



# Room Air Conditioners

**Safety Instructions** ..... 2, 3

**Operating Instructions**  
Controls ..... 4-6

**Care and Cleaning**  
Air Filter ..... 6  
Outdoor Coils ..... 6

**Installation Instructions** ..... 7-11

**Troubleshooting Tips** ..... 12  
Normal Operating Sounds ..... 12

**Consumer Support**  
Consumer Support ..... Back Cover  
Warranty ..... 13

**Owner's Manual and  
Installation Instructions**

AEM05  
AEM06  
AEM08

## Acondicionador de aire

**Manual del propietario  
y instrucciones de  
instalación**

La sección en español empieza en la página 14

Write the model and serial numbers here:

Model # \_\_\_\_\_

Serial # \_\_\_\_\_

Find these numbers on a label on the side of the air conditioner.

# IMPORTANT SAFETY INFORMATION.

## READ ALL INSTRUCTIONS BEFORE USING.

---

### SAFETY INFORMATION

 This is the safety alert symbol. This symbol alerts you to potential hazards that can kill or hurt you and others. All safety messages will follow the safety alert symbol and the word “DANGER”, “WARNING”, or “CAUTION”. These words are defined as:

 **DANGER** Indicates a hazardous situation which, if not avoided, **will** result in death or serious injury.

 **WARNING** Indicates a hazardous situation which, if not avoided, **could** result in death or serious injury.

 **CAUTION** Indicates a hazardous situation which, if not avoided, **could** result in minor or moderate injury.

## **WARNING**

For your safety, the information in this manual must be followed to minimize the risk of fire, electric shock or personal injury.

### SAFETY PRECAUTIONS

---

- Use this appliance only for its intended purpose as described in this Owner’s Manual.
- This air conditioner must be properly installed in accordance with the Installation Instructions before it is used.
- Never unplug your air conditioner by pulling on the power cord. Always grip plug firmly and pull straight out from the receptacle.
- Replace immediately all electric service cords that have become frayed or otherwise damaged. A damaged power supply cord must be replaced with a new power supply cord obtained from the manufacturer and not repaired. Do not use a cord that shows cracks or abrasion damage along its length or at either the plug or connector end.
- Turn the unit **OFF** and unplug your air conditioner before cleaning.
- GE does not support any servicing of the air conditioner. We strongly recommend that you do not attempt to service the air conditioner yourself.
- For your safety...do not store or use combustible materials, gasoline or other flammable vapors or liquids in the vicinity of this or any other appliance.
- All air conditioners contain refrigerants, which under federal law must be removed prior to product disposal. If you are getting rid of an old product with refrigerants, check with the company handling disposal about what to do.
- If the receptacle does not match the plug, the receptacle must be changed out by a qualified electrician.
- These R410A air conditioning systems require contractors and technicians to use tools, equipment and safety standards approved for use with this refrigerant. DO NOT use equipment certified for R22 refrigerant only.

## WARNING

### HOW TO CONNECT ELECTRICITY

---

Do not, under any circumstances, cut or remove the third (ground) prong from the power cord. For personal safety, this appliance must be properly grounded.

**DO NOT use an adapter plug with this appliance.**

The power cord of this appliance is equipped with a 3-prong (grounding) plug which mates with a standard 3-prong (grounding) wall outlet to minimize the possibility of electric shock hazard from this appliance.

Power cord includes a current interrupter device. A test and reset button is provided on the plug case. The device should be tested on a periodic basis by first pressing the **TEST** button and then the **RESET** button while plugged into the outlet. If the **TEST** button does not trip or if the **RESET** button will not stay engaged, discontinue use of the air conditioner and contact a qualified service technician.

Have the wall outlet and circuit checked by a qualified electrician to make sure the outlet is properly grounded.

Where a 2-prong wall outlet is encountered, it is your personal responsibility and obligation to have it replaced with a properly grounded 3-prong wall outlet.

The air conditioner should always be plugged into its own individual electrical outlet which has a voltage rating that matches the rating plate.

This provides the best performance and also prevents overloading house wiring circuits which could cause a fire hazard from overheated wires.

See the Installation Instructions, *Electrical Requirements* section for specific electrical connection requirements.

### USE OF EXTENSION CORDS

---

**RISK OF FIRE.** *Could cause serious injury or death.*

- **DO NOT** use an extension cord with this Window Air Conditioner.
- **DO NOT** use surge protectors or multi-outlet adaptors with this Window Air Conditioner.

**READ AND FOLLOW THIS SAFETY INFORMATION CAREFULLY.**

---

### SAVE THESE INSTRUCTIONS

### RECYCLING INFORMATION

---

For appliance recycling information please visit [www.geappliances.com/recycling](http://www.geappliances.com/recycling).

# About the controls on the air conditioner.

Features and appearance will vary.

Lights next to the touch pads on the air conditioner control panel indicate the selected settings.

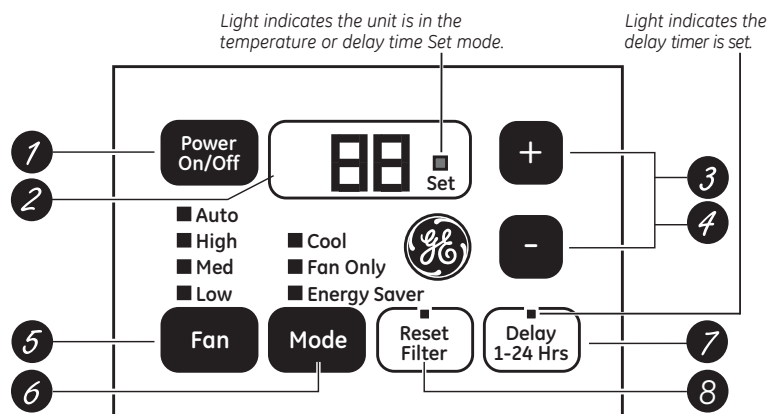

**NOTE:** The display always shows the room temperature except when setting the Set temperature or the Delay timer.

**Air Conditioner Controls**

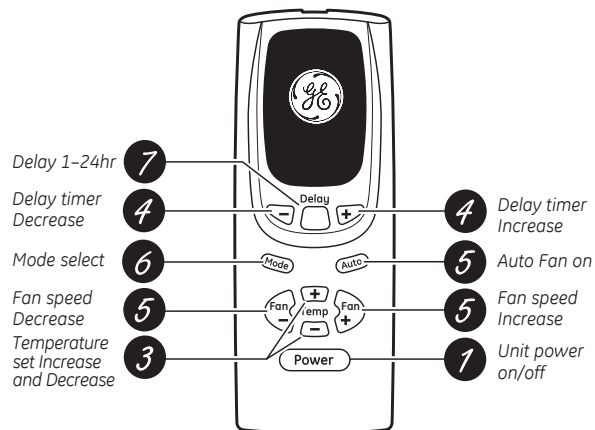

**Remote Control**



## Controls (on some models)

- 1 Power Pad**  
Turns air conditioner on and off. When turned on, the display will show the room temperature.
- 2 Display**  
Shows the room temperature or time remaining on the **Delay** timer. Shows the Set temperature while setting the temperature in **Cool** or **Energy Saver** modes. The **Set** light will turn on while setting.  
  
NOTE: The display will change to show the room temperature after settings have been made.
- 3 Temp Increase ▲ /Decrease ▼ Pads**  
Use to set temperature when in **Cool** or **Energy Saver** mode. The Set light will turn on while setting.
- 4 Delay Timer Increase ▲ (+) /Decrease ▼ (-) Pads**  
Each touch of the **Increase ▲ / Decrease ▼** pads on the unit or the **Increase + / Decrease -** pads on the remote control will set the delay time when using the **Delay 1-24hr** timer. The **Set** light will turn on while setting.
- 5 Fan Speed Pads**  
Use to set the fan speed to **Low, Med, High** or **Auto** on the unit. **NOTE:** On the remote control, use the fan speed **Increase + / Decrease -** pads to set the fan speeds to **Low, Med** or **High**. Use the **Auto** pad to turn **Auto** fan on.
- 6 Mode Pad**  
Use to set the air conditioner to **Cool, Energy Saver** or **Fan Only** mode.
- 7 Delay Pads/Delay 1-24hr Pad**  
**Delay ON**—When the air conditioner is off, it can be set to automatically come on in 1 to 24 hours at its previous mode and fan settings.  
**Delay OFF**—When the air conditioner is on, it can be set to automatically turn off in 1 to 24 hours.  
**How to set:**  
  
Press the **Delay 1-24hr** pad on the unit or the **Delay pad** on the remote control. Each touch of the **Increase ▲ / Decrease ▼** pads on the unit or the **Increase + / Decrease -** pads on the remote control will set the timer in 1-hour intervals. The **Set** light will turn on while setting.  
  
To review the remaining time on the **Delay 1-24hr** timer, press the **Delay 1-24hr** pad on the unit or the **Delay pad** on the remote control. Use the **Increase ▲ / Decrease ▼** pads on the unit or the **Increase + / Decrease -** pads on the remote control to set a new time if desired.  
**To cancel the timer**, press the **Delay 1-24hr** pad until the light on the **Delay 1-24hr** pad goes off.
- 8 Reset Filter**  
LED will turn on when fan has accumulated 250 hours of run time as a reminder to clean filter. Press **Reset Filter** to turn off the LED and reset the accumulated run time.

**Note:** The default temperature reading on the display is degree Fahrenheit (°F). To change the display to degree Celcius (°C), press the Temp Increase ▲ and Temp Decrease ▼ buttons together and hold for 3 seconds. Repeat the process to change back to degree Fahrenheit (°F)

### Do Not Operate in Freezing Outdoor Conditions

This cool-only air conditioner was not designed for freezing outdoor conditions. It must not be used in freezing outdoor conditions.

### Remote Control

- To ensure proper operation, aim the remote control at the signal receiver on the air conditioner.
- Make sure nothing is between the air conditioner and the remote control that could block the signal.
- The remote control signal has a range of up to 20 feet.
- Make sure batteries are fresh and installed correctly as indicated on the remote control.
- Remote contains a magnet allowing it to attach to metal surfaces.

### Cool Mode

Use the **Cool** mode at **Low, Med, High** or **Auto Fan Speed** for cooling. Use the **Temperature Increase ▲ / Decrease ▼** pads to set the desired temperature between 64°F and 86°F in 1°F increments.

An electronic thermostat is used to maintain the room temperature. The compressor will cycle on and off to keep the room at the set level of comfort. Set the thermostat at a lower number and the indoor air will become cooler. Set the thermostat at a higher number and the indoor air will become warmer.

**NOTE:** If the air conditioner is off and is then turned on while set to a **Cool** setting or if turned from a fan setting to a **Cool** setting, it may take approximately 3 minutes for the compressor to start and cooling to begin.

### Cooling Descriptions

**For Normal Cooling**—Select the **Cool** mode and **High** or **Med** fan with a middle set temperature.

**For Maximum Cooling**—Select the **Cool** mode and **High** fan with a lower set temperature.

**For Quieter and Nighttime Cooling**—Select the **Cool** mode and **Low** fan with a middle set temperature.

### Energy Saver Mode

This mode optimizes the cooling power of your air conditioner, thereby saving you energy. Once the set point temperature has been reached, the fan will cycle off to save energy. The fan will cycle back on periodically to insure all cooling capacity in the system is used. This mode is the default mode for the unit. Each time the unit is powered off, it will restart in **Energy Saver** mode **ON**. This includes **Delay** timer mode. The first time the unit is turned on, the settings will be 70° and **Low** fan. You can adjust the fan speed and temperature to your personal comfort.

**Energy Saver ON**—Helps minimize electricity use. It is normal for the fan to cycle off and then back on in this mode. This on/off cycle can repeat multiple times. Because the fan will cycle off, you may notice a variation in room temperature and humidity.

**Energy Saver OFF**—When this mode is not engaged, the fan will run continuously, and in **Cool** mode the compressor will cycle on and off to maintain room temperature.

### Fan Only Mode

Use the Fan Only Mode at Low, Med or High fan speed to provide air circulation and filtering without cooling. Since fan-only settings do not provide cooling, a Set temperature cannot be entered. The room temperature will appear in the display.

**NOTE:** Auto Fan Speed cannot be used when in the **Fan Only** Mode.

### Auto Fan Speed

Set to **Auto** fan speed for the fan speed to automatically set to the speed needed to provide optimum comfort settings with the set temperature.

If the room needs more cooling, the fan speed will

automatically increase. If the room needs less cooling, the fan speed will automatically decrease.

**NOTE:** Auto Fan Speed cannot be used when in the **Fan Only** Mode.

### Power Outage Recovery Feature

In the case of a power outage or interruption, the unit will automatically restart in the settings last used after the power is restored. If the **Delay 1-24hr** feature was set, it will resume

countdown. You may need to set a new time if desired.

Additional important information.

## Air Direction

Use the lever to adjust the air direction left and right only.

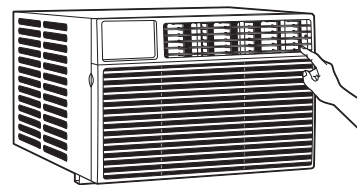

## Care and cleaning of the air conditioner.

### Grille and Case

Turn the air conditioner off and remove the plug from the wall outlet before cleaning.

To clean, use water and a mild detergent. Do not use bleach or abrasives.

### Air Filter

The air filter behind the front grille should be checked and cleaned at least every 30 days or more often if necessary.

#### To remove:

Pull the tab on the right side of the unit until the filter is out.

#### To remove:

Open the inlet grille by pulling downward on the tabs at the top upper corners of the inlet grille until the grille is in a 45° position. Remove the filter.

Clean the filter with warm, soapy water. Rinse and let the filter dry before replacing it. Do not clean the filter in a dishwasher.

**⚠ CAUTION:** DO NOT operate the air conditioner without a filter because dirt and lint will clog it and reduce performance.

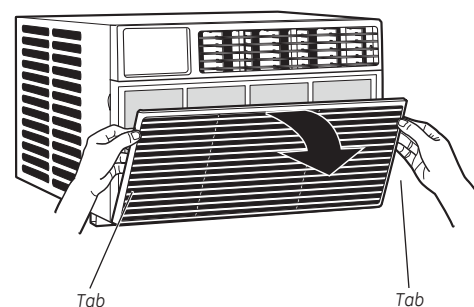
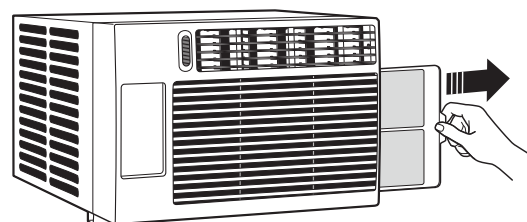

### Outdoor Coils

The coils on the outdoor side of the air conditioner should be checked regularly. If they are clogged with dirt or soot, they may be professionally cleaned.

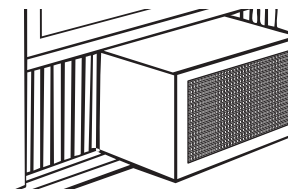

### How to Insert the Batteries in the Remote Control

- 1 Remove the battery cover by sliding it according to the arrow direction.
- 2 Insert new batteries, making sure that the (+) and (-) of battery are installed correctly.
- 3 Reattach the cover by sliding it back into position.

#### NOTES:

- Use 2 "AAA" (1.5 volt) alkaline batteries. Do not use rechargeable batteries.
- Remove the batteries from the remote control if the system is not going to be used for a long time.
- Do not mix old and new batteries. Do not mix alkaline, standard (carbon-zinc) or rechargeable (ni-cad, ni-mh, etc) batteries.

# Installation Instructions

# Air Conditioner

? Questions? Call 800.GE.CARES (800.432.2737) or Visit our Website at: [GEAppliances.com](http://GEAppliances.com)

## BEFORE YOU BEGIN

Read these instructions completely and carefully.

- **IMPORTANT** — Save these instructions for local inspector's use.
- **IMPORTANT** — Observe all governing codes and ordinances.
- **Note to Installer** – Be sure to leave these instructions with the Consumer.
- **Note to Consumer** – Keep these instructions for future reference.
- **Skill level** – Installation of this appliance requires basic mechanical skills.
- **Completion time** – Approximately 1 hour
- We recommend that two people install this product.
- Proper installation is the responsibility of the installer.
- Product failure due to improper installation is not covered under the Warranty.
- You **MUST** use all supplied parts and use proper installation procedures as described in these instructions when installing this air conditioner.

## ELECTRICAL REQUIREMENTS

 Some models require a 115/120-volt AC, 60-Hz grounded outlet protected with a 15-amp time-delay fuse or circuit breaker.

The 3-prong grounding plug minimizes the possibility of electric shock hazard. If the wall outlet you plan to use is only a 2-prong outlet, it is your responsibility to have it replaced with a properly grounded 3-prong wall outlet.

 Some models require 230/208-volt AC, protected with a time-delay fuse or circuit breaker. These models should be installed on their own single branch circuit for best performance and to prevent overloading house or apartment wiring circuits, which could cause a possible fire hazard from overheating wires.



## CAUTION:

Do not, under any circumstances, cut or remove the third (ground) prong from the power cord.

Do not change the plug on the power cord of this air conditioner.

Aluminum house wiring may present special problems—consult a qualified electrician.

## TOOLS YOU WILL NEED

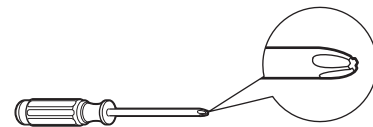

Phillips head screwdriver



Flat-blade screwdriver



Pencil

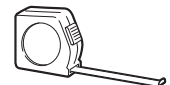

Ruler or tape measure



Level

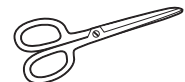

Scissors or knife

Power cord includes a current interrupter device. A test and reset button is provided on the plug case. The device should be tested on a periodic basis by first pressing the **TEST** button and then the **RESET** button while plugged into the outlet. If the **TEST** button does not trip or if the **RESET** button will not stay engaged, discontinue use of the air conditioner and contact a qualified service technician.

# Installation Instructions

## PARTS INCLUDED (Appearance may vary)

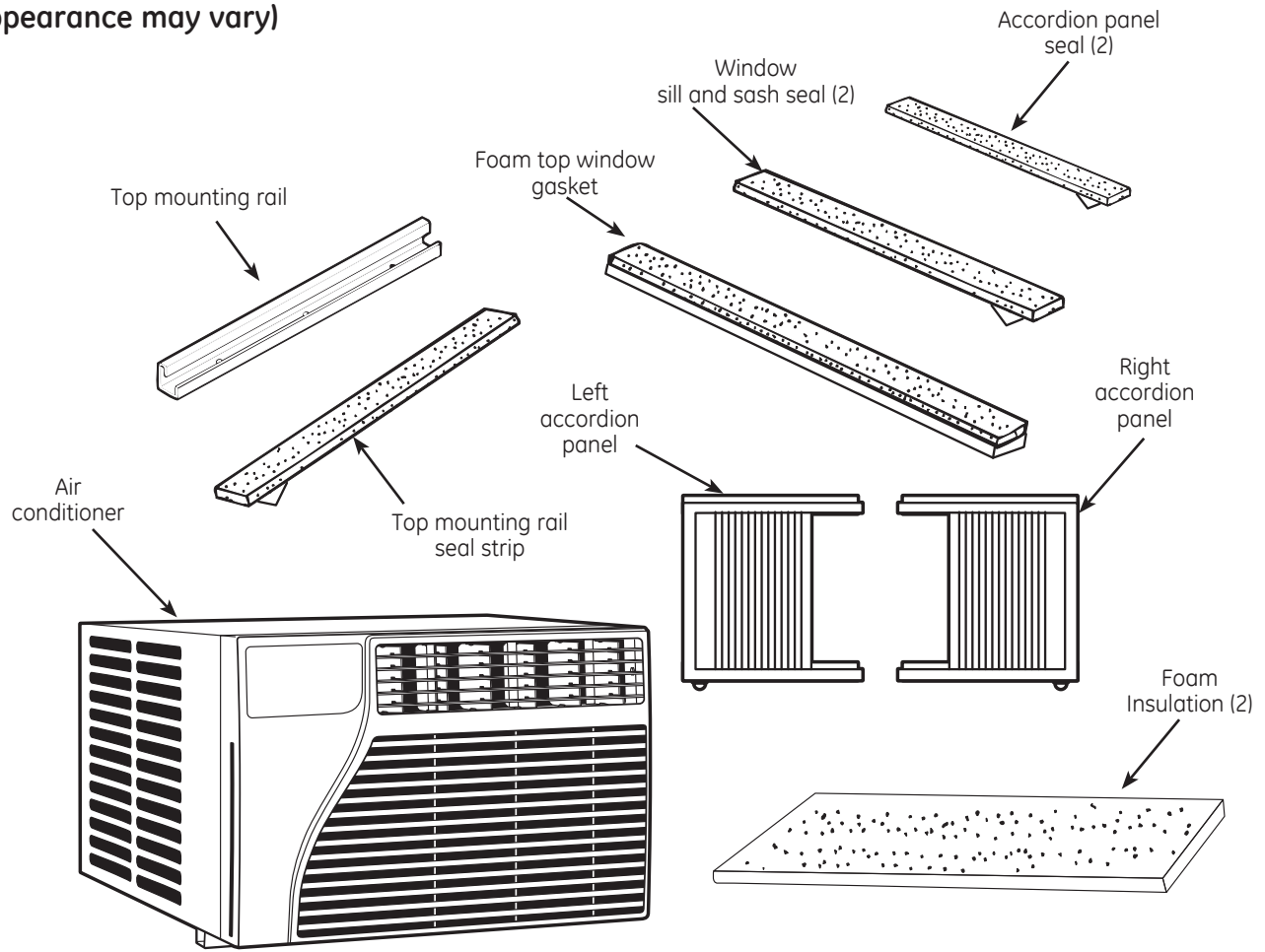

Type A (4)



Type B (6)



Window locking  
bracket (1)

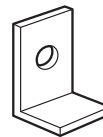



# Installation Instructions

## 1 WINDOW REQUIREMENTS

- These instructions are for a standard double-hung window. You will need to modify them for other types of windows.
- The air conditioner can be installed without the accordion panels if needed to fit in a narrow window. See the window opening dimensions.
- All supporting parts must be secured to firm wood, masonry or metal.
- The electrical outlet must be within reach of the power cord.
- Follow the dimensions in the table and illustration for your model.

Models	A	B
AEM05	13 1/2" min.	22 1/2"-38"
AEM06		
AEM08		

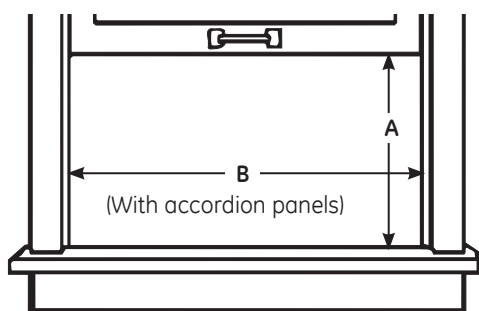

## 3 ATTACH THE TOP MOUNTING RAIL SEAL STRIP

(Some models may have the seal strip already attached to the top mounting rail. If applicable, skip this step.)

Remove the backing from the top mounting rail seal strip and attach the seal strip to the bottom of the top mounting rail, along the front edge.

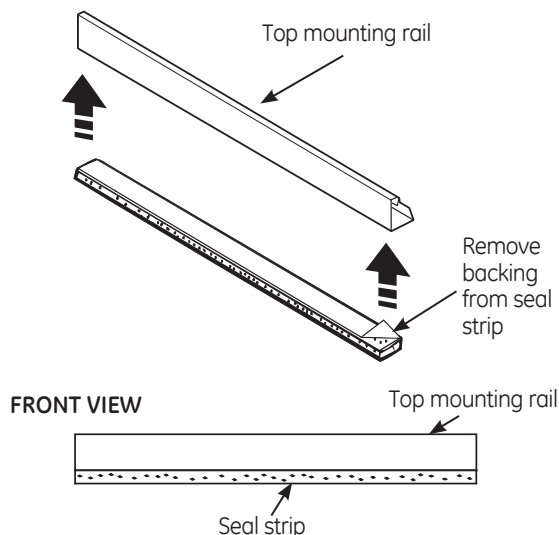

## 2 STORM WINDOW REQUIREMENTS

A storm window frame will not allow the air conditioner to tilt toward the outside, and will keep it from draining properly. To adjust for this, attach a piece of wood to the sill.

### WOOD PIECES

**WIDTH:** 2"

**LENGTH:** Long enough to fit inside the window frame.

**THICKNESS:** To determine the thickness, place a piece of wood on the sill to make it 1/2" higher than the top of the storm window frame or the vinyl frame.

Attach securely with nails or screws provided by the installer.

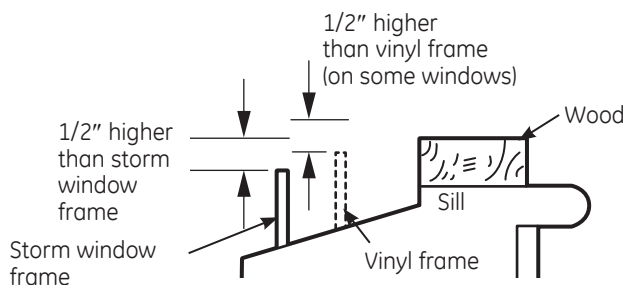

## 4 PREPARE THE AIR CONDITIONER

- A** Install the top mounting rail with 4 Type A screws from the outside of the case.

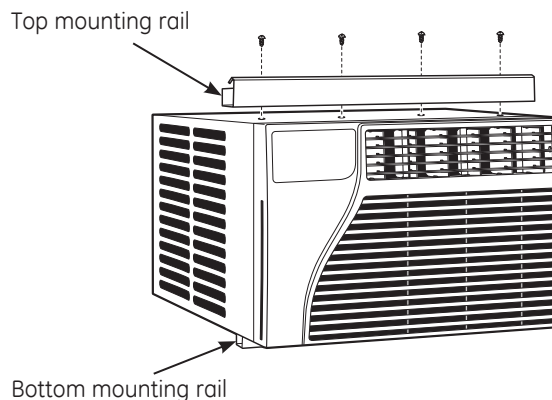

- B** Hold the accordion panel in one hand and gently pull back to free the open end.

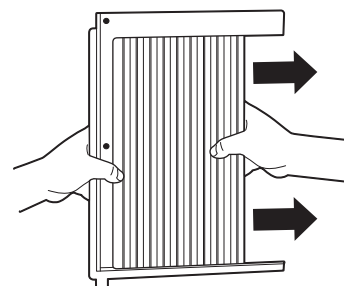

# Installation Instructions

## 4 PREPARE THE AIR CONDITIONER (cont.)

- C** Remove the backing from the accordion seal (two short strips). Stick one sealing strip respectively on the left side and right side of the accordion panels, as shown.

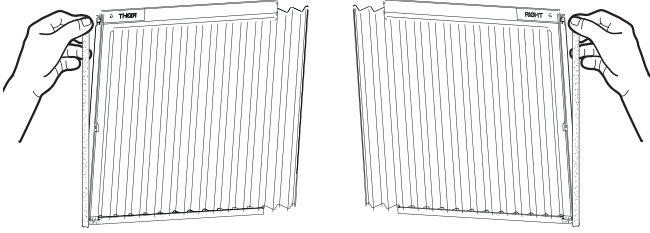

- D** Slide the free end of the accordion panel into the side panel rails. Slide the panel down. Be sure to leave enough space to slip the top and bottom of the frame into the rails on the cabinet.

**NOTE:** There is a right and a left accordion panel. Be sure to use the proper panel for each side.

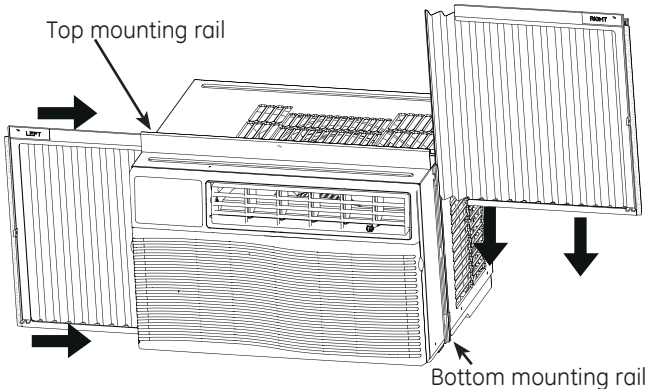

- E** Slide the left and right accordion panels into the top and bottom mounting rails.

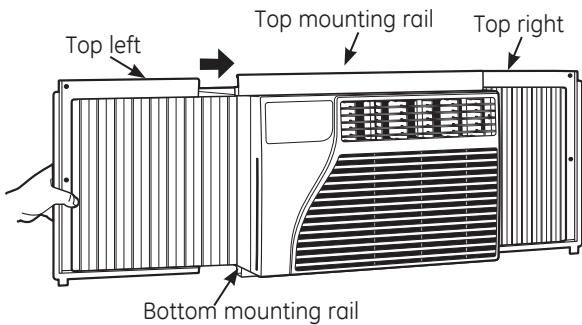

## 5 PREPARE THE WINDOW

Cut the window seal (2 long strips) to the proper length. Peel off the backing and attach the seal to the underside of the window sash.

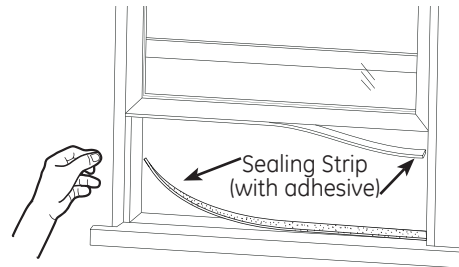

## 6 INSTALL THE AIR CONDITIONER IN THE WINDOW

- A** Place the air conditioner on the sill with the bottom mounting rail against its back edge. Center it and close the window securely behind the top mounting rail. It should be level or slightly tilted to the outside. Use a level; about a 1/3 bubble will be the correct case slant to the outside.

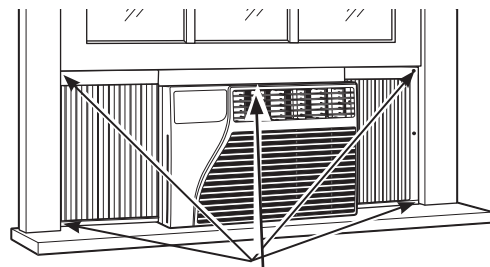

Type B screws

- B** Extend the left and right accordion panels to the vertical window sashes and attach, through the holes in the panels, with 5 Type B screws, as appropriate.

# Installation Instructions

## 7 INSTALL SUPPORT BRACKET AND FOAM TOP WINDOW GASKET

### A **CAUTION:**

To prevent broken glass or damage to windows, on vinyl or other similarly constructed windows, attach the window locking bracket to the window side jamb with one Type B screw.

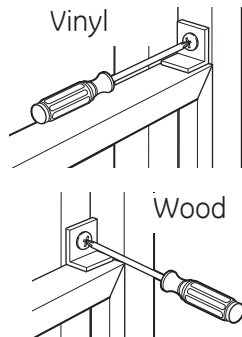

B Cut the foam top window gasket to the window width.

C Stuff the foam between the glass and the window to prevent air and insects from getting into the room.



**NOTE:** If the gasket supplied does not fit your window, obtain appropriate material locally to provide a proper installation seal.

## 8 INSTALL FOAM INSULATION

Additional insulation is provided with your window air conditioner to reduce heat leakage into the home, reducing overall energy usage.

A After the air conditioner is installed in the window measure the length of the accordion for both sides.

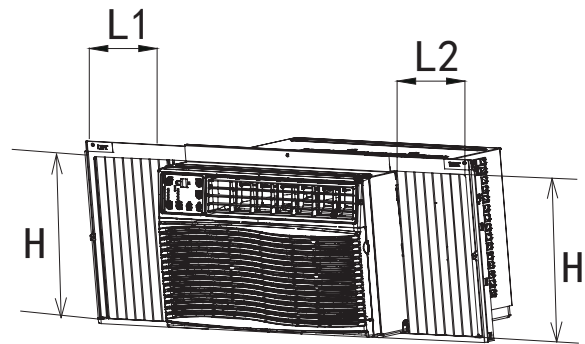

B Cut the foam insulation to the measured length of the left and right side accordion.

**NOTE:** Be sure to measure each accordion because the length could be different on each side.

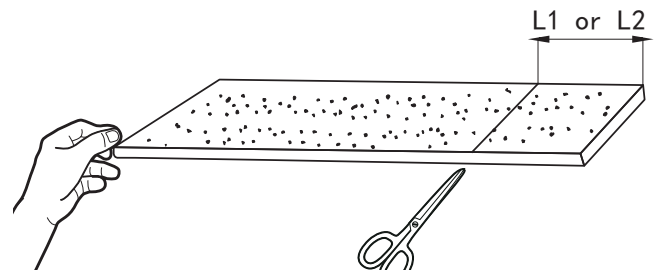

C Remove adhesive from back of foam insulation. Stick the foam insulation onto the left and right accordion, and inside of the frames.

**NOTE:** be careful to cover the entire accordion.

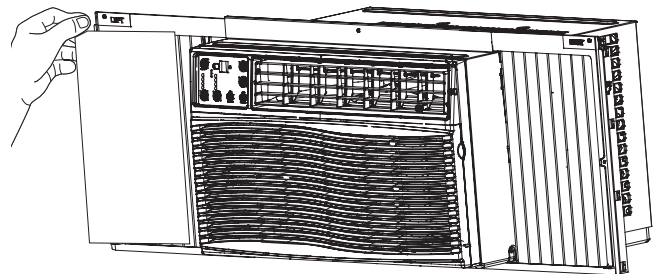

<b>Problem</b>	<b>Possible Causes</b>	<b>What To Do</b>
<b>Air conditioner does not start</b>	The air conditioner is unplugged.	<ul style="list-style-type: none"> <li>• Make sure the air conditioner plug is pushed completely into the outlet.</li> </ul>
	The fuse is blown/circuit breaker is tripped.	<ul style="list-style-type: none"> <li>• Check the house fuse/circuit breaker box and replace the fuse or reset the breaker.</li> </ul>
	Power failure.	<ul style="list-style-type: none"> <li>• The unit will automatically restart in the settings last used after the power is restored.</li> <li>• There is a protective time delay (approximately 3 minutes) to prevent tripping of the compressor overload. For this reason, the unit may not start normal cooling for 3 minutes after it is turned back on.</li> </ul>
	The current interrupter device is tripped.	<ul style="list-style-type: none"> <li>• Press the <b>RESET</b> button located on the power cord plug.</li> <li>• If the <b>RESET</b> button will not stay engaged, discontinue use of the air conditioner and contact a qualified service technician.</li> </ul>
<b>Air conditioner does not cool as it should</b>	Airflow is restricted.	<ul style="list-style-type: none"> <li>• Make sure there are no curtains, blinds or furniture blocking the front of the air conditioner.</li> </ul>
	The temp control may not be set correctly.	<ul style="list-style-type: none"> <li>• On models with touch pads: In the <b>Cool</b> mode, press the Decrease ▼ pad.</li> <li>• On models with control knobs, turn the temperature knob to a higher number.</li> </ul>
	The air filter is dirty.	<ul style="list-style-type: none"> <li>• Clean the filter at least every 30 days. See the <i>Care and Cleaning</i> section.</li> </ul>
	The room may have been hot.	<ul style="list-style-type: none"> <li>• When the air conditioner is first turned on, you need to allow time for the room to cool down.</li> </ul>
	Cold air is escaping.	<ul style="list-style-type: none"> <li>• Check for open furnace registers and cold air returns.</li> </ul>
	Cooling coils have iced up.	<ul style="list-style-type: none"> <li>• See "<b>Air conditioner freezing up</b>" below.</li> </ul>
<b>Air conditioner freezing up</b>	Ice blocks the air flow and stops the air conditioner from cooling the room.	<ul style="list-style-type: none"> <li>• On models with control knobs, set the mode control at <b>High Fan</b> or <b>High Cool</b> with the <b>Temp</b> at <b>1</b> or <b>2</b>.</li> <li>• On models with touch pads, set the controls at <b>High Fan</b> or <b>High Cool</b> and set the thermostat to a higher temperature.</li> </ul>
<b>The remote control is not working</b>	The batteries are inserted incorrectly.	<ul style="list-style-type: none"> <li>• Check the position of the batteries. They should be inserted in the opposite (+) and (-) direction.</li> </ul>
	The batteries may be dead.	<ul style="list-style-type: none"> <li>• Replace the batteries.</li> </ul>
<b>Water drips outside</b>	Hot, humid weather.	<ul style="list-style-type: none"> <li>• This is normal.</li> </ul>
<b>Water drips indoors</b>	The air conditioner is not tilted to the outside.	<ul style="list-style-type: none"> <li>• For proper water disposal, make sure the air conditioner slants slightly from the case front to the rear.</li> </ul>
<b>Water collects in base pan</b>	Moisture removed from air and drains into base pan.	<ul style="list-style-type: none"> <li>• This is normal for a short period in areas with little humidity; normal for a longer period in very humid areas.</li> </ul>

## Normal Operating Sounds

- You may hear a pinging noise caused by water being picked up and thrown against the condenser on rainy days or when the humidity is high. This design feature helps remove moisture and improve efficiency.
- You may hear the thermostat click when the compressor cycles on and off.
- Water will collect in the base pan during high humidity or on rainy days. The water may overflow and drip from the outdoor side of the unit.
- The fan may run even when the compressor does not.

# GE Air Conditioner—One-Year Limited Warranty.



All warranty service provided by our Factory Service Centers, or an authorized Customer Care® technician. To schedule service, visit us on-line at [ge.com](http://ge.com), or call 800.GE.CARES (800.432.2737). Have serial number and model number available when calling for service.

Staple your receipt here.  
Proof of the original purchase date is needed to obtain service under the warranty.

## For The Period Of: GE Will Replace:

### One Year

From the date of the original purchase

**Any part** of the air conditioner which fails due to a defect in materials or workmanship. During this **limited one-year warranty**, GE will also provide, **free of charge**, all labor and related service to replace the defective part.

## What Is Not Covered:

- Service trips to your home to teach you how to use the product.
- Improper installation, delivery or maintenance. If you have an installation problem, or if the air conditioner is of improper cooling capacity for the intended use, contact your dealer or installer. You are responsible for providing adequate electrical connecting facilities.
- Failure of the product resulting from modifications to the product or due to unreasonable use including failure to provide reasonable and necessary maintenance.
- In commercial locations, labor necessary to move the unit to a location where it is accessible for service by an individual technician.
- Replacement of house fuses or resetting of circuit breakers.
- Failure due to corrosion on models not corrosion-protected.
- Damage to the product caused by improper power supply voltage, accident, fire, floods or acts of God.
- Incidental or consequential damage caused by possible defects with this air conditioner.
- Damage caused after delivery.

**EXCLUSION OF IMPLIED WARRANTIES—Your sole and exclusive remedy is product repair as provided in this Limited Warranty. Any implied warranties, including the implied warranties of merchantability or fitness for a particular purpose, are limited to one year or the shortest period allowed by law.**

This warranty is extended to the original purchaser and any succeeding owner for products purchased for home use within the USA. If the product is located in an area where service by a GE Authorized Servicer is not available, you may be responsible for a trip charge or you may be required to bring the product to an Authorized GE Service location for service. In Alaska, the warranty excludes the cost of shipping or service calls to your home.

Some states do not allow the exclusion or limitation of incidental or consequential damages. This warranty gives you specific legal rights, and you may also have other rights which vary from state to state. To know what your legal rights are, consult your local or state consumer affairs office or your state's Attorney General.

Warrantor: General Electric Company. Louisville, KY 40225

## Consumer Support.

---



### **GE Appliances Website**

**GEAppliances.com**

Have a question or need assistance with your appliance? Try the GE Appliances Website 24 hours a day, any day of the year! For greater convenience and faster service, you can now download Owner's Manuals, or even order parts on-line.



### **Real Life Design Studio**

**GEAppliances.com**

GE supports the Universal Design concept—products, services and environments that can be used by people of all ages, sizes and capabilities. We recognize the need to design for a wide range of physical and mental abilities and impairments. For details of GE's Universal Design applications, including kitchen design ideas for people with disabilities, check out our Website today. For the hearing impaired, please call 800.TDD.GEAC (800.833.4322).

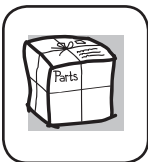

### **Parts and Accessories**

**GEApplianceParts.com**

Individuals qualified to service their own appliances can have parts or accessories sent directly to their homes (VISA, MasterCard and Discover cards are accepted). Order on-line today, 24 hours every day or by phone at 800.626.2002 during normal business hours.

***Instructions contained in this manual cover procedures to be performed by any user. GE does not support any servicing of the air conditioner. We strongly recommend that you do not attempt to service the air conditioner yourself.***



### **Contact Us**

**GEAppliances.com**

If you are not satisfied with the service you receive from GE, contact us on our Website with all the details including your phone number, or write to:

General Manager, Customer Relations  
GE Appliances, Appliance Park  
Louisville, KY 40225