

Dishwasher Lave Vaisselle



BOSCH

en Operating instructions
fr Guide d'Utilisation

9000953941 (0114)

Congratulations and thank you from Bosch!

Thank you for selecting a Bosch dishwasher. You have joined the many consumers who demand quiet and superior performance from their dishwashers.

This manual was written with your safety and convenience in mind, and the information contained herein is very important. We highly recommend that you read this manual before using your dishwasher for the first time.

To learn more about your dishwasher and available accessories, as well as many other top quality Bosch appliances, visit our web site at:

www.bosch-home.com/us (USA)

or

www.bosch-appliances.ca (Canada)

If you have any questions or comments, please contact us at: 1-800-944-2904

Table of Contents

Important Safety Instructions.....	2-3
Dishwasher Components.....	4-5
Dishwasher Setup.....	6-7
Dishware Materials.....	8
Loading the Dishwasher.....	8-9
Rack Accessories.....	10-11
Dishwasher Cycles and Options.....	12
Wash Cycle Information.....	13
Operating the Dishwasher.....	13-14
Care and Maintenance.....	15
Troubleshooting Guide.....	16-17
Customer Service.....	18
Warranty Information.....	19

IMPORTANT SAFETY INSTRUCTIONS: Please READ and SAVE this information



WARNING

Misuse of the dishwasher can result in serious injury or death. Do not use the dishwasher in any way not covered in this manual or for any purpose other than those explained in the following pages.



Severe product damage and/or injury could result from the use of unqualified service technicians or non-original replacement parts. All repairs must be performed by a qualified service technician using only original equipment factory replacement parts.



Electrical shock or fire could result if the electrical supply for the dishwasher covered in this manual is incorrectly installed or if the dishwasher has been improperly grounded. Do not use the dishwasher covered in this manual unless you are certain the electrical supply has been correctly installed or the dishwasher has been properly grounded.



Never use harsh chemicals to clean your dishwasher. Some chloride-containing products can damage your dishwasher and may present health hazards!!



Only sanitizing cycles have been designed to meet the requirements of 6 for soil removal and sanitation efficacy. There is no intention, either directly or indirectly, to imply that all cycles on a certified machine have passed the sanitization performance test.

NOTICE

Never use steam cleaning products to clean your dishwasher. The manufacturer will not be liable for the possible damages or consequences.



It is highly recommended for the end user to become familiar with the procedure to shut off the incoming water supply and the procedure to shut off the incoming power supply. See the Installation Instructions or contact your installer for more information.



NSF/ANSI 184 Certified residential dishwashers are not intended for licensed food establishments.



WARNING: To reduce the risk of fire, electrical shock, or serious injury, observe the following:

- 1 This dishwasher is provided with Installation Instructions and this Use and Care Manual. Read and understand all instructions before using the dishwasher.
- 2 This appliance must be grounded to a metal, permanent wiring system, or an equipment grounding conductor must be run with the circuit conductors and connected to the equipment grounding terminal or lead on the dishwasher. See the Installation Instructions included with this dishwasher for more information on electrical requirements.
- 3 Use this dishwasher only for its intended function, which is the washing of household dishware and kitchenware.
- 4 Use only detergents or rinsing agents recommended for use in a dishwasher, and keep them out of the reach of children.
- 5 When loading items to be washed:
 - Locate sharp items so they are not likely to damage the door seal.
 - Load knives and other sharp utensils with their HANDLES UP to reduce the risk of cut-type injuries.
 - Do not wash plastic items unless they are marked “dishwasher safe” or the equivalent. For plastic items not so marked, check the manufacturer’s recommendations.
 - Do not operate your dishwasher unless all enclosure panels are in place.
 - Do not tamper with or override controls and interlocks.
- 6 Do not abuse, sit or stand on the door or dish racks of the dishwasher.
- 7 To reduce risk of injury, do not allow children to play in or on the dishwasher.
- 8 When children become old enough to operate the appliance, it is the legal responsibility of the parents/legal guardians to ensure the children are instructed in safe practices by qualified persons.
- 9 Under certain conditions, hydrogen gas may be produced in a hot water system that has not been used for two weeks or more. Hydrogen gas is explosive. Before using a dishwasher that is connected to a hot water system that has been unused for two weeks or longer, turn on all hot water faucets and let the water flow from each for several minutes. This will release any accumulated hydrogen gas. As the gas is explosive, do not smoke or use an open flame during this time.
- 10 Remove the dishwasher door to the washing compartment when removing an old dishwasher for service or discarding.
- 11 To avoid floor damage and possible mold growth, do not allow wet areas to remain around or under the dishwasher.
- 12 Protect your dishwasher from the elements. Protect against freezing to avoid possible damage to the fill valve. Damage caused by freezing is not covered by the warranty.
- 13 This appliance must be grounded. In the event of a malfunction or breakdown, grounding will reduce the risk of electric shock by providing a path of least resistance for electric current. This appliance is equipped with a cord having an equipment-grounding conductor and a grounding plug. The plug must be plugged into an appropriate outlet that is installed and grounded in accordance with all local codes and ordinances.
 - Improper connection of the equipment-grounding conductor can result in risk of electric shock. Check with a qualified electrician or service representative if you are in doubt whether the appliance is properly grounded. Do not modify the plug provided with the appliance, if it will not fit the outlet, have a proper outlet installed by a qualified electrician.

State of California Proposition 65 Warnings:

WARNING: This product contains one or more chemicals known to the State of California to cause cancer.

WARNING: This product contains one or more chemicals known to the State of California to cause birth defects or other reproductive harm.

Dishwasher Components

SHX5ER55UC

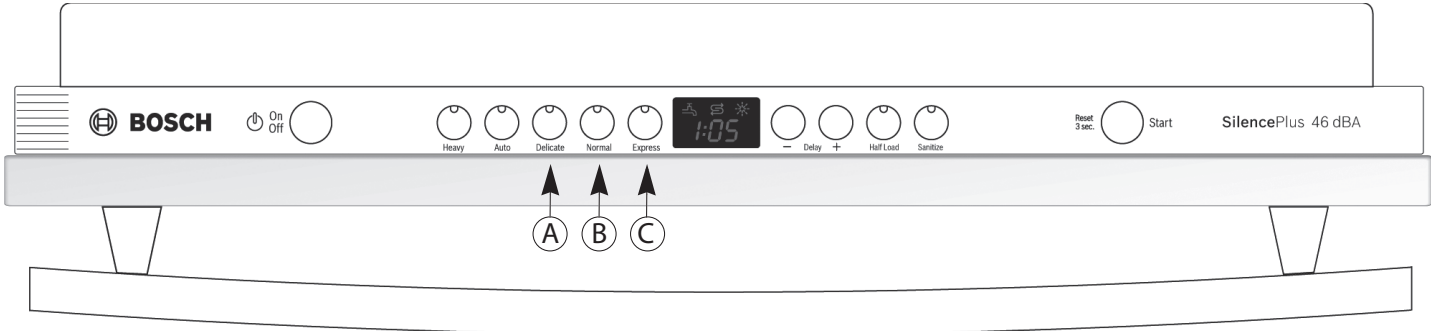

SHX7ER55UC

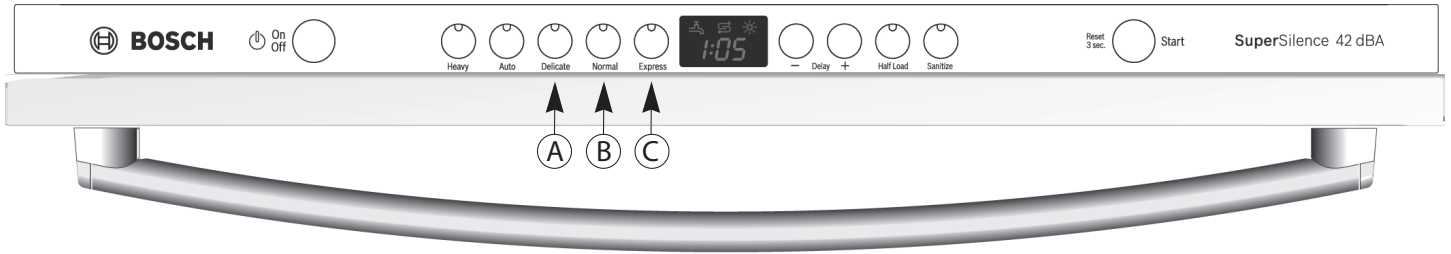

NOTE: Buttons A, B and C are always to the immediate left of the display as shown above.

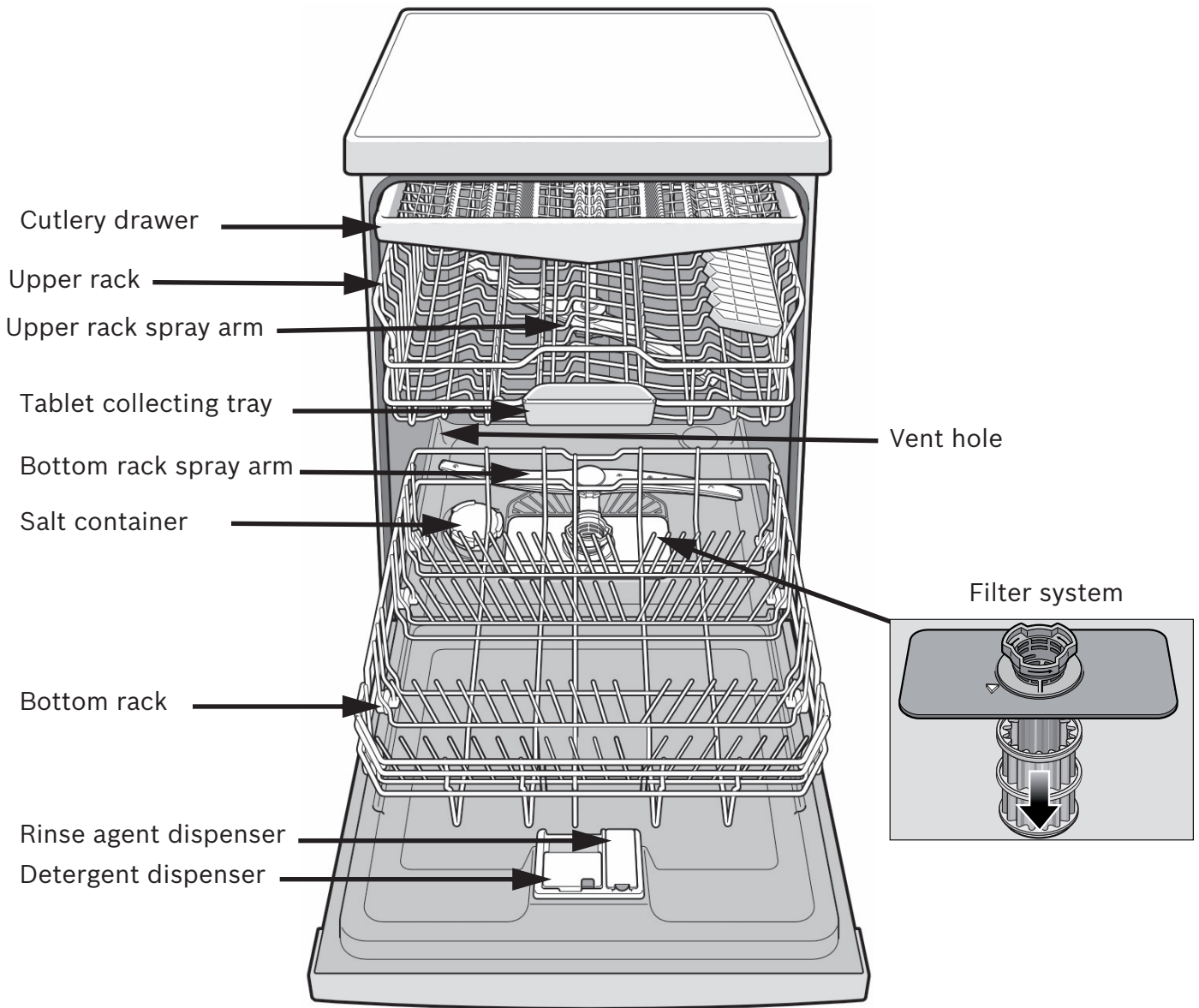

Wash Cycles						Additional Features						
Model	Heavy	Auto	Normal	Delicate	Express	Adjustable Upper Rack	Delay Start	Extra Tall Item Sprinkler	Flip Tines	Half Load Option	InfoLight	Sanitize Option
SHX5ER55UC	X	X	X	X	X	RackMatic	X	X		X		X
SHX7ER55UC	X	X	X	X	X	RackMatic	X	X	X	X	X	X

Dishwasher Setup

Water Softening System

Your dishwasher requires soft water to ensure proper washing results and is equipped with an internal water softening system. However, if you have a household water softening system, the internal system provided is not needed.

For the water softening system to function properly, it will need to use the dishwasher water softening salt. The amount of salt dispensed can be set from “H:00” to “H:07”. Salt is not required at H:00 (this is the default factory setting). The amount of salt required depends on the degree of hardness of your tap water. See **Table 1**.



- 1 Open the door and turn the unit on using the **[ON/OFF]** button.
- 2 Hold down the “**A**” button (see page 4) and press **[START]** until the display indicates “**H:00**”.
- 3 Release both buttons.
- 4 Press the “**C**” button to select the desired setting.
- 5 Save the selected setting by pressing **[START]** and close the door.

Table 1 - Water hardness

Tap water hardness ppm CaCO ₃ /l	Setting of internal water softener	Fill water softener with salt?
0 - 110	H:00	no
120 - 140	H:01	yes
150 - 180	H:02	yes
190 - 210	H:03	yes
220 - 290	H:04	yes
300 - 370	H:05	yes
380 - 540	H:06	yes
550 - 890	H:07	yes

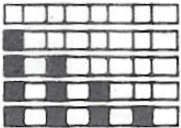
Using the water hardness test strip

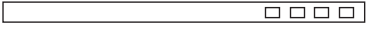
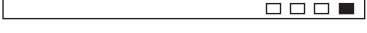
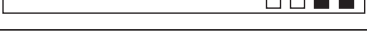
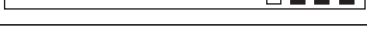
<p>Kurz eintauchen (1 sec), leicht abschütteln und nach 1 min ablesen. 4 grün/green/vert 1 rot/red/rouge 2 rot/red/rouge 3 rot/red/rouge 4 rot/red/rouge</p>	<p>Dip briefly (1 sec), shake off excess water and compare after 1 min.</p> 	<p>Plongez brièvement (1 sec), égouttez l'excès d'eau et comparez après 1 min. <3°dH/ <3.75°e/ <5.4°f >4°dH/ >5°e/ >7.2°f >8,4°dH/ >10.5°e/ >15.1°f >14°dH/ >17.5°e/ >25.2°f >21°dH/ >26.25°e/ >37.8°f</p>	<p>AQUADUR® Teststäbchen zur Bestimmung der Wasserhärte Test stick for determination of water hardness Bandelette pour déterminer la dureté de l'eau</p>
--	--	---	---

Dip the test strip into tap water for a second. Shake off excess water and wait approximately 1 minute before comparing results.	After 1 minute the test strip will show you the correct setting	Setting of internal water softener	Fill water softener with salt?
	0	H:00	no
	1	H:00	no
	2	H:02	yes
	3	H:04	yes
	4	H:06	yes

Salt

Refill the salt container, using a funnel to pour, right before turning on the unit to ensure that salt overflow is immediately washed away. This prevents corrosion. See **Figure 1**.

- 1 Open the screw cap of the salt container.
- 2 Fill the container with water (only required when turning on the unit for the first time).
- 3 Add dishwasher salt until the water is displaced and runs out.
- 4 Refill with salt as soon as the salt refill indicator is lit.

Warning: Never fill the salt dispenser with detergent. It will destroy the water softening system. To prevent corrosion, refill with salt and immediately begin any cycle.

Note: Refill salt only when the “Refill Salt” LED or the salt refill symbol is lit. 
Do not use salt tablets or any salt other than dishwasher water softening salt.

For more information about ordering salt please contact Customer Service.

Figure 1

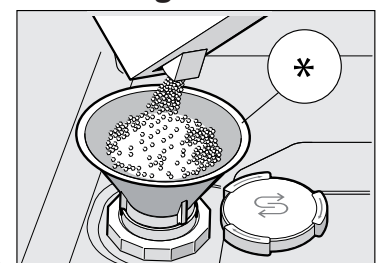

Detergent

Use only detergent specifically designed for dishwashers.

Note: To avoid dishwasher damage, do not use hand dishwashing products in your dishwasher.

The dishwasher uses less water, therefore, less detergent is required. With soft water, 1 tablespoon (15 ml) of detergent will clean most loads. The detergent dispenser cup has lines that measure detergent (**Figure 2**) to 1 tablespoon (15 ml) and 1.75 tablespoons (25 ml). 3 tablespoons (45 ml) of detergent will completely fill the detergent dispenser.

Note: If you do not know the hardness of your water supply, use 15ml of detergent. Increase the amount if necessary to the least amount required to get your kitchenware clean.

Use the measuring lines in the detergent dispenser cup as a guide to measure the amount of detergent recommended in **Table 2**.

To Close:

- Place finger as shown in **Figure 3**.
- Slide door closed and press down firmly until it clicks.

To Open:

- To open the cover, push the button as shown in **Figure 4**.
- Cover will slide open.

Table 2- Recommended Detergent Amount

Wash Cycle	Hard Water/ Heavy Soil	Medium Water/ Medium Soil	Soft Water/ Little Soil
Heavy	3 tbsp (45 ml)	3 tbsp (45 ml)	1.75-3 tbsp (25-45 ml)
Auto	1.75-3 tbsp (25-45 ml)	1.75 tbsp (25 ml)	1-1.75 tbsp (15-25 ml)
Delicate	1.75 tbsp (25 ml)	1-1.75 tbsp (15-25 ml)	1 tbsp (15 ml)
Normal	1.75-3 tbsp (25-45 ml)	1.75 tbsp (25 ml)	1-1.75 tbsp (15-25 ml)
Express	1.75 tbsp (25 ml)	1-1.75 tbsp (15-25 ml)	1 tbsp (15 ml)

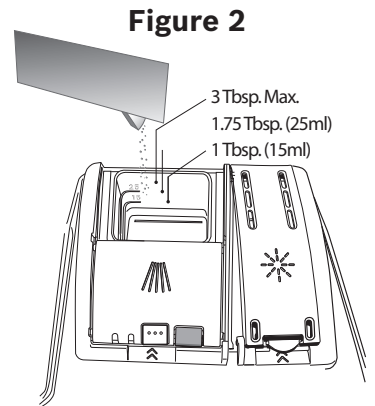

Figure 3

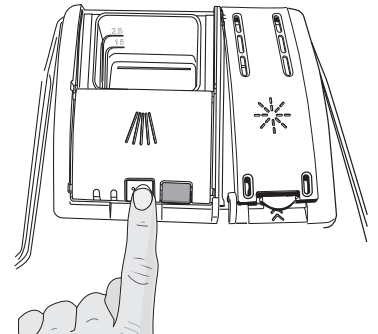
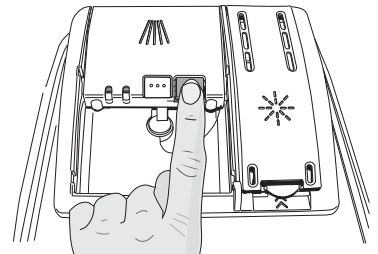

Figure 4



Rinse Aid

To achieve proper drying, always use a liquid rinse aid, even if your detergent contains a rinse aid or drying additive.

Note: The dishwasher indicates low rinse aid by turning on the Refill Rinse Aid LED or symbol in the display. If this light is on, you need to refill the rinse aid dispenser by following the directions below.

Adding Rinse Aid



Add liquid rinse aid to the dispenser until the reservoir is full (see **Figure 5**). Wipe up any excess rinse aid that may puddle when the dispenser reservoir is full. The indicator light will go out a few moments after the dishwasher door is shut. See **page 13** for how to adjust the amount of rinse aid dispensed.

Figure 5

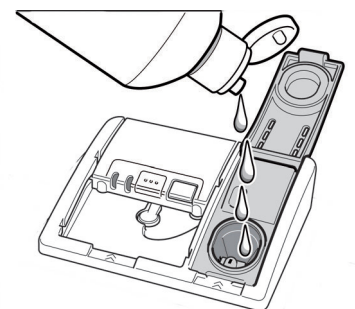

Dishware Materials

Note: Before using your dishwasher for the first time, check the information in this section. Some items are not dishwasher safe and should be hand washed; others require special loading.

Recommended

Aluminum: Colored anodized aluminum may fade over time. Minerals in your water may cause the aluminum to darken or spot. This can usually be removed with a soap-filled steel wool pad.

China, Crystal, Stoneware: Some hand-painted utensils may discolor, fade or spot. Hand wash these utensils. Position fragile glassware so that it will not fall over or come in contact with other utensils during the wash cycle.

Glass: Milk glasses may discolor or become yellow.

Non-stick Coatings: Apply a light coating of vegetable oil to non-stick surfaces after drying.

Plastics: Make sure the plasticware is dishwasher safe.

Stainless Steel, Sterling Silver and Silver Plates: Load these so they do not come in contact with other metals.

Not Recommended

Acrylic: crazing, small cracks throughout the acrylic, may occur.

Adhesive-Joined Pieces: Adhesives that join materials such as plastic, wood, bone, steel, copper, tin, etc. may loosen.

Bone-Handled Utensils: Handles may separate.

Iron: Iron will rust. Hand wash and dry immediately.

Non-Dishware Items: Your dishwasher is intended for use in cleaning ONLY standard household dishware and kitchenware.

Pewter, Brass, Bronze: These items will tarnish. Hand wash and dry immediately.

Tin: Tin will stain. Hand wash and dry immediately.

Wood: Wooden bowls, wooden utensils and utensils with wooden handles can crack, warp and lose their finish.

Loading the Dishwasher

Do not pre-wash items with loosely attached soiling. Remove all food particles, bones, toothpicks and excessive grease. Items having burned-on, baked-on or starchy soils may require some pretreatment. Refer to the Dishware Materials section for more information about dishware suitability.

Load only dishwasher safe items into the dishwasher. Load dishes in the dishwasher racks so the insides of bowls, pots and pans are facing the spray arms. Avoid nesting and contact points between dishes. Separate items of dissimilar metals.

Suggested Loading Pattern for Dishes

Upper Rack

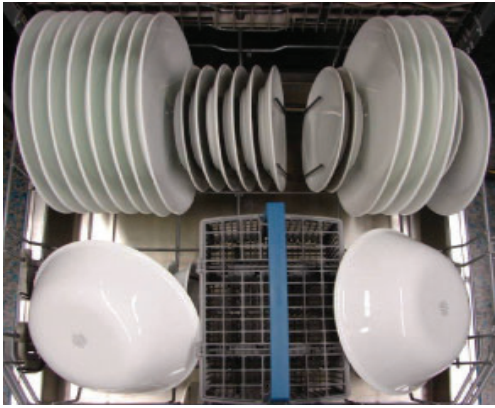

Bottom Rack



Cutlery Rack

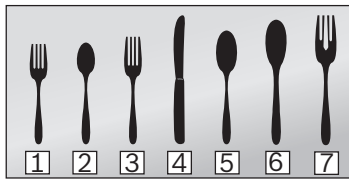
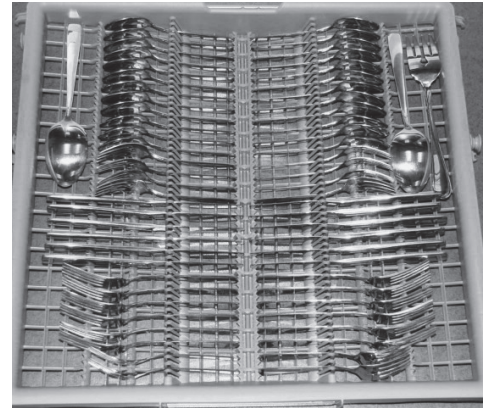

- 1- Salad fork
- 2- Teaspoon
- 3- Dinner fork
- 4- Knife
- 5- Tablespoon
- 6- Serving spoon
- 7- Serving fork

Silverware Basket

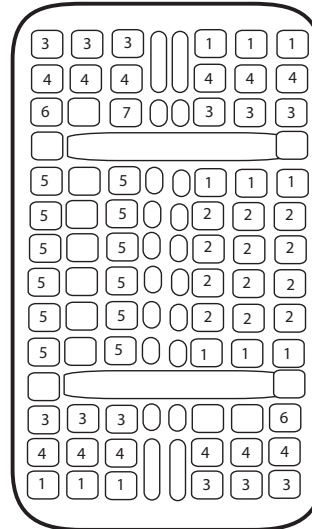

Suggested Loading Pattern for Dishes (10 place settings)

Upper Rack

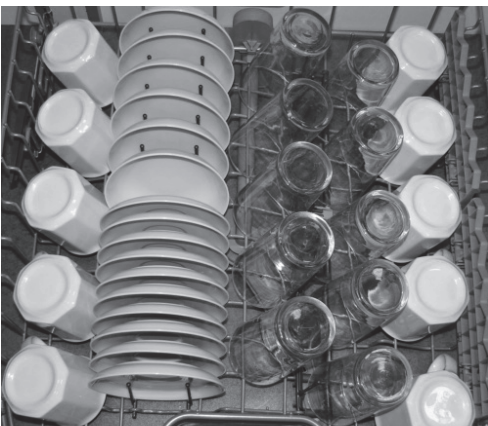

Bottom Rack



Cutlery Rack

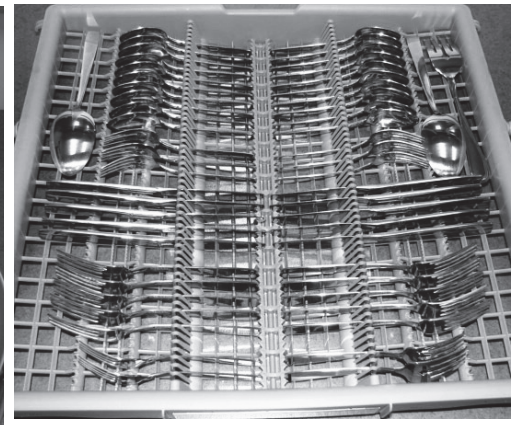

Rack Accessories

Flip Tines (model dependent)

The racks consist of tines that can be folded down depending on what you may need to load in the rack. To fold down, grasp the folding tine and release from notch. Push folding tine downward to desired position as shown in **Figure 6**.

Figure 6

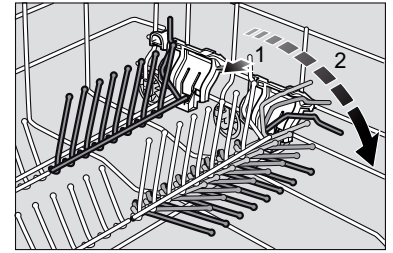

Extra Tall Item Sprinkler

If an item is too tall to be placed in the bottom rack even with the upper rack in the raised position, remove the empty upper rack by pulling it out of the dishwasher until it stops. Pull the front of the rack upward and outward until the rollers are completely free of the roller guides.

Set the upper rack aside. Push the roller guides back into the dishwasher. Insert the Extra Tall Item Sprinkler into the upper rack spray outlet and turn the sprinkler clockwise to lock into position. See **Figure 7**.

Note: Keep the vent on the tub's left side clear by placing tall items such as plastic cutting boards and tall baking sheets on the bottom rack's right side or center.

Figure 7



To avoid dishwasher damage, do not reinstall the upper rack without removing the Extra Tall Item Sprinkler.

Plastic Item Clips (model dependent)

Light-weight plastic accessories (cups, lids, etc.) can be held securely by the plastic item clips. See **Figure 8**.

Figure 8

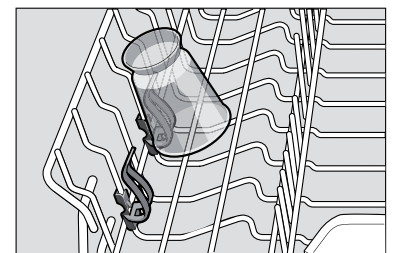

RackMatic®

The height of the upper rack can be adjusted in 3 steps to create more space.

- 1 Pull the upper rack out of the dishwasher until it stops.
- 2 To lower the rack, push the lever inward then upward.
- 3 To raise the rack, hold the basket on the sides of the upper rack and lift up.

Note: Before pushing the upper rack into the dishwasher, ensure the rack height is the same on both sides. If the height is not the same on both sides, the dishwasher door will not shut and the upper rack spray arm will not connect to the water inlet.

Figure 9

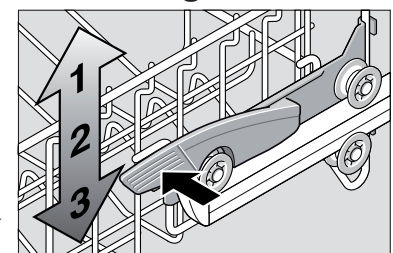

Cutlery Drawer

The cutlery drawer horizontally positions knives, spatulas and other oversized tools for improved cleaning and easier loading and unloading. Arrange cutlery in drawer as illustrated in **Figure 10**.

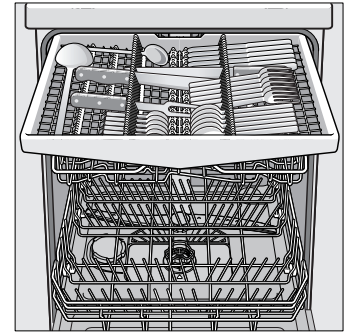

Figure 10

When loading large items such as pilsner glasses or 10” plates in the upper rack (as seen in **Figure 11**), the drawer can be removed to allow more room.



Figure 11

To remove:

- Pull empty drawer out of dishwasher until it stops rolling.
- While pulling toward you, lift the front of the drawer upward and outward (see **Figure 12**) until the rollers are completely free of the roller guides.
- Place empty drawer in safe place.

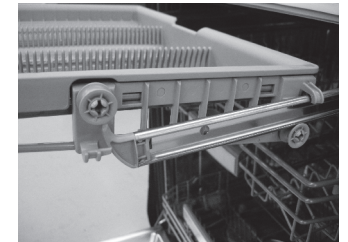

Figure 12

To reinstall:

- Pull the roller guides on both sides out of the dishwasher.
- Position drawer hooks on top of the roller guides (see **Figure 13**).
- While holding one roller guide, slide drawer's top wheel over the roller guide stop (see **Figure 14**).
- Repeat on other side.
- Slide drawer back into dishwasher.

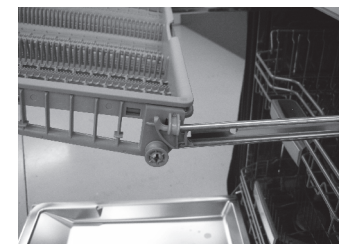

Figure 13

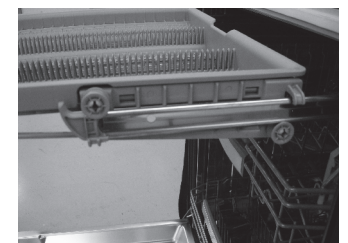

Figure 14

Dishwasher Cycles and Options

Wash Cycles (model dependent)

Note: In order to save energy, it is recommended to set the “Auto Power Off” feature (available on select models) to “P:01” (see manual section titled “Auto Power Off”).

Heavy: Best for cleaning items with baked-on food or grease. These dishes would normally require soaking.

Auto: With our most complex soil sensing capability, this cycle is perfect for use with mixed loads of dishware with varying amounts of food soil. This is the most flexible cycle.

Normal: This is the cycle recommended for daily, regular or typical use to completely wash a full load of normally soiled dishes.

In order to obtain optimal performance with minimum energy consumption, it is recommended to disable all available options and settings, except “Auto Power Off” as noted at the start of this section.

Note 1: See footnote for additional energy test setup instructions.

Delicate: For delicate or heirloom dishware and silverware or other special items. Always make sure that the items are dishwasher safe. Refer to the Dishware Materials section of this manual for further information. Hand washing may be the best treatment for such items.

Express: Cleans lightly soiled dishes and reduces overall wash time. Use this cycle to clean glasses and dessert dishware that may need to be reused at the same event.

Wash Cycle Options

Delay Start: Allows you to delay the start time of your dishwasher in one hour increments up to 24 hours.

Half Load Option: In the Heavy, Auto, Normal, and Delicate wash cycles, the Half Load option can reduce the energy and water consumption when washing small, lightly soiled loads that fill approximately half of the dishwasher’s capacity. To activate, select the Half Load button in addition to any of the three cycles listed above.

Sanitize: The Sanitize feature is available only in the Heavy, Auto and Normal cycles. Press the “Sanitize Option” button to activate the Sanitation features during the Auto and Normal cycles. The Sanitize symbol  or LED will always be on when running a Heavy cycle. The technical sanitation measures may also improve the drying results.

Note: The dishwasher automatically defaults to Auto Wash when turned off and back on. If you used the sanitize option in your last cycle, the dishwasher will default to Auto Wash with the Sanitize option selected when you turn it on.

Wash Cycle Information

The cycle times in this Use and Care Manual are based on normal soil loads and 120°F incoming water and will vary based on your actual conditions.

Table 3 - Wash Cycle Information

	Heavy	Auto	Normal	Delicate	Express
cycle time	110-135 min	105-129 min	95-135 min	80-85 min	30 min
cycle time with Half Load option	115 min	95-105 min	90-120 min	75-80 min	not available
cycle time with Sanitation option	130-150 min	125-150 min	115-155 min	not available	not available
water consumption	4.9-6.4 gal 18.6-24.2 L	3.5-6.5 gal 13.1-24.5 L	1.5-5.4 gal 5.8-20.6 L	2.5-3.8 gal 9.3-14.5 L	2.8 gal 10.5 L
wash temperature	150-160°F 66-71°C	127-150°F 53-66°C	113-131°F 45-55°C	113-122°F 45-50°C	113°F 45°C
rinse temperature	162°F 72°C	158°F 70°C	144-156°F 62-69°C	144°F 62°C	122°F 50°C

Note: Only sanitizing cycles have been designed to meet the requirements of 6 for soil removal and sanitization efficacy. There is no intention, either directly or indirectly, that all cycles have passed sanitization performance tests.

Note 1: The Energy Guide label was based on the soil sensing Normal Wash cycle as follows: The unit was tested without any Rinse Aid (liquid) in the Rinse Aid chamber. A single dose of detergent was inserted into the Detergent Dispenser, with no detergent being used in the prewash. The unit was not subjected to truncated testing per the definitions in the test procedure. We recommend that dish loads such as the one in the energy certification test have the rack position set in the highest position.

Operating the Dishwasher

Start the dishwasher

- 1 Open the door and press the **[On/Off]** button. The Auto cycle LED flashes.
- 2 Select the desired cycle and options.
- 3 Press **[Start]** and close the door to begin the cycle.

Cancel a cycle

- 1 Open the door just far enough to expose the control panel. Be careful of hot water that may splash out.
- 2 Press and hold the **[Start]** button for approximately 3 seconds until the display reads **"0:01"**.
- 3 Close the door and wait about 1 minute while the dishwasher drains.
- 4 Open the door and press the **[On/Off]** button.

Interrupt a cycle

- 1 Open the door just far enough to expose the control panel. Be careful of hot water that may splash out.
- 2 Press the **[On/Off]** button to turn the unit off.
- 3 To resume the cycle, press the **On/Off** button and close the dishwasher door.

Setting the amount of rinse aid

The amount of rinse aid dispensed can be set from "r:00" to "r:06".

To change the setting:

- 1 Open the door and press the **[On/Off]** button.
- 2 Hold down the **"A"** button (see page 4) and press **[Start]** until the display indicates **"H:00"**.
- 3 Release both buttons.
- 4 Press the **"A"** button until the display shows **"r:05"**.
- 5 Press the **"C"** button to select the desired setting.
 - "r:00" = dispenser is OFF
 - "r:01" = lowest setting
 - "r:02" = low setting
 - "r:03" = medium setting
 - "r:04" = medium/high setting
 - "r:05" = high setting
 - "r:06" = highest setting
- 6 Press **[Start]** to save the setting and close the door.

InfoLight®

A LED illuminates the floor to indicate the unit is running. If the appliance is installed at eye-level, the LED is not visible.

To change the setting:

- 1 Open the door and press the **[On/Off]** button.
- 2 Hold down the **"A"** button (see page 4) and press **[Start]** until the display indicates **"H:00"**.
- 3 Release both buttons.
- 4 Press the **"A"** button until the display shows **"1:01"**.
- 5 Press the **"C"** button to switch between **"1:01"** = ON and **"1:00"** = OFF and press **[Start]** to save.

Delay Start

You can delay the start of the cycle in one hour increments up to 24 hours.

To set delay start:

- 1 Open the door and press the **[On/Off]** button.
- 2 Press the **[+]** button until the display jumps to **"h:01"**.
- 3 Press the **[+]** or **[-]** button until the displayed time corresponds with your requirements.
 - h:01** = 1 hour delay
 - h:24** = 24 hour delay
- 4 Press **[Start]** to activate delay start.

To cancel delay start:

- 1 Press the **[+]** or **[-]** button until **"h:00"** is indicated on the digital display.
- 2 Press **[Start]** to save setting and close the door.

Cycle Completion Signal

- 1 Open the door and press the **[On/Off]** button.
- 2 Hold down the “**A**” button (see page 4) and press **[Start]** until the display indicates “**H:00**”.
- 3 Release both buttons.
- 4 Press the “**A**” button until the display shows “**b:02**”.
- 5 Press the “**C**” button to increase or decrease the tone “**b:00**” = OFF and “**b:03**” = LOUDEST
- 6 Press **[Start]** to save setting and close the door.

Intensive Drying

The final rinse uses a higher temperature which improves the drying results. The running time may increase slightly.

To turn intensive drying on:

- 1 Open the door and press the **[On/Off]** button.
- 2 Hold down the “**A**” button (see page 4) and press **[Start]** until the display indicates “**H:00**”.
- 3 Release both buttons.
- 4 Press the “**A**” button until the display shows “**d:00**”.
- 5 Press the “**C**” button to turn intensive drying on or off. “**d:01**” = ON and “**d:00**” = OFF
- 6 Press **[Start]** to save setting and close the door.

Auto Power Off

To save energy, the dishwasher is turned off 1 minute after the wash cycle ends. This function can be adjusted from P:00 to P:02.

To change the setting:

- 1 Open the door and press the **[On/Off]** button.
- 2 Hold down the “**A**” button and press **[Start]** until the display indicates “**d:0x**” (x can be any number).
- 3 Release both buttons.
- 4 Press the “**A**” button until the display indicates “**P:0x**”.
- 5 Press the “**C**” button until the display corresponds with your requirements.
 - P:00** = dishwasher does not turn off automatically
 - P:01** = dishwasher turns off automatically after 1 minute
 - P:02** = dishwasher turns off automatically after 120 minutes (2 hours)
- 6 Press **[Start]** to save the setting and close the door.

Care and Maintenance

A regular inspection and maintenance of your machine will help to prevent faults. This saves time and prevents future problems.

Overall condition of the machine

Never use a steam cleaner to clean your dishwasher. The manufacturer is not liable for any consequential damage.

Regularly wipe the front of the appliance with a damp cloth - water and a small amount of liquid soap is adequate. Do not use sponges with a rough surface or abrasive detergents, as these could scratch the surfaces.

Stainless steel appliances: To prevent corrosion, avoid using sponge cloths.

Clean the outer edges of the inside door panel regularly to remove debris that may collect from normal loading. If spots begin to appear on the stainless steel, make sure the rinse agent is full and functioning properly.

Filters

The filter system consists of a coarse filter, a flat fine filter and a micro filter. The filters keep large foreign objects in the rinsing water away from the pump. Foreign objects may occasionally block the filters.

Check the filters for residue by:

- Unscrew the filter cylinder as illustrated in **Figures 15-16** and take out the filter system.
- Remove any residue and clean filters under running water.
- Reinstall filter system in reverse sequence and ensure that the arrow marks are facing each other after locking it into place.

Spray Arms

Check spray arms for grease and limescale deposits.

If you find such deposits:

- Fill detergent dispenser with detergent and start the appliance without utensils in the cycle with the highest rinsing temperature (see wash cycle information table).
- Clean the appliance with detergents/ appliance cleaners which are particularly suitable for use with dishwashers.
- Unscrew the spray arms and inspect as shown in **Figure 17**.

Waste water pump

Large food remnants in the rinsing water not retained by the filters may block the waste water pump. The rinsing water does not get pumped out and covers the filters.

In this case:

- Disconnect the appliance from the power supply.
- Remove the filters.
- Scoop out standing water - use a sponge if necessary.
- Using a spoon, pry off the pump cover (see **Figures 18-19**) until it clicks, then grip the cover and pull upward until it resists and then pull forward.
- Check inner compartment and remove any foreign objects.
- Place cover in the original position, press down and engage.
- Reinstall filters.

Figure 15

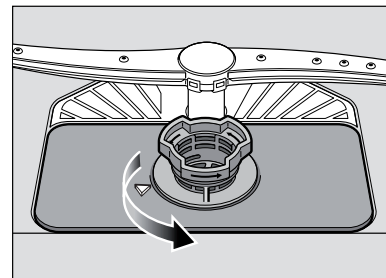

Figure 16

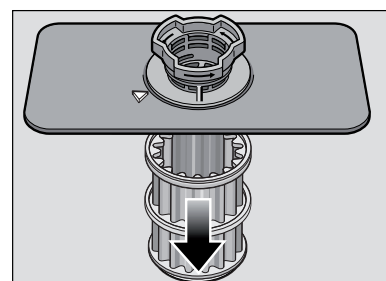

Figure 17

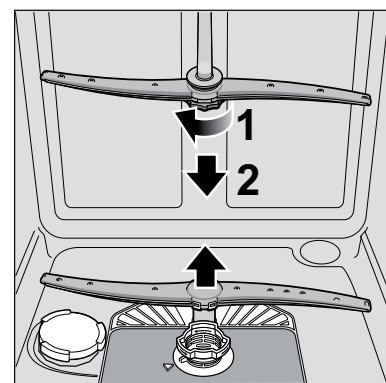

Figure 18

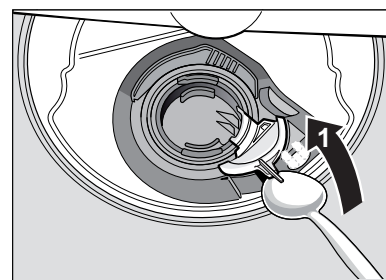
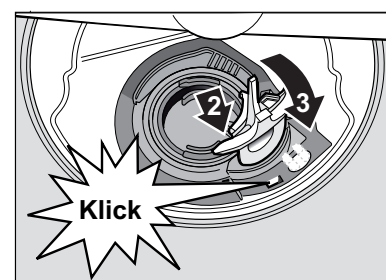

Figure 19



Troubleshooting Guide

Dishwashers may occasionally exhibit problems that are unrelated to a malfunction of the dishwasher itself. The following information may help you with a dishwasher problem without involving a repair professional.

Problem	Cause	Action
Dishwasher does not start	<ol style="list-style-type: none"> 1. Door may not be properly latched. 2. Unit may not be turned on. 3. Unit not reset or previous cycle not completed. 4. Delay start engaged. 5. Interruption of electrical power supply to dishwasher or blown fuse. 6. The door may have been closed without first selecting a cycle. 7. Water supply may not be turned on. 	<ol style="list-style-type: none"> 1. Shut the door completely. 2. Press the main power switch to turn unit on. 3. To reset, refer to "cancelling or changing cycle" in this manual. 4. To reset, refer to "delay start" section in this manual. 5. Check circuit breaker. 6. Select a cycle and close the door. 7. Check and turn on water supply.
Dishwasher beeping (end of cycle signal)	<ol style="list-style-type: none"> 1. Default factory settings alert the customer that the cycle is complete by beeping. This feature can be deactivated if so desired. 2. Water connection is lost. 	<ol style="list-style-type: none"> 1. To adjust the volume or deactivate, refer to the "cycle completion signal" section in this manual. 2. Check and turn on water supply.
Display does not illuminate or console lights are not on	<ol style="list-style-type: none"> 1. A fuse may have been blown or circuit breaker tripped. 2. Door not closed or latched. <p>Note: For models with controls on top of the door, the display only illuminate when the door is opened and controls are visible.</p>	<ol style="list-style-type: none"> 1. Check the fuse or circuit breaker box and replace the fuse or reset the breaker if necessary. 2. Ensure door is properly latched and completely closed.
Dishwasher seems to run a long time	<ol style="list-style-type: none"> 1. Incoming water is not warm enough. 2. Cycle time can vary due to soil and water conditions. 3. Rinse agent dispenser is empty. 4. Dishwasher connected to cold water supply. <p>Note: Refer to "wash cycle information" section in this manual for typical cycle lengths.</p>	<ol style="list-style-type: none"> 1. Before starting a cycle, run hot water faucet at the sink closest to the dishwasher. 2. Sensors in the dishwasher automatically increase the cycle time to ensure a good wash when heavy soil is detected. 3. Add rinse agent. 4. Verify dishwasher is connected to hot water supply plumbing.
Dishes are not getting clean enough	<ol style="list-style-type: none"> 1. Spray arm movement obstructed. 2. Spray arm nozzles clogged. 3. Improper use of detergents. 4. Filters could be clogged. 5. Dishes are nested or loaded too close together. 6. Selected wash cycle is not suitable for food soil conditions. 	<ol style="list-style-type: none"> 1. Ensure that spray arm movement is not blocked by hand rotating spray arms before starting cycle. 2. Remove the spray arms and clean according to the "care and maintenance" section of the manual. 3. Increase or decrease detergent depending on the water hardness (refer to Table 1). 4. Clean the filters according to the "care and maintenance" section of the manual. 5. Rearrange load such that water spray can reach all items in the dishwasher - see "loading the dishwasher" section of the manual. 6. Refer to "wash cycle information" section of the manual.
Dishes are not getting dry enough	<ol style="list-style-type: none"> 1. Rinse agent dispenser is empty. 2. Improper loading of dishes. 3. Selected cycle does not include drying. <p>Note: Plastic or Teflon do not typically dry as well as other items due to their inherent properties.</p>	<ol style="list-style-type: none"> 1. Add rinse agent - the use of rinse agent improves drying. 2. Rearrange load to ensure items are not nesting (see "loading the dishwasher" section of the manual). 3. Rinse and Hold setting does not include drying. <p>Note: Sanitize option and Intensive Drying feature also improve drying performance.</p>

Problem	Cause	Action
Odor	<ol style="list-style-type: none"> 1. Food debris is present at the bottom of the dishwasher. 2. Food particles are present near the door seal. 3. Dishes left in unit too long before running a cycle. 4. Residual water is present at the bottom of the dishwasher. 5. Drain hose is obstructed. 	<ol style="list-style-type: none"> 1. Remove the filters and clean according to the "care and maintenance" section of the manual. 2. Refer to "care and maintenance" section of the manual. 3. Run a Rinse and Hold cycle if you do not intend to immediately wash the dishes. 4. Ensure the unit has completely drained from the last cycle. 5. Remove any obstructions from the drain hose by calling qualified personnel. <p>Note: If odor still persists, run the Normal/Regular cycle until it flushes and interrupt the cycle and place an 8oz. cup of distilled white vinegar solution on the upper rack and then finish the cycle.</p>
Dishwasher not filling with water	<ol style="list-style-type: none"> 1. Restriction in the water supply system. 2. Previous wash cycle was not completed. 3. Delay start is active. 	<ol style="list-style-type: none"> 1. Ensure that the water supply valve (typically located under kitchen sink) is open and check that the water supply line has no kinks or clogs. 2. Refer to the "operating the dishwasher" section of the manual. 3. Cancel the delay start or wait until delay start time completes.
Water leaks	<ol style="list-style-type: none"> 1. Suds. 2. Door seal could be pulled away from track. 3. Condensation vent is blocked. 4. Improper installation. 	<ol style="list-style-type: none"> 1. Wrong type of detergent results in suds and leaks - use only dishwasher detergents. If suds still persist, add one tablespoon of vegetable oil at the bottom of the dishwasher and run the desired cycle. 2. Ensure the door seal is in the track. 3. Ensure that condensation vent is not blocked. 4. Have proper installation verified by qualified personnel (water supply, drain system, leveling, plumbing).
Tub stains	<ol style="list-style-type: none"> 1. Stains on the dishwasher interior are due to water hardness. 2. Silverware in contact with tub. 	<ol style="list-style-type: none"> 1. Concentrated lemon juice can reduce the build up of hard water stains. Run a Regular cycle until it flushes and interrupt the cycle and then place an 8oz. cup of the concentrated lemon solution on the upper rack and finish the cycle. this can be done periodically to avoid build up. 2. Ensure that silverware does not make contact with the tub while running a cycle.
Streaks on glassware or residue on the dishes	<ol style="list-style-type: none"> 1. Incorrect rinse agent setting. 	<ol style="list-style-type: none"> 1. Depending on the hardness of water, adjust the rinse agent dispenser. Refer to "Adding detergent and rinse agent" section in the manual.
Fascia panel discolored or marked	<ol style="list-style-type: none"> 1. Abrasive cleaner used. 	<ol style="list-style-type: none"> 1. Use mild detergents with soft damp cloth.
Noise during wash cycle	<ol style="list-style-type: none"> 1. Dishes may not be arranged properly. 	<ol style="list-style-type: none"> 1. Water circulation sound is normal, but if you suspect items are banging into each other or into the spray arms, refer to the "loading the dishwasher" section of the manual for optimal arrangement.
Detergent dispenser cover will not shut	<ol style="list-style-type: none"> 1. Improper operation of detergent cover. 2. Previous cycle has not been finished or rest or cycle or interrupted. 	<ol style="list-style-type: none"> 1. Refer to "Adding detergent and rinse agent" section of the manual for instructions on opening and closing the dispenser. 2. Refer to the "operating the dishwasher" section of the manual.
Unable to select desired cycle	<ol style="list-style-type: none"> 1. Previous cycle has not finished. 	<ol style="list-style-type: none"> 1. Refer to the "Operating the Dishwasher" section of the manual.

Customer Service

Your Bosch® dishwasher requires no special care other than that described in the Care and Maintenance section of this manual. If you are having a problem with your dishwasher, before calling for service please refer to the Troubleshooting Guide section of the manual. If service is necessary, contact your dealer or installer or an authorized service center. Do not attempt to repair the appliance yourself. Any work performed by unauthorized personnel may void the warranty.

If you are having a problem with your Bosch® dishwasher and are not pleased with the service you have received, please take the following steps until the problem is corrected to your satisfaction:

- 1 Call us at 1-800-944-2904
- 2 Contact Customer Service from our web site:
www.bosch-home.com/us or www.bosch-appliances.ca
- 3 Contact your installer or the Bosch® Authorized Service Contractor in your area.

Please be sure to include your model information as well as an explanation of the problem and the date it started.

You will find the model and serial number information on the label located on the edge of the dishwasher door.

Also, if you are writing, please include a daytime phone number where you can be reached.

Please make a copy of your invoice and keep it with this manual. The customer must show proof of purchase to obtain warranty service.

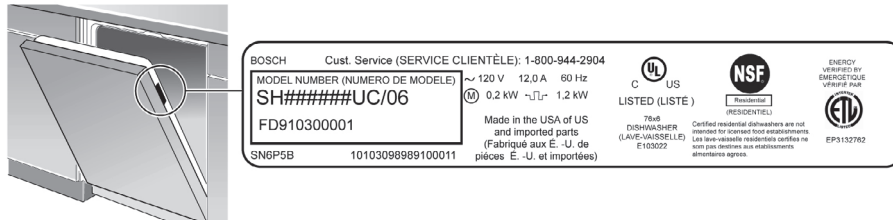

This Bosch® dishwasher is backed by the Good Housekeeping Seal. The limited warranty reflected by the Good Housekeeping Seal means that if a product bearing the Seal is defective within the first two years of purchase, Good Housekeeping will replace the product or refund the purchase price. For details please visit GHSeal.com.

Warranty Information

What this Warranty Covers & Who it Applies to: The limited warranty provided by BSH Home Appliances (“Bosch”) in this Statement of Limited Product Warranty applies only to Bosch dishwashers (“Product”) sold to you, the first using purchaser, provided that the Product was purchased: (1) for your normal, household (non-commercial) use, and has in fact at all times only been used for normal household purposes; (2) new at retail (not a display, “as is”, or previously returned model), and not for resale, or commercial use; and (3) within the United States or Canada, and has at all times remained within the country of original purchase. The warranties stated herein apply only to the first purchaser of the Product and are not transferable.

• Please make sure to return your registration card; while not necessary to effectuate warranty coverage, it is the best way for Bosch to notify you in the unlikely event of a safety notice or product recall.

How Long the Warranty Lasts: Bosch warrants that the Product is free from defects in materials and workmanship for a period of three hundred sixty five (365) days from the date of purchase. The foregoing timeline begins to run upon the date of purchase, and shall not be stalled, tolled, extended, or suspended, for any reason whatsoever. Labor and shipping costs are included in this basic coverage.

Extended Limited Warranty: Bosch also provides these additional limited warranties:

- 2 Year Limited Warranty: Bosch will repair or replace any component that proves to be defective in materials or workmanship (excludes labor charges).
- 5 Year Limited Warranty on Electronics: Bosch will repair or replace any Bosch microprocessor or printed circuit board if it proves to be defective in materials or workmanship (excludes labor charges).
- 5 Year Limited Warranty on Dish Racks: Bosch will replace the upper or lower dish rack (excluding rack components), if the rack proves defective in materials or workmanship (excludes labor charges).
- Lifetime Warranty against Stainless Steel Rust Through: Bosch will replace your dishwasher with the same model or a current model that is substantially equivalent or better in functionality, if the inner liner should rust through (excludes labor charges).
- Bosch will replace the stainless steel door if the door should rust through (excludes labor charges).

The foregoing timeline begins to run upon the date of purchase, and shall not be stalled, tolled, extended, or suspended, for any reason whatsoever.

Repair/Replace as Your Exclusive Remedy: During this warranty period, Bosch or one of its authorized service providers will repair your Product without charge to you (subject to certain limitations stated herein) if your Product proves to have been manufactured with a defect in materials or workmanship. If reasonable attempts to repair the Product have been made without success, then Bosch will replace your Product (upgraded models may be available to you, in Bosch’s sole discretion, for an additional charge). All removed parts and components shall become the property of Bosch at its sole option. All replaced and/or repaired parts shall assume the identity of the original part for purposes of this warranty and this warranty shall not be extended with respect to such parts. Bosch’s sole liability and responsibility hereunder is to repair manufacturer-defective Product only, using a Bosch-authorized service provider during normal business hours. For safety and property damage concerns, Bosch highly recommends that you do not attempt to repair the Product yourself, or use an unauthorized servicer; Bosch will have no responsibility or liability for repairs or work performed by a non-authorized servicer. If you choose to have someone other than an authorized service provider work on your Product, THIS WARRANTY WILL AUTOMATICALLY BECOME NULL AND VOID. Authorized service providers are those persons or companies that have been specially trained on Bosch products, and who possess, in Bosch’s opinion, a superior reputation for customer service and technical ability (note that they are independent entities and are not agents, partners, affiliates or representatives of Bosch). Notwithstanding the foregoing, Bosch will not incur any liability, or have responsibility, for the Product if it is located in a remote area (more than 100 miles from an authorized service provider) or is reasonably inaccessible, hazardous, threatening, or treacherous locale, surroundings, or environment; in any such event, if you request, Bosch would still pay for labor and parts and ship the parts to the nearest authorized service provider, but you would still be fully liable and responsible for any travel time or other special charges by the service company, assuming they agree to make the service call.

Out of Warranty Product: Bosch is under no obligation, at law or otherwise, to provide you with any concessions, including repairs, pro-rates, or Product replacement, once this warranty has expired.

Warranty Exclusions: The warranty coverage described herein excludes all defects or damage that are not the direct fault of Bosch, including without limitation, one or more of the following: (1) use of the Product in anything other than its normal, customary and intended manner (including without limitation, any form of commercial use, use or storage of an indoor product outdoors, use of the Product in conjunction with air or water-going vessels); (2) any party’s willful misconduct, negligence, misuse, abuse, accidents, neglect, improper operation, failure to maintain, improper or negligent installation, tampering, failure to follow operating instructions, mishandling, unauthorized service (including self-performed “fixing” or exploration of the appliance’s internal workings); (3) adjustment, alteration or modification of any kind; (4) a failure to comply with any applicable state, local, city, or county electrical, plumbing and/or building codes, regulations, or laws, including failure to install the product in strict conformity with local fire and building codes and regulations; (5) ordinary wear and tear, spills of food, liquid, grease accumulations, or other substances that accumulate on, in, or around the Product; and (6) any external, elemental and/or environmental forces and factors, including without limitation, rain, wind, sand, floods, fires, mud slides, freezing temperatures, excessive moisture or extended exposure to humidity, lightning, power surges, structural failures surrounding the appliance, and acts of God. In no event shall Bosch have any liability or responsibility whatsoever for damage to surrounding property, including cabinetry, floors, ceilings, and other structures or objects around the Product. Also excluded from this warranty are scratches, nicks, minor dents, and cosmetic damages on external surfaces and exposed parts; Products on which the serial numbers have been altered, defaced, or removed; service visits to teach you how to use the Product, or visits where there is nothing wrong with the Product; correction of installation problems (you are solely responsible for any structure and setting for the Product, including all electrical, plumbing or other connecting facilities, for proper foundation/flooring, and for any alterations including without limitation cabinetry, walls, floors, shelving, etc.); and resetting of breakers or fuses.

TO THE EXTENT ALLOWED BY LAW, THIS WARRANTY SETS OUT YOUR EXCLUSIVE REMEDIES WITH RESPECT TO PRODUCT, WHETHER THE CLAIM ARISES IN CONTRACT OR TORT (INCLUDING STRICT LIABILITY, OR NEGLIGENCE) OR OTHERWISE. THIS WARRANTY IS IN LIEU OF ALL OTHER WARRANTIES, WHETHER EXPRESS OR IMPLIED. ANY WARRANTY IMPLIED BY LAW, WHETHER FOR MERCHANTABILITY OR FITNESS FOR A PARTICULAR PURPOSE, OR OTHERWISE, SHALL BE EFFECTIVE ONLY FOR THE PERIOD THAT THIS EXPRESS LIMITED WARRANTY IS EFFECTIVE. IN NO EVENT WILL THE MANUFACTURER BE LIABLE FOR CONSEQUENTIAL, SPECIAL, INCIDENTAL, INDIRECT, “BUSINESS LOSS”, AND/OR PUNITIVE DAMAGES, LOSSES, OR EXPENSES, INCLUDING WITHOUT LIMITATION TIME AWAY FROM WORK, HOTELS AND/OR RESTAURANT MEALS, REMODELLING EXPENSES IN EXCESS OF DIRECT DAMAGES WHICH ARE DEFINITELY CAUSED EXCLUSIVELY BY BOSCH, OR OTHERWISE. SOME STATES DO NOT ALLOW THE EXCLUSION OR LIMITATION OF INCIDENTAL OR CONSEQUENTIAL DAMAGES, AND SOME STATES DO NOT ALLOW LIMITATIONS ON HOW LONG AN IMPLIED WARRANTY LASTS, SO THE ABOVE LIMITATIONS MAY NOT APPLY TO YOU. THIS WARRANTY GIVES YOU SPECIFIC LEGAL RIGHTS, AND YOU MAY ALSO HAVE OTHER RIGHTS WHICH VARY FROM STATE TO STATE. No attempt to alter, modify or amend this warranty shall be effective unless authorized in writing by an officer of BSH.

How to Obtain Warranty Service: TO OBTAIN WARRANTY SERVICE FOR YOUR PRODUCT, YOU SHOULD CONTACT THE NEAREST BOSCH AUTHORIZED SERVICE CENTER, OR CALL 800-944-2904.

BSH reserves the right to change specifications or design without notice. Some models are certified for use in Canada. BSH is not responsible for products which are transported from the United States for use in Canada.
Check with your local Canadian distributor or dealer.

BSH se réserve le droit de modifier les données techniques ou le design sans préavis. Certains modèles sont certifiés pour une utilisation au Canada. BSH n'est pas responsable pour les produits transportés des États-Unis pour une utilisation au Canada. Vérifier auprès d'un marchand ou distributeur canadien.

BSH Home Appliances Corporation
1901 Main Street
Irvine, CA 92614

9000953941 (0114)