

Top-Loading Washer Use and Care Guide

Laveuse à chargement par le dessus guide d'utilisation et d'entretien

Para una versión de estas instrucciones en español, consulte la página de “Ayuda o servicio técnico”.

Table of Contents

WASHER SAFETY	2
WHAT'S NEW UNDER THE LID?	3
CONTROL PANEL AND FEATURES	4
CYCLE GUIDE	6
USING YOUR WASHER	7
WASHER MAINTENANCE	10
TROUBLESHOOTING	12
WARRANTY	17
ASSISTANCE OR SERVICE	BACK COVER

Table des matières

SÉCURITÉ DE LA LAVEUSE	18
QUOI DE NEUF SOUS LE COUVERCLE?	19
TABLEAU DE COMMANDE ET CARACTÉRISTIQUES	20
GUIDE DE PROGRAMMES	22
UTILISATION DE LA LAVEUSE	23
ENTRETIEN DE LA LAVEUSE	26
DÉPANNAGE	28
GARANTIE	35
ASSISTANCE OU SERVICE	COUVERTURE ARRIÈRE



Designed to use only HE High Efficiency
detergents.
Conçue pour l'utilisation d'un détergent
haute efficacité seulement.

Washer Safety

Your safety and the safety of others are very important.

We have provided many important safety messages in this manual and on your appliance. Always read and obey all safety messages.



This is the safety alert symbol.

This symbol alerts you to potential hazards that can kill or hurt you and others.

All safety messages will follow the safety alert symbol and either the word "DANGER" or "WARNING." These words mean:

! DANGER

You can be killed or seriously injured if you don't immediately follow instructions.

! WARNING

You can be killed or seriously injured if you don't follow instructions.

All safety messages will tell you what the potential hazard is, tell you how to reduce the chance of injury, and tell you what can happen if the instructions are not followed.

IMPORTANT SAFETY INSTRUCTIONS

WARNING: To reduce the risk of fire, electric shock, or injury to persons when using the washer, follow basic precautions, including the following:

- Read all instructions before using the washer.
- Do not wash articles that have been previously cleaned in, washed in, soaked in, or spotted with gasoline, dry-cleaning solvents, other flammable, or explosive substances as they give off vapors that could ignite or explode.
- Do not add gasoline, dry-cleaning solvents, or other flammable, or explosive substances to the wash water. These substances give off vapors that could ignite or explode.
- Under certain conditions, hydrogen gas may be produced in a hot water system that has not been used for 2 weeks or more. **HYDROGEN GAS IS EXPLOSIVE.** If the hot water system has not been used for such a period, before using the washing machine, turn on all hot water faucets and let the water flow from each for several minutes. This will release any accumulated hydrogen gas. As the gas is flammable, do not smoke or use an open flame during this time.
- Do not allow children to play on or in the washer. Close supervision of children is necessary when the washer is used near children.
- Before the washer is removed from service or discarded, remove the door or lid.
- Do not reach into the washer if the drum, tub or agitator is moving.
- Do not install or store the washer where it will be exposed to the weather.
- Do not tamper with controls.
- Do not repair or replace any part of the washer or attempt any servicing unless specifically recommended in this manual or in published user-repair instructions that you understand and have the skills to carry out.
- See "Electrical Requirements" located in the installation instructions for grounding instructions.

SAVE THESE INSTRUCTIONS

State of California Proposition 65 Warnings:

WARNING: This product contains one or more chemicals known to the State of California to cause cancer.

WARNING: This product contains one or more chemicals known to the State of California to cause birth defects or other reproductive harm.

What's New Under the Lid?

Your new washer will operate differently than your past agitator-style washer.

Lid Lock

To allow for higher spin speeds, the lid will lock and the Lid Locked light will turn on. When this light is lit, the lid is locked and cannot be opened. When this light is blinking, the washer is paused. When this light is off, the lid can be opened. After a cycle is started, the washer will fill to the appropriate water level. When the washer is done filling, it will start to agitate. If you need to open the lid to add a garment after this point, the lid will remain unlocked during the entire agitation portion of the wash phase. The cycle will automatically pause when the lid is opened, and the cycle will resume once the lid is closed. The lid will lock before the spin phase begins. If you need to pause or stop after this point, you must press START/STOP/PAUSE/UNLOCK LID and wait for the lid to unlock. The lid will only unlock after washer movement has stopped. Depending on when in the cycle you try to pause, it may take several seconds to several minutes for the lid to unlock. Press START/STOP/PAUSE/UNLOCK LID to resume the cycle.

Water Level Options

Set the Water Level knob to the Auto Sensing setting and the washer automatically adjusts the water level to the load size. Set the Water Level knob to the Deep Water Wash setting and the washer will fill to the maximum water level.

Sensing

This washer will perform a series of spins to check for load balance. During this time, a series of clicks and a whirring noise signal that sensing technology is determining if there is an off-balance load.

Normal Sounds You Can Expect

At different stages of the wash cycle, you may hear sounds and noises that are different from those of your previous washer. For example, you may hear a clicking and hum at the beginning of the spin phase as the lid lock goes through a self-test. There will be different kinds of humming sounds as the agitator tests for load balance or moves the load. And sometimes, you may hear nothing at all, as the washer determines the correct water level for your load or allows time for clothes to soak.

Spray Rinse

Select cycles default to a spray rinse. During these cycles, you will hear water enter the washer as the tub spins, allowing the rinse water to penetrate clothes. Check the "Cycle Guide" for details.

Choosing the Right Detergent

Use only High Efficiency detergents. The package will be marked "HE" or "High Efficiency." Using non-HE detergent will likely result in longer cycle times and reduced rinsing performance. It may also result in component malfunction and, over time, buildup of mold or mildew. HE detergents should be low-sudsing and quick-dispersing to produce the right amount of suds for the best performance. They should hold soil in suspension so it is not redeposited onto clean clothes. Not all detergents labeled as High Efficiency are identical in formulation and their ability to reduce suds. For example, natural, organic, or homemade HE detergents may generate a high level of suds. Always follow the detergent manufacturer's instructions to determine the amount of detergent to use.



Use only High Efficiency (HE) detergent.

Accessories

Enhance your new washer with the following genuine Whirlpool Accessories. For more information on options and ordering, call 1-800-901-2042 or visit us at: www.whirlpool.com/accessories. In Canada, call 1-800-807-6777 or visit us at www.whirlpoolparts.ca.

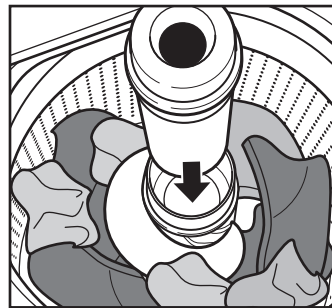

Fabric Softener Dispenser

This convenient fabric softener dispenser connects to the agitator and saves you from manually adding fabric softener during the rinse cycle.

IMPORTANT: The lid must be closed before the washer basket fills with water and for the wash cycle to start. If the lid is open and filling stops, close the lid and press START/STOP/PAUSE/UNLOCK LID to complete the cycle.

Control Panel and Features

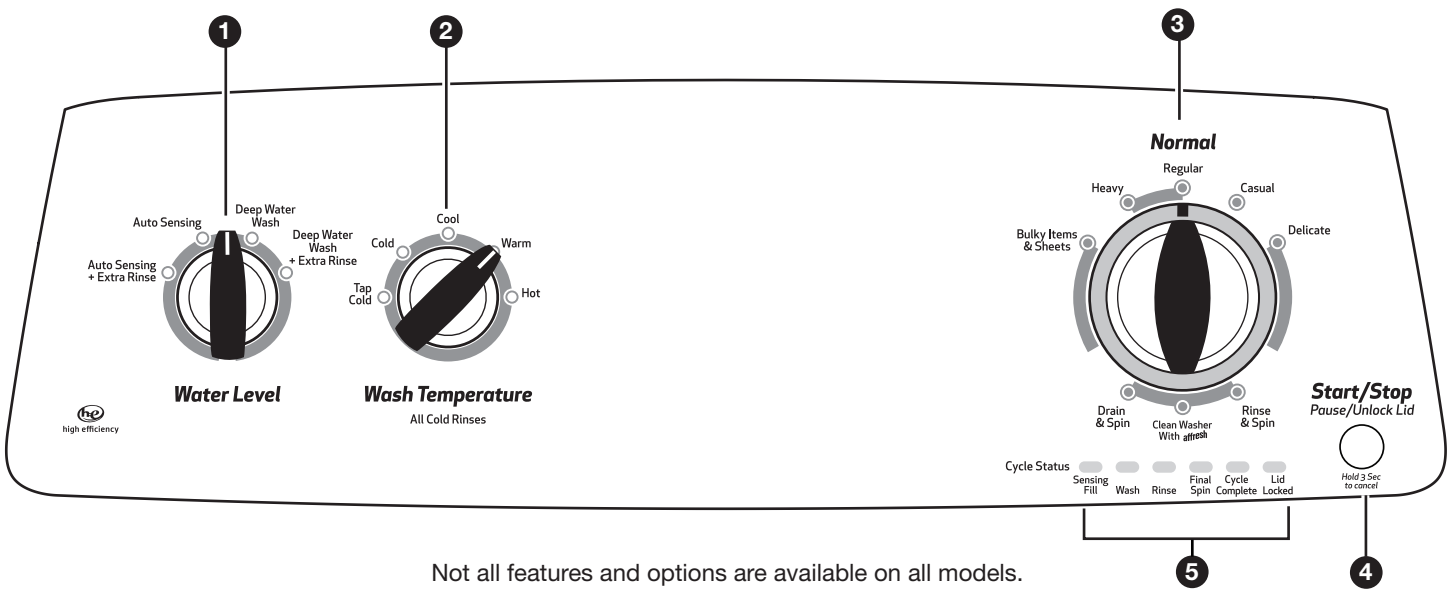

Not all features and options are available on all models.
Appearance may vary.

1 WATER LEVEL

Set the Water Level knob to the Auto Sensing setting and the washer will automatically sense the appropriate water level for the load size and type.

Set the Water Level knob to the Deep Water Wash setting and the washer will fill to the maximum water level.

NOTE: Cycle times will be longer due to extended fill times when using the Deep Water Wash setting.

2 WASH TEMPERATURE

Wash Temperature senses and maintains uniform water temperatures by regulating incoming hot and cold water.

Select a wash temperature based on the type of fabric and soils being washed. For best results and following the garment label instructions, use the warmest wash water safe for your fabric.

- On some models and cycles, warm and hot water may be cooler than your previous washer.
- Even in a cold and cool water wash, some warm water may be added to the washer to maintain a minimum temperature. All rinses are cold.

3 WASH CYCLE KNOB

Use the Wash Cycle knob to select cycles on your washer. See “Cycle Guide” for detailed descriptions of cycles.

4 START/STOP/PAUSE/UNLOCK LID BUTTON

Press to start the selected cycle; press again to pause the cycle and unlock the lid.

NOTE: If the washer is spinning, it may take several minutes to unlock the lid. Press and hold for 3 seconds to cancel a cycle.

5 CYCLE STATUS LIGHTS INDICATOR



The Cycle Status lights show the progress of a cycle. At each stage of the process, you may notice sounds or pauses that are different from your previous washer.

SENSING/FILL

When the Start/Stop/Pause/Unlock Lid button is pressed, and the Water Level knob is set to Auto Sensing, the washer will fill and begin sensing to determine load size and balance.

Once sensing is complete, the washer will fill to the appropriate level for the detected load size and then begin the wash phase of the cycle.

NOTE: Sensing and wash phases will be paused by opening the unlocked lid. Close the lid to resume the cycle. If the lid is left open for more than 10 minutes, the washer will cancel the cycle and pump out the water. The lid will lock after the wash phase to begin the initial spinout and remain locked for the remainder of the cycle.

WASH

The washer will fill to the correct water level based on the load size and the Water Level selection. Certain cycles may agitate during the fill process to boost cleaning. You will hear the agitator rotate, followed by a pause lasting several seconds. When the wash cycle begins, you will hear the agitator increase speed. The motor sounds may change at different stages in the wash cycle while the washer performs different wash actions.

RINSE

Certain cycles use a spray rinse, which adds water to the tub while the basket spins. You may hear the motor turning on briefly (short hum) to move the basket while filling.

FINAL SPIN

The washer spins the load at increasing speeds for proper water removal, based on the selected cycle.

CYCLE COMPLETE

Once the cycle is complete, this light will come on. Remove the load promptly for best results.

LID LOCKED

The Lock feature allows for higher spin speeds. When the Lid Locked light is lit, the lid is locked and cannot be opened without pausing the cycle. When the light is off, the lid can be opened.

To open the lid after it has been locked, press START/STOP/PAUSE/UNLOCK LID. The lid will unlock once the washer movement has stopped. This may take several minutes if the load was spinning at high speed. Press START/STOP/PAUSE/UNLOCK LID again to resume the cycle.

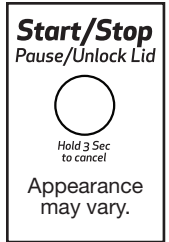

Cycle Guide

For best fabric care, choose the cycle that best fits the load being washed. Recommended settings for best performance are shown in **Bold**. Not all cycles and options are available on all models.

Items to wash:	Cycle	Wash Temperature:*	Cycle Details:
Large items such as sheets, sleeping bags, small comforters, jackets, small washable rugs	Bulky Items & Sheets	Hot Warm Cool Cold Tap Cold	Use this cycle to wash large items such as jackets and small comforters. The washer will fill with enough water to wet down the load before the wash portion of the cycle begins, and uses a higher water level than other cycles.
Sturdy fabrics, colorfast items, towels, sheets, jeans	Normal Heavy	Hot Warm Cool Cold Tap Cold	Use this cycle for heavily soiled or sturdy fabrics.
Cottons, linens, and mixed garment loads	Normal Regular	Hot Warm Cool Cold Tap Cold	Use this cycle for normally soiled cottons and mixed-fabric loads.
No-iron fabrics, cottons, perm. press, linens, synthetics	Casual	Hot Warm Cool Cold Tap Cold	Use this cycle to wash loads of no-iron fabrics such as sport shirts, blouses, casual business clothes, permanent press, and blends.
Machine-wash silks, lingerie, washable wools	Delicate	Hot Warm Cool Cold Tap Cold	Use this cycle to wash lightly soiled garments indicating "Machine Washable Silks" or "Gentle" cycle on the care label. Place small items in mesh garment bags before washing.
Swimsuits and items requiring rinsing without detergent	Rinse & Spin	Cold rinse only	Combines a rinse and high-speed spin for loads requiring an additional rinse cycle or to complete a load after power interruption. Also use for loads that require rinsing only.
No clothes in washer	Clean Washer with affresh®	Hot Warm Cool Cold Tap Cold	Use this cycle every 30 washes to keep the inside of your washer fresh and clean. This cycle uses a higher water level. Use with affresh® Washer Cleaner tablet or liquid chlorine bleach to thoroughly clean the inside of your washer. This cycle should not be interrupted. See "Washer Care." IMPORTANT: Do not place garments or other items in the washer during the Clean Washer with affresh® cycle. Use this cycle with an empty washtub.
Hand-washed garments or dripping wet items	Drain & Spin	N/A	This cycle uses a spin to shorten drying times for heavy fabrics or special-care items washed by hand. Use this cycle to drain washer after cancelling a cycle or completing a cycle after a power failure.

*All rinses are cold.

Using Your Washer

⚠ WARNING



Fire Hazard

Never place items in the washer that are dampened with gasoline or other flammable fluids.

No washer can completely remove oil.

Do not dry anything that has ever had any type of oil on it (including cooking oils).

Doing so can result in death, explosion, or fire.

⚠ WARNING



Electrical Shock Hazard

Plug into a grounded 3 prong outlet.

Do not remove ground prong.

Do not use an adapter.

Do not use an extension cord.

Failure to follow these instructions can result in death, fire, or electrical shock.

1. Sort and prepare your laundry

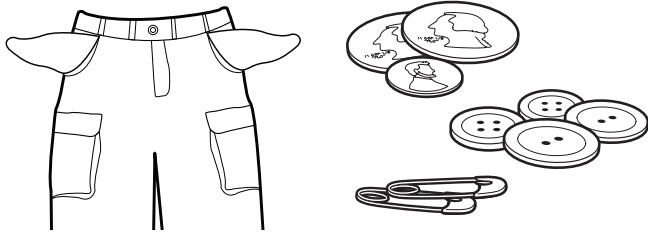

- Empty pockets. Loose change, buttons, or any small object can pass under the agitator and become trapped, causing unexpected sounds.
- Sort items by recommended cycle, water temperature, and colorfastness.
- Separate heavily soiled items from lightly soiled.
- Separate delicate items from sturdy fabrics.
- Do not dry garments if stains remain after washing, because heat can set stains into fabric.
- Treat stains promptly.
- Close zippers, fasten hooks, tie strings and sashes, and remove non-washable trim and ornaments.
- Mend rips and tears to avoid further damage to items during washing.

Helpful Tips:

- When washing waterproof or water-resistant items, load evenly.
- Use mesh garment bags to help avoid tangling when washing delicate or small items.
- Turn knits inside-out to avoid pilling. Separate lint-takers from lint-givers. Synthetics, knits, and corduroy fabrics will pick up lint from towels, rugs, and chenille fabrics.

NOTE: Always read and follow fabric care label instructions to avoid damage to your garments.

2. Add laundry products

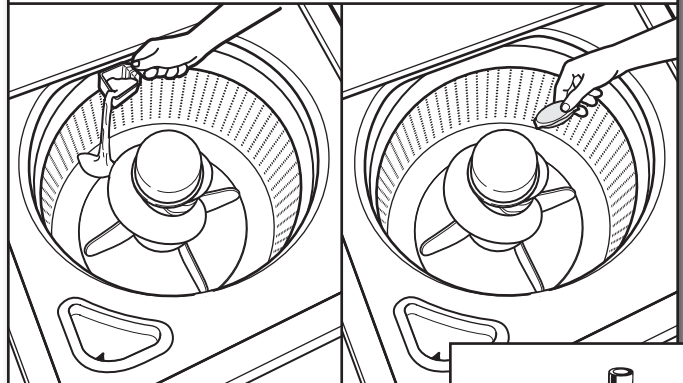

Add a measured amount of HE detergent or single-dose laundry packet into the basket.

If using Oxi-type boosters, color-safe bleach, or fabric softener crystals, add to the bottom of the washer basket before adding clothes.

IMPORTANT: Use only High Efficiency detergents. The package will be marked "HE" or "High Efficiency." Using non-HE detergent will likely result in longer cycle times and reduced rinsing performance. It may also result in component malfunction and, over time, buildup of mold or mildew. HE detergents should be low-sudsing and quick-dispersing to produce the right amount of suds for the best performance. They should hold soil in suspension so it is not redeposited onto clean clothes. Not all detergents labeled as High Efficiency are identical in formulation and their ability to reduce suds. For example, natural, organic, or homemade HE detergents may generate a high level of suds.

NOTE: Follow the manufacturer's instructions to determine the amount of laundry products to use.



3. Load laundry into washer

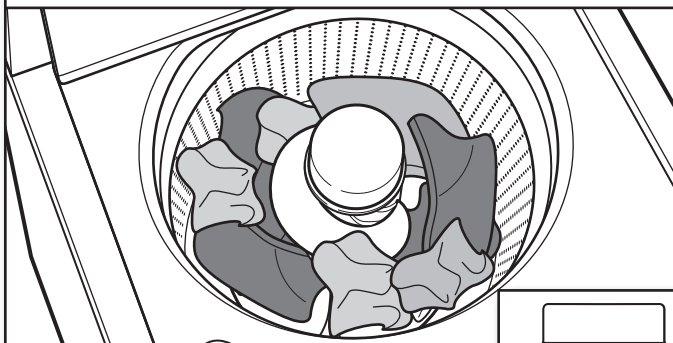

Load garments in loose heaps evenly around basket wall. For best results, do not pack the load tightly. Do not wrap large items such as sheets around the agitator; load them in loose piles around the sides of the basket. Try mixing different-sized items to reduce tangling.

IMPORTANT: Do not tightly pack or force items into washer. Items need to move freely for best cleaning and to reduce wrinkling and tangling.

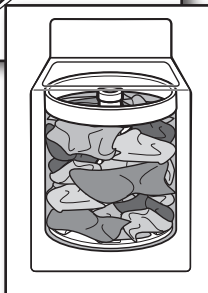

4. Add liquid chlorine bleach to dispenser

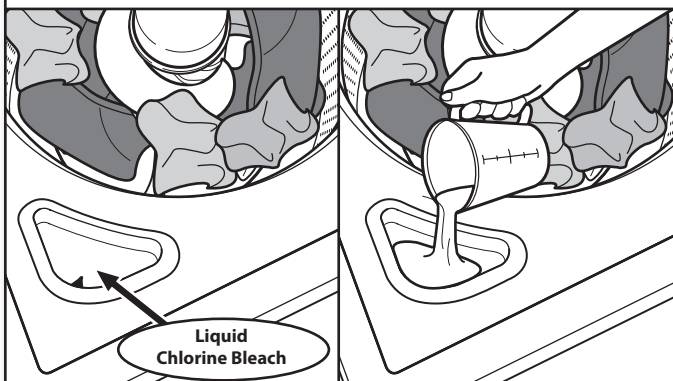

Do not overfill, dilute, or use more than 1 cup (236 mL). Do not use color-safe bleach or Oxi products in the same cycle with liquid chlorine bleach.

5. Select cycle

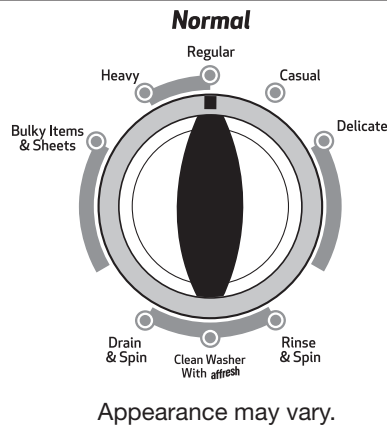

Turn cycle knob to choose your wash cycle. For more information, see "Cycle Guide."

6. Select WATER LEVEL

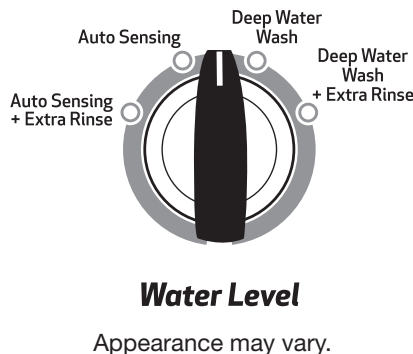

Set the Water Level knob to the Auto Sensing setting and the washer will automatically sense the appropriate water level for the load size and type. Select Extra Rinse for enhanced rinsing performance.

Set the Water Level knob to the Deep Water Wash setting and the washer will fill to the maximum water level. Select Extra Rinse for enhanced rinsing performance.

NOTE: Cycle times will be longer due to extended fill times when using the Deep Water Wash setting.

IMPORTANT: Always select Extra Rinse when manually adding fabric softener. The Extra Rinse option uses additional water and agitation for proper fabric softener distribution.

7. Select WASH TEMPERATURE

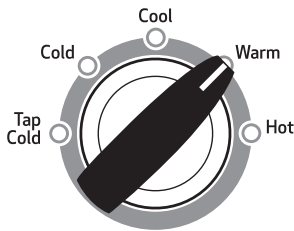

Wash Temperature

All Cold Rinses

Appearance may vary.

Select the wash temperature by turning the Wash Temperature knob to the desired setting. All rinses are tap cold.

NOTE: Always read and follow fabric care label instructions to avoid damage to your items.

Wash Temp	Suggested Fabrics
Hot Some cold water is added to save energy. This may be cooler than your hot water heater setting.	Whites and pastels Durable items Heavy soils
Warm Some cold water may be added, so this will be cooler than what your previous washer provided.	Bright colors Moderate to light soils
Cool Warm water may be added to assist in soil removal and to help dissolve detergents. Cool is slightly warmer than cold.	Colors that bleed or fade Light soils
Cold This is the temperature from your faucet. If your tap cold water is very cold, warm water may be added to assist in soil removal and help dissolve detergent.	Dark colors that bleed or fade Light soils
Tap Cold This is the temperature from your faucet.	Dark colors that bleed or fade Light soils

8. Press START/STOP/PAUSE/ UNLOCK LID to begin wash cycle

Start/Stop
 Pause/Unlock Lid



Hold 3 Sec
 to cancel

Appearance may vary.

Press START/STOP/PAUSE/UNLOCK LID to start the wash cycle. When the cycle has finished, the Cycle Complete indicator will light. Promptly remove items after cycle has completed to avoid odor, reduce wrinkling, and rusting of metal hooks, zippers, and snaps.

Unlocking the lid to add garments

If you need to open the lid to add 1 or 2 missed garments: Press START/STOP/PAUSE/UNLOCK LID; the lid will unlock once the washer movement has stopped. This may take several minutes if the load was spinning at high speed. Then close lid and press START/STOP/PAUSE/UNLOCK LID again to restart the cycle.

NOTE: Washer will not fill with the lid open.

IMPORTANT: If lid is left open for more than 10 minutes, the water will pump out automatically.

Manual soak

If you would like to manually soak your garments at any time during the wash portion of the cycle, press START/STOP/PAUSE/UNLOCK LID and leave the lid closed. Once your desired soak time has elapsed, press START/STOP/PAUSE/UNLOCK LID again to continue the cycle. As long as the lid remains closed, your soak time can be longer than 10 minutes. However, if the lid is opened during the soak and remains open for more than 10 minutes, the water will pump out automatically.

9. Manually add fabric softener

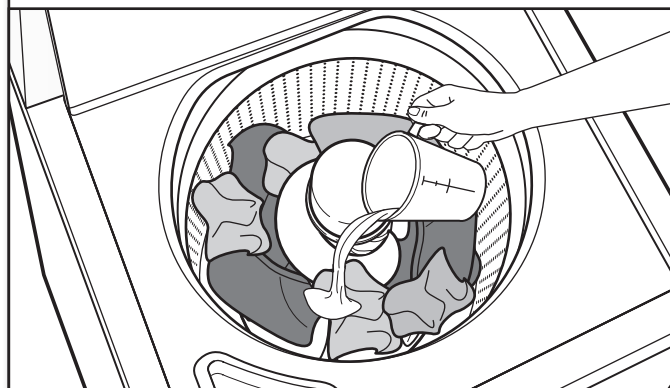

During the final rinse, wait until the washer has completed filling, press START/STOP/PAUSE/UNLOCK LID to pause the washer. Lift the lid and add the measured recommended amount of liquid fabric softener. Do not use more than the recommended amount. Close the lid and press START/STOP/PAUSE/UNLOCK LID again to start the washer.

IMPORTANT: Always select Extra Rinse when manually adding fabric softener. The Extra Rinse option uses additional water and agitation for proper fabric softener distribution.

Washer Maintenance

WATER INLET HOSES

Replace inlet hoses after 5 years of use to reduce the risk of hose failure. Periodically inspect and replace inlet hoses if bulges, kinks, cuts, wear, or leaks are found.

When replacing your inlet hoses, mark the date of replacement on the label with a permanent marker.

NOTE: This washer does not include inlet hoses. See the Installation Instructions for more information.

WASHER CARE

Recommendations to Help Keep Your Washer Clean and Performing at Its Best

1. Always follow the detergent manufacturer's instructions regarding the amount of detergent to use. Never use more than the recommended amount because that may increase the rate at which detergent and soil residue accumulate inside your washer which, in turn, may result in undesirable odor.
2. Use warm and hot wash water settings sometimes (not exclusively cold water washes) because they do a better job of controlling the rate at which soils and detergent accumulate.
3. Always leave the washer lid open between uses to help dry out the washer and prevent the buildup of odor-causing residue.

Cleaning Your Top Loading Washer

Read these instructions completely before beginning the routine cleaning processes recommended below. This Washer Maintenance Procedure should be performed, at a minimum, once per month or every 30 wash cycles, whichever occurs sooner, to control the rate at which soils and detergent may otherwise accumulate in your washer.

Cleaning the Inside of the Washer

To keep your washer odor-free, follow the usage instructions provided above and use this recommended monthly cleaning procedure:

Recommended Cycle for Cleaning the Washer

Refer to the "Cycle Guide" for the optimal cycle for cleaning the inside of the washer. Use this cycle with affresh® Washer Cleaner or liquid chlorine bleach as described below.

Begin procedure

1. affresh® Washer Cleaner Cycle Procedure (Recommended for Best Performance):

- a. Open the washer lid and remove any clothing or items.
- b. Place an affresh® Washer Cleaner tablet in the bottom of the washer basket.
- c. Do not place an affresh® Washer Cleaner tablet in the detergent dispenser.
- d. Do not add any detergent or other chemical to the washer when following this procedure.
- e. Close the washer lid.
- f. Select the cycle recommended for cleaning the inside of the washer.
- g. Press START/STOP/PAUSE/UNLOCK LID to start the cycle.

NOTE: For best results, do not interrupt cycle. If cycle must be interrupted, press START/STOP/PAUSE/UNLOCK LID once. After the cycle has stopped, run a Rinse & Spin cycle to rinse cleaner from washer.

WASHER CARE (cont.)

2. Chlorine Bleach Procedure (Alternative):

- a. Open the washer lid and remove any clothing or items.
- b. Add 1 cup (236 mL) of liquid chlorine bleach to the bleach compartment.

NOTE: Use of more liquid chlorine bleach than is recommended above could cause washer damage over time.

- c. Close the washer lid.
- d. Do not add any detergent or other chemical to the washer when following this procedure.
- e. Select the cycle recommended for cleaning the inside of the washer.
- f. Press START/STOP/PAUSE/UNLOCK LID to start the cycle.

NOTE: For best results, do not interrupt cycle. If cycle must be interrupted, press START/STOP/PAUSE/UNLOCK LID once. After the cycle has stopped, run a Rinse & Spin cycle to rinse cleaner from washer.

Cleaning the Dispensers

After a period of using your washer, you may find some residue buildup in the washer's dispensers. To remove residue from the dispensers, wipe them with a damp cloth and towel dry. Do not attempt to remove the dispensers or trim for cleaning. The dispensers and trim are not removable. If your model has a dispenser drawer, however, remove the drawer and clean it before or after you run the Clean Washer cycle. Use an all-purpose surface cleaner, if needed.

Cleaning the Outside of the Washer

Use a soft, damp cloth or sponge to wipe away any spills. Use only mild soaps or cleaners when cleaning external washer surfaces.

IMPORTANT: To avoid damaging the washer's finish, do not use abrasive products.

NON-USE AND VACATION CARE

Operate your washer only when you are home. If moving or not using your washer for a period of time, follow these steps:

1. Unplug or disconnect power to washer.
2. Turn off water supply to washer to avoid flooding due to water pressure surge.

WINTER STORAGE CARE

IMPORTANT: To avoid damage, install and store washer where it will not freeze. Because some water may stay in hoses, freezing can damage washer. If storing or moving during freezing weather, winterize your washer.

To winterize washer:

1. Shut off both water faucets; disconnect and drain water inlet hoses.
2. Put 1 qt. (1 L) of R.V.-type antifreeze in basket and run washer on Rinse & Spin cycle for about 30 seconds to mix antifreeze and remaining water.
3. Unplug washer or disconnect power.

TRANSPORTING YOUR WASHER

1. Shut off both water faucets. Disconnect and drain water inlet hoses.
2. If washer will be moved during freezing weather, follow "Winter Storage Care" directions before moving.
3. Disconnect drain hose from drain system and drain any remaining water into a pan or bucket. Disconnect drain hose from back of washer.
4. Unplug power cord.
5. Place inlet hoses and drain hose inside washer basket.
6. Drape power cord over edge and into washer basket.
7. Place packing tray from original shipping materials back inside washer. If you do not have packing tray, place heavy blankets or towels into basket opening. Close lid and place tape over lid and down front of washer. Keep lid taped until washer is placed in new location. Transport washer in upright position.

⚠ WARNING



Electrical Shock Hazard

Plug into a grounded 3 prong outlet.

Do not remove ground prong.

Do not use an adapter.

Do not use an extension cord.

Failure to follow these instructions can result in death, fire, or electrical shock.

REINSTALLING/USING WASHER AGAIN

To reinstall washer after non-use, vacation, winter storage, or moving:

1. Refer to the Installation Instructions to locate, level, and connect washer.
2. Before using again, run washer through the following recommended procedure:

To use washer again:

1. Flush water pipes and hoses. Reconnect water inlet hoses. Turn on both water faucets.
2. Plug in washer or reconnect power.
3. Run washer through Bulky Items & Sheets cycle to clean washer and remove antifreeze, if used. Use only HE High Efficiency detergent. Use 1/2 the manufacturer's recommended amount for a medium-size load.

Troubleshooting

First try the solutions suggested here to possibly avoid a service call.

If you experience	Possible Causes	Solution
Vibration or Off-Balance		
Check the following for proper installation or see "Using Your Washer" section.	Feet may not be in contact with the floor and locked.	Front and rear feet must be in firm contact with floor, and washer must be level to operate properly.
	Washer may not be level.	Check floor for flexing or sagging. If flooring is uneven, a 3/4" (19 mm) piece of plywood under your washer will reduce sound. See "Level the Washer" in Installation Instructions.
	Load could be unbalanced.	Load dry items in loose heaps evenly around basket wall. Adding wet items to washer or adding more water to basket could unbalance washer.
		Wash smaller loads to reduce imbalance.
		Do not tightly pack. Avoid washing single items.
		Use Bulky Items & Sheets cycle for oversized, non-absorbent items such as jackets and small comforters. See "Cycle Guide."
		See "Cycle Guide" and "Using Your Washer" in this Use and Care Guide.
Noises		
Clicking or metallic noises	Objects caught in washer drain system.	Empty pockets before washing. Loose items such as coins could fall between basket and tub or may block pump. It may be necessary to call for service to remove items. It is normal to hear metal items on clothing such as metal snaps, buckles, or zippers touch against the basket.
Gurgling or humming	Washer may be draining water.	It is normal to hear the pump making a continuous humming sound with periodic gurgling or surging as final amounts of water are removed during the Drain & Spin cycle.
Humming	Load sensing may be occurring.	You may hear the hum of the sensing spins after you have started the washer. This is normal.
Water Leaks		
Check the following for proper installation:	Washer not level.	Water may splash off basket if washer is not level. Check that load is not unbalanced or tightly packed.
	Fill hoses not attached tightly.	Tighten fill-hose connection.
	Fill hose washers.	Make sure all four fill hose flat washers are properly seated.
	Drain hose connection.	Pull drain hose from washer cabinet and properly secure it to drainpipe or laundry tub.
	Check household plumbing for leaks or clogged sink or drain.	Water can back up out of a clogged sink or drainpipe. Check all household plumbing for leaks (laundry tubs, drain pipe, water pipes, and faucets).
	Washer not loaded as recommended.	Improper loading can cause basket to be out of alignment and cause water to splash off tub. See "Using Your Washer" for loading instructions.
Washer not performing as expected		
Not enough water in washer	Load not completely covered in water.	This is normal operation for an HE low-water washer. If the Water Level knob is set to the Auto Sensing setting, the load will not be completely under water. The washer senses load sizes and adds the correct amount of water for optimal cleaning. IMPORTANT: Do not add more water to washer. Adding water lifts the items off the washplate, resulting in less effective cleaning.
		Use the Bulky Items & Sheets cycle or set the Water Level knob to the Deep Water Wash setting. See "What's New under the Lid" and "Cycle Guide" to match your load with the best cycle.
		Run Clean Washer with affresh® cycle to optimize the water level and wash performance due to soil buildup in washer basket.

Troubleshooting

First try the solutions suggested here to possibly avoid a service call.

If you experience	Possible Causes	Solution
Washer not performing as expected (cont.)		
Washer won't run or fill, washer stops working, or wash light remains on (indicating that the washer was unable to fill appropriately)	Check for proper water supply.	Both hoses must be attached and have water flowing to inlet valve.
		Both hot and cold water faucets must be turned on.
		Check that inlet valve screens have not become clogged.
		Check for any kinks in inlet hoses, which can restrict water flow.

⚠ WARNING



Electrical Shock Hazard

Plug into a grounded 3 prong outlet.

Do not remove ground prong.

Do not use an adapter.

Do not use an extension cord.

Failure to follow these instructions can result in death, fire, or electrical shock.

Washer won't run or fill, washer stops working, or wash light remains on (indicating that the washer was unable to fill appropriately) (cont.)	Check proper electrical supply.	Plug power cord into a grounded 3 prong outlet.
		Do not use an extension cord.
		Ensure there is power to outlet.
		Reset a tripped circuit breaker. Replace any blown fuses. NOTE: If problems continue, contact an electrician.
	Normal washer operation.	Lid must be closed for washer to run.
		Washer will pause during certain phases of cycle. Do not interrupt cycle.
Washer may be tightly packed.	Remove several items, rearrange load evenly in basket. Close lid and press START/STOP/PAUSE/UNLOCK LID.	
	Do not add more than 1 or 2 additional items after cycle has started to avoid tightly packing or unbalancing.	
	Do not add more water to the washer.	
Washer not draining/spinning, loads are still wet, or spin light remains on (indicating that the washer was unable to pump out water within 10 minutes)	Small items may have been caught in pump or between basket and tub, which can slow draining.	Empty pockets and use garment bags for small items.
	Use a cycle with a low spin speed.	Cycles with lower spin speeds remove less water than cycles with high spin speeds. Use the recommended cycle/spin speed for your garment. To remove extra water in the load, select Drain & Spin. Load may need to be rearranged to allow even distribution of the load in the basket.
	The washer may be tightly packed or unbalanced.	Tightly packed or unbalanced loads may not allow the washer to spin correctly, leaving the load wetter than normal. Evenly arrange the wet load for balanced spinning. Select the Drain & Spin cycle to remove excess water. See "Using Your Washer" for loading recommendations.
	Check plumbing for correct drain hose installation. Drain hose extends into standpipe farther than 4.5" (114 mm).	Check drain hose for proper installation. Use drain hose form and securely attach to drainpipe or tub. Do not tape over drain opening. Lower drain hose if the end is higher than 96" (2.4 m) above the floor. Remove any clogs from drain hose.
	Too much detergent causing suds to slow or stop draining and spinning.	Always measure and follow detergent directions for your load. To remove extra suds, select Rinse & Spin. Do not add detergent.

Troubleshooting

First try the solutions suggested here to possibly avoid a service call.

If you experience	Possible Causes	Solution
Washer not performing as expected (cont.)		
Dry spots on load after cycle	High-speed spins extract more moisture than your previous washer.	The high spin speeds combined with airflow during the final spin can cause items near the top of the load to develop dry spots during the final spin. This is normal.
	Washer may be tightly packed.	Use the Bulky Items & Sheets cycle or set the Water Level knob to the Deep Water Wash setting. See “Cycle Guide” to match your load with the best cycle.
	Added extra garments to the load after the sensing/fill phase.	Add only 1 or 2 additional garments after washer has started.
Incorrect or wrong wash or rinse temperatures	Check for proper water supply.	Make sure hot and cold inlet hoses are not reversed.
		Both hoses must be attached to both washer and faucet, and have both hot and cold water flowing to inlet valve.
		Check that inlet valve screens are not clogged.
		Remove any kinks in hoses.
Energy-saving controlled wash temperatures.	This washer uses cooler wash and rinse water temperatures than your previous washer. This includes cooler hot and warm washes.	
Load not rinsed	Check for proper water supply.	Make sure hot and cold inlet hoses are not reversed.
		Both hoses must be attached and have water flowing to the inlet valve.
		Both hot and cold water faucets must be on.
		Inlet valve screens on washer may be clogged.
		Remove any kinks in the inlet hose.
	Not using HE detergent or using too much HE detergent.	The suds from too much detergent can keep washer from operating correctly. Always measure detergent and follow detergent directions based on load size and soil level.
	Washer not loaded as recommended.	The washer is less efficient at rinsing when tightly packed.
		Load garments in loose heaps evenly around the basket wall. Load with dry items only.
		Use cycle designed for the fabrics being washed.
		Add only 1 or 2 additional garments after washer has started.
Use the Bulky Items & Sheets cycle or set the Water Level knob to the Deep Water Wash setting. See “Cycle Guide” to match your load with the best cycle.		
Sand, pet hair, lint, etc., on load after washing	Heavy sand, pet hair, lint, and detergent or bleach residues may require additional rinsing.	Select Rinse & Spin.
Load is tangling	Washer not loaded as recommended.	See “Using Your Washer” section.
		Select a cycle with a slower wash action and spin speed; however, items will be wetter than those using a higher speed spin. Use the Bulky Items & Sheets cycle or set the Water Level knob to the Deep Water Wash setting. See the “Cycle Guide” to match your load with the best cycle.
		Load garments in loose heaps evenly around the basket wall.
		Reduce tangling by mixing types of load items. Use the recommended cycle for the type of garments being washed.

Troubleshooting

First try the solutions suggested here to possibly avoid a service call.

If you experience	Possible Causes	Solution
Washer not performing as expected (cont.)		
Not cleaning or removing stains	Added more water to washer.	Washer senses load size and adds correct amount of water. This is normal and necessary for clothes to move. It is normal for the wash load to be not completely covered in water. Added water lifts the laundry off the washplate, resulting in less effective cleaning.
	Washer not loaded as recommended.	Washer is less efficient at cleaning when load is tightly packed.
		Load garments in loose heaps evenly around the basket wall. Load with dry items only.
		Add only 1 or 2 additional garments after washer has started.
	Adding detergent on top of load.	Add detergent, oxi products, and color-safe bleach to the bottom of the basket before adding the load items.
	Not using HE detergent or using too much HE detergent.	The suds from regular detergent can keep washer from operating correctly.
		Use only HE detergent. Be sure to measure correctly.
		Always measure detergent and follow manufacturer's directions based on load size and soil level.
	Not using correct cycle for fabric type.	Use a higher soil level cycle option and warmer wash temperature to improve cleaning.
		Use Heavy cycle for tough cleaning. See the "Cycle Guide" to match your load with the best cycle.
Not using dispenser.	Use dispenser to avoid chlorine bleach staining.	
	Load dispenser before starting a cycle.	
	Avoid overfilling.	
	Do not add chlorine bleach directly onto load.	
Not washing like colors together.	Wash like colors together and remove promptly after the cycle is complete to avoid dye transfer.	
Not selecting Extra Rinse when using fabric softener.	Always select Extra Rinse when using fabric softener. Cycles that have a spray rinse require this option for proper fabric softener distribution.	
Incorrect dispenser operation	Clogged dispenser.	Load dispenser before starting a cycle.
		Use only liquid chlorine bleach in the bleach dispenser.
Fabric damage	Sharp items were in pockets during wash cycle.	Empty pockets, zip zippers, and snap or hook fasteners before washing to avoid snags and tears.
	Strings and straps could have tangled.	Tie all strings and straps before starting wash load.
	Items may have been damaged before washing.	Mend rips and broken threads in seams before washing.
	Fabric damage can occur if load is tightly packed.	Load garments in loose heaps evenly around the basket wall. Load with dry items only.
		Use cycle designed for the fabrics being washed.
		Use the Bulky Items & Sheets cycle or set the Water Level knob to the Deep Water Wash setting. See "What's New under the Lid" and "Cycle Guide" to match your load with the best cycle.
		Add only 1 or 2 additional garments after washer has started.
	Liquid chlorine bleach may have been added incorrectly.	Do not pour liquid chlorine bleach directly onto load. Wipe up bleach spills.
		Undiluted bleach will damage fabrics. Do not use more than recommended by manufacturer.
		Do not place load items on top of bleach dispenser when loading and unloading washer.
Garment care instructions may not have been followed.	Always read and follow garment manufacturer's care label instructions. See the "Cycle Guide" to match your load with the best cycle.	

Troubleshooting

First try the solutions suggested here to possibly avoid a service call.

If you experience	Possible Causes	Solution
Washer not performing as expected (cont.)		
Odors	Monthly maintenance not done as recommended.	See “Washer Care” in “Washer Maintenance.” Unload washer as soon as cycle is complete.
	Using too much detergent.	Be sure to measure correctly. Always follow the manufacturer’s directions. See “Washer Care” section.
Lid Locked light is flashing	The lid is not closed.	Close the lid. The washer will not start or fill with the lid open.
	A cycle was stopped or paused using START/STOP/PAUSE/UNLOCK LID.	The washer may still be spinning. The lid will not unlock until the basket has stopped spinning. This may take several minutes if washing large loads or heavy fabrics.
Single-dose laundry packet not dissolving	Adding laundry packet incorrectly.	Be sure laundry packet is added to washer basket before adding clothes. Do not add packet to dispenser. Follow the manufacturer’s instructions to avoid damage to your garments.
Washer pumps out water before finishing cycle	Lid is left open for more than 10 minutes.	Make sure lid is closed before starting a cycle and/or during prewash (soak).

WHIRLPOOL CORPORATION LAUNDRY WARRANTY

LIMITED WARRANTY

For one year from the date of purchase, when this major appliance is installed, operated, and maintained according to instructions attached to or furnished with the product, Amana, Admiral, Estate, Inglis, or Roper brands of Whirlpool Corporation or Whirlpool Canada LP (hereafter "Whirlpool") will pay for Factory Specified Replacement Parts and repair labor to correct defects in materials or workmanship that existed when this major appliance was purchased.

YOUR SOLE AND EXCLUSIVE REMEDY UNDER THIS LIMITED WARRANTY SHALL BE PRODUCT REPAIR AS PROVIDED HEREIN. Service must be provided by a company designated by Whirlpool to service Amana, Admiral, Estate, Inglis, or Roper brand appliances. This limited warranty is valid only in the United States or Canada and applies only when the major appliance is used in the country in which it was purchased. This limited warranty is effective from the date of original consumer purchase. Proof of original purchase date is required to obtain service under this limited warranty.

ITEMS EXCLUDED FROM WARRANTY

This limited warranty does not cover:

1. Replacement parts or repair labor if this major appliance is used for other than normal, single-family household use or when it is used in a manner that is inconsistent to published user or operator instructions and/or installation instructions.
2. Service calls to correct the installation of your major appliance, to instruct you on how to use your major appliance, to replace or repair house fuses, or to correct house wiring or plumbing.
3. Service calls to repair or replace appliance light bulbs, air filters, or water filters. Consumable parts are excluded from warranty coverage.
4. Damage resulting from accident, alteration, misuse, abuse, fire, flood, acts of God, improper installation, installation not in accordance with electrical or plumbing codes, or use of products not approved by Whirlpool.
5. Cosmetic damage, including scratches, dents, chips or other damage to the finish of your major appliance, unless such damage results from defects in materials or workmanship and is reported to Whirlpool within 30 days from the date of purchase.
6. Pick up and delivery. This major appliance is intended to be repaired in your home.
7. Repairs to parts or systems resulting from unauthorized modifications made to the appliance.
8. Expenses for travel and transportation for product service if your major appliance is located in a remote area where service by an authorized company designated by Whirlpool to service Amana, Admiral, Estate, Inglis, or Roper brands is not available.
9. The removal and reinstallation of your major appliance if it is installed in an inaccessible location or is not installed in accordance with Whirlpool's published installation instructions.
10. Replacement parts or repair labor on major appliances with original model/serial numbers that have been removed, altered, or cannot be easily determined.

The cost of repair or replacement under these excluded circumstances shall be borne by the customer.

DISCLAIMER OF IMPLIED WARRANTIES

IMPLIED WARRANTIES, INCLUDING ANY IMPLIED WARRANTY OF MERCHANTABILITY OR IMPLIED WARRANTY OF FITNESS FOR A PARTICULAR PURPOSE, ARE LIMITED TO ONE YEAR OR THE SHORTEST PERIOD ALLOWED BY LAW. Some states and provinces do not allow limitations on the duration of implied warranties of merchantability or fitness, so this limitation may not apply to you. This warranty gives you specific legal rights, and you also may have other rights that vary from state to state or province to province.

DISCLAIMER OF REPRESENTATIONS OUTSIDE OF WARRANTY

Whirlpool makes no representations about the quality, durability, or need for service or repair of this major appliance other than the representations contained in this Warranty. If you want a longer or more comprehensive warranty than the limited warranty that comes with this major appliance, you should ask Whirlpool or your retailer about buying an extended warranty.

LIMITATION OF REMEDIES; EXCLUSION OF INCIDENTAL AND CONSEQUENTIAL DAMAGES

YOUR SOLE AND EXCLUSIVE REMEDY UNDER THIS LIMITED WARRANTY SHALL BE PRODUCT REPAIR AS PROVIDED HEREIN. WHIRLPOOL SHALL NOT BE LIABLE FOR INCIDENTAL OR CONSEQUENTIAL DAMAGES. Some states and provinces do not allow the exclusion or limitation of incidental or consequential damages, so these limitations and exclusions may not apply to you. This warranty gives you specific legal rights, and you also may have other rights that vary from state to state or province to province.

If outside the 50 United States and Canada, contact your authorized Whirlpool, Amana, Admiral, Estate, Inglis, or Roper dealer to determine if another warranty applies.

If you think you need repair service, first see the "Troubleshooting" section of the Use & Care Guide. If you are unable to resolve the problem after checking "Troubleshooting," additional help can be found by checking the "Assistance or Service" section or by calling the following numbers for assistance: In the U.S.A., call **800-843-0304** for Amana brand products; **800-688-9920** for Admiral brand products; **800-253-1301** for Estate brand products, or **800-447-6737** for Roper brand products. For assistance In Canada, call: **800-807-6777** for Amana, Admiral, Estate, Inglis, or Roper brand products.

1/12

Keep this book and your sales slip together for future reference. You must provide proof of purchase or installation date for in-warranty service.

Write down the following information about your major appliance to better help you obtain assistance or service if you ever need it. You will need to know your complete model number and serial number. You can find this information on the model and serial number label located on the product.

Dealer name _____
Address _____
Phone number _____
Model number _____
Serial number _____
Purchase date _____

ASSISTANCE OR SERVICE

Before calling for assistance or service, please check "Troubleshooting" or visit www.whirlpool.com/product_help. It may save you the cost of a service call. If you still need help, follow the instructions below.

When calling, please know the purchase date and the complete model and serial number of your appliance. This information will help us to better respond to your request.

If you need replacement parts or to order accessories

We recommend that you use only FSP® Factory Specified Parts. These parts will fit right and work right because they are made with the same precision used to build every new Amana, Admiral, Estate, Inglis, or Roper brands of Whirlpool Corporation or Whirlpool Canada LP appliance.

To locate FSP® replacement parts, assistance in your area, or accessories:

Whirlpool Corporation Customer eXperience Center
**800-843-0304 for Amana, 800-688-9920 for Admiral,
800-253-1301 for Estate, or 800-447-6737 for Roper**
800-442-9991 (Accessories)
www.whirlpool.com/accessories

Whirlpool Canada LP
Customer eXperience Centre
**800-807-6777 for
Amana, Admiral, Estate, Inglis, & Roper**
www.whirlpoolappliances.ca

or call your nearest designated service center or refer to your Yellow Pages telephone directory.

Our consultants provide assistance with

In the U.S.A.

- Features and specifications on our full line of appliances.
- Installation information.
- Specialized customer assistance (Spanish speaking, hearing impaired, limited vision, etc.).

In the U.S.A. and Canada

- Use and maintenance procedures.
- Accessory and repair parts sales.
- Referrals to local dealers, repair parts distributors, and service companies. Whirlpool designated service technicians are trained to fulfill the product warranty and provide after-warranty service, anywhere in the United States and Canada.

You can write with any questions or concerns at:

Whirlpool Corporation
Customer eXperience Center
553 Benson Road
Benton Harbor, MI 49022-2692

Customer eXperience Centre
Whirlpool Canada LP
Unit 200-6750 Century Ave
Mississauga, Ontario L5N 0B7

Please include a daytime phone number in your correspondence.

ASSISTANCE OU SERVICE

Avant de faire un appel pour assistance ou service, veuillez vérifier la section "Dépannage" ou consulter www.whirlpool.com/product_help. Cette vérification peut vous faire économiser le coût d'une visite de réparation. Si vous avez encore besoin d'aide, suivre les instructions ci-dessous.

Lors d'un appel, veuillez connaître la date d'achat et les numéros au complet de modèle et de série de votre appareil. Ces renseignements nous aideront à mieux répondre à votre demande.

Si vous avez besoin de pièces de rechange ou pour commander des accessoires

Si vous avez besoin de commander des pièces de rechange ou des accessoires, nous vous recommandons d'utiliser seulement des pièces FSP® spécifiées par l'usine. Ces pièces conviendront et fonctionneront bien parce qu'elles sont fabriquées avec la même précision que celle utilisée dans la fabrication de chaque nouvel appareil de marque Amana, Admiral, Estate, Inglis, ou Roper de Whirlpool Corporation ou Whirlpool Canada LP. Pour localiser des pièces de rechange FSP® ou des accessoires ou pour obtenir de l'aide dans votre région :

Pour trouver des pièces de rechange FSP®, de l'aide ou des accessoires dans votre région :

Whirlpool Canada LP Centre pour l'eXpérience de la clientèle **800-807-6777** www.whirlpoolappliances.ca
ou contacter votre centre de réparation désigné le plus proche, ou encore consulter les Pages Jaunes.

Nos consultants fournissent

l'assistance pour :

- Procédés d'utilisation et d'entretien.
- Vente d'accessoires et de pièces de rechange.
- Les références aux concessionnaires, compagnies de service de réparation et distributeurs de pièces de rechange locaux. Les techniciens de service désignés par Whirlpool sont formés pour remplir la garantie des produits et fournir un service après la garantie, partout au Canada.

Pour plus d'assistance

Vous pouvez nous soumettre toute question ou problème en écrivant à l'adresse ci-dessous :

Centre pour l'eXpérience de la clientèle
Whirlpool Canada LP
Unit 200-6750 Century Ave
Mississauga, Ontario L5N 0B7

Dans votre correspondance, veuillez indiquer un numéro de téléphone où on peut vous joindre dans la journée.