

36" (91.4 cm), 42" (106.7 cm), 48" (121.9 cm)
SIDE-BY-SIDE
BUILT-IN REFRIGERATORS
with WATER FILTRATION

**USE &
CARE
GUIDE**



KitchenAid[®]
FOR THE WAY IT'S MADE[®]

TABLE OF CONTENTS

	Page		Page
A Note to You	2	Automatic ice maker	11
Refrigerator Safety	3	Solving common ice maker problems	11
Proper disposal of your old refrigerator	3	Removing the ice maker storage bin	12
Parts and Features	4	Ice and cold water dispensers	13
Using Your Refrigerator	5	Water Filtration and Monitoring System	15
Removing the upper ventilation panel	5	Base grille	16
Using the Power On/Off Switch	5	Defrost pan	17
ExtendFresh* Temperature Management System	6	Light bulbs	17
Setting temperature controls	6	Understanding the sounds you may hear	18
Refrigerator features	7	Saving energy	18
Utility compartment	7	Caring for Your Refrigerator	19
Door bins	7	Cleaning your refrigerator	19
SpillClean* glass refrigerator shelves	7	Vacation and moving care	20
FreshChill* Meat Locker	8	Power Interruptions	20
Humidity-controlled ClearVue* crispers	9	Food Storage Guide	21
Covered egg container	10	Storing fresh food	21
Wine rack	10	Storing frozen food	22
Freezer features	10	Troubleshooting Guide	23
Freezer shelves	10	Requesting Assistance or Service	28
Pull-out freezer baskets	10	Warranty	30

A NOTE TO YOU

Thank you for buying a KitchenAid® appliance.

KitchenAid designs the best tools for the most important room in your house. To ensure that you enjoy years of trouble-free operation, we developed this Use and Care Guide. It contains valuable information about how to operate and maintain your appliance properly and safely. Please read it carefully.

Also, please complete and mail the **Product Registration Card** provided with your appliance. The card helps us notify you about any new information for your appliance.

Record your model's information.

Write down the following information about your refrigerator to better help you obtain assistance or service if you ever need it. You will need to know your complete model number and serial number. You can find this information on the model and serial number label/plate.

If you need assistance or service, first see the "Troubleshooting" section of this book. After checking "Troubleshooting," additional help can be found by checking the "Requesting Assistance or Service" section.

Dealer name

Address

Phone number

Model number

Serial number

Purchase date

(See the "Parts and Features" section for model and serial number label/plate location.)

Keep this book and your sales slip together for future reference.

REFRIGERATOR SAFETY

Your safety and the safety of others is very important.

We have provided many important safety messages in this manual and on your appliance. Always read and obey all safety messages.



This is the safety alert symbol. This symbol alerts you to potential hazards that can kill or hurt you and others. All safety messages follow the safety alert symbol and either the word "DANGER" or "WARNING". These words mean:

⚠ DANGER

You can be killed or seriously injured if you don't immediately follow instructions.

⚠ WARNING

You can be killed or seriously injured if you don't follow instructions.

All safety messages will tell you what the potential hazard is, tell you how to reduce the chance of injury, and tell you what can happen if the instructions are not followed.

IMPORTANT SAFETY INSTRUCTIONS

WARNING: To reduce the risk of fire, electric shock, or injury when using your refrigerator, follow these basic precautions:

- Plug into grounded 3 prong outlet.
- Do not remove ground prong.
- Do not use an adapter.
- Do not use an extension cord.
- Disconnect power before servicing.
- Remove doors from your old refrigerator.
- Use nonflammable cleaner only.
- Do not install the refrigerator near an oven, radiator, or other heat source.
- Keep flammable materials and vapors, such as gasoline, away from refrigerator.
- Use two or more people to move or install refrigerator.
- Unplug refrigerator before installing ice maker.
- Use a sturdy glass when dispensing ice or water (on some models).

– SAVE THESE INSTRUCTIONS –

Proper disposal of your old refrigerator

⚠ WARNING

Suffocation Hazard

**Remove doors from your old refrigerator.
Failure to do so can result in death or brain damage.**

IMPORTANT: Child entrapment and suffocation are not problems of the past. Junked or abandoned refrigerators are still dangerous... even if they will sit for "just a few days." If you are getting rid of your old refrigerator, please follow the instructions below to help prevent accidents.

BEFORE YOU THROW AWAY YOUR OLD REFRIGERATOR OR FREEZER:

- Take off the doors.
- Leave the shelves in place so that children may not easily climb inside.

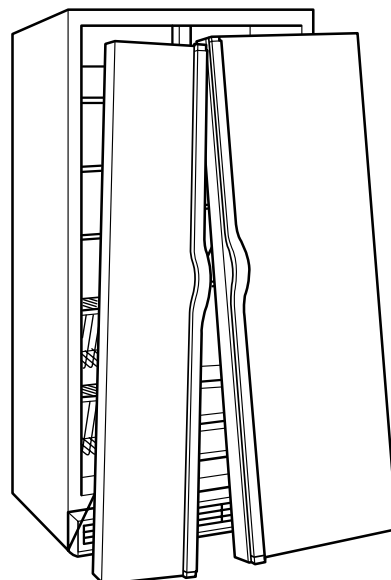

PARTS AND FEATURES

This section contains an illustration of your refrigerator. Use it to become more familiar with the parts and features. Page references are included for your convenience.

NOTE: This manual covers several different models. The refrigerator you have purchased may have some or all of the parts and features listed below.

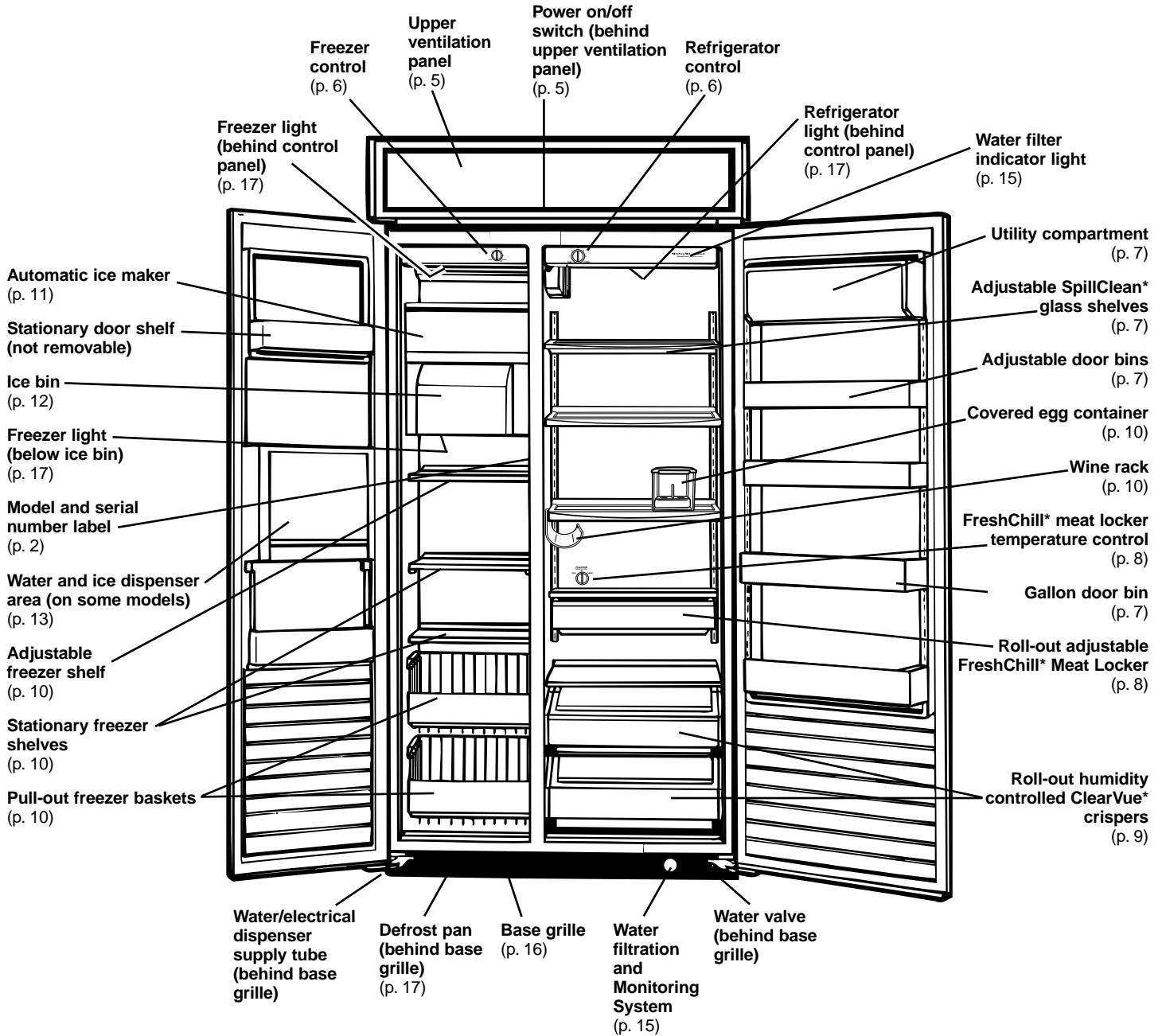

USING YOUR REFRIGERATOR

To obtain the best possible results from your refrigerator, it is important that you operate it properly. This section tells

you how to set the controls, remove and adjust the features in your refrigerator, and how to save energy.

⚠ WARNING



Electrical Shock Hazard

- Plug into a grounded 3 prong outlet.
- Do not remove ground prong.
- Do not use an adapter.
- Do not use an extension cord.
- Failure to follow these instructions can result in death, fire, or electrical shock.

⚠ WARNING



Explosion Hazard

- Keep flammable materials and vapors, such as gasoline, away from refrigerator.
- Failure to do so can result in death, explosion, or fire.

Removing the upper ventilation panel

Panel models —

To remove:

1. Grasp both ends of the panel.
2. Push straight up, then pull straight out.

To replace:

1. Insert hooks (located on back of ventilation panel) into bracket slots.
2. Pull panel down slightly to lock into place.

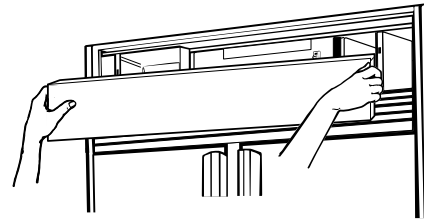

Wraparound metal door models —

KSSC36F, KSSC42F, KSSC48F

To remove:

1. Grasp both ends of the louver panel.
2. Push straight up, then pull straight out.

To replace:

1. Insert hooks (located on back of louver panel) into slots on side trim.
2. Pull louver panel down slightly to lock into place.

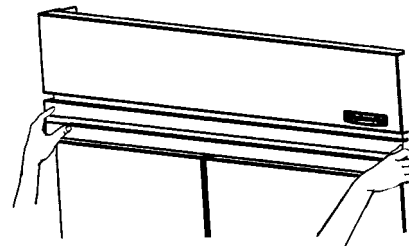

Using the Power On/Off Switch

The Power On/Off Switch is located behind the upper ventilation panel. It is used to turn the power to the refrigerator off when cleaning it or changing light bulbs.

To turn power off:

1. Remove upper ventilation panel from panel models.
Remove lower panel from wrap-around stainless steel models.
2. Press Power On/Off Switch to “OFF” position.

To turn power on:

1. Press Power On/Off Switch to “ON” position.
2. Replace upper ventilation panel or lower panel.

IMPORTANT: Be sure the Power On/Off Switch is in the “ON” position after cleaning refrigerator or changing light bulbs.

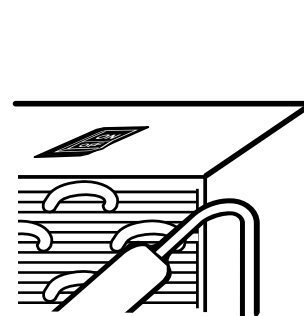

EXTENDFRESH™ Temperature Management System

The ExtendFresh Temperature Management System controls the temperature in both the refrigerator compartment and the freezer compartment independently. The system helps extend the freshness of the food in your refrigerator by responding to temperature changes as small as 1°F. Unlike most refrigerators on the market today, the ExtendFresh System uses a Smart* Fan to transfer cold air immediately from the freezer to the refrigerator for faster response to temperature changes without the need for the compressor to turn on. Also, the system maintains consistent temperatures, which are less affected by external temperature changes such as seasonal changes and programmable home thermostats or even the temperature of other compartments inside the refrigerator.

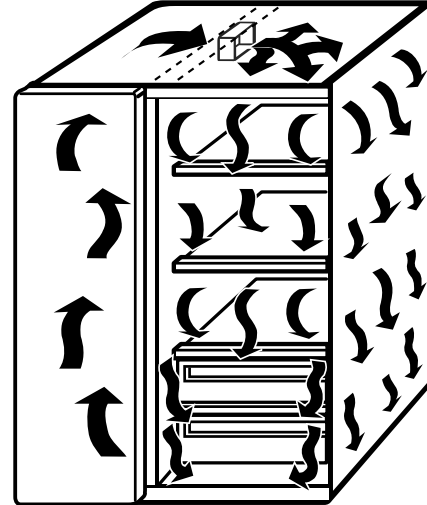

Setting temperature Controls

The Refrigerator and the Freezer Controls have been preset at the factory. These settings should be correct for normal household refrigerator use. Let the refrigerator operate for 24 hours to cool both sections before changing settings.

To change a temperature setting:

Adjust the Refrigerator and/or Freezer Control.

- To make the refrigerator or freezer colder, turn the control knob clockwise.
- To make the refrigerator or freezer less cold, turn the control knob counterclockwise.

IMPORTANT: The **OFF** setting on the Freezer Control stops all cooling action in the refrigerator, but it does not disconnect the refrigerator from the power supply.

If possible, wait to add food until after this 24-hour period. Turning the controls to higher number settings will not cool the sections faster. Adding foods before the refrigerator has cooled completely could cause the refrigerator to take longer to reach the desired temperatures and cause some foods to spoil.

After 24 hours, adjust the controls, one number at a time as desired. "1" is the warmest setting and "5" is the coldest. Allow the refrigerator to operate for 24 hours after each control change.

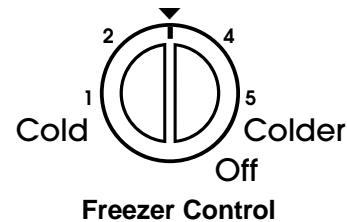
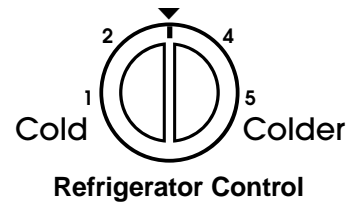

Refrigerator features

Utility compartment

The utility compartment can be placed in any position on the refrigerator door.

To remove:

1. Grasp both ends of compartment.
2. Lift compartment up and pull out.

To replace:

1. Insert compartment hooks into ladder slots on both sides of refrigerator door.
2. Push compartment down to lock into place.

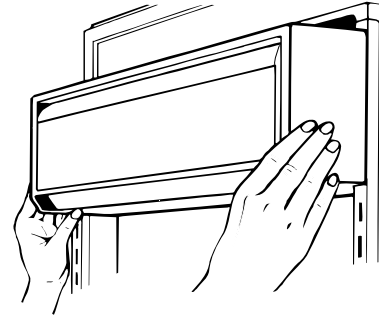

Door bins

Door bins hold two-liter bottles and can be placed in any position on the refrigerator door.

To remove:

1. Grasp door bin.
2. Lift door bin up and pull out.

To replace:

1. Insert door bin hooks into ladder slots on both sides of refrigerator door.
2. Push door bin down to lock into place.

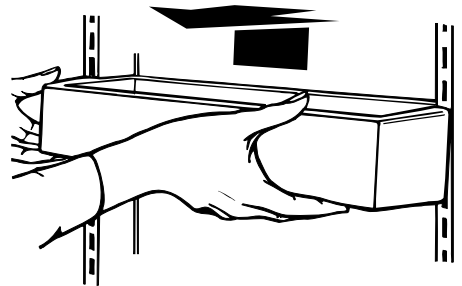

Gallon Door Bin

The gallon door bin holds several gallon-sized containers and can be placed in any position on the refrigerator door.

Note: Positioning the gallon door bin directly across from an interior shelf or covered storage bin will prevent the refrigerator door from closing and could cause damage to bins and shelves.

To install:

1. Insert the attachment brackets into the adjustment slots on the door.
2. Push down on the bin to secure tabs.
3. If necessary, adjust interior shelves to allow for milk jugs and tall beverage containers stored in the gallon door bin.

AVOID

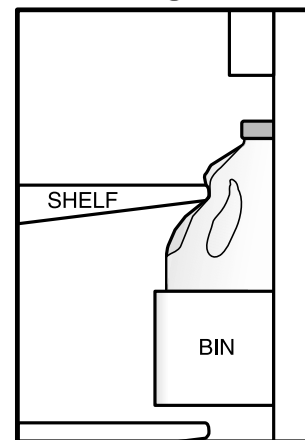

SpillClean™ glass refrigerator shelves

Adjust the shelves to match the way you use your refrigerator.

IMPORTANT: Do not clean glass shelves with warm water when they are cold. Shelves may break if exposed to sudden temperature changes or impact. For your protection, tempered glass is designed to shatter into many small pebble-sized pieces. This is normal.

To remove:

1. Tilt shelf up at front and lift shelf up at back.
2. Pull shelf straight out.

IMPORTANT: Glass shelves are heavy. Handle them carefully.

To replace:

1. Guide the rear shelf hooks into slots in the shelf supports on the back of the refrigerator wall.
2. Tilt shelf up at front until hooks drop into slots. Lower front of shelf to level position.
3. Check the stability of the shelf to be sure hooks have been inserted properly.

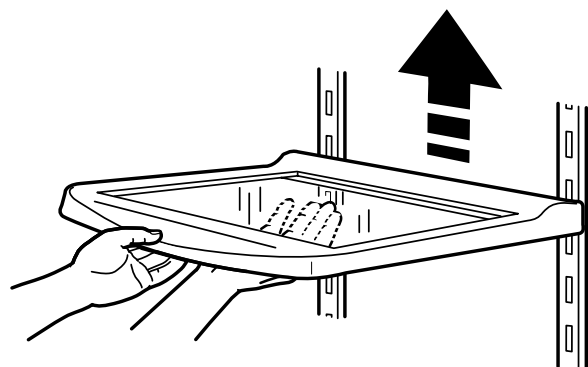

FreshChill™

Meat Locker

The FreshChill Meat Locker is designed to provide colder storage temperatures than the average refrigerator temperature. The Meat Locker can be located in any set of ladder slots. **For temperature-controlled use, however, the Meat Locker must be located in the second to last (bottom) set of ladder slots.** The FreshChill Meat Locker can be removed for cleaning.

IMPORTANT: If the meat locker is placed in any set of slots other than the second to last (bottom) set of ladder slots, the air supply hole must be sealed. Use the plug taped to the inside bottom of the meat locker to seal the air supply hole.

The rubber air connector (located on back of meat locker) directs air from the air supply hole into the meat locker. If the air connector comes off, replace it by pushing it into the square opening on back of meat locker.

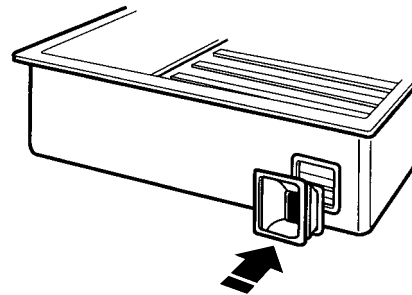

To remove:

1. Roll meat locker out to the stop.
2. Lift front of meat locker slightly.
3. Pull meat locker out the rest of the way.

To replace:

1. Position meat locker rollers between front roller of track and the track.
2. Push meat locker up and onto track.
3. Slide meat locker back until it stops.

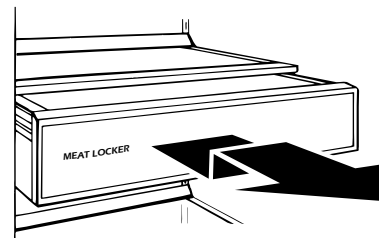

Setting the FreshChill™ Meat Locker Temperature Control

The FreshChill Meat Locker Temperature Control allows you to adjust the storage temperature of the FreshChill meat locker.

Cold air flows into the meat locker through an air duct between the freezer and the refrigerator. Setting the control allows more or less cold air through the air duct. Set the control to "Cold" to close the air duct.

IMPORTANT: If a food item freezes in the FreshChill Meat Locker, utility drawer, or crisper, turn the FreshChill Meat Locker Temperature Control to "Cold". If the water dispenser stops working, water in the line may have frozen. If this happens, turn the FreshChill Meat Locker Temperature Control to "Cold".

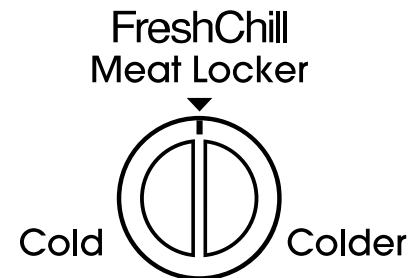

Humidity-controlled ClearVue™ crispers

The humidity-controlled crispers are designed to keep fresh vegetables and fruits longer. The Crisper Controls are located on the front of the crispers. The controls adjust the humidity (moisture) in the drawers. Slide control to “HIGH” for lettuce, cabbage and other produce that have leaves. Slide control to “LOW” for apples, corn and other produce that have skins.

The humidity-controlled crispers are interchangeable. The ClearVue section allows you to see into the crisper without opening them.

IMPORTANT: Occasionally, a food item may freeze in the FreshChill* Meat Locker, utility drawer, or crisper. When this occurs, turn the FreshChill Meat Locker Temperature Control to “cold.”

To remove crispers:

1. Roll drawer out to the stop.
2. Lift front of drawer and pull out the rest of the way.

To replace crispers:

1. Position drawer rollers between front roller of track and the track.
2. Push crisper up and onto track.
3. Slide crisper back until it stops.

To remove glass covers:

1. Lift right side of glass cover to free retainer and left side of cover.
2. Carefully remove glass cover.

To replace glass covers:

1. Place retainer on right side of glass cover.
2. Insert left side of glass cover into groove on left side of drawer.
3. Lower cover so that the retainer pins are in the guide holes on right side of drawer.

To remove ClearVue section:

1. Remove glass cover.
2. Slide ClearVue section down track, away from the retainer.
3. Replace in reverse order.

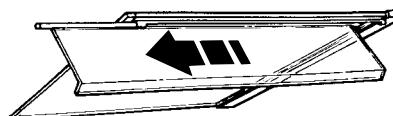
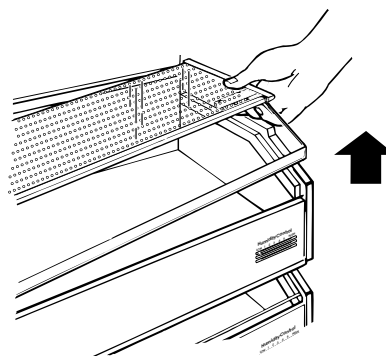
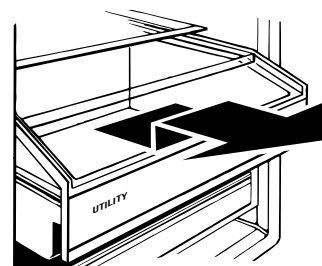

Covered Egg Container

The covered egg container with carrier provides extra protection for storing eggs anywhere inside your refrigerator section. The ClearVue* container allows you to see how many eggs you have stored.

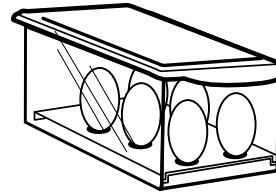

Wine rack

Insert the wine rack into position by sliding it between a refrigerator shelf and the wall of the refrigerator compartment.

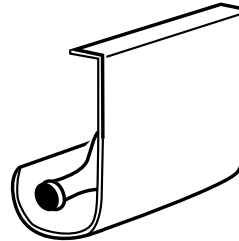

Freezer features

Freezer shelves

To remove:

1. Lift shelf up.
2. Pull shelf straight out.
3. Replace in reverse order.

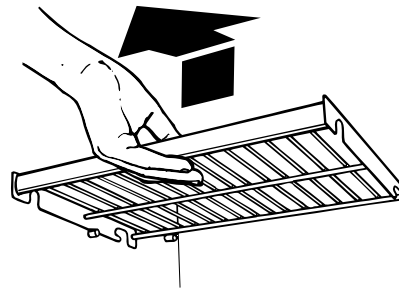

Pull-out freezer baskets

To remove:

1. Pull basket out to the stop.
2. Lift basket slightly and move it to the left.
3. Pull basket out the rest of the way.

To replace:

1. Place basket in shelf tracks and move basket to the left.
2. Push basket in to the stop on the left side.
3. Lift left side of basket slightly to clear the stop.
4. Push basket in the rest of the way.

IMPORTANT: Be sure both sides of basket are in the shelf tracks before filling with food.

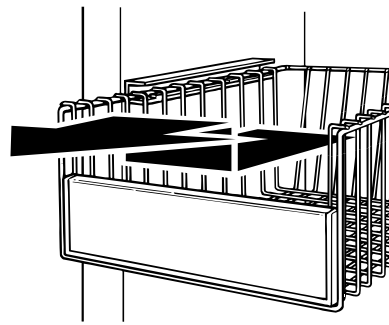

Note: Stationary shelf on freezer door is not removable.

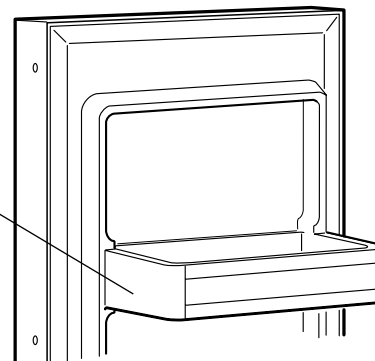

Automatic ice maker

To start ice maker:

- **For dispenser models only:** Pull ice maker cover panel out from the bottom and slide it to the rear.
- Push ice maker wire arm down to the “ON” position.

The ice maker fills with water and begins forming ice. Allow 24 hours to produce the first batch of ice. Ice maker should then produce 7 to 9 batches of ice in a 24-hour period under normal conditions. **Discard the first three batches of ice.** After ice is formed, ice cubes drop into storage bin. When ice bin is full, ice maker arm raises to the “OFF” position (arm up).

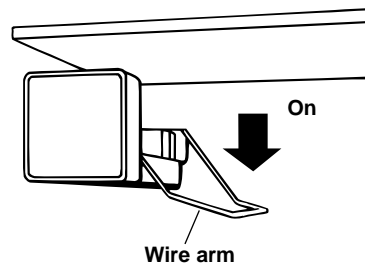

To stop ice maker:

- Lift the ice maker wire arm until you feel it click into the “OFF” position.
- Do not force arm up or down. Do not store anything on top of ice maker or in ice bin.

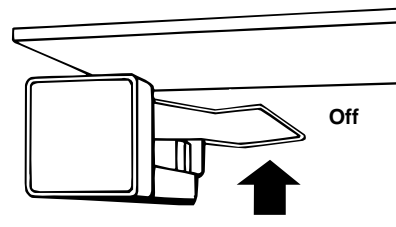

Solving common ice maker problems

PROBLEM	POSSIBLE CAUSE/SOLUTION
Ice crescents attached at corners	This is normal. They break apart easily. Shake bin occasionally to keep cubes separated.
Ice maker will not operate or ice is not made fast enough	ON/OFF wire arm is in the “OFF” (up) position. Lower wire arm to the “ON” (down) position. Freezer is not cold enough. Adjust temperature controls and wait 24 hours. (See “Setting temperature controls” on page 6.) Copper tubing is kinked. Check water tubing.
Off-taste or odor in ice	New plumbing connections can cause discolored or off-flavored ice. Discard the first few batches of ice. Cubes are stored too long. Throw them away and make a new supply. Food is not wrapped properly. See page 20. Freezer and ice bin need to be cleaned. See page 17. Water may contain minerals (such as sulfur). A filter may be required to remove them.
No ice produced	There is no water in the tank. Press the water dispenser lever and hold it in for several minutes. When water dispenses, tank is full.

Removing the ice maker storage bin

Depending on the model, the ice maker storage bin holds the following amounts of ice:

36" - 8.5 pounds (3.9 kg)

42" - 13.5 pounds (6.1 kg)

48" - 17.6 pounds (8.0 kg)

Remove and discard unused ice periodically to reduce the potential for off-taste or odor buildup in ice. The storage bin can be removed for cleaning or to dispense large amounts of ice at one time.

Note: On models without ice and cold water dispenser, the storage bin cannot be removed full of ice if the freezer door stop is set to a 90° opening.

To remove:

1. Pull the ice maker cover panel out from the bottom and slide it to the rear.
2. Lift the ice maker wire arm until you feel it click into the "OFF" position.

For dispenser models only: While the ice maker is "OFF," no more ice can be produced, but ice can still be dispensed when the freezer door is closed.

3. Lift the front of the storage bin, then pull it out.
4. Empty the storage bin. Use hot or warm water to melt ice if necessary. Never use anything sharp to break up ice in the storage bin. This can damage the storage bin and the dispenser mechanism.

To replace:

1. Push storage bin in all the way.
2. Lower the ice maker wire arm down to the "ON" position to restart ice maker.
3. Lower the ice maker cover panel.

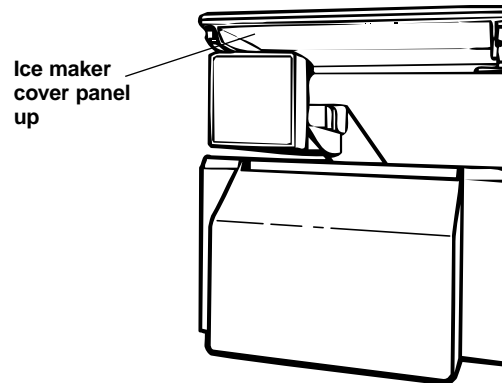
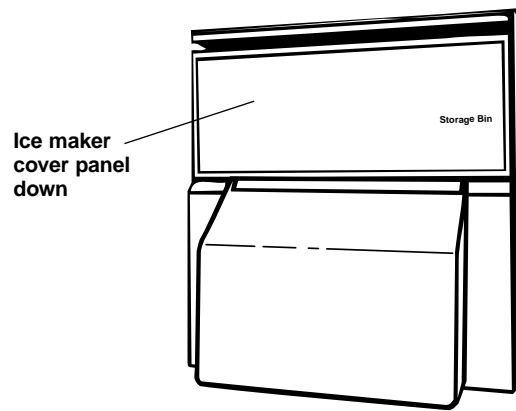

Ice and cold water dispensers

(models KSSP36Q, KSSP42Q, KSSP48Q, KSSS36Q, KSSS42Q, KSSS48Q)

⚠ WARNING



Cut Hazard

Use a sturdy glass when dispensing ice or water.
Failure to do so can result in cuts.

Ice dispenser

Ice dispenses from ice maker storage bin in the freezer. When dispenser bar is pressed, a trap door opens in a chute between the dispenser and ice bin. Ice moves from the bin and falls through the chute. When dispenser bar is released, a buzzing sound may be heard for a few seconds.

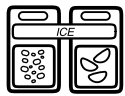

Your refrigerator dispenses both cubed and crushed ice. Before dispensing ice, select which type of ice you prefer. For crushed ice, press pad on left above "ICE". For cubed ice, press pad on right above "ICE".

To dispense ice:

1. Press pad for desired type of ice.
2. Press a **sturdy** glass against the ice dispenser bar. Hold glass close to dispenser opening so ice does not fall outside of glass.
3. Remove the glass to stop dispensing.

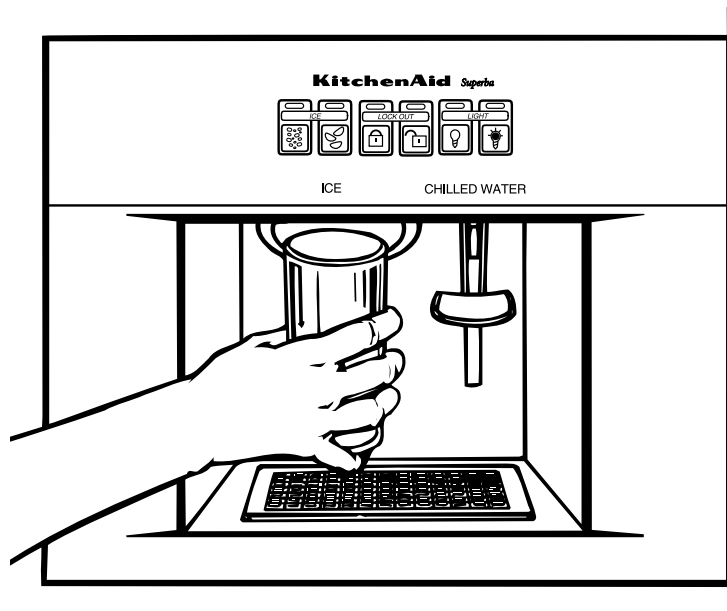

Water dispenser

IMPORTANT: If the water dispenser stops working, water may be frozen in the water line leading to the dispenser. If this happens, turn the FreshChill* Meat Locker Temperature Control toward "Cold."

Chilled water comes from a reservoir behind the crispers. Allow about 24 hours to chill the first reservoir full of water.

When the refrigerator is first hooked up, press the water dispenser bar until you draw and discard 2 to 3 quarts (1.9 to 2.9 L) of water. This removes air from the system and rinses the water filter, reservoir, and pipes. Ice maker will not produce ice without filling reservoir.

If the dispenser is not used regularly, dispense enough water every week to freshen the supply. Allow two to three hours for a new supply of water to chill.

IMPORTANT: The small tray under the dispenser is designed to evaporate **small** spills. There is no drain in the tray. Do not pour water into it.

To dispense water:

1. Press a **sturdy** glass against the water dispenser bar.
2. Remove glass to stop dispensing.

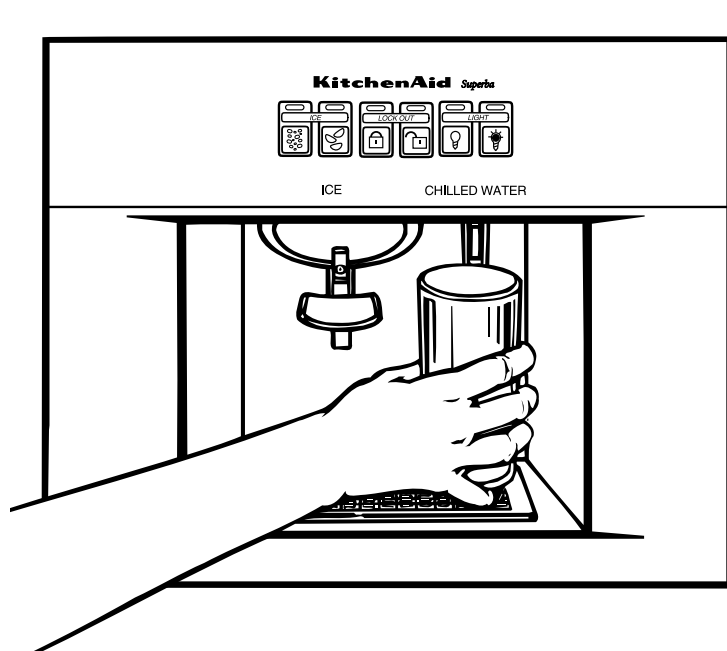

Dispenser/ice maker operating tips

PROBLEM	CAUSE	SOLUTION
Dispensers won't work	Freezer door open	Close the freezer door.
Ice dispenser won't work	Ice bin not properly installed	Make sure ice bin is pushed in all the way.
	Wrong ice in bin	Use only crescents from ice maker. Shake ice bin occasionally to keep cubes separated and to obtain increased storage capacity.
	Dispenser not used for extended periods of time, causing ice cubes to melt together	Dump old ice and make a new supply.
	Ice dispenser bar held in too long	Wait about three minutes for the dispenser motor to reset. Large amounts of ice should be taken from the bin, not through the dispenser.
	Lock Out has been chosen	Turn Lock Out off.
	Low water pressure	Call local utility company.
	Using a reverse osmosis water filtering system	Remove the refrigerator water filter. Replace filter cap in grille. See page 16.
	Water filtration system installed incorrectly or clogged	Check Water Filtration Installation Instructions to see that filter was installed correctly and is not clogged.
Off-taste or odor in ice	Ice attracts airborne odors; old ice	Dump old ice and make a new supply; store excess ice in a covered container.
	Water quality	For best results, avoid connecting ice maker to a softened water supply. If softened water supply cannot be avoided, make sure the water softener is well maintained and operating properly.
	Foods not properly wrapped	Wrap foods properly in airtight and moisture-proof materials. See page 20.
	Ice bin and freezer may need cleaning	Clean freezer and ice bin. See "Cleaning the refrigerator" on page 17 for instructions.
	Plumbing to ice maker	Follow Installation Instructions for proper ice maker water supply hookup.
	New ice maker	The first few batches of ice from a new ice maker may have an off-taste. Dump this ice and make a new supply.

Water Filtration and Monitoring System

The water filter indicator light

The water filter indicator light will help you know when to change your water filter cartridge. The light is located at the top of the refrigerator compartment. The light will change from green to yellow. This tells you that it is almost time to change the water filter cartridge (90% of the filter life has been used). It is recommended that you replace the water filter cartridge when the water filter indicator light changes to red OR water flow to your water dispenser or ice maker decreases noticeably. (See "Changing a water filter cartridge" below).

NOTE: Do not use with water that is microbiologically unsafe or of unknown quality without adequate disinfection before or after the system.

After changing the water filter cartridge, reset the water filter indicator light by depressing the Light Switch button 5 times. The indicator light will change from red to green when the system is reset.

Changing a water filter cartridge

The water filter is located below the refrigerator compartment door.

1. Locate the water filter cartridge cap in the front base grille below the freezer compartment door. Rotate the cap counterclockwise to a vertical position and pull the cap and filter cartridge out through the base grille.

NOTE: There will be water in the cartridge. Some spilling may occur.

2. Remove the cartridge cap by sliding it off the end of the old cartridge. The cap will slide to the left or right. **DO NOT DISCARD THE CAP.**
3. Take the new cartridge out of its packaging and remove protective cover from o-rings.
4. Slide the cartridge cap onto the new cartridge as shown.

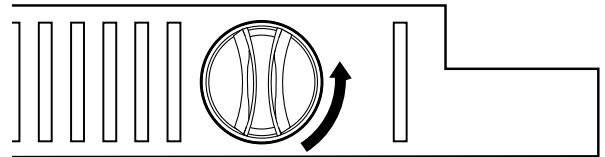
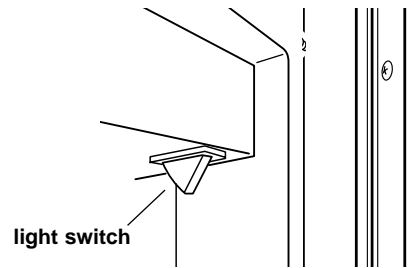

1.

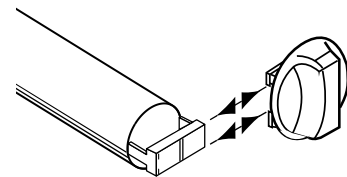

2.

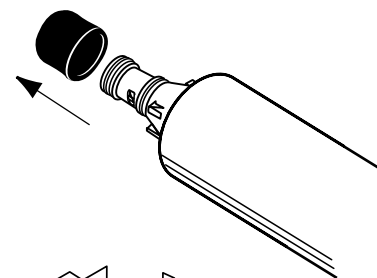

3.

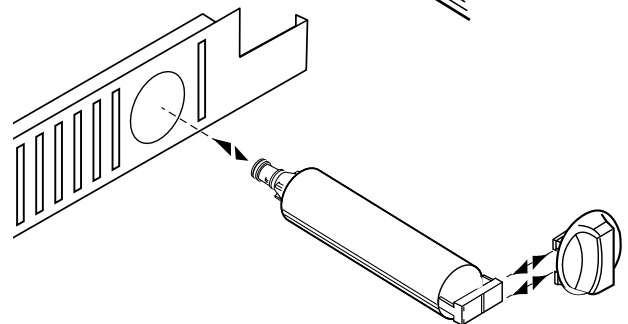

4.

Water Filtration and Monitoring System (cont.)

5. With cartridge cap in the vertical position, push the new filter cartridge into the base grille until it stops. Rotate the cartridge cap clockwise to a horizontal position.
6. RUN WATER THROUGH THE DISPENSER UNTIL THE WATER RUNS CLEAR (about 2-3 gallons or 6-7 minutes). This will clean the system and clear air from the lines. Additional flushing may be required in some households.

NOTE: As air is cleared from the system, water may spurt out of the dispenser.

Using the dispenser without a water filter

You can run the dispenser without a water filter cartridge. Your water will not be filtered. If you run the dispenser without a water filter cartridge, keep the cartridge cap and replace it in the base grille for future use.

1. Remove the water filter cartridge (See "Changing a water filter cartridge" earlier in this section.) Then slide the cartridge cap off the end of the filter cartridge. DO NOT DISCARD THE CAP.
2. With the cartridge cap in the vertical position, insert the cap into the base grille until it stops.
3. Rotate the cartridge cap to a horizontal position.

NOTE: The cartridge cap may not be even with the base grille.

Ordering replacement filters

To order more water filter cartridges, call 1-800-253-1301 and ask for accessory Part #4392857 or contact your authorized KitchenAid dealer.

Base grille

To remove:

1. Remove one screw at each end of the base grille.
2. Remove base grille.
3. Replace in reverse order.

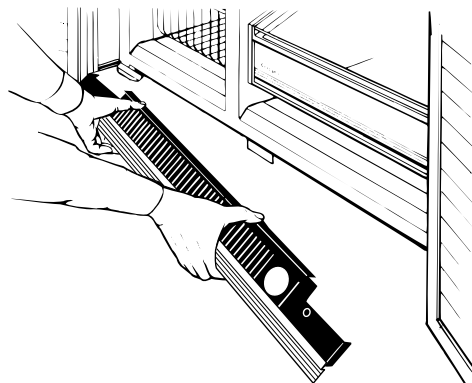
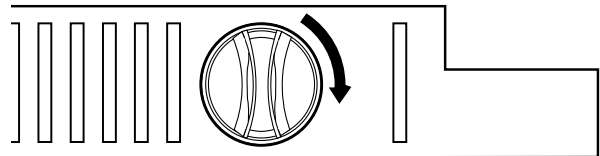
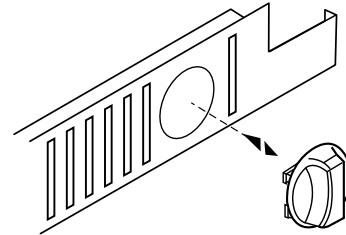
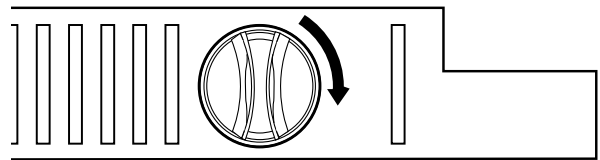

Defrost pan

The defrost pan is located behind the base grille, toward the left side of the refrigerator.

To remove:

1. Press Power On/Off Switch to the "OFF" position. (See page 5 for instructions).
2. Remove base grille.
3. Find retaining clip (A) under refrigerator.
4. Push up on the clip and, at the same time, slide the pan forward and out.
5. Clean the pan. (See page 17 for instructions.)

To replace:

1. Position the edge of the defrost pan approximately 7 inches (17.8 cm) from the left side of the refrigerator.
2. Lift defrost pan into guides and push back until you hear the "click" or "snap" of the retaining clip moving into place.
3. Replace the base grille.
4. Press Power On/Off Switch to the "ON" position.

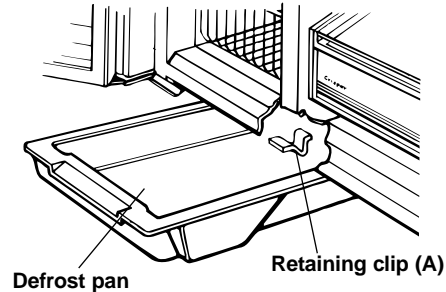

Light bulbs

Light bulbs are located behind the Refrigerator and Freezer Controls:

1. Unplug refrigerator or disconnect power to refrigerator.
2. Reach behind control panel.
3. Unscrew bulb and replace it with a 40-watt, incandescent, medium-base, tubular bulb.
4. Plug refrigerator power cord into outlet or reconnect power to refrigerator.

Light bulb below ice storage bin:

1. Unplug refrigerator or disconnect power to refrigerator.
2. Remove light cover.
3. Unscrew bulb and replace it with a 40-watt, incandescent, medium-base, tubular bulb.
4. Replace light cover.
5. Plug refrigerator power cord into outlet or reconnect power to refrigerator.

Light bulb in dispenser area: (dispenser models)

1. Unplug refrigerator or disconnect power to refrigerator.
2. Unscrew the bulb from the top, inside of the dispenser area.
3. Replace bulb with a heavy-duty, 10-watt bulb.
4. Plug refrigerator power cord into outlet or reconnect power to refrigerator.

IMPORTANT: Be sure to press Power On/Off Switch to the "ON" position after changing light bulb(s).

Understanding the sounds you may hear

Your new refrigerator may make sounds that your old one didn't make. Because the sounds are new to you, you might be concerned about them. Most of the new sounds are normal. Hard surfaces like the floor, walls, and cabinets can make the sounds seem louder than they

actually are. Due to new product designs, there may be sounds that you are not familiar with. The following chart describes the kinds of sounds that might be new to you and what may be making them.

SOUNDS/OBSERVATIONS	CAUSES
Hum or hiss	The refrigerator's fan motor and moving air.
Clicking or snapping sounds	The thermostat makes a definite click when the refrigerator stops running. It also makes a sound when the refrigerator starts. The defrost timer will click when the defrost cycle starts and stops.
Ice maker sounds • trickling water • clatter of ice	You may hear buzzing (from the water valve), trickling water, and the clatter of ice falling into the bin.
Running sounds	The high-efficiency compressor and motor will run longer than older designs. The internal fan may occasionally run when the compressor is off.
Trickling water/ water sounds	During the defrost cycle, the refrigerator will not be running. The trickling water is the frost accumulated on the freezer coil melting and running into the defrost pan. When the refrigerator stops running, you will hear gurgling in the tubing for a few minutes.
Warm air from upper ventilation panel/ base grille	You may feel air blowing from behind the upper ventilation panel and base grille when the refrigerator is running. This is normal.

Saving Energy

You can help your refrigerator use less electricity.

- Clean the condenser coils regularly.
- Open the door as few times as possible. Think about what you need before you open the door. Get everything out at one time. Keep food organized so you won't have to search for what you want. Close door as soon as food is removed.
- Fill up the refrigerator, but don't overcrowd it so air movement is blocked.
- It is a waste of electricity to set the refrigerator and freezer to temperatures colder than they need to be. If ice cream is firm in the freezer and drinks are as cold as your family likes them, that's cold enough.

CARING FOR YOUR REFRIGERATOR

Your refrigerator is built to give you many years of dependable service. However, there are a few things you can do to help extend its product life. This section tells

you how to clean your refrigerator and what to do when going on vacation, moving, or during a power outage.

Cleaning your refrigerator



The refrigerator and freezer compartments defrost automatically. However, clean both once a month to prevent odors from building up. Wipe up spills immediately.

Before cleaning, disconnect the refrigerator from its power supply by pressing the Power On/Off Switch to the "OFF" position. Then, take out all removable parts and clean the refrigerator according to the directions given below. Be sure to press the Power On/Off Switch to the "ON" position when you are finished cleaning.

⚠ WARNING

Explosion Hazard

Use nonflammable cleaner.

Failure to do so can result in death, explosion, or fire.

PROBLEM	WHAT TO USE	HOW TO CLEAN
Removable parts (shelves, crisper, etc.)	Sponge or cloth with mild detergent and warm water	Hand wash and dry thoroughly.
Outside	Sponge, cloth, or paper towel with mild detergent, warm water, and a good appliance wax (or good auto paste wax)	Wash outside of cabinet. Do not use abrasive or harsh cleaners. Wipe and dry thoroughly. Wax painted metal surfaces at least twice a year. Apply wax with a clean, soft cloth. Waxing painted metal surfaces provides rust protection. Do not wax plastic parts.
Inside walls (allow freezer to warm up so cloth won't stick)	Sponge, soft cloth, or paper towel with baking soda or mild detergent and warm water	Wash with mixture of warm water and: • mild detergent, or • baking soda (2 tbs to 1 qt [26 g to .95 L] of water). Wipe and dry thoroughly.
Door liners and gaskets	Sponge, soft cloth, or paper towel with mild detergent and warm water	Wipe and dry thoroughly. DO NOT USE cleaning waxes, concentrated detergents, bleaches, or cleaners containing petroleum on plastic parts.
Plastic parts (covers and panels)	Soft, clean sponge or soft, clean cloth with mild detergent and warm water	Wipe and dry thoroughly. DO NOT USE paper towels, window sprays, scouring cleansers, or flammable fluids. These can scratch or damage material. See "Important Safety Instructions" on page 3.
Defrost pan	Sponge or cloth with mild detergent and warm water	Press Power On/Off Switch to the "OFF" position. Remove base grille. (See page 14.) Reach into small opening at right edge and remove the defrost pan. (See page 15.) Wash, rinse, and dry thoroughly. Replace defrost pan. Make sure to push it completely into the opening. Replace base grille. Press Power On/Off Switch to the "ON" position.
Stainless steel doors and grille	Stainless steel cleaner	Wipe with soft cloth.

PART	WHAT TO USE	HOW TO CLEAN
Condenser coils	Vacuum cleaner with extended narrow attachment	Remove upper ventilation panel to expose condenser coils. (See page 5.) Vacuum coils when dusty or dirty. Coils may need to be cleaned as often as every other month. Replace upper ventilation panel.
Base grille	Vacuum cleaner with brush attachment	Vacuum base grille.
Stainless steel	A professional stainless steel cleaner.	Follow directions included with cleaner.

Vacation and moving care

Short vacations

If you will be away for less than four weeks, use these tips to prepare your refrigerator before you leave.

1. Use up any perishables and freeze other items.
2. If your refrigerator has an automatic ice maker:
 - Raise wire arm to “OFF” (up) position.
 - Shut off water supply to the ice maker.
3. Empty the ice bin.

Long vacations

If you will be gone for a month or more, follow these steps to prepare your refrigerator.

1. Remove all food from the refrigerator.
2. If your refrigerator has an automatic ice maker:
 - Turn off the water supply to the ice maker at least one day ahead of time.
 - When the last load of ice drops, turn off the ice maker. Make sure all ice is dispensed out of the ice maker mechanism.
3. Unplug the refrigerator.
4. Clean it, wipe it, and dry well.
5. Tape rubber or wood blocks to the tops of both doors to prop them open far enough for air to get in. This stops odor and mold from building up.

Moving

If the refrigerator must be moved, contact the dealer from whom you purchased the unit or your local KitchenAid authorized servicer.

Power interruptions

If electricity goes off, call the power company. Ask how long power will be off.

1. If power will be interrupted 24 hours or less, **keep both doors closed**. This helps food stay cold and frozen.
2. If service will be interrupted longer than 24 hours:
 - (a) Remove all frozen food and store in a frozen food locker.

OR

 - (b) Place 2 lbs. (900g) of dry ice in freezer for every cubic foot (28 liters) of freezer space. This will keep food frozen for two to four days. Wear gloves to protect your hands from dry ice burns.

OR

 - (c) If neither a food locker nor dry ice is available, use or can perishable food at once.

Remember: A full freezer stays cold longer than a partly filled one. A freezer full of meat stays cold longer than a freezer full of baked goods. If food contains ice crystals, it may be safely refrozen, although the quality and flavor may be affected. If the condition of the food is poor, or if you feel it is unsafe, dispose of it.

Questions?

Call our Consumer Assistance Center telephone number, **1-800-235-0665**, from anywhere in the U.S.A. or Canada.

FOOD STORAGE GUIDE

There is a correct way to package and store refrigerated or frozen food.

To keep food fresher, longer, take the time to study these recommended steps.

Storing fresh food

Wrap or store food in the refrigerator in airtight and moisture-proof material unless otherwise noted. This prevents food odor and taste transfer throughout the refrigerator. For dated products, check code date to ensure freshness.

Butter or margarine

Keep opened butter in covered dish or closed compartment. When storing an extra supply, wrap in freezer packaging and freeze.

Cheese

Store in the original wrapping until you are ready to use it. Once opened, rewrap tightly in plastic wrap or aluminum foil.

Milk

Wipe milk cartons. For best storage, place milk on interior shelf.

Eggs

Store in original carton on interior shelf. On some models, an egg storage container is provided for your convenience.

Fruit

Wash, let dry, and store in refrigerator in plastic bags or crisper. Do not wash or hull berries until they are ready to use. Sort and keep berries in original container in a crisper, or store in a loosely closed paper bag on a refrigerator shelf.

Leafy vegetables

Remove store wrapping and trim or tear off bruised and discolored areas. Wash in cold water and drain. Place in plastic bag or plastic container and store in crisper.

Storing fresh food (cont.)

Vegetables with skins

(carrots, peppers)

Place in plastic bags, or plastic container and store in crisper.

Fish

Use fresh fish and shellfish the same day as purchased.

Meat

Store most meat in original wrapping as long as it is airtight and moisture-proof. Rewrap if necessary. See the following for storage times. When storing meat longer than the times given, freeze the meat.

Chicken	1-2 days
Bacon	5-7 days
Ground beef	1-2 days
Cold cuts	3-5 days
Steaks/roasts	3-5 days
Variety meats	1-2 days
Cured meats.....	7-10 days

Leftovers

Cover leftovers with plastic wrap or aluminum foil. Plastic containers with tight lids can also be used.

NOTE: Keep your refrigerator smelling fresh with an open box of baking soda.

Storing frozen food

The freezer section is designed for storing commercially frozen food and for freezing food at home.

NOTE: For further information about preparing food for freezing or food storage times, check a freezer guide or reliable cookbook.

Packaging

Successful freezing depends on the correct packaging. When you close and seal the package you must not allow air or moisture in or out. If you do, you could have food odor and taste transfer throughout the refrigerator, and also dry out frozen food.

Packaging recommendations:

- Rigid plastic containers with tight-fitting lids
- Straight-sided canning/freezing jars
- Heavy-duty aluminum foil
- Plastic-coated paper
- Non-permeable plastic wraps (made from saran film)
- Specified freezer self-sealing plastic bags

Follow package or container instructions for proper freezing methods.

Do not use:

- Bread wrappers
- Non-polyethylene plastic containers
- Containers without tight lids
- Wax paper or wax-coated freezer wrap
- Thin, semi-permeable wrap

Freezing

Your freezer will not quick-freeze any large quantity of food. Put no more unfrozen food into the freezer than will freeze within 24 hours (about 2 to 3 lbs of food per cubic foot [907-1,350 g per liter] of freezer space).

Leave enough space in the freezer for air to circulate around packages. Also leave enough room at the front so the door can close tightly.

Storage times vary according to the quality and type of food, the type of packaging used (airtight and moisture-proof), and the storage temperature.

Ice crystals inside a sealed package are normal. It means that moisture in the food and air inside the package have condensed, creating ice crystals.

NOTE: Allow hot foods to cool at room temperature for 30 minutes, then package and freeze. Cooling hot foods before freezing saves energy.

TROUBLESHOOTING GUIDE

You can solve many common refrigerator problems easily, saving you the cost of a possible service call. Try the suggestions below to see if you can solve your

problem without outside help. If the suggestions do not work, please call the KitchenAid Consumer Assistance Center.

Your refrigerator will not operate

Check if ...	Then ...
The power supply cord is unplugged.	Firmly plug the cord into a live outlet with proper voltage.
A household fuse has blown or circuit breaker has tripped.	Replace the fuse or reset the circuit.
The Refrigerator Control is turned to the "OFF" position.	Refer to the "Setting temperature controls" section.
The refrigerator is defrosting.	Recheck to see if the refrigerator is operating in 30 minutes. Your refrigerator will regularly run an automatic defrost cycle. If it is still not running after checking the above items, call the Consumer Assistance Center.

The lights do not work

Check if ...	Then ...
The power supply cord is unplugged.	Firmly plug the cord into a live outlet with proper voltage.
A household fuse or circuit breaker has tripped.	Replace the fuse or reset the circuit.
A light bulb is loose in the socket.	Turn the Freezer Control to OFF. Disconnect the refrigerator from the electrical supply. Gently remove the bulb and reinsert. Then reconnect the refrigerator to the electrical supply and reset the Freezer Control.
A light bulb has burned out.	Replace with an appliance bulb of the same wattage, size, and shape. See the "Changing the light bulbs" section.

There is water in the defrost drain pan

Check if ...	Then ...
The refrigerator is defrosting.	The water will evaporate. It is normal for water to drip into the defrost pan.
It is more humid than normal.	Expect that the water in the defrost pan will take longer to evaporate. This is normal when it is hot or humid.
Water in the defrost pan is overflowing.	Check to make sure your refrigerator is level. (See the "Leveling" section.) If it is still overflowing, there is probably something wrong with the refrigerator. Call the Consumer Assistance Center.

Troubleshooting (cont.)

The motor seems to run too much

Check if ...	Then ...
The room temperature is hotter than normal.	Expect the motor to run longer under warm conditions. At normal room temperatures, expect your motor to run about 40% to 80% of the time. Under warmer conditions, expect it to run even more of the time.
A large amount of food has just been added to the refrigerator.	Adding a large amount of food warms the refrigerator. It is normal for the motor to run longer in order to cool the refrigerator back down. See the "Food Storage Guide" section.
The door is opened often.	Expect the motor to run longer when this occurs. In order to conserve energy, try to get everything you need out of the refrigerator at once, keep food organized so it is easy to find, and close the door as soon as the food is removed.
The controls are not set correctly for the surrounding conditions.	Refer to the "Setting temperature controls" section.
The doors are not closed completely.	Push the doors firmly shut. If they will not shut all the way, see "The doors will not close completely," later in this section.
The base grille is dirty or blocked.	This prevents air circulation and makes the motor work harder. Remove the grille and clean.
The condenser coils are dirty.	This prevents air transfer and makes the motor work harder. Clean the condenser coils. Refer to the "Cleaning your refrigerator" section.
The door gaskets are not sealed all the way around.	Contact a qualified person or a technician. If the problem is not due to any of the above, remember that your new refrigerator will run longer than your old one due to its high-efficiency motor.

The refrigerator seems to make too much noise

Check if ...	Then ...
The sounds and noises are common for new refrigerators.	Refer to the "Understanding the sounds you may hear" section.

The ice maker is not producing ice

Check if ...	Then ...
The freezer temperature is not cold enough to produce ice.	See the "Setting controls" section.
The ice maker arm is in the "OFF" (arm up) position.	Lower arm to the "ON" (arm down) position. See the "Ice maker operation" section.
The water line shutoff valve to the refrigerator is not turned on.	Turn on the water valve.
An ice cube is jammed in the ejector arm.	Remove the ice from the ejector arm with a plastic utensil. Refer to the "Ice maker operation" section.
The ice maker mold has no water in it or no ice has been produced.	Check to see if your refrigerator has been connected to your home water supply and the supply shutoff valve is turned on.
	If not due to any of the above, there may be a problem with the water line. Contact the Consumer Assistance Center.

The ice maker is producing too little ice

Check if ...	Then ...
The ice maker has just been installed.	Wait 72 hours for full ice production to begin. Once your refrigerator is cooled down, the ice maker should begin producing 56-72 cubes every 24 hours.
A large amount of ice has just been removed.	Allow 24 hours for ice maker to produce more ice.
The controls are not set correctly.	Refer to the "Setting temperature controls" section.
The water shutoff valve is not turned completely on.	Turn valve on fully. Refer to the "Ice maker operation" section.
There is a water filter installed on the refrigerator. This filter may be clogged or installed incorrectly.	First, check the filter installation instructions to ensure that the filter was installed correctly and is not clogged. If installation or clogging is not a problem, call a qualified person or a technician.

Off-taste or odor in the ice

Check if ...	Then ...
The plumbing connections are new, causing discolored or off-flavored ice.	Discard the first few batches of ice.
The ice cubes have been stored for too long.	Throw old ice away and make a new supply.
Food in the freezer has not been wrapped properly.	Refer to the "Storing frozen food" section.
Freezer and ice bin need to be cleaned.	See the "Cleaning your refrigerator" section.
Water contains minerals (such as sulfur).	A filter may need to be installed to remove the minerals.

The divider between the two compartments is warm

Check if ...	Then ...
The condenser coils or base grille are dirty or clogged.	Clean according to the "Cleaning your refrigerator" section.
The motor has quit working.	See "Your refrigerator will not operate" earlier in this section. NOTE: The refrigerator temperature may turn from warm to hot.
	If not due to any of the above, the warmth is probably due to normal operation of the automatic exterior moisture control. If still concerned, call the Consumer Assistance Center or an authorized KitchenAid service company.

Temperature is too warm

Check if ...	Then ...
The door(s) are opened often.	Be aware that the refrigerator will warm when this occurs. In order to keep the refrigerator cool, try to get everything you need out of the refrigerator at once, keep food organized so it is easy to find, and close the door as soon as the food is removed.
A large amount of food has just been added to the refrigerator or freezer.	Adding a large amount of food warms the refrigerator. It can take several hours for the refrigerator to return to the normal temperature.
The controls are not set correctly for the surrounding conditions.	Refer to the "How controls work" section.

There is interior moisture build-up

Check if ...	Then ...
The door is opened often.	To avoid humidity build-up, try to get everything you need out of the refrigerator at once, keep food organized so it is easy to find, and close the door as soon as the food is removed. (When the door is opened, humidity from the room air enters the refrigerator. The more often the door is opened, the faster humidity builds up, especially when the room itself is very humid.)
The room is humid.	It is normal for moisture to build up inside the refrigerator when the room air is humid.

There is interior moisture build-up (cont.)

Check if ...	Then ...
The food is not packaged correctly.	Check that all food is securely wrapped. If necessary, repackage food according to the guidelines in the “Food Storage Guide” section. Wipe off damp food containers before placing in the refrigerator.
The controls are not set correctly for the surrounding conditions.	Refer to the “Setting temperature controls” section.
A self-defrost cycle was completed.	It is normal for droplets to form on the back wall after the refrigerator self-defrosts.

The doors will not close completely

Check if ...	Then ...
Food packages are blocking the door open.	Rearrange containers so that they fit more tightly and take up less space.
The ice bin is out of position.	Push the ice bin in all the way.
The pans, shelves, bins, or baskets are out of position.	Put all pans, shelves, bins, and baskets back into their correct position.
The gaskets are dirty.	Clean gaskets according to the directions in the “Caring for Your Refrigerator” section.
The doors were removed during product installation and not properly replaced.	Remove and replace the doors or, contact a qualified person.

The doors are difficult to open

Check if ...	Then ...
The gaskets are dirty or sticky.	Clean gaskets according to the directions in the “Caring for Your Refrigerator” section.

REQUESTING ASSISTANCE OR SERVICE

To avoid unnecessary service calls, please check the “Troubleshooting Guide” section. It may save you the cost of a service call. If you still need help, follow the instructions below.

If you need assistance or service in U.S.A.

Call the KitchenAid Customer Interaction Center toll-free at 1-800-235-0665.

Our consultants are available to assist you.

When calling: Please know the purchase date, and the complete model and serial number of your appliance (see the “A Note to You” section). This information will help us better respond to your request.



Our consultants provide assistance with:

- Features and specifications on our full line of appliances
- Installation information

- Use and maintenance procedures
- Accessory and repair parts sales
- Specialized customer assistance (Spanish speaking, hearing impaired, limited vision, etc.)
- Referrals to local dealers, service companies, and repair parts distributors

KitchenAid designated service technicians are trained to fulfill the product warranty and provide after-warranty service, anywhere in the United States.

To locate the designated KitchenAid service company in your area, you can also look in your telephone directory Yellow Pages.

If you need replacement parts

If you need to order replacement parts, we recommend that you only use factory-authorized parts. These parts will fit right and work right, because they are made to the same exacting specifications used to build every new KitchenAid® appliance.

To locate factory-authorized parts in your area, call our Customer Interaction Center telephone number, your nearest authorized service center, or KitchenAid Factory Service at 1-800-442-1111.

Base grille water filter cartridges:

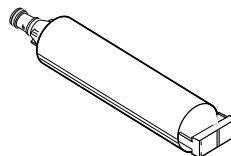

Standard Cartridge - order part number 4392857 (L500)
Cyst Cartridge - order part number 4392922 (LC400)

For further assistance

If you need further assistance, you can write to KitchenAid with any questions or concerns at:

KitchenAid Brand Home Appliances
Customer Interaction Center
c/o Correspondence Dept.
2000 North M-63
Benton Harbor, MI 49022-2692

Please include a daytime phone number in your correspondence.

REQUESTING ASSISTANCE OR SERVICE

Before calling for assistance or service, please check the “Troubleshooting Guide” section. It may save you the cost of a service call. If you still need help, follow the instructions below.

If you need assistance or service in Canada

1. If the problem is not due to one of the items listed in “Troubleshooting Guide”†...



Contact the dealer from whom you purchased your appliance, or call the KitchenAid Canada Customer Interaction Centre toll-free, **8:30 a.m. – 6 p.m. (EST)**, at **1-800-235-0665**.

2. If you need service†...

Contact your nearest KitchenAid Canada Appliance Service branch or authorized servicing outlet to service your appliance. (See list below.) Make sure the service company you contact is authorized to service your appliance during the warranty period.

†When asking for assistance or service, please provide a detailed description of the problem, your appliance’s complete model and serial numbers, and the purchase date. (See the “A Note to You” section.) This information will help us respond properly to your request.

KitchenAid Canada Appliance Service – Consumer Services

Direct service branches:

BRITISH COLUMBIA		1-800-665-6788
ALBERTA		1-800-661-6291
ONTARIO (except 807 area code)	Ottawa area	1-800-267-3456
	Outside the Ottawa area	1-800-807-6777
MANITOBA, SASKATCHEWAN and 807 area code in ONTARIO		1-800-665-1683
QUEBEC	Montreal (except South Shore)	1-800-361-3032
	South Shore Montreal	1-800-361-0950
	Quebec City	1-800-463-1523
	Sherbrooke	1-800-567-6966
ATLANTIC PROVINCES		1-800-565-1598

For further assistance

If you need further assistance, you can write to KitchenAid Canada with any questions or concerns at:

Consumer Relations Department
KitchenAid Canada
1901 Minnesota Court
Mississauga, Ontario L5N 3A7

Please include a daytime phone number in your correspondence.

KitchenAid® Built-In Refrigerator Warranty



LENGTH OF WARRANTY:	KITCHENAID WILL PAY FOR:	KITCHENAID WILL NOT PAY FOR:
ONE YEAR FULL WARRANTY FROM DATE OF INSTALLATION	Replacement parts and labor costs to correct defects in light bulbs. Service must be provided by a designated KitchenAid servicing outlet.	A. Service calls to: <ol style="list-style-type: none"> 1. Correct the installation of the refrigerator. 2. Instruct you how to use the refrigerator. 3. Replace house fuses or correct house wiring. 4. Replace house plumbing. B. Repairs when refrigerator is used in other than normal home use. C. Damage resulting from accident, alteration, misuse, abuse, improper installation, or installation not in accordance with local electrical codes or plumbing codes. D. Any food loss due to product failure. E. Any labor costs during the limited warranty. F. Replacement parts or repair labor costs for units operated outside the United States or Canada. G. Repairs to parts or systems resulting from unauthorized modifications made to the appliance. H. Removal and replacement of trim or decorative panels that interfere with servicing the product. I. Labor or parts installed by any non-designated service company during the full warranty period, unless approved by KitchenAid before service is performed. J. Any medicine loss due to product failure.
TWO YEAR FULL WARRANTY FROM DATE OF INSTALLATION	Replacement parts and repair labor costs to correct defects in materials or workmanship. Service must be provided by a designated KitchenAid servicing outlet.	
THIRD THROUGH SIXTH YEAR FULL WARRANTY FROM DATE OF INSTALLATION	Replacement parts and repair labor costs to correct defects in materials or workmanship in the sealed refrigeration system. These parts are: 1. Compressor; 2. Evaporator; 3. Condenser; 4. Drier; 5. Connecting Tubing. Service must be provided by a designated KitchenAid servicing outlet.	
SEVENTH THROUGH TWELFTH YEAR LIMITED WARRANTY FROM DATE OF INSTALLATION	Replacement parts to correct defects in materials or workmanship in the sealed refrigeration system. These parts are: 1. Compressor; 2. Evaporator; 3. Condenser; 4. Drier; 5. Connecting Tubing.	
LIFETIME LIMITED WARRANTY ON REFRIGERATOR DOOR BINS	Replacement parts to correct defects in materials of workmanship in the refrigerator door bins.	

11/99

KITCHENAID AND KITCHENAID CANADA DO NOT ASSUME ANY RESPONSIBILITY FOR INCIDENTAL OR CONSEQUENTIAL DAMAGES. Some states or provinces do not allow the exclusion or limitation of incidental or consequential damages, so this exclusion or limitation may not apply to you.

This warranty gives you specific legal rights, and you may also have other rights which may vary from state to state or province to province.

Outside the United States and Canada, a different warranty may apply. For details, please contact your authorized KitchenAid dealer.

If you need service, first see the “Troubleshooting Guide” section of this book. After checking the “Troubleshooting Guide,” additional help can be found by checking the “Requesting Assistance or Service” section or by calling our Consumer Assistance Center, **1-800-235-0665** (toll-free), from anywhere in the U.S.A. or Canada.

WATER FILTER CERTIFICATES

State of California
 Department of Health Services
 Water Treatment Device
 Certificate Number
 98 - 1367

Date Issued: November 18, 1998

State of California
 Department of Health Services
 Water Treatment Device
 Certificate Number
 98 - 1343

Date Issued: June 9, 1998

Trademark/Model Designation	Replacement Elements
Whirlpool WF-LC400	LC 400
Manufacturer: Whirlpool Corp.	

The water treatment device(s) listed on this certificate have met the testing requirements pursuant to Section 116830 of the Health and Safety Code for the following health related contaminants:

Microbiological Contaminants and Turbidity	Inorganic/Radiological Contaminants
Cysts (protozoan) Turbidity	Lead
Organic Contaminants: None	

Rated Service Capacity: 400 gallons Rated Service Flow: 0.5 gpm

Do not use where water is microbiologically unsafe or with water of unknown quality, except that systems claiming cyst reduction may be used on water containing cysts.

Trademark/Model Designation	Replacement Elements
WF-L500	L500
Manufacturer: Whirlpool Corp.	

The water treatment device(s) listed on this certificate have met the testing requirements pursuant to Section 116830 of the Health and Safety Code for the following health related contaminants:

Microbiological Contaminants and Turbidity	Inorganic/Radiological Contaminants
None	Lead
Organic Contaminants: None	

Rated Service Capacity: 500 gallons Rated Service Flow: 0.5 gpm

Do not use with water that is microbiologically unsafe or of unknown quality, without adequate disinfection before or after the system.

PRODUCT DATA SHEETS

Base Grille Water Filtration System Model WF-LC400/LC400



Tested and certified by NSF International against ANSI/NSF Standard 42 for the reduction of Chlorine (Class I) Taste and Odor and against ANSI/NSF Standard 53 for the reduction of Lead, Cysts and Turbidity.

Capacity: 400 Gallons (1514 Liters)
Service Flow Rate: 0.5 GPM (1.89 L/min.) @ 60 psi.

Substance Reduction	U.S. EPA MCL	Average Influent	Maximum Effluent	Average Effluent	Minimum % Reduction	Average % Reduction	NSF Test Number
Aesthetic Effects							
Chlorine Taste/Odor	N/A	2.0 mg/L	N/A	0.04 mg/L	N/A	98%	994707
Particulate	N/A	610,000/mL*	N/A	154/mL	N/A	99%	994711
Contaminant Reduction	U.S. EPA MCL	Average Influent	Maximum Effluent	Average Effluent	Minimum % Reduction	Average % Reduction	NSF Test Number
Cyst	99.95%**	89,250/mL*	6/mL	2.3/mL	99.993%	99.997%	994710
Turbidity	0.5 NTU	29 NTU	0.12 NTU	0.09 NTU	99.59%	99.69%	994710
Lead: @ pH 6.5	0.015 mg/L	0.16 mg/L***	0.001mg/L	0.001 mg/L	99.4%	99.4%	994708
Lead: @ pH 8.5	0.015 mg/L	0.16 mg/L***	0.002 mg/L	0.001 mg/L	98.8%	99.4%	994709

*Test requirement is at least 100,000 particles/ml of AC Fine Test Dust. **Cyst performance is % reduction based on NSF Standard 53. ***Test requirement is 0.15 mg/L ± 10%. These contaminants are not necessarily in your water supply. Performance may vary based on local water conditions.

Base Grille Water Filtration System Model WF-L500/L500



Tested and certified by NSF International against ANSI/NSF Standard 42 for the reduction of Chlorine (Class I) Taste and Odor and against ANSI/NSF Standard 53 for the reduction of Lead.

Capacity: 500 Gallons (1893 Liters)
Service Flow Rate: 0.5 GPM (1.89 L/min.) @ 60 psi.

Substance Reduction	Average Influent	Maximum Effluent	Average Effluent	Minimum % Reduction	Average % Reduction	NSF Test Number	
Chlorine, Taste/Odor	2.0 mg/L	N/A	0.1 mg/L	N/A	95%	981788	
Contaminant Reduction Performance††	U.S. EPA MCL	Average Influent	Maximum Effluent	Average Effluent	Minimum % Reduction	Average % Reduction	NSF Test Number
Lead: @ pH 6.5	0.015 mg/L	0.16 mg/L†	0.007 mg/L	0.005 mg/L	95%	97%	976115
Lead: @ pH 8.5	0.015 mg/L	0.14 mg/L†	0.012 mg/L	0.008 mg/L	91%	94%	976116

- It is essential that operational, maintenance, and filter replacement requirements be carried out for the product to perform as advertised.
- Model WF-LC400** The filter monitor system measures the amount of water that passes through the filter and alerts you to replace the filter. When 90% of the filter's rated life is used, the filter indicator light changes from green to yellow. When 100% of the filter's rated life is used, the filter indicator light changes from yellow to red, and it is recommended that you replace the filter. Use replacement cartridge LC400, part# 9902. 2000 suggested retail price of \$39.95 U.S.A./\$49.95 Canada.
- Model WF-NL500** The filter monitor system measures the amount of water that passes through the filter and alerts you to replace the filter. When 90% of the filter's rated life is used, the filter indicator light changes from green to yellow. When 100% of the filter's rated life is used, the filter indicator light changes from yellow to red, and it is recommended that you replace the filter. Use replacement cartridge L500, part# 4392857. 2000 Suggested retail price of \$29.95 U.S.A./\$39.95 Canada.
- The product is for cold water use only.
- Do not use with water that is microbiologically unsafe or of unknown quality without adequate disinfection before or after the system.
- Refer to the "Assistance or Service" section for the Manufacturer's name, address and telephone number.
- Refer to the "Warranty" section for the Manufacturer's limited warranty.

Application Guidelines/Water Supply Parameters

Water Supply	City or Well
Water Pressure	30 - 120 psi (207 - 827 kPa)
Water Temperature	33° - 100°F (0.6° - 37.8° C)

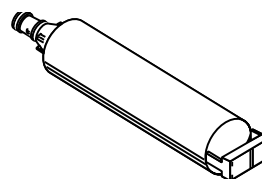

†Test requirement is 0.15 mg/L ± 10%.

††These contaminants are not necessarily in your water supply. Performance may vary based on local water conditions.

®NSF is a registered trademark of NSF International.