

Wall Oven

Use and Care Guide



Electrolux

CONTENTS

- | | | | |
|-----------|--------------------------------|-----------|------------------------------|
| 6 | Before Setting Oven Controls | 38 | Care and Cleaning |
| 8 | Setting Oven Controls | 43 | Before You Call |
| 14 | Fast Preheat | 43 | Solutions to Common Problems |
| 15 | Bake | 46 | Warranty |
| 32 | Adjusting the Oven Temperature | | |

PLEASE READ AND SAVE THIS GUIDE

Thank you for purchasing an Electrolux appliance. You've chosen a product that brings with it decades of professional experience and innovation. Ingenious and stylish, it has been designed with you in mind. So whenever you use it, you can be safe in the knowledge that you'll get great results every time.

This Use & Care Guide is part of our commitment to customer satisfaction and product quality throughout the service life of your new appliance. We view your purchase as the beginning of a relationship. To ensure our ability to continue serving you, please use this page to record important product information.

CUSTOMER CARE AND SERVICE

Keep a Record for Quick Reference

Purchase Date

Electrolux model number

Electrolux serial number

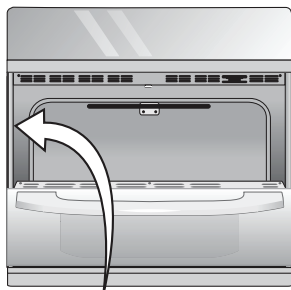

When contacting Service, ensure that you have the following data available. The information can be found on the rating plate. Serial plate location: open oven drawer (some models) or warmer drawer (some models). We recommend the use of original spare parts. Registering your product with Electrolux enhances our ability to serve you. You can register online at www.electroluxappliances.com or by dropping your Product Registration Card in the mail. For toll-free telephone support in the U.S. and Canada:

1-877-4ELECTROLUX (1-877-435-3287).

VISIT OUR WEBSITE FOR ACCESSORIES, CONSUMABLES, AND MORE!

The Electrolux Webshop



In the Electrolux webshop, you'll find everything you need to keep all your Electrolux appliances looking spotless and working perfectly. Electrolux offers a wide range of accessories designed and built to the high quality standards you would expect from specialist cookware to cutlery baskets, from bottle holders to delicate laundry bags.

Visit the webshop at: www.electrolux.com/shop

On the Electrolux Website

Want to learn more about your product or discover additional Electrolux appliances? If so, then check out the link below for product overviews, a list of features, photo galleries, product manuals (complete owner's guide, installation instructions, wiring diagrams, product spec sheets), specifications, reviews, related accessories, and video guides.

For online support and Internet production information, visit <http://www.electroluxappliances.com>

www.electrolux.com

1-877-435-3287

Important Safety Instructions

Read all instructions before using this appliance.
Save these instructions for future reference.

This manual contains important safety symbols and instructions. Please pay attention to these symbols and follow all instructions given.

Do not attempt to install or operate your appliance until you have read the safety precautions in this manual. Safety items throughout this manual are labeled with a **WARNING** or **CAUTION** statement based on the risk type.

DEFINITIONS

This is the safety alert symbol. It is used to alert you to potential personal injury hazards. Obey all safety messages that follow this symbol to avoid possible injury or death.

⚠ WARNING

Indicates a potentially hazardous situation which, if not avoided, may result in death or serious injury.

⚠ CAUTION

Indicates a potentially hazardous situation which, if not avoided, may result in minor or moderate injury.

IMPORTANT! Indicates installation, operation, maintenance, or valuable information that is not hazard related.



General Information, Important, Hints and Tips

Indicates useful information to avoid malfunctions and is also used for hints and tips how the appliance works in the best way. Information icon followed by supporting text.

⚠ WARNING

Storage In or On Appliance—Flammable materials should not be stored in an oven or near surface units. This includes paper, plastic, and cloth items, such as cookbooks, plastic ware, and towels, as well as flammable liquids. Do not store explosives, such as aerosol cans, on or near the oven.

⚠ WARNING

Do Not Leave Children Alone - Children should not be left alone or unattended in the area where appliance is in use. They should never be allowed to sit or stand on any part of the appliance, including the storage drawer, lower broiler drawer, warmer drawer, or lower double oven.

⚠ WARNING

Never cover any slots, holes, or passages in the oven bottom or cover an entire oven rack with materials, such as aluminum foil. Aluminum foil linings may trap heat, causing a fire hazard.

⚠ WARNING

Tip Over Hazard

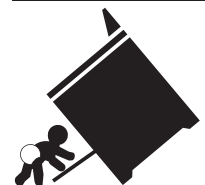

- A child or adult can tip the oven and be killed.
- Install the anti-tip device to oven and/or structure per installation instructions.

- Ensure the anti-tip device is re-engaged when the oven is moved.
- Do not operate the oven without the anti-tip device in place and engaged.
- Failure to follow these instructions can result in death or serious burns to children and adults.

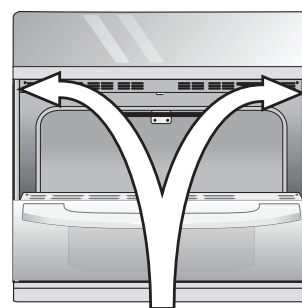

Anti-tip mounting holes

Refer to the installation instructions supplied with your appliance for proper installation.

Check for proper installation with a visual check that the anti-tip screws are present. Test the installation with light downward pressure on the open oven door. The oven should not tip forward.

⚠ WARNING

Stepping, leaning, or sitting on the door or drawers of an oven can result in serious injuries and also cause damage to the appliance. Do not allow children to climb or play around the oven. The weight of a child on an open oven door may cause the oven to tip, resulting in serious burns or other injury.

⚠ CAUTION

Wear proper apparel. Loose-fitting or hanging garments should never be worn while using this appliance. Do not let clothing or other flammable materials come into contact with hot surfaces.

⚠ CAUTION

Do not heat unopened food containers. Build-up of pressure may cause container to burst and result in injury.

⚠ CAUTION

Do not use water or flour on grease fires. Smother fire or flame or use dry chemical or foam-type extinguisher. Cover the fire with a pan lid or use baking soda.

Important Safety Instructions

⚠ CAUTION

Use dry potholders. Moist or damp potholders on hot surfaces may result in burns from steam. Do not let potholders touch hot cooking areas. Do not use towels or other bulky cloths.

⚠ CAUTION

Do not store items of interest to children in the cabinets above a range or on the backguard of the range. Children climbing on the range to reach items could be seriously injured.

⚠ CAUTION

When heating fat or grease, watch it closely. Grease may catch fire if it becomes too hot.

IMPORTANT! Important Safety Notice - The California Safe Drinking Water and Toxic Enforcement Act requires the governor of California to publish a list of substances known to cause cancer, birth defects, or other reproductive harms, and it requires businesses to warn customers of potential exposures to such substances.

⚠ CAUTION

Read and follow the below instructions and precautions for unpacking, installing, and servicing your appliance:

- Remove all tape and packaging before using the oven. Destroy the carton and plastic bags after unpacking the oven. Never allow children to play with packaging material.
- Proper Installation—Be sure your appliance is properly installed and grounded by a qualified technician in accordance with the National Electrical Code ANSI/NFPA No. 70 latest edition and local electrical code requirements. In Canada, install in accordance with CSA Standard C22.1, Canadian Electrical code, Part 1, and local electrical code requirements. Install only per installation instructions provided in the literature package for this oven.
- User Servicing—Do not repair or replace any part of the appliance unless specifically recommended in the manuals. All other servicing should be done only by a qualified technician. This reduces the risk of personal injury and damage to the oven.
- Ask your dealer to recommend a qualified technician and an authorized repair service. Know how to disconnect the power to the oven at the circuit breaker or fuse box in case of an emergency.
- Never modify or alter the construction of an oven by removing the leveling legs, panels, wire covers, anti-tip brackets/screws, or any other part of the oven.
- Remove the oven door from any unused oven if it is to be stored or discarded.
- Be sure to have an appropriate foam-type fire extinguisher available, visible, and easily located near the appliance.
- Do not attempt to operate the oven during a power failure. If the power fails, always turn off the oven. If the oven is not turned off and the power resumes, the oven will begin to operate again. Once the power resumes, reset the clock and oven function.
- Cold temperatures can damage the electronic control. When using this appliance for the first time, or when the appliance has not been used for an extended period of time, be sure the appliance has been in temperatures above 32°F (0°C) for at least 3 hours before turning on the power to the appliance.

IMPORTANT INSTRUCTIONS FOR USING YOUR OVEN

- Never use your appliance for warming or heating the room.
- Use care when opening oven door, lower oven door, or warmer drawer (some models). Stand to the side of the oven when opening the door of a hot oven. Let hot air or steam escape before you remove or replace food in the oven.
- Keep oven vent ducts unobstructed. Touching surfaces in this area when the oven is on may cause severe burns. Do not place plastic or heat-sensitive items on or near the oven vent. These items can melt or ignite.
- Placement of Oven Racks - Always place oven racks in desired location while oven is cool. If rack must be moved while oven is hot, do not let potholder contact hot heating element in oven. Use potholders and grasp the rack with both hands to reposition. Remove all bakeware and utensils before moving the rack.
- Do not use a broiler pan without its insert. Broiler pans and inserts allow dripping fat to drain away from the high heat of the broiler. Do not cover the broiler insert with aluminum foil; exposed fat and grease could ignite.
- Protective Liners - Do not use aluminum foil to line oven bottoms, except as suggested in the manual. Improper installation of these liners may result in a risk of electric shock, or fire.
- Do not cook food on the oven bottom. Always cook in proper bakeware and always use the oven racks.

Save these instructions for future reference.

Important Safety Instructions

IMPORTANT INSTRUCTIONS FOR CLEANING YOUR OVEN

⚠ CAUTION

Before manually cleaning any part of the oven, be sure all controls are turned off and the oven is cool. Cleaning a hot oven can cause burns.

Clean the oven regularly to keep all parts free of grease that could catch fire. Do not allow grease to accumulate.

Always follow the manufacturer's recommended directions for use of kitchen cleaners and aerosols. Be aware that excess residue from cleaners and aerosols may ignite causing damage and injury.

Clean ventilating hoods frequently. Grease should not be allowed to accumulate on the hood or filter. Follow the manufacturer's instructions for cleaning hoods.

SELF-CLEANING OVENS

- Clean only the parts listed in this manual. Before using self-clean, remove the broiler pan, any food, utensils, and bakeware from the oven. Remove oven racks unless otherwise instructed.
- Do Not Use Oven Cleaners. No commercial oven cleaner or oven liner protective coating of any kind should be used in or around any part of the oven.
- Do Not Clean Door Gasket. The door gasket is essential for a good seal. Care should be taken not to rub, damage, or move the gasket.
- Some birds are extremely sensitive to the fumes given off during the self-clean cycle of any oven. Move birds to another well-ventilated room.

⚠ CAUTION

DO NOT TOUCH HEATING ELEMENTS OR INTERIOR SURFACES OF OVEN - Heating elements may be hot even though they are dark in color. Interior surfaces of an oven become hot enough to cause burns. During and after use, do not touch, or let clothing or other flammable materials contact heating elements or interior surfaces of oven until they have had sufficient time to cool. Other surfaces of the appliance may become hot enough to cause burns - among these surfaces are (identification of surfaces - for example, oven vent openings and surfaces near these openings, oven doors, and windows of oven doors).

GROUNDING INSTRUCTIONS

⚠ WARNING

Avoid fire hazard or electrical shock. Failure to follow this warning may cause serious injury, fire, or death.

This appliance must be supplied with the proper voltage and frequency, and connected to an individual, properly grounded branch circuit, protected by a circuit breaker or fuse.

It is the responsibility and obligation of the consumer to contact a qualified installer to assure that the electrical installation is adequate and is in conformance with all local codes and ordinances.

See the installation instructions packaged with this appliance for complete installation and grounding instructions.

Save these instructions for future reference.

BEFORE SETTING OVEN CONTROLS

Oven Vents

The oven vent is located under the control panel. When the oven is on, warm air passes through this vent. This venting is necessary for proper air circulation in the oven and good baking results. Do not block oven vent. Steam or moisture may appear near the oven vent. This is normal.

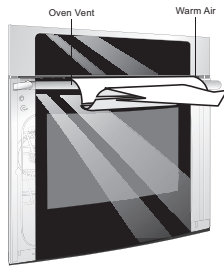

Figure 1: Oven vent location



Some models are equipped with a cooling fan that runs during the cooking process to cool internal electronic components. It is normal for this fan to continue to run for an extended period of time, even when the oven is off.

CAUTION

Do not line the oven walls, racks, bottom, or any other part of the oven with aluminum foil. Doing so will alter heat distribution, produce poor baking results, and may cause permanent damage to the oven interior. During fresh clean temperatures, the oven will be hot enough to melt foil.

Oven Rack Supports

CAUTION

Always use potholders or oven mitts when removing food or adjusting the oven racks. Wait until the oven is completely cooled if possible. Oven racks may be very hot and may cause burns.

To install oven rack supports:

CAUTION

Always install the oven rack support before turning on the oven (when the oven is cool). To aid installation of the oven rack supports, apply a thin layer of cooking oil to all the prongs of the supports (Figure 2)

1. Hold the oven rack support at a slight angle and insert prongs into the holes at the top of the oven cavity (Figure 3).
2. Lift the rack into the top holes, aligning the bottom prongs with the bottom holes (Figure 3).
3. Once the upper prongs are in place, hold the oven rack support flush with the oven side and insert the bottom prongs into the bottom holes (Figure 4).
4. Slide the bottom prongs down into the lower holes. Some force may be required to set the rack into place (Figure 4).

IMPORTANT! To remove the ladder rack support for a self-clean cycle, reverse the order used when installing the ladder rack supports.

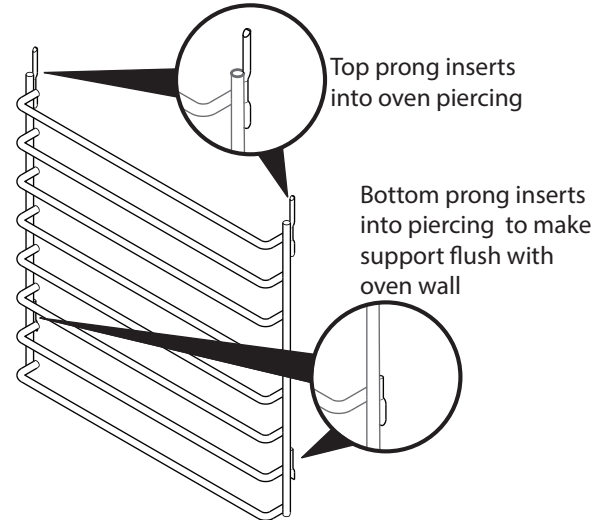

Figure 2: Rack prongs for insertion into holes.

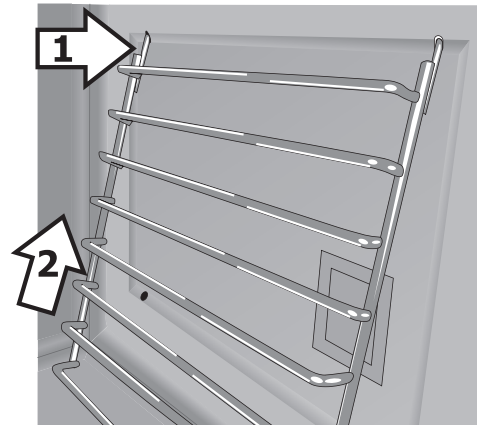

Figure 3:

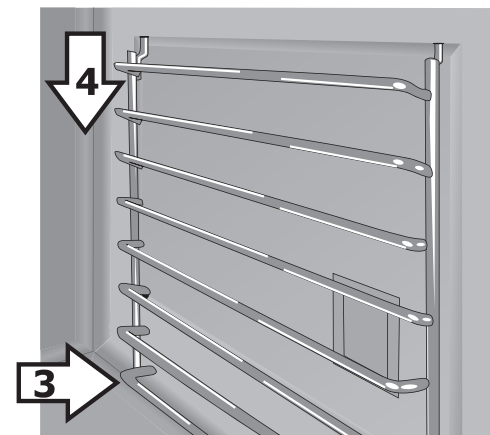

Figure 4:

Arranging, Removing, and Replacing Flat or Offset Oven Racks

- To Arrange: Always arrange the oven racks when the oven is cool (prior to operating the oven).
- To Remove: Pull the oven rack straight forward until it reaches the stop position. Lift up front of oven rack slightly and slide out.
- To Replace: Place the oven rack on the rack guides on the oven walls. Tilt the front of the rack upward slightly and slide the oven rack back into place.

Types of Oven Racks

Flat Oven Rack

Flat oven racks (or the flat handle oven rack) may be used for most cooking needs and may be placed in most oven rack positions.

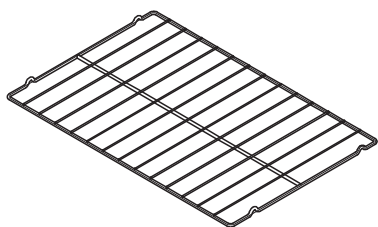

Figure 5: Flat oven rack

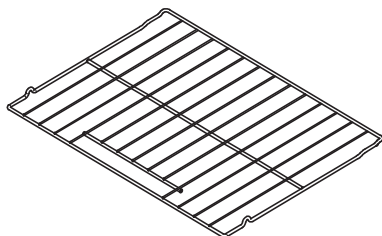

Figure 6: Flat handle oven rack

Offset Oven Rack (Some Models)

The offset oven rack provides additional stepdown positions from the standard flat rack design. The offset design positions the base of the rack about 1/2 of a rack position lower than the flat rack and may be used in most oven rack positions.

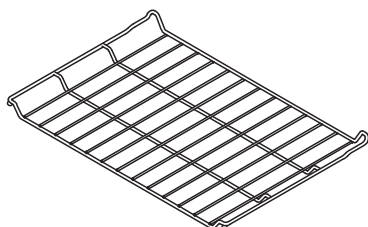

Figure 7: Offset oven rack

Luxury Glide™ Oven Racks

The fully extendable Luxury-Glide™ rack makes food preparation easier. This oven rack has glide tracks that allow the rack to be pulled away from the oven without rubbing the sides of the oven wall.

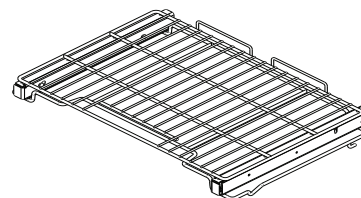

Figure 8: Luxury Glide™ rack showing glide stop

To install the Luxury-Glide™ oven racks:

⚠ CAUTION

Always use potholders or oven mitts when removing food or adjusting the oven racks. Wait until the oven is completely cooled if possible. Oven racks may be very hot and may cause burns.

⚠ CAUTION

Always remove/replace the oven racks before turning on the oven (when the oven is cool).

The Luxury-Glide™ rack installs like all other oven racks. Before sliding the rack all the way in, lift the back of the rack slightly to set the rack past the stop position. Slide the rack all the way in so that the back of the rack stops by touching the vertical support of the ladder rack. The glide portion of the rack can be easily pulled in and out in this position while the rack's frame remains locked into the ladder supports. This allows bakeware to remain in place on the rack and slide out easily to check food items without removing them from the oven.

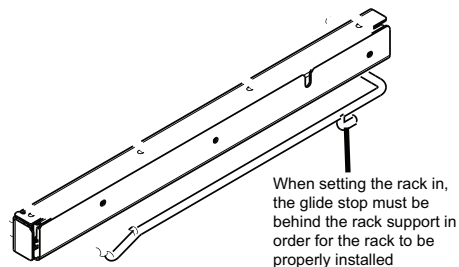

Figure 9: Luxury Glide™ rack install

IMPORTANT! To prevent possible damage to the oven, do not attempt to close the oven door until all the oven racks are fully positioned back inside the oven cavity.

i

Clean oven racks according to the instructions provided in the Care & Cleaning section.

SETTING OVEN CONTROLS

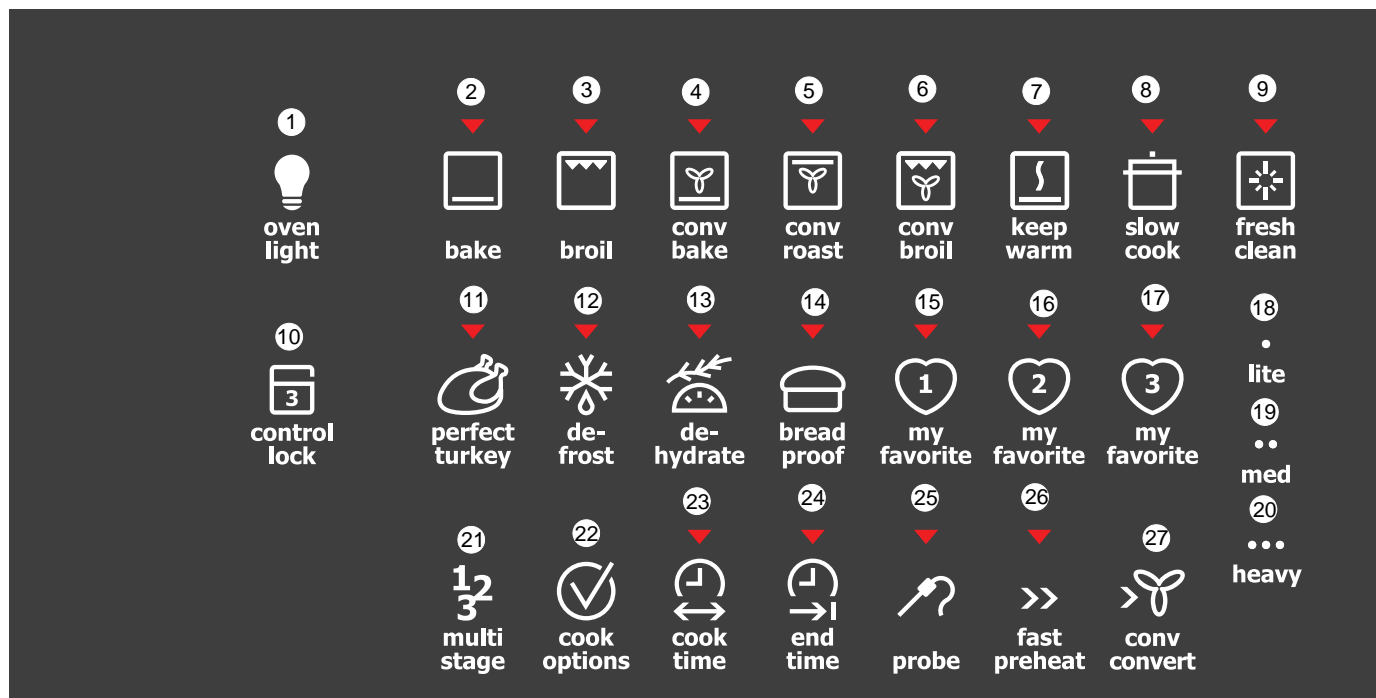

1. **Oven Light¹** - Use to turn the internal “theater” style oven light on and off.
2. **Bake** - Use to enter the normal baking mode temperature and start a normal bake function, at any temperature from 170°F to 550°F (76°C to 288°C).
3. **Broil** - Use to select the broil function, at any temperature from 300°F to 550°F (148°C to 288°C).
4. **Conv Bake** - Use to select the convection baking function, which is used to obtain the best culinary results when baking with multiple pans and racks at any temperature from 170°F to 550°F (76°C to 288°C).
5. **Conv Roast** - Use to select the convection roasting function, best for cooking tender cuts of beef, lamb, pork, and poultry. Use this mode when cooking speed is desired at any temperature from 170°F to 550°F (76°C to 288°C).
6. **Conv Broil** - Use to select the convection broil function, best for thicker cuts of meat, fish, and poultry. Uses the broil element and a fan to circulate heat evenly and continuously at any temperature from 300°F to 550°F (148°C to 288°C).
7. **Keep Warm** - Use to select the keep warm function, best for keeping oven cooked foods warm after cooking has finished at any temperature from 150°F to 190°F (66°C to 86°C).
8. **Slow Cook** - Use to select the slow cook function, which cooks food more slowly, at lower temperatures and provides cooking results much the same way as a Slow Cooker or Crock-Pot.
9. **Fresh Clean** - Use to select the fresh cleaning function.
10. **Control Lock²** - Use to disable all oven functions by locking the oven door and control panel.
11. **Perfect Turkey** - Use to select the perfect turkey function, which uses the meat probe to control precisely the cooking of a perfect turkey using the convection system to brown the exterior and seal in the juices.
12. **Defrost** - Use to select the defrost function, which is used to thaw small portions of delicate items such as cream cakes, frozen cream pies, and cheesecake at room temps.
13. **Dehydrate** - Use to select the dehydrate function, which dries foods with heat from the bake and the convection elements, circulating heat throughout the oven by the convection fan.
14. **Bread Proof** - Use to select the bread proof function, which prepares the dough for baking by activating the yeast.
15. **My Favorite 1** - Use each of the three my favorite function keys to save your most used and complex cooking sequences, spanning cooking mode, target temperature, and cook time (if any).
16. **My Favorite 2** - The oven can recall up to three cooking sequences from its internal memory. Use the second my favorite function key to save or recall your second pre-programmed cooking sequence.
17. **My Favorite 3** - Use the third my favorite function key to save or recall your third pre-programmed cooking sequence.
18. **Lite (Fresh Clean Cycle)** - Use to start a 2-hour fresh clean cycle.
19. **Med (Fresh Clean Cycle)** - Use to start a 3-hour fresh clean cycle.
20. **Heavy (Fresh Clean Cycle)** - Use to start a 4-hour fresh clean cycle.

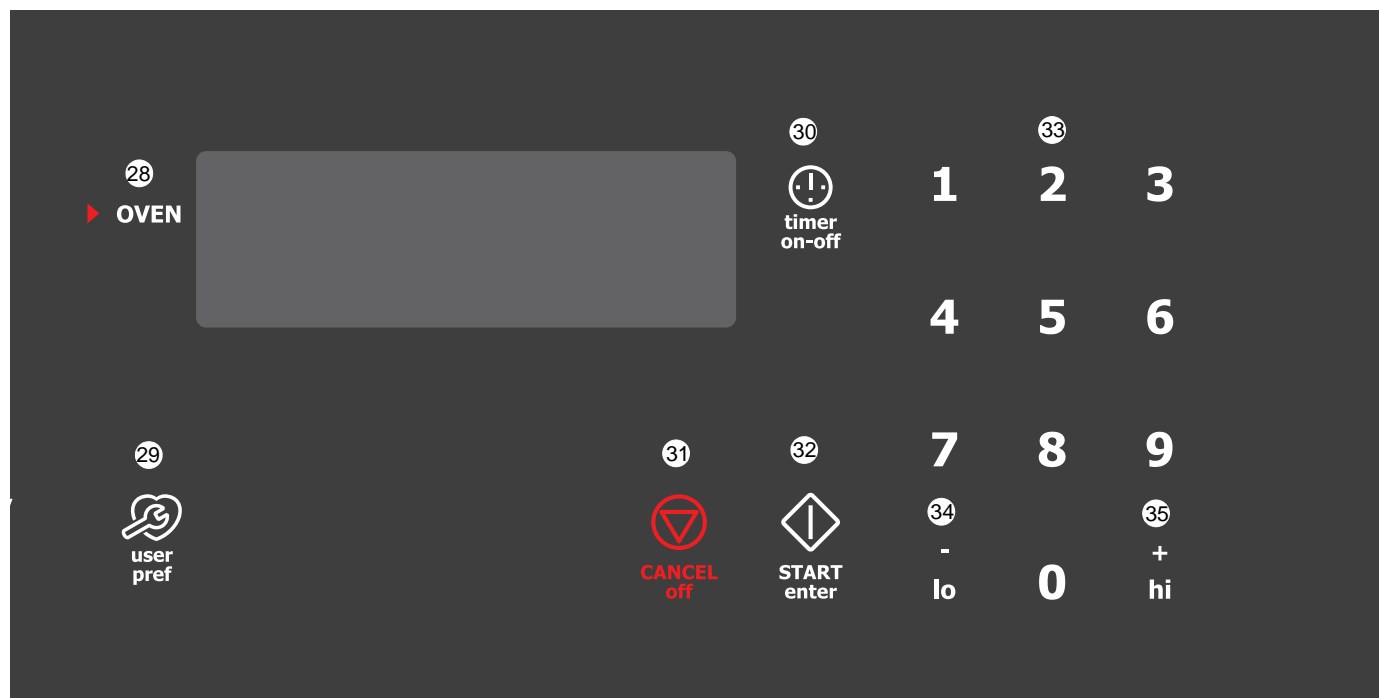

- 21. Multi Stage** - Use to enter up to three subsequent functions, to program a queue of up to three cooking modes with individual cooking times and temperatures.
- 22. Cook Options** - Use to light up the cooking options functions, such as cook time.
- 23. Cook Time** - Use to set a cooking duration time with an auto shut off.
- 24. End Time** - Use to select the time at which the cooking will end. It allows the oven to be set to shut off automatically at a set time of the day.
- 25. Probe** - Use to activate the meat probe function, enabling you to test internal food temperature at any temperature from 130°F to 210°F (54°C to 98°C).
- 26. Fast Preheat** - Use to preheat the oven quickly to any temperature from 170°F to 550°F (76°C to 288°C).
- 27. Conv Convert** - Use to convert a standard baking recipe temperature to a temperature for convection baking.
- 28. Oven** - Use to light up the available cooking modes functions.
- 29. User Pref** - Use to bring the user preference menu in the display. Available when the oven is not being used, use this function to set such options as time of day, audio control, and many more.
- 30. Timer On-Off** - Use to set or cancel the minute timer. The minute timer does not start or stop cooking.
- 31. CANCEL Off** - Use to cancel any function previously entered except the time of day and minute timer. Push the **CANCEL off** key to stop cooking.
- 32. START Enter** - Use to start all oven functions.
- 33. 0 thru 9** - Use to enter temperature and times.
- 34. -lo** - Use to lower the temperature and times. This key is used in conjunction with the **+hi** key to set the Sabbath feature.
- 35. +hi** - Use to raise the temperature and times. This key is used in conjunction with the **-lo** key to set the Sabbath feature.



Over Control Footnotes

1. The oven light key will appear on the left-hand side of the oven control on 30" models, and it will appear on the right-hand side of the oven control on 27" models.
2. The control lock key will appear on the left-hand side of the oven control on 30" models, and it will appear on the right-hand side of the oven control on 27" models.

Control and Time Settings

Table 1: Minimum and maximum control settings

Feature	Minimum Temp	Maximum Temp
Fast Preheat	170°F (76°C)	550°F (288°C)
Bake	170°F (76°C)	550°F (288°C)
Broil	300°F (148°C)	550°F (288°C)
Conv Bake	170°F (76°C)	550°F (288°C)
Conv Roast	170°F (76°C)	550°F (288°C)
Conv Broil	300°F (148°C)	550°F (288°C)
Keep Warm	150°F (66°C)	190°F (88°C)
Slow Cook	Lo 225°F (108°C)	Hi 275°F (135°C)

Table 2: Minimum and maximum time setting

Feature	Minimum Time	Maximum Time
Timer	1 min	11 hr 59 min
Clock 12 hour	1:00 hr	11 hr 59 min
Clock 24 hour	0:00 hr	23 hr 59 min
Cook time 12 hour	1 min	11 hr 59 min
End time 12 hour	1:00 hr	12 hr 59 min
End time 24 hour	0:00 hr	23 hr 59 min
Clean Duration	(2 hr)	(4 hr)

Wave-Touch™ Display Modes

Your control is in a sleep mode when not in use. Only the clock time will display during this mode.

To go to the Awake mode:

To awaken the control, touch within the display panel (Figure 10). If the control panel is not touched again within 2 minutes, the control will return to the sleep mode. User preferences are available during the awake mode as well as timers, oven light and the control lock.

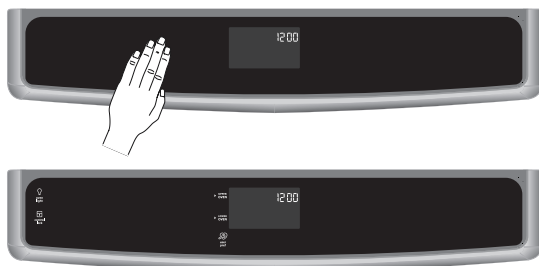

Figure 10: Activating the awake mode

Setting the User Preferences

The User Preferences menu includes all user defined options. This feature enables you to control the various options of the electronic controls. This menu features the Time of Day, Celsius or Fahrenheit display mode, Continuous Bake or 12 Hour Energy Saving modes, Clock display or No-Clock display, 12 Hours Time of Day or 24 Hours Time of Day, Audio Control, and Adjusting the oven temperature. The User Preferences menu is only available when the oven is not on.

To browse through the User Preferences menu:

- To bring up the User Preferences menu, press **user pref**.
- Press **user pref** again to browse through the menu pages and select the feature you wish to adjust.
- Press **+hi** or **-lo** to toggle through a feature's available choices, which can include the ability to increase or decrease the numeric values. You may also use the numeric keypad to input precise values.
- Press **START enter** to accept a new option entry or press **user pref** to advance to the next preference.
- Press **CANCEL off** to save your entries and exit the user preferences mode.



Setting the Clock-Time of Day

When the appliance is powered up for the first time or when the electric supply to the appliance has been interrupted, the display will flash **12:00** (Figure 11). Before any function of the oven can be set, **CANCEL off** must be pressed. This will set the clock at 12:00. To set the clock for the actual time the **user pref** key must first be pressed to bring the oven to the clock mode. Be sure to set the correct time on the clock before using the oven, especially if cooking with added time instructions.



Figure 11: 12:00 initial display

To set the clock time (example: 1:30):

1. Press **user pref**. **CLO 1200** appears in the display.
2. Enter **1 3 0** using the numeric keypad.
3. Press **START enter** to accept the new time.
4. Press **CANCEL off** to exit the user preferences menu.



i The clock cannot be adjusted while the oven is cooking, the timer is active, or during a fresh clean cycle.

i If an invalid time is entered, the control sounds an error tone, a chime. Re-enter a valid time and press **START enter**. Pressing **CANCEL off** automatically sets for **12:00**.

Setting the Clock Display-On or Off

The clock display mode allows you to turn the clock display on or off.

To set the clock display:

1. Press **user pref** until **preset clock display** mode appears (Figure 12).
2. Use **+hi** or **-lo** to toggle to the **CLO off** option.
3. Press **START enter** to accept, then **CANCEL off** to exit the preferences mode.



Figure 12: Clock on (L) or off (R) display

i User preference options are not available while using any cooking function, when using the kitchen timer, or during fresh clean.

Setting 12 or 24 Hour Display Mode

The oven control is factory preset to display the time of day in the 12-hour clock setting. The display can be changed to a 24 hour clock setting or to the OFF mode.

When the clock display is turned off, it continues to run and will function based on the previously set 12 or 24-hour setting.

To change clock display modes:

1. Press **user pref** until the preset **12hr clock display** mode appears (Figure 13).
1. Use **+hi** or **-lo** to toggle to the **24hr** option (Figure 13).
2. Press **START enter** to accept, then **CANCEL off** to exit the preferences mode.



Figure 13: Clock 12 hour (L) or 24 hour (R) display

i You cannot change the clock display mode while the oven is active with any cooking function or during fresh clean.

Changing Oven Temperature Display-Fahrenheit (°F) or Celsius (°C)

The oven control can be programmed to display temperatures in °F or °C. The oven has been preset at the factory to display in °F

To change the temperature display mode:

1. Press **user pref** key until **F-C F** appears in display (Figure 14).
2. Use **+hi** or **-lo** to toggle between the **F** or **C** option.
3. Press **START enter** to accept.
4. Press **CANCEL off** to exit the preferences mode.



Figure 14: F or C selection



You cannot modify the oven temperature display while oven is active with any cooking function or during fresh clean operation.

Changing Between 12-Hour Energy Saving or Continuous Bake Mode Settings

The oven control is factory preset for a 12-hour Energy Saving mode. This setting automatically turns off any oven function after 11 hours and 59 minutes of non-stop cooking. The control may be set to override this feature if there is a need for cooking beyond 12 hours.

To change between 12 Hour Energy Saving and continuous bake settings:

1. Press **user pref** until **ES on** or **ES off** appear in the display.
2. Press **+hi** or **-lo** again to toggle between **ES on** or **ES off**.
3. Press **START enter** to accept the desired setting, then **CANCEL off** to exit the preferences mode.



Setting Silent or Audible Control Mode

The audio control feature allows you to control the audio volume for the oven control. You may turn the audio off and later return to operating with all the normal audible sounds and alerts. A tone sounds when a key is pressed and also at the end of a cycle (timer, cook time, or end time).

The factory audio setting is preset to level 5 (Figure 15). The volume can be adjusted for lower levels from 5 through 1, or it can be turned off for a silent control setting (Figure 15).

To adjust the audio tone level:

1. Press **user pref** until **AUD 5** appears (Figure 15).
2. Use **+hi** or **-lo** to toggle from **5** down to **1**, or to the **off** option for desired level.
3. Press **START enter** to accept the new audio level, then press **CANCEL off** to exit the preferences mode.



Figure 15: Audio level adjust on (L) or off (R)



When the control is set for AUD off, error tones will remain audible.

Oven/Control Lock

The control lock feature automatically locks the oven door and the control panel. The Control Lock is only allowed when the oven is turned off (not active). The door lock icon will flash in the display for 20 seconds or until the door has finished locking. Both doors will lock at the same times. Do not attempt to open the oven door while the door lock icon is flashing.

To activate control lock:

1. Press and hold **control lock** for three seconds. The time of day will be visible.



To cancel the control lock feature:

Press and hold **control lock** for three seconds. Once unlocked, the door lock icon will no longer appear.



If **OVEN** is pressed when oven lock is active, the oven will sound an error tone (a chime) indicating the function is not available until the control lock feature is turned off.

Timer

This unit is equipped with a kitchen timer which serves as an extra timer in the kitchen that will chime when the set time has run out. This timer can help timed cooking or food preparation times without interfering with any active cooking process. It does not start or stop cooking. When the time countdown reaches less than 1 minute, the display will show the time remaining in seconds. The timer feature can be used during any of the other oven control functions and cooking modes.

To set the timer for 5 minutes:

1. Press **timer on-off**. **0:00** will appear in the display.
2. Press 5 on the numeric keypad to set the timer to 5 minutes. The **lo** or **hi** keys may be pressed to raise or lower the actual time displayed.
3. Press **timer on-off** again to accept and start the countdown.
4. When the set time runs out, **0:00** will be displayed, and **timer on-off** will flash. The clock will sound a chime that will be repeated at regular intervals until **timer on-off** is pressed.



To cancel the timer before the set time has run out:

- Press **timer on-off**. The display will return to the time of day.



Temperature Visual Display

Your oven is equipped with a temperature visual display for each oven. When a cooking mode is set, the actual temperature will display in the user interface window and will rise as the unit preheats. When the unit reaches the set temperature, a chime will sound to remind you to place the food in the oven. This feature is active with bake, convection bake, and convection roast.



The lowest temperature that will display is 100°F (38°C).

Interior Oven Lights

Your appliance is equipped with four halogen lights and includes "theater" style oven lighting feature that gradually lights the oven interiors to full brightness. The oven lights will turn on automatically when the oven door is opened.

The Two Dual Left/Right Corner Oven Lights

The interior oven lights are located at the rear of the oven cavity and are covered with a glass shield. The glass shield must be in place whenever the oven is in use.

The Two Dual Left/Right Side Oven Lights

An interior oven light will turn on automatically when the oven door is opened.

The oven lights may be turned on when the door is closed by using the oven light key located on the control panel.

To toggle the oven lights on and off:

- Press **oven light**.



FAST PREHEAT

The oven can be programmed to preheat in the following modes: bake, convection bake, and convection roast. When activated, the oven will begin preheating quickly and **PRE-HEATING** will appear in the display. The minimum temperature shown is 100°F (38°C). A tone will sound to indicate the oven has finished preheating and **PRE-HEATING** will disappear from the display. Once the oven has fully preheated, the fast preheat feature will perform like bake and continue to bake until cancelled. For optimum performance, use Fast Preheat with convection bake only.

IMPORTANT! The rapid preheat feature is for single rack baking only. The heat distribution with multiple rack will be uneven. Use a glide rack in position 3, or in the center of the oven.

IMPORTANT! For batter- and dough-based baked goods such as cakes, pastries, and breads, use the convection bake function.

To set Fast Preheat using the default oven temperature:

CAUTION

Always use pot holders or oven mitts when working with a hot oven. When baking, the oven interior and oven racks will become hot enough to cause burns.

1. Press **OVEN** to light up the available cooking modes keys.
2. Press **bake, conv bake, or conv roast.**
3. Press **cook options.**
4. Press **fast preheat.**
5. Press **START enter.**



i Preheating is not necessary when roasting or cooking casseroles.

i The convection fan will rotate when the fast preheat is started. This is normal. If fast preheat is set with the bake feature the convection fan will turn off once the oven set temperature is reached.

i To change temperature settings after fast preheat has started, press the **+hi** or **-lo** keys to increase or decrease the oven temperature. The oven temperature will change by 5° (F) with each press of **+hi** or **-lo**.

To set fast preheat with an oven temperature of 425°F (218°C):

CAUTION

Always use pot holders or oven mitts when working with a hot oven. When baking, the oven interior and oven racks will become hot enough to cause burns.

1. Press **OVEN** to light up the available cooking modes keys.
2. Press **bake, conv bake, or conv roast.**
3. Enter **4 2 5** using the numeric keypad.
4. Press **cook options.**
5. Press **fast preheat.**
6. Press **START enter.**

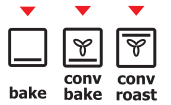

425



i To stop fast preheat at any time, press **CANCEL off**.

BAKE

Bake may be set with these options: 1) fast preheat; 2) cook time; or 3) delayed start, achieved through using the cook time and end time settings.



The meat probe can be used in this mode.

To set the oven for bake at the default oven temperature of 350°F (176°C):

CAUTION

Always use pot holders or oven mitts when working with a hot oven. When baking, the oven interior and oven racks will become hot enough to cause burns.

CAUTION

Do not bake foods directly on the oven bottom. To avoid damaging the oven interior and surfaces, always bake foods in the oven using bakeware positioned on an oven rack.

- For best results, single rack baking is recommended. Fully preheat oven. Place food in rack position 3 or in center of oven (Figure 16) using a glide rack and place pans as shown in Figure 17.
- Press **OVEN** to light up the available cooking modes keys.
- Press **bake**. The default oven temperature of 350°F (176°C) appears in the display.



- Press **START enter**.



- When Bake is active the oven begins to preheat. The display will show **PRE-HEATING** and the convection fan will run until preheating is complete. When the oven reaches the set temperature, the control sounds a tone to signal the oven is ready.
- To stop bake at any time, press **CANCEL off**.

To set bake with oven temperature of 425°F(218°C):

- Press **OVEN** to light up the available cooking modes keys.
- Press **bake**.



- Enter **4 2 5** using the numeric keypad.
- Press **START enter**. To add or change any bake settings once the oven is baking, make temperature changes using the **+hi** or **-lo** keys. Each press will adjust the temp by ±5°F (±2°C).
- To stop bake at any time, press **CANCEL off**.



The convection fan will rotate when bake first starts. This is normal. The fan will turn off once the oven reaches the set temperature.



If bake is active without a cook time setting, the oven will remain on for 12 hours before turning off automatically unless it is cancelled. To bake longer than 12 hours, see ["Changing Between 12-Hour Energy Saving or Continuous Bake Mode Settings"](#) on page 12 for instructions.

Baking Tips

- Fully preheat the oven before baking items like cookies, cakes, biscuits, or breads.
- When using a single rack for baking, position the rack so that the food is in the center of the oven.
- For best results when baking cakes using two oven racks, place bakeware on oven rack positions 2 and 7 (Figure 16) and place pans as shown in Figure 17. Use glide rack in position 2 and a flat rack in position 7.
- Use positions 2 and 7 when baking cookies on multiple pans. Use glide rack in position 2 and a flat rack in position 7.
- Allow at least 2 inches (5 cm) of space between bakeware for proper air circulation.
- Dark or dull pans and glass absorb more heat than shiny bakeware resulting in dark or over browning of foods. To prevent this it may be necessary to reduce the oven temperature or cook time to prevent over browning of some foods. Dark pans are recommended for pies. Shiny pans are recommended for cakes, cookies and muffins.
- Do not open the oven door too often. Opening the door will reduce the temperature in the oven.
- For cakes, pastries, and breads, use the convection bake function for best results when using multiple racks.

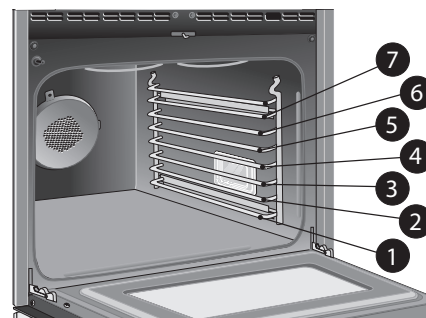

Figure 16: Rack positions

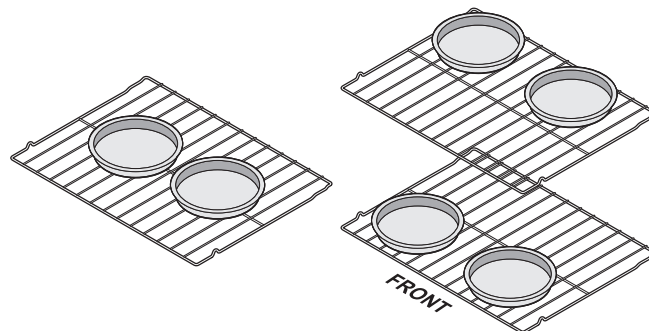

Figure 17: Single rack pan spacing (L), Double spacing (R)

Cook Time

Cook time is used when a recipe calls for a specific temperature and cook time. Follow the recipe's suggested cook time can help ensure the best possible results. Cook time allows the oven to be set to cook for a set length of time and shut off automatically. The maximum cook time is 11 hours, 59 minutes. The time remaining will always be shown in the timer section of the display. This feature can be used with bake, convection bake, convection roast, keep warm, defrost, bread proof, and dehydrate. It can also be part of a multi stage sequence.

To bake for 30 minutes with the oven at default temperature setting of 350°F (176°C):

WARNING

Food Poisoning Hazard. Do not let food sit for more than one hour before or after cooking. Doing so can result in food poisoning or sickness. Foods that can easily spoil such as milk, eggs, fish, meat, or poultry should be chilled in the refrigerator first. Even when chilled, they should not stand in the oven for more than 1 hour before cooking begins and should be removed promptly when finished cooking. Eating spoiled food can result in sickness from food poisoning.

CAUTION

Use caution with the cook time or end time features. Use the automatic timer when cooking cured or frozen meats and most fruits and vegetables.

1. Press **OVEN** to light up the available cooking modes keys.

2. Press **bake**.



3. Press **cook options**.



4. Press **cook time**.



5. Enter **3 0** using the numeric keypad.



6. Press **START enter**. The oven starts heating. Cook time will start counting down for the set time.

7. **End** will appear in the display window and the oven will shut off automatically when the time runs out. The control will chime and repeat the end tones every 10-15 seconds until **CANCEL off** is pressed. To stop cooking, press **CANCEL off**.



To change cook time while cooking, press **cook time**, then use **lo** or **hi** to adjust the time, and then press **START enter** to finish.

Setting Cook Time with End Time

End time allows the oven to be set to shut off automatically at a set time of day. The oven control will calculate the remaining time by itself. The time remaining will always be shown in the timer section of the display. The oven will shut off and chime when the countdown is finished. This feature can be used with bake, convection bake, convection roast, slow cook, keep warm, defrost, dehydrate, and bread proof. This oven can be programmed with cook time and end time to start and stop by itself at the right time. Before setting end time, be sure the time of day is set correctly on the oven clock.

To set the oven to bake at 375°F (191°C) for 50 minutes and to automatically shut off at 5:30:

1. Press **OVEN** to light up the available cooking modes keys.

2. Press **bake**.



3. Enter **3 7 5** using the numeric keypad.

375

4. Select **cook options**.



5. Press **cook time**.



6. Enter **5 0** using the numeric keypad.

50

7. Press **end time**



8. Enter **5 3 0** using the numeric keypad.

530

9. Press **START enter**



10. **End** will appear in the display window and the oven will shut off automatically when the time runs out. The control will chime and repeat the end tones every 10-15 seconds until **CANCEL off** is pressed. To stop cooking, press **CANCEL off**.



Once **START enter** is pressed, the oven will calculate the delayed start time. When the oven reaches the delayed starting time, the oven will automatically turn on and heat to the set temperature. The oven will maintain the set temperature throughout the set cook time until the set end time cancels the cooking function.

To change temperature settings during the cooking process, use the **+hi** or **-lo** keys to increase or decrease the oven temperature. The oven temperature will change by 5° (F) with each press of the **+hi** or **-lo** key.

Broil

Broiling is a method of cooking tender cuts of meat by direct heat under the broil element of the oven. This mode is best for meats, fish, and poultry up to 1" thick. The meat probe cannot be used with this mode. Depending on cooking preferences, you can increase or decrease cooking times or move food to a different rack position. If the food you are broiling is not listed in [Table 3](#), follow the instructions provided in your cookbook and watch the item closely.

To broil with default broil oven temperature of 550°F (288°C):

1. Arrange interior oven racks and place the broiler insert on the broiler pan, then place the meat on the insert. Remember to follow all warnings and cautions ([Figure 18](#)).
2. Press **oven** to light up the available cooking modes keys.

3. Press **broil**. The display will show **5 5 0**.



broil

4. Press **START enter**. To change temperature settings, use the **+hi** or **-lo** keys to increase or decrease the oven temperature. The oven temperature will change by 5°F with each press of **+hi** or **-lo**.
5. Place food in the oven after 2 minutes to rack position recommendations ([Table 3](#)) and ([Figure 19](#)). Be sure to place pan with the meat directly under the broil element and close the oven door during broiling.
6. Turn food when the top side is browned and cook on the second side.



START enter

7. Press **CANCEL off** to stop the broil feature.



CANCEL off

⚠ WARNING

If an oven fire occurs, turn the oven off and do not open the door. If the fire continues, throw baking soda on the fire or use a fire extinguisher. Do not put water or flour on the fire. Flour may be explosive, and water can cause a grease fire to spread and possibly cause personal injury.

⚠ CAUTION

Always use pot holders or oven mitts when using a hot oven. When broiling, the oven interior and oven racks will become hot enough to cause burns. Do not use the broiler pan without the insert. Do not cover the broil pan or insert with aluminum foil; the exposed grease could ignite.

Important notes:

- Always arrange oven racks when the oven is cool.
- For optimum browning, preheat the broil element for five to six minutes before placing meat in the oven. to avoid burning food, watch the food carefully when broiling and turn meat when needed.
- Broiler pans and inserts allow the grease to drain away from the high heat of the broiler. Do not use the pan without the insert. Do not cover the broiler insert with aluminum foil-the exposed grease could ignite.

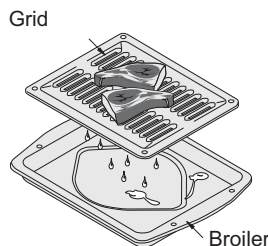

Figure 18: Broiler pan/insert

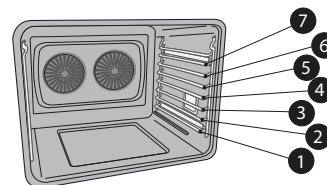

Figure 19: Rack positions

Table 3: Broiling recommendations^{1), 2)}

Food Item	Rack Position	Temperature	Cook Time (in minutes)		Internal Temp	Doneness
			1st side	2nd side		
Steak 1" thick	5th or 6th	550°F (288°C)	6	5	160°F (71°C)	Medium
Steak 1" thick	6th or 7th	550°F (288°C)	7	5	160°F (71°C)	Medium-Well
Steak 1" thick	6th or 7th	550°F (288°C)	8	7	160°F (71°C)	Well
Pork Chops 3/4" thick	6th	550°F (288°C)	8	6	160°F (71°C)	Well
Chicken - Bone In	5th	450°F (232°C)	20	10	180°F (82°C)	Well
Chicken - Boneless	6th	450°F (232°C)	8	6	180°F (82°C)	Well
Fish	6th	500°F (288°C)	13	n/a	145°F (63°C)	Well
Shrimp	5th	550°F (288°C)	5	n/a	145°F (63°C)	Well
Hamburger 1" thick	7th	550°F (288°C)	6	4	135°F (57°C)	Rare
Hamburger 1" thick	7th	550°F (288°C)	9	7	160°F (71°C)	Medium
Hamburger 1" thick	6th	550°F (288°C)	10	8	160°F (71°C)	Well

- 1) Use this table for recommended broiling times. It might be necessary to increase/decrease times or adjust the pan's rack position.
- 2) The U.S. Department of Agriculture states, "Rare fresh beef is popular, but you should know that cooking it to only 140°F (60°C) means some food poisoning organisms may survive." (Source: Safe Food Book, Your Kitchen Guide, USDA Rev. June 1985.) The lowest temperature recommended by the USDA is 145°F (63°C) for medium rare fresh beef. For beef medium 160°F, well done 170°F.

Convection Bake

Convection functions use a fan to circulate the oven's heat uniformly and continuously around the oven (Figure 20). This improved heat distribution allows for fast, even baking and browning results. It also gives better baking results when using two oven racks at the same time. Heated air flows around the food from all sides, sealing in juices and flavors. Breads and pastry brown more evenly. Most foods baked in a standard pan will bake faster and more evenly with the convection feature. Multiple rack baking may slightly increase bake time for some foods, but the overall result is time saved.



The convection bake feature is best used for multiple rack baking. Use a glide rack on position 2 and a flat rack on position 7. Use this feature when the recipe instructions have been written especially for convection baking. If the recipe instructions are for baking and you wish to use convection baking, follow the "Convection Convert" instructions on page 19. Convection convert will automatically adjust the oven temperature so that convection baking will provide the best possible results.

Benefits of convection bake:

- Superior multiple oven rack performance
- Foods bake more evenly
- No special pans or bakeware required
- Foods can bake up to 25 to 30% faster.

Convection bake may be set with the following options:

- Convection convert
- Fast preheat
- Meat probe
- Cook time or cook time with end time settings

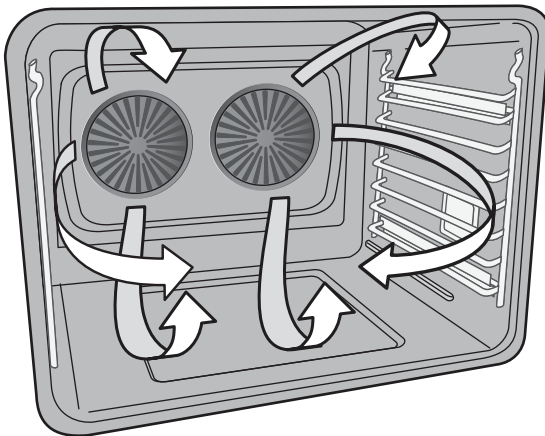

Figure 20: Air circulation in convection mode

To set convection bake with the factory default temperature of 350°F (176°C):

⚠ CAUTION

Always use pot holders or oven mitts when working with a hot oven. When baking, the oven interior and oven racks will become hot enough to cause burns.

1. Arrange interior oven racks.
2. Press **OVEN** to light up the baking modes keys.

3. Press **conv bake**.



4. Press **START enter**. The display will show **PRE-HEATING**.



5. Place food in the oven when the chime signals, the temperature display shows that the oven has reached the set target temperature, and **PRE-HEATING** disappears. Remove food once complete.

6. Press **CANCEL off** to stop or cancel the convection bake feature at any time.



IMPORTANT! If the oven door is opened when convection bake is active, the convection fans will stop rotating until the oven door is closed.



When using convection bake, bake time reductions may vary depending on the amount and type of food being baked.

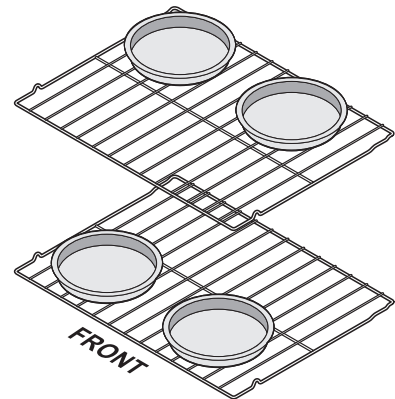

Figure 21: Pan spacing for convection baking

Convection Baking/Convert Tips

- Fully preheat the oven before baking items like cookies, biscuits, and breads.
- When using any single oven rack, position the rack in the oven so that the food is in the center of the oven.
- When baking cakes using two oven racks, place bakeware in positions 2 and 7 (Figure 22) and place pans as shown in Figure 21. Use a flat rack in position 7 and a glide rack in position 2.
- Use positions 2 and 7 for multiple-rack convection baking, position. Use a flat rack in position 7 and a glide rack in position 2.
- Allow 2 inches (5 cm) of space between bakeware to allow for proper air circulation.
- Cookies and biscuits should be baked on pans with no sides or very low sides to allow air to circulate around the food.
- Dark or dull bakeware absorbs more heat than shiny bakeware, resulting in dark or overbrowned foods. It may be necessary to reduce oven temperature or bake time to prevent overbrowning of some foods. Dark bakeware is recommended for pies. Shiny bakeware is recommended for cakes, cookies, and muffins.
- Do not open the oven door often. Opening the door will reduce the temperature in the oven and may increase bake time.
- Reduce oven temperature 25°F (14°C) from recipe's recommended oven temperature. Follow the remainder of the recipe's instructions using the minimum recommended bake time.
- For cakes, pastries, and breads, use the convection bake function for best results when using multiple racks.

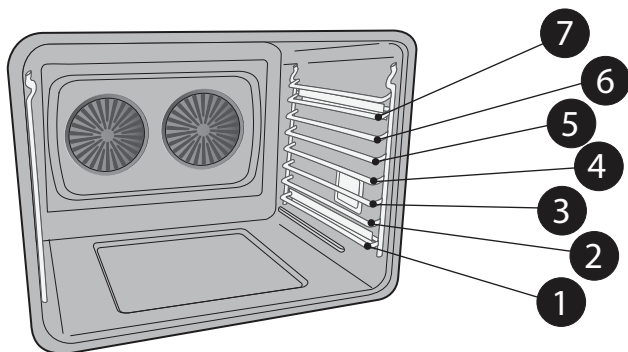

Figure 22: Rack positions

Convection Convert

Use convection convert to automatically convert any normal baking recipe into a convection bake recipe. The control uses the normal recipe settings and adjusts to a lower temperature for convection baking. When set properly, this feature is designed to display the actual converted (reduced) temperature in the display. Convection convert may only be used with a convection bake cooking mode.

Benefits of convection convert:

- Superior multiple oven rack performance
- Some foods bake faster, saving time and energy
- No special bakeware required







When using convection convert, bake time reductions may vary depending on the open temperature setting. Convection convert reduces original temperatures by 25°F (14°C).

To set convection convert with the factory default oven temperature of 350°F (176°C):

⚠ CAUTION

Always use pot holders or oven mitts when using the oven. When baking, the oven interior and oven racks will become very hot which can cause burns.

1. Arrange interior oven racks.
2. Press **OVEN** to light up the available baking modes keys.
3. Press **conv bake**. 
4. Press **cook options**. The bake options keys will light up. 
5. Press **conv convert**. The temperature displayed will be 25°F (14°C) lower than what it used to be. 
6. Press **START enter** to begin the convection baking. Once the oven reaches the set temperature, a tone will sound indicating the oven is ready. 
7. Press **CANCEL off** to stop or cancel the convection feature at any time. 



Convection convert can be set after the convection bake function is started by pressing **cook options**, and then pressing **conv convert**.

Using Convection convert with cook time

When convection conversion is used with the cook time feature, **CF** (check food) will be displayed when 75% of the bake time complete. The control will chime at regular intervals until **CANCEL off** is pressed, as a reminder to check the food. When the cook time runs out, the oven will shut off automatically and chime.

To set convection convert for 30 minutes at 375°F (191°C):

CAUTION

Always use pot holders or oven mitts when using the oven. When baking, the oven interior and oven racks will become very hot which can cause burns.

1. Arrange interior oven racks.
2. Press **OVEN** to light up the available baking modes keys.

3. Press **conv bake**.



4. Enter **3 7 5** using the numeric keypad.

5. Press **cook options**. The bake options keys will light up.



6. Press **cook time**.



7. Enter **3 0** using the numeric keypad.

8. Press **conv convert**. The temperature displayed will be 25°F (14°C) lower than what it used to be.



9. Press **START enter** to begin the convection baking. Once the oven reaches the set temperature, a tone will sound indicating the oven is ready.



10. Press **CANCEL off** to stop or cancel the convection feature at any time.



The convection convert feature will work best if the bake time is 20 minutes or longer. If setting a bake time that is under 20 minutes, this feature will not chime at 75% of the bake time.

Convection Roast

Convection roast is best for cooking tender cuts of beef, lamb, pork, and poultry. Heated air circulates around the meat from all sides, gently browning the exterior and sealing in the juices and flavors. Use this mode when cooking speed is desired. Convection roast uses the hidden bake element, the hidden convection element, the broil element, and a fan to circulate the oven's heat evenly and continuously within the oven.

Convection roast may be set with cook time, cook time with end time, and probe. Preheating is not necessary when using convection roast.

To set convection roast with the default oven temperature of 350°F (176°C):

1. Arrange interior oven racks.
2. Press **OVEN** to light up the available cooking modes keys.
3. Press **conv roast**.
4. Press **START enter**. To change temperature settings after this feature has started, press **+hi** or **-lo** to increase or decrease the oven temperature. The oven temperature will change by $\pm 5^{\circ}\text{F}$ ($\pm 2^{\circ}\text{C}$) with each press of **+hi** or **-lo**.
5. Press **CANCEL off** to stop or cancel the convection feature at any time.



To properly arrange food for roasting:

⚠ CAUTION

Always use pot holders or oven mitts when using the oven. When cooking, the oven interior and oven racks will become very hot which can cause burns. Do not cover the broil pan/insert with aluminum foil; the exposed grease could ignite.

⚠ WARNING

Should an oven fire occur, close the oven door and turn the oven off. If the fire continues, throw baking soda on the fire or use a fire extinguisher. Do not put water or flour on fire. Flour may be explosive, and water can cause a grease fire to spread and cause personal injury.

1. Place the oven rack on bottom or next to the bottom oven rack position.
2. Place the insert/grid on the broiler pan. Make sure the insert is securely seated on top of the broiler pan. Do not use the broiler pan without the insert. Do not cover the insert with aluminum foil.
3. Next, place the roasting rack on the insert/grid. Make sure the roasting rack is securely seated on the grid in the broiler pan. The roasting rack allows the heated air to circulate under the food for even cooking and helps to increase browning on the underside.
4. Place meat (fat side up) on insert (Figure 23). Place prepared food on oven rack and slide into oven.

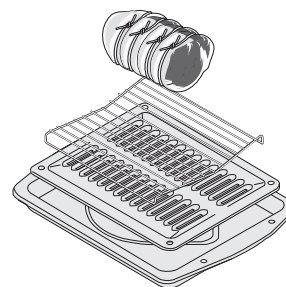

Figure 23: Broil pan, insert, and roasting rack

Table 4: Convection roasting temperature and time recommendations

Meat		Weight	Oven Temp	Internal Temp	Minutes per lb.
Beef	Standing rib roast ¹⁾	4 to 6 lbs.	350°F (177°C)	160°F (71°C) ¹⁾	25-30
	Ribeye roast ¹⁾	4 to 6 lbs.	350°F (177°C)	160°F (71°C) ¹⁾	25-30
	Tenderloin roast ¹⁾	2 to 3 lbs.	400°F (204°C)	160°F (71°C) ¹⁾	15-25
Poultry	Turkey whole ²⁾	12 to 16 lbs.	325°F (163°C)	180°F (82°C)	8-10
	Turkey whole ²⁾	16 to 20 lbs.	325°F (163°C)	180°F (82°C)	10-15
	Turkey whole ²⁾	20 to 24 lbs.	325°F (163°C)	180°F (82°C)	12-16
	Chicken	3 to 4 lbs.	350°F-375°F (177°C-191°F)	180°F (82°C)	12-16
Pork	Ham roast, fresh	4 to 6 lbs.	325°F (163°C)	160°F (71°C)	30-40
	Shoulder blade roast	4 to 6 lbs.	325°F (163°C)	160°F (71°C)	20-30
	Loin	3 to 4 lbs.	325°F (163°C)	160°F (71°C)	20-25
	Pre-cooked ham	5 to 7 lbs.	325°F (163°C)	160°F (71°C)	30-40

1) For beef, medium 160°F. Well done 170°F.

2) Stuffed turkey requires additional roasting time. Shield legs and breast with foil to prevent over browning and drying of the skin.

Convection Roasting tips:

- Preheating for convection roast will not be necessary for most meats and poultry.
- Arrange oven racks so the food is in the center of the oven.
- Since convection roast cooks faster, you can reduce cook times by 25% from the recommended time of your recipe (check the food at this time). Then if needed, increase cook time until the desired doneness is obtained.
- Do not cover foods when dry roasting - covering will prevent the meat from browning properly.
- Be sure to carefully follow your recipe's temperature and time recommendations or refer to the convection roast recommendations in [Table 4](#).
- Use the broiler pan and insert, as well as the roasting rack ([Figure 23](#)) (some models). The broiler pan will catch grease spills, and the insert will help prevent splatters. The roasting rack will hold the meat.
- Do not use the broiler pan without the grid or cover the grid with aluminum foil.
- Always pull the rack out to the stop position before removing food.
- It is not recommended to roast chicken on a roasting rack. Use a deep pan instead.

Convection Broil

Use convection broil to cook thicker cuts of meat, fish, and poultry that require direct exposure to radiant heat and the convection fan for optimum browning results. Convection broil gently browns the exterior and seals in the juices. It uses the broil element and a fan to circulate the oven's heat evenly and continuously within the oven.

The convection fan will begin rotating once convection broil has been activated, and the oven door is closed.

Convection Broiling Tips:

- Always pull the rack out to the stop position before turning or removing food.
- For optimum browning, preheat the broil element for 2 min.
- Broil one side until the food is browned; turn and cook on the second side. Season and serve.
- Always use the broiler pan and its insert when broiling, if included. It allows the dripping grease to be kept away from the high heat of the broil element ([Figure 23](#)).
- Do not use the broil pan without the insert. Do not cover the broil pan insert with foil. The exposed grease could catch fire. Do not use the roasting rack when broiling.
- Since convection broil cooks food quickly, reduce the cook time by 25% from the recommended cook time of your recipe (check the food at this time). If necessary, increase cook time until the desired doneness is obtained.



To set convection broil with a default oven set temperature of 550°F (288°C):

⚠ CAUTION

Always use pot holders or oven mitts when using the oven. When cooking, the oven interior and oven racks will become very hot which can cause burns. Do not cover the broil pan/insert with aluminum foil; the exposed grease could ignite.

⚠ WARNING

Should an oven fire occur, close the oven door and turn the oven off. If the fire continues, throw baking soda on the fire or use a fire extinguisher. Do not put water or flour on fire. Flour may be explosive, and water can cause a grease fire to spread and cause personal injury.

1. Arrange interior oven racks.
2. Press **OVEN** to light up the available cooking modes keys.
3. Press **conv broil**. 
4. Press **START enter**. The convection fan will begin rotating once convection broil has been activated and oven door is closed. To change temperature settings, press **+hi** or **-lo** to increase or decrease the oven temperature. The oven temperature will change by $\pm 5^{\circ}\text{F}$ ($\pm 2^{\circ}\text{C}$) with each press of **+hi** or **-lo**. 
5. Press **CANCEL off** to stop or cancel the convection feature at any time. 

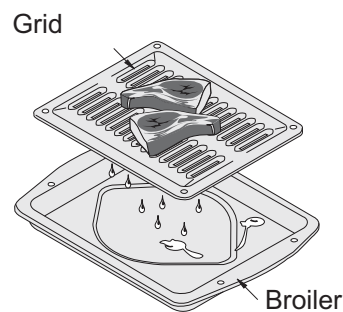

Figure 24: Broil pan and grid



The temperature probe cannot be used in this cooking mode.

Keep Warm

Keep warm is best for keeping oven baked foods warm for serving after cooking has finished. It may be set with cook time, cook time/end time, and multi stage. Keep warm uses the hidden bake element to maintain the temperature within the oven. Keep warm will run continuously or (if used with bake time) until the time runs out.

To set a keep warm temperature at the default of 170°F (76°C):

WARNING

Food Poisoning Hazard. Do not let food sit for more than one hour before or after cooking. Doing so can result in food poisoning or sickness. Foods that can easily spoil such as milk, eggs, fish, meat, or poultry should be chilled in the refrigerator first. Even when chilled, they should not stand in the oven for more than 1 hour before cooking begins and should be removed promptly when finished cooking. Eating spoiled food can result in sickness from food poisoning.

1. Arrange interior oven racks.
2. Press **OVEN** to light up the available cooking modes keys.

3. Press **keep warm** to activate the keep warm function. The default temperature of 170°F (76°C) will appear in the display.



4. Press **START enter**.



5. Press **CANCEL off** to stop or cancel the keep warm feature.



To set keep warm with a setting of 150°F (71°C):

WARNING

Food Poisoning Hazard. Do not let food sit for more than one hour before or after cooking. Doing so can result in food poisoning or sickness. Foods that can easily spoil such as milk, eggs, fish, meat, or poultry should be chilled in the refrigerator first. Even when chilled, they should not stand in the oven for more than 1 hour before cooking begins and should be removed promptly when finished cooking. Eating spoiled food can result in sickness from food poisoning.

1. Arrange interior oven racks.
2. Press **OVEN** to light up the available cooking modes keys.

3. Press **keep warm** to activate the keep warm feature.



4. Press **-lo** until the temperature shows **150** on the display.

150

5. Press **START enter**.



6. Press **CANCEL off** to stop or cancel the keep warm feature.



If changing cooking times, use cook time or end time to make the desired changes. Refer to “Cook Time” and “Setting Cook Time with End Time” on page 16 for instructions on how to use these features.

Keep Warm Tips:

- Always start with hot food. Do not use the warm feature to heat cold food.
- Food in heat-safe glass and glass ceramic containers may need higher temperature settings compared to food in regular containers.
- Avoid repeated openings of the oven. It will allow hot air to escape and the food to cool.
- Aluminum foil may be used to cover food to increase moisture content.

Keep Warm Temperature Selection

See Table 5 for the recommended keep warm food settings. If a particular food is not listed, use the default temperature of 170°F. If more crispness is desired, remove the lid or aluminum foil from the food. Most foods can be kept as serving temperatures of 170°F. When a combination of foods are to be kept warm (for example, a meat with two vegetables and rolls) use 170°F.

Table 5: Keep warm recommended food settings

Food Item	Heating Level
Hot beverages	hi 190°F (86°C)
Fried foods	hi 190°F (86°C)
Vegetables	med 170°F (76°C)
Soups (Cream) and Stews	med 170°F (76°C)
Sauces	med 170°F (76°C)
Meats	med 170°F (76°C)
Gravies	lo 150°F (66°C)
Eggs	lo 150°F (66°C)
Dinner plates with food	lo 150°F (66°C)
Casseroles	lo 150°F (66°C)
Breads and pastries	lo 150°F (66°C)

Meat Probe

When cooking meat such as roasts, hams, or poultry, use the meat probe function to check the internal temperature without guesswork. For some foods, especially poultry and roasts, testing the internal temperature is the best method to ensure properly cooked meats. Your oven will automatically change from cooking to keep warm once the probe has reached the set temperature.

The following temperature settings apply to the probe function:

- Default: 170°F (76°C)
- Minimum: 130°F (54°C)
- Maximum: 210°F (98°C)

IMPORTANT!

- Use only the meat probe supplied with appliance. Using any other probe or device may result in damage to appliance and the meat probe receptacle.
- Never leave or store meat probe inside oven.
- Defrost food completely before inserting meat probe to avoid damaging probe.

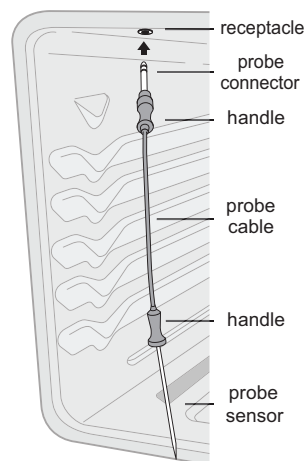

Figure 25: Probe receptacle insertion

The probe receptacle is located at the top of the oven cavity as shown in [Figure 25](#).

Proper meat probe placement

Always insert meat probe so that the probe tip rests in the center of the thickest part of meat. Do not allow meat probe to touch bone, fat, gristle, or bakeware.

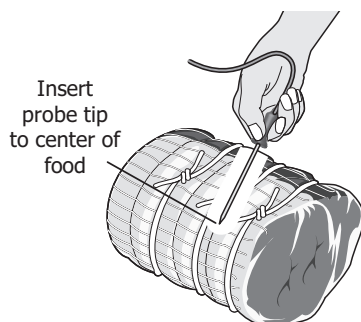

Figure 26: Proper probe placement

Tips for Probe Placement

- For bone-in ham or lamb, insert meat probe into the center of lowest large muscle or joint.
- For meals such as meat loaf or casseroles, insert meat probe into center of food.
- When cooking fish, insert meat probe just above the gill.

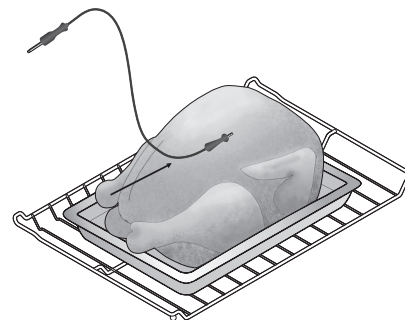

Figure 27: Proper probe placement



For whole poultry or turkey, insert meat probe into the thickest part of the breast ([Figure 27](#)).

To set the meat probe:

Follow these steps to set the probe target temperature to 180°F (82°C) when using the convection roast feature with oven set temperature for 325°F (162°C): The default internal temperature when setting the probe is 170°F (76°C).

⚠ CAUTION

Always use pot holders or oven mitts when working with a hot oven. When baking, the oven interior and oven racks will become hot enough to cause burns.

⚠ CAUTION

Handle the meat probe carefully when inserting and removing from food or probe receptacle. Do not use kitchen utensils, such as tongs, to pull on meat probe cable when inserting or removing from food or receptacle. Use the provided handle, as shown in [Figure 25](#). To avoid possibility of burns after cooking, carefully unplug meat probe using a pot holder to protect hands.

1. Prepare the food and properly insert the meat probe into the food. Do not preheat or start cooking before properly inserting the meat probe. Probe should be inserted into the food and receptacle while the oven is still cool.
2. Place the prepared food on the desired oven rack position and slide into the oven.
3. Plug the meat probe into the probe receptacle located on the top of the oven cavity. When the meat probe is correctly plugged in to receptacle, the probe icon will illuminate in the oven control display after **cook options** is pressed.

4. Press **OVEN** to light up the available cooking modes keys.

5. Press **conv roast**.



6. Enter **3 2 5** using the numeric keypad.

325

7. Press **cook options**.



8. Press **probe**. The default temperature of 170°F appears in the display



9. Enter **1 8 0** using the numeric keypad to change the probe setting.

180

10. Press **START enter**.



11. During the cooking process, to view the internal meat temperature, press **probe** once. After 6 seconds, the display will show the actual oven temperature. Press **probe** twice to review or change the probe target temperature.



12. The oven control will chime when the internal target temperature is reached. By default the oven will automatically change to a keep warm setting. Keep warm will maintain the oven temperature at 170°F (76°C).

13. Press **CANCEL off** to stop cooking at any time.



Table 6: USDA recommended minimum internal cooking temps

Food Type	Internal Temp.
Ground meat and meat mixtures	
Beef, Pork, Veal, Lamb Turkey, Chicken	160°F (71°C) 165°F (74°C)
Fresh beef, veal, lamb	
Medium rare + Medium Well Done	145°F (63°C) 160°F (71°C) 170°F (77°C)
Poultry	
Chicken and Turkey, whole Poultry Breasts, Roasts Poultry Thighs, Wings Duck and Goose Stuffing (cooked alone or in bird)	165°F (74°C) 165°F (74°C) 165°F (74°C) 165°F (74°C) 165°F (74°C)
Fresh pork-roasts, steaks, and chops	
Medium Well Done	160°F (71°C) 170°F (77°C)
Ham	
Fresh (raw) Pre-cooked (to reheat)	160°F (71°C) 140°F (60°C)
Eggs and egg dishes	
Eggs Eggs dishes Leftovers and Casseroles	Cook til yolk/white firm 160°F (71°C) 165°F (74°C)

The U.S. Department of Agriculture states, “Rare fresh beef is popular, but you should know that cooking it to only 140°F (60°C) means some food poisoning organisms may survive.” (Source: *Safe Food Book, Your Kitchen Guide*, USDA Rev. June 1985.) The lowest temperature recommended by the USDA is 145°F (63°C) for medium rare fresh beef. For beef medium 160°F, well done 170°F

Visit the USDA Food Safety and Inspection website at www.fsis.usda.gov

Perfect Turkey™

Perfect turkey uses the meat probe feature with convection roasting to ensure your turkey is cooked perfectly. It displays the internal temperature of the turkey and calculates the amount of cooking time remaining. Heated air circulates around the turkey from all sides, sealing in juices and flavors. Poultry cooked with this feature are crispy brown on the outside while staying moist on the inside.

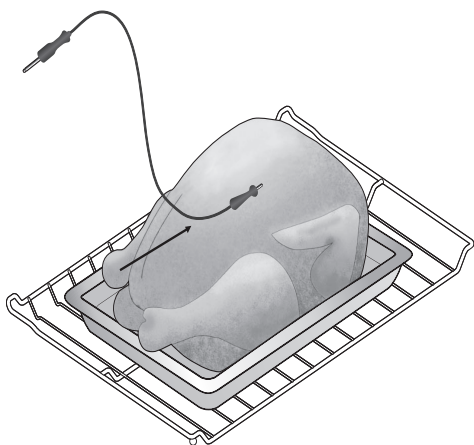

Figure 28: Proper probe placement

IMPORTANT! To ensure a proper probe reading, it is essential that the probe tip is inserted up into the thickest part of the breast for perfect turkey. For best results, the turkey should be as close to refrigerated temperature as possible (35°F - 40°F) (2°C - 4°C) when setting the perfect turkey feature.

IMPORTANT! The temperature of the meat probe can be entered only when the probe is plugged in. If the probe is unplugged, the meat probe set temperature will be reset back to the default temperature of 180°F (82°C).

When the perfect turkey function starts, the control will display **CALC** (for calculation) with the probe displaying the actual internal temperature of the turkey. After some time, the control will display the time remaining until the internal temperature of the turkey reaches the meat probe set temperature.

During the roasting process, the time remaining is updated once every minute and displayed in hours and minutes. When the time remaining is less than 1 hour, only the actual minutes remaining will show in the display.

During the final 10 minutes, the display will countdown in both minutes and seconds. The meat probe temperature cannot be changed during this time. When perfect turkey is finished, **00:00** will appear in the display, the perfect turkey LED indicator will turn off, and the oven will automatically turn on the keep warm feature. It will stay on until it is cancelled.

IMPORTANT! It is not recommended to modify the perfect turkey settings once cooking has started. Doing so may not provide the best results.

Setting Perfect Turkey™

The default oven temperature of 325°F (163°C) is the optimal temperature for roasting turkey and cannot be changed. The probe ensures that the turkey will be cooked to the desired doneness.

To use the perfect turkey feature:

1. Insert the probe into the thickest part of the breast and place the turkey in the oven.
2. Plug the meat probe into the probe receptacle located on the top of the oven cavity. When the meat probe is correctly plugged into the receptacle, the probe icon will illuminate in the oven control display (Figure 25).
3. Press **OVEN** to light up the available cooking modes.
4. Press **perfect turkey**. The meat probe set temperature will be 180°F (82°C) by default.



If the meat probe is not plugged and **perfect turkey** is pressed, the control will chime and reject the key. The probe key starts flashing as a reminder to plug in the probe. **START enter** is invisible and unavailable until the probe is connected to the probe receptacle. The probe key continues flashing until the probe is plugged in or the programming mode is canceled or times out.

5. To adjust the meat probe set temperature, enter a temperature using **+hi** or **-lo** or the numeric keypad.
6. Press **START enter**. After the internal temperature of the turkey begins to rise, the display will show the calculated time remaining until the cooking process ends.



It is not recommended to change the meat probe set temperature after perfect turkey has started. If a different temperature is desired, then press **probe** and enter the new temperature using the numeric keypad and press **START enter**.

7. Press **CANCEL off** any time when setting the control or during the cooking process.



Table 7: Perfect turkey temperature recommendations¹⁾

Meat	Weight	Oven Temp	Internal Temp	Min, per lb.
Turkey ²⁾	12-16 lb.	325°F (163°C)	180°F (82°C)	8-10
Turkey ²⁾	16-20 lb.	325°F (163°C)	180°F (82°C)	10-15
Turkey ²⁾	20-24 lb.	325°F (163°C)	180°F (82°C)	12-16

- 1) Stuffed turkey requires additional roasting time. Shield legs and breast with foil to prevent overbrowning and drying of the skin.
- 2) Weight, Oven temp, internal temp, and minutes per lb are for a whole turkey

Setting Defrost

Only frozen foods that can be defrosted and served without cooking should be used with this feature. Use defrost to thaw small portions of delicate items such as cream cakes, frozen cream pies, and cheesecake at room temperature. While in the defrost mode, the convection fan will operate to circulate room temperature air around the food slowly, accelerating the natural defrosting of the food without using heat. Defrost may be set with cook time and cook time with end time.

To set defrost:

CAUTION

Always use pot holders or oven mitts when working with a hot oven. When baking, the oven interior and oven racks will become hot enough to cause burns.

CAUTION

This feature is not meant for thawing frozen meats, poultry, seafood, or other foods that need to be cooked before serving. Follow USDA recommendations for thawing foods.

WARNING

Food Poisoning Hazard. Do not let food sit for more than one hour before or after cooking. Doing so can result in food poisoning or sickness. Foods that can easily spoil such as milk, eggs, fish, meat, or poultry should be chilled in the refrigerator first. Even when chilled, they should not stand in the oven for more than 1 hour before cooking begins and should be removed promptly when finished cooking. Eating spoiled food can result in sickness from food poisoning.

1. Place the food on the desired oven rack position and slide into the oven.
2. Press **OVEN** to light up the available cooking modes keys.

3. Press **defrost**.



4. Press **START enter**.



5. Press **CANCEL off** to stop cooking at any time.



Setting Dehydrate

The dehydrate feature dries with heat from the elements. The heat is circulated throughout the oven by the convection fan. Use dehydrate to dry and/or preserve foods such as fruits, vegetables, herbs, and very thin slices of meat. Dehydrate may be set with cook time and cook time with end time. The following temperature settings apply to the dehydrate feature:

- Auto-suggest (default) setting: 120°F (48°C)
- Minimum dehydrate setting: 100°F (38°C)
- Maximum dehydrate setting: 225°F (108°C)

To set dehydrate at the default temperature of 120°F (48°C):

1. Place the food on the desired oven rack position and slide into the oven.
2. Press **OVEN** to light up the available cooking modes keys.

3. Press **dehydrate**.



4. Press **START enter**.



5. Press **CANCEL off** to turn off dehydrate at any time.



To add or change any cook settings after this feature has started:

- To change temperature settings, use the **+hi** or **-lo** keys to increase or decrease the oven temperature by $\pm 5^\circ\text{F}$ ($\pm 2^\circ\text{C}$).
- If changing cooking times, use cook time or end time to make the changes. Refer to [“Cook Time”](#) and [“Setting Cook Time with End Time”](#) on [page 16](#) for instructions on how to use these features.

For best results:

- Dry most fruits and vegetables at 140°F (60°C). Dry herbs at 100°F (38°C).
- Drying times vary depending on the moisture and sugar content of the food, the size of the pieces, the amount being dried, and the humidity in the air.
- Treat fruits with antioxidants to avoid discoloration.
- Tightly woven cooling racks can be used to allow the air to circulate around the food; or use drying racks to allow the air to circulate around the food (this type of oven rack is not supplied with this appliance).
- Consult a food preservation book or library for information.
- The convection fan will turn off when the door is opened. Be sure to not open the oven door too often during the dehydrating process. The fan will resume operating when the door is closed.

Setting Bread Proof

The bread proof feature maintains a warm environment useful for rising yeast-leavened products. Bread proof can be set with the following options: cook time or cook time with end time. The following temperature settings apply to the bread proof feature:

- Auto-suggest (default) setting: 100°F (38°C)
- Minimum bread proof setting: 85°F (30°C)
- Maximum bread proof setting: 100°F (38°C)

For best results:

- No need to preheat for this feature.
- Proof bread until dough has doubled in bulk.
- Lightly cover the dough.
- Place a shallow pan with 1 to 3 cups of boiling water on the lowest rack position to keep the air moist inside the oven cavity.
- Allow at least 1" between edge of pan and walls of oven.
- Use the oven light to check progress. Do not open the oven door.

To set bread proof for 85°F (30°C):

1. Place dough on the desired oven rack position and slide into the oven.
2. Press **OVEN** to light up the available cooking modes keys.
3. Press **bread proof**. The default temperature of 100°F will appear in the display.
4. Enter **8 5** using the numeric keypad.
5. Press **START enter**.
6. Press **CANCEL off** to turn off bread proof at any time.



85



Slow Cook

Slow cook may be used to cook foods more slowly, at lower oven temperatures and provide cooking results much the same way as a slow cooker or crock-pot. Slow cook is ideal for roasting beef (ribs and brisket), pork, and poultry. It may be set with cook time, cook time/end time, prove, and multi stage. Slow cooking meats may result in the exterior of meats becoming dark but not burnt. This is normal. Slow cook uses the hidden bake element to maintain a low temperature in the oven. The meat probe cannot be used in this cooking mode. There are two settings available, high (HI) or low (LO). The maximum cook time for slow cook is 12 hours unless the oven control has been changed to the continuous bake mode.

To set slow cook with a low setting:

WARNING

Food Poisoning Hazard. Do not let food sit for more than one hour before or after cooking. Doing so can result in food poisoning or sickness.

CAUTION

Always use potholders or oven mitts when removing food or adjusting the oven racks. Wait until the oven is completely cooled if possible. When cooking, the oven interior and oven racks will become hot enough to cause burns.

1. Place the food on the desired oven rack position and slide into the oven.
2. Press **OVEN** to light up the available cooking modes keys.
3. Press **slow cook**. The default setting **Hi** appears in the display. If you need a low setting, press **-lo** to select the **Lo** setting.
4. Press **START enter**. To change any cook settings after slow cook has started, press **+hi** or **-lo** and release.
5. Press **CANCEL off** to stop slow cook at any time.



If changing cooking times, use cook time or end time to make the needed changes. Refer to [“Cook Time”](#) and [“Setting Cook Time with End Time”](#) on [page 16](#) for instructions on how to use these features.

For best results:

- Slow cooking meats may result in the outside of the meat turning dark; this is normal. Completely thaw all frozen foods before cooking.
- Arrange food in center of oven. Position multiple racks to accommodate size of cooking utensils when baking multiple food items. Add any cream or cheese sauces during the last hour of cooking.
- Do not frequently open the oven door or leave the oven door open when checking food items. The more heat that is lost, the longer the food will need to cook.
- Cover foods to keep them moist or use a loose or vented cover to allow foods to turn crisp or brown.

Setting Multi Stage

Use multi stage to perform sequential cooking at the touch of a button. Its purpose is to program a queue of up to three cooking modes with individual cooking time and temperatures in a sequence. This feature can be used with bake, broil, convection bake, convection roast, convection broil, keep warm, and bread proof. A cook time can be programmed with the desired cooking mode and then queued. Be sure to follow recipe suggestions when determining how to best set multi stage.

For example, the first stage might be a short duration with a higher than normal cooking temperature to rapidly start the cooking process. A second stage at a normal temperature would allow for a longer, more normal cooking time. A final stage can be set for holding the cooked food at serving temperature by setting keep warm as the final stage. During stage 1 baking, the electronic control provides temperature visual output in the display. During stage 2 and 3, the electronic control displays the set temperature only.

IMPORTANT! A proper cook time and a set temperature are required for every stage programming. At least two stages must be programmed before multi stage cooking operation starts.



Any stage programmed with broil or convection broil cannot last longer than 10 minutes.

IMPORTANT! Be sure to run the fast preheat feature to get the oven up to the desired temperature before starting a multi stage operation. See "Fast Preheat" on page 14.

To set a (2) multi stage feature for a casserole with:

- For stage 1, bake at 400°F (204°C) for 1 hour; and
- For stage 2, brown, broil for at 500°F (260°C) for 4 minutes, using 2 stages of this feature:

CAUTION

Always use pot holders or oven mitts when working with a hot oven. When baking, the oven interior and oven racks will become hot enough to cause burns.

1. Place the food on the desired oven rack position and slide into the oven.
2. Press **OVEN** to light up the available cooking modes keys.

3. Press **multi stage**.



----- **STAGE 1** appears in the display -----

4. Press **bake**.



bake

5. Enter the temperature of **4 0 0** using the numeric keypad. **400**



6. Press **START enter**.

7. Enter **6 0** minutes using the numeric keypad. **60**



8. Press **START enter**. This sets the first stage of cooking and **stage 2** will show in the display allowing you to program the desired next step.

----- **STAGE 2** -----



9. Press **broil**.

broil

10. Enter **5 0 0** degrees using the numeric keypad. **500**



11. Press **START enter**.

12. Enter **4** minutes using the numeric keypad. **4**



13. Press **START enter** twice. This will program the 2 stages and begin cooking.

14. Press **CANCEL off** to stop multi stage cooking at any time.



CANCEL off

Setting Multi Stage for Three Stages

When all three stages of cooking are preferred, setting the multi stage feature requires a few easy steps. Each stage may be programmed with a cooking feature, set temperature, and a cook time. Using three stages is ideal when you want to add a keep warm after using two cooking functions.

To program a (three stage) multi stage feature for a casserole with:

- For stage 1, bake at 350°F (176°C) for 1 hour;
- For stage 2, brown, broil for 500°F (260°C) for 4 minutes; and
- For stage 3, keep warm at 170°F (76°C) for 15 minutes.

CAUTION

Always use pot holders or oven mitts when working with a hot oven. When baking, the oven interior and oven racks will become hot enough to cause burns.

1. Place the food on the desired oven rack position and slide into the oven.
2. Press **OVEN** to light up the available cooking modes.

3. Press **multi stage**.



----- **STAGE 1** appears in the display-----

4. Press **bake**.



bake

5. Enter **3 5 0** using the numeric keypad.

350

6. Press **START enter**.



7. Enter **6 0** minutes using the numeric keypad.

60

8. Press **START enter**.



----- **STAGE 2** appears in the display-----

9. Press **broil**.



broil

10. Enter **5 0 0** using the numeric keypad.

500

11. Press **START enter**.



12. Enter **4** minutes using the numeric keypad.

4

13. Press **START enter**



----- **STAGE 3** appears in the display -----

14. Press **keep warm**.



keep warm

15. Press **START enter**.



16. Enter **1 5** minutes using the numeric keypad.

15

17. Press **START enter**.



18. Press **CANCEL off** to stop multi stage cooking at any time.



My Favorite

The my favorite settings allows you to save your most frequently used or most complex cooking sequences. This feature will save the cooking mode, the target temperature, and the cook time (if any). The my favorite feature stores and recalls up to three favorite recipe settings, which are easily accessible from a one touch key. This feature will only store or recall one favorite recipe at a time. from each of the three my favorite keys on the control display.

My favorite may be used with bake, cook time, convection bake, convection roast, slow cook, and keep warm, and it will not work with any other feature, including end time, broil, or fresh clean.

To set a favorite recipe (example: bake for 30 minutes with oven temperature of 325°F (162°C)):

CAUTION

Always use pot holders or oven mitts when working with a hot oven. When baking, the oven interior and oven racks will become hot enough to cause burns.

1. Place the food on the desired oven rack position and slide into the oven.
2. Press **OVEN** to light up the available cooking modes keys.

3. Press **bake**. The default oven temperature of **350** appears in the display.



4. Enter **3 2 5** for temp using the numeric keypad.

325

5. Press **cook options**.



6. Press **cook time**.



7. Enter **3 0** minutes using the numeric keypad.

30

8. Press **START enter**.



9. To store, press and hold one of the three **my favorite** keys for 3 seconds and release when you hear acceptance tone and see the red indicator light above your selection.



10. Press **CANCEL off** to stop the my favorite function at any time.



To use a saved favorite recipe setting:

1. Press **oven** to light up the available cooking modes keys.

2. Press the **my favorite** key of your choice. The saved recipe will appear in the display.



3. Press **START enter**.



To erase a favorite recipe setting:

1. Press **oven** to light up the available cooking modes keys.

2. Press the **my favorite** key of your choice and hold for 3 seconds, until the my favorite indicator light turns off.





ADJUSTING THE OVEN TEMPERATURE

This appliance has been factory calibrated and tested to ensure accurate baking temperatures. For the first few uses, follow all recipe times and temperature recommendations carefully. If you think the oven is cooking too hot or too cool for your recipe times, the control may be adjusted so the oven cooks hotter or cooler than the temperature displayed.

The oven temperature may be increased or decreased $\pm 35^{\circ}\text{F}$ ($\pm 19^{\circ}\text{C}$) by adjusting the User Programmable Offset (UPO).

IMPORTANT! Do not use oven thermometers such as those found in grocery stores to check oven temperature. These thermometers may vary as much as 20°F to 40°F from actual oven temperatures.

How to offset the oven temperature by $+30^{\circ}\text{F}$:

1. Press **user pref** until **UPO** appears in the display. The default setting of **0** should display next to **UPO** (Figure 29). 
2. To increase the oven temperature by 30°F , press **+hi** until **30** appears next to **UPO** (Figure 29). **30**
3. To accept change, press **START enter**. 
4. When finished, press **CANCEL off** to return the oven to an idle mode. 

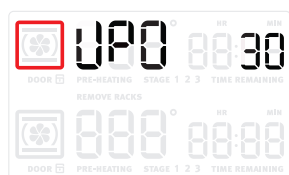

Figure 29: Oven temperature set 30° higher than default

To offset the oven temperature by -30°F (-17°C):





1. Press **user pref** until **UPO** appears in the display (Figure 30). 
2. To decrease the oven temperature by 30°F , press **-lo** until **-30** appears (Figure 30). **-30**
3. To accept change, press **START enter**. 
4. When finished, press **CANCEL off** to return the oven to an idle mode. 



Figure 30: Oven temperature set 30° lower than default

 Oven temperature adjustments made by changing the UPO setting will not affect the broil or fresh clean feature temperatures.

 Do not use oven thermometers such as those found in grocery stores to check the temperature setting inside the oven. These thermometers may display temperatures that vary greatly from the actual temperature.

Setting the Sabbath Mode (for use on the Jewish Sabbath and Holidays)



For further assistance, guidelines for proper usage, and a complete list of models with the Sabbath feature, please visit the web at <http://www.star-k.org>.

This appliance provides special settings for use when observing the Jewish Sabbath/Holidays.

Sabbath mode disables all audible tones or visual display changes on the oven control. Bake heating is the only cooking features available while in the Sabbath mode.

You must first set the bake feature and temperature(s) needed for the oven, as well as the cook time and delay start options (if needed). Any settings made prior to setting the Sabbath mode will be visible in the displays.

The Sabbath mode will override the factory preset 12-hour Energy Saving mode and the appliance will stay on until the cooking features are cancelled. If any of the cooking features are cancelled when the appliance is in the Sabbath mode, no audible or visual indicators will be available to verify the cancellation.

If the oven interior lights are needed, be sure to activate them prior to setting the Sabbath mode. Once the oven light is turned on and the Sabbath mode is active, the oven light will remain on until the Sabbath mode is turned off and the oven lights are turned off. The oven door will not activate the interior oven lights when the oven door is opened or closed.

It is recommended that any oven temperature modification made within an active Sabbath mode be followed with two presses of the START enter key. This will ensure the oven remains on even if an attempt is made to set the oven temperature outside of its temperature range. If the oven temperature is set outside of the temperature range, the oven will default to the nearest available temperature. Try to set the desired oven temperature again.

To program oven to bake with default oven temperature of 325°F (162°C) and activate the Sabbath feature:

⚠ WARNING

Food Poisoning Hazard. Do not let food sit for more than one hour before or after cooking. Doing so can result in food poisoning or sickness. Foods that can easily spoil such as milk, eggs, fish, meat, or poultry should be chilled in the refrigerator first. Even when chilled, they should not stand in the oven for more than 1 hour before cooking begins and should be removed promptly when finished cooking. Eating spoiled food can result in sickness from food poisoning.

⚠ CAUTION

Always use pot holders or oven mitts when working with a hot oven. When baking, the oven interior and oven racks will become hot enough to cause burns.

1. Be sure the clock is set to the correct time of day.
2. Place the food on the desired oven rack position and slide into the oven.
3. Press **OVEN** to light up the available cooking modes keys.

4. Press **bake**.



5. Enter **3 2 5** using the numeric keypad.

3 2 5

6. If you desire to set the oven control for cook time or end time, select **cook options**. If not, skip this step and continue to step 8.



7. If entering both cook time and end time for delay bake, the oven will automatically calculate the start time. Refer to “Cook Time” and “Setting Cook Time with End Time” on page 16 for instructions on how to use these features.



IMPORTANT! Remember the oven will shut down after using cook time and therefore may only be used once during the Sabbath/Jewish Holidays.

8. Press **START enter**. The oven will turn on and begin heating immediately.



9. To enter Sabbath mode, press and hold both **+ hi** and **- lo** keys together for 3 seconds. Release the keys when you hear the chime.

**+ -
hi lo**



Once **SAb** appears in the display, the oven control will no longer chime or display any further changes, and the oven is properly set for the Sabbath feature.



Figure 31: Sabbath Mode display

IMPORTANT! The keys available once the oven is set to Sabbath mode are bake, start, cancel, and the numeric keypad. Cook time and end time are available before Sabbath mode is set.

10. To change the oven temperature once baking has started and the oven is in Sabbath mode, press **+ hi** or **- lo**. Each press of a key will raise (+) or lower (-) the temperature in $\pm 5^{\circ}\text{F}$ ($\pm 2^{\circ}\text{C}$) increments. Remember that the oven control will no longer chime or display further changes once the oven is in Sabbath mode.

**+ -
hi lo**

11. The oven may be turned off at any time by pressing **CANCEL off**.



12. Pressing **CANCEL off** will not turn off the Sabbath feature. To cancel Sabbath mode, press and hold **+ hi** and **- lo** keys together for 3 seconds. **SAb** will disappear from the display.

**+ -
hi lo**

IMPORTANT! Remember the oven will shut off after completing a cook time or end time and therefore may only be used once during the Sabbath/Jewish holidays. The maximum cook time setting is 11 hours and 59 minutes.

What to do after a power failure or power interruption when Sabbath mode is active

If a power failure or interruption occurs during the Sabbath/Holidays, the appliance will shut off. **SF** will appear in all the control display, indicating a Sabbath mode failure (Figure 32).



Figure 32: Sabbath Failure

When power is returned, the oven will not turn back on automatically. The oven will remember that it is set for the Sabbath, and the food may be safely removed from the oven while still in the Sabbath mode; however, the oven cannot be turned back on until the Sabbath mode is cancelled. After Sabbath mode is cancelled, Sabbath mode settings may be entered again, if it's still needed.

1. To cancel Sabbath mode, press and hold **+ hi** and **- lo** together for 3 seconds.
2. **SAb** will disappear from the display, and the oven may be used with all normal functions.

+ -
hi lo

Restoring the Factory Default Settings

Your appliance is set with a number of predetermined oven control settings. Over time you may make changes to the original factory settings. The following options may have been modified since the appliance was new:

- Clock 12-hour or 24-hour display mode
- 12-Hour Energy Savings or continuous bake mode
- Tone volume
- Oven temperature display (Fahrenheit or Celsius)
- Any oven temperature adjustment made (UPO)
- Clock Display On or Off
- Any saved recipes

IMPORTANT! Before restoring, be aware that any previous changes made to the oven control settings will be erased once the numeric keypad is pressed. This includes any temperature offset made for the oven when baking.

To restore factory default settings:

1. Press **user pref** until **rSt no** or **rSt YES** appears in the display (Figure 33).
2. Press **+hi** until **rSt YES** appears in the display.
3. Press **START enter** to accept.



Figure 33: Oven ready to reset to default settings

Fresh Clean

A fresh cleaning oven automatically cleans itself by using much higher temperatures than those used for baking. The fresh clean feature eliminates soils completely or reduces them to a fine powdered ash that, when the oven has cooled, can be wiped away easily with a damp cloth.

The fresh clean function provides three different clean time settings for fresh clean. Set clean for 2 hours for light, 3 hours for normal, or 4 hours for heavier soils.

Before starting fresh clean:

⚠ WARNING

Do not leave small children unattended near the appliance. During the fresh clean cycle, the outside of the oven can become very hot to touch and can cause burns.

- Do not force the oven door open when fresh clean is active. This can damage the automatic door-locking system. Use caution when opening the door after fresh cleaning. The oven may still be very hot and can cause burns. To avoid possible burns, stand to one side of the oven when opening the oven door to allow hot air or steam to escape.

⚠ CAUTION

The health of some birds is extremely sensitive to the fumes given off during the fresh clean cycle of any range. Move birds to another well-ventilated room.

⚠ CAUTION

Do not line the oven walls, oven racks, oven bottom or any other part of the range with aluminum foil. Doing so will stop heat distribution, produce poor baking results, and may cause permanent damage to the oven interior. Aluminum foil will melt to a hot oven surface during fresh clean.

⚠ CAUTION

The oven bake and broil elements may appear to have cooled after they have been turned off. The elements may still be hot and burns may occur if these elements are touched before they have cooled.

- Remove all oven racks, including ladder racks, from the oven interior to avoid possible damage. If the oven racks are not removed they may discolor.
- Remove all items from the oven including bakeware, utensils, accessories, and any aluminum foil. Aluminum foil will not withstand high temperatures from a fresh clean cycle and will melt.
- Remove any excessive build up caused by spills. Any spill on the oven bottom should be wiped up and removed before starting a fresh clean cycle. To clean, use hot, soapy water and a cloth. Large spill residue can cause heavy smoke or fire when subjected to high temperatures. Do not allow food spills with a high sugar or acid content (such as milk, tomatoes, sauerkraut, fruit juices, or pie filling) to remain on the surface as they may leave a dull spot even after cleaning.

- Do not clean the oven door gasket (Figure 34). The woven material of the oven door gasket is essential for a good seal. Care should be taken not to rub, damage, or remove the gasket. Do not use any cleaning materials on the oven door gasket. Doing so could cause damage to the door gasket.
- Do not use oven cleaners or oven protective coatings in or around any part of the oven interior. Residue from oven cleaners may damage the oven interior during the next self-clean cycle.
- Clean any soil from the oven frame, the door liner outside the oven door gasket and the small area at the front center of the oven bottom (Figure 34). These areas heat sufficiently to burn soil on. Clean using soap and water prior to starting fresh clean.

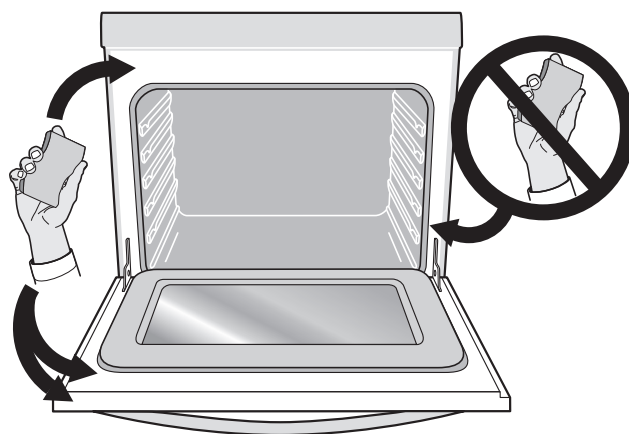

Figure 34: Oven door area to clean and not clean (gasket)

Setting Fresh Clean

⚠ WARNING

Do not leave small children unattended near the appliance. During the fresh clean cycle, the outside of the oven can become very hot to touch and can cause burns.

⚠ CAUTION

Do not force the oven door open when fresh clean is active. This can damage the automatic door-locking system. Use caution when opening the door after fresh cleaning. The oven may still be very hot and can cause burns. To avoid possible burns, stand to one side of the oven when opening the oven door to allow hot air or steam to escape.

IMPORTANT! The kitchen area should be well ventilated. Use an open window, ventilation fan, or exhaust hood during the first fresh clean cycle to help eliminate the normal odors associated the initial clean cycle.

To start a fresh clean:

1. Ensure the oven is empty and remove all oven racks and racks support. Be sure the clock is set with the correct time of day and the oven door is completely closed.
2. Press **OVEN** to light up the available cooking modes keys.
3. Press **fresh clean**. **REMOVE RACKS** will appear in the display and flash. And the oven will chime.



Remove racks indicator appears in display.

REMOVE RACKS

4. The fresh clean feature allows you to choose one of three time options. Press **lite** for a 2-hour clean (Figure 35); or



Figure 35: 2 hour lite clean

5. Press **med** (normal) for a 3-hour clean (Figure 36); or



Figure 36: 3 Hour normal clean

6. Press **heavy** for a 4-hour clean (Figure 37).



Figure 37: 4 Hour heavy clean

7. Press **START enter** to begin cleaning.



Once active, the door lock motor will begin locking the oven door. **DOOR** will blink in the display.

- Do not try to open the door when the **DOOR** message is blinking or once it is on (allow about 15 seconds for the oven door to completely lock).
- Once the oven door is locked the **CLn** message will appear in the display for the entire fresh clean cycle (Figure 37).

When the fresh clean cycle is finished:

⚠ WARNING

Use caution when opening the oven door after fresh cleaning. The oven may still be very hot and can cause burns. To avoid possible burns, stand to the side of the oven when opening the oven door to allow hot air or steam to escape. The oven bake and broil elements may appear to have cooled after they have been turned off. The elements may still be hot, and burns may occur if these elements are touched before they have cooled.

1. The time of day and **Hot** will show in the display (Figure 38).
2. Once the oven has cooled (about 1 hour) and **Hot** is no longer displayed, the **door lock** message will flash. When this message stops flashing in the display, the door has finished unlocking and may be opened.



Figure 38: Hot oven (door still locked)

⚠ CAUTION

The oven bake and broil elements may appear to have cooled after they have been turned off. The elements may still be hot and burns may occur if these elements are touched before they have cooled.

3. After the oven has cooled, wipe away any residue or powdered ash from the oven interior using a damp cloth or paper towel.



A fresh clean cycle will not start if the control lock feature is active. If a fresh clean cycle was started but did not finish due to a power outage, your oven may not have completely cleaned.

To cancel fresh clean:

1. Press **CANCEL off**.



WARNING

Use caution when opening the oven door after fresh cleaning. The oven may still be very hot and can cause burns. To avoid possible burns, stand to the side of the oven when opening the oven door to allow hot air or steam to escape. The oven bake and broil elements may appear to have cooled after they have been turned off. The elements may still be hot, and burns may occur if these elements are touched before they have cooled.

2. If the fresh clean cycle has heated the oven to a high enough temperature, **Hot** will appear in the display (Figure 39). Allow enough time for the oven to cool and the door to unlock before the oven door may be opened.



Figure 39: Oven too hot for door to unlock

IMPORTANT! Before restarting fresh clean, read the following important notes:

- If your clock is set with the (default) 12 hr display mode, the delay start for a fresh clean can only be programmed to start up to 11 hours and 59 minutes after the time showing in the display (be sure to set the clock to current time before programming a delay start). To set a delay start fresh clean to begin 12 or more hours (maximum is 23 hours and 59 minutes) after the time of setting, be sure to first set the control in the 24 Hr display mode.
- If fresh clean was active and then interrupted by a power failure or cancelled before the oven was thoroughly cleaned, it may be necessary to run another fresh clean cycle.

Setting Delayed Fresh Clean

You may want to set the oven to perform a fresh clean at a later time (up to 12 hours later). The end time key will determine when the cleaning will stop. The end time must be set far enough from the real time to allow for the type of clean cycle you select, whether 2, 3, or 4 hours. Remember to add 30 to 40 additional minutes of cooling time before using the oven for cooking.



If you want to set a delayed fresh clean to end between 12 and 24 hours, use the user pref key to set the 12hr energy saving mode (ES) to Off and also set the clock (CLO) to the 24 hr mode.

Setting for a heavy (4 hour) fresh clean cycle to end at 8:00 o'clock:

WARNING

Do not leave small children unattended near the appliance. During the fresh clean cycle, the outside of the oven can become very hot to touch and can cause burns.

CAUTION

Do not force the oven door open when fresh clean is active. This can damage the automatic door-locking system. Use caution when opening the door after fresh cleaning. The oven may still be very hot and can cause burns. To avoid possible burns, stand to one side of the oven when opening the oven door to allow hot air or steam to escape.

IMPORTANT! The kitchen area should be well ventilated. Use an open window, ventilation fan, or exhaust hood during the first fresh clean cycle to help eliminate the normal odors associated the initial clean cycle.

1. Ensure the oven is empty and remove all oven racks and racks support. Be sure the clock is set with the correct time of day and the oven door is completely closed. In this example, the time of day should be earlier than 4:00 o'clock.
2. Press **OVEN** to light up the available cooking modes keys.

3. Press **fresh clean**.



4. Press **heavy**.



5. Press **cook options**. The end time icon will appear.



6. Press **end time**. The numeric keypad will illuminate.



7. Enter **8 0 0** on the numeric keypad.

8 0 0

8. Press **START enter**. The display will indicate the time remaining before fresh clean begins. When the fresh clean cycle begins, the display will show the time remaining in the fresh clean cycle.



CARE AND CLEANING

Cleaning Various Parts of Your Oven

Before cleaning any part of the oven, be sure all controls are turned off and the oven is cool. Remove spills and any heavy soiling as soon as possible. Regular cleaning will reduce the difficulty and time of major cleaning later.

Surface Type	Recommendation
Aluminum and Vinyl	Use hot, soapy water and a cloth. Dry with a clean cloth.
Painted body parts Painted decorative trims	Use a soft cloth and clean with mild detergent and water or a 50/50 solution of vinegar and water. Follow by rinsing the area with clean water; dry and polish with a soft cloth. Glass cleaners may be used if sprayed on a soft cloth first. Do not spray liquids directly on the oven control and display area. Do not use large amounts of water on the control panel. Excess water on the control area may cause damage to the appliance. Do not use other liquid cleaners, abrasive cleaners, scouring pads, or paper towels. They will damage the finish.
Porcelain enamel broiler pan and insert Door liner and body parts	Gentle scouring with a soapy scouring pad will remove most spots. Rinse with a 1:1 solution of clear water and ammonia. If necessary, cover difficult spots with an ammonia-soaked paper towel for 30 to 40 minutes. Rinse with clean water and a damp cloth, and then scrub with a soap-filled scouring pad. Rinse and wipe dry with a clean cloth. Remove all cleaners or the porcelain may become damaged during future heating.
Oven racks	Oven racks and ladder racks must be removed from oven cavity before the clean cycle for cleaning. Clean by using a mild, abrasive cleaner following manufacturer's instructions. Rinse with clean water and dry.
Glide racks	For instructions on how to care for your glide racks, see "Caring for Your Glide Racks" on page 39
Oven door	Use soap and water to thoroughly clean the top, sides, and front of the oven door. Rinse well. You may use a glass cleaner on the outside glass of the door. Do not immerse the door in water. Do not spray or allow water or the glass cleaner to enter the door vents. Do not use oven cleaners, cleaning powders, or any harsh abrasive cleaning materials on the outside of the oven door. The oven gasket located on the inner frame of the door and visible when the door is opened is essential for a good seal. Do not clean the oven door gasket. On fresh clean models, the oven door gasket is made of a woven material. Care should be taken not to rub, damage, or remove this gasket.
Stainless Steel (some models)	Only use cleaners and polishes that are specifically manufactured for cleaning stainless steel. Always rub in direction of metal grain to avoid damaging. Do not use cleaners with high concentrations of chlorides or chlorine. Do not use harsh scrubbing cleaners. Polish with a lint-free cloth. Always be sure to wipe excess cleaner/polish off from the metal surface as bluish stains may occur during future oven heating that cannot be removed. Clean heavier soils with hot, soapy water and a cloth or sponge. Rinse and dry using clean water and a cloth.

Caring for Your Glide Racks

⚠ CAUTION

Handle oven racks only when they are cool. After cooking or after the fresh-clean cycle, racks will be very hot and can cause burns.

Important Notes:

- Remove all oven racks, including ladder racks, before starting a clean cycle.
- Do not use cooking oil, cooking spray, or other oil-based lubrication products on the glide rack extension tracks. Use only the graphite lubrication in this area. To order graphite lubrication, contact your installer, servicer or dealer.
- It is important that the parts of the rack that contact the oven sides always have a light coating of vegetable oil. Apply a thin layer of vegetable oil to the sides of the rack after every fresh-clean cycle and when the rack becomes difficult to reposition in the oven.

To lubricate the glide rack:

1. Remove the rack from the oven and place the rack on a large flat surface covered with newspaper or scrap cloth. Fully extend the rack.
2. Wipe away debris and crumbs from the glide track using a cloth or sponge.

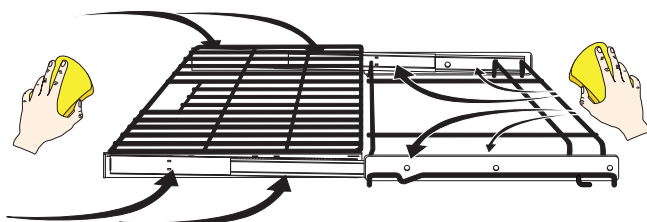

3. Shake graphite lubrication very well before applying. Place four drops of graphite lubrication along the tracks (see area circled on figure below). Repeat on both sides of the glide rack.

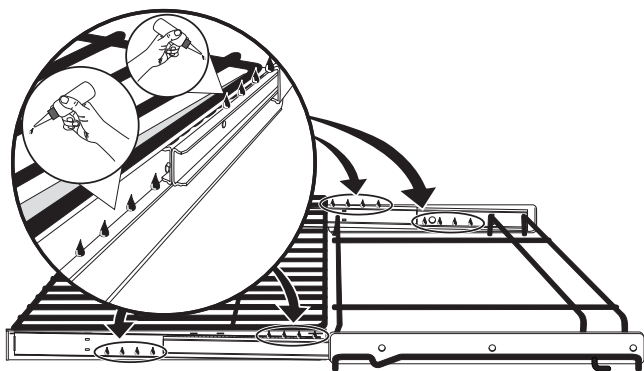

4. Extend and return the glide rack several times along the tracks to distribute the lubrication.

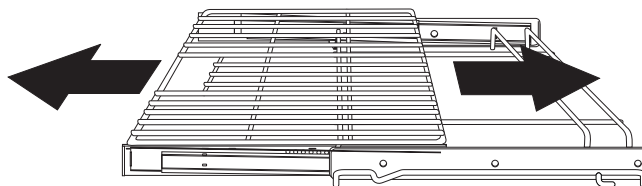

5. Turn glide rack over. Shake graphite lubrication very well before applying. Place four drops of graphite lubrication along the tracks. Repeat on both sides of the glide rack.

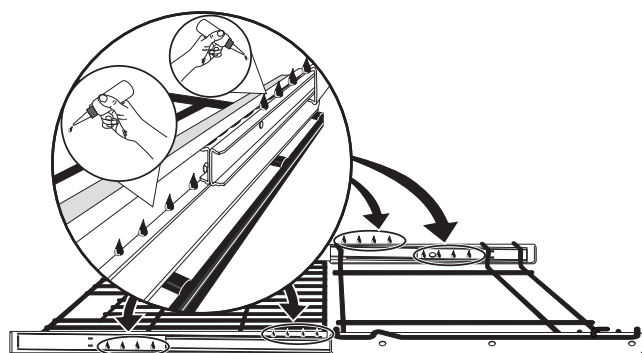

6. Extend and return the glide rack several times along the tracks to distribute the lubrication.

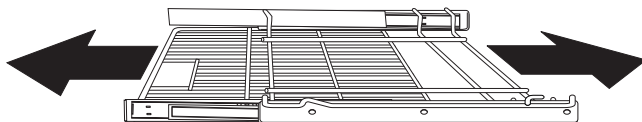

7. Apply a thin layer of cooking oil to the outer frame of the glide rack as shown below. Keeping the frame sides lightly lubricated allows the entire rack to slide easily when changing rack positions.

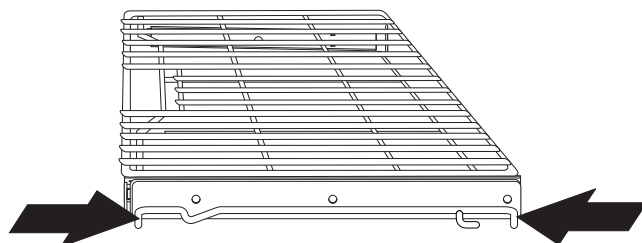

8. Replace rack in oven right-side up.

Removing and Replacing the Oven Door

To remove the oven door:

CAUTION

The door is heavy. For safe, temporary storage, lay the door flat with the inside of the door facing down.

WARNING

To prevent possible burns, do not attempt to remove the oven door until the oven has completely cooled.

1. Open oven door completely, horizontal with floor.
2. Pull up the lock located on each hinge support toward front of the oven. You may have to apply a little upward pressure on the lock to pull it up (Figure 41 and Figure 42).
3. Grasp the door by the sides, pull the bottom of the door up and toward you to disengage the hinge supports.
4. Keep pulling the bottom of the door toward you while rotating the top of the door toward the appliance to completely disengage the hinge levers (Figure 43).

To Replace Oven Door:

1. Firmly grasp both sides of oven door along the door sides. Do not use the oven door handle (Figure 43).
2. Holding the oven door at the same angle as the removal position, seat the hook of the hinge arm over the roller pins located on each side of the oven door frame (Figure 43). The hook of the hinge arms must be fully seated onto the roller pins.
3. Fully open the oven door, horizontal with floor (Figure 40).
4. Push the door hinge locks up toward and into the oven frame on both left and right oven door hinges to the locked position (Figure 41).
5. Close the oven door.

IMPORTANT!

Special Door Care Instructions - Most oven doors contain glass that can break. Do not close the oven door until all the oven racks are fully in place. Do not hit the glass with pots, pans, or any other object. Scratching, hitting, jarring, or stressing the glass may weaken its structure causing an increased risk of breakage at a later time.



Figure 40: Door at horizontal position

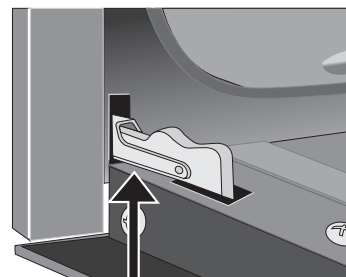

Figure 41: Door hinge locks

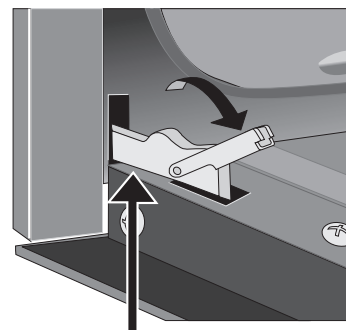

Figure 42: Hinge: unlocked position

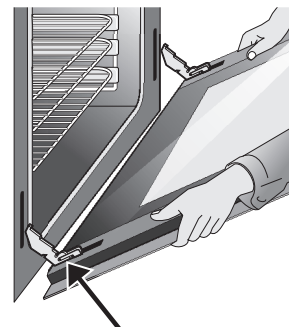

Figure 43: Holding door for removal

Replacing the Dual Left/Right Corner Oven Lights

The interior oven lights are located at the rear of the oven cavity and are covered with a glass shield. The glass shield must be in place whenever the oven is in use (Figure 44).

To replace the oven interior light bulb:

CAUTION

Be sure the oven is unplugged and all parts are cool before replacing oven light. Wear a leather-faced glove for protection against possible broken glass.

1. Turn electrical power off at the main source.
2. Remove interior oven light shield by turning a quarter turn counter-clockwise.
3. Replace bulb with a new T-4 type Halogen 25 watt appliance bulb.



Do not allow your fingers to touch the new bulb when replacing. This will shorten the life of the bulb. Use a paper towel or cotton glove while handling the new bulb when installing.

4. Replace glass oven light shield by rotating clockwise.
5. Turn power back on again at the main source (or plug the appliance back in).
6. Be sure to reset the time of day on the clock.

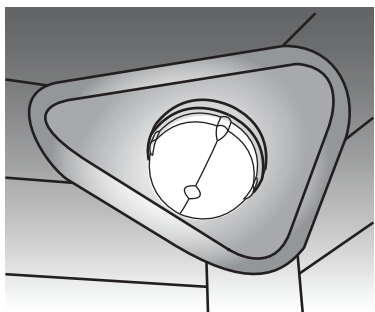

Figure 44: Wall oven Halogen light

Replacing the Dual Left/Right Side Oven Lights

An interior oven light will turn on automatically when the oven door is opened. The oven light may be turned on when the door is closed by using the oven light switch located on the control panel.



The lamp is covered with a glass shield. The glass shield can be removed to be cleaned manually or to change the oven light.

To replace the oven interior light bulb:

CAUTION

Be sure the range is unplugged and all parts are cool before replacing oven light. Wear a leather-faced glove for protection against possible broken glass.

1. Turn electrical power off at the main source or unplug the appliance.
2. To remove the glass shield, pull the back side of the shield toward the inside of the oven in a manner to lift it up from the oven side. The glass shield should come out easily by pushing a little toward front of the wall oven (Figure 45).
3. Replace the Halogen appliance bulb.



Do not allow your fingers to touch the new bulb when replacing. This will shorten the life of the new bulb. Use a paper towel to cover the new bulb when installing.

4. Replace glass interior oven light shield.
5. Turn power back on again at the main source (or plug the appliance back in).
6. Be sure to reset the time of day on the clock.

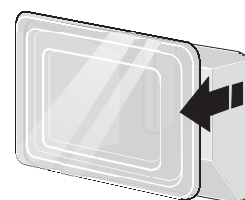

Lift backside of glass shield and remove it.

Figure 45: Wall oven Halogen light

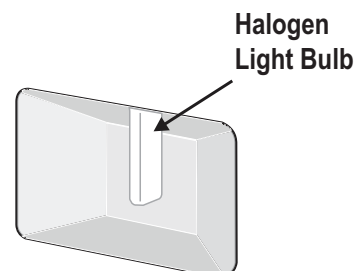

Figure 46: Wall oven Halogen light

Broiler Pan Cleaning Tips

To make cleaning easier, line the bottom of the broiler pan with aluminum foil. Do not cover the broiler grid with foil.

To prevent grease from baking on, remove the broiler pan from the oven as soon as cooking is completed. Use hot pads because the broiler pan is extremely hot. Pour off grease. Soak the pan in hot, soapy water.

Clean the broiler pan as soon as possible after each use. If necessary, use soap-filled steel wool pads. Heavy scouring may scratch the grid.

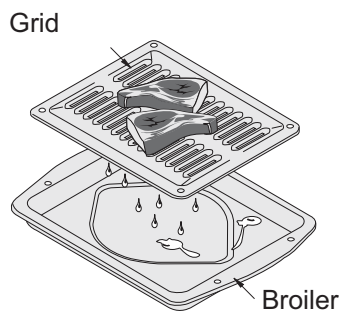

Figure 47: Broiler pan and grid

Aluminum Foil and Oven Liners

Do not use oven bottom liners or use aluminum foil to cover the oven racks.

⚠ CAUTION

Protective liners—Do not use aluminum foil to line the oven bottom, except as suggested in the manual. Improper installation of these liners may result in a risk of electrical shock, or fire.

Using a liner in the oven restricts the heat and air flow needed to obtain the best possible cooking results for any oven.

During fresh clean the oven temperature can become hot enough to melt aluminum cooking utensils or aluminum foil if left in the oven. This could result in permanent damage to the oven interior and porcelain finish.

BEFORE YOU CALL





SOLUTIONS TO COMMON PROBLEMS

Oven Baking

For best baking results, heat the oven before baking cookies, breads, cakes, pies, or pastries, etc. There is no need to preheat the oven for roasting meat or baking casseroles.

The baking times and temperatures needed to bake a product may vary slightly from your previously owned appliance.

Baking Problems and Solutions

Baking Problems	Causes	Corrections
<p>Cookies and biscuits burn on the bottom.</p> 	<ul style="list-style-type: none"> • Cookies and biscuits put into oven before the preheating time is completed. • Oven rack is overcrowded or rack position too low. • Dark pans absorbs heat too fast. 	<ul style="list-style-type: none"> • Allow oven to preheat to desired temperature before placing food in oven. • Choose pan sizes that will permit 2" to 4" of air space (5.1 cm to 10.2 cm) on all sides when placed in the oven. • Use a medium weight baking sheet.
<p>Cakes too dark on top or bottom</p> 	<ul style="list-style-type: none"> • Cakes put in oven before preheating time is completed. • Rack position too high or too low. • Oven too hot. 	<ul style="list-style-type: none"> • Allow oven to preheat to the selected temperature before placing food in the oven. • Use proper rack position for baking needs. • Set oven temperature 25°F (14°C) lower than recommended.
<p>Cakes not done in center</p> 	<ul style="list-style-type: none"> • Oven too hot. • Incorrect pan size. • Pan not centered in oven. 	<ul style="list-style-type: none"> • Set oven temperature 25°F (14°C) lower than recommended. • Use pan size suggested in recipe. • Use proper rack position and place pan so there is 5.1 cm to 10.2 cm (2" to 4") of space on all sides of pan.
<p>Cakes not level.</p> 	<ul style="list-style-type: none"> • Oven not level. • Pan too close to oven wall or rack overcrowded. • Pan warped. • Oven light left on during baking 	<ul style="list-style-type: none"> • Place a marked glass measuring cup filled with water on the center of the oven rack. If the water level is uneven, refer to the installation instructions for leveling the oven. • Be sure to allow 5.1 cm to 10.2 cm (2" to 4") of clearance on all sides of each pan in the oven. • Do not use pans that are dented or warped. • Do not leave oven light on while baking.
<p>Foods not done when baking time is over.</p> 	<ul style="list-style-type: none"> • Oven too cool. • Oven overcrowded. • Oven door opened too frequently. 	<ul style="list-style-type: none"> • Set oven temperature 25°F (14°C) higher than suggested and bake for the recommended time. • Be sure to remove all pans from the oven except the ones to be used for baking. • Open oven door only after shortest recommended baking time.

Solutions to Common Problems

Before you call for service, review the following list. It may save you time and expense. Possible solutions are provided with the problem listed:

Problem	Solution
Poor baking results	<ul style="list-style-type: none"> Many factors effect baking results. Use proper oven rack position. Center food in the oven and space pans to allow air to circulate. Preheat oven to the set temperature before placing food in the oven. Bakeware may be too lightweight or warped. Use heavier quality bakeware so foods being prepared may bake more evenly. Try adjusting the recipe's recommended temperature or baking time. See "Adjusting the Oven Temperature" on page 32 if you feel the oven is too hot or cold.
Oven does not operate.	<ul style="list-style-type: none"> The time of day is not set. The oven clock must first be set in order to operate the oven. Be sure oven controls are set properly. See "Setting the Clock-Time of Day" on page 11 and review instructions for the desired baking function in this user's guide. Service wiring is not complete. Contact your dealer, installing agent, or authorized servicer. Power outage. Check house lights to be sure. Call your local electric company. Short in cord/plug. Contact your dealer, installing agent, or authorized servicer to replace cord/plug. House fuse has blown or circuit breaker has tripped immediately following installation. House fuse may not be fully engaged. Check fuse and screw or engage circuit breaker securely.
Oven light does not work.	<ul style="list-style-type: none"> Be sure the oven light is secure in the socket. See "Replacing the Dual Left/Right Corner Oven Lights" and "Replacing the Dual Left/Right Side Oven Lights" on page 41.
Flames inside oven or smoking from oven vent.	<ul style="list-style-type: none"> Excessive spills in oven. Grease or food spilled onto oven bottom or oven cavity. Wipe up excessive spills before starting oven. If flames or excessive smoke are present when using broil, see "Broil" on page 17.
Fresh clean does not work.	<ul style="list-style-type: none"> Oven control not set properly. Make sure the oven door is closed. Make sure you have removed the oven racks and the oven rack supports from the oven. Review "Fresh Clean" on page 35.
Oven racks discolored or do not slide easily.	<ul style="list-style-type: none"> Oven racks left in oven cavity during clean. Always remove oven racks from oven cavity before starting a clean cycle. Clean using a mild abrasive cleaner following manufacturer's instructions. Rinse with clean water, dry, and replace in oven.
Glide racks do not slide smoothly	<ul style="list-style-type: none"> Glide racks need lubrication. For instructions on how to care for your oven racks, see "Caring for Your Glide Racks" on page 39
Oven smokes excessively when broiling.	<ul style="list-style-type: none"> Incorrect setting. Follow broiling instructions in the "Broil" on page 17. Meat too close to the broil element. Reposition broil rack to provide proper clearance between the meat and broil element. Remove excess fat from meat. Cut remaining fatty edges to prevent curling, but do not cut into the lean. Grid on broiler pan wrong side up. Grease does not drain into broiler pan. Always place the grid on the broiler pan with the ribs up and the slots down to allow grease to drip into the pan. Broiler pan used without grid or grid cover with aluminum foil. Do not use the broiler pan without the grid or cover the grid with aluminum foil. Oven needs to be cleared. Grease build up on oven surfaces. Regular cleaning is necessary when broiling frequently. Grease or food splatters will cause excessive smoking.
Oven control panel chimes and displays an F code error.	<ul style="list-style-type: none"> Oven control has detected a fault or error condition. Press STOP to clear the error code. Try bake or broil function. If the F code error repeats, turn off power to appliance, wait 5 minutes and then repower appliance. Set clock with correct time of day. Try bake or broil function again. If fault recurs, press STOP to clear.

Soil not completely removed after fresh clean.	<ul style="list-style-type: none">• Fresh clean was interrupted. Review “Fresh Clean” on page 35.• Excessive spills on oven bottom. Clean before starting fresh clean.• Failure to clean soil from the oven frame, the door liner outside the oven door gasket, and the small area at the front center of the oven bottom. These areas are not in the fresh cleaning area, but they get hot enough to burn on residue. Clean these areas before starting the fresh clean cycle. Burned-on residue can be cleaned with a stiff nylon brush and water or a nylon scrubber. Be careful not to damage the oven gasket.
Appliance is not level.	<ul style="list-style-type: none">• Poor installation. Place oven rack in center of oven. Place a level on the oven rack. Adjust leveling leg at base of appliance until the oven rack is level.• Kitchen cabinet alignment may make oven appear not level. Be sure cabinets are square and have sufficient room for appliance clearance.• Cabinets not square or are built in too tightly. Contact builder or installer to make appliance accessible.
Fan noise occurring after the oven is turned off.	<ul style="list-style-type: none">• Some models are equipped with a cooling fan that runs during the cooking process to cool internal electronic components. It is normal for this fan to continue to run for an extended period of time, even when the oven is off.

WARRANTY

Your appliance is covered by a one year limited warranty. For one year from your original date of purchase, Electrolux will repair or replace any parts of this appliance that prove to be defective in materials or workmanship when such appliance is installed, used, and maintained in accordance with the provided instructions. In addition, the glass cooktop or radiant surface element of your appliance (excluding built-in and free-standing range appliances) is covered by a two through five year limited warranty. During the 2nd through 5th years from your original date of purchase, Electrolux will provide a replacement glass cooktop or radiant surface element for your appliance which has proven to be defective in materials or workmanship when such appliance is installed, used, and maintained in accordance with the provided instructions.

Exclusions

This warranty does not cover the following:

1. Products with original serial numbers that have been removed, altered or cannot be readily determined.
2. Product that has been transferred from its original owner to another party or removed outside the USA or Canada.
3. Rust on the interior or exterior of the unit.
4. Products purchased "as-is" are not covered by this warranty.
5. Products used in a commercial setting.
6. Service calls which do not involve malfunction or defects in materials or workmanship, or for appliances not in ordinary household use or used other than in accordance with the provided instructions.
7. Service calls to correct the installation of your appliance or to instruct you how to use your appliance.
8. Expenses for making the appliance accessible for servicing, such as removal of trim, cupboards, shelves, etc., which are not a part of the appliance when it is shipped from the factory.
9. Service calls to repair or replace appliance light bulbs, air filters, water filters, other consumables, or knobs, handles, or other cosmetic parts.
10. Labor or in-home service costs during the additional limited warranty periods beyond the first year from your original date of purchase.
11. Pickup and delivery costs; your appliance is designed to be repaired in the home.
12. Surcharges including, but not limited to, any after hour, weekend, or holiday service calls, tolls, ferry trip charges, or mileage expense for service calls to remote areas, including the state of Alaska.
13. Damages to the finish of appliance or home incurred during transportation or installation, including but not limited to floors, cabinets, walls, etc.
14. Damages caused by: services performed by unauthorized service companies; use of parts other than genuine Electrolux parts or parts obtained from persons other than authorized service companies; or external causes such as abuse, misuse, inadequate power supply, accidents, fires, or acts of God.

DISCLAIMER OF IMPLIED WARRANTIES; LIMITATION OF REMEDIES

CUSTOMER'S SOLE AND EXCLUSIVE REMEDY UNDER THIS LIMITED WARRANTY SHALL BE REPAIR OR REPLACEMENT AS PROVIDED HEREIN. **CLAIMS BASED ON IMPLIED WARRANTIES, INCLUDING WARRANTIES OF MERCHANTABILITY OR FITNESS FOR A PARTICULAR PURPOSE, ARE LIMITED TO ONE YEAR OR THE SHORTEST PERIOD ALLOWED BY LAW, BUT NOT LESS THAN ONE YEAR.** ELECTROLUX SHALL NOT BE LIABLE FOR CONSEQUENTIAL OR INCIDENTAL DAMAGES SUCH AS PROPERTY DAMAGE AND INCIDENTAL EXPENSES RESULTING FROM ANY BREACH OF THIS WRITTEN LIMITED WARRANTY OR ANY IMPLIED WARRANTY. SOME STATES AND PROVINCES DO NOT ALLOW THE EXCLUSION OR LIMITATION OF INCIDENTAL OR CONSEQUENTIAL DAMAGES, OR LIMITATIONS ON THE DURATION OF IMPLIED WARRANTIES, SO THESE LIMITATIONS OR EXCLUSIONS MAY NOT APPLY TO YOU. THIS WRITTEN WARRANTY GIVES YOU SPECIFIC LEGAL RIGHTS. YOU MAY ALSO HAVE OTHER RIGHTS THAT VARY FROM STATE TO STATE.

If You Need Service

Keep your receipt, delivery slip, or some other appropriate payment record to establish the warranty period should service be required. If service is performed, it is in your best interest to obtain and keep all receipts. Service under this warranty must be obtained by contacting Electrolux at the addresses or phone numbers below. This warranty only applies in the USA, Puerto Rico and Canada. In the USA and Puerto Rico, your appliance is warranted by Electrolux Major Appliances North America, a division of Electrolux Home Products, Inc. In Canada, your appliance is warranted by Electrolux Canada Corp. Electrolux authorizes no person to change or add to any obligations under this warranty. Obligations for service and parts under this warranty must be performed by Electrolux or an authorized service company. Product features or specifications as described or illustrated are subject to change without notice.

USA

1-877-435-3287

Electrolux Major Appliances North America
10200 David Taylor Drive
Charlotte, NC 28262

Canada

1-800-265-8352

Electrolux Canada Corp.
5855 Terry Fox Way
Mississauga, Ontario, Canada L5V 3E4

electrolux.com/shop



CE

