

# FRIGIDAIRE

All about the

# Use & Care

of your Gas Range



## TABLE OF CONTENTS

|   |    |                             |    |
|---|----|-----------------------------|----|
| Product Record and Registration . . . . . | 2  | Care and Cleaning . . . . . | 29 |
| Important Safety Instructions . . . . .   | 3  | Before You Call . . . . .   | 33 |
| Before Setting Surface Controls . . . . . | 8  | Warranty . . . . .          | 36 |
| Setting Surface Burners . . . . .         | 9  |                             |    |
| Before Setting Oven Controls . . . . .    | 12 |                             |    |
| Oven Controls . . . . .                   | 14 |                             |    |

# PRODUCT RECORD AND REGISTRATION

|                                       |    |
|---------------------------------------|----|
| Product Record and Registration ..... | 2  |
| Important Safety Instructions .....   | 3  |
| Before Setting Surface Controls ..... | 8  |
| Setting Surface Burners .....         | 9  |
| Before Setting Oven Controls .....    | 12 |
| Oven Controls .....                   | 14 |
| Care and Cleaning .....               | 29 |
| Before You Call .....                 | 33 |
| Warranty .....                        | 36 |

Thank you for choosing **Frigidaire**.

This Use and Care Guide is part of our commitment to customer satisfaction and product quality throughout the service life of your new appliance. We view your purchase as the beginning of a relationship. To ensure our ability to continue serving you, please use this page to record important product information.

## Questions?

For toll-free telephone support in the U.S. and Canada call **1-800-944-9044**

For online support and Internet production information visit **www.frigidaire.com**.

## Need Help?

Visit the Frigidaire web site at **www.frigidaire.com**

Before you call for service, there are a few things you can do to help us serve you better.

## Read this Use & Care Manual

This manual contains instructions to help you use and maintain your range properly.

## If You Received a Damaged Range...

Immediately contact the dealer (or builder) that sold you the range.

## Save Time and Money

Check the section title "Before You Call". This section helps step you through some common problems that might occur.

If you do need service, help is only a phone call away. Call Frigidaire Customer Services at **1-800-944-9044**.

## Product Registration

Registering your product with Frigidaire enhances our ability to serve you. Register online at **www.frigidaire.com** or by dropping your Product Registration Card in the mail.

## Record model & serial numbers here

---

Purchase Date

---

Frigidaire model number

---

Frigidaire serial number

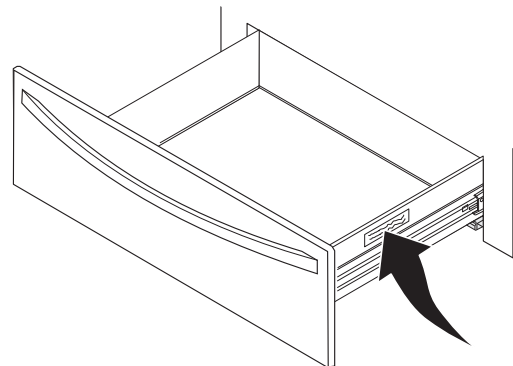

# IMPORTANT SAFETY INSTRUCTIONS

## CAUTIONS AND WARNINGS

Read all instructions before using this appliance.

This manual contains important safety symbols and instructions. Please pay attention to these symbols and follow all instructions given.

Do not attempt to install or operate your appliance until you have read the safety precautions in this manual. Safety items throughout this manual are labeled with a WARNING or CAUTION statement based on the risk type.

## DEFINITIONS

 This is the safety alert symbol. It is used to alert you to potential personal injury hazards. Obey all safety messages that follow this symbol to avoid possible injury or death.

### WARNING

Indicates a potentially hazardous situation which, if not avoided, may result in death or serious injury.

### CAUTION

Indicates a potentially hazardous situation which, if not avoided, may result in minor or moderate injury.

### IMPORTANT

Indicates installation, operation, maintenance, or valuable information that is not hazard related.

### NOTE

Indicates a short, informal reference. Usually something written down to assist the memory or for future reference.

### WARNING

If the information in this manual is not followed exactly, a fire or explosion may result causing property damage, personal injury or death.

**FOR YOUR SAFETY:** Do not store or use gasoline or other flammable vapors and liquids in the vicinity of this or any other appliance.

#### WHAT TO DO IF YOU SMELL GAS:

- Do not try to light any appliance.
- Do not touch any electrical switch.
- Do not use any phone in your building.
- Immediately call your gas supplier from a neighbor's phone. Follow the gas supplier's instructions.
- If you cannot reach your gas supplier, call the fire department.
- Installation and service must be performed by a qualified installer, servicer or the gas supplier.

### WARNING

Storage In or On Appliance—Flammable materials should not be stored in an oven or near surface units. This includes paper, plastic, and cloth items, such as cookbooks, plastic ware, and towels, as well as flammable liquids. Do not store explosives, such as aerosol cans, on or near the oven.

## IMPORTANT SAFETY INSTRUCTIONS

### ➔ IMPORTANT

Read and follow the below instructions and precautions for unpacking, installing, and servicing your appliance:

- Remove all tape and packaging before using the oven. Destroy the carton and plastic bags after unpacking the oven. Never allow children to play with packaging material.
- Proper installation is essential. Be sure your appliance is properly installed and grounded by a qualified technician in accordance with the National Electrical Code ANSI/NFPA No. 70 latest edition and local electrical code requirements. In Canada, install in accordance with CSA Standard C22.1, Canadian Electrical code, Part 1, and local electrical code requirements. Install only per installation instructions provided in the literature package for this oven.
- User Servicing - Do not repair or replace any part of the appliance unless specifically recommended in the manuals. All other servicing should be done only by a qualified technician. This reduces the risk of personal injury and damage to the oven.
- Ask your dealer to recommend a qualified technician and an authorized repair service. Know how to disconnect the power to the oven at the circuit breaker or fuse box in case of an emergency.
- Never modify or alter the construction of an oven by removing the leveling legs, panels, wire covers, anti-tip brackets/screws, or any other part of the oven.
- Remove the oven door from any unused oven if it is to be stored or discarded.
- Be sure to have an appropriate foam-type fire extinguisher available, visible, and easily accessible located near the appliance.

### ⚠ WARNING

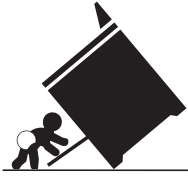

#### Tip Over Hazard

- **A child or adult can tip the range and be killed.**
- **Verify the anti-tip device has been installed to floor or wall.**
- **Ensure the anti-tip device is re-engaged to floor or wall when the range is moved.**
- **Do not operate the range without the anti-tip device in place and engaged.**
- **Failure to follow these instructions can result in death or serious burns to children and adults.**

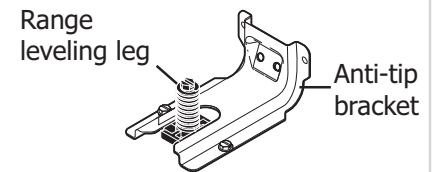

To check if the anti-tip bracket is installed properly, use both arms to grasp the rear edge of the range back. Carefully attempt to tilt range forward. When properly installed, the range should not tilt forward.

Refer to the anti-tip bracket installation instructions supplied with your range for proper installation.

### ➔ IMPORTANT

Cold temperatures can damage the electronic control. When using this appliance for the first time, or when the appliance has not been used for an extended period of time, be sure the appliance has been in temperatures above 32°F (0°C) for at least 3 hours before turning on the power to the appliance.

Do not attempt to operate the oven during a power failure. If the power fails, always turn off the oven. If the oven is not turned off and the power resumes, the oven will not operate. Once the power resumes, reset the clock and oven function.

## IMPORTANT SAFETY INSTRUCTIONS

### WARNING

- Do Not Leave Children Alone - Children should not be left alone or unattended in the area where appliance is in use. They should never be allowed to sit or stand on any part of the appliance, including the storage drawer, lower broiler drawer, warmer drawer, or lower double oven.
- Do not store items of interest to children near or in cabinets above appliance. Children climbing on the range to reach items could be seriously injured.
- Stepping, leaning, or sitting on the door or drawers of a oven can result in serious injuries and also cause damage to the appliance. Do not allow children to climb or play around the oven. The weight of a child on an open oven door may cause the oven to tip, resulting in serious burns or other injury.
- Never cover any slots, holes, or passages in the oven bottom or cover an entire oven rack with materials, such as aluminum foil or any other oven liners or materials. Aluminum foil linings or other oven linings may trap heat, causing a fire hazard.

Important Safety Notice - The California Safe Drinking Water and Toxic Enforcement Act requires the governor of California to publish a list of substances known to cause cancer, birth defects, or other reproductive harms, and requires businesses to warn customers of potential exposures to such substances.

### CAUTION

- When heating fat or grease, watch it closely. Grease may catch fire if it becomes too hot.
- Do not use water or flour on grease fires. Smother fire or flame or use a dry chemical or foam-type extinguisher. Cover the fire with a pan lid or use baking soda.
- Use dry potholders. Moist or damp potholders on hot surfaces may result in burns from steam. Do not let potholders touch hot cooking areas. Do not use towels or other bulky cloths.
- Do not heat unopened food containers. Build-up of pressure may cause container to burst and result in injury.
- Wear proper apparel. Loose-fitting or hanging garments should never be worn while using the appliance.
- Do not touch heating elements or interior surfaces of oven. Heating elements may be hot even though they are dark in color. Interior surfaces of an oven become hot enough to cause burns.
- During and after use, do not touch, or let clothing or other flammable materials contact heating elements or interior surfaces of oven until they have had sufficient time to cool. Other surfaces of the appliance may become hot enough to cause burns - among these surfaces are oven vent openings and surfaces near these openings, oven doors, and windows of oven doors.

## IMPORTANT SAFETY INSTRUCTIONS

### IMPORTANT INSTRUCTIONS FOR USING YOUR COOKTOP

#### **WARNING**

Use Proper Flame Size — Adjust flame size so it does not extend beyond the edge of the utensil. The use of undersized utensils will expose a portion of the burner flame to direct contact and may result in ignition of clothing. Proper relationship of utensil to flame will also improve efficiency.

- Know which knob controls each surface burner. Place a pan of food on the burner before turning it on, and turn the burner off before removing the pan.
- Always turn knob to the full LITE position when igniting top burners. Visually check that burner has lit. Then adjust the flame so it does not extend beyond the edge of the utensil.
- To reduce the risk of burns, ignition of flammable materials, and spillage due to unintentional contact with the utensil, the handle of the utensil should be positioned so that it is turned inward, and does not extend over adjacent surface burners.
- Never leave surface burners unattended at high heat settings — Boil overs cause smoking and greasy spill overs that may ignite, or a pan that has boiled dry may melt.
- Glazed cooking utensils — Only certain types of glass, glass/ceramic, ceramic, earthenware, or other glazed utensils are suitable for cook top service without breaking due to the sudden change in temperature. Check the manufacturer's recommendations for cook top use.
- When you are flaming foods under a ventilating hood, turn the fan on.
- Air curtain or other overhead range hoods, which operate by blowing a downward air flow on to a range, shall not be used in conjunction with gas ranges other than when the hood and range have been designed, tested and listed by an independent test laboratory for use in combination with each other.

### IMPORTANT INSTRUCTIONS FOR USING YOUR OVEN

- Never use your appliance for warming or heating the room.
- Use care when opening oven door, lower oven door, or warmer drawer (some models). Stand to the side of the oven when opening the door of a hot oven. Let hot air or steam escape before you remove or replace food in the oven.
- Keep oven vent ducts unobstructed. Touching surfaces in this area when the oven is on may cause severe burns. Do not place plastic or heat-sensitive items on or near the oven vent. These items can melt or ignite.
- Placement of Oven Racks - Always place oven racks in desired location while oven is cool. If rack must be moved while oven is hot, do not let potholders contact hot heating element in oven. Use potholders and grasp the rack with both hands to reposition. Remove all cookware and utensils before moving the rack.
- Do not use a broiler pan without its insert. Broiler pans and inserts allow dripping fat to drain away from the high heat of the broiler. Do not cover the broiler insert with aluminum foil or any other material; exposed fat and grease could ignite.
- Protective Liners - Do not use aluminum foil or any other materials or liners to line surface or oven bottoms, except as suggested in the manual. Improper installation of these liners may result in a risk of electric shock, or fire.
- Do not cook food on the oven bottom. Always cook in proper cookware and always use the oven racks.



## IMPORTANT SAFETY INSTRUCTIONS

### IMPORTANT INSTRUCTIONS FOR CLEANING YOUR OVEN

#### **⚠ CAUTION**

Before manually cleaning any part of the oven, be sure all controls are turned off and the oven is cool.

- Clean the oven regularly to keep all parts free of grease that could catch fire.
- Always follow the manufacturer's recommended directions for use of kitchen cleaners and aerosols. Be aware that excess residue from cleaners and aerosols may ignite causing damage and injury.
- Clean ventilating hoods frequently. Grease should not be allowed to accumulate on the hood or filter. Follow the manufacturer's instructions for cleaning hoods.

#### SELF CLEANING OVENS

- Clean only the parts listed in this manual. Before using clean, remove the broiler pan, any food, utensils, and cookware from the oven. Remove oven racks unless otherwise instructed.
- Do not use oven cleaners. No commercial oven cleaner or oven liner protective coating of any kind should be used in or around any part of the oven.
- Do not clean the oven door gasket. The door gasket is essential for a good seal. Care should be taken not to rub, damage, or move the gasket.
- Some birds are extremely sensitive to the fumes given off during the clean cycle of any oven. Move birds to another well-ventilated room.

#### GROUNDING INSTRUCTIONS.

#### **⚠ WARNING**

Avoid fire hazard or electrical shock. Do not use an adapter plug, an extension cord, or remove the grounding prong from the electrical power cord. Failure to follow this warning may cause serious injury, fire, or death.

This appliance is equipped with a 3-prong grounding plug for your protection against shock hazard and should be plugged directly into a properly grounded receptacle. Do not cut or remove the grounding prong from this plug.

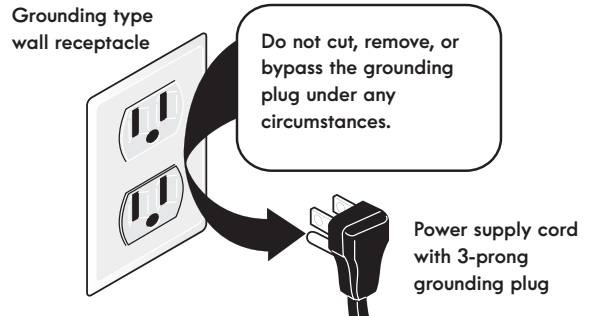

For personal safety, the range must be properly grounded. For maximum safety, the power cord must be plugged into an electrical outlet that is correctly polarized and properly grounded.

If a 2-prong wall receptacle is the only available outlet, it is the personal responsibility of the consumer to have it replaced with a properly grounded 3-prong wall receptacle, installed by a qualified technician.

See the installation instructions packaged with this appliance for complete installation and grounding instructions.

#### Conversion to L.P. Gas

This appliance allows for conversion to **Liquefied Petroleum (L.P.) Gas**. If L.P. conversion is needed, contact your local L.P. Gas provider for assistance.

#### **⚠ WARNING**

Personal injury or death from electrical shock may occur if the conversion to L.P. gas is not made by a qualified installer or electrician. Any additions, changes or conversions required in order for this appliance to satisfactorily meet the application needs must be made by a qualified technician.

## BEFORE SETTING SURFACE CONTROLS

### Control locations of the gas surface burners

Your range is equipped with gas surface burners with different BTU ratings. The ability to heat food quicker and in larger volumes increases as the burner size increases.

The small simmer burner is best used for simmering delicate sauces, etc. This burner is located at the right rear burner position on the cooktop. The standard burner can be used for most surface cooking needs. The standard burners are located at the left front and left rear positions on the cooktop.

The power burners are best used for bringing large quantities of liquid rapidly up to temperature or when preparing larger quantities of food. The power burner is located at the right front position on the cooktop. Regardless of size, always select cookware that is suitable for the amount and type of food being prepared. Select a burner and flame size appropriate to the pan. Never allow flames to extend beyond the outer edge of the pan.

### Assembly of the surface burner caps and burner grates

It is very important to make sure that all of the surface burner caps and surface burner grates are installed correctly and at the correct locations.

1. Remove all packing material from cooktop area.
2. Discard all packing material (if applicable).
3. Unpack burner grates and position on the cooktop.

#### → IMPORTANT

- The grates are designed to rest inside the recess on the cooktop.
- To install burner grates, place grates flat-side down and align into the cooktop recess.
- Grates should rest flush against each other and against the sides of the recess.

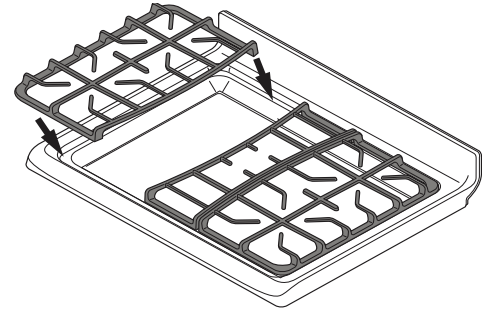
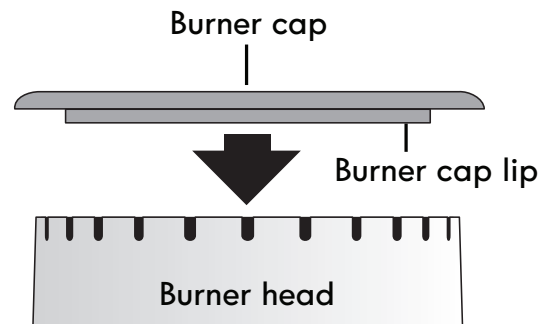

Figure 1: Proper grate installation



#### → IMPORTANT

Do not allow spills, food, cleaning agents or any other material to enter the gas orifice holder opening.

Always keep the burner caps and burner heads in place whenever the surface burners are in use.

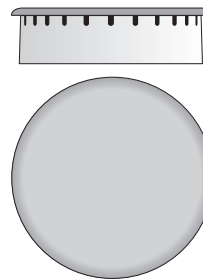

Correct burner cap placement

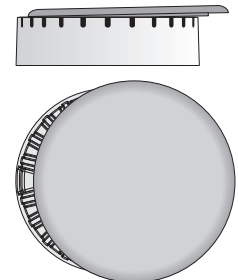

Incorrect burner cap placement



## SETTING SURFACE BURNERS

### → IMPORTANT

- Do not cook with the surface control knob left in the **LITE** position. The electronic ignitor will continue to spark if the control knob setting remains in the **LITE** position.
- When setting any surface control knob to the **LITE** position, all electronic surface ignitors will spark at the same time. However, only the surface burner you are setting will ignite.
- Never place or straddle a cooking utensil over two different surface cooking areas at the same time. This can cause uneven heating results.
- In the event of an electrical power outage, the surface burners can be lit manually. Use caution when lighting surface burners manually. To light a surface burner, hold a lit match to the burner head, then slowly turn the surface control knob to **LITE**. After burner lights push in and turn knob to desired setting.
- When operating the oven, it is possible for residual heat from the oven to build-up and over time to eventually transfer to the surface control knobs located directly above the oven door.
- Do not place flammable items such as plastic salt and pepper shakers, spoon holders or plastic wrappings on the cooktop when it is in use. These items could melt or ignite. Potholders, towels, or wooden spoons could catch fire if placed too close to the range cooktop.
- Do not place aluminum foil or any material that can melt on the range cooktop. If these items melt they may permanently damage the cooktop surface.

### Operating the gas surface controls

1. Place cooking utensil on surface burner.
2. Push the surface control knob in and turn counterclockwise out of the OFF position.
3. Release the knob and rotate to the LITE position (see figure 2). Note: All four electronic surface ignitors will spark at the same time. However, only the burner you are turning on will ignite.
4. Visually check that the burner has a flame.
5. Turn the control knob counterclockwise to the desired flame size. The control knobs do not have to be set at a particular setting. Use the knob indicator settings to adjust the flame as needed. Do not cook with the surface control knob in the LITE position. (The electronic ignitor will continue to spark if the knob is left in the LITE position.)

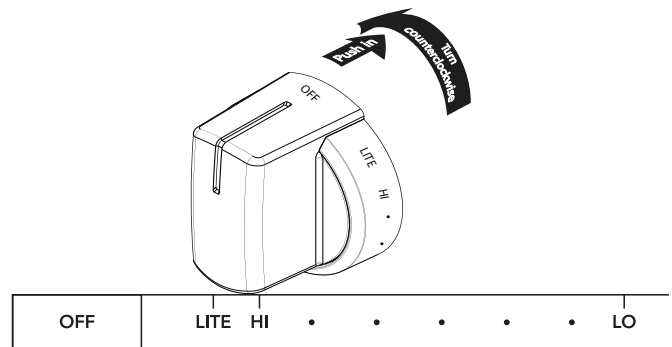

**Figure 2: Operating the gas knob**

In the event of an electrical power outage, the surface burners can be lit manually. To light a surface burner, hold a lit match to the burner head, then slowly turn the surface control knob to LITE. After burner lights turn the knob to desired setting.

### ⚠ CAUTION

Do not operate the burner for an extended period of time without cookware on the grate. The finish on the grate may chip without cookware to absorb the heat.

# SETTING SURFACE BURNERS

## Setting proper surface burner flame size

For most cooking: Start on the highest control setting and then turn to a lower one to complete the process. Use the recommendations below as a guide for determining proper flame size for various types of cooking. The size and type of utensil used and the amount of food being cooked will influence the setting needed.

### NOTE

Settings based on using medium weight metal or aluminum pans. Settings may vary using other types of pans. The color of the flame is key to proper burner adjustment. A good flame is clear, blue, and hardly visible in a well lit room. Each cone of the flame should be steady and sharp. Clean burner if flame is yellow-orange.

| Flame Size   | Type of Cooking  |
|--------------|--|
| High Flame   | <ul style="list-style-type: none"> <li>Start most foods</li> <li>Bring water to a boil</li> <li>Pan broiling</li> </ul>          |
| Medium Flame | <ul style="list-style-type: none"> <li>Maintain slow boil</li> <li>Thicken sauces and gravies</li> <li>Steaming foods</li> </ul> |
| Low Flame    | <ul style="list-style-type: none"> <li>Keep foods cooking, poaching and stewing</li> </ul>                                       |

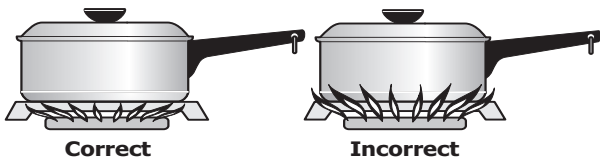

Figure 3: Gas flame adjustment

### IMPORTANT

Never extend the flame beyond the outer edge of the utensil. A higher flame simply wastes heat and energy, and increases the risk of being burned by the gas flame.

## Gas Cooktop Burners

The front control gas cooktop comes with a variety of burners to accommodate different sizes of cookware. The most powerful burner (18k BTU) for cooking in larger pots for canning or large amounts of soup or for boiling water is located at the right front of the cooktop.

The cooktop also has 12k, 7.5k, and 5k BTU burners to fit most cookware and cooking need.

The Simmer Oval burner is in the center of the cooktop and consists of a center burner and an oval burner. The center burner of the simmer oval can be set separately from the oval burner.

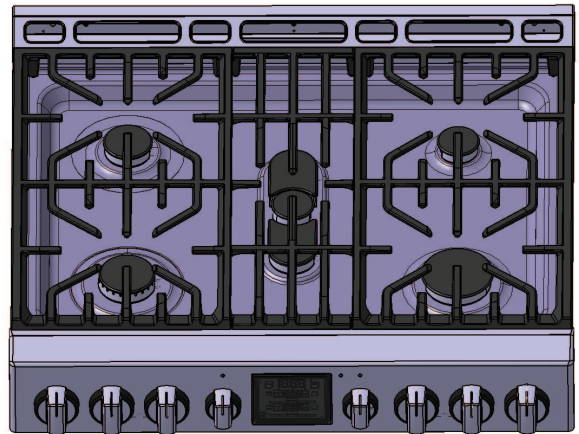

Figure 4: Gas cooktop with simmer-oval burner shown in center of cooktop.

### CAUTION

Never place or straddle a cooking utensil over two different surface cooking areas at the same time unless the cooktop is designed for such a purpose.

## SETTING SURFACE BURNERS

### Setting the Simmer Oval Burner

The simmer oval burner is specifically designed for use with a griddle, and can be used for simmering sauces or foods in most pots or pans. There are two knobs which control the separate functions of the simmer oval.

To turn on the full simmer oval use the control knob located to the left of the oven mode knob. There is an oval icon marking above the knob.

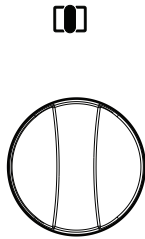

**Figure 5: Control knob for full oval burner**

To access the center burner only, turn the control knob located to the right of the oven temperature control knob.

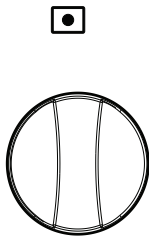

**Figure 6: Center burner control knob**

**Important:** Both the simmer oval control and the center control may be turned on at the same time.

### Home Canning

Be sure to read and observe all the following points when home canning with your appliance. Check with the United States Department of Agriculture (USDA) website and be sure to read all the information they have available as well as follow recommendations for home canning procedures.

- Use only quality flat bottom canners when home canning.
- Use a straight-edge to check canner bottom.
- Make sure the diameter of the canner does not exceed 1 inch beyond the surface element markings or burner.
- Start with hot tap water to bring water to boil more quickly.
- Use the highest heat setting when first bringing the water to a boil. Once boiling is achieved, reduce heat to lowest possible setting to maintain that boil.
- Never place or straddle a cooking utensil over two different surface cooking areas at the same time unless the cooktop is designed for such a purpose.

## BEFORE SETTING OVEN CONTROLS

### Oven vent location

The oven vent is located under the backguard in the rear of the cooktop. When the oven is on, warm air passes through this vent. This venting is necessary for proper air circulation in the oven and good baking results. While the oven is in operation, it is normal for steam or moisture to appear near the vent. Do not block oven vent.

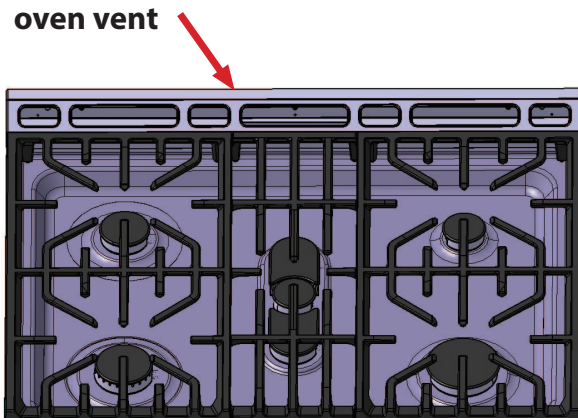

Figure 7: Oven vent location

### CAUTION

Always use pot holders or oven mitts when using the oven. When cooking, the oven interior and exterior, oven racks and cooktop will become very hot which can cause burns.

### IMPORTANT

Remove all oven racks and clean according to instructions provided in the Care & Cleaning section of this manual. Never pick up hot oven racks or parts.

All oven racks should be removed before a **clean** operation. Racks left in the oven during the high heat of the clean function can easily discolor. The ability of the racks to easily slide in and out along the rack positions may also be affected.

### Type of oven racks

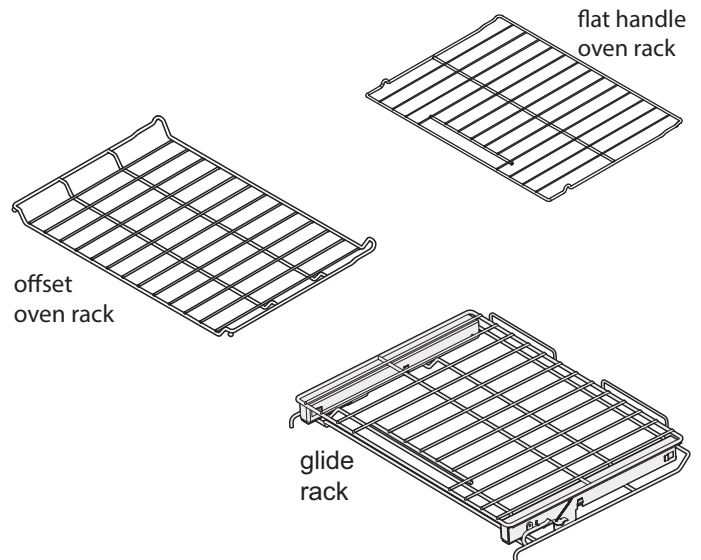

### Oven Rack Descriptions

- **Flat oven racks** (or the **flat handle oven rack**) may be used for most cooking needs and may be placed in most oven rack positions.
- The **offset oven rack** (some models) provides additional step down positions from the standard flat rack design. The offset design positions the base of the rack about  $\frac{1}{2}$  of a rack position lower than the flat rack and may be used in most oven rack positions.
- The fully extendable oven **glide rack** allows you to effortlessly extend your food away from the oven.

### Removing, replacing, and arranging flat or offset oven racks

**To arrange** - Always arrange the oven racks when the oven is cool (prior to operating the oven).

**To remove** - Pull the oven rack straight forward until it reaches the stop position. Lift up front of oven rack slightly and slide out.

**To replace** - Place the oven rack on the rack guides on both sides of oven walls. Tilt the front of oven rack upward slightly and slide the oven rack back into place. Be sure oven racks are level before using.

## BEFORE SETTING OVEN CONTROLS

### ➔ IMPORTANT

Do not line the oven walls, racks, bottom or any other parts of the range with aluminum foil or any other materials or oven liners. Doing so will alter heat distribution and may cause permanent damage to the oven interior. During **clean** the oven temperatures will be hot enough to melt foil.

**Protective Liners** — Only use aluminum foil as recommended in this manual. Improper installation of these liners may result in risk of electric shock or fire.

### Removing and Replacing the Glide Racks

The fully extendable Glide rack makes food preparation easier. This oven rack has glide tracks that allow the rack to be pulled away from the oven without rubbing the sides of the oven wall.

**To remove** - Using one hand, reach through handle opening and lift up on the release lever located across the lower front of the rack as shown in [Figure 8](#).

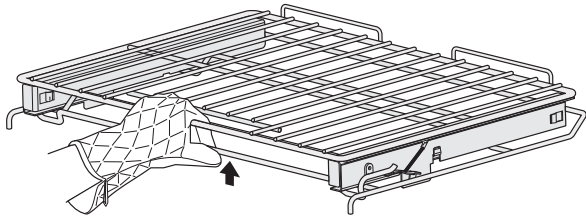

**Figure 8: Grasp handle and lift up on bar**

While holding up the release lever, pull the glide rack out of the oven until the stop position is reached ([Figure 9](#))

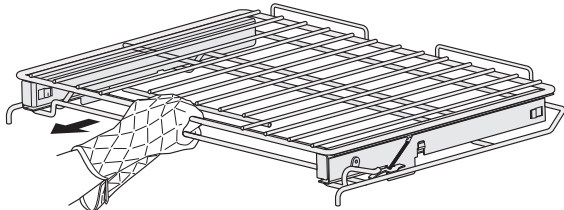

**Figure 9: Pull rack to stop position**

Using both hands, grasp the upper and lower portions of the glide rack. Lift up the front of the rack slightly and continue to pull the rack away from the oven ([Figure 10](#)). Be sure to grasp both upper and lower rack portions together when removing or handling the glide rack. The rack portions move independently and are difficult to handle unless held together.

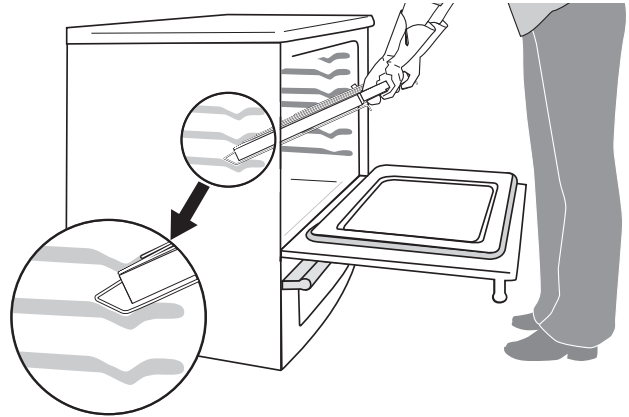

**Figure 10: Remove and replace using both hands**

**To replace** - grasp both upper and lower portions of glide rack, lift and hold the rack level between the oven cavity walls. Tilt the front of the rack upward slightly and slide the rack completely into position.

### ➔ IMPORTANT

To prevent possible damage to the oven, do not attempt to close the oven door until all the oven racks are fully positioned back inside the oven cavity.

# OVEN CONTROLS

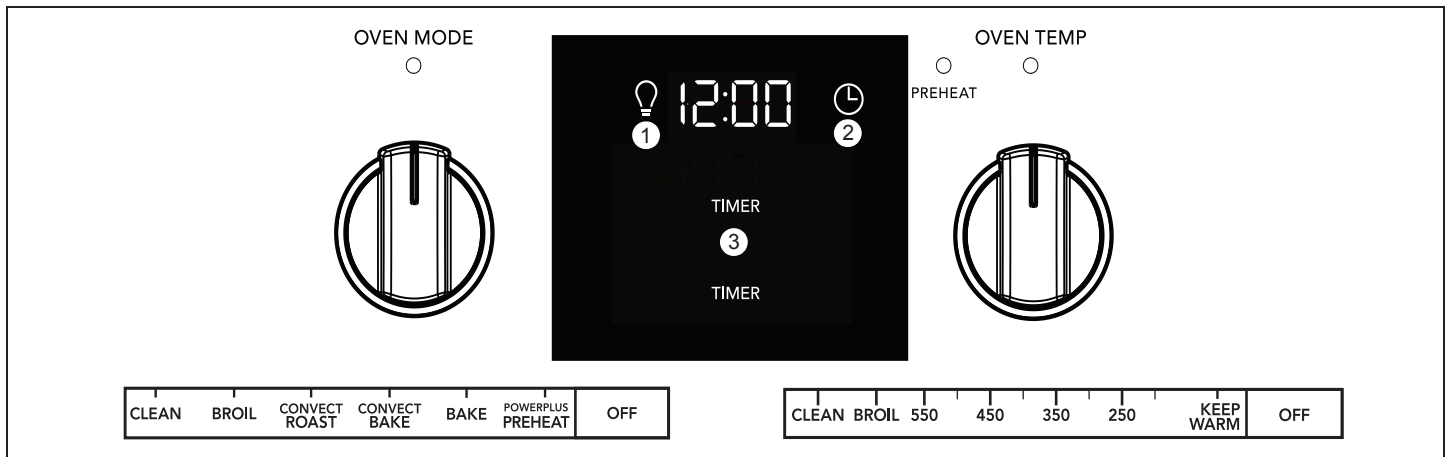

## OVEN MODE SETTINGS

**POWERPLUS™ PREHEAT** - Use powerplus preheat for single rack items only and place food in center of oven.

**BAKE** - Use to select bake function before setting temperature.

**CLEAN** - Use to select clean feature cycle before setting clean with oven temperature selector.

**CONVECT BAKE** - Use to select convection baking before setting oven temperature.

**CONVECT ROAST** - Use to select convection roast for beef, lamb, pork, and poultry before setting oven temperature.

**BROIL** - Use to set broil feature before setting broil with oven temperature selector.

**KEEP WARM** - Keep warm provides a low heat for keeping cooked foods at serving temperature.

## OVEN DISPLAY FEATURES

- OVEN LIGHT** - Use to turn internal oven light on and off.
- CLOCK** - Use clock icon when setting the time of day.
- TIMER** - Oven timers for tracking cooking times. Timers do not stop or start the cooking process.

## OVEN TEMPERATURE SETTINGS

Use to set oven temperatures between 170°F (KEEP WARM) and 550°F. The CLEAN setting should only be used after reading all cautions and warnings in the “Self Cleaning” sections of this manual starting on [page 26](#).

## Oven Minimum and Maximum Control Settings

| Feature           | Min. Temp/Time              | Max. Temp/Time |
|-------------------|-----------------------------|----------------|
| BAKE              | 170°F (77°C)<br>(KEEP WARM) | 550°F (288°C)  |
| POWERPLUS PREHEAT | 170°F (77°C)<br>(KEEP WARM) | 550°F (288°C)  |
| CONVECT BAKE      | 170°F (77°C)<br>(KEEP WARM) | 550°F (288°C)  |
| CONVECT ROAST     | 170°F (77°C)<br>(KEEP WARM) | 550°F (288°C)  |
| MEAT PROBE        | 140°F (60°C)                | 210°F (99°C)   |
| BROIL             | 550°F (288°C)               |                |
| TIMER             | 0:01 Hr                     | 11:59          |
| CLOCK (12hr)      | 1:00 Hr                     | 12:59 Hr       |
| CLEAN (Times)     | 2, 3 OR 4 HOURS             |                |

## User Preference Settings

The default (factory) settings for sounds, energy saving, temperature offset, and convection convert are pre-set in the oven control. These may be changed by accessing the user preference display while the oven is idle. Once the user preference menu is activated, the user can make changes and scroll through a menu of options, choosing from **Aud** (audible control setting), **ES** (energy saving), **UPO** (User Programmable Offset for changing the oven temperature), **Aut** (automatic convection convert), **def** (default setting) and **rSt** (which will reset all preferences to default settings).



## Setting the Clock

The clock icon is used to access the time of day setting. When the oven is first plugged in or if there has been an interruption in power to the range, **12:00** will flash in the display.

### To set the correct time of day:

1. Press the clock icon.
2. The display will show a time along with a **-** key and a **+** key in the display below.
3. Press either **-** or **+** key to scroll to the correct time of day and release the key.
4. The control will accept the new set time with a chime, and the control will show the time of day along with the two timers that are available.

### **NOTE**

The clock cannot be changed when the oven is set for cooking or clean is active. Only a 12 hour clock is available on the Frigidaire Professional model.

## Oven Lights

The oven lights will turn on automatically when the oven door is opened. The oven lights may be turned on when the door is closed by using the oven light key located on the control panel.

**Note:** Keep oven lights off while baking. The oven lights will turn off during a clean cycle and not operate.

### To toggle the oven lights on and off:

1. Press oven light symbol .

The interior oven light is covered with a glass shield. The glass shield must be in place whenever the oven is in use.

To change the interior oven lights, see [“Replacing the oven light”](#) in the Care & Cleaning section.

## Setting the Timer

The minute timers in the oven display serve as extra timers to help keep track of cooking functions. The timer cannot be used during a clean cycle or if the meat probe function associated with the timer display is in use. The minimum timer setting is 1 minute and the maximum setting is 11:59 (HR:MIN).

### To set the timer:

1. Press either **TIMER** key.
2. The timer display will show
3. **0:00** and a **-** key and **+** key on either side of the time display. **NOTE:** If the **-** key is pressed at this time an invalid key chime will sound.
4. Press the **+** key to begin to scroll to the desired setting. If the **+** key is held, the timer value will increase rapidly. Once the desired setting is reached, release the key and the timer will start counting down automatically after a short time-out.
5. The timer display will show the **H:M** icon if the timer is set for more than 1 minute. If the value is under 1 minute, the timer will display the time in seconds and the **H:M** icon will not appear.
6. When the timer ends, a reminder chime will sound and repeat once every 60 seconds for a period of five minutes. Before the user can program an expired timer again, the timer key must be pressed.
7. To cancel the timer before the set time expires, press the **TIMER** key.

### **NOTE**

The minute timers will not start or stop the cooking process. The minute timers can be used alone or while using most of the other oven features.

## OVEN CONTROLS

### Setting Continuous Bake or 6 Hour Energy Saving

The oven is preset to cook up to 6 hours and to shut off automatically. For longer periods of cooking, this feature can be changed to continuous cooking by setting the user preference and turning the energy saving feature off.

#### To set the oven for continuous cooking:

1. Press and hold both the **light** icon and the **clock** icon at the same time for a few seconds until the display sounds an acceptance chime and the display will show one of the user preferences.
2. Press the **+** key in the upper part of the display until **ES** appears and **ON** is showing.



Figure 11: Energy saving with ON and OFF options

3. To turn the energy saving feature **off**, press the **+** or **-** key in the lower part of the display and **OFF** will appear in the display.
4. The control will accept the change in a few seconds and sound the acceptance chime. The oven is now set for continuous cooking.
5. To return to the time of day display, press and hold the **light** and **clock** icons at the same time for a few seconds until the display chimes and fades back to showing the time of day in the display.

### → IMPORTANT

Changing to continuous bake does not change how the cooktop controls operate.

### Setting Control for Silent Operation

The oven is set to operate with certain chimes and tones (default settings) that alert the user to certain oven functions. The silent operation feature allows the oven control to be operated without sounds when necessary. By accessing user preferences, this option can be later returned to operate with normal programming sounds.

#### To set the oven control for silent operation:

1. Press and hold both the **light** icon and the **clock** icon at the same time for a few seconds until the display sounds an acceptance chime. **Aud** should appear in the display.
2. If **Aud** is not showing, press the **+** key in the upper part of the display until **Aud** appears and **HI** is showing in the lower part of the display. This is the normal (default) setting.



Figure 12: Default setting for oven control sounds

3. To turn the energy saving feature to a lower sound or completely OFF, press the **+** or **-** key in the lower part of the display until **LO** or **OFF** appears in the display.



Figure 13:

4. When the desired setting appears in the display, release the key and wait for an acceptance chime.
5. To return to the time of day display, press and hold both the **light** and **clock** icons at the same time for a few seconds until the display chimes and fades back to showing the time of day.

## Setting PowerPlus™ Preheat

The PowerPlus™ Preheat feature uses the convection fan to quickly bring the oven up to the set temperature. Use powerplus preheat for single rack items only and place food in center of oven.

**Important:** When baking delicate items like cakes and cookies use the regular bake or convection bake mode.

### To set powerplus preheat:

1. Turn the oven mode selector to **POWERPLUS PREHEAT**. The oven mode light will turn on.
2. Turn the oven temperature selector to the desired temperature. The convection fan will turn on after 6 minutes and remain on as a convection bake. The control will chime once the oven is preheated.
3. When finished baking turn both oven selectors to the **OFF** position.

## Setting Bake

### Baking tips

#### For best bake results:

- Fully preheat the oven before baking items like cookies, cakes, biscuits, and breads. When using any single rack, position the rack so that the food is in the center of the oven.
- The convection fan will be on during preheat and then turn off and on occasionally as needed.
- For best results when baking cakes using two oven racks, place racks in positions 6 (offset rack) and 1 (Glide rack) [Figure 14](#).
- When baking using two oven racks, position cookware as shown in [Figure 15](#). Allow at least 2 inches (5 cm) of space between cookware for proper air circulation.
- Dark or dull bakeware absorbs more heat than shiny bakeware. It may be necessary to reduce oven temperature and cook time to prevent overbrowning of some foods. Dark bakeware is recommended for pies. Shiny bakeware is recommended for cakes, cookies, and muffins.

**Important:** For batter and dough-based baked goods such as cakes, pastries, and breads, use the regular bake function for best results. For cookies use the convection bake function.

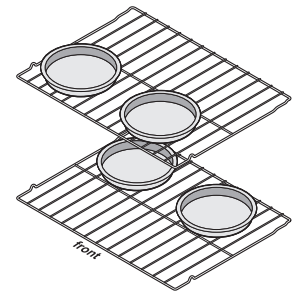
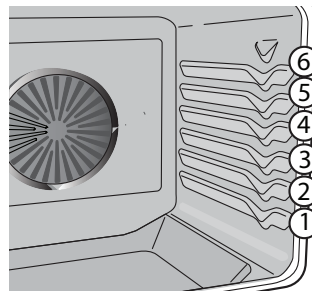

**Figure 14: Rack positions**    **Figure 15: Pan spacing**

Use the bake function whenever a recipe calls for normal baking. When the set bake temperature is reached the control will sound a chime to alert that the oven is fully preheated.

Bake may be set for any temperature between (170°F 77°C) and 550°F (288°C).

### To set BAKE for oven temperature of 350°F:

1. Be sure to arrange racks to the desired positions for the item(s) to be baked.
2. Turn the oven mode selector to the **BAKE** position.
3. Turn the oven temperature selector to **350°F**.
4. The **PREHEAT** and the oven temperature light will turn on and sound an acceptance tone. The oven will begin heating.
5. When the set temperature is reached a reminder chime will sound alerting you to place food in oven. Set either timer to keep track of actual cooking time if necessary.
6. When finished baking, be sure to return both the temperature selector knob and the oven mode knob to the **OFF** positions.

**Note:** Do not open oven door too often. Doing so reduces oven temperature and may extend cooking time. The convection fan will start after the oven has been heating for 6 minutes. It will stop each time the oven door is opened.

## OVEN CONTROLS

### Convection Cooking

This mode of cooking enables you to obtain the best results when baking with multiple pans and racks. The oven can be programmed for convection baking at any temperature between 170°F to 550°F with a default temperature of 350°F. The convection fan will turn on after 6 minutes and remain on during the convection baking process.

The convection function uses a fan to circulate the oven heat uniformly and continuously around the oven (Figure 16). This improved heat distribution allows for fast, even cooking and browning results. It also gives better baking results when using two oven racks at the same time.

#### Benefits of convection cooking:

- Multiple rack baking.
- Some foods may cook faster.

#### Convection baking tips:

- Fully preheat the oven before baking items like cookies, cakes, biscuits, and breads. For best results baking cookies use convection bake function.
- If your recipe cooking temperature has not been converted for convection baking, see “[Setting Convection Convert](#)” on [page 19](#) for further instructions on temperature conversion.
- When using any single rack, position the rack so that the food is in the center of the oven.
- For best results when baking cakes using two oven racks, place racks in positions 6 with offset rack and 1 using Glide rack (See [Figure 16](#)).
- When baking using two oven racks, position cookware as shown in [Figure 17](#). Allow at least 2 inches (5 cm) of space between cookware for proper air circulation.
- Dark or dull bakeware absorbs more heat than shiny bakeware. It may be necessary to reduce oven temperature and cook time to prevent overbrowning of some foods. Dark bakeware is recommended for pies. Shiny bakeware is recommended for cakes, cookies, and muffins.
- Do not open oven door too often. Doing so reduces oven temperature and may extend cooking time.
- Most baked goods (except cakes) should be baked on pans with no sides or low sides to allow air to circulate.

### Setting Convection Bake

This mode of cooking enables you to obtain the best results when baking with multiple pans and racks. The oven can be programmed for convection baking at any temperature between 170°F to 550°F.

#### To set the oven for convection bake and temperature to 350°F:

1. Arrange interior oven racks.
2. Turn the oven mode selector to **CONVECT BAKE**.
3. Turn the oven temperature selector to **350°F**.
4. The convection fan will turn on 6 minutes after the oven begins heating. Once the oven reaches the set temperature the oven will sound a chime indicating the food items can be placed in the oven.
5. When finished baking, be sure to return both the temperature selector knob and the oven mode knob to the **OFF** positions.

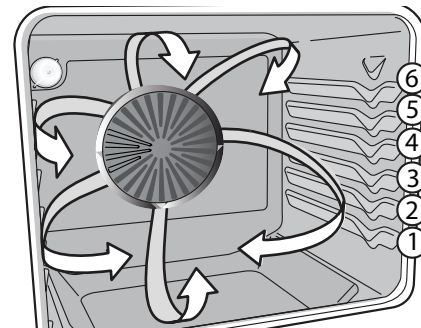

Figure 16: Convection air flow

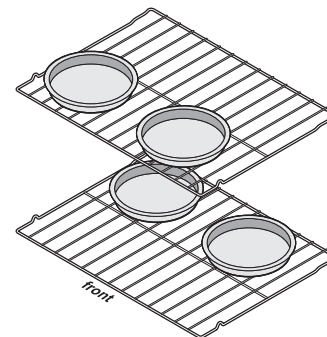

Figure 17: Pan spacing recommendations

## Setting Convection Convert

This feature must be set before selecting the oven mode and oven temperature by using the user preference setting in the oven display.

Convection convert automatically converts a standard baking recipe for convection baking. Convection convert may only be used with a convection bake cooking mode. Because convection baking generally cooks food faster than normal baking, food items should be checked for doneness before the suggested normal recipe cook times.

### To set convection convert:

1. The oven temperature selector must be in the **OFF** position. Turn the oven mode selector to **CONVECT BAKE**.
2. Press and hold both the oven **light** icon and the **clock** icon for about 3 seconds until **Aut°** (Automatic convection convert) appears in the display.
3. Press either the **-** or **+** key until **ON** appears.

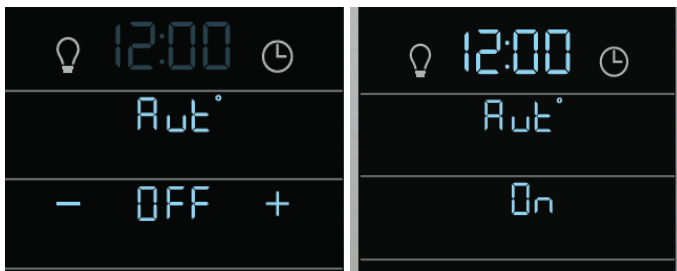

**Figure 18: Convection convert off (L) and on (R)**

4. Turn the oven mode selector to the **OFF** position. The oven will accept the convection convert setting with an acceptance chime and the control will return to display the time of day. The convection bake function will now automatically convert normal baking temperatures for convection baking.
5. To change back to regular convection baking, repeat the same steps in this process and press the **+** or **-** key until **OFF** appears. Once the control accepts the change with a chime, turn the oven mode selector to **OFF**.

## Setting Convection Roast

Convection roast is best for cooking tender cuts of beef, lamb, pork, and poultry. Use this mode when cooking speed is desired. Convection roasting gently browns the exterior and seals in the juices. Convection roasting uses the bake element, convection element, and fan to circulate the heat evenly and continuously within the oven.

### Convection roasting tips:

- Use a broiler pan and grid, as well as a roasting rack (available by mail order). The broiler pan will catch grease drippings, and the grid will help prevent spatters. The roasting rack will hold the meat. Make sure the roasting rack is securely seated on the grid in the broiler pan. Do not use the broiler pan without the grid or cover the grid with aluminum foil or any other material.
- Pull the rack out to the stop position before removing food. Position food (fat side up) on the roasting rack.
- Do not open the oven door often. Doing so will reduce the temperature in the oven and may increase the cooking time necessary for best results.
- It is not recommended to roast chicken on a roasting rack. Use a deep pan and place on rack position 1 (offset rack).

### To set oven for convection roasting:

1. Place meat on roasting rack and place in oven.
2. Turn oven mode selector to **CONVECT ROAST**.
3. Turn oven temperature selector to desired roasting temperature.

**Note:** Preheating the oven for convection roasting is not necessary. At this time you may want to set **TIMER** as a reminder for checking food.

# OVEN CONTROLS

**Table 1: Convection roasting temperature and time recommendations**

| Meat    |                     | Weight       | Oven Temp                  | Internal Temp | Minutes per lb. |
|---------|---------------------|--------------|----------------------------|---------------|-----------------|
| Beef    | Standing rib roast* | 4 to 6 lb.   | 350°F (177°C)              | *160°F (71°C) | 25-30           |
|         | Rib eye roast*      | 4 to 6 lb.   | 350°F (177°C)              | *160°F (71°C) | 25-30           |
|         | Tenderloin roast    | 2 to 3 lb.   | 400°F (204°C)              | *160°F (71°C) | 15-25           |
| Poultry | Turkey whole**      | 12 to 16 lb. | 325°F (163°C)              | 180°F (82°C)  | 8-10            |
|         | Turkey whole**      | 16 to 20 lb. | 325°F (163°C)              | 180°F (82°C)  | 10-15           |
|         | Turkey whole**      | 20 to 24 lb. | 325°F (163°C)              | 180°F (82°C)  | 12-16           |
|         | Chicken             | 3 to 4 lb.   | 350°F-375°F (177°C-191°C)* | 180°F (82°C)  | 12-16           |
| Pork    | Ham roast, fresh    | 4 to 6 lb.   | 325°F (163°C)              | 160°F (71°C)  | 30-40           |
|         | Shoulder roast      | 4 to 6 lb.   | 325°F (163°C)              | 160°F (71°C)  | 20-30           |
|         | Loin                | 3 to 4 lb.   | 325°F (163°C)              | 160°F (71°C)  | 20-25           |
|         | Pre-cooked ham      | 5 to 7 lb.   | 325°F (163°C)              | 160°F (71°C)  | 30-40           |

\* The U.S. Department of Agriculture states, "Rare fresh beef is popular, but you should know that cooking it to only 140°F (60°C) means some food poisoning organisms may survive." (Source: Safe Food Book, Your Kitchen Guide, USDA Rev. June 1985.) The lowest temperature recommended by the USDA is 145°F (63°C) for medium rare fresh beef. For well done 170°F (77°C)

\*\* Stuffed turkey requires additional roasting time. Shield legs and breast with foil to prevent over browning and drying of the skin.

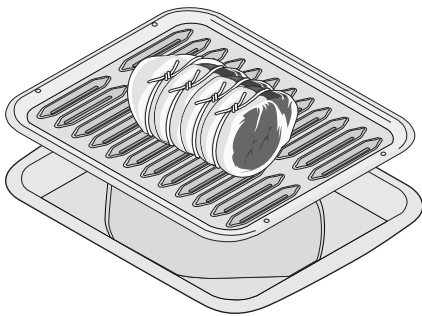

**Figure 19: Roast with broil pan and insert**

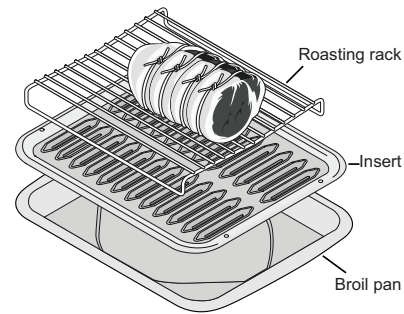

**Figure 20: Optional roasting rack shown with broil pan and insert.**

## ⚠ CAUTION

Do not use the broiler pan without the insert. A roasting rack [Figure 20](#) (some models) can be used when convection roasting. Do not cover the broil pan or insert with aluminum foil or any other material; the exposed grease could ignite.

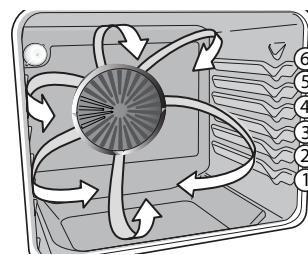

**Figure 21: When roasting chicken do not use roasting rack; use a deep pan and place on rack position 1.**



## Using the Broil Feature

Use the broil feature to cook meats requiring direct exposure to radiant heat for optimum browning results.

### **WARNING**

Should an oven fire occur, do not open oven door, turn off the oven. If the fire continues, throw baking soda on the fire or use a fire extinguisher. Do not put water or flour on the fire. Flour may be explosive, and water can cause a grease fire to spread and cause personal injury.

### **CAUTION**

Always use pot holders or oven mitts when working with a hot oven. When broiling, the oven interior, oven racks and cooktop will become hot enough to cause burns. Do not use the broiler pan without the insert. Do not cover the broil pan or insert with aluminum foil or any other material; the exposed grease could ignite.

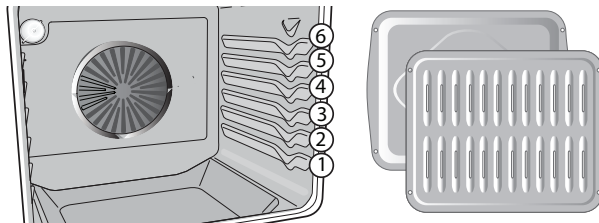

Figure 22: Rack positions (L); and broil pan and insert (R)

Table 2: Broiling Suggestions

| Food                  | Rack Position   | Temperature  | Cook time (minutes) |          | Internal Temperature | Doneness |
|-----------------------|-----------------|--------------|---------------------|----------|----------------------|----------|
|                       |                 |              | 1st side            | 2nd side |                      |          |
| Steak 1" thick        | 5th or 6th*     | 550F (288°C) | 6                   | 4        | 145°F (63°C)         | Medium*  |
| Steak 1" thick        | 5th or 6th*     | 550F (288°C) | 8                   | 7        | 170°F (77°C)         | Well     |
| Pork Chops 3/4" thick | 5th             | 550F (288°C) | 8                   | 6        | 170°F (77°C)         | Well     |
| Chicken bone-in       | 4th             | 550F (288°C) | 20                  | 10       | 170°F (77°C)         | Well     |
| Chicken boneless      | 4th             | 550F (288°C) | 8                   | 6        | 170°F (77°C)         | Well     |
| Fish                  | 5h              | 550F (288°C) | 13                  | n/a      | 170°F (77°C)         | Well     |
| Shrimp                | 5h              | 550F (288°C) | 5                   | n/a      | 170°F (77°C)         | Well     |
| Hamburger 1" thick    | 6th (flat rack) | 550F (288°C) | 4                   | 4        | 135°F (57°C)         | Rare**   |
| Hamburger 1" thick    | 6th*            | 550F (288°C) | 9                   | 7        | 145°F (63°C)         | Medium   |
| Hamburger 1" thick    | 6th*            | 550F (288°C) | 10                  | 8        | 170°F (77°C)         | Well     |

\* Use offset rack in top position unless indicated otherwise. \*\* The U.S. Department of Agriculture states, "Rare fresh beef is popular, but you should know that cooking it to only 140°F (60°C) means some food poisoning organisms may survive." (Source: Safe Food Book, Your Kitchen Guide, USDA Rev. June 1985.) The lowest temperature recommended by the USDA is 145°F (63°C) for medium rare fresh beef. For well done 170°F (77°C). Suggested broiling times do not include the 2 minutes for preheating.

### To set broil:

1. Arrange oven racks while oven is cool.
2. Turn the mode selector knob to **broil**. The corresponding indicator light will flash.
3. Turn the temperature selector knob to **broil**. The indicator light will turn on and remain lit. For optimum browning results, preheat oven for 5 minutes before adding food.
4. Place the broiler pan on the rack. Be sure to center the broiler pan directly under the broiler flame.
5. Broil with door closed.
6. Pull the oven rack out to the stop position before turning or removing food.
7. Turn the temperature and the selector knobs to **OFF** when cooking is completed or to cancel broil.

### Recommended Broiling Times

Depending on the type, the thickness, and the desired doneness of meat, it might be necessary to increase or decrease recommended broiling times or adjust the broiling pan to different rack positions. If a broiler pan and insert are not supplied with this appliance, they may be purchased from [frigidaire.com](http://frigidaire.com).

## OVEN CONTROLS

### Meat Probe

Use the probe feature for best results when cooking foods such as roasts, hams or poultry, using a probe to check internal temperature is the safest method to ensure properly cooked food. Before using the meat probe read the important information listed here:

#### ➔ IMPORTANT

- The probe feature must be set before setting the cooking mode and oven temperature.
- If a timer is running when the meat probe is plugged in, the control will sound a triple beep once and the timer will keep running. The timer must be canceled before the probe temperature can be set.
- If the meat probe is unplugged during a cooking function, or plugged in during BROIL, the oven will stop cooking and turn off.
- If the meat probe is plugged in while the oven is in a function that allows for the meat probe, the control will sound a triple beep indicating that the meat probe is not allowed. After the alert, the oven will continue to cook to the set oven temperature.
- If no cooking mode is selected within 30 seconds of setting the target temperature, the oven mode indicator light will stop blinking. The display will continue to show the meat probe settings until an allowable cooking mode is selected.
- When the meat probe is set correctly, the control will signal an alert when the internal food temperature reaches the desired set target temperature. When active, the internal food temperature is visible in the display during the cooking process. This eliminates any guesswork or the need to open the oven door to check a thermometer.

**Note:** If the meat probe is plugged while the oven is in a function which allows probe cooking, it may be set the following way:

1. Cancel the active cooking function. The display will show the meat probe icon and temperature 000°.
2. The meat probe temperature can now be set and the control will sound an acceptance chime. The oven mode indicator light will blink until an allowable cooking function is selected.

### Proper placement of probe in food.

- Insert the probe so that the probe tip rests inside the center of the thickest part of meat or food (Figure 23). For best results, do not allow the probe to contact bone, fat, gristle, or the cookware.
- For bone-in ham or lamb, insert the probe into the center of lowest large muscle or joint.
- For meatloaf or casseroles, insert the probe into center of food.
- When cooking fish, insert meat probe just above the gill.
- For whole poultry or turkey, fully insert the probe into the thickest part of the breast.

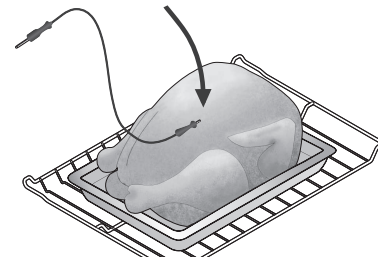
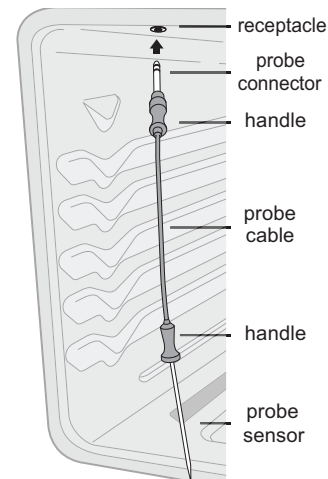

Figure 23: Placing probe in poultry

### To set probe:

1. Insert the probe into the food. Place prepared food on the desired oven rack position and slide into the oven.
2. Plug the connector end of the probe into the probe receptacle while the oven is still cool.



**Meat Probe (cont'd)**

- When the probe is inserted, an acceptance tone will sound, the probe icon appears in the display (See Figure 24). Close the oven door.

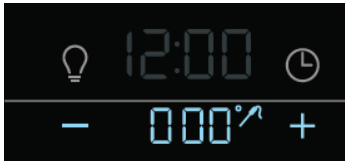

**Figure 24: Probe inserted and ready to set temperature**

- Press the **+** key to set the desired probe temperature between 140°F and 210°F. If no selection is made within 10 seconds, the control will automatically set the default temperature of 170°F and the display will sound an acceptance chime.

**Note:** The probe must be fully set before setting the oven mode and temperature mode.

- Set the **oven mode** to **POWERPLUS PREHEAT**, **BAKE**, **CONVECT BAKE**, or **CONVECT ROAST**.
- Set the **oven temp** control to the desired cooking temperature. The oven will begin heating.
- During the cooking process, an up arrow **↑** and the current meat probe temperature will appear in the display until the meat probe target temperature is reached.
- When 75% of the target temperature is reached, the control will chime and a **CHECK FOOD** reminder will appear in the display. **CHECK FOOD** will remain in the display and continue to chime every 60 seconds for five minutes or until the oven door is open.
- Once the target temperature of the food is reached, the control will chime to signal the end of cooking. At this time the **↑** will turn off and the display will show the **FOOD READY** and **OVEN WARM** messages.

### **WARNING**

Food Poisoning Hazard. Do not let food sit for more than one hour before or after cooking. Doing so can result in food poisoning or sickness.

**Trailing Keep Warm with Meat Probe**

When the meat probe reaches the target temperature, the oven will automatically switch to keep warm (170°F) and remain on for up to 3 hours before turning off automatically. The display will continue to show the meat probe temperature until either **keep warm** is canceled or by disconnecting the meat probe from the receptacle. Once turned off, the probe icon and temperature will fade from the display.

**Important:** If the meat probe temperature should exceed the maximum allowable temperature, the oven control will beep and **HOT** will appear in the display for 40 seconds to notify that the probe temperature is too high.

**Setting Keep Warm**

**Keep Warm** maintains a temperature of 170°F (77°C) for keeping oven baked foods at serving temperature until canceled. The feature may be used with **BAKE**, **CONVECT BAKE**, **CONVECT ROAST**, and **POWERPLUS PREHEAT**.

**Keep warm tips:**

- Always start with hot food. Do not use the keep warm feature to heat cold food.
- Food in heat-safe glass and glass ceramic containers may need higher temperature settings compared to food in regular containers. Avoid repeated openings of the oven, it will allow hot air to escape and the food to cool.
- Aluminum foil may be used to cover food to increase moisture content.

**To set keep warm:**

- Arrange interior oven racks and place food in oven.
- Turn the oven mode selector to **BAKE**, **CONVECT BAKE**, **CONVECT ROAST**, or **POWERPLUS PREHEAT**.
- Set the oven temperature selector to **KEEP WARM**.
- The indicator light will blink and then an acceptance chime will sound.
- The preheat indicator light will turn on and stay on until the oven reaches the keep warm temperature of 170°F.

## OVEN CONTROLS

### Setting the Sabbath Feature

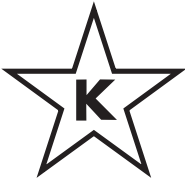

This appliance provides special settings for use when observing the Jewish Sabbath/Holidays. Sabbath mode disables all audible tones or visual display changes on the oven control.

For further assistance, guidelines for proper usage, and a complete list of models with the Sabbath feature, please visit the web at [www.star-k.org](http://www.star-k.org).

The Sabbath feature may only be used with the bake function. Once the oven is properly set using bake with the Sabbath feature active, the oven will remain on until canceled. The Sabbath feature overrides the factory preset 6 hour energy saving feature.

**Important:** The oven light will turn off during the Sabbath mode and remain off until the Sabbath mode is canceled.

**Note:** The meat probe feature is not available in Sabbath mode.

### WARNING

Food Poisoning Hazard. Do not let food sit for more than one hour before or after cooking. Doing so can result in food poisoning or sickness. Foods that can easily spoil such as milk, eggs, fish, meat, or poultry should be chilled in the refrigerator first. Even when chilled, they should not stand in the oven for more than 1 hour before cooking begins and should be removed promptly when finished cooking.

### To set the oven for baking and activate the Sabbath feature:

1. Be sure the clock is set to the correct time of day. Place food in the oven.
2. Turn the oven mode selector to **BAKE**.
3. Turn the oven temperature selector to the desired bake temperature.
4. An acceptance chime will sound, the oven will start heating and the LED lights will stop blinking and remain on.
5. To enter Sabbath mode press and hold the **oven light** key and the **clock** key at the same time for about 3 seconds. The control will sound an acceptance chime and **SAB** will appear in the display below the time of day.



**Figure 25: Oven display showing Sabbath mode**

**Note:** During the Sabbath mode all normal sounds of the oven control will be turned off. However the control will allow any sounds associated with alarms.

During Sabbath operation the oven temperature may be changed by adjusting the oven temperature selector. The oven will remain in Sabbath until canceled by the user.

### To turn off the Sabbath feature:

1. Turning the oven mode selector and the oven temperature selector to the **OFF** position will cancel BAKE only.
2. To turn off the Sabbath feature press and hold both the oven light key and the clock key for about 3 seconds.
3. The acceptance chime will sound and SAB will disappear from the display. Be sure both oven selectors are returned to the OFF positions

### Power failure while using Sabbath feature:

Should you experience a power failure or interruption, the oven will shut off. When power is returned, **SF** (Sabbath Failure) will be displayed, and the oven will not turn back on automatically. If your food was nearly fully cooked, you may allow the trapped heat in the oven to finish the cooking process. Otherwise, you should remove the food when the power failure occurs because you may only start the oven once during the Sabbath/Jewish holidays.

### After the Sabbath observance turn off the Sabbath feature.

Press and hold both the **oven light** and **clock** keys for at least 3 seconds. **SAb** will disappear from the display, and the oven may be used with all normal functions.

## OVEN CONTROLS

### Adjusting the Oven Temperature

The temperature in the oven is pre-set at the factory. When first using the oven, be sure to follow recipe times and temperatures.

#### NOTE

Do not use oven thermometers such as those found in grocery stores to check the temperature settings inside your oven. These oven thermometers may vary as much as 20 to 40 degrees from actual temperatures.

If you think the oven is cooking too hot or too cool for the temperature you select, you can adjust the actual oven temperature to be more or less than what is displayed by accessing the UPO (User Programmable Offset).

Before adjusting, test a recipe by using a temperature setting higher or lower than the recommended temperature. The baking results should help you to decide how much of an adjustment is needed.

#### To adjust the oven temperature:

**Important:** Make sure both the oven mode selector and the oven temperature selector are in the OFF position.

1. Press and hold both the light icon and the clock icon at the same time for a few seconds until the display sounds an acceptance chime. **AUd** should appear in the display.
2. Press the **+** key in the upper part of the display until **UPO** appears and the default setting of **0°** (or the last set temperature offset) is showing.



Figure 26: UPO shown at default setting

3. Using the **+** or **-** key in the bottom of the display, press until the desired temperature change (offset) is reached. The display will change  $\pm 5^\circ$  with each key press to a maximum of **+ 35°** or a minimum of **- 35°F**.



Figure 27: UPO shown 10° higher than default

If a lower temperature offset is desired, press the **-** key in the bottom of the display until the desired lower temperature appears.



Figure 28: UPO shown 10° lower than default

Once the new offset appears in the display, release the key and the control will accept the change.

4. To return the display to normal, press and hold both the oven **light** icon and the **clock** icon at the same time until an acceptance chime sounds. The display will return to show the time of day.

#### NOTE

Changing the UPO will not affect the broil or clean temperatures.

## OVEN CONTROLS

### Self Cleaning

A self cleaning oven cleans itself with temperatures well above normal cooking temperatures which eliminate soils completely or reduces them to a fine powdered ash you can wipe away with a damp cloth.

While the oven is in operation, the oven heats to temperature much higher than those used in normal cooking. Sounds of metal expansion and contraction are normal. Odor is also normal because the food soil is being removed. Smoke may appear through the oven vent.

### ➔ IMPORTANT

#### Adhere to the following self clean precautions:

- Do not spray oven cleaners or oven protective coatings in or around any part of the oven interior.
- Do not clean the oven door gasket (Figure 29). The woven material of the oven door gasket is essential for a good seal. Care should be taken not to rub, damage, or remove the gasket.
- Do not use any cleaning materials on the oven door gasket. Doing so could cause damage.
- Remove the broiler pan and insert, all utensils, and any aluminum foil from the cooktop and oven. These items cannot withstand high cleaning temperatures and may melt.
- Completely remove all oven racks and any accessories. If the oven racks are not removed, they will lose their special coating properties and no longer slide in and out of the oven cavity easily.
- Remove any excessive soil or debris from the oven bottom. To clean, use hot, soapy water and a cloth. Large spills can cause heavy smoke or fire when subjected to high temperatures.
- Do not allow food spills with a high sugar or acid content (such as milk, tomatoes, sauerkraut, fruit juices, or pie filling) to remain on the surface as they may leave a dull spot even after cleaning.
- Clean any soil from the oven frame, the door liner outside the oven door gasket, and the small area at the front center of the oven bottom. These areas heat sufficiently to burn soil on. Clean with soap and water. These areas are shown in white (Figure 29).

### ⚠ CAUTION

The health of some birds is extremely sensitive to the fumes given off during the clean cycle of any range. Move birds to another well-ventilated room.

Do not force the oven door open. This can damage the automatic door locking system. Use caution when opening the door after the clean cycle is complete. The oven may still be very hot.

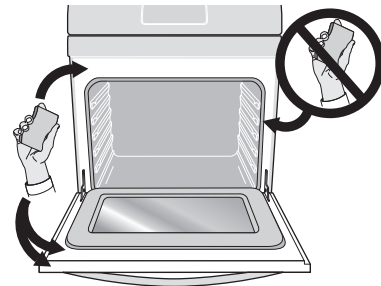

Figure 29: Clean around the oven door gasket

### ⚠ CAUTION

To avoid possible burns, use care when opening the oven door after the clean cycle. Stand to the side of the oven when opening the door to allow hot air or steam to escape.

Do not leave small children unattended near the appliance during a clean cycle; the range may become very hot to the touch and may cause burns.

Do not line the oven walls, racks, bottom, or any other part of the range with aluminum foil or with any oven liners or materials. Doing so will destroy heat distribution, produce poor baking results, and cause permanent damage to the oven interior (aluminum foil will melt to the interior surface of the oven).



## Setting Clean

If you are planning to use the oven directly after a clean cycle, remember to allow time for the oven to cool down and the oven door to unlock. This normally takes about one hour. A 3 hour clean cycle will actually take about 4 hours to complete.

It is recommended to use a 2 hour clean cycle for light soils, a 3 hour cycle for average soils, and a 4 hour cycle for heavy soils.

### To set the controls for a 3 hour clean cycle and shut off automatically:

1. Turn both the oven mode and oven temperature selectors to **CLEAN**. The display will show a 3 hour time (normal clean) and the **-** and **+** keys.

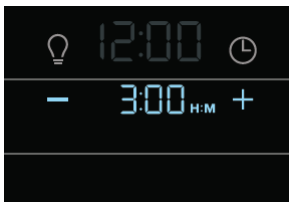

Figure 30: Oven set for 3 hour clean

2. If a 3 hour clean is desired, the control will accept the time within 3 seconds. However, the user may select a 2 or 4 hour clean by using the **-** or **+** keys to change to the desired clean time and then allow the control to accept the change.

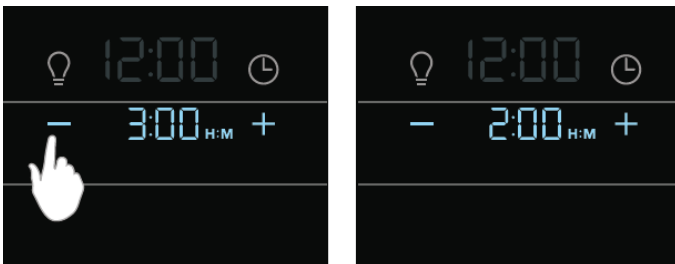

Figure 31: Setting 2 hour clean

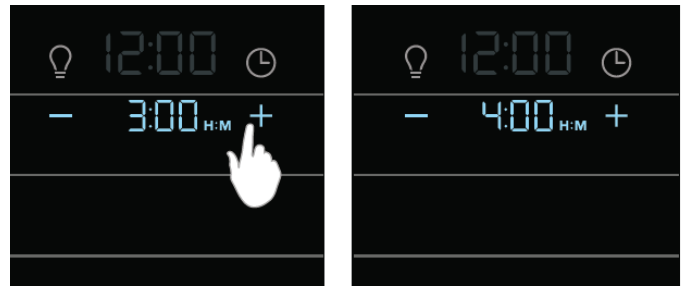

Figure 32: Setting 4 hour clean

Once the control accepts the clean time the display will flash a reminder for the user to **REMOVE RACKS**. The

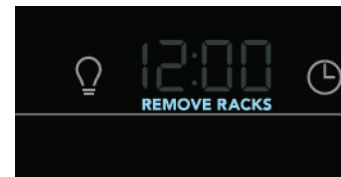

Figure 33: Display prompting user to remove racks

**REMOVE RACKS** notification will flash for a few seconds prompting the user to remove all oven racks. If the oven door is opened as this time the display will show **CLO** to indicate that the door must be closed before the clean cycle can begin. If the door remains open for more than 3 minutes, the clean function will be canceled.

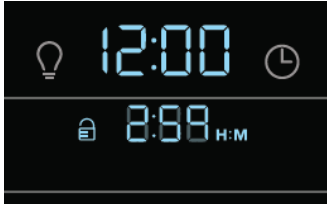

Figure 34: Message of open door that must be closed before oven can begin the clean cycle

When the oven is set to run the clean cycle, the motor door lock will begin locking the oven door. Do not open the oven door while the lock motor is running or when any locking indicators or displays are showing. The oven door is completely locked in about 15 seconds.

## OVEN CONTROLS

- Once the door is closed the time of day will be visible along with the selected clean time and the door lock icon will be visible in the display.



**Figure 35: Clean cycle in progress**

- During the clean cycle the time of day remains in the display and the time remaining in the clean cycle will also be active. (Figure 35)



**Figure 36: Hot oven after clean with door still locked**

- When the clean cycle ends the oven will be too hot for the door to unlock until the oven cools to a safe temperature. This may take up to an hour. During this time the display will show **Hot** along with the door lock icon.
- At this point **CLn** will appear in the display and the lock icon will blink and the control will signal the end of the clean cycle with a chime. The internal oven temperature will still be hot enough to cause burns.

### **!** CAUTION

To avoid possible burns, use care when opening the oven door after the clean cycle. Stand to the side of the oven when opening the door to allow hot air or steam to escape.

Do not force the oven door open while **clean** is active. This can damage the automatic door locking system. Use caution when opening the door after the clean cycle is complete. The oven may still be very hot.

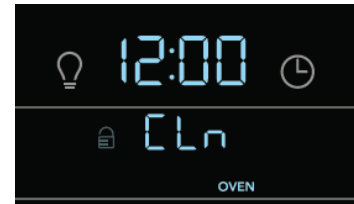
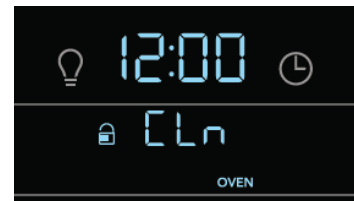

**Figure 37: Clean lock icon blinks as door unlocks**

**Note:** Once the clean cycle ends the oven will not be available for another clean for 4 hours.

#### **To cancel a clean before it ends:**

Turn both the oven selector knob and the oven temperature knob to the **OFF** position.

## CARE AND CLEANING

### Cleaning Various Parts of Your Oven

**Before cleaning any part of the oven, be sure all controls are turned off and the oven is cool.**

Remove spills and any heavy soiling as soon as possible. Regular cleaning will reduce the number of major cleaning later.

| Surface Type  | Recommendation  |
|---|---|
| Aluminum and Vinyl  | <ul style="list-style-type: none"> <li>Use hot, soapy water and a cloth. Dry with a clean cloth.</li> </ul>   |
| Painted body parts  | <ul style="list-style-type: none"> <li>Using a soft cloth, clean with mild dish detergent and water or a 50/50 solution of vinegar and water. Follow by rinsing the area with clean water; dry and polish with a soft cloth. Glass cleaners may be used if sprayed on a soft cloth first. Do not spray liquids directly on the oven control and display area. Do not use large amounts of water on the control panel. Excess water on the control area may cause damage to the appliance. Do not use other liquid cleaners, abrasive cleaners, scouring pads, or paper towels - they will damage the finish.</li> </ul>   |
| Painted decorative trims  |   |
| Painted and plastic control knobs and control panel               |   |
| Surface burners<br>Burner grates                                  | <ul style="list-style-type: none"> <li>To remove control knobs, turn to the OFF position; grasp firmly and pull straight off the shaft. To replace knobs after cleaning, line up the flat sides of both the knob and the shaft; then push the knob into place.</li> <li>For details on cleaning surface burners and grates see <a href="#">“Cleaning the cooktop and surface burners”</a> on <a href="#">page 30</a>.</li> </ul>  |
| Smudge Proof™ Stainless Steel (some models)                       | <ul style="list-style-type: none"> <li>Your oven finish may be made with stainless steel (some models). Clean the stainless with warm soapy water using a clean sponge or cloth. Rinse with clean water and dry with a soft clean cloth.</li> <li>Do not use any store bought cleaners like stainless steel cleaners or any other types of cleaners containing any abrasive, chlorides, chlorine, or ammonia. It is recommended to use mild dish soap and water or a 50/50 solution of water and vinegar.</li> </ul>  |
| Stainless Steel   |   |
| Porcelain enamel broiler pan and insert (available by mail order) | <ul style="list-style-type: none"> <li>Gentle scouring with a soapy scouring pad will remove most spots. Rinse with a 1:1 solution of clear water and ammonia. If necessary, cover difficult spots with an ammonia-soaked paper towel for 30 to 40 minutes. Rinse with clean water and a damp cloth, and then scrub with a soap-filled scouring pad. Rinse and wipe dry with a clean cloth. Remove all cleaners or the porcelain may become damaged during future heating.</li> </ul>   |
| Oven interior (Porcelain)   |   |
| Door liner and body parts   |   |
| Oven racks  | <ul style="list-style-type: none"> <li>Oven racks must be removed from oven cavity. Clean by using a mild, abrasive cleaner following manufacturer’s instructions. Rinse with clean water and dry.</li> </ul>   |
| Oven door   | <ul style="list-style-type: none"> <li>Use soap and water to thoroughly clean the top, sides, and front of the oven door. Rinse well. You may use a glass cleaner on the outside glass of the door. Do not immerse the door in water. Do not spray or allow water or the glass cleaner to enter the door vents. Do not use oven cleaners, cleaning powders, or any harsh abrasive cleaning materials on the outside of the oven door.</li> <li>Do not clean the oven door gasket. On self-clean models, the oven door gasket is made of a woven material which is essential for a good seal. Care should be taken not to rub, damage, or remove this gasket.</li> </ul> |
| Oven door gasket  |   |

## CARE AND CLEANING

### Cleaning the cooktop and surface burners

To avoid possible burns turn off all of the surface burners and allow them to cool.

Any additions, changes or conversions required in order for this appliance to satisfactorily meet the application needs must be made by an authorized qualified agency.

Routinely clean the cooktop. Wipe with a clean, damp cloth and wipe dry to avoid scratches. Keeping the surface burner head ports and slots clean will prevent improper ignition and an uneven flame.

#### To clean recessed and contoured areas of cooktop

If a spill occurs on or in the recessed or contoured areas, blot up spill with an absorbent cloth. Rinse with a clean, damp cloth and wipe dry.

#### To clean burner grates

- Clean when the grates are cool. Use nonabrasive plastic scrubbing pad and mild abrasive cleanser.
- Food soils containing acids may affect the finish. Clean immediately after the grates are cool. Thoroughly dry grates immediately following cleaning.

#### To clean burner caps

- Remove caps from burner heads after they have cooled. Clean heavy soils with a plastic scrubbing pad and absorbent cloth. Thoroughly dry burner caps immediately following cleaning including the bottom and inside of cap.
- Do not use abrasive cleaners. Do not clean burner caps in the dishwasher. Do not operate surface burners without burner caps properly in place.

#### To clean the surface burner heads

For proper gas flow it may be necessary to clean the burner head and slots. First use a clean damp cloth to soak up any spills. Remove any food from between the burner slots using a small nonabrasive brush like a toothbrush and wipe up using a damp cloth. For stubborn soils located in the slots, use a small-gauge wire or needle to clean. The electrode must be carefully cleaned. Take care not to hit the electrode with anything hard or it could be damaged.

#### To clean the burner head ignition ports

Each burner head has a small ignition port (Figure 38). Should you experience ignition problems it may be that this port hole is partially blocked with soil. With the burner head in place, use a small wire gauge needle or the end of a paper clip to clear the ignition port.

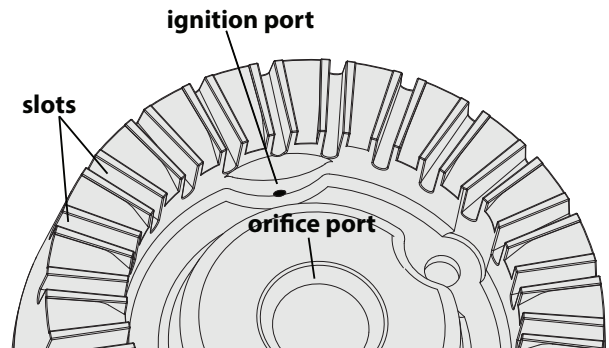

Figure 38: Gas burner head parts

### Replacing the oven light

#### CAUTION

Be sure the oven is unplugged and all parts are cool before replacing oven light.

The interior oven lights are located at the rear of the oven cavity and are covered with glass shields. The glass shield must be in place whenever the oven is in use (Figure 39).

1. Turn electrical power off at the main source or unplug the appliance.
2. Remove interior oven light shield by turning the shield gently counter-clockwise and pull the shield straight out. Do not twist or turn.
3. Replace bulb with a new appliance bulb. Replace glass oven light shield.
4. Turn power back on again at the main source (or plug the appliance back in). Be sure to reset the time of day on the clock.

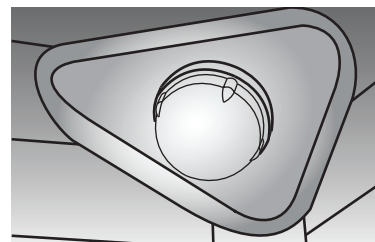

Figure 39: Oven light protected by glass shield

## Removing and Replacing the Oven Door

### **⚠ WARNING**

Do not remove oven door until it is completely cooled.

#### To remove oven door:

1. Open oven door completely horizontal with floor (See [Figure 40](#)).
2. Pull the door hinge locks on both left and right door hinges up from the oven frame completely towards the oven door (See [Figure 41](#)). A tool such as a small flat-blade screwdriver may be required to unlock the hinge ([Figure 42](#)).
3. Grasp both sides of oven door along the door sides. Do not use the oven door handle (See [Figure 43](#)).
4. Keep pulling the bottom of the door toward you while rotating the top of the door toward the appliance to completely disengage the hinge levers ([Figure 43](#)).

#### To replace oven door:

1. Firmly grasp both sides of oven door along the door sides. Do not use the oven door handle (See [Figure 43](#)).
2. Holding the oven door at the same angle as the removal position, seat the hook of the hinge arm over the roller pins located on each side of the oven door frame (See [Figure 43](#)). The hook of the hinge arms must be fully seated onto the roller pins.
3. Fully open the oven door, horizontal with floor See [Figure 40](#)).
4. Push the door hinge locks up towards and into the oven frame on both left and right oven door hinges to the locked position (See [Figure 41](#)).
5. Close the oven door.

### **➔ IMPORTANT**

**Special door care instructions** - Most oven doors contain glass that can break. Do not close the oven door until all the oven racks are fully in place. Do not hit the glass with pots, pans, or any other object. Scratching, hitting, jarring, or stressing the glass may weaken its structure and increase risk of breakage at a later time.

### **⚠ CAUTION**

The door is heavy. For safe, temporary storage, lay the door flat with the inside of the door facing down.

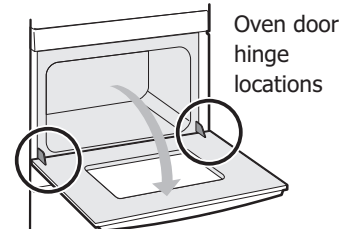

**Figure 40: Door hinge location**

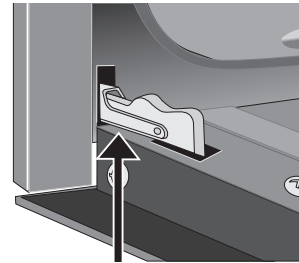

**Figure 41: Door hinge locks**

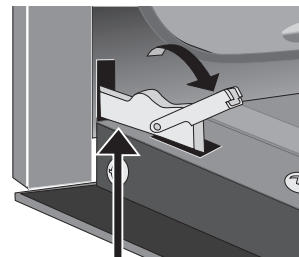

**Figure 42: Hinge in unlocked position**

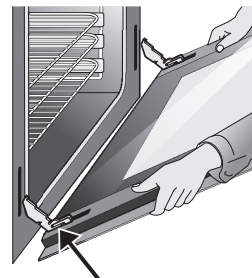

**Figure 43: Holding door for removal**

## CARE AND CLEANING

### Caring for your glide racks

Handle oven racks only when they are cool.

After cooking or after the clean cycle, racks will be very hot and can cause burns.

#### Important Notes:

- It is recommended to remove all racks from the oven during clean cycles. After a clean cycle, or anytime the gliding is rough, the glide racks should be treated with graphite lubrication.
- Do not use cooking oil, cooking spray, or other oil-based lubrication products on the glide rack extension tracks. Use only the graphite lubrication in this area.
- It is important that the parts of the rack that contact the oven sides always have a light coating of vegetable oil. Apply a thin layer of vegetable oil to the sides of the rack after every clean cycle and when the rack becomes difficult to reposition in the oven.

#### To lubricate the glide rack:

1. Remove the rack from the oven and place the rack on a large flat surface covered with newspaper or scrap cloth. Fully extend the rack.
2. Wipe away debris and crumbs from the glide track using a cloth or sponge.

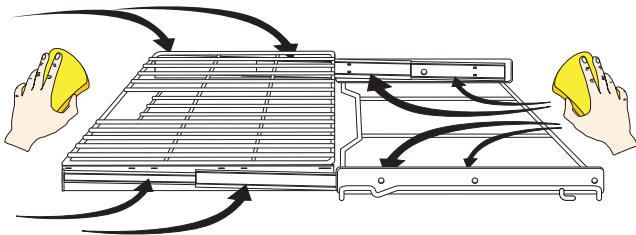

3. Shake graphite lubrication very well before applying. Place four drops of graphite lubrication along the tracks (see area circled on figure below). Repeat on both sides of the glide rack.

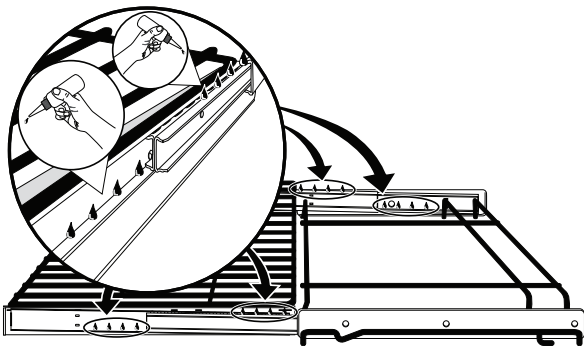

4. Extend and return the glide rack several times along the tracks to distribute the lubrication.

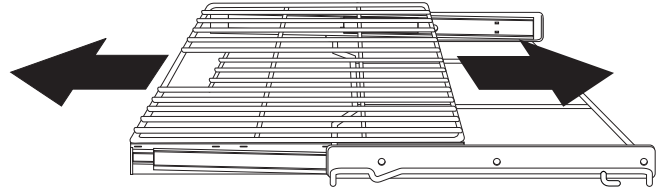

5. Turn glide rack over. Shake graphite lubrication very well before applying. Place four drops of graphite lubrication along the tracks. Repeat on both sides of the glide rack.

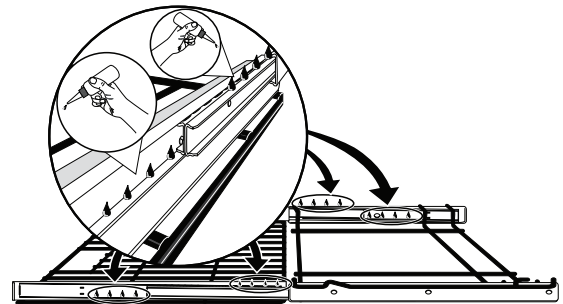

6. Extend and return the glide rack several times along the tracks to distribute the lubrication.

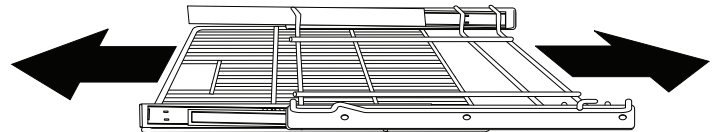

7. Apply a thin layer of cooking oil to the outer frame of the glide rack as shown below. Keeping the frame sides lightly lubricated allows the entire rack to slide easily when changing rack positions.

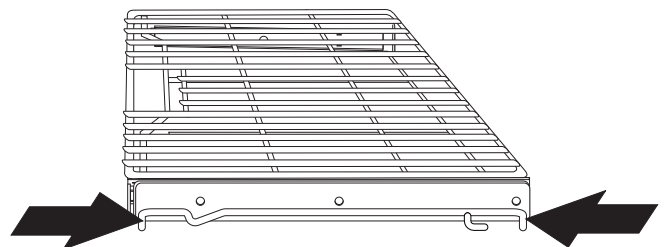





Replace rack in oven right side up.



**Solutions to Common Baking Problems**

For best cooking results, heat the oven before baking cookies, breads, cakes, pies or pastries, etc. There is no need to preheat the oven for roasting meat or baking casseroles. The cooking times and temperatures needed to bake a product may vary slightly from your previously owned appliance.

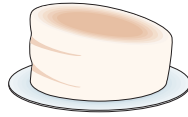
**Baking Problems and Solutions Chart**

| Baking Problems   | Causes  | Corrections  |
|---|---|--|
| <p><b>Cookies and biscuits burn on the bottom.</b></p>     | <ul style="list-style-type: none"> <li>• Cookies and biscuits put into oven before the preheating time is completed.</li> <li>• Oven rack is overcrowded.</li> <li>• Dark pans absorb heat too fast.</li> </ul> | <ul style="list-style-type: none"> <li>• Allow oven to preheat to desired temperature before placing food in oven.</li> <li>• Choose pan sizes that will permit 2" to 4" of air space (5.1 cm to 10.2 cm) on all sides when placed in the oven.</li> <li>• Use a medium weight baking sheet.</li> </ul>  |
| <p><b>Cakes too dark on top or bottom.</b></p>             | <ul style="list-style-type: none"> <li>• Cakes put in oven before preheating time is completed.</li> <li>• Rack position too high or too low.</li> <li>• Oven too hot.</li> </ul>                               | <ul style="list-style-type: none"> <li>• Allow oven to preheat to the selected temperature before placing food in the oven.</li> <li>• Use proper rack position for baking needs.</li> <li>• Set oven temperature 25°F/13°C lower than recommended.</li> </ul>   |
| <p><b>Cakes not done in center.</b></p>                  | <ul style="list-style-type: none"> <li>• Oven too hot.</li> <li>• Incorrect pan size.</li> <li>• Pan not centered in oven.</li> </ul>   | <ul style="list-style-type: none"> <li>• Set oven temperature 25°F/13°C lower than recommended.</li> <li>• Use pan size suggested in recipe.</li> <li>• Use proper rack position and place pan to allow for 2" to 4" (5.1 cm to 10.2 cm) of space on all sides of pan.</li> </ul>  |
| <p><b>Cakes not level.</b></p>                           | <ul style="list-style-type: none"> <li>• Range not level.</li> <li>• Pan too close to oven wall or rack overcrowded.</li> <li>• Pan warped.</li> <li>• Oven light left on during baking.</li> </ul>             | <ul style="list-style-type: none"> <li>• Place a marked glass measuring cup filled with water on the center of the oven rack. If the water level is uneven, refer to the installation instructions for leveling the range.</li> <li>• Be sure to allow 2" to 4" (5.1 cm to 10.2 cm) of clearance on all sides of each pan in the oven.</li> <li>• Do not use pans that are dented or warped.</li> <li>• Keep oven light off while baking.</li> </ul> |
| <p><b>Foods not done when cooking time is over.</b></p>  | <ul style="list-style-type: none"> <li>• Oven too cool.</li> <li>• Oven overcrowded.</li> <li>• Oven door opened too frequently.</li> </ul>   | <ul style="list-style-type: none"> <li>• Set oven temperature 25°F/13°C higher than suggested and bake for the recommended time.</li> <li>• Be sure to remove all pans from the oven except the ones to be used for baking.</li> <li>• Open oven door only after shortest recommended baking time.</li> </ul>  |

## BEFORE YOU CALL

### Solutions to Common Problems

Before you call for service, review the following list. It may save you time and expense. Possible solutions are provided with the problem listed:

| Problem   | Solution   |
|---|--|
| Poor baking results   | Many factors effect baking results. Use proper oven rack position. Center food in the oven and space pans to allow air to circulate. Preheat oven to the set temperature before placing food in the oven. Try adjusting the recipe's recommended temperature or baking time. See <a href="#">“Adjusting the Oven Temperature”</a> on <a href="#">page 25</a> if you feel the oven is too hot or cold.  |
| Appliance is not level  | Be sure floor is level, strong and stable enough to adequately support range. If floor is sagging or sloping, contact a carpenter to correct the situation.<br><br>Poor installation. Place oven rack in center of oven and place a level on the oven rack. Adjust leveling legs at base of appliance until the rack is level.<br><br>Kitchen cabinet alignment may make range appear not level. Be sure cabinets are square and have sufficient room for appliance clearance.         |
| Cannot move appliance easily. Appliance must be accessible for service. | Cabinets not square or are built in too tight to allow clearance for appliance. Contact builder or installer to make appliance accessible.<br><br>Carpet interferes with appliance. Provide sufficient space so appliance can be lifted over carpet.   |
| Entire appliance does not work.   | For models with a power cord, make sure power cord is plugged properly into outlet. If electricity to home is working, check fuse box or breaker. Call your local electric company for service outage information..  |
| Oven portion does not operate.  | The time of day is not set. The oven clock must first be set in order to operate the oven. See <a href="#">“Setting the Clock”</a> on <a href="#">page 15</a> .<br><br>Be sure oven controls are set properly. See <a href="#">“Oven Control Functions”</a> on <a href="#">page 14</a> and review instructions for the desired cooking function in this manual or see <a href="#">“Entire appliance does not operate”</a> in this checklist.   |
| Oven light does not work.   | Be sure the oven light is secure in the socket. See <a href="#">“Replacing the oven light”</a> on <a href="#">page 30</a> .  |
| Flames inside oven or smoking from oven vent.                           | Excessive spills in oven. Grease or food spilled onto oven bottom or oven cavity. Wipe up excessive spills before starting oven. If flames or excessive smoke are present when using Broil, see <a href="#">“Using the Broil Feature”</a> on <a href="#">page 21</a> .   |
| Oven racks discolored or do not slide easily.                           | Oven racks left in oven cavity during <b>Clean</b> . Always remove oven racks from oven cavity before starting a clean cycle. Clean by using a mild abrasive cleaner following manufacturer's instructions. Rinse with clean water, dry, and replace in oven.  |
| Oven smokes excessively when broiling.                                  | Incorrect setting. Follow broiling instructions in <a href="#">Setting Oven Controls</a> section.<br><br>Meat too close to the broil flame. Reposition broil rack to provide proper clearance between the meat and flame. Remove excess fat from meat. Cut remaining fatty edges to prevent curling, but do not cut into lean.<br><br>Grease build up on oven surfaces. Regular cleaning is necessary when broiling frequently. Grease or food splatters will cause excessive smoking. |

## BEFORE YOU CALL

|  |   |
|--|---|
| Oven control panel sounds an audible alarm and displays an Error code. | Oven control has detected a fault or error condition. Turn either oven mode or temperature selector to the OFF position to clear the error code. Try Bake or Broil function. If the Error code error repeats, turn OFF power to appliance, wait 5 minutes and then repower appliance. Set clock with correct time of day. Try Bake or Broil function again. If fault recurs, turn oven mode and temperature selectors OFF and call 1-800-4-MY-HOME® for assistance.   |
| Soil not completely removed after Clean                                | <p>Clean was interrupted. Review instructions in Clean section.</p> <p>Excessive spills on oven bottom. Clean before starting Clean.</p> <p>Failure to clean soil from the oven frame, the door liner outside the oven door gasket and the small area at the front center of the oven bottom. These areas are not in the self-cleaning area, but get hot enough to burn on residue. Clean these areas before starting the clean cycle. Burned-on residue can be cleaned with a stiff nylon brush and water or a nylon scrubber. Be careful not to damage the oven gasket.</p>   |
| Convection fan does not rotate.  | <p>Oven door is open. Convection fan will turn off if oven door is opened when Convection is active. Close oven door.</p> <p>The convection fan will turn on after the oven has been heating for 6 minutes, and remain on during the cooking process.</p>   |
| Clean does not work.   | Oven control not set properly. Review instructions in Clean section.  |
| Surface burners do not ignite.   | <p>Surface control knob was not completely turned to Lite. Push in and turn the surface control knob to Lite until burner ignites and then turn control knob to desired flame size.</p> <p>Burner ports are clogged. With the burner OFF, use a small-gauge wire or needle to burner head slots and ignition ports.</p> <p>Range power cord is disconnected from outlet (electric ignition models only). Be sure power cord is securely plugged into the power outlet. Electrical power outage. Burners may be lit manually. See <a href="#">“Operating the gas surface controls”</a> on page <a href="#">page 9</a>.</p> |
| Surface burner flame uneven or only part way around the burner cap.    | <p>Burner slots or ports are clogged. With the surface burner OFF, clean ports with a small gauge wire or needle.</p> <p>Moisture is present after cleaning. Lightly fan the flame and allow burner to operate until flame is full.</p> <p>Burner caps are not seated properly. Check that all burner caps are level and seated correctly on burner heads.</p>  |
| Surface burner flame is too high.                                      | <p>Surface control knob is set too high. Adjust to lower flame setting.</p> <p>Burner caps are not seated properly. Check that all surface burner caps are level and seated correctly on surface burner heads.</p> <p>Incorrect L.P. conversion. Refer to L.P. conversion kit instructions to correct.</p>  |

# WARRANTY

Your appliance is covered by a one year limited warranty. For one year from your original date of purchase, Electrolux will pay all costs for repairing or replacing any parts of this appliance that prove to be defective in materials or workmanship when such appliance is installed, used and maintained in accordance with the provided instructions.

## Exclusions

This warranty does not cover the following:

1. Products with original serial numbers that have been removed, altered or cannot be readily determined.
2. Product that has been transferred from its original owner to another party or removed outside the USA or Canada.
3. Rust on the interior or exterior of the unit.
4. Products purchased "as-is" are not covered by this warranty.
5. Food loss due to any refrigerator or freezer failures.
6. Products used in a commercial setting.
7. Service calls which do not involve malfunction or defects in materials or workmanship, or for appliances not in ordinary household use or used other than in accordance with the provided instructions.
8. Service calls to correct the installation of your appliance or to instruct you how to use your appliance.
9. Expenses for making the appliance accessible for servicing, such as removal of trim, cupboards, shelves, etc., which are not a part of the appliance when it is shipped from the factory.
10. Service calls to repair or replace appliance light bulbs, air filters, water filters, other consumables, or knobs, handles, or other cosmetic parts.
11. Surcharges including, but not limited to, any after hour, weekend, or holiday service calls, tolls, ferry trip charges, or mileage expense for service calls to remote areas, including the state of Alaska.
12. Damages to the finish of appliance or home incurred during installation, including but not limited to floors, cabinets, walls, etc.
13. Damages caused by: services performed by unauthorized service companies; use of parts other than genuine Electrolux parts or parts obtained from persons other than authorized service companies; or external causes such as abuse, misuse, inadequate power supply, accidents, fires, or acts of God.

## DISCLAIMER OF IMPLIED WARRANTIES; LIMITATION OF REMEDIES

CUSTOMER'S SOLE AND EXCLUSIVE REMEDY UNDER THIS LIMITED WARRANTY SHALL BE PRODUCT REPAIR OR REPLACEMENT AS PROVIDED HEREIN. CLAIMS BASED ON IMPLIED WARRANTIES, INCLUDING WARRANTIES OF MERCHANTABILITY OR FITNESS FOR A PARTICULAR PURPOSE, ARE LIMITED TO ONE YEAR OR THE SHORTEST PERIOD ALLOWED BY LAW, BUT NOT LESS THAN ONE YEAR. ELECTROLUX SHALL NOT BE LIABLE FOR CONSEQUENTIAL OR INCIDENTAL DAMAGES SUCH AS PROPERTY DAMAGE AND INCIDENTAL EXPENSES RESULTING FROM ANY BREACH OF THIS WRITTEN LIMITED WARRANTY OR ANY IMPLIED WARRANTY. SOME STATES AND PROVINCES DO NOT ALLOW THE EXCLUSION OR LIMITATION OF INCIDENTAL OR CONSEQUENTIAL DAMAGES, OR LIMITATIONS ON THE DURATION OF IMPLIED WARRANTIES, SO THESE LIMITATIONS OR EXCLUSIONS MAY NOT APPLY TO YOU. THIS WRITTEN WARRANTY GIVES YOU SPECIFIC LEGAL RIGHTS. YOU MAY ALSO HAVE OTHER RIGHTS THAT VARY FROM STATE TO STATE.

## If You Need Service

Keep your receipt, delivery slip, or some other appropriate payment record to establish the warranty period should service be required. If service is performed, it is in your best interest to obtain and keep all receipts. Service under this warranty must be obtained by contacting Electrolux at the addresses or phone numbers below.

This warranty only applies in the USA and Canada. In the USA, your appliance is warranted by Electrolux Major Appliances North America, a division of Electrolux Home Products, Inc. In Canada, your appliance is warranted by Electrolux Canada Corp. Electrolux authorizes no person to change or add to any obligations under this warranty. Obligations for service and parts under this warranty must be performed by Electrolux or an authorized service company. Product features or specifications as described or illustrated are subject to change without notice.

USA  
1.800.944.9044  
Electrolux Home Products, Inc.  
10200 David Taylor Drive  
Charlotte, NC 28262



Canada  
1.800.265.8352  
Electrolux Canada Corp.  
5855 Terry Fox Way  
Mississauga, Ontario, Canada  
L5V 3E4