



OWNER'S MANUAL

DRYER

Please read this manual carefully before operating your dryer and retain it for future reference.

DLEC888W
DLEC888R



MFL67653090

www.lg.com

Features



- **Ultra Big Capacity Drum**
The LG Dryer has a large capacity.

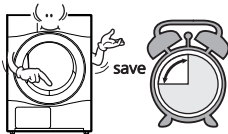

- **Reduced drying time**
Drying time is reduced by the use of an efficient air flow system and an optimized heater.

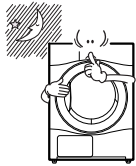

- **Innovative Noise Reduction**
The optimized design of the air flow system and the vibration reduction technology helps to reduce noise.

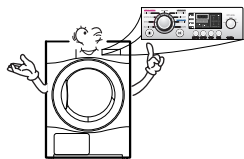

- **Ease of Use**
The electronic control has a large, easy to read LED display.

What are Sensor Dry and Manual Dry?

Your dryer provides sensor drying and manual drying programs.

Sensor Dry Dryer electronically senses laundry moisture level and automatically determines operation time based on the dryness of the load and the selected program. The control will change the estimated time remaining if it senses a large change in the time needed to complete the cycle. These large increases or decreases in the time display are normal, and do not indicate a product malfunction.

Manual Dry Manual Dry allows you to set the desired dry time manually. Certain types of loads, such as large and/or bulky loads, may not dry properly using Sensor Dry. These loads should be dried using the Manual Dry feature to ensure complete drying.

Contents

| | |
|-------------------------------------|----|
| Safety Instructions | 3 |
| Installation Instructions | 7 |
| Electrical Requirement | 11 |
| Appearance And Design | 14 |
| Operating Your Dryer | 15 |
| Additional Functions..... | 18 |
| Caring For Your Dryer | 22 |
| Additional Tips For Smart Use | 25 |
| Troubleshooting Guide | 27 |
| Technical Data | 32 |
| Warranty | 33 |

Safety Instructions

READ ALL INSTRUCTIONS BEFORE USE

WARNING

For your safety, the information in this manual must be followed to minimize the risk of fire or explosion, electric shock, or to prevent property damage, personal injury, or loss of life.

Your Safety and the safety of others is very important.

We have provided many important safety messages in this manual and on your appliance. Always read and obey all safety messages.



This is the safety alert symbol.

This symbol alerts you to potential hazards that can kill or hurt you and others.

All safety messages will follow the safety alert symbol and either the word DANGER or WARNING.

These words mean:



DANGER: You can be killed or seriously injured if you don't immediately follow instructions.



WARNING: You can be killed or seriously injured if you don't follow instructions.

All safety messages will tell you what the potential hazard is, tell you how to reduce the chance of injury, and tell you what can happen if the instructions are not followed.

BASIC SAFETY PRECAUTIONS

WARNING

To reduce the risk of fire, electric shock, or injury to persons when using this appliance, follow basic precautions, including the following:

- Do not install a clothes dryer with flexible plastic venting materials. If flexible metal (foil type) duct is installed, it must be of a specific type identified by the appliance manufacturer as suitable for use with clothes dryers. Flexible venting materials are known to collapse, be easily crushed, and trap lint. These conditions will obstruct clothes dryer airflow and increase the risk of fire.
- Do not store or use gasoline or other flammable vapors and liquids in the vicinity of this appliance or any other appliances.
- Installation and service must be performed by a qualified installer, service agency, or the gas supplier.
- Install the clothes dryer according to the manufacturer's instructions and local codes.
- Save these instructions.
- Certain internal parts are intentionally not grounded and may present a risk of electronic shock only during serving. Service personnel - do not contact the following parts while the appliance is energized: Motor

GROUNDING INSTRUCTIONS

This appliance must be grounded. In the event of malfunction or breakdown, grounding will reduce the risk of electric shock by providing a path of least resistance for electric current. This appliance must be equipped with a cord having an equipment-grounding conductor and a grounding plug. The plug must be plugged into an appropriate outlet that is properly installed and grounded in accordance with all local codes and ordinances.

Do not modify the plug provided with the appliance. If it will not fit the outlet, have a proper outlet installed by a qualified electrician.

This appliance must be connected to a grounded metal, permanent wiring system or an equipment-grounding conductor must be run with the circuit conductors and connected to the equipment-grounding terminal or lead on the appliance. Electrical shock can result if the dryer is not properly grounded.

Safety Instructions

BASIC SAFETY PRECAUTIONS

⚠ WARNING

To reduce the risk of fire, electric shock, or injury to persons when using this appliance, follow basic precautions, including the following:

- Read all instructions before using the dryer.
- Before use, the dryer must be properly installed as described in this manual.
- Do not place items exposed to cooking oils in your dryer. Items contaminated with cooking oils may contribute to a chemical reaction that could cause a load to catch fire.
- Do not dry articles that have been previously cleaned in, washed in, soaked in, or spotted with gasoline, dry-cleaning solvents, or other flammable or explosive substances as they give off vapors that could ignite or explode.
- Do not reach into the dryer if the drum or any other part is moving.
- Do not repair or replace any part of the dryer or attempt any servicing unless specifically recommended in this Use and Care Guide or in published user-repair instructions that you understand and have the skills to carry out.
- Do not tamper with controls.
- Before the dryer is removed from service or discarded, remove the door to the drying compartment.
- Do not allow children to play on or in the dryer. Close supervision of children is necessary when the dryer is used near children.
- Do not use fabric softeners or products to eliminate static unless recommended by the manufacturer of the fabric softener or product.
- Do not use heat to dry articles containing foam rubber or similarly textured rubber-like materials.
- Keep area around the exhaust opening and adjacent surrounding areas free from the accumulation of lint, dust, and dirt.
- The interior of the dryer and exhaust vent should be cleaned periodically by qualified service personnel.
- Do not install or store the dryer where it will be exposed to the weather.
- Always check the inside of the dryer for foreign objects.
- Clean lint screen before or after each load.
- Do not spray dry cleaning detergent directly onto the product or use the product to dry clothes that have dry cleaning detergent on them. Doing so could result in an explosion or fire.
- Do not dry clothes that are stained with combustible or flammable materials. Doing so could result in an explosion or fire. Flammable materials include thinners, benzene, solvents, cleaning solutions, acetone, alcohol, gasoline, turpentine, wax, wax removers, hair gel, hairspray, edible oils, motor oil, creams, cosmetic products and lotions, and oil stains.
- Do not dry clothes stained with oily substances. Oily substances (including edible oils) on clothes cannot be completely removed even by washing with water, and the remaining oil could result in a fire if dried.
- Remove clothes promptly from the dryer after the cycle ends or if there is a power outage during the cycle. Do not store clothing in the dryer.

⚠ WARNING

Improper connection of the equipment-grounding conductor can result in a risk of electric shock. Check with a qualified electrician or service person if you are in doubt as to whether the appliance is properly grounded.

Safety Instructions

SAFETY INSTRUCTIONS FOR INSTALLATION

⚠ WARNING

To reduce the risk of fire, electric shock, or injury to persons when using this appliance, follow basic precautions, including the following:

- **Properly ground dryer to conform with all governing codes and ordinances.** Follow details in the installation instructions. Electrical shock can result if the dryer is not properly grounded.
- **Before use, the dryer must be properly installed as described in this manual.** Electrical shock can result if the dryer is not properly grounded.
- **Install and store the dryer where it will not be exposed to temperatures below freezing or exposed to the weather.**
- **All repairs and servicing must be performed by an authorized servicer unless specifically recommended in this Owner's Guide. Use only authorized factory parts.** Failure to follow this warning can cause serious injury, fire, electrical shock, or death.
- **To reduce the risk of electric shock, do not install the dryer in humid spaces.** Failure to follow this warning can cause serious injury, fire, electrical shock, or death.
- **Connect to a properly rated, protected, and sized power circuit to avoid electrical overload.** Improper power circuit can melt, creating electrical shock and/or fire hazard.
- **Remove all packing items and dispose of all shipping materials properly.** Failure to do so can result in death, explosion, fire, or burns.
- **Place dryer at least 18 in. above the floor for a garage or basement installation.** Failure to do so can result in death, explosion, fire, or burns.
- **Keep all packaging from children.** Packaging material can be dangerous for children. There is a risk of suffocation.
- **Do not install nearby heat item.** Such as stove, cooking oven. Failure to do so can cause damage, smoke, and fire.
- **Do not place candle and cigarettes on top of the product.** Failure to do so can cause damage, smoke, and fire.
- **Remove all protective vinyl film from the product.** Failure to do so can cause damage, smoke, and fire.
- Certain internal parts are intentionally not grounded and may present a risk of electronic shock only during serving. Service personnel - do not contact the following parts while the appliance is energized: Motor

READ ALL INSTRUCTIONS BEFORE USE

Safety Instructions

⚠ WARNING

To reduce the risk of fire, electric shock, or injury to persons when using this appliance, follow basic precautions, including the following:

SAFETY INSTRUCTIONS FOR INSTALLATION

- Do not, under any circumstances, cut or remove the ground prong from the power cord. To prevent personal injury or damage to the dryer, the electrical power cord must be plugged into a properly grounded outlet.
- For personal safety, this dryer must be properly grounded. Failure to do so can result in electrical shock or injury.
- Refer to the installation instructions in this manual for specific electrical requirements for your model. Failure to follow these instructions can create an electrical shock hazard and/or a fire hazard.
- This dryer must be plugged into a properly grounded outlet. Electrical shock can result if the dryer is not properly grounded. Have the wall outlet and circuit checked by a qualified electrician to make sure the outlet is properly grounded. Failure to follow these instructions can create an electrical shock hazard and/or a fire hazard.
- The dryer should always be plugged into its own individual electrical outlet which has a voltage rating that matches the rating plate. This provides the best performance and also prevents overloading house wiring circuits which could cause a fire hazard from overheated wires.
- Never unplug your dryer by pulling on the power cord. Always grip plug firmly and pull straight out from the outlet. The power cord can be damaged, resulting in a risk of fire and electrical shock.
- Repair or replace immediately all power cords that have become frayed or otherwise damaged. Do not use a cord that shows cracks or abrasion damage along its length or at either end. The power cord can melt, creating electrical shock and/or fire hazard.
- When installing or moving the dryer, be careful not to pinch, crush, or damage the power cord. This will prevent injury and prevent damage to the dryer from fire and electrical shock.

⚠ WARNING: This product contains chemicals known to the State of California to cause cancer and birth defects or other reproductive harm. *Wash hands after handling.*

CALIFORNIA SAFE DRINKING WATER AND TOXIC ENFORCEMENT ACT

This act requires the governor of California to publish a list of substances known to the state to cause cancer, birth defects, or other reproductive harm and requires businesses to warn customers of potential exposure to such substances.

Gas appliances can cause minor exposure to four of these substances, namely benzene, carbon monoxide, formaldehyde, and soot, caused primarily by the incomplete combustion of natural gas or LP fuels.

Properly adjusted dryers will minimize incomplete combustion. Exposure to these substances can be minimized further by properly venting the dryer to the outdoors.

SAVE THESE INSTRUCTIONS

Installation Instructions

The following instructions will help guide you through the initial steps of setting up your dryer for use. Please note that every section of this manual provides important information regarding the preparation and use of your dryer, and it is important that you review this entire manual before proceeding with any installation or use. More detailed instructions concerning electrical connections, gas connections, and exhaust requirements are provided in other parts of this manual.

STEP 1 Positioning the Dryer.

Choose a location with a solid floor for your dryer. Place the dryer at least eighteen inches above the floor for a garage installation. After placing the dryer in the desired location, make sure that it has the required clearances shown.

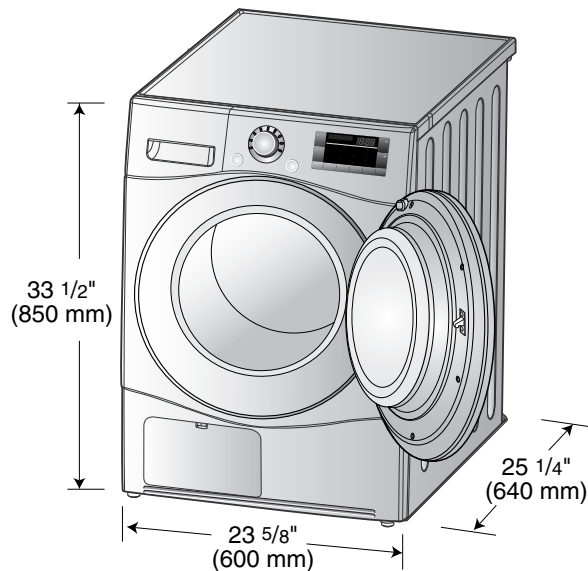

Note

Leveling legs should be secured.

All four legs should be on a solid, even floor and properly leveled as shown in this manual.

If dryer is not level, laundry may not be able to accurately detect the moisture level in the clothes.

When leveling, please be cautious to avoid injury.

Installation Instructions

STEP 2 Electrical Connections

Following are several warnings and instructions concerning making the electrical connection for electric dryers. More detailed information concerning the electrical connection is provided at the manual section entitled Electrical Requirements For Electric Dryer and it is important that you thoroughly review that section, and the remainder of this manual, before taking any steps to install or use this dryer.

1. Use only a new U.L. listed No. 10 (copper wire only) conductor power supply cord kit rated 240 Volts (minimum) 30 Amperes and labeled as suitable for use in a clothes dryer.
2. 4-wire cord is required for manufactured (mobile) home installations and use and where local codes do not allow grounding of this appliance through neutral. As well as all new construction after January 1, 1996.
3. For additional instruction on connecting the dryer to an electrical power source, please refer to this manual's section on Electrical Requirements for Electric Dryer.

⚠ WARNING

- Use a new UL approved 30 amp power supply cord or 10 gauge solid copper wire.
- Use a UL approved strain relief.
- Disconnect power before making electrical connections.
- Connect neutral wire (white or center) to center terminal.
- Ground wire (green or bare) must be connected to green ground connector.
- Securely tighten all electrical connections
- See installation instructions for complete instructions.
- A 4-wire connection is required for all mobile and manufactured home installations, as well as all new construction after January 1, 1996.
- Failure to do so can result in fire or electrical shock.

STEP 3 Preparation of the Dryer

Prior to the first use of this appliance, use all-purpose cleaning products or a solution of detergent and water, with a damp cloth to remove from the inside of the dryer drum/drying compartment any dust or dirt that may have accumulated in the inside of the dryer. Plug in your dryer after reviewing the following parts on your dryer's Electrical Requirements.

STEP 4 Confirming Heat Source Operation

Close the door to the dryer drum/drying compartment and, after completing all steps in this manual for proper installation of this dryer, start the dryer on a heat setting, as described more fully in the operating instructions that accompany the dryer.

STEP 5 Additional Instructions for Installation of Your Dryer in a Manufactured or Mobile Home

The following instructions are applicable to installations of the dryer in a manufactured or mobile home. Any installation in a manufactured or mobile home must comply with the Manufactured Home Construction and Safety Standards Title 24 CFR, Part 32-80 or Standard CAN/CSA Z240 MH and local codes and ordinances. If you are uncertain whether your proposed installation will comply with these standards, please contact a service and installation professional for assistance.

- 1) The electrical connection for an electric dryer must be a 4-wire connection. More detailed information concerning the electrical connection is provided at the manual section entitled Electrical Requirements for Electric Dryer

Installation Instructions

Stacking Kit

In order to stack this dryer on an LG stacking kit is required.

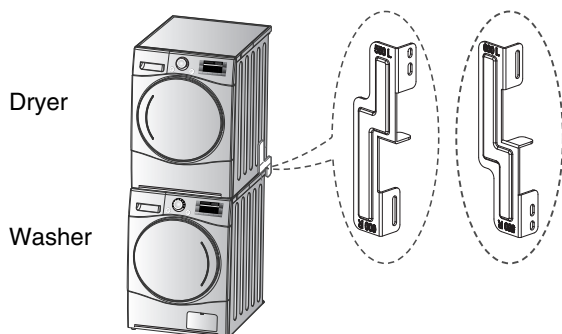

This dryer may only be stacked on top of an LG washer. DO NOT attempt to stack this dryer on any other washer, as damage, injury or property damage could result.

| Shape and assembly direction | Washer Top plate size | |
|------------------------------|-----------------------|---------------------|
| | 21 7/8 inch (550mm) | 23 5/8 inch (600mm) |
| | | |

Installation Procedure

1. Place the LG dryer on the LG washing machine.
2. Remove the two screws from the bottom of the rear cover on each side as illustrated below.

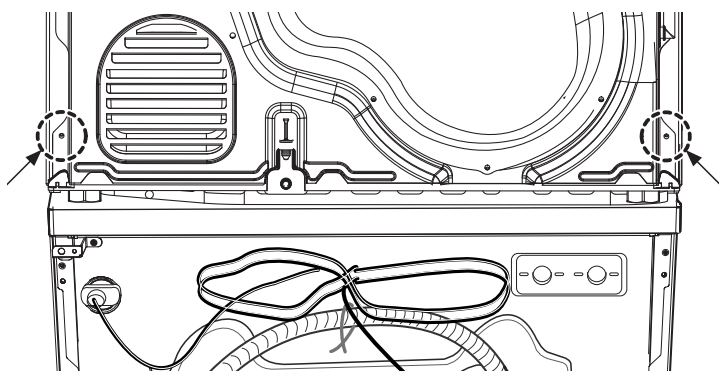

WARNING

- Incorrect installation can cause serious accidents.
- The weight of the dryer and the height of installation makes the stacking procedure too risky for one person. This procedure should be performed by 2 or more experienced service personnel.
- The dryer is not suitable for a built-in installation. Please do not install as a built-in appliance.
- Do not operate if the dryer is disassembled.

3. Align the stacking kit holes and the rear cover holes.

3-1) 23 5/8 inch (600mm)

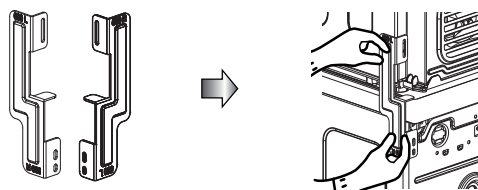

3-2) 21 7/8 inch (550mm)

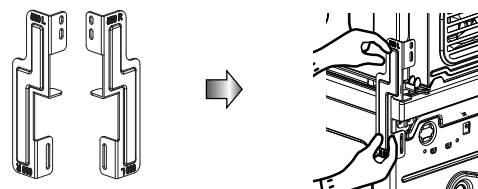

- Fasten the 2 screws that were removed earlier from the dryer to the stacking kit.
- Use 4 screws in accessory box [0.6inch (16mm)] to assemble washer rear cover and stacking kit.
- The procedure for the opposite side will be the same.

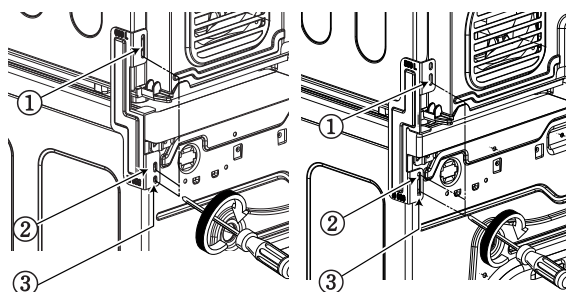

Installation Instructions

● Level the dryer



1. Level the dryer is to prevent undesirable noise and vibration.

Locate your dryer on a solid, level floor. Make sure it is not subjected to splashing water or freezing temperatures. Do not store flammable materials near the dryer.

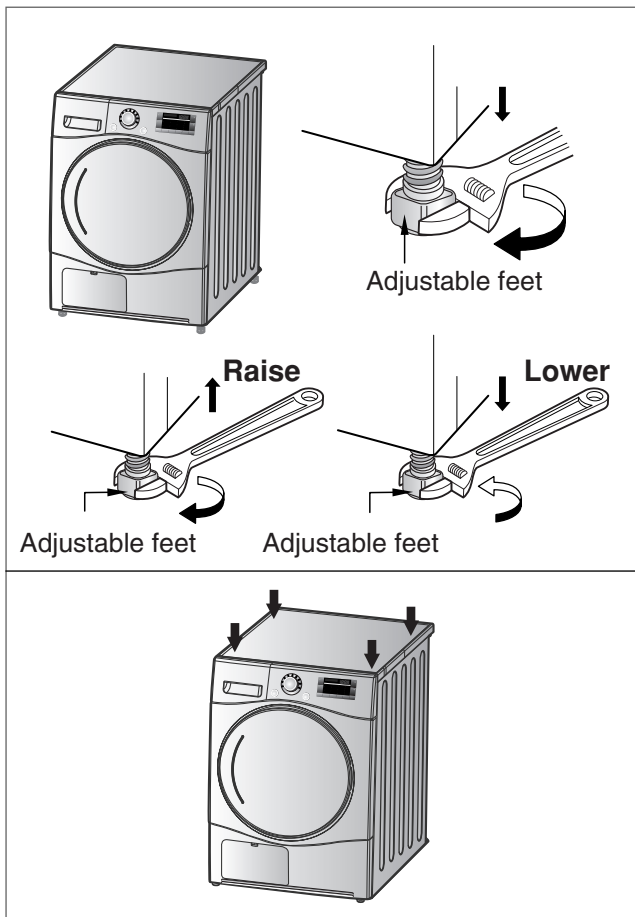

2. If the dryer is not properly level, adjust the front leveling legs up and down as necessary.

Turn the legs clockwise to raise the dryer and counterclockwise to lower the dryer. Check the dryer diagonally to make sure it does not rock either way. Readjust the legs if necessary.

* Diagonal Check

When pushing down corners of the dryer, the machine should not move at all. (Check in either direction.)

If machine rocks when pushing the machine top plate diagonally, adjust the feet again.

Electrical Requirement

CONNECTING ELECTRIC DRYERS

⚠ WARNING

To help prevent fire, electric shock, serious injury, or death, the wiring and grounding must conform to the latest edition of the National Electrical Code, ANSI/NFPA 70 and all applicable local regulations. Please contact a qualified electrician to check your home's wiring and fuses to ensure that your home has adequate electrical power to operate the dryer.

⚠ WARNING

To reduce the risk of fire, electric shock, or injury to persons when using this appliance, follow basic precautions, including the following:

- **This dryer must be connected to a grounded metal, permanent wiring system, or an equipment-grounding conductor must be run with the circuit conductors and connected to the equipment-grounding terminal or lead on the dryer.** Failure to do so can result in fire, explosion, or death.
- **The dryer has its own terminal block that must be connected to a separate 240 VAC, 60-Hertz, single-phase circuit, fused at 30 amperes (the circuit must be fused on both sides of the line.)**
ELECTRICAL SERVICE FOR THE DRYER SHOULD BE OF THE MAXIMUM RATE VOLTAGE LISTED ON THE NAMEPLATE. DO NOT CONNECT DRYER TO 110-, 115-, OR 120-VOLT CIRCUIT. Heating elements are available for field installation in dryers which are to be connected to an electrical service of a different voltage than that listed on the rating plate. Failure to follow these instructions can result in fire, explosion, or death.
- **If branch circuit to dryer is 15 ft. (4.5 m) or less in length, use UL (Underwriters Laboratories) listed No.-10 AWG wire (copper wire only), or as required by local codes. If over 15 ft. (4.50 m), use UL-listed No.-8 AWG wire (copper wire only), or as required by local codes. Allow sufficient slack in wiring so dryer can be moved from its normal location when necessary.** Failure to do so can result in fire, explosion, or death.

- **The power cord (pigtail) connection between wall receptacle and dryer terminal block IS NOT supplied with dryer. Type of pigtail and gauge of wire must conform to local codes and with instructions on the following pages.** Failure to follow these instructions can result in fire, explosion, or death.
- **A 4-wire connection is required for all mobile and manufactured home installations, as well as all new construction after January 1, 1996. A 4-wire connection must be used where local codes do not permit grounding through the neutral wire.** Failure to do so can result in fire, explosion, or death.
- Do not modify the plug and internal wire provided with the dryer.
- If it does not fit the outlet, a proper outlet will need to be installed by a qualified electrician.

Special Electrical Requirements for Mobile or Manufactured Homes

⚠ WARNING

To reduce the risk of fire, electric shock, or injury to persons when using this appliance, follow basic precautions, including the following:

- Any installation in a manufactured or mobile home must comply with the Manufactured Home Construction and Safety Standards Title 24 CFR, Part 32-80 or Standard CAN/CSA Z240 MH and local codes and ordinances.
- **A 4-wire connection is required for all mobile and manufactured home installations, as well as all new construction after January 1, 1996.** Failure to do so can result in fire, explosion, or death.

Electrical Requirement

Review the following options to determine the appropriate electrical connection for your home:



**4-wire receptacle
(NEMA type 14-30R)**

Use the instructions in this section if your home has a 4-wire receptacle (NEMA type 14-30R) and you will be using a UL listed, 120/240 volt minimum, 30 amp, dryer power supply cord.



**3-wire receptacle
(NEMA type 10-30R)**

Use the instructions in this section if your home has a 3-wire receptacle (NEMA type 10-30R) and you will be using a UL listed, 120/240 volt minimum, 30 amp, dryer power supply cord.

Note

- Be sure the screws of the terminal block are tightened firmly. Failure to properly tighten the screws can result in fire, or property damage.
- If you are not sure of the power supply wires or cannot tell which are hot and neutral, consult a qualified electrician.
- If you are not sure if your electric outlet is wired properly, consult a qualified electrician. Connecting the power supply incorrectly can result in product damage, fire, injury or death.
- Direct wiring is not permitted by code in most locations. It is the customer's responsibility to ensure that the installation meets all local codes.

Option 1: 4-wire connection with a Power supply cord.

- If your local codes or ordinances do not allow the use of a 3 wire connection, or you are installing your dryer in a mobile home, you must use a 4-wire connection.

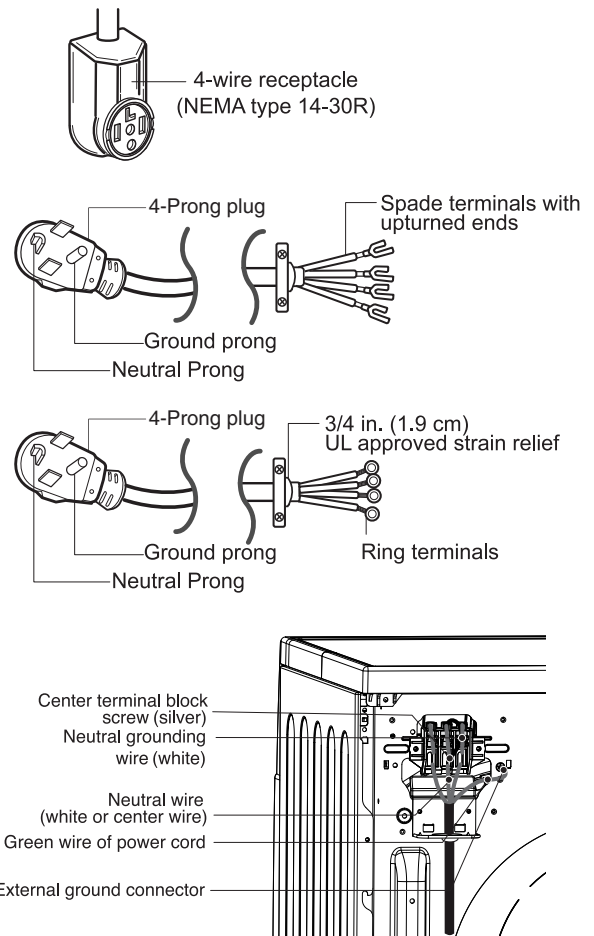

1. Connect neutral wire (white) of power cord to center terminal block screw.
2. Connect red and black wire to the left and right terminal block screws.
3. Connect ground wire (green) of power cord to external ground screw and move neutral ground wire of appliance and connect it to center screw.
4. Make sure that the strain relief screw is tightened and be sure that all terminal block nuts are on tight and power cord is in right position.

Electrical Requirement

Option 2 : 3-Wire Connection with a Power Supply Cord

If your local codes or ordinances permit the connection of a frame-grounding conductor to the neutral wire, use these instructions. If your local codes or ordinances do not allow the connection of a frame-grounding conductor to the neutral wire, use the instructions under

Section 3: Optional 3-wire connection.

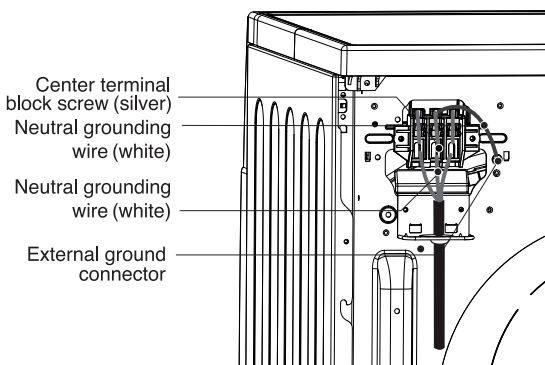
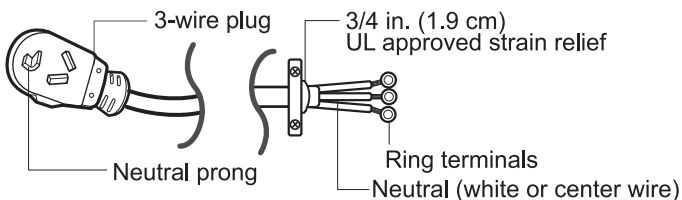
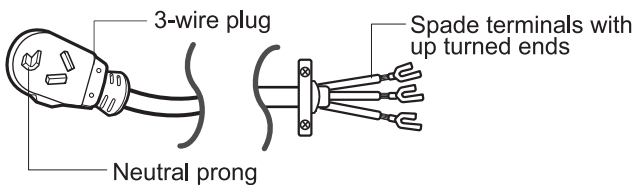
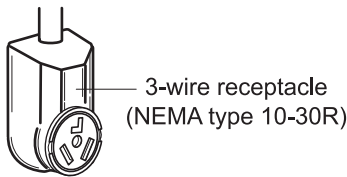

Option 3 : Optional 3-wire connection.

- If your local codes or ordinances do not allow the connection of a frame-grounding conductor to the neutral wire, use the instructions under this section.

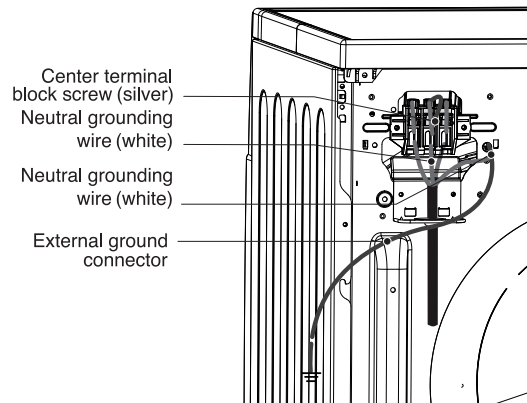
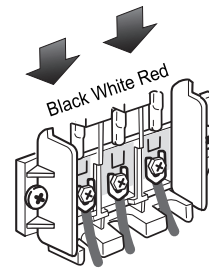

1. Connect neutral wire (white) of power cord to center terminal block screw.
2. Connect ground wire of appliance and neutral wire of power cord to center terminal block screw.
3. Connect red and black wire to the left and right terminal block screws.
4. Make sure that the strain relief screw is tightened. and be sure that all terminal block nuts are on tight and power cord is in right position.

Appearance And Design

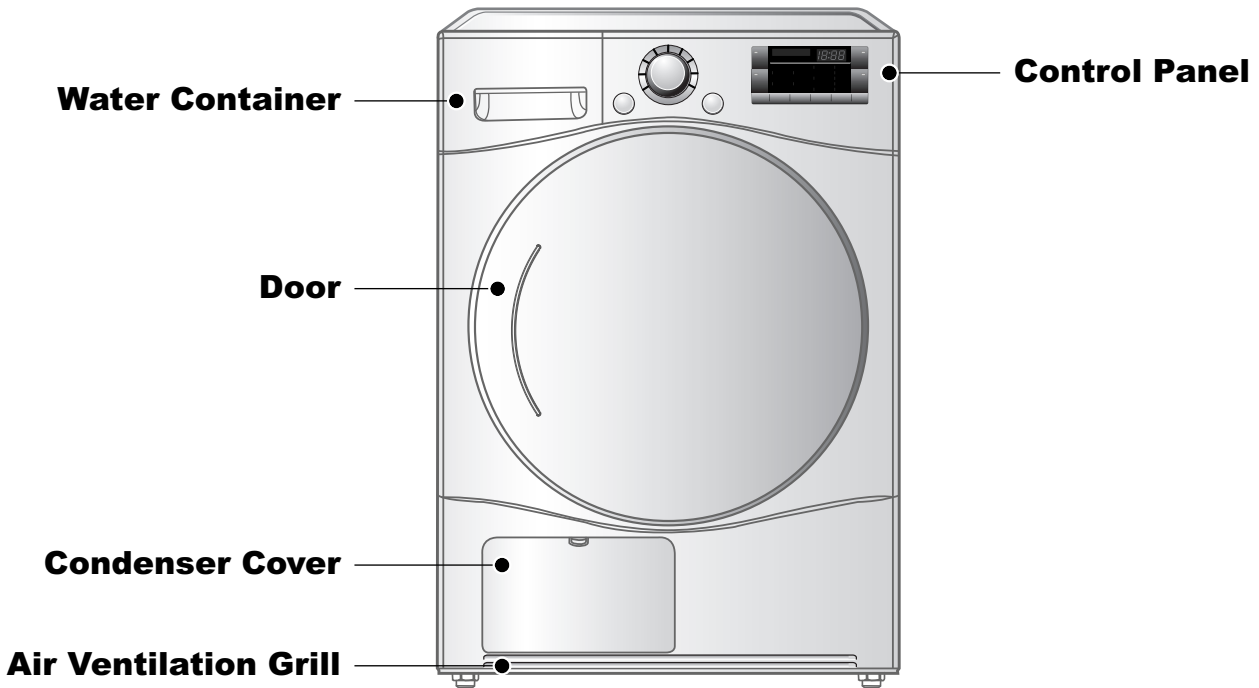

Control Panel



Power

Start/Pause

Additional Function Buttons

- More Time
- Less Time
- Option
- Signal
- Time Delay
- Custom PGM
- Wrinkle Care
- Drum Light

Operating Your Dryer

Cycle Selection Table

| SENSOR DRY CYCLES | | | Drying Level | Temp. |
|-------------------|---|--|--------------|-------------|
| Cotton | Quilts, small comforters and blankets | For thick and quilted fabrics | Very | High |
| | Terry towels, tea towels, towels, bed linen | For thick and quilted fabrics which do not need to be ironed | More | |
| | Bath towels, tea towels, underwear, cotton socks | For fabrics which do not need to be ironed | Normal | |
| | Sheets, pillowcase, towels | For fabrics which do not need to be ironed | Less | |
| | Bed linen, table linen, towels, T-shirts, polo shirts, and work clothes | For fabrics which do need to be ironed | Damp | |
| Mixed Fabrics | Bed linen, table linen, tracksuits, parka, blankets | For thick and quilted fabrics which do not need to be ironed | More | Medium High |
| | Shirts, blouses | For fabrics which do not need to be ironed | Normal | |
| | Trousers, dresses, skirts, blouses | For fabrics which do need to be ironed | Damp | |
| Easy Care | Shirts, T-shirts, trousers, under-wear and socks | For polyamide, acrylic, and polyester that do not need to be ironed | Normal | |
| | Shirts, T-shirts, under-wear, anoraks and socks | For polyamide, acrylic, polyester that do need to be ironed | Damp | |
| Bulky Items | Bed clothes, sheets | For bulky items | - | High |
| Jeans | Jeans and colour fading garments. | For jeans which do not need to be ironed | - | Medium High |
| Soft Care | T-shirts, pillowcase, and towels | For cotton fabrics which do not need to be ironed | - | Medium High |
| Quick Dry | A kind of linen and towel except for the special fabrics | For the small loads of qualified fabrics with short drying times | - | High |
| Sports Wear | Athletic uniform, training wear | For polyester material | - | Low |
| Delicates | Silk, Women's thin clothes, lingerie | For fabrics which are heat-sensitive like synthetic fabrics | - | Medium |
| Wool | Wool | For wool fabrics | - | Ultra Low |
| MANUAL DRY CYCLES | | | | |
| Gentle Air | Silk, wool, delicate lingerie | Refreshes clothes without tumble drying (It can use the dryer rack.) | - | Ultra Low |
| Cool Air | All fabrics that need to be fluffed without heat | | - | - |
| Warm Air | Bath towels, bath robes, dishclothes, quilted fabrics made of acrylic | Small clothes and pre-dried laundry normal fabrics using hot temperature | - | Adjustable |

CAUTION

If the load is less than 2.2lbs (1kg), please use Warm Air cycle in MANUAL DRY cycles. Use the Wool cycle for wool items and the Delicates cycle for heat-sensitive fabrics including silk, underwear and lingerie. Be sure to follow the recommended load sizes when washing fabrics that need special care (see page 25) or clothes will not dry properly.

Operating Your Dryer

BEFORE YOU USE YOUR DRYER

1. When unpacking your dryer, make sure there is no visible damage to the machine.
2. Follow the installation instructions and use a level to ensure proper installation.
3. Check the water reservoir, condenser, door, gasket and drum for signs of damage.
4. Run the dryer for a few minutes to make sure it is heating properly.

1. Turn power on.

First, press the **Power** button. The indicator light above the button will become illuminated, indicating that the machine is ready set to run.

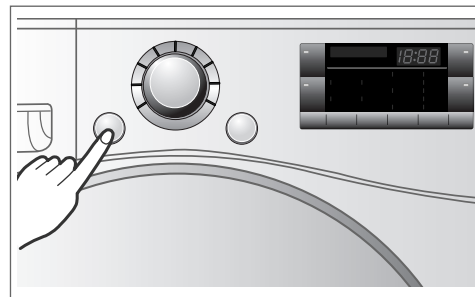

Turn the dryer on.

2. Open the door.

3. Check the lint filter, water container, and condenser.

The lint filter near the door, should be emptied before drying operation.

Open and check if lint filter is cleaned.

If not, clean it referring to page 22.

For better drying results, make sure the water container and condenser are also empty and clean.

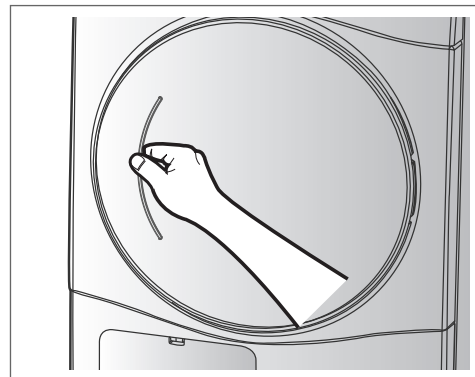

Open the door.

4. Place laundry into the drum after sorting.

The clothes should be sorted by fabric type and dryness level and all the strings and belts of clothes should be secured before being put into the drum.

Push the laundry all the way back to keep it away from the door seal.

If not, the door seal and clothes may be damaged.

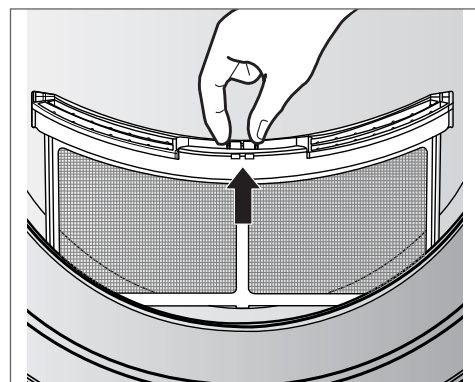

Check the lint filter.

Operating Your Dryer

5. Close the Door.

Before you close the door, make sure fabrics are properly loaded and not caught in the door opening.

6. Select the Drying Cycle you want.

You can choose a cycle by turning the Cycle Selector Knob until the required program reaches to its indicator. If you press **Start/Pause** button without choosing any cycle, the dryer will proceed with the Cotton program. [Please refer to following Cycle Selection Table (page 15) for the detailed information]

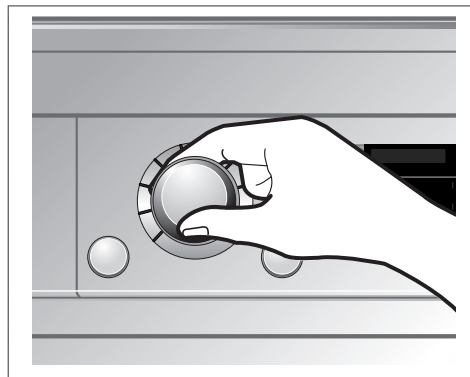

Select the desired cycle.

7. Press the Start/Pause button.

You can hear the drum turning.

8. After operation is completed, open the door and remove the laundry.

Be careful! Drum inside could be still hot. (Operation time varies depending on your cycle selection or options.)

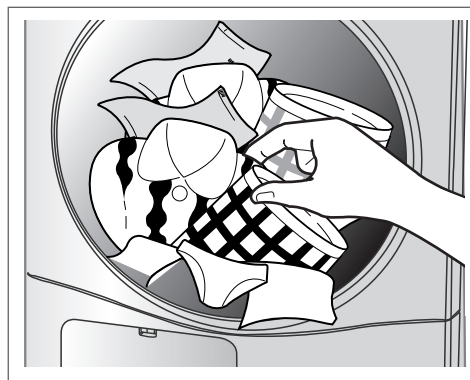

Take out the laundry.

9. Clean the lint filters and empty water container.

The lint filter should be cleaned after each load.

10. Turn off the Dryer.

Press the **Power** button.

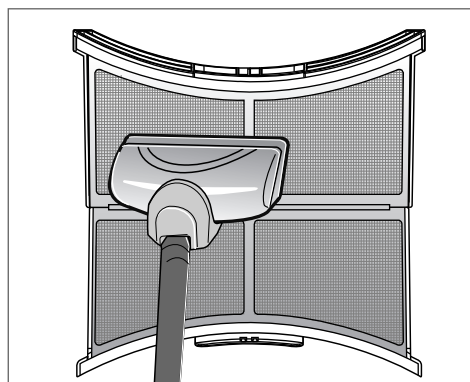

Clean the door lint filter.

⚠ CAUTION

- Be careful the filter is not torn or damaged when using a vacuum cleaner. If there is a little residue buildup on filter, you can scrub lint screen with a brush to remove.
- If you want to open the door while dryer is operating, please press the **Start/Pause** button first, wait until drum completely stops and then open the door.

Additional Functions

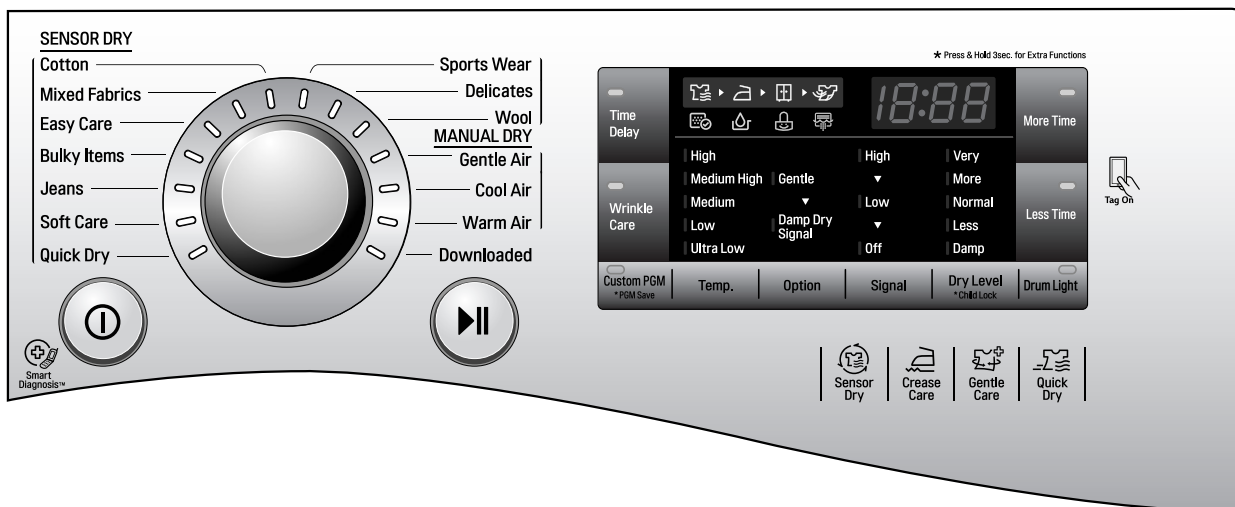

Time Delay

The Time Delay feature allows you to have the dryer run at a time that is more convenient, for example when electricity rates are cheaper. The cycle can be delayed from 3 hours up to a maximum of 19 hours.

1. Load the dryer and close the door.
2. Press the **Power** button.
3. Select the desired cycle and options.
4. Press the **Time Delay** button until the desired delay time is displayed.
5. Press the **Start/Pause** button.

Wrinkle Care (10:00)

Selecting this option will tumble the load periodically for a few seconds without heat. This will continue for up to 2 hours after the selected cycle, or until the door is opened. This prevents wrinkling of unremoved dry items until they can be removed.

Note

If the door is opened during the drying portion of a cycle before Wrinkle Care has started, the cycle will not be cancelled and Wrinkle Care will begin as soon as the normal drying portion of the cycle is completed.

Custom PGM

If you have a special combination of settings that you use frequently, you can save these settings as a Custom PGM.

* To Save a Custom PGM

1. Turn on the dryer.
2. Select a cycle.
3. Use the cycle modifier buttons to adjust the settings for that cycle.
4. Set any other desired cycle options.
5. Press and hold the **Custom PGM** button for 3 seconds. You will hear two beeps to confirm the settings have been stored.

To Recall a Custom PGM

1. Press and release the **Custom PGM** button. The stored settings will be displayed.
2. Press and release the Cycle Selector Knob to start the cycle. The dryer will start automatically.

Note

You can only save one Custom PGM program at a time. If you press and hold the Custom PGM button for 3 seconds, you will overwrite any previously stored Custom PGM settings.

Once Custom PGM has been recalled, any of the memorized modifiers or options can be adjusted. However, if the Cycle Selector Knob is rotated, Custom PGM will be cancelled.

Additional Functions

More Time / Less Time

The **More Time** and **Less Time** buttons can be used to increase or decrease the dry time when MANUAL DRY cycles are selected. These buttons are disabled once the cycle is started.

Note

These buttons are available only with **MANUAL DRY**, before you push **Start/Pause** button.

Drum Light

Press the **Drum Light** button to turn on the drum light during dryer operation. This will allow you to more easily observe the load. The drum light will come on any time the door is opened.

Temp.

Adjusts the temperature setting from Ultra Low to High. This allows precise care of your fabrics and garments.

- Press the **Temp.** button repeatedly to scroll through available settings.

Options

Gentle

- This function keeps the garments more moist than the standard Iron dry level.
- Cotton, Mixed Fabrics and Easy Care cycles.

Damp Dry Signal

- This option causes the control to beep once the clothes have reached a "Damp Dry Signal" level. This can be used to alert you to remove articles that you don't want to over dry or that you want to have damp for easier ironing.
- Cotton, Mixed Fabrics and Easy Care cycles.

Signal

Press the **Signal** button to adjust the volume of the signals from high to off.

Child Lock()

Use this option to prevent cycle settings from being changed while the dryer is operating. Press and hold the **Dry Level** button for 3 seconds to activate or deactivate the Child Lock function.

The lock icon will be shown in the display, and all controls are disabled.

Additional Functions

- The Tag On function allows you to conveniently use the LG SmartDiagnosis™ and Cycle Download features to communicate with your appliance right from your own smart phone.
- To use the Tag On function:
 1. Download the LG Smart Laundry & DW App to your smart phone.
 2. Turn on the NFC (Near Field Communication) function in your smart phone.
- The Tag On function can only be used with most smart phones equipped with the NFC function and based on the Android operating system (OS).

Turning on the NFC function of the smart phone



1. Enter the "Settings" menu of the smart phone and select "Share & Connect" under "WIRELESS & NETWORKS".

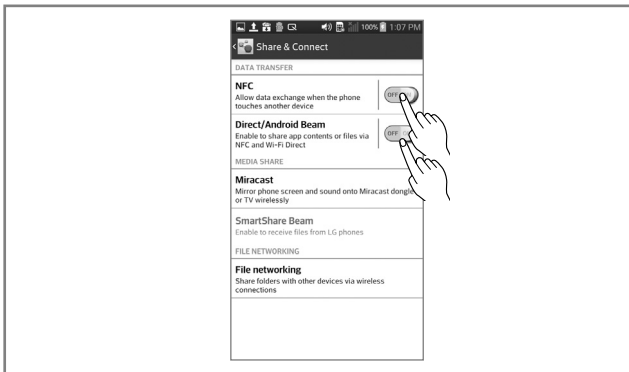

2. Set "NFC" and "Direct Android Beam" to ON and select "NFC".

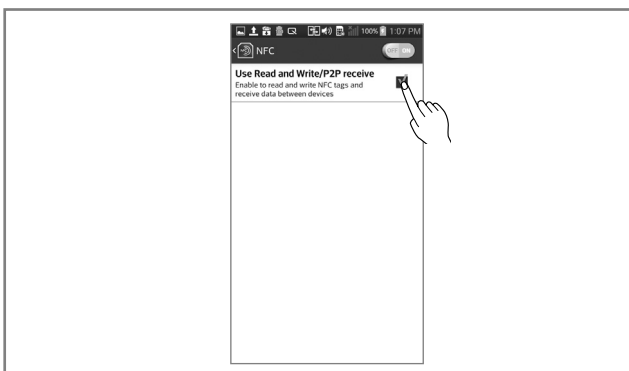

3. Check "Use Read and Write/P2P receive".

Note

- Depending on the smart phone manufacturer and Android OS version, the NFC activation process may differ.
- Refer to the manual of your smart phone for details.

Additional Functions

The Tag On guide

Tag On position

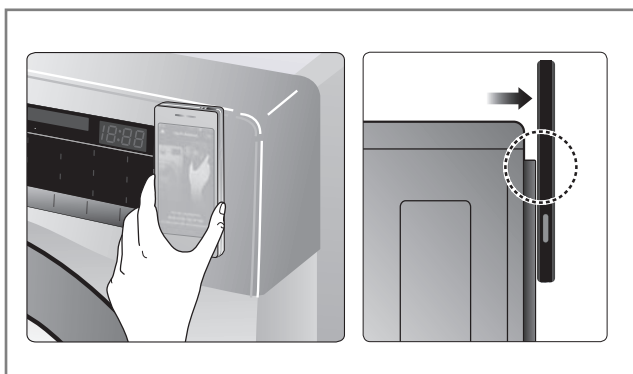
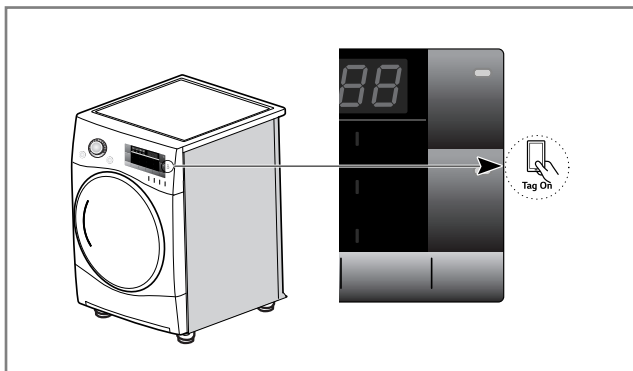

-  **Tag On:**
Look for the Tag On icon next to the LED screen on the control panel.
This is where you position your smart phone when using the Tag On function with the LG SmartDiagnosis™ and Cycle Download features of the LG Smart Laundry & DW App.
- When you use the Tag On function, position your smart phone so that the NFC antenna on the back of your smart phone matches the position of the Tag On icon on the appliance.
If you do not know the position of your NFC antenna, move your smart phone very slightly in a circular motion until the application verifies the connection.

• Because of the characteristics of NFC, if the transmission distance is too far, or if there is a metal sticker or a thick case on the phone, transmission will not be good. In some cases, NFC-equipped phones may be unable to transmit successfully.

• Press  in the LG Smart Laundry & DW app for a more detailed guide on how to use the Tag On function.

Caring For Your Dryer

Clean lint filter

To maintain proper air flow and keep your dryer operating at peak efficiency, it is important to empty the lint filter between every load. If the Clean Filter () light comes on during a cycle and the beeper sounds, pause the dryer and empty the filter immediately.

1. Open the door.
2. Pull the filter out.

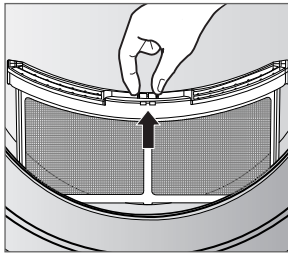

3. Open the filter and use your fingers to roll the lint off the screen surfaces. If the lint is difficult to remove or the filter material is showing signs of clogging, follow the cleaning instructions below.

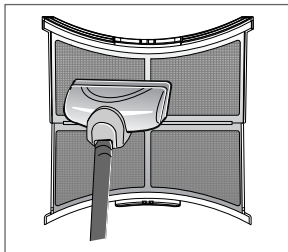

4. Snap the filter closed and replace it in the dryer.
 - Push the filter all the way down to avoid interference with the door

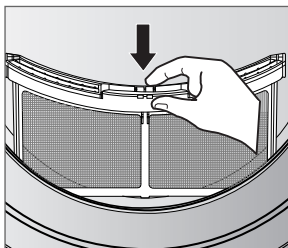

5. Close the door.

Wash the lint screen in warm, soapy, water. Dry thoroughly and replace.

Clean lint filter during a cycle

If the Clean Filter () light flashes and the alarm sounds during operation, clean the filter promptly.

1. Press the **Power** button to stop the dryer. Then press it again to turn the dryer on.
2. Turn the Cycle Selector Knob to select the Cool Air cycle.
3. Press the **Start/Pause** button to start the dryer.
4. Let the Cool Air cycle run for 5 minutes to cool the dryer, then open the door and clean the lint filter.

Note

If the dryer is stopped in the middle of a cycle, the lint filter may be very hot. Failure to follow these cool down instructions could result in injury.

Empty water container

If your dryer is not connected to a household drain, then the water reservoir will capture the water from the drying process. This should be emptied every load. Failure to do so may result in poor drying performance.

If the container becomes full during a cycle, the Empty Water () light and alarm will be activated. In this case, the water reservoir should be emptied immediately, but in no case should it continue to be used for more than 1 hour.

1. Using the handle on the front of the drawer, pull out the reservoir.

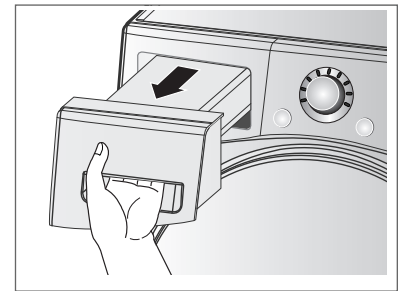

2. Using the handle on the front of the drawer, pull out the reservoir.

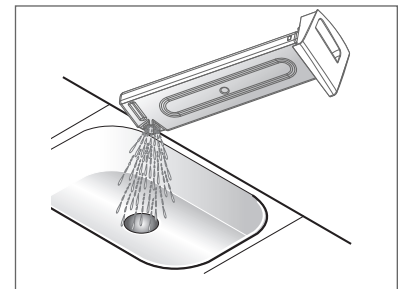

3. Drain the water into a sink.

4. Press the **Start/Pause** button to resume the cycle.

Caring For Your Dryer

Condenser

The condenser is a very important part of your dryer. This is where the moisture is removed from the air so there is no need for an outside exhaust. If the condenser is not properly maintained, it will greatly increase energy consumption and drying time. The condenser should be cleaned 3 or 4 times a year, or any time the Clean Condenser () light blinks.

1. Push the tab and open the condenser cover.

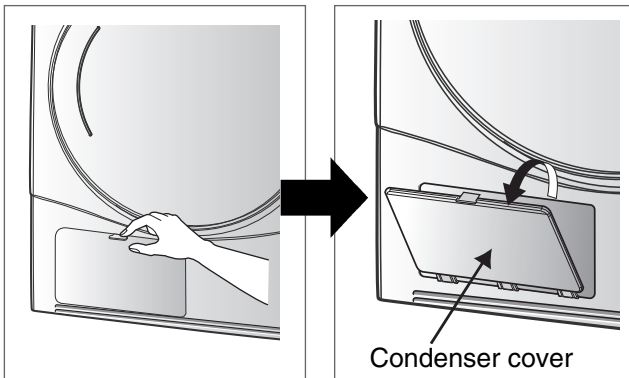

2. Unlock the inner plate by rotating the locking levers on either side of the plate. Then slide the plate out of the opening.

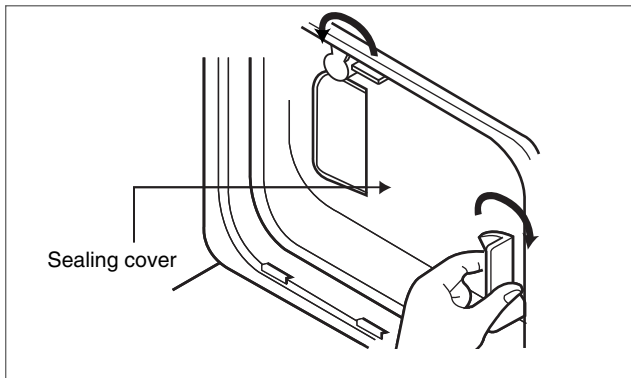

3. Carefully slide the condenser straight out of the housing using the finger ring at the center. Use care when handling the condenser to prevent damage that could reduce its efficiency.

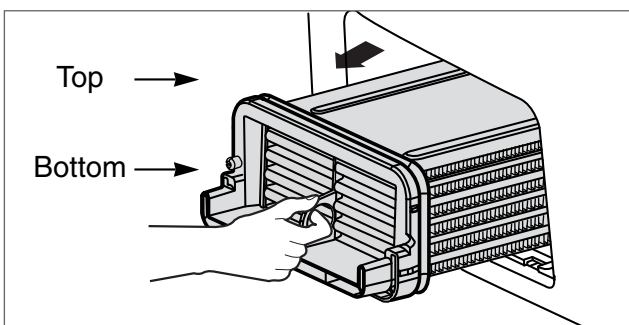

4. Thoroughly clean the condenser by running tap water through it from both the ends and the sides.

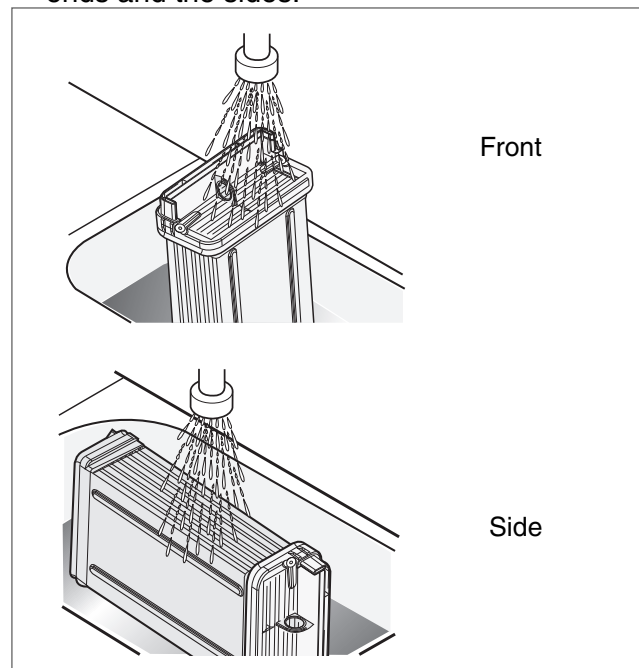

5. Slide the clean condenser into the housing. Make sure it is oriented as shown in the drawing in step 3.
6. Insert the inner plate into the opening in front of the condenser, then rotate the locking tabs to lock it in place. Then close the front cover.

CAUTION

- NEVER operate the dryer without the condenser in place.
- Do not operate the dryer with a dirty or clogged condenser. Doing so will increase energy consumption and drying times.
- Handle the condenser with care. Do not use sharp or hard objects to clean the condenser as this could damage the condenser.
- Do not operate the dryer with a damaged condenser. Doing so could result in leaking which may result in property damage.

Caring For Your Dryer

Ventilation Grille and Cool Air Inlet Grille

Use a vacuum cleaner to clean the front ventilation grill and the cool air inlet in the back. Failure to remove any lint or dirt buildup will reduce air flow and increase energy consumption and drying times.

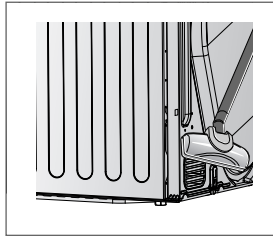
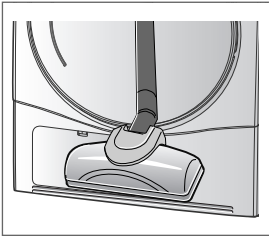

Note

The warm air is exhausted through the ventilation grill.

Condensed Water Drain

Condensed water is pumped to the reservoir which must be emptied every load. If a household drain is available, this water can be pumped down the drain so the reservoir is not used.

1. Slide the drain connection out the opening located on the back of the dryer on the right side as you face the rear of the dryer.

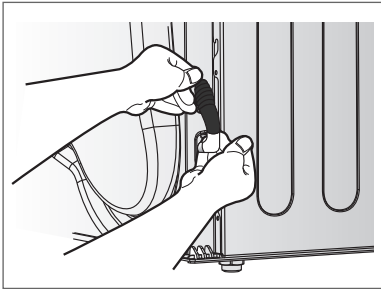

2. Disconnect the hose that goes up to the reservoir.

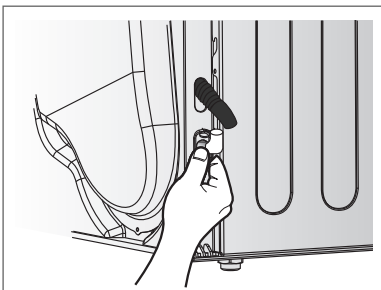

3. Connect the external drain hose included with the dryer. Route this hose to a permanent drain and secure the hose so it can not come loose.

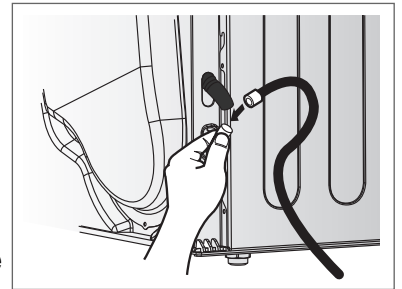

Moisture Sensor

This sensor is used by the control to sense the moisture remaining in the clothes. If the sensor becomes dirty or coated the control will not be able to sense the moisture and the dryer will shut off before the clothes are dry. Clean the sensor bars as shown below to maintain optimum performance of the SENSOR DRY cycles.

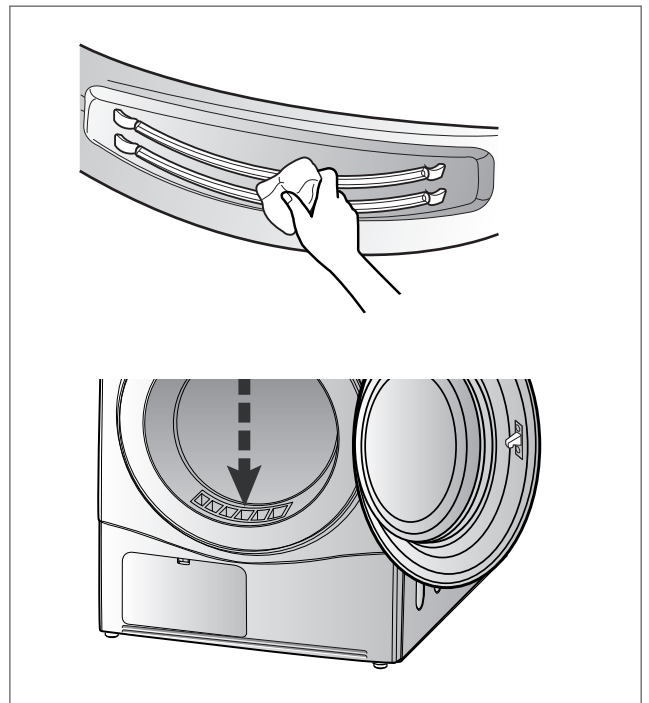

Additional Tips For Smart Use

Drying Guide

Woolen Article

Dry woolens in wool cycle. Be sure to follow fabric care label symbols. Wool is not completely dried from the program so don't repeat drying. Pull woolens to their original shape and dry them flat.

Woven and loopknit materials

Some woven and loopknit materials may shrink, depending on quality.

Permanent Press and Synthetics

Do not overload your dryer.

Take out permanent press items as soon as the dryer stops to reduce wrinkles.

Baby clothes and night gowns

Always check the manufacturer's instructions.

Rubber and Plastics

Do not dry any items made from or containing rubber or plastics such as:

- a) Aprons, bibs and chair covers
- b) Curtains and table clothes
- c) Bathmats

Fiber glass

Do not dry fiberglass articles in your dryer.















Glass particles left in the dryer could be picked up by your clothes the next time you use the dryer and irritate your skin.

Fabric Care Labels

Sort and dry laundry according to care labels, size, and fabric type.

Do not overload the dryer. This will save energy and time and give the best drying performance.

Below are fabric care labels.

| Symbols | Instructions |
|---|--|
|  | Dry |
|  | Tumble dry |
|  | Permanent Press / Wrinkle resistant |
|  | Gentle / Delicates |
|  | Do not tumble dry |
|  | Do not dry |
|  | High heating |
|  | Medium heating |
|  | Low heating |
|  | No heat / air |
|  | Line Dry / hang to dry |
|  | Drip dry |
|  | Dry flat |
|  | In the shade |

Additional Tips For Smart Use

Spare Parts

Spare parts are covered under the terms of warranty. Components covered by warranty are provided free of charge. If coverage is expired, spare parts must be purchased from an authorized service center.

Disposal of the dryer

To prevent possible injury to children, if you dispose of this dryer you must do so safely. Remove and dispose of the door, lid, and other protruding parts which could cause harm. Cut off the power cord to prevent future use. Follow local ordinances to dispose of the dryer safely.

Service contact

If there is something wrong with your dryer, refer to the troubleshooting table.

If the trouble persists or you still have questions, please contact an authorized service center or call 1-800-243-0000.

You will need to provide the service center with the following information:

1. Your name, address, and ZIP code.
2. Your phone number.
3. Description of the problem.
4. The model number and serial number of your dryer.
5. The date of purchase.

Accessory parts

Your dryer comes with accessories such as

1. Condensing drain hose

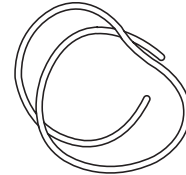

2. Hose holder

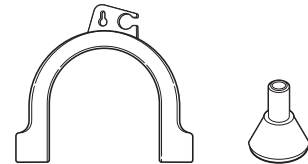

3. Stacking kit (2EA)

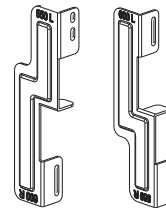

Dryer Rack

Dryer Rack (Purchased Separately)

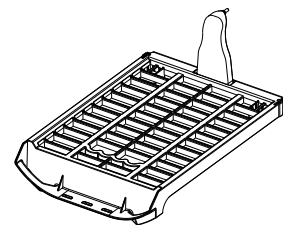

Troubleshooting Guide

Troubleshooting Tips

Save time and money! Review the charts on the following pages first and you may not need to call for service.

1. Problem: My dryer won't start

| Question | What to Do |
|---|---|
| <ul style="list-style-type: none">• Is the dryer plugged in? | Confirm that the dryer's plug is securely and completely pushed into the power outlet |
| <ul style="list-style-type: none">• Is the fuse blown, or is the circuit breaker tripped? | Check your home's or laundry room's fuse box/circuit breaker box and replace the fuse or reset the circuit breaker. |

2. Problem: My dryer doesn't heat

| Question | What to Do |
|---|---|
| <ul style="list-style-type: none">• Is the fuse blown, or is the circuit breaker tripped? | If the fuse is blown or the circuit breaker tripped, the dryer might tumble but not heat. Check your home's or laundry room's fuse box/circuit breaker box and replace the fuse or reset the circuit breaker. |

3. Problem: There are greasy spots on my clothes

| Question | What to Do |
|--|---|
| <ul style="list-style-type: none">• Did you follow the instructions on your fabric softener product? | Check and follow the instructions provided with your fabric softener product. |
| <ul style="list-style-type: none">• Are you drying clean and dirty clothes together? | Make sure to use your dryer to dry only clean items, because dirty items can soil clean clothes placed in the same load or later placed in the dryer drum. |
| <ul style="list-style-type: none">• Were your clothes entirely clean? | Stains on dried clothes are actually stains that weren't removed during the washing process. Make sure you are following your washing instructions and that the clothes are being completely cleaned. |

Troubleshooting Guide

4. Problem: There is lint on my clothes

| Question | What to Do |
|---|---|
| <ul style="list-style-type: none">• Is your lint filter full? | Please refer to the manual section on cleaning the lint filter, and please confirm that the lint filter is clean. It is important that the lint filter is clean before each new load of laundry. |
| <ul style="list-style-type: none">• Did you properly sort your load of laundry? | In order to reduce the amount of lint in a load of laundry, sort lint producers (like a fuzzy white cotton towel) separately from clothes that might catch lint (such as a pair of black linen pants). |
| <ul style="list-style-type: none">• Do your clothes have excess static electricity? | See comments below under item 5, There is static in my clothes after drying. |
| <ul style="list-style-type: none">• Did you overload your dryer? | Divide your larger load into smaller loads. |
| <ul style="list-style-type: none">• Did you place any paper, tissue, or other similar material in the load? | Sometimes a person might forget to take a piece of paper or a tissue out of the pocket of a pair of pants, and this paper, tissue, or similar material can cause excess lint in a load of laundry. Confirm that the pockets of pants, shirts, and other articles of clothing are empty before washing and drying. |

5. Problem: There is static in my clothes after drying

| Question | What to Do |
|---|---|
| <ul style="list-style-type: none">• Did you use fabric softener? | Try using a fabric softener to reduce static electricity. |
| <ul style="list-style-type: none">• Did you over dry the load of laundry? | Overdrying a load of laundry can cause a build up of static electricity. Try using a fabric softener or adjust your settings and use a shorter drying time. |
| <ul style="list-style-type: none">• Are you drying synthetic, permanent press and blends? | These materials can cause static to build up in a load of dried clothes. Try using a fabric softener. |

6. Problem: The drying time is not consistent

| Question | What to Do |
|---|---|
| <ul style="list-style-type: none">• Are you using consistent heat settings and consistent load sizes? | The drying time for a load will vary depending on several factors including, but not limited to, the size of the load, the type of fabrics, the wetness of the clothes, the condition of the lint filter and the rating of the power source (i.e. 208V will take longer than 240V). |

Troubleshooting Guide

7. Problem: It takes too long for my clothes to dry

| Question | What to Do |
|---|---|
| <ul style="list-style-type: none">• Did you properly sort your loads of laundry? | Separate heavy weight items from light weight items when creating loads. |
| <ul style="list-style-type: none">• Are you drying large loads of heavy fabrics? | Heavy fabrics take longer to dry because they tend to retain more moisture. To help reduce and maintain more consistent drying times for large and heavy fabrics, separate these items into smaller loads of a consistent size. |
| <ul style="list-style-type: none">• Are the dryer controls properly set? | Use the appropriate control settings for the type of load you are drying. |
| <ul style="list-style-type: none">• Is the lint filter clean before each new load of laundry? | Please confirm that the lint filter is clean prior to each new load of laundry. |
| <ul style="list-style-type: none">• Is the fuse blown, or is the circuit breaker tripped? | Check your home's or laundry room's fuse box/circuit breaker box and replace the fuse or reset the circuit breaker. |
| <ul style="list-style-type: none">• Did you overload your dryer? | Divide your larger load into a number of smaller loads. |
| <ul style="list-style-type: none">• Did you under load your dryer? | If you are only drying a handful of items, add a few extra pieces to help ensure proper tumbling action. |

8. Problem: My clothes are wrinkled

| Question | What to Do |
|---|---|
| <ul style="list-style-type: none">• Are you overdrying your laundry? | Overdrying a load of laundry can lead to wrinkled clothes. Try a shorter drying time, and remove items while they still retain a slight amount of moisture. |
| <ul style="list-style-type: none">• Are you removing your laundry from the dryer soon after the drying cycle is complete? | Remove your laundry from the dryer after the drying cycle ends and either hang or fold the items. |

9. Problem: My clothes are shrinking

| Question | What to Do |
|---|---|
| <ul style="list-style-type: none">• Are you following the care instructions for your garment? | To avoid shrinkage, carefully follow the care and use instructions for your garment, because some fabrics will naturally shrink when washed. Other fabrics can be washed but will shrink when dried in a dryer. |

Troubleshooting Guide

● Error Mode

- *dE* LED displays *dE* if the door is open. Make sure the door is closed and press the Start/Pause button to operate the dryer.
- *EE,EE3,LE* If display errors continue to occur, unplug the power cord and then call the Service Center.

● Drum light does not work

- Contact customer service

Troubleshooting Guide

Should you experience any problems with your dryer, it has the capability of transmitting data to your smart phone using the LG Smart Laundry Application or via your telephone to the LG call center.

Smart Diagnosis™ cannot be activated unless your dryer is turned on by pressing the **Power** button. If your dryer is unable to turn on, then troubleshooting must be done without using Smart Diagnosis™

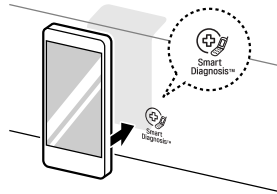

● Using Smart Diagnosis™

Smart Diagnosis™ Using Your Smart Phone

1. Download the LG Smart Laundry & DW application on your smart phone.
2. Open the LG Smart Laundry application on your smart phone. Press the right arrow button to advance to the next screen.
3. Press the Record button on the smart phone and then hold the mouth piece of the smart phone near the Smart Diagnosis™ logo on the dryer.
4. With the phone held in place, press and hold the **More Time** button for 3 seconds.
5. Keep the phone in place until the tone transmission has finished. The display will count down the time.
6. When the recording is complete, view the diagnosis by pressing the Next button on the phone.

Note

- Call quality differences by region may affect the function.
- Use a home telephone for better communication performance, resulting in better service.
- Poor call quality may result in poor data transmission from your phone to the machine, which could cause Smart Diagnosis™ to malfunction.

Smart Diagnosis™ Through the Call Center

1. Call the LG call center at: (LG U.S.) 1-800-243-0000
(LG Canada) 1-888-542-2623.
2. When instructed to do so by the call center agent, hold the mouthpiece of your phone over the Smart Diagnosis™ logo on the machine. Hold the phone no more than one inch from (but not touching) the machine.

Note

Do not touch any other buttons or icons on the display screen.

3. Press and hold the **More Time** button for 3 seconds.
4. Keep the phone in place until the tone transmission has finished. The display will count down the time.
5. Once the countdown is over and the tones have stopped, resume your conversation with the call center agent, who will then be able to assist you in using the information transmitted for analysis.

Note

- For best results, do not move the phone while the tones are being transmitted.
- If the call center agent is not able to get an accurate recording of the data, you may be asked to try again.

Technical Data

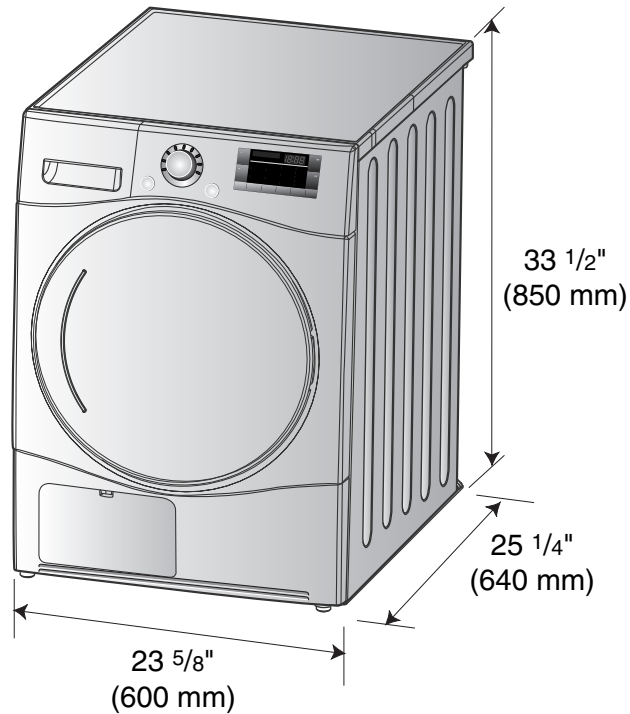

- Type : Electric Dryer
 - Rating : Please refer to the rating label regarding detailed information.
 - Size : 23 5/8 x 25 1/4 x 33 1/2 (inch)
 - Capacity : IEC 4.2 cu.ft
 - Weight : 107lb (48.6 kg)
- * The appearance and specifications are subject to change without manufacturer's notice.

Ventilation Requirement

| Alcove or undercounter | Closet |
|---|---|
| Ensure air flow of 112 cu.ft./min through dryer | Closet door must have 2(louvered) openings, each having a minimum area of 60 sq. inches (387 sq.cm), located 3 inches (8 cm) from bottom and top of door. |

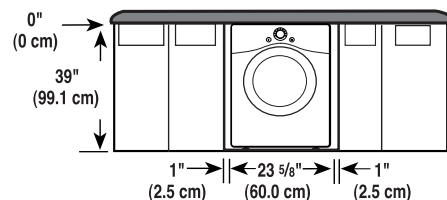
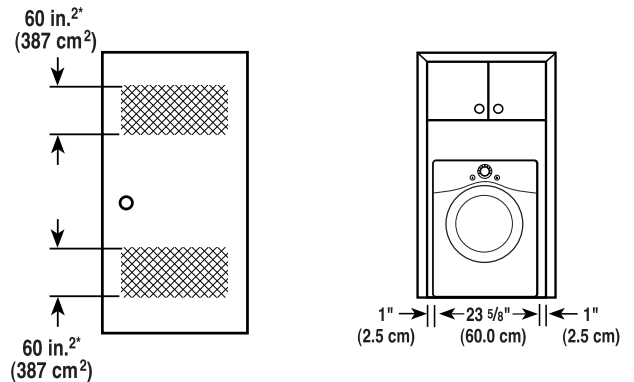

WARRANTY (USA)

Should your LG Dryer (“Product”) fail due to a defect in materials or workmanship under normal home use, during the warranty period set forth below, LG will at its option repair or replace the product. This limited warranty is valid only to the original retail purchaser of the product and applies only when purchased and used within the United States including U.S. Territories. Proof of original retail purchase is required to obtain warranty service under this limited warranty.

| Warranty Period | Scope of Warranty | HOW SERVICE IS HANDLED |
|--|-------------------|---|
| One (1) year from date of original retail purchase | Parts and Labor | LG will provide parts and labor to repair or replace defective parts. |

- Replacement products and parts are warranted for the remaining portion of the original warranty period or ninety (90) days, whichever is greater.
- Replacement products and parts may be new or remanufactured.

THIS WARRANTY IS IN LIEU OF ANY OTHER WARRANTY, EXPRESS OR IMPLIED, INCLUDING WITHOUT LIMITATION, ANY WARRANTY OF MERCHANTABILITY OR FITNESS FOR A PARTICULAR PURPOSE. TO THE EXTENT ANY IMPLIED WARRANTY IS REQUIRED BY LAW, IT IS LIMITED IN DURATION TO THE EXPRESS WARRANTY PERIOD ABOVE. NEITHER THE MANUFACTURER NOR ITS U.S. DISTRIBUTOR SHALL BE LIABLE FOR ANY INCIDENTAL, CONSEQUENTIAL, INDIRECT, SPECIAL, OR PUNITIVE DAMAGES OF ANY NATURE, INCLUDING WITHOUT LIMITATION, LOST REVENUES OR PROFITS, OR ANY OTHER DAMAGE WHETHER BASED IN CONTRACT, TORT, OR OTHERWISE.

Some states do not allow the exclusion or limitation of incidental or consequential damages or limitations on how long an implied warranty lasts, so the above exclusion or limitation may not apply to you. This warranty gives you specific legal rights and you may also have other rights that vary from state to state.

THIS LIMITED WARRANTY DOES NOT COVER:

- Service trips to deliver, pick up, or install or repair the product; instruction to the customer on operation of the product; repair or replacement of fuses or correction of wiring or plumbing, or correction of unauthorized repairs/installation.
- Failure of the product to perform during power failures and interruptions or inadequate electrical service.
- Damage caused by leaky or broken water pipes, frozen water pipes, restricted drain lines, inadequate or interrupted water supply or inadequate supply of air.
- Damage resulting from operating the Product in a corrosive atmosphere or contrary to the instructions outlined in the Product’s owner’s manual.
- Damage to the Product caused by accidents, pests and vermin, lightning, wind, fire, floods, or acts of God.
- Damage or failure caused by unauthorized modification or alteration, or if it is used for other than the intended purpose, or any water leakage where the unit was not properly installed.
- Damage or failure caused by incorrect electrical current, voltage, or plumbing codes, commercial or industrial use, or use of accessories, components, or consumable cleaning products that are not approved by LG.

Warranty

- Damage caused by transportation and handling, including scratches, dents, chips, and/or other damage to the finish of your product, unless such damage results from defects in materials or workmanship and is reported within one (1) week of delivery.
- Damage or missing items to any display, open box, discounted, or refurbished Product.
- Products with original serial numbers that have been removed, altered, or cannot be readily determined. Model and Serial numbers, along with original retail sales receipt, are required for warranty validation.
- Increases in utility costs and additional utility expenses.
- Repairs when your Product is used in other than normal and usual household use (e.g. commercial use, in offices and recreational facilities) or contrary to the instructions outlined in the Product's owner's manual.
- Costs associated with removal of your Product from your home for repairs.
- The removal and reinstallation of the Product if it is installed in an inaccessible location or is not installed in accordance with published installation instructions, including LG's owner's and installation manuals.
- Damage resulting from misuse, abuse, improper installation, repair, or maintenance. Improper repair includes use of parts not approved or specified by LG.
- The warranty also does not cover the following:

Filter is clogged.

- Not heating, long dry time

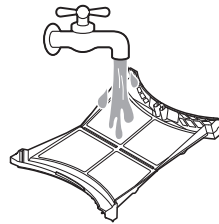
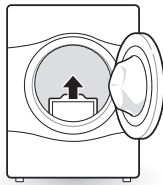

- Clean the lint filter.

Improperly connected power cord or electrical outlet issue.

- No Power
- Not Heating

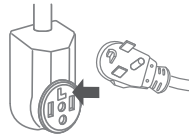
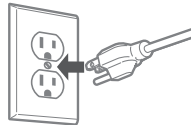

- Reconnect power cord, replace house fuse or reset breaker. If outlet is issue, electrician may be required.

The cost of repair or replacement under these excluded circumstances shall be borne by the consumer.

TO OBTAIN WARRANTY SERVICE AND ADDITIONAL INFORMATION

For additional product information, visit the LG website at <http://www.lg.com>

For assistance using this product or to schedule service, contact LG Electronics at 1-800-243-0000.

For further assistance, write: LG Electronics, 201 James Record Road, Huntsville, Alabama 35813