

FRIGIDAIRE

All about the

Use & Care

of your Electric Range with
Induction Cooktop

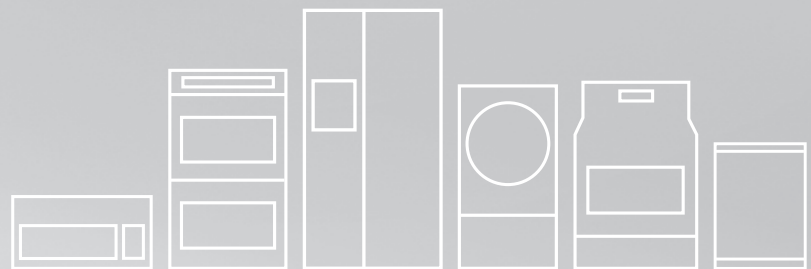

TABLE OF CONTENTS

Product Record and Registration	2	Oven Controls	19
Important Safety Instructions	3	Care and Cleaning	37
Before Setting Surface Controls	8	Before You Call	41
Setting Surface Controls	12	Warranty	44
Before Setting Oven Controls	16		

PRODUCT RECORD AND REGISTRATION

Product Record and Registration	2
Important Safety Instructions	3
Before Setting Surface Controls	8
Tips For Using the Cooking Zones	9
Home Canning	11
Setting Surface Controls	12
Operating Induction Cooking Zones	13
Pan Preheat Recommendations	13
Warmer Zone	14
Before Setting Oven Controls	16
Effortless™ Oven Rack System	17
Oven Controls	19
Temperature Display (Fahrenheit/Celsius)	21
Setting Control for Silent Operation	21
Quick Preheat	22
Setting Bake	23
Convection Cooking	24
Setting Bake Time	25
Setting Delay Start	26
Keep Warm	26
Cooking with Meat Probe	29
Setting the Sabbath Feature	32
Adjusting Oven Temperature	33
Restoring Factory Default Setting	33
Steam Clean	34
Self Cleaning Operation	35
Care and Cleaning	37
Cooktop Maintenance	38
Replacing the Oven Light	39
Removing and Replacing the Oven Door	40
Before You Call	41
Solutions to Common Problems:	42
Warranty	44

Questions?

For toll-free telephone support in the U.S. and Canada call **1-800-944-9044**.

For online support and Internet product information visit <http://www.frigidaire.com>.

Thank you for choosing Frigidaire.

Important: This Use and Care Guide is part of our commitment to customer satisfaction and product quality throughout the service life of your new appliance. We view your purchase as the beginning of a relationship. To ensure our ability to continue serving you, please use this page to record important product information.

Need Help?

Visit the Frigidaire web site at www.frigidaire.com

Before you call for service, there are a few things you can do to help us serve you better.

Read this Use and Care Manual

This manual contains instructions to help you use and maintain your range properly.

If You Received a Damaged Range...

Immediately contact the dealer (or builder) that sold you the range.

Save Time and Money

Check the section title "Before You Call". This section helps step you through some common problems that might occur.

If you do need service, help is only a phone call away. Call Frigidaire Customer Services at **1-800-944-9044**.

Product Registration

Registering your product with Frigidaire enhances our ability to serve you. You can register online at <http://www.frigidaire.com> or by dropping your Product Registration Card in the mail.

Record model and serial numbers here

Purchase Date

Frigidaire model number

Frigidaire serial number

Serial Plate Location

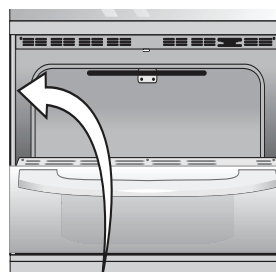

Serial plate location: open oven drawer (some models) or storage drawer (some models).

IMPORTANT SAFETY INSTRUCTIONS

Cautions and Warnings

Read all instructions before using this appliance.

This manual contains important safety symbols and instructions. Please pay attention to these symbols and follow all instructions given.

Do not attempt to install or operate your appliance until you have read the safety precautions in this manual. Safety items throughout this manual are labeled with a WARNING or CAUTION statement based on the risk type.

Definitions

 This is the safety alert symbol. It is used to alert you to potential personal injury hazards. Obey all safety messages that follow this symbol to avoid possible injury or death.

WARNING

Indicates a potentially hazardous situation which, if not avoided, may result in death or serious injury.

CAUTION

Indicates a potentially hazardous situation which, if not avoided, may result in minor or moderate injury.

IMPORTANT

Indicates installation, operation, maintenance, or valuable information that is not hazard related.

NOTE

Indicates a short informal reference written down to assist the memory or for future reference.

WARNING

Storage in or on appliance—Flammable materials should not be stored in an oven or near surface units. This includes paper, plastic, and cloth items, such as cookbooks, plastic ware, and towels, as well as flammable liquids. Do not store explosives, such as aerosol cans, on or near the appliance.

WARNING

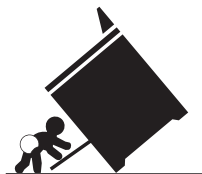

Tip Over Hazard

- A child or adult can tip the appliance and be killed.
- Verify the device is engaged with the countertops or that the device has been installed to the walls of the cabinet, the wall, or the floor as per the installation instructions
- Ensure the anti-tip device is re-engaged with the countertop, the walls of the cabinet, the wall, or the floor as per the installation instructions when the appliance is moved.
- Do not operate the appliance without the anti-tip device in place and engaged.
- Failure to follow these instructions can result in death or serious burns to children and adults.



To check if the anti-tip bracket is installed properly, use both arms to grasp the rear edge of the appliance back. Carefully attempt to tilt appliance forward. When properly installed, the appliance should not tilt forward.

Refer to the anti-tip bracket installation instructions supplied with your range for proper installation.

CAUTION

Do not store items of interest to children in the cabinets above a range on the backguard of the ranges. Children climbing on the range to reach items could be seriously injured.

Save these instructions for future reference.

IMPORTANT SAFETY INSTRUCTIONS

CAUTION

Persons with a pacemaker or similar medical device should exercise caution using or standing near an induction unit while it is in operation, as the electromagnetic field may affect the working of the pacemaker or similar medical device. It would be advisable to consult your doctor or the pacemaker or similar medical device manufacturer about your particular situation.

This appliance has been tested and found to comply with the limits for a class B digital device, pursuant to Part 18 of the FCC rules. These limits are designed to provide reasonable protection against harmful interference in a residential installation. This unit generates, uses and can radiate radio frequency energy and, if not installed and used in accordance with the instructions, may cause harmful interference to radio communications. However there is no guarantee that interference will not occur in a particular installation. If this unit does cause harmful interference to radio or television reception, which can be determined by turning the unit off and on, the user is encouraged to try to correct the interference by one or more of the following measures:

- Reorient or relocate the receiving antenna.
- Increase the distance between unit and receiver.
- Connect the unit into an outlet or circuit different from that to which the receiver is connected.

IMPORTANT

Important Safety Notice - The California Safe Drinking Water and Toxic Enforcement Act requires the governor of California to publish a list of substances known to cause cancer, birth defects, or other reproductive harms, and requires businesses to warn customers of potential exposures to such substances.

Unpacking, Installing, and Servicing Your Appliance

IMPORTANT

Read and follow the below instructions and precautions for unpacking, installing, and servicing your appliance:

- Remove all tape and packaging before using the range. Destroy the carton and plastic bags after unpacking the range. Never allow children to play with packaging material.
- Proper installation—Be sure your appliance is properly installed and grounded by a qualified technician in accordance with the National Electrical Code ANSI/NFPA No. 70 latest edition, and local electrical code requirements. In Canada, install in accordance with CSA Standard C22.1, Canadian Electrical code, Part 1, and local electrical code requirements. Install only per installation instructions provided in the literature package for this range.
- User servicing—Do not repair or replace any part of the appliance unless specifically recommended in the manuals. All other servicing should be done only by a qualified technician. This reduces the risk of personal injury and damage to the range.
- Ask your dealer to recommend a qualified technician and an authorized repair service. Know how to disconnect the power to the range at the circuit breaker or fuse box in case of an emergency.
- Never modify or alter the construction of a range by removing the leveling legs, panels, wire covers, anti-tip brackets/screws, or any other part of the range.
- Do not attempt to operate the range during a power failure. If the power fails, always turn off the range. If the range is not turned off and the power resumes, the range will begin to operate again. Once the power resumes, reset the clock and oven function.

Save these instructions for future reference.

IMPORTANT SAFETY INSTRUCTIONS

- Cold temperatures can damage the electronic control. When using this appliance for the first time, or when the appliance has not been used for an extended period of time, be sure the appliance has been in temperatures above 32°F (0°C) for at least 3 hours before turning on the power to the appliance.
- Remove the oven door from any unused range if it is to be stored or discarded.
- Be sure to have an appropriate foam-type fire extinguisher available, visible, and easily accessible located near the appliance.

WARNING

- Do not leave children alone - Children should not be left alone or unattended in the area where the appliance is in use. They should never be allowed to sit or stand on any part of the appliance, including the storage drawer, lower broiler drawer, warmer drawer, or lower double oven.
- Stepping, leaning, or sitting on the door or drawers of a oven can result in serious injuries and also cause damage to the appliance. Do not allow children to climb or play around the oven. The weight of a child on an open oven door may cause the oven to tip, resulting in serious burns or other injury.
- Never cover any slots, holes, or passages in the oven bottom or cover an entire oven rack with materials, such as aluminum foil. Aluminum foil linings may trap heat, causing a fire hazard.

CAUTION

- Do not touch heating elements or interior surfaces of oven - Heating elements may be hot even though they are dark in color. Interior surfaces of an oven become hot enough to cause burns. During and after use, do not touch or let clothing or other flammable materials contact these areas until they are cool. These areas may include the cooktop, surfaces facing the cooktop, oven vent areas, oven door, and oven window.
- Wear proper apparel - Loose-fitting or hanging garments should never be worn while using the appliance.
- Do not heat unopened food containers - Build-up of pressure may cause container to burst and result in injury.
- Watch closely when heating fat or grease. Grease may catch fire if it becomes too hot.
- Do not use water or flour on grease fires. Smother fire or flame or use dry chemical or foam-type extinguisher. Cover the fire with a pan lid or use baking soda.
- Use dry potholders. Moist or damp potholders on hot surfaces may result in burns from steam. Do not let potholders touch hot cooking areas. Do not use towels or other bulky cloths.

Save these instructions for future reference.

IMPORTANT SAFETY INSTRUCTIONS

Important Instructions For Ceramic Glass Cooktops

- Do not cook on a broken cooktop. If the cooktop is broken, cleaning solutions and spills may penetrate the cooktop and create a risk of electric shock. Contact a qualified technician immediately.
- Exercise caution when cleaning the cooktop. If a wet sponge or cloth is used to wipe spills on a hot cooking area, be careful to avoid steam burns. Some cleaners can produce noxious fumes if applied to a hot surface.

Important Instructions for Using your Cooktop

- Know which knob or keypad controls each surface cooking zone. Place pan with food on the cooking zone before turning it on. Turn the cooking zone off before removing the pan.
- Use proper pan size. This appliance is equipped with induction cooking zones of different sizes. Select utensils specifically manufactured or approved for induction cooking. Pans should have flat bottoms that match the induction cooking zone size. Using the proper utensil on the cooking zone will improve efficiency.
- To reduce the risk of burns, ignition of flammable materials, and spills due to unintentional contact with the cookware, turn utensil handles inward and do not extend them over other cooking zones.
- Never leave surface cooking zones unattended. Boil-overs may cause smoking and greasy spills may ignite. A pan that has boiled dry could be damaged and may damage the cooktop.
- When you are flaming foods under a ventilating hood, turn on the fan.

Important Instructions for Using Your Oven

- Never use your appliance for warming or heating the room.
- Use care when opening oven door, lower oven door, or warmer drawer (some models). Stand to the side of the oven when opening the door of a hot oven. Let hot air or steam escape before you remove or replace food in the oven.
- Keep oven vent ducts clear. Touching surfaces in this area when the oven is on may cause severe burns. Do not place plastic or heat-sensitive items on or near the oven vent. These items can melt or ignite.
- Placement of oven racks - Always place oven racks in their desired locations while oven is cool. If the rack must be moved while the oven is hot, do not let potholder contact a hot heating element in the oven. Use potholders and grasp the rack with both hands to reposition. Do not let potholders contact the hot heating elements in the oven. Remove all cookware and utensils before moving the rack.
- Do not use a broiler pan without its insert. Broiler pans and inserts allow dripping fat to drain away from the high heat of the broiler. Do not cover the broiler insert with aluminum foil; exposed fat and grease could ignite.
- Protective liners - Do not use aluminum foil to line surface unit drip bowls or oven bottoms, except as suggested in the manual. Improper installation of these liners may result in a risk of electric shock or fire.
- Do not cook food on the oven bottom. Always cook in proper cookware and always use the oven racks.

Save these instructions for future reference.

IMPORTANT SAFETY INSTRUCTIONS

Important Instructions for Cleaning Your Oven

CAUTION

Before manually cleaning any part of the range, be sure all controls are turned off and the range is cool. Cleaning a hot range can cause burns.

- Clean the range regularly to keep all parts free of grease that could catch fire. Pay particular attention to the area around each surface element. Do not allow grease to accumulate.
- Always follow the manufacturer's recommended directions for use of kitchen cleaners and aerosols. Be aware that excess residue from cleaners and aerosols may ignite causing damage and injury.
- Clean ventilating hoods frequently. Grease should not be allowed to accumulate on the hood or filter. Follow the manufacturer's instructions for cleaning hoods.

Important Instructions for Self Cleaning Ovens

- Use the self clean cycle to clean only the parts listed in this manual. Before using self clean, remove the broiler pan, any food, utensils, and cookware from the oven. Remove oven racks unless otherwise instructed.
- Do not use oven cleaners. No commercial oven cleaner, oven liner, or protective coating of any kind should be used in or around any part of the oven.
- Do not clean the oven door gasket. The door gasket is essential for a good seal. Do not rub, damage, or move the gasket.
- Some birds are extremely sensitive to the fumes given off during the self clean cycle of any range. Move birds to another well-ventilated room.

Grounding Instructions

WARNING

Avoid fire hazard or electrical shock. Do not use an adapter plug, extension cord, or remove grounding prong from the power cord. Failure to follow this warning may cause serious injury, fire, or death.

For models with a factory-equipped power cord:

For personal safety, this appliance must be properly grounded. For maximum safety, the power cord must be plugged into an electrical outlet that is the correct voltage, is correctly polarized and properly grounded in accordance with local codes.

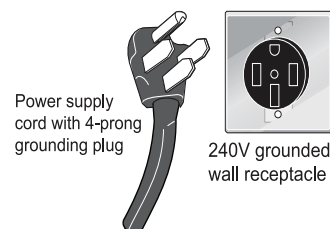

It is the personal responsibility of the consumer to have the appropriate outlet with the correct, properly grounded wall receptacle installed by a qualified electrician. See the installation instructions packaged with this appliance for complete installation and grounding instructions.

For models without a factory-equipped power cord:

For personal safety, this appliance must be properly grounded. For maximum safety, the power cord must be plugged into an electrical outlet that is the correct voltage, is correctly polarized and properly grounded in accordance with local codes. It is the personal responsibility of the consumer to have the appropriate outlet with the correct, properly grounded wall receptacle installed by a qualified electrician. It is the responsibility and obligation of the consumer to contact a qualified installer to assure that the electrical installation is adequate and is in conformance with all local codes and ordinances.

See the installation instructions packaged with this appliance for complete installation and grounding instructions.

Save these instructions for future reference.

BEFORE SETTING SURFACE CONTROLS

Induction Cooking Zones

Your cooktop is equipped with four induction cooking zones of different sizes and a radiant heat warmer zone (Figure 1).

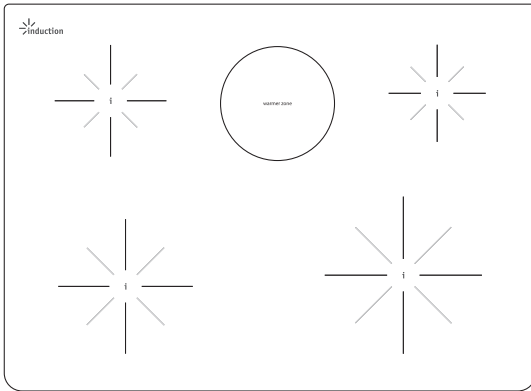

Figure 1: Typical induction cooktop

Benefits of Induction Surface Cooking

Fast and efficient - Induction cooking zones heat faster and use less energy. Induction power levels are quick to boil and they are efficient when simmering.

A cooler cooktop - A unique feature of the induction cooking zones is, whether it is turned on or off, the cooking zones remain cooler than radiant type elements. Virtually no wasted heat is produced since the heat begins with the presence of cookware.

Easy cleanups - The cooler cooking zones make cleanup easier. Spills resist sticking or burning so they wipe up easily.

Magnetic detector - The cooking zone has a sensor that automatically detects whether cookware is magnetic. This will reduce accidental "turn-ons."

Pan size detection - The pan size recognition sensor automatically detects and adapts the induction cooking zones to the pan sizes in use for consistent, more even cooking.

More responsive - Induction cooking zones are more responsive than their electric or gas counterparts because only the pan heats. This type of cooking heats easier and will be just as responsive when reducing to a simmer.

Induction cooking directly heats the pan; heating will only begin when cookware is properly placed on the cooking zones.

Induction Cookware

▶ IMPORTANT

Before using the induction cooking zones, be sure to carefully read and follow these cookware recommendations and the instructions in the pan sensing section.

When purchasing pans for use on the induction cooktop, look for cookware specifically identified by the manufacturer as induction ready, induction capable, or a similar statement by the manufacturer that the cookware is specifically designed for induction cooking.

The cooking zones will not activate if the cookware is not constructed with a base magnetic material. To check if the cookware base material is suitable, use a magnet to test (Figure 2). If a magnet sticks to the bottom of the cookware, the material type is correct.

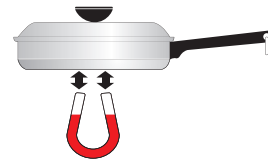

Figure 2: Testing a pan for magnetic properties

For the best possible surface cooking results, it is recommended to only use high quality heavy gauge cookware on the induction cooking zones. Be sure to follow all the manufacturer's recommendations when using cookware made for induction cooking.

Induction Cookware Types

The most common induction cookware types available are:

- **Stainless steel** - Generally excellent for induction cooking. Is durable, easy to clean and resists staining.

▶ IMPORTANT

Not all stainless steel cookware is magnetic; stainless steel is not always suitable for induction cooking.

- **Cast iron** - Good for induction cooking. Cooks evenly. Do not slide cast iron cookware on cooktop. Cast iron cookware with a rough surface will scratch ceramic cooktop.
- **Porcelain-enamel coated metals** - Heating characteristics will vary depending on quality of base material. Porcelain-enamel coating must be smooth to avoid scratching the ceramic cooktop.

BEFORE SETTING SURFACE CONTROLS

Tips For Using the Cooking Zones

- Be sure to use cooktop cookware made with a magnetic base material.
- Use quality cooktop cookware with heavier bottoms for better heat distribution, allowing for more even cooking results.
- Check that cookware bottom rests level on cooktop surface. Cookware should have flat bottoms that make good contact with the entire induction cooking zone area. Check for flatness by rotating a ruler across the bottom of the cookware (Figure 3).
- Be sure cookware is properly balanced and does not tilt from a heavy handle.
- Be sure that the pan size matches the amount of food to be prepared. The size and type of cookware used will influence the setting needed for best cooking results.
- Never let cookware boil dry. This may cause permanent damage such as breakage, fusion, or marring that can affect the cooktop.
- Use cookware that meets the minimum and maximum cookware size requirements for each cooking zone.



Figure 3: Checking the pan for flatness

CAUTION

- Do not place flammable items such as plastic salt and pepper shakers, spoon holders or plastic wrappings on the cooktop when it is in use. These items could melt or ignite if placed too close to hot cookware.

Moving Cookware on a Smoothtop

It is recommended to always use heavier gauge high quality cookware on the cooking zones. Even high quality cookware can still scratch the cooktop surface. Do not slide cookware on the ceramic cooktop.

IMPORTANT

- Always lift cookware before moving on the ceramic glass smoothtop. Any cookware that has rough or dirty bottoms can mark and scratch the ceramic glass surface. Always start with clean cookware.
- Do not allow aluminum foil, or any material that can melt to make contact with the ceramic glass cooktop. If these items melt on the cooktop they may damage the ceramic cooktop.

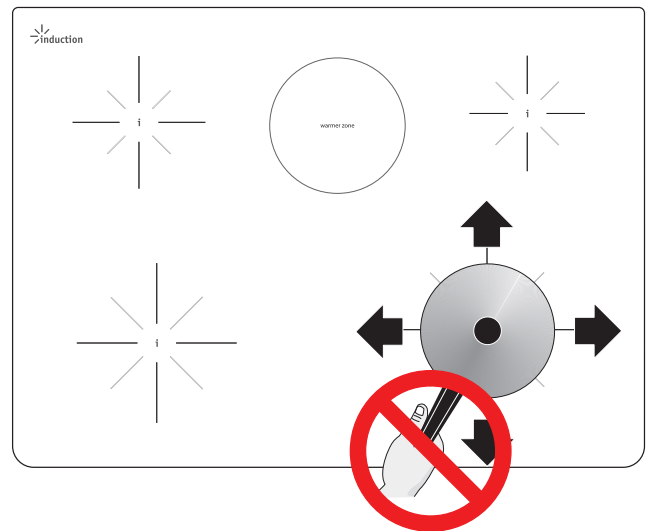

Figure 4: Do not slide pan

Sliding any type of cookware over the surface will scratch the cooktop over time. Scratches will make cleaning the ceramic cooktop difficult and degrade the appearance of the cooktop.

See “Care and Cleaning” beginning on page 37 for more detailed information about the cooktop.

BEFORE SETTING SURFACE CONTROLS

Pan Sensing

The cooking zone sensors located below the cooktop surface require that certain cookware conditions are met before the induction cooking zones can operate.

The cooking zone display windows may display a pan sensing error message. If a cooking zone is activated and no cookware is detected, the affected induction cooking zone display window will flash with the last power level request setting (Figure 5). If the cookware does not meet the correct conditions, the cooking zones may not heat.



Figure 5: Power boost power level setting

A flashing error message as illustrated in Figure 5 can be generated by those conditions. Use Figure 6 as a guide to help to correct the problem or problems before attempting to reactivate any of the cooking zones.

If the problem or problems are not corrected, the affected cooking zone will automatically deactivate after 3 minutes.

NOTE

It is recommended that you lower the requested power level setting before correcting the pan sensing message.







Correct	Incorrect
<ul style="list-style-type: none">• Cookware base material has good magnetic characteristics. 	<ul style="list-style-type: none">• Cookware base material is non-magnetic. 
<ul style="list-style-type: none">• Cookware centered correctly on cooking zone. 	<ul style="list-style-type: none">• Cookware not centered on cooking zone. 
<ul style="list-style-type: none">• Flat pan bottom and straight sides. 	<ul style="list-style-type: none">• Curved or warped pan bottoms or sides. 
<ul style="list-style-type: none">• Pan size meets or exceeds the recommended minimum size for cooking zone.	<ul style="list-style-type: none">• Pan does not meet the minimum size required (too small) for cooking zone.
<ul style="list-style-type: none">• Pan rests completely and is level on the cooktop surface. 	<ul style="list-style-type: none">• Pan bottom rests on cooktop edge. 
<ul style="list-style-type: none">• Pan is properly balanced. 	<ul style="list-style-type: none">• Heavy handle tilts pan. 

Figure 6: Potential cooking zone Issues

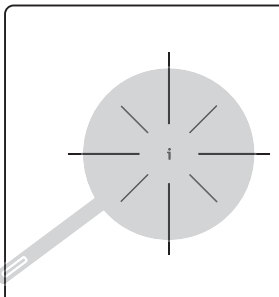
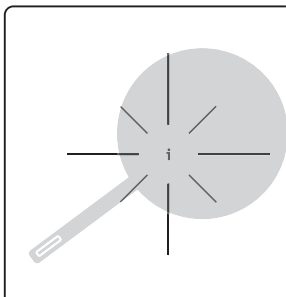
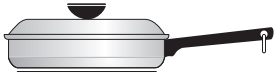
BEFORE SETTING SURFACE CONTROLS

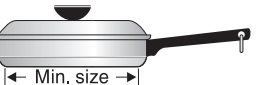
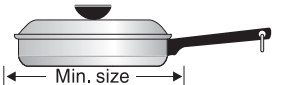
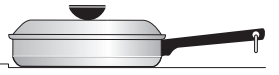
Minimum and Maximum Pan Size

Induction cooking zones require a minimum pan size in order to activate. The graphics on each cooking zone location are your guide to the correct minimum pan size for that zone. The shorter lines guide the minimum pan size. The longer lines guide the maximum pan size. The cookware bottom must meet the minimum and maximum area requirements for the heating process to begin. See Figure 7 for the pan size requirements for each cooking zone location.

If a pan that is induction-capable is centered properly but is too small, the affected cooking zone display will flash the last power level setting and the pan will not heat. Select a larger pan that meets the minimum size requirement to activate the selected cooking zone.

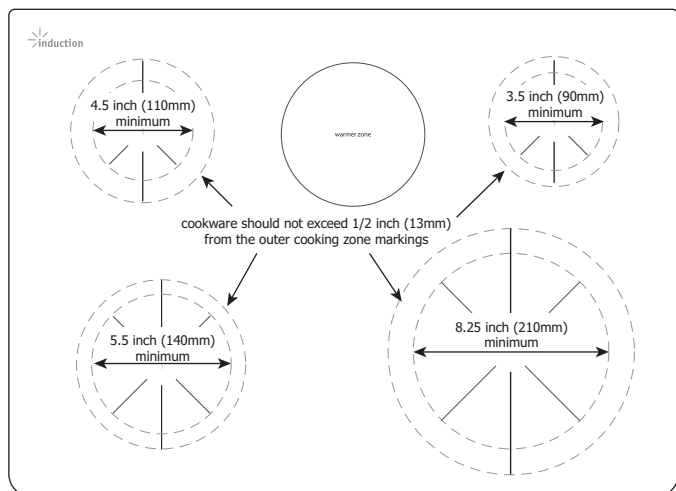

Figure 7: Induction pan size requirements

Do not use pans with bottoms that extend more than 1/2" (13mm) beyond any of the longer line marks provided on the cooktop. The cookware must make full contact with the ceramic glass surface. Cookware should not rest on or touch the metal edges of the cooktop.

The type and size of cookware, cooking duration, number of cooking zones in use and their power level settings are all factors that affect the amount of heat that will spread beyond the cooking zones. Induction cooking zones and areas surrounding the cooking zones may become hot enough to cause burns. Be sure to read all cautions.

Hot Cookware and Residual Heat

! CAUTION

Unlike radiant surface elements, induction cooking zones do not glow red when hot. The glass surface may be hot from residual heat transferred from the cookware and burns may occur. Do not touch hot cookware or pans directly with hands. Always use oven mitts or potholders to protect hands from burns.

Home Canning

! CAUTION

Canning can generate large amounts of steam. Use extreme caution to prevent burns. Raise the lid to vent steam away from you. Safe canning requires that harmful micro-organisms are destroyed and jars seal completely. When canning in a water bath canner, continuously maintain a gentle but steady boil for the required time.

Be sure to read and observe the following points when home canning with your appliance.

Check with the United States Department of Agriculture (USDA) website. Be sure to read all the available information as well as follow the recommendations for home canning procedures.

- Use only quality flat bottom canners when home canning. Use a straight-edge to check canner bottom.
- Use only a completely flat bottom canner with no ridges that radiate from the bottom center when home canning using a range with a ceramic glass cooktop.
- Make sure the diameter of the canner does not exceed 1 inch beyond the cooking zone markings. It is recommended to use smaller diameter canners on ranges with ceramic glass or open coil electric cooktops.
- Start with hot tap water to boil more quickly. Use the highest heat setting when first bringing the water to a boil. Once boiling is achieved, reduce heat to lowest possible setting to maintain that boil.
- It is best to can small amounts and light loads.
- Do not leave water bath or pressure canners on high heat for extended amounts of time.
- Alternate surface units between each batch to allow the units and surrounding surfaces to cool down. Try to avoid canning on the same burner unit all day.

SETTING SURFACE CONTROLS

Cooktop Display Windows

The range backguard provides a digital window for each cooking zone on the cooktop. Power levels and messages are monitored and controlled using the window displays in combination with the corresponding control knobs.

Available Power Level Settings

The cooktop control (Figure 8) displays power levels ranging from **Lo** to **Hi** to **Pb** (Figure 9) in a display window located above each control dial. The settings range is between 1.5 and 9.5 (Figure 10), adjustable in 0.5 increments.

Use Table 1 on page 13 to determine the correct power level setting for the type of food you are preparing.

Power Boost (Pb) Power Level

When setting an induction cooking zone for **Hi**, the display will initially show **Pb** power level for up to 10 minutes (Figure 9). After 10 minutes the cooking zone will automatically return to the **Hi** setting. The **Pb** setting is only available immediately after activating a cooking zone by turning the knob to **Hi**.

Hot Element (HE) Surface Window Message

When using a cooking zone, the cooktop may become very hot. After turning any cooking zone off, the cooktop may remain hot for some time. The corresponding **HE** (Figure 11) message displays until the cooktop has cooled.

ESEC Error Indicator Message (Er)

An error message will display flashing **Er** (Figure 12) at power up or after a power failure for any surface control knob not in the **OFF** position. If a power failure should occur, set all surface control knobs to **OFF** (Figure 8). This will reset the surface controls.

Review “Setting the Clock” on page 20 to reset the clock. Once the surface controls have been set to **off** and the clock has been set with the correct time of day, the surface controls should return to normal operation. If the surface controls do not function and the **Er** message remains in any display after following these procedures, contact an authorized service provider for assistance.

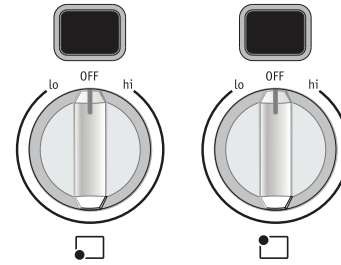

Figure 8: Typical induction cooktop controls



Figure 9: Power setting indications



Figure 10: Power level ranges



Figure 11: Hot element display



Figure 12: ESEC error indication

Lockout Window Message

The (- -) message appears whenever Lockout, self clean, or Sabbath is active (Figure 13). See “Setting Oven Lockout Feature” on page 22 for more details.



Figure 13: ESEC error indication

➔ IMPORTANT

Induction cooking zones will not operate when the oven is set for Sabbath mode. For more details on the Sabbath feature, see “Setting the Sabbath Feature” on page 32.

SETTING SURFACE CONTROLS

Operating Induction Cooking Zones

Start most surface cooking on a higher setting and then adjust to a lower setting to finish cooking.

The suggested settings provided in [Table 1](#) may vary slightly, depending on the cookware design, quality and amount of food being prepared.

Be sure to use quality cookware that is constructed with magnetic base material and meets the minimum and maximum pan size requirements.

Table 1: Suggested power level settings

Settings	Type of Cooking
Power boost (Pb)	Use to heat pans with large amounts of food or to bring large pans of water to boil
High (8.0 - Hi)	Start most foods, bring water to a boil, pan broiling
Medium high (5.0 - 8.0)	Continue a rapid boil, fry, deep fat fry
Medium (4.0 - 5.0)	Maintain a slow boil, thicken sauces and gravies or steam vegetables
Medium low (2.0 - 4.0)	Keep foods cooking, poach, stew (3.0 or lower is a simmer setting)
Low (Lo - 2.0)	Keep warm, melt, simmer

NOTE

- The suggested power level settings are based on cooking with medium sized pans with lids. Be sure to make any further setting adjustments needed for best surface cooking results.
- The size and type of utensil used, and the amount and type of food being cooked will influence the setting needed for best cooking results.

Pan Preheat Recommendations

Be aware that induction cooking may decrease the amount of time required to preheat a cooking utensil compared to cooking on a radiant element cooktop or gas surface burner.

Whenever using the cooktop or oven always pay close attention to all food items cooking and remain very attentive until all the cooking processes are complete.

To operate induction cooking zones:

IMPORTANT

Remember that induction surface cooking will initially heat the cooking utensil very quickly.

1. Place induction cookware on the desired cooking zone.
2. To activate a cooking zone, push in and turn the control knob in either direction to the desired setting.
3. Adjust the power level by turning the knob. This will increase or decrease the power level in 0.5 increments from 1.5 to 9.5. **Lo** is the lowest power level available.
4. Once cooking is complete, turn the control knob **off** and remove cookware.

Cooktop Operational Noises

The electronic processes involved with induction cooking may create some background noises. You may hear a slight “buzzing” sound when cooking on the cooktop.

These noises are part of the induction cooking process and are considered normal.

Some cookware will “buzz” depending on the construction or base material. The buzz may be more noticeable if the contents of the pan are cold. As the pan heats up, the noise will decrease. The noise will also decrease if the power level setting is reduced.

NOTE

When using the induction cooktop, operational noises are more noticeable while cooking at the power boost level. Very loud noises are not part of normal induction cooking.

SETTING SURFACE CONTROLS

Warmer Zone

WARNING

Food Poisoning Hazard. Do not let food sit for more than 1 hour before or after cooking. Doing so can result in food poisoning or sickness. Foods that can easily spoil such as milk, eggs, fish, meat, or poultry should be chilled in the refrigerator first. Even when chilled, they should not stand in the oven for more than 1 hour before cooking begins and should be removed promptly when finished cooking.

The purpose of the warmer zone is to keep foods (vegetables, gravies, casseroles, soups, stews, breads, pastries and oven-safe dinner plates) at serving temperature (Figure 14).

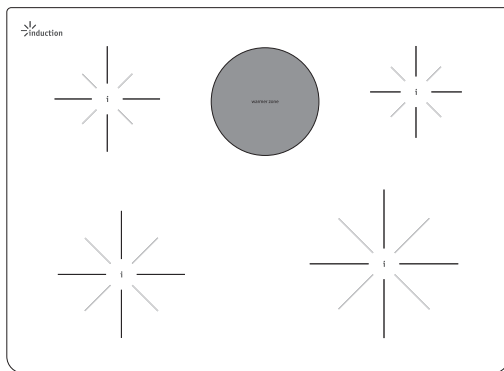

Figure 14: Warmer zone cooktop location

IMPORTANT

Always start with hot food. Do not heat cold food on the warmer zone. All food placed on the warmer zone should be covered with a lid to maintain quality.

For best results:

- When warming pastries or breads, the cover should have an opening to allow moisture to escape.
- Do not use plastic wrap to cover food. Plastic may melt onto the surface and be very difficult to remove.
- Use only dishware, utensils and cookware recommended for oven and cooktop use.

CAUTION

- Unlike radiant surface elements, induction cooking zones will not glow red when they are hot. The glass surface may be hot from residual heat transferred from the cookware and burns may occur.
- Do not touch hot cookware or pans directly with hands. Always use oven mitts or pot holders to protect hands from burns.
- The cooking zones may appear to have cooled after they have been turned off. The glass surface may still be hot from residual heat and burns may occur if the cooktop is touched before it has cooled sufficiently.
- Do not place flammable items such as plastic salt and pepper shakers, spoon holders or plastic wrappings on the cooktop when it is in use. These items could melt or ignite if placed too close to hot cookware.

IMPORTANT

- The hot element (**HE**) message will appear in the display windows once a heating element or cooking zone is turned off and will remain on until the heating surface area or areas have cooled sufficiently.
- Do not allow aluminum foil, or any material that can melt to make contact with the ceramic glass cooktop. If these items melt on the cooktop they may damage the ceramic cooktop.
- If the cookware is moved from the center of any active induction cooking zone, the pan sensor will detect the situation and the cookware will no longer heat. The affected cooking zone display window will flash until the cookware is moved back to center of cooking zone.
- If the cookware is placed back properly centered on the cooking zone, the zone will resume heating. The cooking zone will remember the power level setting for up to 3 minutes before the cooking zone will automatically shut off.

SETTING SURFACE CONTROLS

Warmer Zone Temperature Selection

If a particular food is not listed (Table 2), start with the medium heat level and adjust as needed (Figure 15). Most foods can be kept at serving temperatures by using the medium heat level.

Table 2: Food settings recommendations

Food Item	Heating Level
Breads/Pastries	lo (Low)
Casseroles	lo (Low)
Dinner plates with food	lo (Low)
Eggs	lo (Low)
Gravies	lo (Low)
Meats	med (Medium)
Sauces	med (Medium)
Soups (cream)	med (Medium)
Stews	med (Medium)
Vegetables	med (Medium)
Fried foods	hi (High)
Hot beverages	hi (High)
Soups (liquid)	hi (High)



To operate the warmer zone:

1. Place cookware on the warmer zone.
2. Press . The warmer zone indicator light will turn on.
3. Press **temp** once. The control will beep and the **lo** setting light will illuminate.
4. Press **temp** to adjust to the desired warmer setting.
5. When finished, press **on-off**. The warmer zone indicator light will turn off and the control will beep.

CAUTION

- The warmer zone produces radiant heat, but will not glow red when hot. To avoid possible burns always use potholders or oven mitts when moving food to and from the warmer zone as cookware and plates will be hot.
- Radiant surface elements may appear to have cooled after they have been turned off. The glass surface may still be hot and burns may occur if the glass surface is touched before it has cooled.
- Do not place flammable items such as plastic salt and pepper shakers, spoon holders or plastic wrappings on top of the range when it is in use. These items could melt or ignite. Potholders, towels or wooden spoons could catch fire if placed too close to the surface elements.

Figure 15: Warmer zone adjustment

BEFORE SETTING OVEN CONTROLS

Oven Vent Location

The oven vent is located under the control panel. When the oven is on, warm air passes through this vent. This venting is necessary for proper air circulation in the oven and good baking results. Do not block the oven vent.

Steam or moisture may appear near the oven vent. This is normal.

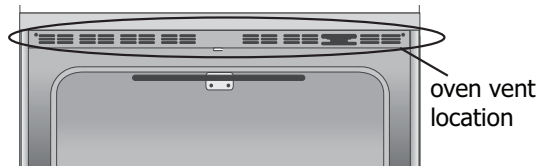

Figure 16: Do not block oven vent location

Types of Oven Racks

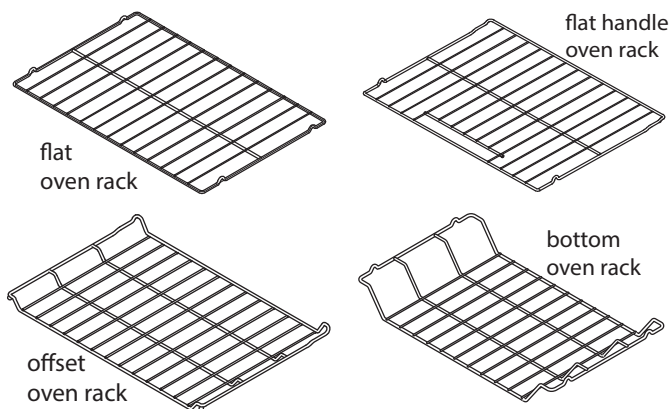

Figure 17: Oven rack types

- Flat oven racks (or the flat handle oven rack) may be used for most cooking needs and may be placed in most oven rack positions.
- The offset oven rack (some models) provides additional stepdown positions from the standard flat rack design. The offset design positions the base of the rack about a half rack position lower than the flat rack and may be used in most oven rack positions.
- The bottom oven rack (some models) allows you to maximize oven cooking space by using the lowest rack position for baking or roasting large cuts of meat.
- The “Effortless™ Oven Rack System” is described on [page 17](#).

Arranging, Removing, and Replacing Racks

! WARNING

Completely remove all oven racks and any cooking accessories from the oven before performing a self clean function in order to avoid damage to the racks. If oven racks are not removed before a self clean, they will lose their special coating and will no longer slide in and out of the oven cavity effortlessly.

! CAUTION

Always use pot holders or oven mitts when using the oven. When cooking, the oven interior and exterior, oven racks and cooktop will become very hot which can cause burns. Remove all racks and accessories prior to starting a self clean cycle.

- To arrange - Always arrange the oven racks when the oven is cool (prior to operating the oven).
- To remove - Pull the oven rack straight forward until it reaches the stop position. Lift up front of oven rack slightly and slide out.
- To replace - Place the oven rack on the rack guides on both sides of oven walls. Tilt the front of oven rack upward slightly and slide the oven rack back into place. Be sure oven racks are level before using.

➔ IMPORTANT

Do not line the oven walls, racks, bottom or any other parts of the range with aluminum foil. Doing so will alter heat distribution, produce poor baking results and may cause permanent damage to the oven interior. During self clean temperatures the oven will be hot enough to melt foil.

BEFORE SETTING OVEN CONTROLS

Effortless™ Oven Rack System

CAUTION

Remove all oven racks and accessories before starting a self clean cycle. If the oven racks are left in the oven during the self clean cycle, the gliding ability of the Effortless™ Oven Rack system will be damaged, and oven racks will lose their shiny finish and may turn blue. Remove all oven racks and clean according to instructions provided in “Care and Cleaning” beginning on page 37.

Make sure the oven and oven racks are completely cool before attempting to assemble or disassemble the Effortless™ Oven Rack system. Never pick up hot oven racks or parts.

Some models are equipped with a special oven rack system that automatically extends the oven rack to assist in access to your food items. This rack extends when the oven door is opened or closed (Figure 18).

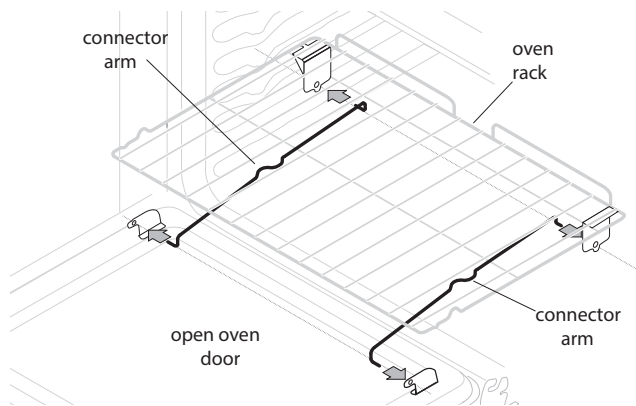

Figure 18: Effortless™ oven rack

IMPORTANT

The Effortless™ Oven Rack system can be used in oven rack positions 1, 2, or 3 (Figure 19). Placing any oven rack in any other position will prevent the oven door from fully closing and may damage the oven door, oven cavity, or the door connector brackets.

Do not attempt to use the Effortless™ Oven rack in rack positions 4 or 5.

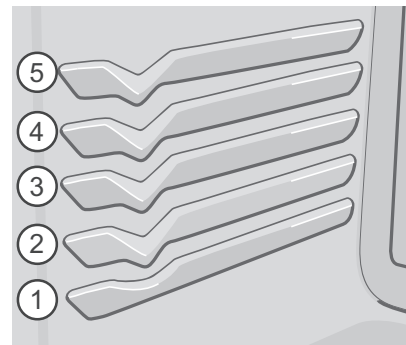

Figure 19: Rack positions

BEFORE SETTING OVEN CONTROLS

To assemble the Effortless™ Oven Rack system:

1. Locate all required parts. You will need the supplied oven rack (Effortless™ Oven Rack is a flat rack with a special dark coating on the left and right rack sides) and the two supplied chrome connector arms.
2. Be sure the oven is completely cool before proceeding.
3. Open the oven door.
4. Place the oven rack in positions 2, 3, or 4 only (Figure 19). Be sure the rack connector brackets are at the rear of the range and pointing towards oven bottom (Figure 20).

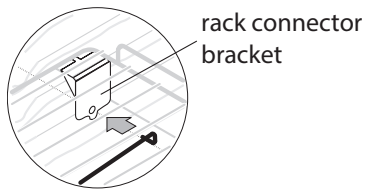

Figure 20: Bracket must be at rear of the range

5. Assemble one connector arm at a time. With the oven door open and the oven rack in place, install one end of the connector arm to the hole in the door connector bracket (Figure 21) and the other end in the hole in the rack connector bracket (Figure 22). The oven rack may need to be adjusted in or out in the rack position to match the length of the connector arm.

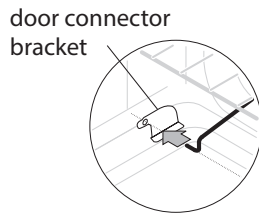

Figure 21: Connector arm/door connection

6. While holding the connector arm in place, twist the connector arm so the ends of the connector arm point upwards (Figure 23). The connector arm should now be locked into position (Figure 24).
7. Repeat steps 5 and 6 for the other connector arm.
8. Once both connector arms are properly in place, be sure to test the oven rack operation by gently closing the oven door. The oven rack should move in and out of the oven freely when the door is opened or closed.

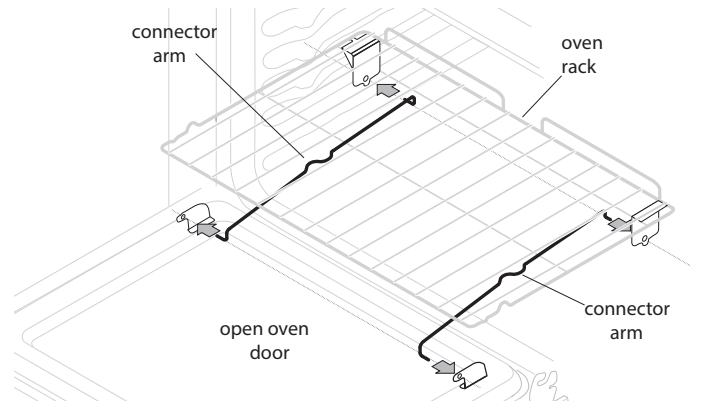

Figure 22: Assembly of the Effortless™ oven rack

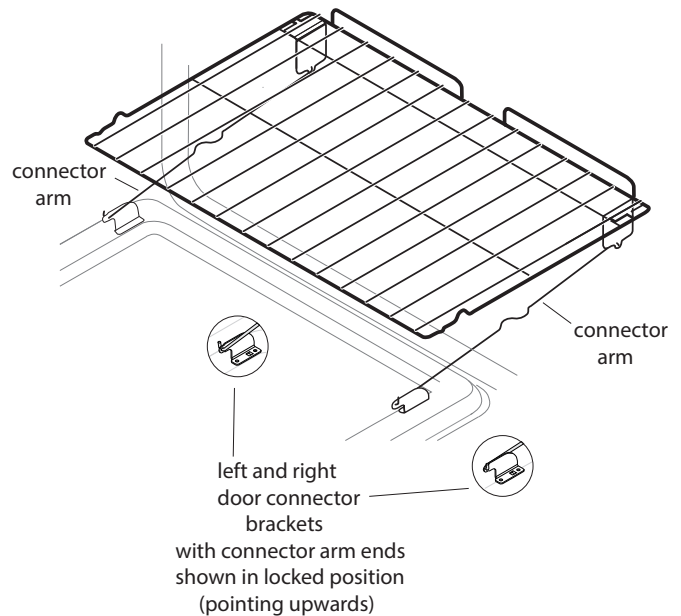

Figure 23: Effortless™ oven rack after assembly

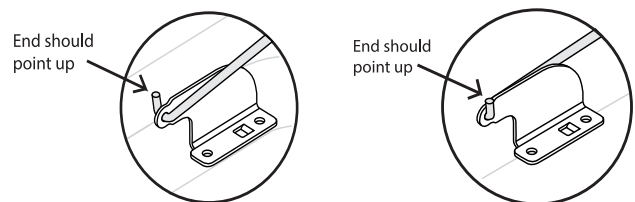
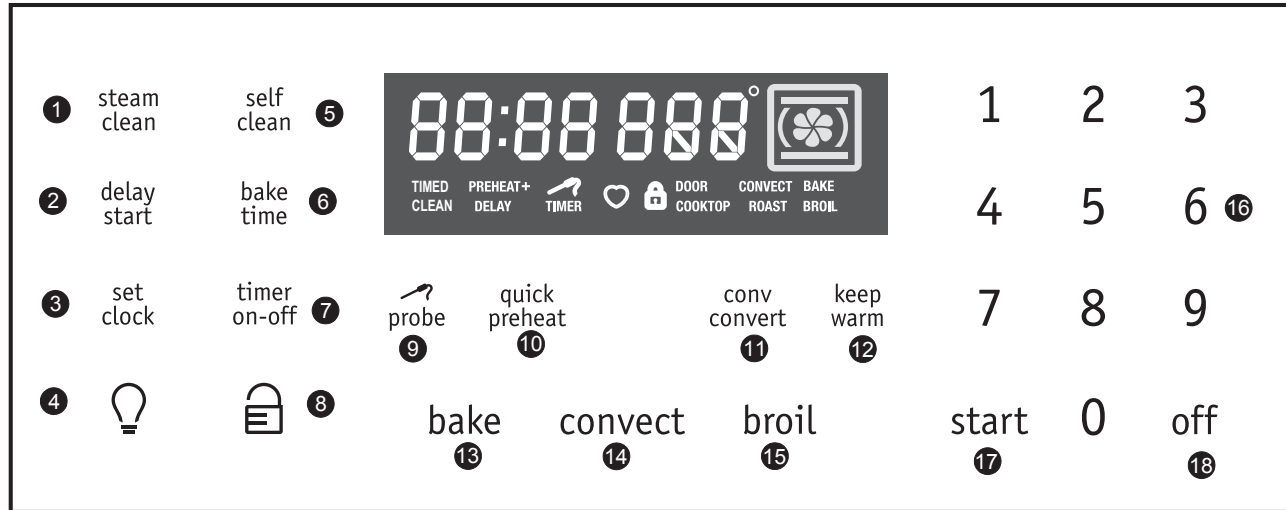

Figure 24: Left and right brackets, pointing up

OVEN CONTROLS



Oven Control Features

To get the best use of your oven, take some time to become familiar with the various features and functions of your oven model. Detailed instructions on using each oven feature and function of the controls can be found in this section of the owner's manual.

- 1. steam clean** — Use for steam clean function.
- 2. delay start** — Use to program a delayed time bake or delayed self cleaning cycle start time.
- 3. set clock** — Use along with the numeric keypad to set the time of day.
- 4. Oven light** — Use to turn the oven light on and off.
- 5. self clean** — Use to select self clean function.
- 6. bake time** — Use to enter the length of baking time.
- 7. timer on-off** — Use to set or cancel the timer. The timer does not start or stop the cooking process.
- 8. Oven lockout** — Use to lock the oven door and the control panel.
- 9. probe** — Use to monitor internal temperature of food for required doneness.
- 10. quick preheat** — Use to preheat oven temperature before cooking.
- 11. conv convert** — Use to convert regular recipe temperature to convection recipe temperatures.
- 12. keep warm** — Use to keep food and dishes warm until served.
- 13. bake** — Use to select the bake cooking feature.
- 14. convection** — Use to select between convection bake, convection roast, and convection broil.
- 15. broil** — Use to select broil cooking feature.
- 16. Numeric keypad** — Use to enter temperatures and times.
- 17. start** — Use for starting all cooking features.
- 18. off** — Use to turn off or cancel any oven function entered except time of day and minute timer.

OVEN CONTROLS

Table 3: Minimum and maximum control settings

Feature ^a	Mode	Minimum Temp./Time	Maximum Temp./Time
Quick Preheat		170°F (77°C)	550°F (288°C)
Bake		170°F (77°C)	550°F (288°C)
Broil		LO 400°F (204°C)	HI 550°F (288°C)
Convection Bake		170°F (77°C)	550°F (288°C)
Convection Roast		170°F (77°C)	550°F (288°C)
Convection Broil		400°F (204°C)	550°F (288°C)
Meat Probe		Lo 140°F (60°C)	Hi 210°F (99°C)
Timer	12/24 Hr. Mode	1 Min.	11:59 Hr./Min.
Clock Time	12 Hr. Mode 24 Hr. Mode	1:00 Hr./Min. 0:00 Min	12:59 Hr./Min. 23:59 Hr./Min.
Delay Start	12 Hr. Mode 24 Hr. Mode	1:00 Hr./Min. 0:00 Min	12:59 Hr./Min. 23:59 Hr./Min
Bake Time	12/24 Hr. Mode	1 Min.	5:59 Hr./Min.
Self Clean Time		2 hours	4 hours
Keep Warm			3 hours

a. The features listed show the minimum and maximum temperature or time settings allowable.

Setting the Clock

The set clock control is used to set the clock. The clock may be set for 12 or 24 hours display operation. The clock is preset at the factory for 12 hour display. When the oven is first plugged in, or when the power supply to the oven has been interrupted, the timer in the display will flash.

To set the clock (example below for 1:30):

1. Press **set clock**. The display will show **CLO**.
2. Press **1 3 0** on the keypad to set the time of day to 1:30. **CLO** will stay in the display.
3. Press **start**. **CLO** will disappear and the clock will start with the newly set time.

Setting 12 or 24 Hour Time of Day Display

1. Press and hold **set clock** for 6 seconds. **CLO** will appear in the display.
2. Continue holding the key until **12Hr dAY** or **24Hr dAY** appears in the display and the control beeps once.
3. Press **self clean** to switch between the 12 and 24 hour time of day display. The display will show either **12Hr dAY** or **24Hr dAY**.
4. Press **start** to accept the change or press **off** to reject the change.
5. Reset the correct time. If the 24 hour time of day mode was chosen, the clock will display time from **0:00** through **23:59** hours.

Temperature Display (Fahrenheit/Celsius)

The **broil** and **self clean** keys control the Fahrenheit (F) or Celsius (C) temperature display modes. The oven control can be programmed to display temperatures in °F or °C. The oven is preset at the factory to display in °F.

To change the temperature display:

1. To tell if the display is set for °F or °C, press **broil** and hold for 6 seconds. **550°** will appear, **broil** will flash in the display, and a beep will sound. If **F** appears, the display is set to show temperatures in Fahrenheit. If **C** appears, the display is set to show temperatures in Celsius.
2. Press **self clean** to switch between **F** or **C** display modes. The display will show either **F** or **C**.
3. Press **start** to accept the change or press **off** to reject the change.

Setting Continuous Bake or 6 Hour Energy Saving

The **timer on-off** and **self clean** keys control the continuous bake or 6 hour energy saving features. The oven control has a factory preset 6 Hour Energy Saving feature that shuts off the oven if the oven control is left on for more than 6 hours. The oven can be programmed to override this feature for Continuous Baking.

To set for continuous bake or 6 hour energy saving:

1. Press and hold **timer on-off** for 6 seconds. After 6 seconds **6Hr OFF** or **StAY On** will appear in the display and the control will beep once.
2. Press **self clean** to switch between the 6 hour energy saving and continuous bake features.
3. Press **start** to accept the change (display will return to time of day) or press **off** to reject the change.
 - **6Hr OFF** indicates the control is set for the 6 hour energy saving mode.
 - **StAY On** indicates the control is set for the continuous bake feature.

Setting Control for Silent Operation

Delay start and **self clean** keys control the silent control operation feature. The silent control operation feature allows the oven control to be operated without sounds or beeps whenever necessary. If desired the control can be programmed for silent operation and later returned to operating with all the normal sounds and beeps.

To change control from normal sound operation to silent control operation:

1. To set oven for normal or silent operation, press and hold **delay start**. -- -- will appear and **DELAY** will flash in the display. After 6 seconds **bBEEP On** or **bBEEP OFF** will appear in the display.
2. Press **self clean** to switch between normal sound operation and silent operation mode. The display will show either **bBEEP On** or **bBEEP OFF**. If **bBEEP On** appears, the control will operate with normal sounds and beeps. If **bBEEP OFF** appears, the control is in the silent operation mode.
3. Press **start** to accept the change or press **off** to reject the change.

NOTE



The control will always beep at the end of a minute timer and will beep when a set temperature has been reached, even if the control is set to silent operation.

OVEN CONTROLS

Setting Oven Lockout Feature

The  key controls the oven lockout. When active, this feature automatically locks the oven door, control keypads, and cooktop, and prevents the oven from being turned on. It does not affect the clock, timer, or interior oven lights.

To activate the oven lockout feature:

1. Press and hold  for 3 seconds.
2. After 3 seconds, **door Loc** will appear, a tone will sound, and **DOOR** and  will flash in the display.
3. Once locked, **DOOR** and the lock icon will stop flashing and remain visible with the lock icon.

NOTE

Lockout will not operate when the warmer zone is active.

To reactivate normal oven operation:

1. Press and hold  for 3 seconds.
2. After 3 seconds, **door Loc** will appear, a tone will sound, and the word **DOOR** and the lock icon will flash in the display until the oven door has completely unlocked.
3. The oven is now fully operational.

Setting the Minute Timer

The **timer on-off** key controls the minute timer and serves as an extra timer that can be used during any of the other oven control functions.

To set the minute timer:

1. Press **timer on-off**. -- -- will appear and **timer** will flash in the display. Press the number keys to set the desired time.
2. Press **start**. The time will begin to count down and **Timer** will stay in the display. When the time expires, **End** and **Timer** will show in the display. The clock will beep three times every 30 seconds until **timer on-off** is pressed.
3. To cancel the minute timer before the set time expires, press **timer on-off**.

NOTE

If **start** is not pressed within 25 seconds, the timer will return to the time of day. The timer does not start or stop the cooking process.

Oven Light

The oven is equipped with two oven lights that automatically turn on whenever the oven door is opened. The oven light may be turned on when the door is closed by using the oven light key on the control panel. The light does not operate during self clean. It will stay off until the door unlocks. For best baking results, do not leave the oven light on while cooking.

Press  to toggle the oven lights on and off:

See “Replacing the Oven Light” on page 39 to change lights.

Quick Preheat

The **quick preheat** feature is used when a recipe calls for preheating the oven. When the preheat stage ends, a tone will sound indicating when to place the food in the oven. Preheat can be programmed for temperatures between 170°F to 550°F (77°C to 288°C). It is unnecessary when roasting or cooking casseroles. For batter and dough based goods such as cakes, pastries, and breads, use the regular bake or convection function for best results.

To set the preheat temperature for 350°F (177°C):

1. Arrange the interior oven racks.
2. Press **quick preheat**. The display will show **350°**.
3. Press **start**. The display will show **350°** and **PREHEAT+** while the oven is preheating.
4. Press **off** when baking is complete or to cancel the preheat feature.

To change preheat temperature while oven is preheating (example: from 350°F to 425°F):

1. Press **quick preheat**. The display will show **3 5 0°**.
2. Press **4 2 5** to enter the new preheat temperature and press **start**. The display will show **4 2 5°**. Bake will display the set oven temperature and will continue cooking at the setting.
3. When preheated, place food in the oven...

NOTE

The convection fan will start as soon as the oven is set for convection bake. The display will show an icon of rotating fan within a square, indicating the convection fan is operating. The bake, broil, and convection elements will also cycle for a better heat distribution. Press **off** to stop the feature at any time.

4. When baking is complete, press **off**.

Setting Bake

Bake controls normal baking. If a quick preheating is preferred, refer to “Quick Preheat” on page 22. The oven can be programmed to bake at any temperature from 170°F to 550°F (77°C to 288°C). The default baking temperature is 350°F (177°C).

To set the bake temperature to 375°F (190°C):

CAUTION

Always use pot holders or oven mitts when using the oven. When cooking the oven interior, oven racks and cooktop will become very hot which can cause burns.

1. Arrange the interior oven racks.
2. Press **bake**. The display will show the default setting **350°**.
3. Press **3 7 5**.
4. Press **start**.

When Bake is active the oven begins to preheat. The display will show **PREHEAT+** and the oven temperature starting at 100°F (38°C). The convection fan will also run until preheating is complete. When the oven reaches the set temperature the control emits a tone to signal the oven is ready and the convection fan turns off. The display will show **375°**.

5. When preheat is completed, place food in oven.

NOTE

Pressing **off** at any time will stop the feature.

To change the bake temperature (example: changing from 375°F to 425°F):

1. Press **bake**. The display will show **375°**.
2. Press **4 2 5**.
3. Press **start**. The display will show the new setting.

For best bake results:

- For batter and dough based baked goods such as cakes, pastries, and breads, use the convection function for best results.
- Fully preheat the oven before baking items like cookies, cakes, biscuits, and breads.
- When using any single rack, position the rack so that the food is in the center of the oven.
- For best results when baking cakes using two oven racks, place racks in positions 2 and 4 (Figure 25).
- When baking using two oven racks, position cookware as shown in Figure 26.
- Allow at least 2 to 4 inches (5 to 10 cm) space between cookware for proper air circulation. Set one position lower if using offset racks.
- Dark or dull bakeware absorbs more heat than shiny bakeware. It may be necessary to reduce oven temperature and cook time to prevent overbrowning of some foods. Dark bakeware is recommended for pies. Shiny bakeware is recommended for cakes, cookies, and muffins.
- Do not open the oven door often. Doing so will reduce the temperature in the oven and may increase cook time.

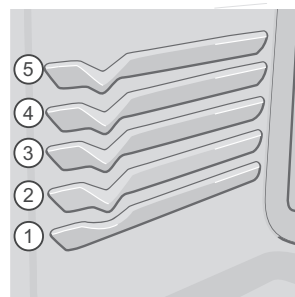

Figure 25: Rack positions

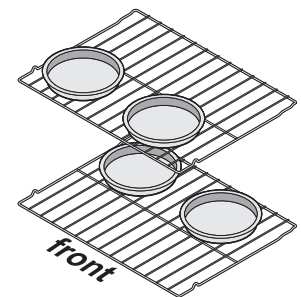

Figure 26: Pan spacing

OVEN CONTROLS

Convection Cooking

Convection baking uses the three elements and a fan to circulate the heat evenly and continuously within the oven (Figure 27). The improved heat distribution allows for even cooking with excellent results. Multiple rack baking may slightly increase cook time for some foods, but the overall result is time saved. Some food may cook faster and more evenly with convection bake.

Benefits of convection cooking:

- Multiple rack baking.
- Some foods cook faster, saving time and energy.
- No special pans or bakeware needed.

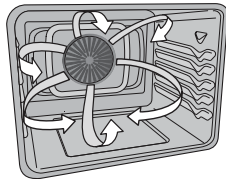

Figure 27: Air circulation in convection function

Setting Convection Bake

This mode of cooking enables you to obtain the best results when baking with multiple pans and racks. The oven can be programmed for convection baking at any temperature between 170°F to 550°F (77°C to 288°C) with a default temperature of 350°F (177°C).

To set the oven for convection bake and temperature to 375°F (190°C):

CAUTION

Always use pot holders or oven mitts when using the oven. When cooking the oven interior, oven racks and cooktop will become very hot which can cause burns.

1. Arrange the interior oven racks.
2. Press **convect**. **Convect** and **bake** will flash and the default temperature of **350°** will appear in the display.
3. Press **3 7 5**. **convect** and **bake** will keep flashing, and **375°** will appear in the display.
4. Press **start**. The actual oven temperature and the fan icon will be displayed. A beep will sound once the oven temperature reaches 375°F. The display will show **375°**, **CONVECT**, **BAKE**, and the fan icon.
5. Place food in the oven.

Convection baking tips:

- Fully preheat the oven before baking items like cookies, cakes, biscuits, and breads. Use convection baking for best results.
- When using any single rack, position the rack so that the food is in the center of the oven. When baking using two oven racks, position cookware as shown in Figure 29. Allow at least 2 to 4 inches (5 to 10 cm) space between cookware for proper air circulation.
- For best results when baking cakes using two oven racks, place racks in positions 2 and 4 (Figure 28).
- Bake cookies and biscuits on pans with no (or very low) sides to allow heated air to circulate around the food.
- Dark or dull bakeware absorbs more heat than shiny bakeware. You may reduce oven temperature and cook time to prevent overbrowning of some foods. Dark bakeware is recommended for pies. Shiny bakeware is recommended for cakes, cookies, and muffins.
- Do not open the oven door often. Doing so will reduce oven temperature and may increase cooking time.

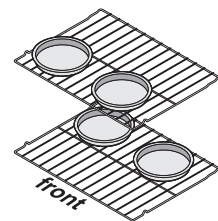
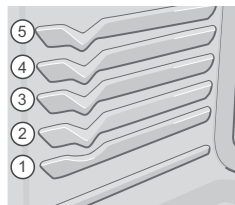

Figure 28: Rack positions Figure 29: Pan spacing

NOTE

The convection fan will start as soon as the oven is set for convection bake. The display will show an icon of rotating fan within a square, indicating the convection fan is operating. The bake, broil, and convection elements will also cycle for a better heat distribution.

Press **off** to stop the feature at any time.

WARNING

Should an oven fire occur, close oven door and turn off the oven. If the fire continues, throw baking soda on the fire or use a fire extinguisher. Do not put water or flour on the fire. Flour may be explosive, and water can cause a grease fire to spread and cause personal injury.

Setting Convection Convert

Convection convert automatically converts a standard baking recipe for convection baking. When set properly, this feature is designed to display the actual converted (reduced) temperature in the display. Convection convert may only be used with a convection bake cooking mode. It can be used with a delay start and bake time. If convection conversion is used with the bake time and delay start features, Check food (CF) will display when 75% of the bake time has completed. At this time the oven control will sound three long beeps at regular intervals until baking time is finished. The control will display **End** and continue to beep at regular intervals until **off** is pressed.

To set the oven for convection bake with a standard baking recipe temperature of 400°F (204°C):

CAUTION

Always use pot holders or oven mitts when using the oven. When cooking the oven interior, oven racks and cooktop will become very hot which can cause burns.

1. Arrange the interior oven racks.
2. Press **convect**. **Convect** and **bake** will flash and **350°** will appear in the display.
3. Press **4 0 0**. **Convect** and **bake** will keep flashing and **400°** will appear in the display.
4. Press **start**.
5. Set **bake time** or **delay start** if needed. See “Setting Delay Start” on page 26 and “Setting Bake Time” on page 25.
6. Press **convect convert**, and the oven will start heating. The temperature displayed will be 25°F (14°C) lower than what it was. The actual oven temperature and the fan icon will be displayed. A beep will sound once the oven temperature reaches 375°F, and the display will show **375°**, **CONVECT**, **BAKE**, and the fan icon.
7. Place food in the oven.

NOTE

When using a bake time under 20 minutes, the convection convert will not beep and display the **CF** message.

Press **off** to cancel the feature at any time.

Bake, broil, and convection elements will cycle for better heat distribution and faster, more even cooking.

Setting Bake Time

Use bake time when setting the oven to cook for a specific length of time and shut off automatically when the time is complete.

When cooking time ends, the oven will shut off and will beep. This feature can be used with bake, convection bake, convection roast, and slow cook modes.

To program the oven to begin baking immediately and to shut off automatically (example: Bake at 350°F for 30 minutes):

1. Be sure the clock is set for the correct time of day.
2. Arrange interior oven rack(s) and place the food in the oven.
3. Press **bake**. The display will show **350°**.
4. Press **start**. The actual oven temperature will appear in the display.
5. Press **bake time**. -- -- will appear in the display.
6. Enter the desired baking time by pressing **3 0**.
7. Press **start**. Once the timed bake feature has started, the current time of day will appear in the display.
8. Press **off** when baking has finished or to cancel the bake time feature at any time. A bake time of **0** minute can also be entered to cancel the bake time feature and keep the oven in its current cooking mode.

When the timed bake finishes:

1. **End** and the time of day will show in the display. The oven will shut off automatically.
2. The control will beep 3 times every 30 seconds until **off** is pressed.

NOTE

Baking time can be set for any amount of time between 1 minute to 5 hrs and 59 minutes. The time remaining can be shown in the timer section of the display by pressing **bake time** at any moment of the cooking.

Once bake time has started baking, a beep will sound when the oven temperature reaches the set temperature.

OVEN CONTROLS

Setting Delay Start

CAUTION

Food Poisoning Hazard. Do not let food sit for more than 1 hour before or after cooking. Doing so can result in food poisoning or sickness. Foods that can easily spoil such as milk, eggs, fish, meat, or poultry should be chilled in the refrigerator first. Even when chilled, they should not stand in the oven for more than 1 hour before cooking begins and should be removed promptly when finished cooking.

Bake, convection, bake time, and **delay start** keys control the delayed start feature. The automatic timer of delayed start will turn the oven on and off when you select in advance.

To program the oven for a delayed start time with the bake function. (example: baking at 375°F for 30 minutes, starting at 5:30):

1. Be sure that the clock is set with the correct time of day.
2. Arrange interior oven racks and place the food in the oven.
3. Press **bake**. The display will show **350°**.
4. Press **3 7 5** to enter the desired temperature.
5. Press **start**. The actual oven temperature will appear in the display.
6. Press **bake time**.
7. Enter **3 0** using the numeric keypad.
8. Press **start**.
9. Press **delay start**.
10. Enter the desired start time by pressing **5 3 0** on the numeric keypad.
11. Press **start**.

When a delayed baking function starts, the set oven temperature will appear. **Delay, bake,** and the current time of day will appear in the display. When the desired start time is reached, the actual oven temperature will appear in the display and **delay** disappears. Oven starts to bake at the previously selected temperature.

Keep Warm

Warm is best for keeping oven baked foods warm for serving after cooking has finished. **Keep warm** turns on the warm feature, will maintain an oven temperature of 170°F (77°C), and will keep oven baked foods warm for serving up to 3 hours after cooking.

After 3 hours, **keep warm** will shut the oven off. The feature may be used without any other cooking operations or can be set to turn on automatically after a bake time or delay start.

Keep Warm tips:

- Always start with hot food. Do not use keep warm to heat cold food.
- Food in heat-safe glass and glass ceramic containers may need higher temperature settings compared to food in regular containers.
- Do not open the oven door too often, it will allow hot air to escape and the food to cool.
- Aluminum foil may be used to cover food to increase moisture content.

To set keep warm:

1. Arrange interior oven racks and place food in the oven.
2. Press **keep warm**. “**HLd**” will appear in the display.
3. Press **start**. If **start** is not touched within 25 seconds the request to activate **keep warm** will be canceled.
4. To cancel keep warm at any time, press **off**.

To set keep warm to turn on automatically:

1. Arrange interior oven racks and place food in the oven. Set the oven properly for bake time or delay start.
2. Press **keep warm**. If no key is touched within 25 seconds, the request to turn on the warm feature will be cancelled.
3. Press **start**. **HLd** will disappear and the temperature will be displayed. Keep warm is set to turn on automatically after timed bake has finished.

OVEN CONTROLS

Setting Broil

Use the broil feature to cook meats requiring direct exposure to radiant heat for optimum browning results. The broil pan and insert used together allow grease to drain away from the high heat of the oven broiler. If a broiler pan and insert are not supplied, they may be purchased online from <http://www.frigidaire.com>.

To set broil at 500°F (260°C):

WARNING

Should an oven fire occur, close oven door and turn off the oven. If the fire continues, throw baking soda on the fire or use a fire extinguisher. Do not put water or flour on the fire. Flour may be explosive, and water can cause a grease fire to spread and cause personal injury.

CAUTION

Use potholders or oven mitts when using a hot oven. When broiling, the oven interior, racks and cooktop will become hot enough to cause burns. Do not use the pan without the insert. Do not cover the broil pan or insert with aluminum foil; the exposed grease could ignite.

1. Preheat for 5 minutes before broiling. If using a searing grill, first preheat oven for 5 to 10 minutes.

Table 4: Broiling Recommendations^{a, b, c}

Food item	Rack Position	Temperature	Cook time (minutes)		Internal Temperature	Doneness
			1st side	2nd side		
Steak 1" thick	4th or 5th	550°F (288°C)	6	4	145°F (63°C)	Medium
Steak 1" thick	4th or 5th	550°F (288°C)	7	5	160°F (71°C)	Medium-well
Steak 1" thick	4th or 5th	550°F (288°C)	8	7	170°F (77°C)	Well
Pork Chops 3/4" thick	4th or 5th	550°F (288°C)	8	6	170°F (77°C)	Well
Chicken - Bone In	3rd	450°F (232°C)	20	10	170°F (77°C)	Well
Chicken - Boneless	3rd or 4th	450°F (232°C)	8	6	170°F (77°C)	Well
Fish	3rd	500°F (260°C)	13	—	170°F (77°C)	Well
Shrimp	3rd	550°F (288°C)	5	—	170°F (77°C)	Well
Hamburger 1" thick	5th	550°F (288°C)	5	4	135°F (57°C)	Rare
Hamburger 1" thick	3rd or 4th	550°F (288°C)	9	7	145°F (63°C)	Medium
Hamburger 1" thick	3rd or 4th	550°F (288°C)	10	8	170°F (77°C)	Well

- The U.S. Department of Agriculture states, "Rare fresh beef is popular, but you should know that cooking it to only 140°F (60°C) means some food poisoning organisms may survive." (Source: Safe Food Book, Your Kitchen Guide, USDA Rev. June 1985.) The lowest temperature recommended by the USDA is 145°F (63°C) for medium rare fresh beef. For well done 170°F (77°C).
- Broiling is direct heat cooking and will produce some smoke. If smoke is excessive, place food further away from the element. Always watch food carefully to prevent burning.
- Use the off-set rack only in rack position 5, if an off-set rack is provided.

2. Arrange the interior oven rack and place the broiler pan on the rack. Center the broiler pan directly under the broiler element. Close the oven door.



Figure 30: Rack positions (L); Broil pan and insert (R)

3. Press **broil**. 550° will appear in the display. If a lower temperature is desired, press the desired temperature before continuing. The minimum broil temperature setting is 400°F (204°C). Press **start**. The oven will begin to broil. 5 0 0° will appear in the display.
4. Broil on one side until food is browned; turn and cook on the second side. Season and serve. Pull the rack out to the stop position before turning or removing food.
5. To stop or cancel the broil function, press **off**.
 - For optimum browning, preheat the broil element for 5 minutes. Broil one side until the food is browned; turn and cook on the second side. Season and serve.

OVEN CONTROLS

Setting Convection Broil

Use this mode for thicker cuts of meat, fish, and poultry. The convection broiling gently browns the exterior and seals in the juices. Convection broiling uses the broil element and a fan to circulate the oven's heat evenly and continuously within the oven. The oven can be programmed for convection broiling at any temperature between 400°F to 550°F (204°C to 288°C) with a default temperature of 550°F (288°C). See [Table 4](#).

To set a convection broil temperature of 500°F (260°C):

CAUTION

Always use pot holders or oven mitts when using the oven. When cooking the oven interior, oven racks and cooktop will become very hot which can cause burns.

1. Arrange oven racks first. Press **convect**; **350°** will be displayed, and **convect** and **bake** will flash.
2. Press **convect** two more times; **550°** will be displayed and **convect** and **broil** will flash.
3. Press **5 0 0**.
4. Press **start**. **CONVECT, BROIL, 500°**, and the fan icon will be displayed.
5. After 5 minutes of preheat, place food in the oven.

NOTE

The preheat tone will not sound for this feature.

Convection broiling tips:

- For optimum browning, preheat the broil element for 5 minutes.
- Always pull the rack out to the stop position before turning or removing food.
- Always use a broiler pan and insert when broiling. It keeps grease away from the high heat of the broil element.
- Do not use a broil pan without the insert. Do not cover an insert with foil. The exposed grease could catch fire.
- If using a searing grill (available by mail order), preheat the grill for 5 to 10 minutes before placing your meat. Broil one side until the food is browned; turn and cook on the second side. Season and serve.
- Convection broiling is generally faster than conventional broiling. Check for doneness at the minimum recommended time.

Setting Convection Roast

This mode is best for cooking tender cuts of beef, lamb, pork, and poultry. Use this mode when cooking speed is desired. Convection roasting gently browns the exterior and seals in the juices. Convection roasting uses the bake element, convection element, broil element, and fan to circulate the heat evenly and continuously within the oven. The oven can be programmed for convection roasting at any temperature between 170°F to 550°F (77°C to 288°C) with a default temperature of 350°F (177°C).

To set a convection roast temperature of 375°F:

WARNING

Should an oven fire occur, close oven door and turn off the oven. If the fire continues, throw baking soda on the fire or use a fire extinguisher. Do not put water or flour on the fire. Flour may be explosive, and water can cause a grease fire to spread and cause personal injury.

1. Arrange oven racks and place food in the oven.
2. Press **convect**; **350°** will be displayed; **Convect** and **bake** will flash.
3. Press **convect** again. **350°** will be displayed, and **convect** and **roast** will flash.
4. Enter **3 7 5** using the number keys.
5. Press **start**; The actual oven temperature will be displayed. **Convect, roast**, and the fan icon will be displayed. The bake, broil, and convection elements will also cycle for a better heat distribution.

Convection roasting tips:

- Use a broiler pan and insert, as well as a roasting rack (available online from <http://www.frigidaire.com>). The broiler pan will catch grease drippings, and the insert will help prevent splatters. The roasting rack will hold the meat.
- It's not recommended to roast chicken on a roasting rack. Use a deep pan instead.
- Make sure the roasting rack is securely seated on the insert in the broiler pan. Do not use the broiler pan without the insert or cover the insert with aluminum foil.
- Pull the rack out to the stop position before removing food. Position food (fat side up) on the roasting rack.

Cooking with Meat Probe

Use the probe feature for best results when cooking foods such as roasts, hams or poultry. 

For meats like poultry and roasts, using a probe to check internal temperature is the safest method to ensure properly cooked food.

When set correctly, the probe feature will signal an alert when the internal food temperature reaches the desired set target temperature.

When active, the probe displays the internal food temperature which is visible in the display during the cooking process. This eliminates any guesswork or the need to open the oven door to check the thermometer.

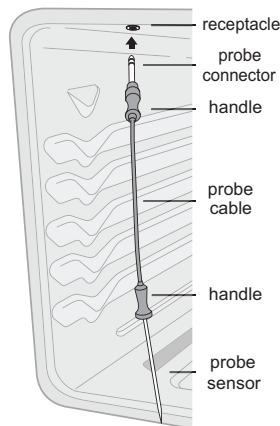

Figure 31: Using the probe

CAUTION

- Do not use kitchen utensils to pull on the probe cable or handles. Always insert and remove the probe using the provided handles, as shown in Figure 31.
- To avoid the possibility of burns after cooking with the probe, use care when disconnecting the probe from the receptacle or food. The probe may be hot. Be sure to always use a pot holder to protect your hands.
- Before starting self clean, verify that the probe is removed from the oven interior. The high temperatures during self clean may damage or destroy the probe.
- To avoid damaging the probe, defrost frozen foods completely before inserting.

To properly place the probe:

- Insert the probe so that the probe tip rests inside the center of the thickest part of meat or food (Figure 32). For best results, do not allow the probe temperature sensor to contact bone, fat, gristle, or the cookware.

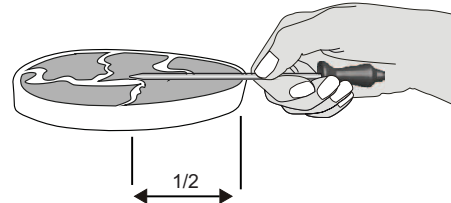

Figure 32: Probe in thickest area of food

- For bone-in ham or lamb, insert the probe into the center of lowest large muscle or joint. For meat loaf or casseroles, insert the probe into center of food. When cooking fish, insert meat probe just above the gill.
- For whole poultry or turkey, fully insert the probe sensor into the thickest part of the breast (Figure 33).

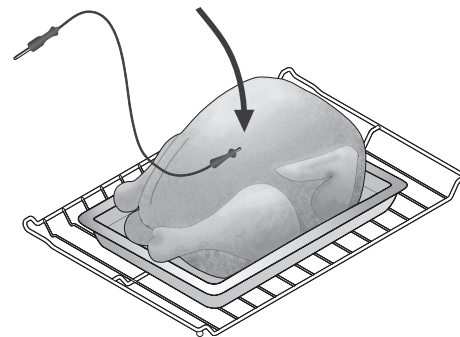

Figure 33: Probe in thickest part of breast

WARNING

- Do not store the probe inside the oven. Use only the original probe provided.
- Before starting self clean, double check that the probe is removed from the oven interior.
- Use only the original probe provided with this appliance. Connecting any other probe or device into the probe receptacle could result in damage to the oven control, electronics and the receptacle.

OVEN CONTROLS

To connect the probe to the oven:

1. Insert the probe into the food.
2. Place prepared food on the desired oven rack position and slide into the oven.
3. Plug the connector end of the probe all the way into the probe receptacle while the oven is still cool. The receptacle is located on the top left front of the oven cavity (Figure 34).

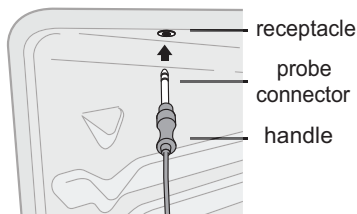



Figure 34: Probe connector

4. When the probe is set, a tone sounds, the probe icon illuminates, and the actual probe temperature appears in the display (Figure 35).
5. Close the oven door.



Figure 35: Probe set showing probe temperature

6. Press  once.
7. Enter the desired temperature for food type (Table 5). The minimum setting is 140°F (60°C); the maximum is 210°F (99°C). Default is 170°F (77°C).
8. Press **start** to accept the target temperature.
9. Set for **quick preheat, bake, convection bake, convection roast**, or **convection convert** as desired, and if necessary adjust the oven temperature accordingly.
10. The control will provide three beeps when the internal target temperature is reached. The oven will automatically change to a warm setting (**HLd**), and the actual probe temperature will alternate in the display. Warm will maintain the oven temperature at 170°F (77°C) for 3 hours unless otherwise cancelled.

To stop cooking at any time, press **off**.

Table 5: USDA recommended minimum internal cooking temperatures

Food Type	Internal Temp.
Ground meat and meat mixtures	
Beef*, Pork, Veal, Lamb	160°F (71°C)
Turkey, Chicken	165°F (73°C)
Fresh beef, veal, lamb	
Medium rare	145°F (62°C)
Medium	160°F (71°C)
Well Done	170°F (77°C)
Poultry	
Chicken and Turkey, whole	165°F (73°C)
Poultry Breasts, Roasts	165°F (73°C)
Poultry Thighs, Wings	165°F (73°C)
Duck and Goose	165°F (73°C)
Stuffing (cooked alone or in bird)	165°F (73°C)
Fresh Pork	
160°F (71°C)	
Ham	
Fresh (raw)	160°F (71°C)
Pre-cooked (to reheat)	140°F (60°C)
Eggs and egg dishes	
Eggs	Cook until yolk and white are firm
Eggs dishes	160°F (71°C)
Leftovers and Casseroles	165°F (73°C)

*The U.S. Department of Agriculture states, "Rare fresh beef is popular, but you should know that cooking it to only 140°F (60°C) means some food poisoning organisms may survive." (Source: *Safe Food Book, Your Kitchen Guide*, USDA Rev. June 1985.)

Visit the USDA Food Safety and Inspection website at www.fsis.usda.gov

To set how the oven will operate once the probe reaches the target temperature:

The oven will automatically stop cooking and start keep warm when probe sensor reaches the target temperature. This may be set to continue cooking if desired. Setting the options once the probe reaches the target temperature must be done when the oven is inactive. The probe does not need to be connected to the receptacle when setting this option.

To set the oven to continue cooking after reaching the target temperature:

1. Press **probe** key and hold for 6 seconds.
2. Press **self clean** key and toggle until **Continu** appears, as shown below, then press **start** to accept.

A black rectangular box representing an oven's digital display. The word "Continu" is shown in a white, segmented, digital font.

To set the oven to automatically stop cooking and start warm once reaching target temperature:

1. Press and hold the **probe** key for 6 seconds.
2. Press the **self clean** key and toggle until **CAnCEL** appears, as shown below, then press **start** to accept.

A black rectangular box representing an oven's digital display. The word "CAnCEL" is shown in a white, segmented, digital font.

PROBE TOO HOT Message:

When the message **PROB... TOO... HOT...** flashes in the display, the probe temperature has exceeded 250°F (121°C). If the probe is not removed, this message may continue until the sensor reaches 300°F (149°C) or higher. At this point the oven will automatically turn off. Be sure the probe sensor is fully covered by the food.

NOTE

During cooking the internal food temperature will display by default. To see the target temperature press the **probe** key once. After 6 seconds the display will revert to the internal food temperature. To assure accuracy, do not remove the probe from the food or receptacle until the desired internal temperature is reached.

If the probe is removed from the receptacle only, the probe feature will cancel but the oven will continue to cook. If the probe is removed from the food only, the probe feature will remain active and may eventually generate a probe too hot message.

To change the target temperature while cooking, press the **probe** key once. Use the numeric keys to change the temperature. Press the **start** key to accept any change.

OVEN CONTROLS

Setting the Sabbath Feature

(For use on the Jewish Sabbath and Holidays)



The **bake time** and **start** keys are used to set the Sabbath feature.

For further assistance, guidelines for proper usage, and a complete list of models with the Sabbath feature, please visit the web at <http://www.star-k.org>.

Bake time and **delay start** pressed together set the Sabbath feature. The Sabbath feature may only be used with the bake function. Once the oven is properly set using bake with the Sabbath feature active, the oven will remain on until cancelled. The Sabbath feature overrides the factory preset 12 hour energy saving feature.

If the oven light is needed during the Sabbath, press  before activating the Sabbath feature. Once the oven light is turned on and the Sabbath feature is active, the oven light will remain on until the Sabbath feature is turned off. If the oven light needs to be off, turn the oven light off before activating the Sabbath feature.

IMPORTANT

It is advised to not activate any cooking function other than bake while the Sabbath feature is active. The oven lights, start time and end time may only be set before entering the Sabbath mode.

To program the oven to begin baking immediately and activate the Sabbath feature (example: baking at 350°F):

1. Be sure that the clock is set with the correct time of day.
2. Place the food in the oven.
3. Press **bake**. The display shows **3 5 0°**.
4. Press **start**. The actual oven temperature appears in the display.

IMPORTANT

If setting the oven control for a bake or delayed bake time, do so here. If not, skip this step and continue to Step 6. For “[Setting Delay Start](#)”, see [page 26](#). For “[Setting Bake Time](#)”, see [page 25](#). Remember the oven will turn off after using bake time or delay start and may only be used once during the Sabbath/Jewish holidays. The maximum bake time is 5 hours and 59 minutes.

5. The oven will turn on and begin heating.

6. Press and hold both **bake time** and **delay start** for at least 3 seconds. **SAb** will appear in the display. Once **SAb** appears in the display, the oven control will no longer beep or display any further changes, and the oven is properly set for the Sabbath feature.
7. The oven may be turned off at any time by first pressing **off** (this will turn the oven off only).
8. To turn off the Sabbath feature, press and hold both the **bake time** and **delay start** keys for at least 3 seconds. **SAb** will disappear from the display.

CAUTION

Food Poisoning Hazard. Do not let food sit for more than 1 hour before or after cooking. Doing so may result in food borne illness. Foods that can easily spoil such as milk, eggs, fish, meat, or poultry should be chilled in the refrigerator first. Even when chilled, they should not stand in the oven for more than 1 hour before cooking begins and should be removed promptly when finished cooking.

NOTE

- The cooktop is locked during the Sabbath mode.
- You may change the oven temperature once baking starts by pressing **bake** and the number keys for the new temperature. For example, to change from 350°F to 425°F, press **4 2 5**. Then, press **start** twice.
- Only the numeric keypad, bake, start, and off controls will function after setting the Sabbath feature. All other features will not function once the Sabbath feature is properly activated. The display will not show temperature changes or sound any audible tones when the oven is set with the Sabbath feature.

If power fails while using the Sabbath feature:

Should you experience a power failure or interruption, the oven will shut off. When power is returned, **SF** (Sabbath Failure) will be displayed, and the oven will not turn back on automatically. If your food was nearly fully cooked, you may allow the trapped heat in the oven to finish the cooking process. Otherwise, you should remove the food when the power failure occurs because you may only start the oven once during the Sabbath/Jewish holidays.

To turn off the Sabbath feature:

Press and hold both the **bake time** and **delay start** keys for at least 3 seconds. **SAb** will disappear from the display and the oven and cooktop may again be used with all normal functions.

Adjusting Oven Temperature

The temperature in the oven is preset at the factory. When first using the oven, be sure to follow recipe times and temperatures. If you think the oven is cooking too hot or too cool for the temperature you select, you can adjust the actual oven temperature to be more or less than what is displayed. Before adjusting, test a recipe by using a temperature setting higher or lower than the recommended temperature. The baking results should help you to decide how much of an adjustment is needed.

To adjust the oven temperature higher:

1. Press and hold **bake** for 6 seconds. **UPO 0** will appear in the display.
2. To increase the temperature, use the number keys to enter the desired change. For example, for 30°F, press **3 0**. The temperature may be increased as much as 35°F (19°C).
3. Press **start** to accept the temperature change and the display will return to the time of day. Press **off** to reject the change if necessary.

To adjust the oven temperature lower:

1. Press **bake** for 6 seconds. **UPO 0** will appear in the display.
2. To decrease the temperature, use the number keys to enter the desired change (Example -30°F) **3 0**. Then, press **self clean**. The temperature may be decreased as much as 35°F (19°C).
3. Press **start** to accept the temperature change and the display will return to the time of day. Press **off** to reject the change if necessary.

NOTE

Oven temperature adjustments made with this feature will not change the broil or self clean cycle temperatures.

The oven temperature adjustments are permanent and will stay in the unit memory unless manually changed or if all the controls are reset. Even a power outage will not reset these changes. Follow the same procedure again if you wish to change it to a different setting or use these instructions to restore default settings.

Do not use oven thermometers like those found in grocery stores to check the temperature settings inside the oven. They may display readings that vary greatly from the actual temperature.

Restoring Factory Default Setting

Your appliance is programmed with default control settings. Over time, users may make changes to these settings. The following options have settings that can be modified and may have been changed since the appliance was new:

- 12 or 24 hour display mode
- Continuous bake or 12 hour energy savings mode
- Silent or audible control
- Oven temperature display (F or C)
- Oven temperature adjustments (offsets)
- Stored recipes
- Cancel or continue cooking with meat probe option

NOTE

If you choose to restore factory default settings, all of the above user preferences will be restored to their original settings (factory default). The oven temperature adjustment will reset and any stored recipes will be cleared.

To restore oven control to factory default settings:

1. When the oven is in idle and no cooking function is in operation, press and hold the **7** key until the acceptance tone sounds (about 6 seconds).
2. Press **start**. The control is now reset to default settings.

OVEN CONTROLS

Steam Clean

The steam clean feature offers a chemical free and time-saving method to assist in the routine cleaning of your oven. Steam clean may be used before manually cleaning the oven to help loosen soils on the oven bottom.

CAUTION

Do not add ammonia, oven cleaners, or any other household cleaners or chemicals to the water used in the steam clean cycle.

Before manually cleaning any part of the oven, be sure all controls are turned off and the oven is cool. The oven may be hot and can cause burns.

To set a steam clean cycle:

1. Oven should be at room temperature. If the oven temperature is above the room temperature, steam clean will not start. Be sure the oven is cool. Remove all racks and oven accessories.
2. Scrape or wipe loose debris from the oven bottom.
3. Pour 8 oz (227 ml) distilled or filtered water onto the oven bottom (Figure 36). Close the oven door.

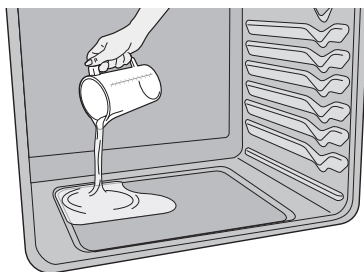

Figure 36: Add 8 ounces of distilled water

4. Press **steam clean**. **StCn** will show in the display (Figure 37).



Figure 37: Steam clean selected

5. Press **start**.
6. Steam clean is a 20 minute cycle. The display will show the time remaining.
7. An alert will sound at the end of the cycle, and the **End** message will show in the display. Press **off** to return to the clock.
8. When the steam clean cycle is complete, stand to the side of the oven out of the way of escaping vapor when opening the oven door. The cycle includes a cool-down period, so you may immediately use a soft cloth or sponge to remove any remaining water.
9. Wipe oven cavity and bottom. Do not clean oven door gasket (Figure 38).

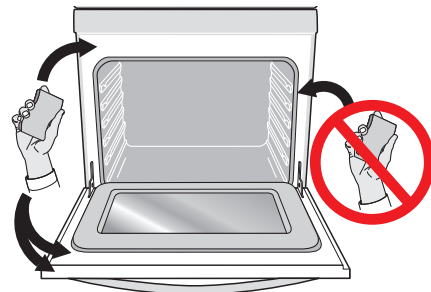

Figure 38: Clean around the oven door gasket

For best results, clean oven immediately after the cycle is complete. Steam clean works best for soils on the oven bottom. Removal of especially stubborn or baked-on soils may require a manual cleaning. See "Cleaning Various Parts of Your Oven" on page 37.

Some condensation or water vapor may appear close to the oven vent. This is normal. The oven gasket may become damp; do not wipe dry. Open door to cambered position and allow to air dry.

Local water sources often contain minerals (hard water) and will leave deposits on the oven cavity. If this occurs, wipe cavity with vinegar or lemon juice. Use distilled or filtered water.

If the door is opened during the steam clean cycle, a beep will sound and **d-0** will show in the display. Close the oven door. Keep oven door closed during steam clean cycle.

Steam clean cannot be programmed with a delay start. If steam clean results are not satisfactory, run a self clean. See "Self Cleaning Operation" on page 35.

Self Cleaning Operation

A self cleaning oven cleans itself with high temperatures that are well above normal cooking temperatures. These temperatures eliminate soils completely or reduce them to a fine powdered ash that can be wiped away with a damp cloth.

IMPORTANT

Adhere to the following cleaning precautions:

- Completely remove all oven racks and any cooking accessories from the oven to avoid damage to the racks. If oven racks are not removed before a self clean, they will lose their special coating and will no longer slide in and out of the oven cavity effortlessly.
- Remove all items from the oven and cooktop including cookware, utensils, and any aluminum foil. Aluminum foil will not withstand the high self clean temperatures.
- Do not line the oven walls, racks, bottom or any other parts of the range with aluminum foil. Doing so will alter heat distribution, produce poor baking results and may cause permanent damage to the oven interior. During self clean temperatures the oven will be hot enough to melt foil.
- Do not spray oven cleaners or protective coatings in or around any part of the oven interior.
- Clean any soil from the oven frame, door liner outside the oven door gasket, and the small area at the front center of the oven bottom with soap and water. These areas heat sufficiently to burn soil on.
- Remove any excessive spills from the oven cavity before starting the self cleaning cycle. To clean, use hot, soapy water and a cloth. Large spills can cause heavy smoke or fire when subjected to high temperatures.
- Do not allow food spills with a high sugar or acid content (milk, tomatoes, sauerkraut, fruit juices, or pie filling, etc.) to remain on surfaces. They may leave a dull spot even after cleaning.
- Do not clean the oven door gasket. Take care not to rub, damage, or remove the gasket or use any cleaning substances on the oven door gasket (Figure 38). Doing so could cause damage and reduce the efficiency of the oven's performance.

CAUTION

- Do not leave small children unattended near the appliance. During self clean, the range may become very hot to the touch.
- The oven bake and broil elements may appear to have cooled after they have been turned off. The elements may still be hot and burns may occur if these elements are touched before they have cooled.
- Use caution when opening the door after the self cleaning cycle is completed. The oven may still be very hot. Stand to the side of the oven door when opening the door to allow hot air or steam to escape.
- Do not force the oven door open when self clean is active. This can damage the automatic door locking system. Use caution when opening the door after self clean cycle is complete; the oven may still be very hot.
- The health of some birds is extremely sensitive to the fumes given off during the self cleaning cycle of any oven. Move birds to another well ventilated room.

What to Expect During Self Clean

When the oven is set to run a self clean cycle, the motor door lock will begin locking the oven door. Do not open the oven door while the lock motor is running or when any locking indicators or displays are showing. The oven door is completely locked in about 15 seconds.

While in self clean mode, the oven heats to temperatures much higher than those used in normal cooking. Sounds of metal expansion and contraction are normal.

Odors are normal as the food soil is being removed. Smoke may appear through the oven vent.

If heavy spills are not wiped up before cleaning, they may flame and cause more smoke and odor than usual. This is normal and safe and should not cause alarm. If available, use an exhaust fan during the self cleaning cycle.

OVEN CONTROLS



Setting Self Clean Cycle Duration

The **self clean** key controls the self cleaning feature. If you plan to use the oven directly after a self clean cycle, allow time for the oven to cool and the oven door to unlock. This normally takes about one hour. A 3 hour self clean cycle will actually take about 4 hours to complete.



The automatic timer will turn the oven on and off at the time you select in advance.

It is recommended to use a 2 hour self clean cycle for light soils, a 3 hour cycle for average soils, and a 4 hour cycle for heavy soils.

To set the controls for a 3 hour self cleaning cycle to start immediately and shut off automatically:

1. Be sure the clock is set with the correct time of day and the oven door is closed.
2. Press **self clean**. **CLn** and **3:00 HR** will show in the display. The control will automatically clean for a 3 hour period (default self cleaning cycle time). If a 2 or 4 hour clean time is desired, press **self clean** multiple times to toggle between 2, 3, or 4 hours.
3. Press **start**. **door Loc** will appear, a beep will sound, and the word **DOOR** and the  icon will flash; **CLn** will remain on in the display.
4. As soon as the control is set, the motor driven oven door lock will begin to close automatically. Once the door is locked, the **DOOR** indicator light and  will stop flashing and remain on, and the oven icon will appear in the display. Allow about 15 seconds for the oven door to lock completely.

When the self clean cycle is completed:



1. The oven will beep 3 times and **HOT** will appear in the display. The time of day, the word **DOOR**, and the  icon will remain in the display.
2. Once the oven has cooled for approximately 1 hour, **door OPn** will appear, and the word **DOOR** and the  icon will flash until the door unlocks. The door can be opened, and the clock display will show the time of day.

To stop or Interrupt a self cleaning cycle:

1. Press **off**.
2. The oven door can only be opened after the oven has cooled down for about 1 HOUR. **door OPn** will appear, and the word **DOOR** and the  icon will flash until the door is unlocked. The oven door can then be opened, and the clock display will revert back to the time of day.

Delay Start Self Clean

To set the control for delayed self clean (example: 3 hour self clean cycle to start at 4:30):

1. Be sure the clock is set with the correct time of day and the oven door is closed.
2. Press **self clean**. **CLn** and **3:00 HR** will show in the display. The control will automatically clean for a 3 hour period. If a 2 or 4 hour clean time is desired, press **self clean** multiple times to toggle between 2, 3, or 4 hours.
3. Press **start**. **door Loc** will appear, a beep will sound, and the word **DOOR** and the  lock icon will flash. The letters **CLn** will remain on in the display.
4. As soon as the control is set, the motor driven oven door lock will begin to close automatically. Once the door has been locked, the word **DOOR** and the  lock icon indicator light will quit flashing and remain on.
5. Press **delay start**. Enter the desired start time using the number keys **4 3 0**.
6. Press **start**. **DELAY**, **DOOR**, and the  icons will remain on.
7. The control will start the self cleaning at the set start time for the period of time previously selected. At that time, the icon **DELAY** will go out; **CLn** and oven icon will appear in the display.

When the self clean cycle is completed:

1. The oven will beep 3 times and **HOT** will appear in the display. The time of day, the word **DOOR**, and the lock icon will remain in the display.
2. When the oven cools after approximately 1 hour, **door OPn** will appear in the display and the word **DOOR** and the  icon will flash until the door is unlocked. The oven door can then be opened, and the clock display will return to the time of day.

CAUTION

To avoid possible burns, use care when opening the oven door after the self cleaning cycle. Stand to the side of the oven when opening the door to allow hot steam and air to escape.

Do not force the oven door open when self clean is active. This can damage the automatic door locking system. Use caution when opening the door after self clean cycle is complete; the oven may still be very hot.

CARE AND CLEANING

Cleaning Various Parts of Your Oven

Before cleaning any part of the oven, be sure all controls are turned off and the range is cool. Remove spills and any heavy soiling as soon as possible.

Surface Type	Recommendation
Painted and plastic control knobs Painted body parts Painted decorative trims Aluminum, Plastic, and Vinyl trim	For general cleaning, use hot, soapy water and a cloth. For more difficult soils and built-up grease, apply liquid detergent directly onto soil and let soak for 30-60 minutes. Rinse with a damp cloth and dry. Do not use abrasive cleaners on these surfaces; they can scratch.
Control panel Control keypad membrane Control panel trim	Before cleaning the control panel, turn all controls off, activate control lock (some models) and if needed remove knobs from panel (some models). Do not use abrasive cleaners on controls or trim; they can scratch. Clean using hot, soapy water and a cloth or sponge. Be sure to squeeze excess water before wiping control panel; especially when wiping around the controls area. Excess water in or around the controls may cause damage to the appliance. When rinsing, use clean water and a cloth or sponge and be sure to squeeze excess water before wiping the control panel.
Stainless Steel (some models)	Clean stainless with warm soapy water using a clean sponge or cloth. Rinse with clean water and dry with soft clean cloth. Do not use harsh scrubbing cleaners. Only use kitchen cleaners especially made for cleaning stainless steel. Rinse cleaners from the surface as bluish stains may occur during heating that cannot be removed.
Smudge Proof™ Stainless Steel (some models)	Your oven finish may be Smudge Proof™ Stainless Steel (some models). Clean the stainless with warm soapy water using a clean sponge or cloth, or a 50/50 solution of water and vinegar. Rinse with clean water and dry with a soft clean cloth. Do not use store bought cleaners like stainless steel cleaners or any other types of cleaners containing any abrasive, chlorides, chlorine, or ammonia.
Porcelain enamel parts Porcelain enamel broiler pan and insert (available by mail order)	Gentle scouring with a soapy scouring pad will remove most spots. Rinse with a 1:1 solution of clear water and ammonia. Cover difficult spots with an ammonia-soaked paper towel for 30 to 40 minutes. Rinse with clean water and damp cloth. Scrub with a soap-filled scouring pad. Rinse and wipe dry with a clean cloth. Remove all cleaners or porcelain may become damaged during future heating.
Oven interior	Remove excessive spills from oven cavity bottom before starting self clean. Clean any soils from oven frame and door liner outside the oven door gasket.
Oven racks	Oven racks must be removed from oven cavity. Clean by using a mild, abrasive cleaner following manufacturer's instructions. Rinse with clean water and dry.
Oven door	Use soap and water to thoroughly clean the top, sides and front of the oven door. Rinse well. You may use a glass cleaner on the outside glass of the oven door. Do not immerse the door in water. Do not spray or allow water or glass cleaner to enter the door vents. Do not use oven cleaners, cleaning powders or any harsh abrasive cleaning materials on the outside of the oven door. Do not clean the oven door gasket. On self cleaning models the oven door gasket is made of a woven material which is essential for a good seal. Care should be taken not to rub, damage or remove this gasket.
Ceramic Cooktop	Refer to "Cooktop Cleaning" and "Cooktop Maintenance" on page 38.

CARE AND CLEANING

Cooktop Maintenance

⚠ CAUTION

Before manually cleaning any part of the appliance, be sure all controls are turned off and the range is cool.

➔ IMPORTANT

Consistent and proper cleaning is essential to maintaining your ceramic glass cooktop.

Prior to using your cooktop for the first time, apply a ceramic cooktop cleaning cream (available in most hardware, grocery and department stores) to the ceramic surface. Clean and buff with a clean paper towel. This will make cleaning easier when soiled from cooking. Cooktop cleaning creams leave a protective finish on the glass to help prevent scratches and abrasions.

Sliding metal pans on the cooktop can cause metal markings on the cooktop surface. These marks should be removed immediately after the cooktop has cooled using the cooktop cleaning cream. Metal marks can become permanent if not removed prior to future use.

Cookware (cast iron, metal, ceramic or ceramic-coated) with rough or dirty bottoms can mark or scratch the cooktop surface.

Do not:

- slide anything across the cooktop (Figure 39).
- use cookware with dirt or dirt build-up on bottom; replace with clean cookware before using.
- use your cooktop as a cutting board or work surface in the kitchen.
- drop heavy or hard objects on the ceramic glass cooktop; they may cause it to crack.

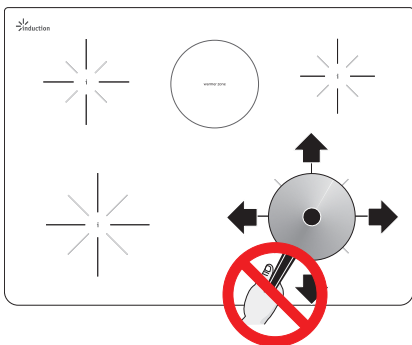

Figure 39: Do not slide pan

Cooktop Cleaning

⚠ CAUTION

Before cleaning the cooktop, be sure the controls are turned to off and the cooktop is cool.

For light to moderate soil:

Apply a few drops of glass-ceramic cooktop cleaner directly to the cooktop. Use a paper towel or use a non-abrasive plastic type cleaning pad to clean the entire cooktop surface. Make sure the cooktop is cleaned thoroughly, leaving no residue.

For heavy, burned on soil:

Apply a few drops of glass-ceramic cooktop cleaner directly to the soiled area. Rub the soiled area using a non-abrasive plastic type cleaning pad, applying pressure as needed. Do not use the pad you use to clean the cooktop for any other purpose.

If soils remain, carefully scrape soils with a metal razor blade scraper, holding scraper at a 30 degree angle to the surface (Figure 40). Remove loosened soils with cooktop cleaning cream and buff surface clean.

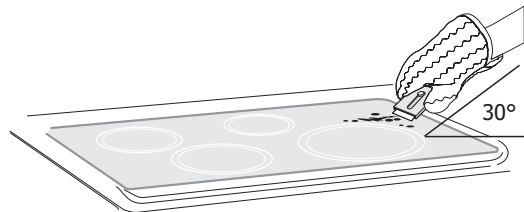

Figure 40: Cooktop cleaning

Plastic or foods with a high sugar content:

These types of soils need be removed immediately if spilled or melted onto the cooktop surface. Permanent damage (such as pitting of the cooktop surface) may occur if not removed immediately.

After turning the surface elements off, use a razor blade scraper or a metal spatula with a mitt and scrape the soil from the hot surface (as illustrated). Allow cooktop to cool, and use the same method for heavy or burned on soils.

➔ IMPORTANT

Damage to the ceramic glass cooktop may occur if using an abrasive type cleaning pad. Only use cleaning products specifically designed for ceramic glass cooktops.

! WARNING

- Do not use a cooktop cleaner on a hot cooktop. The fumes can be hazardous to your health and can chemically damage the ceramic glass surface.
- Do not use abrasive cleaners and scouring pads, such as metal and some nylon pads. They may scratch the cooktop, making it more difficult to clean.
- Do not use harsh cleaners, such as chlorine bleach, ammonia or oven cleaners, as they may etch or discolor the cooktop.
- Do not use dirty sponges, cloths or paper towels, as they can leave soil or lint on the cooktop which can burn and cause discoloration.

Aluminum Foil and Oven Liners

Protective liners—Do not use oven bottom liners or use aluminum foil to cover the oven racks. Do not use aluminum foil to line the oven bottom, except as suggested in the manual. Improper installation of these liners may result in a risk of electrical shock, or fire. Using a foil liner in the oven restricts the heat and air flow needed to obtain the best possible cooking results.

During self clean the oven temperature can become hot enough to melt aluminum cooking utensils or aluminum foil if left in the oven. This could result in permanent damage to the oven interior and porcelain finish.

Broiler Pan Cleaning Tips

To make cleaning easier, line the bottom of the broiler pan with aluminum foil. Do not cover the insert with foil. To prevent grease from baking on, remove the broiler pan from the oven as soon as cooking is completed. Use hot pads because the broiler pan is extremely hot. Pour off grease. Soak the pan in hot, soapy water. Clean the broiler pan as soon as possible after each use. If necessary, use soap-filled steel wool pads. Heavy scouring may scratch the insert.

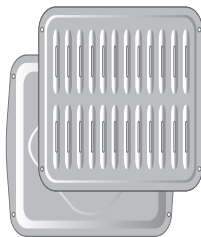

Figure 41: Broil pan and insert

Replacing the Oven Light

! CAUTION

Be sure the oven is unplugged and all parts are cool before replacing an oven light.

The interior oven lights are located at the rear of the oven cavity and are protected by glass shields. The shields must be in place whenever the oven is in use (Figure 42).

Replacing the oven interior light bulb:

1. Disconnect electrical power at the main source or unplug the appliance.
2. Remove any/all oven racks that hinder access to the oven lights.
3. Remove interior oven light shield by turning a quarter turn.
4. Pull the bulb straight out.
5. Replace defective bulb with a new T-4 type Halogen 25 watt appliance bulb.

! NOTE

Do not touch the new bulb with your fingertips when replacing. This will shorten the life of the bulb. Use a paper towel or cotton glove while handling the new bulb.

6. Reinstall the oven light shield.
7. Reconnect power at the main source (or plug the appliance back in).
8. Be sure to reset the time of day on the clock.

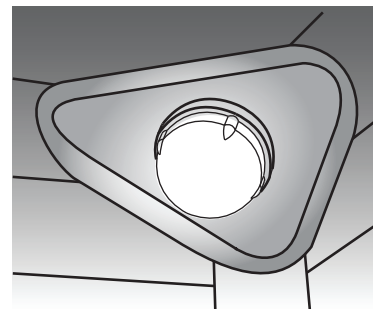

Figure 42: Wall oven halogen light

CARE AND CLEANING

Removing and Replacing the Oven Door

To remove oven door:

1. Open oven door completely, horizontal with floor (Figure 43).
2. Pull the door hinge locks on both left and right door hinges down from the oven frame completely towards the oven door (Figure 44). A tool such as a small flat-blade screwdriver may be required.
3. Firmly grasp both sides of oven door along the door sides. Do not use the oven door handle (Figure 45).
4. Close the door to the cambered stop position (the oven door will stop into this position just before fully closing).
5. Lift the oven door hinge arms over the roller pins located on each side of the oven frame (Figure 45).

To replace oven door:

CAUTION

The door is heavy. For safe, temporary storage, lay the door flat with the inside of the door facing down.

1. Firmly grasp both sides of oven door along the door sides. Do not use the oven door handle (Figure 45).
2. Holding the oven door at the same angle as the removal position, seat the hook of the hinge arm over the roller pins located on each side of the oven door frame (Figure 45 and Figure 46). The hook of the hinge arms must be fully seated onto the roller pins.
3. Fully open the oven door, horizontal with floor (Figure 43).
4. Push the door hinge locks up towards and into the oven frame on both left and right oven door hinges to the locked position (Figure 44).
5. Close the oven door.

IMPORTANT

Special door care instructions - Most oven doors contain glass that can break. Do not close the oven door until all oven racks are fully in place. Do not hit the glass with pots, pans, or any other object. Scratching, hitting, jarring, or stressing the glass may weaken its structure causing an increased risk of breakage at a later time.

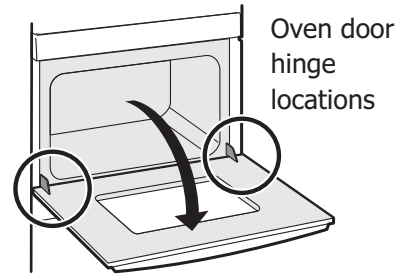

Figure 43: Door hinge location

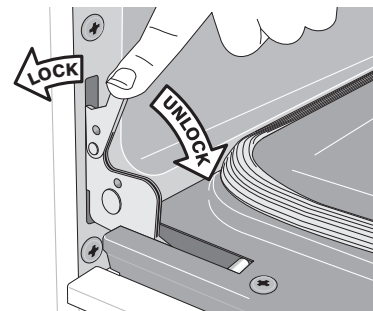

Figure 44: Door hinge locks

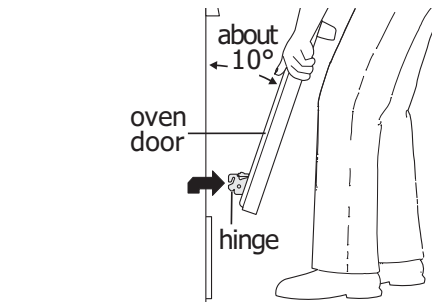

Figure 45: Holding door for removal

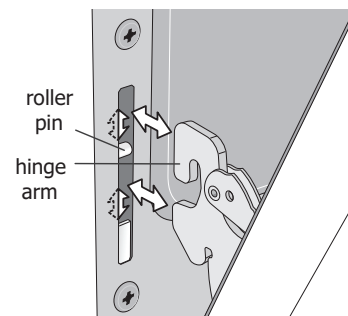







Figure 46: Replacement and location of hinge arm and roller pin

Solutions to Common Baking Problems

For best cooking results, heat the oven before baking cookies, breads, cakes, pies or pastries, etc. There is no need to preheat the oven for roasting meat or baking casseroles.

The cooking times and temperatures needed to bake a product may vary slightly from your previously owned appliance.

Baking Problems and Solutions Chart

Baking Problems	Causes	Corrections
Cookies and biscuits burn on the bottom. 	<ul style="list-style-type: none"> • Cookies and biscuits put into oven before the preheating time is completed. • Oven rack is overcrowded. • Dark pans absorb heat too fast. 	<ul style="list-style-type: none"> • Allow oven to preheat to desired temperature before placing food in oven. • Choose pan sizes that permit 2" to 4" (5.1 cm to 10.2 cm) space on all sides when placed in the oven. • Use a medium weight baking sheet.
Cakes too dark on top or bottom. 	<ul style="list-style-type: none"> • Cakes put in oven before preheating time is completed. • Rack position too high or too low. • Oven too hot. 	<ul style="list-style-type: none"> • Allow oven to preheat to the selected temperature before placing food in the oven. • Use proper rack position for baking needs. • Set oven temperature 25°F (13°C) lower than recommended.
Cakes not done in center. 	<ul style="list-style-type: none"> • Oven too hot. • Incorrect pan size. • Pan not centered in oven. 	<ul style="list-style-type: none"> • Set oven temperature 25°F (13°C) lower than recommended. • Use pan size suggested in recipe. • Use proper rack position and place pan to allow 2" to 4" (5.1 cm to 10.2 cm) space on all sides of pan.
Cakes not level. 	<ul style="list-style-type: none"> • Range not level. • Pan too close to oven wall or rack overcrowded. • Pan warped. • Oven light left on during baking. 	<ul style="list-style-type: none"> • Place a marked glass measuring cup filled with water on the center of the oven rack. If the water level is uneven, refer to the installation instructions for leveling the range. • Be sure to allow 2" to 4" (5.1 cm to 10.2 cm) clearance on all sides of each pan in the oven. • Do not use pans that are dented or warped. • Do not leave oven light on while baking.
Foods not done when cooking time is over. 	<ul style="list-style-type: none"> • Oven too cool. • Oven overcrowded. • Oven door opened too frequently. 	<ul style="list-style-type: none"> • Set oven temperature 25°F (13°C) higher than suggested and bake for the recommended time. • Be sure to remove all pans from the oven except the ones to be used for baking. • Open oven door only after shortest recommended baking time.

BEFORE YOU CALL

Solutions to Common Problems:

Before calling for service, review the list below to save time and expense. Problems and possible solutions are provided.

Problem	Solution
Oven control panel beeps and displays F or E error codes.	Oven control has detected a fault or error condition. Press the off key to clear the error code. Press bake or broil function. If the F or E code error repeats, turn off power to the appliance, wait 5 minutes, and then reapply power. Set clock with correct time of day. Try bake or broil again. If fault recurs, press off and call for service.
Poor baking results.	<p>Many factors effect baking results. Use proper oven rack position. Center food in the oven and space pans to allow air to circulate. Preheat oven to the set temperature before placing food in the oven. Try adjusting the recipe's recommended temperature or baking time. See "Adjusting Oven Temperature" on page 33 if you feel the oven is too hot or cold.</p> <p>In your oven is cooking poorly, perform the following check: Press broil: 550 should be displayed. Place your hand near the handle on the oven door. Between the door and the control panel you should feel a rush of air on your hand. If so, your unit is functioning properly and you have had a power failure in your home. If no air rush happens, call a service technician to replace your cooling fan.</p>
Appliance is not level	<p>Be sure floor is level, strong and stable enough to adequately support range. If floor is sagging or sloping, contact a carpenter to correct the situation.</p> <p>Poor installation. Place oven rack in center of oven. Place a level on the oven rack. Adjust leveling legs at base of appliance until the oven rack is level.</p> <p>Kitchen cabinet alignment may make range appear not level. Be sure cabinets are square and have sufficient room for appliance clearance.</p>
Cannot move appliance easily/ Inaccessible for service	<p>Cabinets not square or are built in too tightly. Contact builder or installer to make appliance accessible.</p> <p>Carpet interferes with appliance. Provide sufficient space so appliance can be lifted over carpet</p>
Flames inside oven or smoking from oven vent.	Excessive spills in oven. Grease or food spilled onto oven bottom or oven cavity. Wipe up excessive spills before starting oven. If flames or excessive smoke are present when using broil, see " Setting Broil " on page 27 .
Self clean does not work.	Oven control not set properly. See " Self Cleaning Operation " on page 35 .
Oven light does not work.	Be sure the oven light is secure in the socket. See " Replacing the Oven Light " on page 39 .
Surface cookware seems too hot or not hot enough	Incorrect induction cooktop power level setting. Adjust power level setting higher or lower as needed.
Areas of discoloration with a metallic sheen	Mineral deposits from water and food. Remove using a ceramic glass cooktop cleaning creme. Use cookware with clean, dry bottoms.
Brown streaks or specks on the cooktop.	Boil overs are cooked onto surface. Use razor blade scraper to remove soil. See " Cooktop Cleaning " on page 38 .
Convection fan does not rotate.	Oven door is open. Convection fan will turn off if oven door is opened when convection is active. Close oven door.
Fan noise occurring after the oven is turned off.	Some models are equipped with a cooling fan that runs during the cooking process to cool internal electronic components. It is normal for this fan to continue to run for an extended period of time, even when the oven is off.

BEFORE YOU CALL

Metal marks on the cooktop.	Sliding or scraping metal utensils on cooktop surface. Do not slide metal utensils on cooktop surface. Use a ceramic-glass cooktop cleaning creme to remove the marks. See “Cooktop Cleaning” on page 38.
Cooking zones do not glow when heating.	The induction cooking zones do not glow even when they are hot. Induction cooking uses electromagnetic energy to induce heat directly to the cookware.
Induction cooking zone does not heat cookware or does not heat evenly	<p>Be sure the correct surface control is activated for the cooking zone.</p> <p>Be sure to use the correct cookware material type for induction cooking. Use cookware specifically identified by the manufacturer to use for induction cooking. If you're not sure, use a magnet to test whether the cookware type will work. If a magnet sticks to the bottom of the cookware, the material type is correct for induction cooking.</p> <p>Be sure to read about pan-sensing in the Induction Cooking section and correct any pan-sensing issues in the checklist provided. Use quality heavier gauge cookware.</p>
Soil not completely removed after self clean.	<p>Self clean was interrupted. Review instructions on “Self Cleaning Operation” on page 35.</p> <p>Excessive spills on oven bottom. Clean before starting self clean.</p> <p>Failure to clean soil from the oven frame, the door liner outside the oven door gasket, and the small area at the front center of the oven bottom. These areas are not in the self cleaning area, but get hot enough to burn on residue. Clean these areas before starting the self cleaning cycle. Burned-on residue can be cleaned with a stiff nylon brush and water or a nylon scrubber. Be careful not to damage the oven gasket.</p> <p>If self clean is performing poorly, perform the following check: Press broil: 550 should be displayed. Place your hand near the handle on the oven door. Between the door and the control panel you should feel a rush of air on your hand. If so, your unit is functioning properly and you have had a power failure in your home. If no air rush happens, call a service technician to replace the cooling fan.</p>
Oven portion of appliance does not operate	Be sure the oven controls are set properly for the desired cooking feature. See “Running H/F 2” in this manual or read the instructions “Entire appliance does not operate” in this checklist.
Oven smokes excessively when broiling.	<p>Incorrect setting. Follow the “Setting Broil” instructions on page 27.</p> <p>Meat too close to the broil element. Reposition broil rack to provide proper clearance between the meat and broil element. Remove excess fat from meat. Cut remaining fatty edges to prevent curling, but do not cut into lean.</p> <p>Grease build up on oven surfaces. Regular cleaning is necessary when broiling frequently. Grease or food splatters will cause excessive smoking.</p>
Scratches or abrasions on cooktop surface	Coarse particles such as salt or sand between cooktop and utensils can cause scratches. Be sure cooktop surface and bottoms of utensils are clean before usage. Small scratches do not affect cooking and will become less visible with time. Cleaning materials not recommended for ceramic glass cooktop have been used. See “Cooktop Cleaning” on page 38. Cookware with rough bottom has been used. Use smooth, flat bottomed cookware.
Entire appliance does not operate.	The time of day is not set. The oven clock must first be set in order to operate the oven. Be sure oven controls are set properly. Review instructions for the desired cooking function in this manual. Service wiring is not complete.
Oven racks discolored or do not slide easily.	Oven racks left in oven cavity during self clean. Remove oven racks from oven cavity before starting a self-clean cycle. Clean by using a mild abrasive cleaner following manufacturer's instructions. Rinse with clean water, dry, and replace in oven.

WARRANTY

Your appliance is covered by a one year limited warranty. For one year from your original date of purchase, Electrolux will pay all costs for repairing or replacing any parts of this appliance that prove to be defective in materials or workmanship when such appliance is installed, used and maintained in accordance with the provided instructions.

Exclusions

This warranty does not cover the following:

1. Products with original serial numbers that have been removed, altered or cannot be readily determined.
2. Product that has been transferred from its original owner to another party or removed outside the USA or Canada.
3. Rust on the interior or exterior of the unit.
4. Products purchased "as-is" are not covered by this warranty.
5. Food loss due to any refrigerator or freezer failures.
6. Products used in a commercial setting.
7. Service calls which do not involve malfunction or defects in materials or workmanship, or for appliances not in ordinary household use or used other than in accordance with the provided instructions.
8. Service calls to correct the installation of your appliance or to instruct you how to use your appliance.
9. Expenses for making the appliance accessible for servicing, such as removal of trim, cupboards, shelves, etc., which are not a part of the appliance when it is shipped from the factory.
10. Service calls to repair or replace appliance light bulbs, air filters, water filters, other consumables, or knobs, handles, or other cosmetic parts.
11. Surcharges including, but not limited to, any after hour, weekend, or holiday service calls, tolls, ferry trip charges, or mileage expense for service calls to remote areas, including the state of Alaska.
12. Damages to the finish of appliance or home incurred during installation, including but not limited to floors, cabinets, walls, etc.
13. Damages caused by: services performed by unauthorized service companies; use of parts other than genuine Electrolux parts or parts obtained from persons other than authorized service companies; or external causes such as abuse, misuse, inadequate power supply, accidents, fires, or acts of God.

DISCLAIMER OF IMPLIED WARRANTIES; LIMITATION OF REMEDIES

CUSTOMER'S SOLE AND EXCLUSIVE REMEDY UNDER THIS LIMITED WARRANTY SHALL BE PRODUCT REPAIR OR REPLACEMENT AS PROVIDED HEREIN. CLAIMS BASED ON IMPLIED WARRANTIES, INCLUDING WARRANTIES OF MERCHANTABILITY OR FITNESS FOR A PARTICULAR PURPOSE, ARE LIMITED TO ONE YEAR OR THE SHORTEST PERIOD ALLOWED BY LAW, BUT NOT LESS THAN ONE YEAR. ELECTROLUX SHALL NOT BE LIABLE FOR CONSEQUENTIAL OR INCIDENTAL DAMAGES SUCH AS PROPERTY DAMAGE AND INCIDENTAL EXPENSES RESULTING FROM ANY BREACH OF THIS WRITTEN LIMITED WARRANTY OR ANY IMPLIED WARRANTY. SOME STATES AND PROVINCES DO NOT ALLOW THE EXCLUSION OR LIMITATION OF INCIDENTAL OR CONSEQUENTIAL DAMAGES, OR LIMITATIONS ON THE DURATION OF IMPLIED WARRANTIES, SO THESE LIMITATIONS OR EXCLUSIONS MAY NOT APPLY TO YOU. THIS WRITTEN WARRANTY GIVES YOU SPECIFIC LEGAL RIGHTS. YOU MAY ALSO HAVE OTHER RIGHTS THAT VARY FROM STATE TO STATE.

If You Need Service

Keep your receipt, delivery slip, or some other appropriate payment record to establish the warranty period should service be required. If service is performed, it is in your best interest to obtain and keep all receipts. Service under this warranty must be obtained by contacting Electrolux at the addresses or phone numbers below.

This warranty only applies in the USA and Canada. In the USA, your appliance is warranted by Electrolux Major Appliances North America, a division of Electrolux Home Products, Inc. In Canada, your appliance is warranted by Electrolux Canada Corp. Electrolux authorizes no person to change or add to any obligations under this warranty. Obligations for service and parts under this warranty must be performed by Electrolux or an authorized service company. Product features or specifications as described or illustrated are subject to change without notice.

USA
1.800.944.9044
Electrolux Home Products, Inc.
10200 David Taylor Drive
Charlotte, NC 28262



Canada
1.800.265.8352
Electrolux Canada Corp.
5855 Terry Fox Way
Mississauga, Ontario, Canada
L5V 3E4