

Monogram™

Installation

Instructions

Built-In Refrigerators

36" Models:

ZISW36DY

ZISB36DY

ZIS36NY

42" Models:

ZISW42DY

ZISB42DY

ZIS42NY

48" Models:

ZISW48DY

ZISB48DY

ZIS48NY

Introduction

Monogram™ refrigerators are designed to blend into the kitchen cabinetry. Through a series of product and trim kit choices, the Monogram™ refrigerator can be beautifully integrated into the kitchen.

All models require field-installed custom panels. Lexan® and Stainless Steel Panel Kits are available. Custom Trim kits for handles, 3/4" thick panels and dispenser trim are also available. Order these from your Monogram dealer.

Lexan® and Stainless Steel Panel Kits:

Model	Black Lexan®	White Lexan®	Stainless Steel
ZIS36NY	ZWBP36	ZWWP36	ZWSP36
ZISW36DY/ZISB36DY	ZWBP36D	ZWWP36D	ZWSP36D
ZIS42NY	ZWBP42	ZWWP42	ZWSP42
ZISW42DY/ZISB42DY	ZWBP42D	ZWWP42D	ZWSP42D
ZIS48NY	ZWBP48	ZWWP48	ZWSP48
ZISW48DY/ZISB48DY	ZWBP48D	ZWWP48D	ZWSP48D

Custom Trim Kits:

ZKH1

Provides for the installation of a custom handle on standard 1/4" custom panels.

ZG1

Provides 1/4" grille panel frame side pieces. To be used when installation height is more or less than factory set 84" height.

ZKT48, ZKT42, ZKT36

Provides for the installation of 3/4" custom door and grille panels, using the standard full length handle.

ZKHT1

Provides for the installation of a custom handle using 3/4" door and grille panels. This kit must be used in conjunction with ZKT48, ZKT42 and ZKT36.

ZWCD1

For 36" and 42" wide models. Provides for the installation of a custom collar trim on the dispenser for one continuous custom panel on freezer door. This kit can be used alone, or with all other kits.

ZWCD2

For 48" wide models. Provides for the installation of a custom collar trim on the dispenser for one continuous custom panel on freezer door. This kit can be used alone, or with other kits.

Important Notes:

Custom door and grille panel sizes vary to accommodate the trim kit being used. See Custom Options Guide for panel sizes and details.

Maximum weight for fresh food panels is 50 pounds and 30 pounds for freezer door panels.

Contents

Installation/Appearance Examples	3, 4	Step 7: Connect Water Supply	10
Set Up Preparation		Step 8: Connect Power	10
Electric & Water Locations	5	Step 9: Mount 1/4" Top Grille Panel	10
Product Dimensions	5	Door Panel Dimensions	11
Grounding the Appliance	6	Panels Secured to 1/4" Backing.....	11
Anti-Tip Precautions	6	Standard 1/4" Door Trim Template	11
Tools Required	6	Step 10: Install Door Panels	12
Hardware Supplied	6	Step 11: Arrange interior	13
Hardware Required	6	Step 12: Set Temperature Controls	13
Flooring	6	Step 13: Start Icemaker	13
Door Clearances	6	Step 14: Install Toekick	14
Installation Instructions		Problem Solving	15
Step 1: Remove Packaging	7		
Step 2: Prepare water line	7		
Step 3: Install Side Panels	8		
Step 4: Roll Unit into Opening	8		
Step 5: Level Refrigerator	8		
Step 6: Secure Refrigerator case trim to side panels	9		

Monogram™ Built-In Refrigerator Installation/Appearance Examples

The finished and rough-in dimensions are determined by the type of installation being made. The following illustrations will demonstrate the basic options.

If you have a unique installation, (other than those illustrated here) use the product dimensions shown on page 5 to calculate your rough-in dimensions.

Side panels are required whenever the sides of the refrigerator will be exposed.

If a custom enclosure has been made and installed, or if you are installing between pantry and oven cabinets, side panels are not required.

For a flush appearance, the custom enclosure cutout should be:
 84" H x 36" W x 24-3/4" D, for 36" models.
 84" H x 42" W x 24-3/4" D, 42" models.
 84" H x 48" W x 24-3/4" D, 48" models.

The finished appearance of your installation is determined by the depth of the side panels. The distance between side panels is the finished cutout.

Installation Between Base & Wall Cabinets

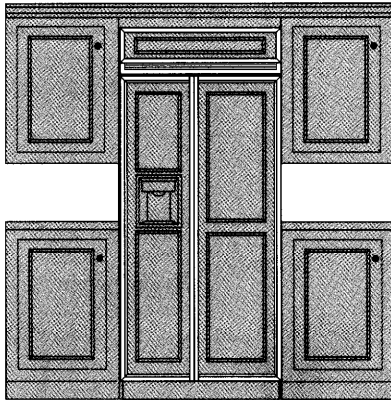

Appearances and cutout dimensions are the same for both dispenser and non-dispenser models.

36" Wide Models

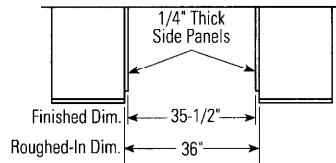

42" Wide Models

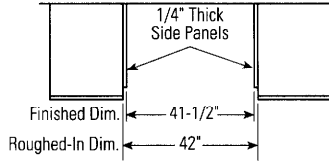

48" Wide Models

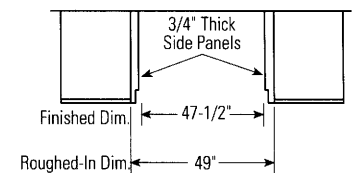
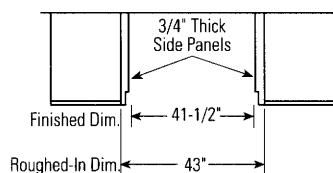
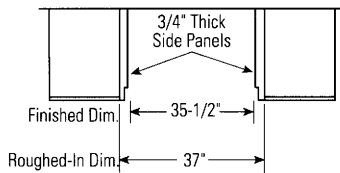
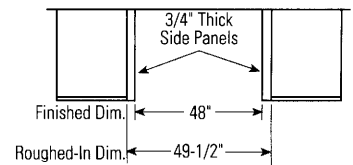
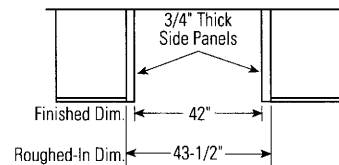
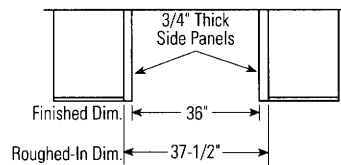
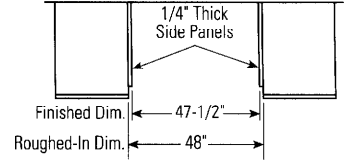

Notching the front edge of the side panel (1/4" deep) creates a smaller space between cabinet door and adjacent refrigerator door panels.

*Installation
At End-of-Run
Base & Wall
Cabinets*

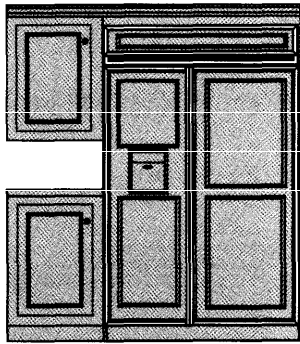

36" Wide Models

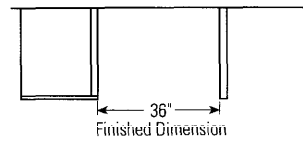

42" Wide Models

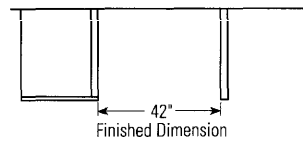

48" Wide Models

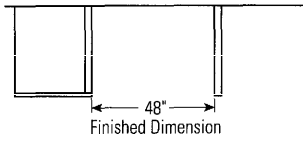

*Installation
Between
Wall Oven
and Pantry
Cabinet*

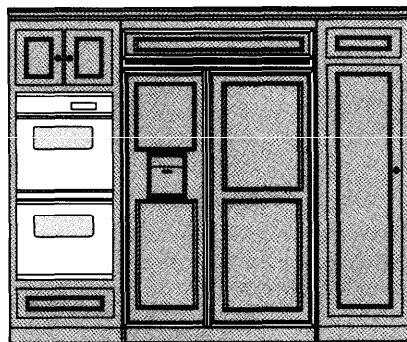

If a custom enclosure has been made and installed, or if you are installing between pantry and oven cabinets, side panels are not required.

For a flush appearance, the custom enclosure, cutout should be:
84" H x 36" W x 24-3/4"D, for 36" models.
84" H x 42" W x 24-3/4"D, 42" models.
84" H x 48" W x 24-3/4"D, 48" models.

EXCEPT:

Side panels, 1/2" minimum thickness, are required when using **frameless cabinets**.

36" Wide Models

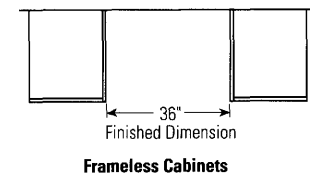
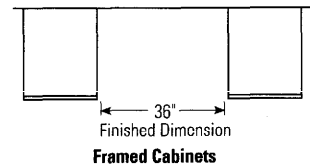

42" Wide Models

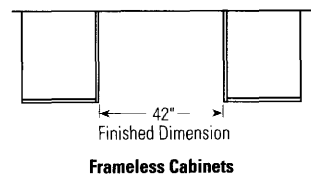
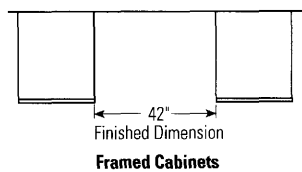

48" Wide Models

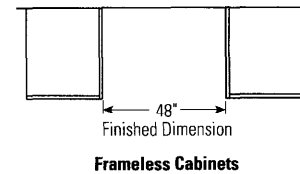
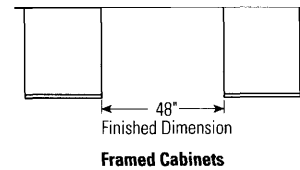

Monogram™ Built-In Refrigerator Set up Preparation

Before you begin – Read these instructions completely and carefully.

IMPORTANT – Save these instructions for local inspector's use.

IMPORTANT – OBSERVE ALL GOVERNING CODES AND ORDINANCES.

Note to Installer – Be sure to leave these instructions with the Consumer.

Note to Consumer – Keep these instructions with your Use and Care Book for future reference.

Electric and Water Connection Locations

Water line can be routed through the floor or back wall.

- Water line should be:
 - Approximately 3-1/2" from the floor on the back wall, or 3-1/2" from the back wall on the floor.
 - At least 5" from either side.

A 115 volt, 60 Hz., 15 or 20 amp power supply is required. An individual properly grounded branch circuit or circuit breaker is recommended, as noted on the rating plate. The rating plate is located on the bottom of the cabinet front of the fresh food compartment and is visible when the door is opened.

- Locate the electrical outlet within 5" x 7" shaded area is illustrated. From the right side:
 - 12-3/8" for 36" wide models.
 - 18-3/8" for 42" wide models.
 - 20-3/8" for 38" wide models.
- Between 74" and 81" from the floor.

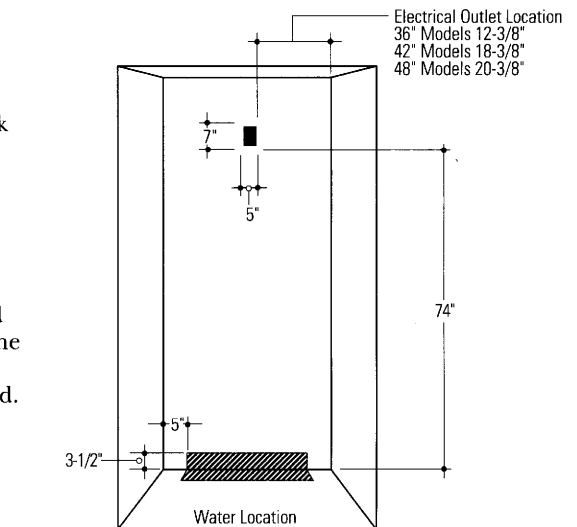

Product Dimensions

36" Models

A–36" outside trim width

B–35" case trim

42" Models

A–42" outside trim width

B–41" case trim

48" Models

A–48" outside trim width

B–47" case trim

All 36", 42" and 48" Wide Models

C–10-3/4"

D–72-1/4"

E–83"

F–24-3/4"

G–4"

G–4"

These models are designed to be installed flush with surrounding cabinetry. Cutout dimensions and clearances are determined by the many installation options available.

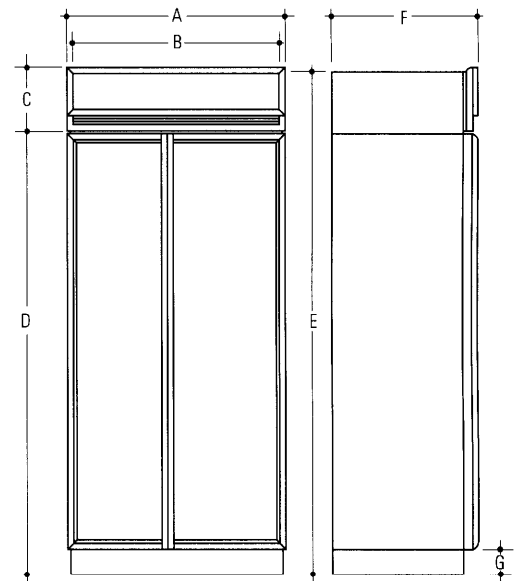

Caution: Refrigerators are much heavier at the top than at the bottom—be extra careful when moving.

Grounding the Appliance

IMPORTANT—(Please read carefully)
FOR PERSONAL SAFETY, THIS APPLIANCE MUST BE PROPERLY GROUNDED.

The power cord of this appliance is equipped with a three-prong (grounding) plug which mates with a standard three-prong grounding wall receptacle to minimize the possibility of electric shock hazard from this appliance.

If the electrical service provided does not meet the above specifications, it is recommended that a licensed electrician install an approved outlet.

DO NOT, UNDER ANY CIRCUMSTANCES, CUT OR REMOVE THE THIRD (GROUND) PRONG FROM THE POWER CORD.

DO NOT USE AN EXTENSION CORD WITH THIS APPLIANCE.

DO NOT USE AN ADAPTOR PLUG WITH THIS APPLIANCE.

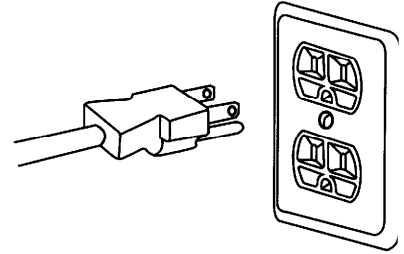

Tools Required

- | | | | |
|---|---|--|--|
| <ul style="list-style-type: none"> • Tinsnips to cut banding • Stepladder • Bucket | <ul style="list-style-type: none"> • Level • Appliance Hand Truck • Tubing cutter • 7/16" open-end wrench | <ul style="list-style-type: none"> • #2 Phillips screwdriver • Stubby Phillips screwdriver • Drill and appropriate bits | <ul style="list-style-type: none"> • 7/16" socket with 3" extension for ratchet • Safety glasses |
|---|---|--|--|

Hardware Supplied

- | | | |
|--|--|--|
| <ul style="list-style-type: none"> • 1-1/2" stamped open-end wrench | <ul style="list-style-type: none"> • Special plastic fastener adhesive strips | <ul style="list-style-type: none"> • 1/4" panel foam spacers • 1/4-1/4 union with nuts |
|--|--|--|

Hardware Required

- | | | | |
|---|---|---|--|
| <ul style="list-style-type: none"> • Water shut-off valve (optional but recommended) | <ul style="list-style-type: none"> • Water filter WR97X0214 (optional but recommended) | <ul style="list-style-type: none"> • Custom panel for fresh food and freezer compartments. | <ul style="list-style-type: none"> • Side panels (see page 8) • Hardware for side panel installation |
|---|---|---|--|

Flooring

For proper installation, this unit must be placed on a level surface of hard material that is at the same height as the rest of the flooring. This surface should be strong enough to support a fully loaded refrigerator.

CAUTION: Protect the finish of the flooring. Cut a large section of the cardboard carton, lay on the floor in the area where you are working.

Door Clearance Required

If the refrigerator is to be installed in a corner:

- A 2" min. clearance between the case trim and adjacent wall on both sides of the refrigerator will assure a 90° door opening and access to all drawers. An 8" clearance is required on both sides for removal of pans.

Built-In Refrigerator Installation Steps

Step 1 Remove Packaging

CAUTION: Refrigerator is much heavier at the top than at the bottom—be careful when moving.

- Remove outer carton.
 - Carefully cut banding at top and bottom.
 - Remove top cap.
 - Slide out back corner posts (2).
 - Slide carton off top of cabinet.
- Remove toekick from back of refrigerator and set aside for later installation.
- Remove grille panel frame from front of door, set aside for later installation.

NOTE: IT IS NOT NECESSARY TO LAY CABINET DOWN IN ORDER TO REMOVE SKID!

- To remove skid, remove the four 7/16" bolts and their brackets.

CAUTION: DO NOT ATTEMPT TO ROLL UNIT OFF SKID.

- There are support blocks on the bottom of cabinet and door. They must be removed before rolling unit off skid or damage will occur.
- Carefully tilt cabinet and slide blocks out from underneath cabinet, slide unit off skid.
When using a hand-truck, handle from side only.

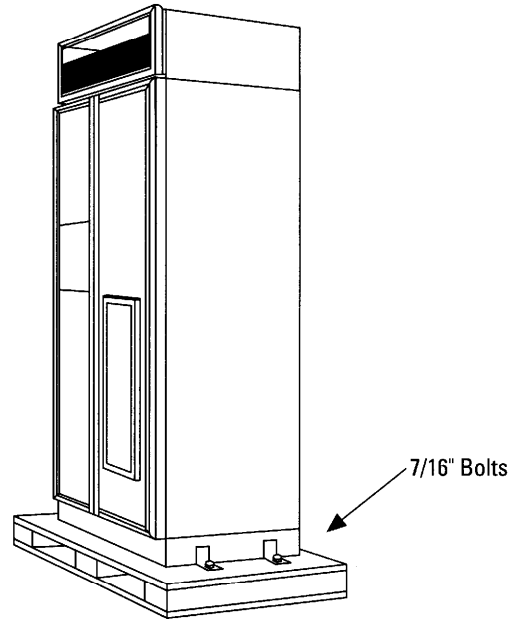

Step 2 Prepare Water Line

- Route 1/4" OD copper tubing between house cold water line and the water connection location.
- Copper tubing should be long enough to extend to the front of the refrigerator. Allow enough to accommodate bend leading into the water valve.
- Install a shut-off valve between the icemaker water valve and cold water pipe in the basement or a cabinet. The shut-off valve should be located where it will be easily accessible.

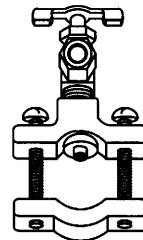
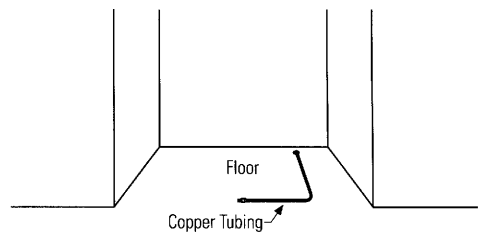

Step 3

Install Side Panels

Decorator side panels are required wherever the sides of the refrigerator will be exposed. Side panel installation will be determined by the design of the side panel you have previously chosen. Side panels are normally set into place and fastened to adjacent cabinetry or the back wall before rolling unit into opening. If you choose to use 1/4" side panels, they should be fastened to the refrigerator before setting refrigerator into place. See Illustration A. If you choose to use 1/2" to 3/4" side panels, see Illustrations B and C.

If a custom refrigerator enclosure has been made and installed, or if you are installing between pantry and oven cabinets, side panels are not required. Check finished hole size as determined by previous instructions.

To cover entire side of the refrigerator: Cut panels 84" high, 23-5/16 to 24-3/4" wide. Height and width of the panels will vary depending on installation method.

Make sure side panels are installed plumb. See *Custom Options Guide* for more details.

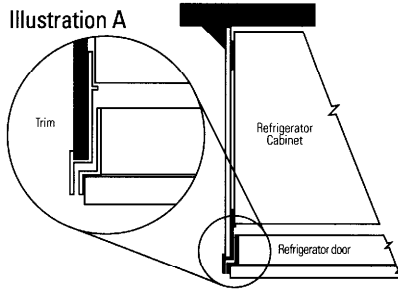

1/4" Side Panels – Insert end of side panel into case trim. Fasten with velcro strips included.

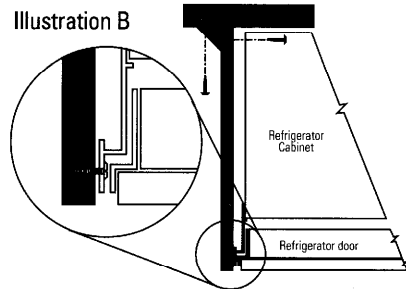

1/2" to 3/4" Side Panels – Leading edge of side panel is flush with cabinet front. Fasten to the back wall using a cleat.

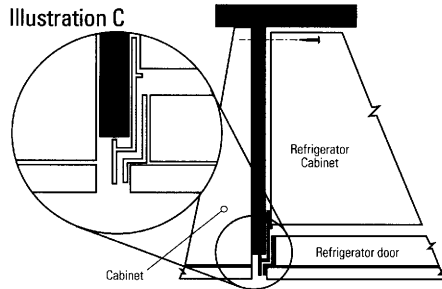

1/2" to 3/4" Side Panels – Recessed front edge of side panel. Fasten to adjacent cabinet.

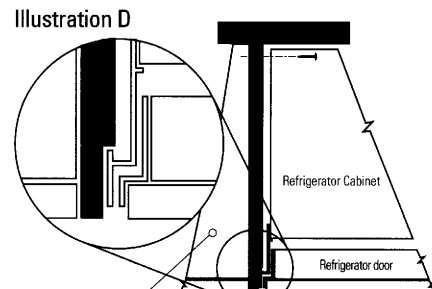

1/2" to 3/4" Side Panels – Leading edge of side panel is routed 1/4" deep, 1-1/2" wide. Fasten to adjacent cabinet.

Step 4

Roll Unit into Opening

With cardboard protective pad in position, use a handtruck to roll refrigerator into the front of the location cut-out.

Step 5

Level Refrigerator

All models have 4-point leveling. The front is supported by leveling legs, the back is supported by rear wheels.

- To level the back of the unit, turn the 7/16" hex nut located above the rear wheels.
- For front leveling, use the 1-1/2" open-end wrench (provided).
- Turn hex nut or front leveling leg to raise or lower the refrigerator.
- Adjust carefully, the refrigerator should be level and plumb with cabinetry, and should align with toekick height.

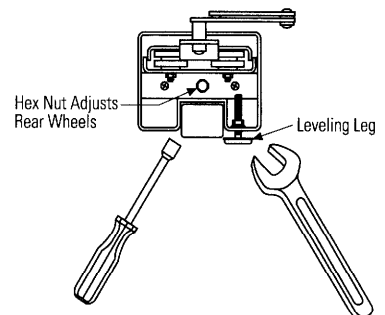

Step **6**

Secure Refrigerator case trim to side panel

WARNING

Anti-Tip Precautions

Personal Injury/Property Damage Hazard

The refrigerator is much heavier at the top. To prevent the refrigerator from tipping over you must:

- Install a wood block, the full width of the refrigerator. Secure the block with wood screws penetrating at least 3/4" into wall studs.

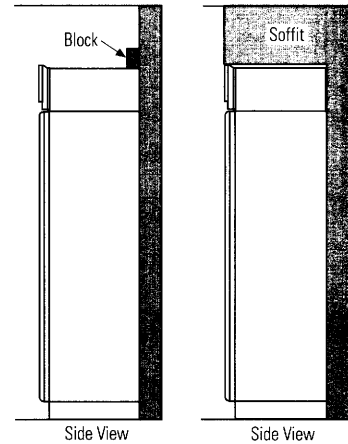

When using 1/2" to 3/4" side panels, the front flange of the case trim is attached to the side panel.

- Open freezer door to access case trim.
- Drill hole in flange and drive screw through the flange, into the side panel.
- Follow the same procedure for fresh food side.

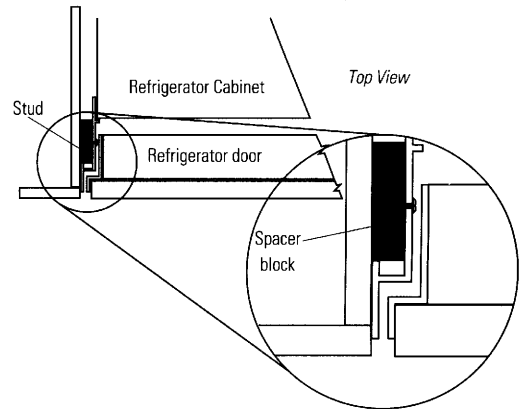

OR

If refrigerator is installed between cabinets with no side panels or in a custom enclosure, install a spacer block as shown.

- Open freezer door to access case trim.
- Drill hole in trim and drive screw through the trim and into the spacer block.
- Follow the same procedure for fresh food side.

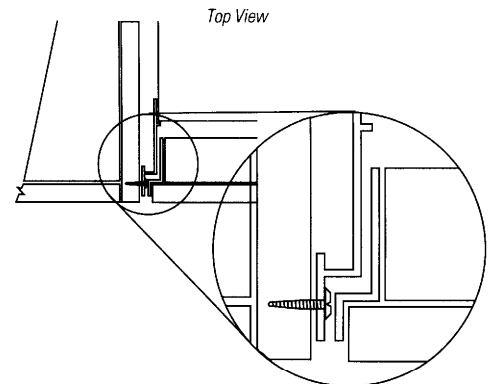

Step **7**

Connect Water Supply

- Locate and bring copper tubing to front of cabinet.
- Turn water on to flush debris from line, run about a quart of water through tubing into a bucket, then shut off water.
- Slip a 1/4-1/4 union nut (provided) over both ends of the copper tubing at the right front leg of the refrigerator and couple the lines.
- Turn on water to check for leaks.

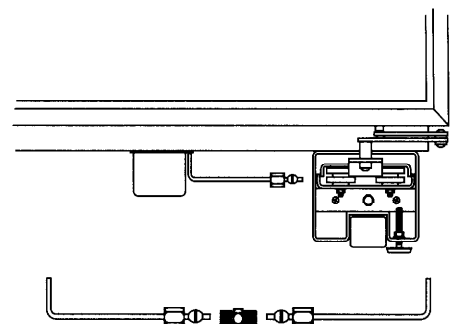

Step **8**
Connect
Power

- Connect refrigerator power cord plug to properly grounded receptacle, accessible through the top right side of the hood opening.
- Check to make sure power to refrigerator is on by opening refrigerator door to see if interior lights are on.

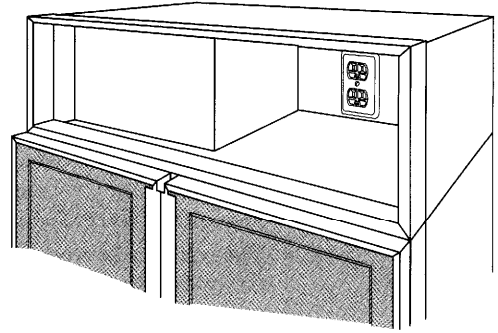

Step **9**
Mount 1/4"
Top Grille
Panel

If you are using 3/4" thick custom panels, SKIP THIS STEP. See *Custom Options Guide* for grille panel sizes. Order the ZKT kit for your model, and follow the installation instructions packed with the kit.

The grille panel frame is factory assembled for 84" installation height. If installation height varies, order ZG1 trim kit which provides optional side trim pieces. Cut custom, Lexan® or stainless panel to sizes shown below.

Models	Installation Height	Panel Height	Panel Width
36" wide	83"	8"	35"
42" wide	83-1/2"	8-1/2"	41"
48" wide	84-1/2"	9-1/2"	47"

The grille panel frame for the top grille is shipped with the unit.

The refrigerator is shipped with the top case trim secured at the 83" refrigerator height.

- Loosen 2 screws on both sides and raise the case trim to meet soffit height, from 83" to 84-1/2".
- Tighten all 4 screws.

To insert decorative grille panel into the frame:

- Remove 2 screws (one each in top corners) as shown.
- Slide panel into the frame and reassemble.
- Mount panel grille by dropping into the slots on the case trim.

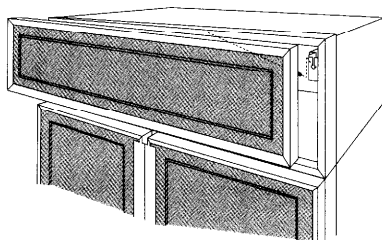
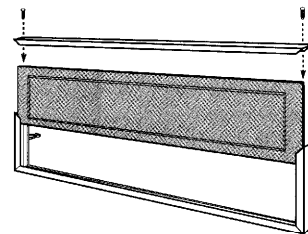
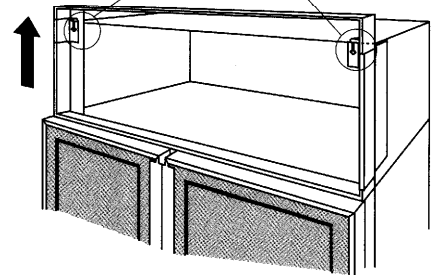
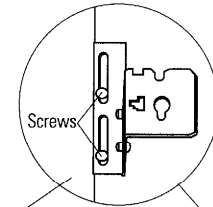

Important: Maintain 1-1/2" min. gap between top of doors and bottom of panel frame.

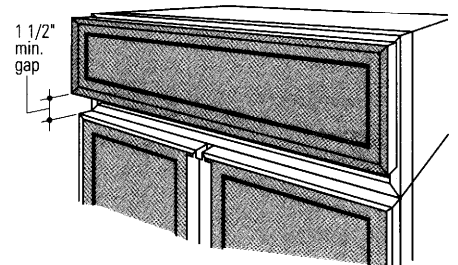

*Door
Panel
Dimensions*

All models require field-installed panels. Lexan® and stainless steel panel kits are sized to fit your model. If you are using custom panels, cut the panels to the sizes shown for your model.

1/4" CUSTOM PANEL DIMENSIONS

Model	Non-Dispenser Freezer Panel (WxH)	Dispenser Freezer Panel (WxH)		Fresh Food Panel (WxH)
		Upper	Lower	
ZIS36NY	15-1/4"x67-7/8"			19-1/4"x67-7/8"
ZISW36DY ZISB36DY		15-1/4"x16-5/8"	15-1/4"x36-7/8"	19-1/4"x67-7/8"
ZIS42NY	15-1/4"x67-7/8"			25-1/4"x67-7/8"
ZISW42DY ZISB42DY		15-1/4"x16-5/8"	15-1/4"x36-7/8"	25-1/4"x67-7/8"
ZIS48NY	19-1/4"x67-7/8"			27-1/4"x67-7/8"
ZISW48DY ZISB48DY		19-1/4"x16-5/8"	19-1/4"x36-7/8"	27-1/4"x67-7/8"

*Panels
Secured
to 1/4"
Backing*

If you are using custom panels secured to 1/4" thick backing, the same panel sizes apply. However, the raised portion of the panel requires trim, hinge and fingertip clearances. Allow 5/16" clearance on the top and bottom for trim flange. Allow 1-1/4" clearance on hinge side to avoid striking adjacent cabinetry. Allow 2" on handle side for fingertip clearance.

Countertops adjacent to refrigerator installation should be mitered 45° degrees.

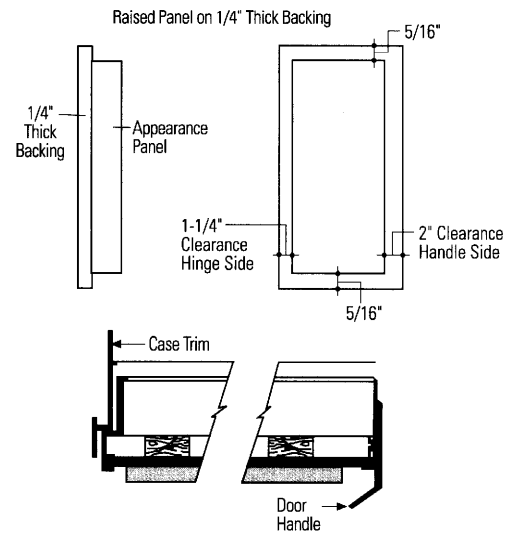

*Standard
1/4" Door
Trim
Template*

This illustration represents the actual size of the 1/4" door trim and standard handle section. Use this to determine how stile and rail sections interface with the door trim.

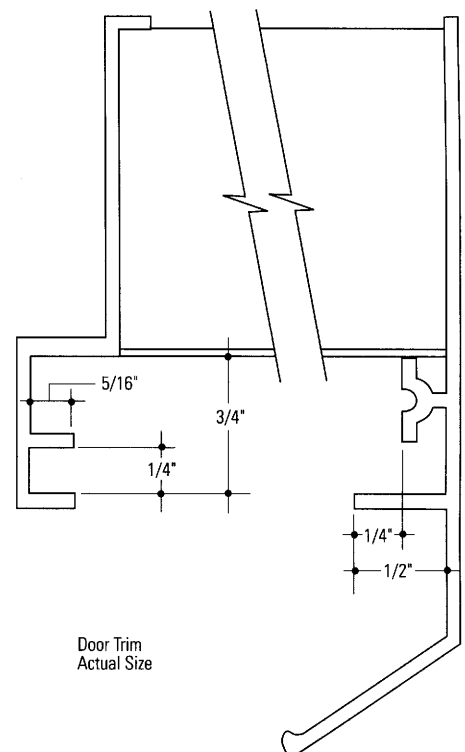

Step 10

Install 1/4" Door Panels

If you are using 3/4" thick custom panels, **SKIP THIS STEP**. See *Custom Options Guide* for panel sizes. Order the ZKT kit for your model, and follow the installation instructions packed with the kit.

If you are using a custom collar dispenser trim, order the ZWCD1 kit (for 36" and 42" models) or ZWCD2 kit (for 48" models).

To install 1/4" door panels:

- Carefully remove the Phillips head screws from the door handle endcaps, top and bottom.
- Open door to 90° stop. Remove the Phillips head screws from the aluminum trim door handles. Retain all screws.

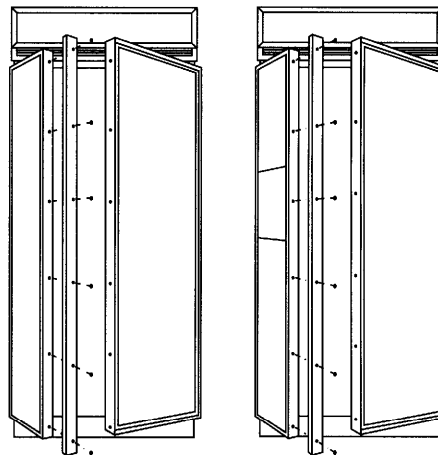

- Attach 2" x 2" adhesive backed foam pads to the door. These fillers assure proper fit. Fillers are shipped with literature package in snack pack drawer.

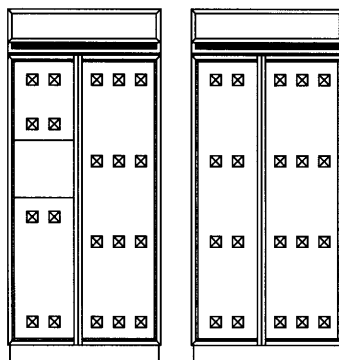

- Slide in panels.
- Replace door handles and secure with original screws.
- Again, check to be sure unit is level and that panels align with cabinetry. Doors will not close properly if unit is not level.
- Check for noises caused by incomplete alignment (rubbing of panels, trim or screws).

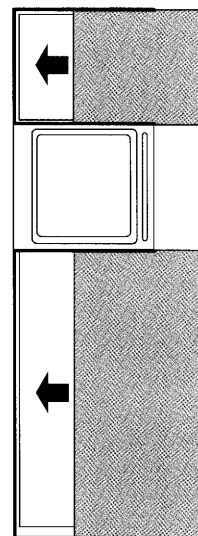
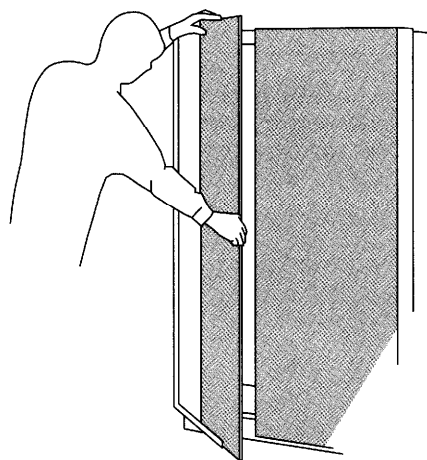

Step **11**
*Arrange
Interior*

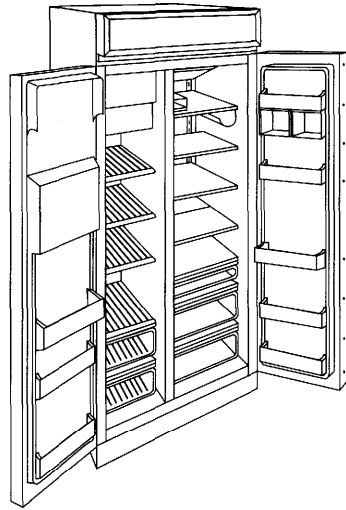

- Remove internal packing materials.
- Set shelves to desired positions.

CAUTION: The top and third shelf are turned upside down for shipping. They must be removed and turned right side up. To remove shelf packing, apply upward pressure on the inverted shelf with one hand and hold in place. Remove packing with other hand. Grip shelf with both hands, lower shelf front and remove from cabinet. Turn shelf right side up and install in desired location.

- Remove tape from all shelves and set them at desired heights.

Step **12**
*Set
Temperature
Controls*

- Set Fresh Food control at "5".
- Set Freezer control at "5".

IMPORTANT: Allow 24 hours for temperatures to stabilize before making adjustments.



Step **13**
*Start
Icemaker*

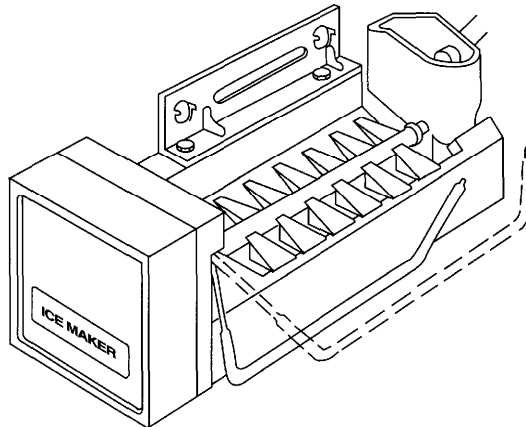

- Lower feeler arm to the ON position.
- Make sure the ice bin is pushed back all the way to the stops on the shelf below the icemaker.
- Discard the first few batches of ice cubes.
- During operation, you will hear the hum of the motor, movement of the cube ejector, humming or clicking of the water valve, and ice falling into the bin. These sounds are normal.

Step **14**
*Install
 Toekick*

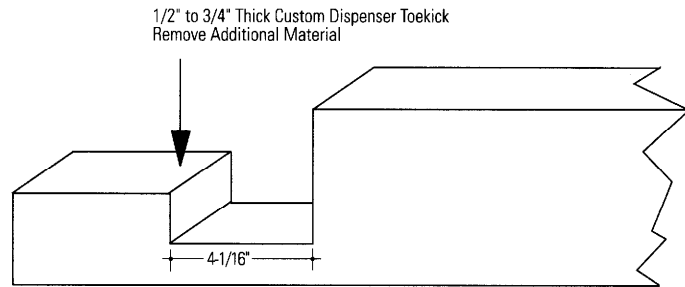
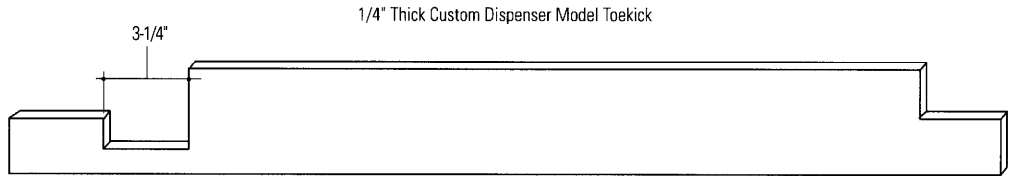
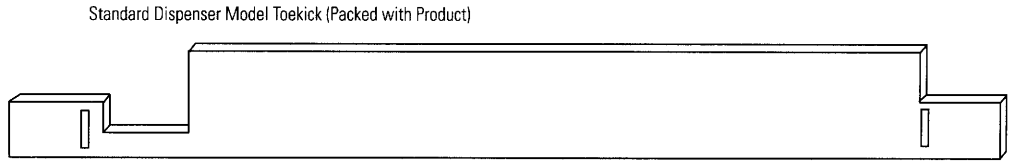
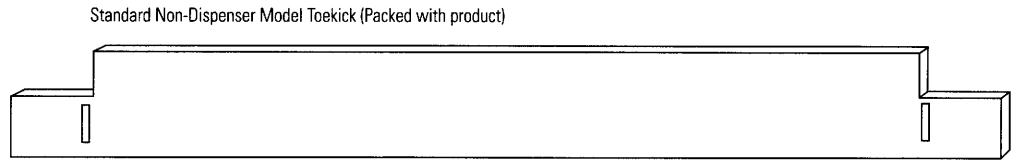

A custom toekick can be installed to match or complement the surrounding cabinetry.

A standard toekick is supplied with all refrigerators. If a custom toekick is to be installed, use the supplied toekick as a template to cut out notches around hinges and water line tubing.

For 1/2" to 3/4" thick custom toekicks, additional material should be removed and cut away. This will allow the water and electrical umbilical tube to rotate smoothly when the door is fully opened.

The custom toekick should be installed in such a manner that it can be removed if service is required.

Problem Solving

Alignment of Doors

Door alignment is usually assured when the unit is leveled. If doors are not aligned after leveling the unit, contact GE Service.

Moisture

If moisture forms between the doors or on the cabinet, turn on the energy saver switch. This should only occur when humidity is high. If the problem persists, contact GE Service.

Operation of Unit

If the refrigerator does not operate after checking the installation instructions, check the electrical connections inside the cooling compartment, check the power cord plug in the wall outlet and the power supply to the outlet. If all connections and fuse or circuit breaker are in order, contact GE service.

Decorator Panels

Contact your Contractor/Installer

Squareness of Cabinetry

Contact your Contractor/Installer

Water

Contact your plumber

Note: While performing installations described in this book, safety glasses or goggles should be worn.

To obtain specific information concerning any Monogram product or service, call GE Answer Center® consumer information service at 800.626.2000—any time, day or night.

For local service in your area, call 1-800-GE-CARES (1-800-432-2737).

Note: Product improvement is a continuing endeavor at General Electric. Therefore, materials, appearance and specifications are subject to change without notice.



Monogram.™

General Electric Company
Louisville, KY 40225

Pub. No. 31-45243
Dwg. No. 162D9267P002
©1996 GE Appliances
Printed in U.S.A. (N.D. 393)

8823