

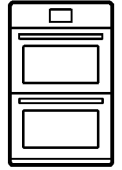

Thinking of you
Electrolux



Double Wall Oven

Use and Care Guide

CONTENTS

- 3 Read all instructions before using this appliance.
- 6 Before Setting Oven Controls
- 8 Setting Oven Controls
- 35 Care and Cleaning
- 39 Solutions to Common Problems
- 42 Warranty

WELCOME TO ELECTROLUX

PLEASE READ AND SAVE THIS GUIDE

Thank you for purchasing an Electrolux appliance. You've chosen a product that brings with it decades of professional experience and innovation. Ingenious and stylish, it has been designed with you in mind. So whenever you use it, you can be safe in the knowledge that you'll get great results every time.

This Use and Care Guide is part of our commitment to customer satisfaction and product quality throughout the service life of your new appliance.

We view your purchase as the beginning of a relationship. To ensure our ability to continue serving you, please use this page to record important product information.

CUSTOMER CARE AND SERVICE

When contacting Service, ensure that you have the following data available.

The information can be found on the rating plate.

Serial plate location: open upper oven door and look on left side of oven frame

We recommend the use of original spare parts.

Registering your product with Electrolux enhances our ability to serve you.

You can register online at www.electroluxappliances.com or by dropping your Product Registration Card in the mail.

Keep a Record for Quick Reference

Purchase Date _____

Electrolux model number _____

Electrolux serial number _____

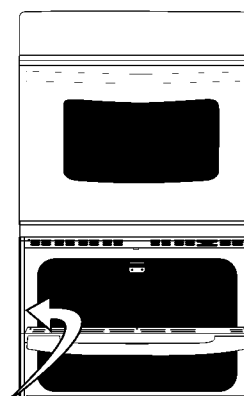

QUESTIONS?

For toll-free telephone support in the U.S. and Canada:

1-877-4ELECTROLUX (1-877-435-3287)

For online support and Internet production information visit <http://www.electroluxappliances.com>.

All rights reserved Printed in USA

Important Safety Instructions

Read all instructions before using this appliance.
Save these instructions for future reference.

This manual contains important safety symbols and instructions. Please pay attention to these symbols and follow all instructions given.

Do not attempt to install or operate your appliance until you have read the safety precautions in this manual. Safety items throughout this manual are labeled with a **WARNING** or **CAUTION** statement based on the risk type.

DEFINITIONS

 This is the safety alert symbol. It is used to alert you to potential personal injury hazards.

Obey all safety messages that follow this symbol to avoid possible injury or death.

⚠ WARNING
Indicates a potentially hazardous situation which, if not avoided, may result in death or serious injury.

⚠ CAUTION
Indicates a potentially hazardous situation which, if not avoided, may result in minor or moderate injury.

IMPORTANT! Indicates installation, operation, maintenance, or valuable information that is not hazard related.

 **General Information, Important, Hints and Tips**
Indicates useful information to avoid malfunctions and is also used for hints and tips how the appliance works in the best way. Information icon followed by supporting text.

⚠ WARNING
Storage in or on appliance—Flammable materials should not be stored in an oven or near surface units. This includes paper, plastic, and cloth items, such as cookbooks, plastic ware, and towels, as well as flammable liquids. Do not store explosives, such as aerosol cans, on or near the oven.

⚠ WARNING
Do not leave children alone - Children should not be left alone or unattended in the area where appliance is in use. They should never be allowed to sit or stand on any part of the appliance, including the storage drawer, lower broiler drawer, warmer drawer, or lower double oven.

⚠ WARNING
Never cover any slots, holes, or passages in the oven bottom or cover an entire oven rack with materials, such as aluminum foil. Aluminum foil linings may trap heat, causing a fire hazard.

⚠ WARNING Tip Over Hazard

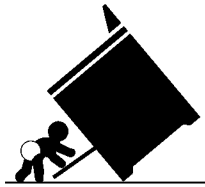

- A child or adult can tip the oven and be killed.
- Install the anti-tip device to oven and/or structure per installation instructions.

- Ensure the anti-tip device is re-engaged when the oven is moved.
- Do not operate the oven without the anti-tip device in place and engaged.
- Failure to follow these instructions can result in death or serious burns to children and adults.

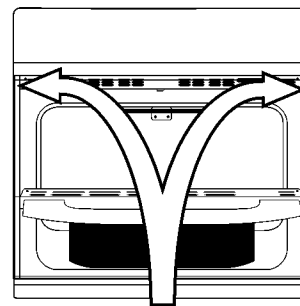

Anti-tip mounting holes

Refer to the installation instructions supplied with your appliance for proper installation.

Check for proper installation with a visual check that the anti-tip screws are present. Test the installation with light downward pressure on the open oven door. The oven should not tip forward.

⚠ WARNING
Stepping, leaning, or sitting on the door of an oven can result in serious injuries and also cause damage to the appliance. Do not allow children to climb or play around the oven. The weight of a child on an open oven door may cause the oven to tip, resulting in serious burns or other injury.

⚠ CAUTION
Wear proper apparel. Loose-fitting or hanging garments should never be worn while using this appliance. Do not let clothing or other flammable materials come into contact with hot surfaces.

⚠ CAUTION
Do not heat unopened food containers. Build-up of pressure may cause container to burst and result in injury.

⚠ CAUTION
Do not use water or flour on grease fires. Smother fire or flame or use dry chemical or foam-type extinguisher. Cover the fire with a pan lid or use baking soda.

⚠ CAUTION
Do not touch heating elements or interior surfaces of the oven unless the oven has cooled sufficiently.

Important Safety Instructions

⚠ CAUTION

Use dry potholders. Moist or damp potholders on hot surfaces may result in burns from steam. Do not let potholders touch hot cooking areas. Do not use towels or other bulky cloths.

⚠ CAUTION

Do not store items of interest to children in the cabinets above the oven. Children climbing on the range to reach items could be seriously injured.

⚠ CAUTION

When heating fat or grease, watch it closely. Grease may catch fire if it becomes too hot.

IMPORTANT! Important Safety Notice - The California Safe Drinking Water and Toxic Enforcement Act requires the governor of California to publish a list of substances known to cause cancer, birth defects, or other reproductive harms, and it requires businesses to warn customers of potential exposures to such substances.

⚠ CAUTION

Read and follow the below instructions and precautions for unpacking, installing, and servicing your appliance:

- Remove all tape and packaging before using the oven. Destroy the carton and plastic bags after unpacking the oven. Never allow children to play with packaging material.
- Proper Installation—Be sure your appliance is properly installed and grounded by a qualified technician in accordance with the National Electrical Code ANSI/NFPA No. 70 latest edition and local electrical code requirements. In Canada, install in accordance with CSA Standard C22.1, Canadian Electrical code, Part 1, and local electrical code requirements. Install only per installation instructions provided in the literature package for this oven.
- User servicing—Do not repair or replace any part of the appliance unless specifically recommended in the manuals. All other servicing should be done only by a qualified technician. This reduces the risk of personal injury and damage to the oven.
- Ask your dealer to recommend a qualified technician and an authorized repair service. Know how to disconnect the power to the oven at the circuit breaker or fuse box in case of an emergency.
- Never modify or alter the construction of an oven by removing the leveling legs, panels, wire covers, anti-tip brackets/screws, or any other part of the oven.

- Remove the oven door from any unused oven if it is to be stored or discarded.
- Be sure to have an appropriate foam-type fire extinguisher available, visible, and easily located near the appliance.
- Do not attempt to operate the oven during a power failure. If the power fails, always turn off the oven. If the oven is not turned off and the power resumes, the oven will begin to operate again. Once the power resumes, reset the clock and oven function.
- Cold temperatures can damage the electronic control. When using this appliance for the first time, or when the appliance has not been used for an extended period of time, be sure the appliance has been in temperatures above 32°F (0°C) for at least 3 hours before turning on the power to the appliance.

IMPORTANT INSTRUCTIONS FOR USING YOUR OVEN

- Never use your appliance for warming or heating the room.
- Use care when opening oven door, lower oven door, or warmer drawer (some models). Stand to the side of the oven when opening the door of a hot oven. Let hot air or steam escape before you remove or replace food in the oven.
- Keep oven vent ducts unobstructed. Touching surfaces in this area when the oven is on may cause severe burns. Do not place plastic or heat-sensitive items on or near the oven vent. These items can melt or ignite.
- Placement of oven racks - Always place oven racks in desired location while oven is cool. If rack must be moved while oven is hot, do not let pot holder contact hot heating element in oven. Use potholders and grasp the rack with both hands to reposition. Remove all bakeware and utensils before moving the rack.
- Do not use a broiler pan without its insert. Broiler pans and inserts allow dripping fat to drain away from the high heat of the broiler. Do not cover the broiler insert with aluminum foil; exposed fat and grease could ignite.
- Protective liners - Do not use aluminum foil to line oven bottoms, except as suggested in the manual. Improper installation of these liners may result in a risk of electric shock, or fire.
- Do not cook food on the oven bottom. Always cook in proper bakeware and always use the oven racks.

Save these instructions for future reference.

Important Safety Instructions

IMPORTANT INSTRUCTIONS FOR CLEANING YOUR OVEN

- Before manually cleaning any part of the oven, be sure all controls are turned off and the oven is cool. Cleaning a hot oven can cause burns.
- Clean the oven regularly to keep all parts free of grease that could catch fire. Do not allow grease to accumulate.
- Always follow the manufacturer's recommended directions for use of kitchen cleaners and aerosols. Be aware that excess residue from cleaners and aerosols may ignite causing damage and injury.
- Clean ventilating hoods frequently. Grease should not be allowed to accumulate on the hood or filter. Follow the manufacturer's instructions for cleaning hoods.

SELF CLEANING OVENS

- Clean only the parts listed in this manual. Before using self clean, remove the broiler pan, any food, utensils, and bakeware from the oven. Remove oven racks unless otherwise instructed.
- Do not use oven cleaners. No commercial oven cleaner or oven liner protective coating of any kind should be used in or around any part of the oven.
- Do not clean door gasket. The door gasket is essential for a good seal. Care should be taken not to rub, damage, or move the gasket.
- Some birds are extremely sensitive to the fumes given off during the self clean cycle of any oven. Move birds to another well-ventilated room.

CAUTION

DO NOT TOUCH HEATING ELEMENTS OR INTERIOR SURFACES OF OVEN - Heating elements may be hot even though they are dark in color. Interior surfaces of an oven become hot enough to cause burns. During and after use, do not touch, or let clothing or other flammable materials contact heating elements or interior surfaces of oven until they have had sufficient time to cool. Other surfaces of the appliance may become hot enough to cause burns - among these surfaces are (identification of surfaces - for example, oven vent openings and surfaces near these openings, oven doors, and windows of oven doors).

GROUNDING INSTRUCTIONS

WARNING

Avoid fire hazard or electrical shock. Failure to follow this warning may cause serious injury, fire, or death.

For personal safety, this appliance must be properly grounded. For maximum safety, the power cord must be plugged into an electrical outlet that is the correct voltage, is correctly polarized and properly grounded in accordance with local codes. It is the personal responsibility of the consumer to have the appropriate outlet with the correct, properly grounded wall receptacle installed by a qualified electrician. It is the responsibility and obligation of the consumer to contact a qualified installer to assure that the electrical installation is adequate and is in conformance with all local codes and ordinances.

See the installation instructions packaged with this appliance for complete installation and grounding instructions.

Save these instructions for future reference.

BEFORE SETTING OVEN CONTROLS

Oven Vent

The oven vent is located under the control panel (Figure 1). When the oven is operational, warm air will pass through this vent for proper air circulation and provide good baking results in the oven. Steam or moisture may appear near the vent, this is normal. Do not block this vent.

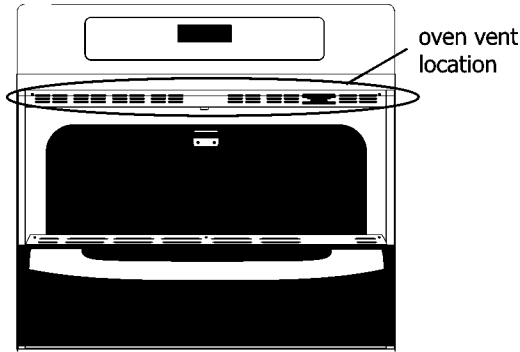

Figure 1: Oven vent

Oven Racks

CAUTION Always use potholders or oven mitts when removing food or adjusting the oven racks. Wait until the oven has completely cooled if possible. Oven racks may be very hot and may cause burns.

IMPORTANT! It is recommended to remove all racks from the oven during clean cycles, but porcelain racks may be left in the oven if they are soiled. After a clean cycle, or anytime the gliding is rough, the glide racks should be treated with graphite lubrication. For instructions on how to care for your oven racks, see "Caring for your porcelain enameled glide racks" on page 37.

Removing and replacing flat or offset oven racks

- To remove - pull the oven rack straight forward until it reaches the stop position. Lift up front of oven rack slightly and slide out.
- To replace - place the oven rack on the rack guides on the oven walls. Tilt the front of the rack upward slightly and slide the oven rack back into place.

Flat oven racks may be used for most cooking needs and may be placed in most oven rack positions.(Figure 2)

The fully extendable **Luxury-Glide™** oven rack (Figure 3) allows you to effortlessly extend your food away from the oven. See **Removing and Replacing the Luxury-Glide™ Oven Racks** on next page for instructions.

Types of oven racks

Your appliance may be equipped with any one or more of the following rack types.

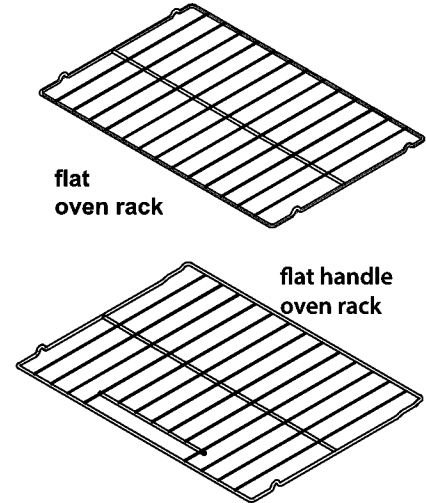

Figure 2: Flat rack for most baking

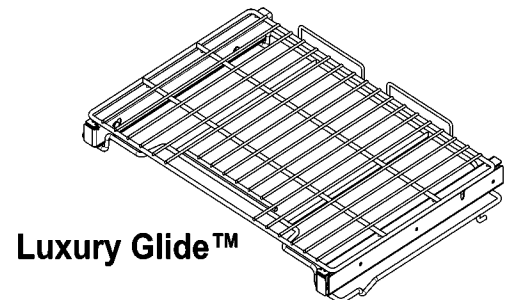

Figure 3: Luxury Glide rack

IMPORTANT! Do not line oven walls, racks, bottom or any other part of the oven with aluminum foil. Doing so will alter heat distribution, produce poor baking results, and may cause permanent damage to the oven interior. During a self clean cycle oven temperatures will be hot enough to melt foil.

Installing Oven (Ladder) Rack Supports

IMPORTANT! Always install oven rack support before turning on the oven (when the oven is cool).

To aid installation of the porcelain oven rack supports, apply a thin layer of cooking oil to all the prongs of the supports shown below.

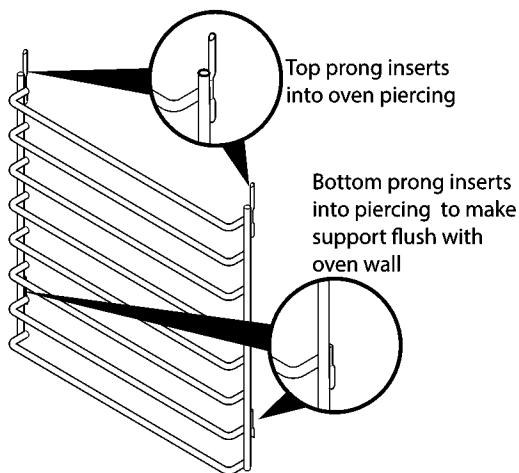

To install oven rack supports:

1. Hold the oven rack support at a slight angle and insert prongs into the holes at the top of the oven cavity (Arrow 1).
2. Lift the rack into the top holes, aligning the bottom prongs with the bottom holes (Arrow 2).
3. Once the upper prongs are in place, hold the oven rack support flush with the oven side and insert the bottom prongs into the bottom holes (Arrow 3).
4. Slide the bottom prongs down into the lower holes. Some force may be required to set the rack into place (Arrow 4).

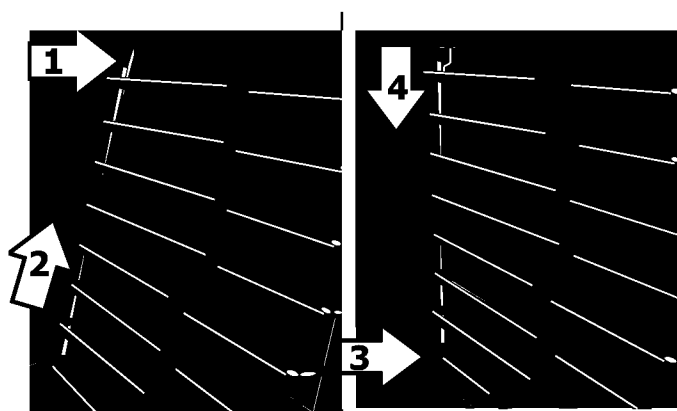

Figure 4: Follow 4 steps to install ladder racks

To remove the ladder rack support for a self-clean cycle, reverse the order used when installing the ladder rack supports.

Luxury Glide™ oven racks

The fully extendable Luxury Glide™ rack makes food preparation easier. This oven rack has glide tracks that allow the rack to be pulled away from the oven without rubbing the sides of the oven wall.

The Luxury Glide™ rack installs like all other oven racks. Before sliding the rack all the way in, lift the back of the rack slightly to set the rack past the stop position (Figure 6). Be sure to slide the rack all the way in so that the back of the rack stops by touching the vertical support of the ladder rack. The glide portion of the rack can be easily pulled in and out in this position while the frame of the rack remains locked into the ladder supports.

This allows bakeware to remain in place on the Luxury Glide™ rack and slide out easily to check food items without removing them from the oven.

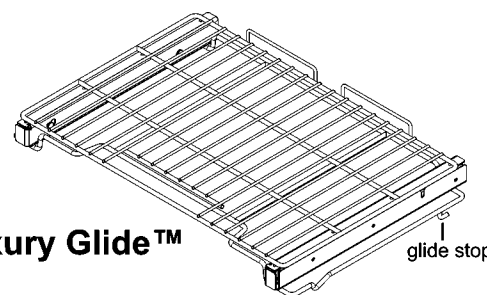

Figure 5: Glide rack showing glide stop

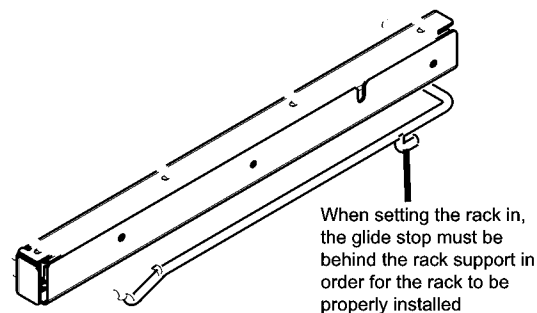
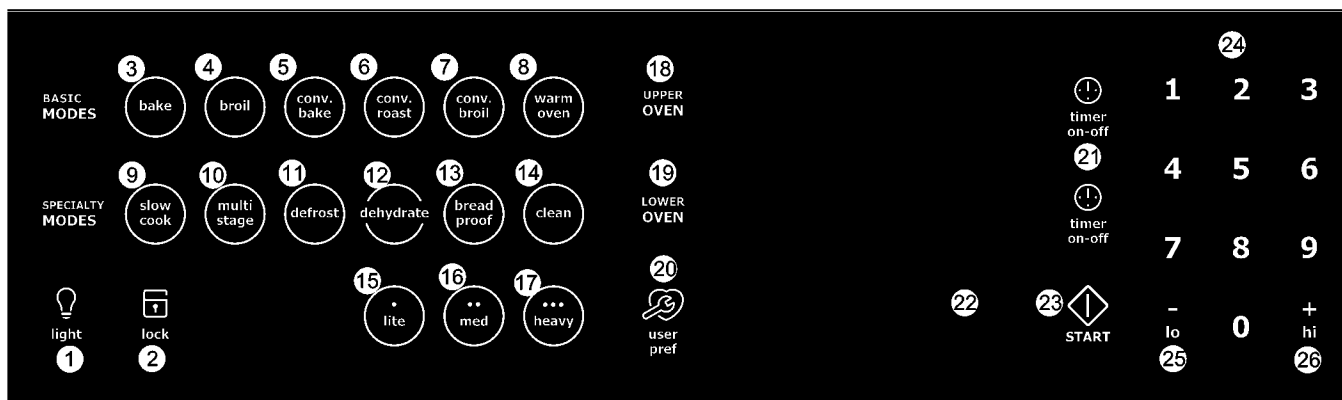

Figure 6: Carefully lift rack while inserting to ensure the glide stop is behind the ladder rack support

IMPORTANT!

Luxury Glide™ racks may be left in the oven if they are soiled. After a clean cycle, or anytime the gliding is rough, the glide racks should be treated with graphite lubrication. Refer to “Caring for your porcelain enameled glide racks” on page 38.

SETTING OVEN CONTROLS



- oven light** - Turns internal oven lights on and off. When turned on or when the door opens the lights will gradually increase in brightness similar to theater lighting.
- control lock** - Use to lock all oven functions including the oven door.
- bake** - Use to enter normal baking temperatures for recipes that call for regular baking.
- broil** - Selects normal broil function with a default temperature of 550°F (288°C) and is adjustable to 400°F (205°C).
- conv bake** - Use to set convection baking that uses a convection fan to circulate the oven heat for faster cooking of some foods. For an explanation of convection cooking see "Convection Bake" on page 16.
- conv roast** - Use to set convection roasting that uses a convection fan to gently brown the exterior and seals in the juices of meat.
- conv broil** - Use to select convection broiling to combine direct heat with the speed of convection cooking.
- warm oven** - Use for keeping cooked foods at serving temperature for up to 3 hours. Warm oven can be used in both the upper oven and the lower oven.
- slow cook** - Use to select slow cook for cooking foods at lower temperatures over longer periods of time. This is especially useful when roasting meats that require long, slow cooking.
- multi stage** - Allows up to 3 stages of cooking foods and is ideal when adding the warm oven feature after a cooking function.
- defrost** - Uses convection fan with the room temperature to defrost delicate food items like frozen cakes and pastries.
- de-hydrate** - Use to select dehydrate that combines very low heat with the convection function to dry foods for preservation.
- bread proof** - Use to select bread proof which uses low heat to help activate yeast based items before baking.
- clean** - Use to select the self cleaning feature before starting the desired cleaning time. Be sure to read about clean before using at "Setting Clean" on page 33.
- lite** - Use after pressing the clean key for a 2 hour clean for mostly lighter cleaning.
- med** - Use after pressing the clean key when a normal (3 hr) cleaning is desired.
- heavy** - Use after pressing clean key for a deep (4 hr) clean.
- upper OVEN** - Use to select upper oven before starting any cooking function.
- lower OVEN** - Use to select lower oven before starting any cooking function.
- user pref** - Use to bring the user preference menu in the display and select special options including selection of Fahrenheit or Celsius temperature displays, setting the clock, continuous cooking or energy saving, and adjusting oven temperatures.
- timer on-off** - Use to set or cancel the minute timer. The minute timers will not start or stop any cooking functions.
- CANCEL** - Use to cancel any function previously entered except the time of day and minute timer. Push cancel to stop cooking.
- START** - Use to start all oven functions and to confirm user preferences settings.
- 0 through 9 number keys** - Use to set times and temperatures and to set clock to correct time of day.
- lo** - Use to lower temperatures and times and to change some user preferences.
- hi** - Use to raise temperatures and times and to change some user preferences.

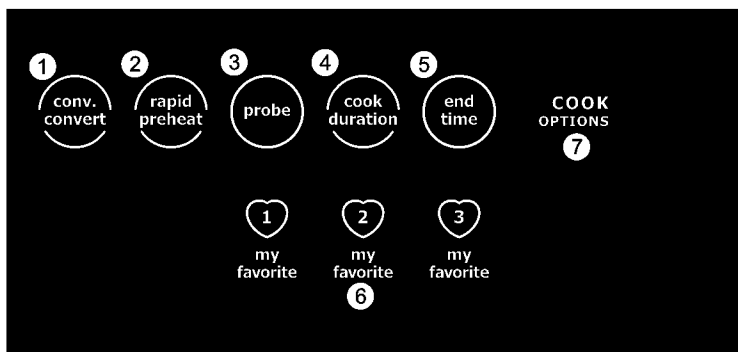

Figure 7: Cook options keys and my favorite recipe keys

1. **conv. convert** - Converts standard temperature to convection temperature. This feature is only available when using convection bake.
2. **rapid preheat** - Use to quickly preheat oven to set temperature before baking certain items that require a hot oven before placing them in oven. Rapid preheat can only be set using the bake or conv bake features.
3. **probe** - Using the probe when cooking meats such as roasts, hams or poultry allows the probe to check the internal temperature without any guesswork.
4. **cook duration** - Use to set a specific cooking duration time which turns off the cooking process when the time expires.
5. **end time** - Use to set time which cooking will end. When used with cook duration setting this will produce a delayed start and explained in "Setting Cook Duration with End Time" on page 24.
6. **my favorite** - Use to store and then recall up to 3 favorite recipes. For tips on using this feature see "My Favorites" on page 37.
7. **COOK OPTIONS** - Select to see which options are available with oven functions.

Minimum and Maximum Control Settings

Feature	Minimum Temp	Maximum Temp
Rapid Preheat	170°F (76°C)	550°F (288°C)
Bake	170°F (76°C)	550°F (288°C)
Broil	400°F (204°C)	550°F (288°C)
Convection Bake	170°F (76°C)	550°F (288°C)
Convection Roast	170°F (76°C)	550°F (288°C)
Convection Broil	300°F (148°C)	550°F (288°C)
Warm Oven	150°F (66°C)	190°F (86°C)
Slow Cook	Lo 225°F(107°C)	Hi 275°F(135°C)
Bread Proof	85°F (30°C)	100°F (38°C)
Dehydrate	100°F (38°C)	225°F (108°C)
Meat Probe	130°F (54°C)	210°F (98°C)

Minimum and Maximum Time Settings

Feature	Minimum Time	Maximum Time
Timer	1 min	11 hr 59 min
Clock 12 hour	1:00 hr	11 hr 59 min
Clock 24 hour	0:00 hr	23 hr 59 min
Cook time 12 hour	1 min	11 hr 59 min
Cook time 24 hour	1 min	23 hr 59 min
End time 12 hour	1:00 hr	12 hr 59 min
End Time 24 hour	0:00 hr	23 hr 59 min
Clean Duration	2 hrs	4hrs

Wave-Touch™ Display Modes

Sleep mode

When not in use, the control panel display will only show the clock.

Awake mode

Touch the control panel to show available controls. You must select upper or lower oven to start cooking. If the panel is not touched again within 2 minutes the control will return to the sleep mode.

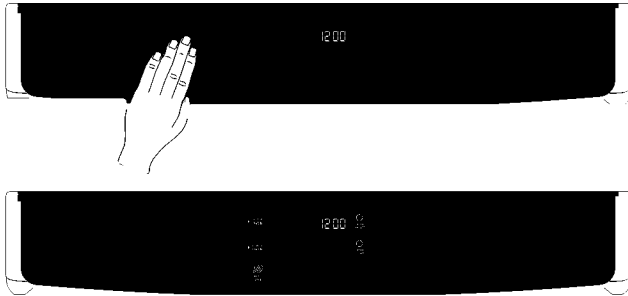

User Preferences



The **user pref** key controls options for preferences. The display shows a digital abbreviation and value for every preference each time the user pref key is pressed.

IMPORTANT! Please read the following instructions before setting the clock or changing the user preferences functions:

- User preferences cannot be changed when any oven function or timer is active.
- Press and continue to press **user pref** to navigate through the preferences.
- Press **hi +** or **lo -** to toggle between options for each preference.
- Continue to press **hi +** or **lo -** to increase or decrease numeric values. You may also use the numeric keys to input precise values. However, when adjusting the oven temperature settings use the **hi** or **lo** keys as described in "Adjusting the Oven Temperature" on page 31
- Press **START** to accept a new option entry or press **user pref** to advance to the next preference.
- Press **CANCEL** to exit the preferences mode.

Setting the Clock

When the appliance is powered up for the first time or when the electric supply to the appliance has been interrupted, the display will flash **12:00**. Press **CANCEL**. This will automatically set the clock at 12:00.

CLO 12:00

To set the clock for 1:30 (as an example of setting correct time of day):

1. Press **user pref** until **CLO** appears in the display.



1. Enter **130** using numeric keys.

130

2. Press **START** to accept.
3. Press **CANCEL** to return to programming mode.



START CANCEL

- Be sure to set the clock to the **correct time** of day before using the oven, especially when cooking with added time instructions.
- The clock cannot be adjusted while the oven is cooking, the timer is active, or during a clean.
- If an invalid time of day is entered, the control will sound with a triple beep (error tone). Re-enter a valid time of day and press **START**. If **CANCEL** is pressed the clock will automatically set for **12:00**.

To set the clock to another time (as an example of changing for Daylight Savings Times):

1. Press the user preference key  until **CLO** appears in the display.
2. Use numeric keys or **hi +** or **lo -** keys to set the correct time of day and press **START**.

Setting the Clock Display

The clock display mode allows you to turn the clock display on or off.

To change the clock display to OFF:

1. Press **user pref** until **clock display** mode appears (See Figure 8).
2. Use **hi +** or **lo -** on either side of the zero (0) on the numeric keypad to toggle to the **CLO off** option.
3. Press **START** to accept.
4. Press **CANCEL** to return to the programming mode.

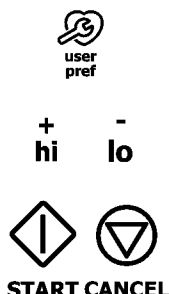

Figure 8: Clock on (L) or off (R) display

Setting 12 or 24 Hour Display

The oven control is factory preset to display the time of day in the 12 hour clock setting. The display can be changed to a 24 hour clock setting or to the **OFF** mode.

When the clock display is turned off it continues to run and will function based on the previously set 12 or 24 hour setting.

To change clock display modes:

1. Press **user pref** until the preset **12hr clock display** mode appears. See Figure 9 (L) below.
2. Use **hi +** or **lo -** on either side of the zero (0) on the numeric keypad to toggle to the **24hr** option.
3. Press **START** to accept.
4. Press **CANCEL** to return to the programming mode.

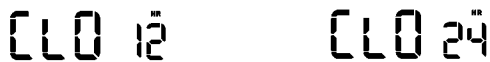

Figure 9: Clock 12 hour (L) or 24 hour (R) display



The clock display mode cannot be changed while the timer is running or the oven is active with any cooking function or during clean.

Changing Oven Temperature Display (°F or °C)

The oven control is factory preset to display oven temperatures with Fahrenheit (°F) values. The control may be changed to display temperatures in Celsius (°C) if desired.

To change the temperature display mode:

1. Press **user pref** until **F** or **C** appears in display. Use **hi +** or **lo -** keys on either side of the zero (0) on the numeric keypad to select desired setting.
2. When the desired mode appears in the display release the key.



3. Press **START** to accept.
4. Press **CANCEL** to return to the programming mode.



Changing Between 12 Hour Energy Saving or Continuous Bake Mode Settings

The oven control is factory preset for a 12 HR Energy Saving mode. This setting automatically turns off any oven function after 11 hours and 59 minutes of non-stop cooking. The control may be set to override this feature for cooking beyond 12 hours.

To change between 12 Hour Energy Saving and continuous bake settings:

1. Press **user pref** until either **ES on** or **ES off** appears in the display.
2. Press **hi +** or **lo -** on either side of the zero (0) on the numeric keypad to change between **ES on** and **ES off**.
3. When the desired setting appears press **START** to accept.



Adjusting Tone Volume

A tone will sound when a key is pressed and also at the end of a cycle (timer, cook time, or end time). The factory audio setting is preset to the highest level (Figure 12). The volume may be adjusted for lower levels from 1 through 5, or can be turned off.

Level **Aud 5** is the highest setting, level 1 is the lowest setting (Figure 11) and **Aud off** (Figure 12) will provide a silent control setting.

Aud 5

Figure 10: Tone volume set for highest level

Aud 1

Figure 11: Tone volume set for lowest level

Aud off

Figure 12: Controls set for silent operation

To adjust the audio tone level:

1. Press **user pref** until the current **Aud** level setting appears in the display.
2. To choose different audio levels continue to press **hi +** or **lo -** on either side of the zero (0) on the numeric keypad to toggle to the desired audio level setting.
3. Press **START** to accept new audio level.



When control is set for **Aud off**, error tones will remain audible.

Control Lock

The control lock will lockout the oven control keys and will lock the upper and lower oven doors. All oven functions must be off before the control lock can be activated.

To activate control lock:

1. Press and hold **control lock** for 3 seconds. Once locked, **LOC** will appear in the display along with the door lock icon. The time of day will still be visible.



To cancel the control lock feature:

Press and hold **control lock** key for 3 seconds. Once unlocked, **control** and door lock icon will no longer appear.

If an oven control key is pressed when oven control lock is active, the oven will sound an error tone (triple beep) indicating the function is not available until the control lock feature is turned off.

IMPORTANT! Do not attempt to force the oven door open when the **door Loc** message is displayed.

Timers

The timers can help keep track of timed cooking or food preparation times without interfering with any active cooking process. Timer settings:

- Minimum set time: 1 minute
- Maximum set time: 11 hours 59 minutes

How to set the timer for 5 minutes:

1. Press **timer on-off**.



2. Enter **5** minutes using numeric key.

5

3. Press **timer on-off** to start timer.



- To cancel an active timer press the **timer on-off** key. The timer does not start or stop the cooking process. The timer may be started alone or with any other active cooking feature.
- The timer will display hours and minutes until 1 hour remains. When the timer countdown reaches less than 1 minute, the display will show the time remaining in seconds. When the time runs out the timer will chime, and the display will show **00:00**.
- If both the oven and the timer are active, the timer information will display by default. To momentarily display information for any other active feature, press the corresponding key once to display the desired feature.

Changing Settings

Software controls the upper and lower ovens so that both can be set to operate at the same time with unique settings. It is very important to understand that before setting or modifying either oven, you must first select which oven you want to set or modify.

Select **UPPER** or **LOWER OVEN** depending on which oven you want to change settings.

You may toggle between either oven and make setting changes at any time.

Temperature Visual Display

Your oven is equipped with a temperature visual display for each oven. When a cooking mode is set, the actual temperature will be shown in the display and will rise as the unit preheats. When the unit has reached its target temperature, a tone will sound to remind you to place the food in the oven. This feature will be active with bake, convection bake, and convection roast. The cooking modes which do not feature the temperature visual display will be noted in their descriptions.



The lowest temperature that can be displayed is 100°F.

Interior Oven Lights

Your appliance includes “theater” style oven lighting features that gradually lights the oven interior to full brightness. Both upper and lower ovens are equipped with 4 halogen lights.

IMPORTANT! It is suggested that the oven lights remain off when baking delicate items such as cakes. They can be turned on momentarily to check baking progress, but should not be left on throughout the full bake time.

The oven lights turn on automatically when the oven door is opened. The oven lights can be turned on when the door is closed by using the oven light key located on the control panel.



Press the oven light icon  to turn the interior oven lights on and off whenever the oven door is closed.



Pressing the oven light key will turn on the oven lights in both ovens. The oven lights will not operate during a clean cycle.

The interior oven lights are located both sides and in the upper rear corners of each oven cavity. Each light is covered with a glass shield. The glass shield must be in place whenever the oven is in use.

To change the interior light, see “**Replacing the Dual Left or Right Side Oven Lights**” on page 36 in the “**Care and Cleaning**” section.

Cook Options

The cook options key will illuminate whenever a basic cooking mode is selected. To determine which options are available (**conv. convert, rapid preheat, probe, cook duration, and bread proof**) when a basic cooking mode is selected, press the cook options key first, then choose the desired option.

Rapid Preheat

Use the **rapid preheat** option for single rack baking to bring the oven to baking temperature. The **rapid preheat** option can only be set using the **bake, convection bake, and convection roast** features. Rapid preheat may be set with cook duration or cook duration with an end time. The following oven temperature settings apply for the rapid preheat function:

- Factory default temperature: 350°F (176°C)
- Minimum **rapid preheat** setting: 170°F (76°C)
- Maximum **rapid preheat** setting: 550°F (288°C)

For best results

- Recommended for single rack cooking only. Use oven rack position 3.
- For batter and dough-based baked goods such as cakes, pastries, and breads, use the convection bake function for best results.

To set rapid preheat using the default oven temperature of 350°F (176°C):

1. Press **UPPER** or **LOWER OVEN**.
2. Press **bake, conv bake, or conv roast**.
3. Press **cook options**.
4. Press **rapid preheat**.
5. Press **START**.

**bake
conv.
bake
conv
roast**

**rapid
preheat**



START

- When activated, the oven will begin preheating and **PREHEATING** will appear in the display.
- A tone will sound indicating the oven has finished preheating. Place prepared food inside oven using a **single** oven rack.
- To stop preheating at anytime press **CANCEL**.



The convection fan will rotate when the rapid preheat is started. If rapid preheat is set with the bake feature the convection fan will turn off once the oven set temperature is reached.



To change temperature settings after rapid preheat has started, use the **hi +** or **lo -** keys on either side of the zero (**0**) on the numeric keypad to increase or decrease the oven temperature. The oven temperature will change by 5° (F) with each press of the **hi +** or **lo -** key.

When oven is fully preheated, the **rapid preheat** feature will perform like a bake function and continue to bake and maintain the set temperature until canceled.

To set rapid preheat with an oven temperature of 425°F (218°C):

1. Press **UPPER** or **LOWER OVEN**.
2. Press **bake, conv bake, or conv roast**.
3. Enter **4 2 5** using numeric keys.
4. Press **cook options**,
5. Press **rapid preheat**.
6. Press **START**.

bake

**conv.
bake**

**conv
roast**

425

**rapid
preheat**



START

To stop **rapid preheat** at any time press **CANCEL**.

Bake

Use **bake** to cook most food items that require normal cooking temperatures. Bake may be set with the following options:

- Rapid preheat
- Probe
- Cook time and cook time with end time setting

The following oven temperature settings apply will to the **bake** feature:

- Factory default bake setting: 350°F (176°C)
- Minimum bake setting: 170°F (76°C)
- Maximum bake setting: Upper oven 550°F (288°C); Lower oven 450°F (232°C)
- Once **bake** is activated the oven will begin preheating and the convection fan will run until preheating is complete. When the oven reaches set temperature the control will sound a tone indicating the oven is ready.

CAUTION

Always use pot holders or oven mitts when working with a hot oven. When cooking, the oven interior, oven racks will become hot enough to cause burns.

CAUTION

Do not cook foods directly on the oven bottom. To avoid damaging the oven interior and surfaces, always cook foods in the oven using cookware positioned on an oven rack.

To set the oven for **bake** at the default oven temperature of 350°F(176°C):

1. Select **UPPER** or **LOWER OVEN**.
2. Press **bake**. The default oven temperature of 350°F will appear in the display.
3. Press **START**.

bake



START

To stop **bake** at any time press **CANCEL**.

To set **bake** with oven temperature of 425°F(218°C):

1. Select **UPPER** or **LOWER OVEN**.
2. Press **bake**.
3. Enter **4 2 5** using numeric keys.
4. Press **START**.

bake

425



START

To stop **bake** at any time press **CANCEL**.

Note: A **cook time** setting may be added to a baking function any time after starting a bake. Refer to the “Cook Duration” on page 18 for complete instructions.

- To add or change any cook settings once the oven is baking first select oven you wish to change. Make temperature changes using the **hi +** or **lo -** keys. Each press will adjust the temperature by +5°F or - 5°F (or 2°C).



If **bake** is active without a cook duration setting, the oven will remain on for 12 hours before turning off automatically unless it is canceled.

To bake longer than 12 hours, see “Changing Between 12 Hour Energy Saving or Continuous Bake Mode Settings” on page 11 for instructions.

For best results

- Fully preheat the oven when baking items like cookies, cakes, biscuits and breads. When using a single rack for baking, place in oven rack position 3.
- When baking cakes using 2 Glide racks, place cookware on positions 2 and 6 and position cookware allowing 2-4 inches (5-10cm) of space between the food items to ensure proper circulation.(Figure 14)
- When using a flat rack with a glide rack, use position 7 for the flat rack and 2 for the glide rack or place the flat rack in 2 and the glide rack in position 6.
- Dark or dull pans and glass absorb more heat than shiny bakeware resulting in dark or over browning of foods. To prevent this it may be necessary to reduce the oven temperature or cook time to prevent over browning of some foods. Dark pans are recommended for pies. Shiny pans are recommended for cakes, cookies and muffins.
- Do not open the oven door too often. Opening the door will reduce the temperature in the oven.
- For batter and dough-based baked goods such as cakes, pastries, and breads, use the convection bake function for best results.

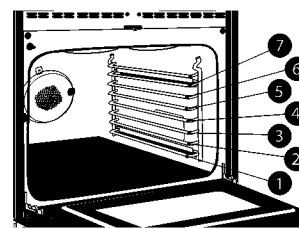

Figure 13: Rack positions

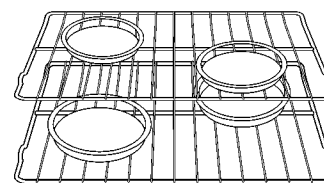

Figure 14: Pan spacing using multiple racks

Convection Bake

Convection Bake uses a fan and three elements to circulate the oven heat evenly and continuously (Figure 15) throughout the oven. The improved heat distribution allows for even cooking with excellent results. Multiple rack cooking may slightly increase cook times for some food types, but the overall result will be time saved.

The convection bake feature should only be used when your recipe instructions have been written especially for convection baking. If your recipe instructions are for regular baking and you wish to use convection bake, follow the convection convert option instructions. The convection convert option will automatically adjust the oven temperature so that convection baking will provide the best possible results.

Benefits of convection bake:

- Superior multiple oven rack performance
- Foods cook more evenly

Convection bake may be set with convection convert, rapid preheat, cook time or cook time with end time settings and probe.

The following temperature settings apply to the convection bake feature:

- Factory default setting: 350°F (176°C)
- Minimum bake setting: 170°F (77°C)
- Maximum bake setting: 550°F (288°C)

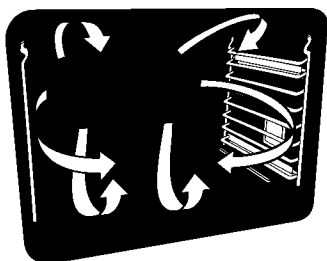

Figure 15: Convection air flow

To set convection bake with the factory default temperature of 350° (176°):

1. Select **UPPER** or **LOWER OVEN**.
2. Press **conv bake**.
3. Press **START**.

conv.
bake



START

IMPORTANT! When preheating oven is needed before baking, be sure to press **cook options** after selecting **conv bake**, then press **rapid preheat** before pressing **START**.

To stop convection bake at anytime press **CANCEL**.

Convection baking tips:

- When baking with a single rack use rack position 3 and center the food in the oven cavity.
- Layer cakes will have better results using the convection bake feature. Fully preheat the oven before baking items like cookies, cakes, biscuits, and breads.
- When using two glide racks use rack positions 2 and 6.
- When using a flat rack with a glide rack, use position 7 for the flat rack and 2 for the glide rack, or place the flat rack in position 2 and the glide rack in position 6.(Figure 16)
- Bake cookies and biscuits on pans with no sides or very low side to allow heated air to circulate around the food. Food items baked on pans with a dark finish will cook faster.
- When placing multiple food items in the oven allow 2 - 4 inches (5-10cm) of space between the food items for proper air circulation.(Figure 17).

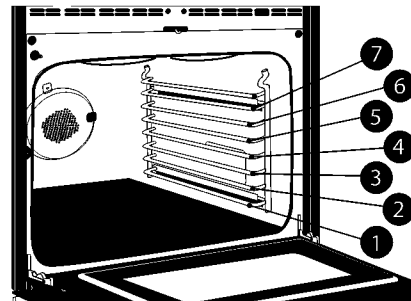

Figure 16: Rack positions

- Dark or dull pans and glass absorb more heat than shiny bakeware resulting in dark or over browning of foods. To prevent this it may be necessary to reduce the oven temperature or cook time to prevent over browning of some foods. Dark pans are recommended for pies. Shiny pans are recommended for cakes, cookies and muffins.
- Do not open the oven door often. Doing so will reduce the oven temperature and may increase cook time. The convection fan will turn off when the door is opened and resume operation when the door is closed.

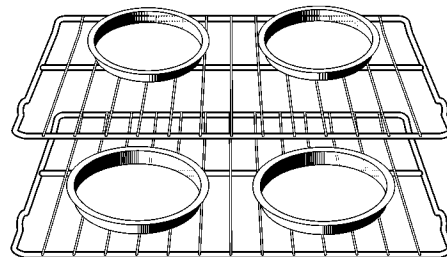

Figure 17: Pan spacing for best results

Convection Convert

The convection convert feature allows you to convert any normal baking recipe into a convection bake recipe. The control uses the normal recipe settings and adjusts to a lower temperature for convection baking. Convection convert must be used with convection bake. Convection convert may be set with cook or end time instructions.

Benefits of convection convert:

- Superior multiple oven rack performance.
- Some foods cook faster, saving time and energy.

To set convection convert with the factory default oven temperature of 350°F (176°C):

1. Select **UPPER** or **LOWER OVEN**
2. Press **conv bake**.
3. Press **cook options**.
4. Press **conv convert**
5. Press **START**.

**conv.
bake**
**conv.
convert**

START

When activated, the oven will begin heating. Once the oven reaches the set temperature a tone will sound indicating the oven is ready.

Note: Convection convert can be set after the convection bake function is started by simply pressing the **conv convert** key.

To stop convection convert at anytime press **CANCEL**.



When using **convection convert**, cook time reductions may vary depending on the oven temperature setting.

- **Convection convert** reduces original temperatures by 25°F (13°C).
- When convection convert is used with the **cook duration** and **end time** features, **CF** (Figure 18) will be displayed when 75% of the bake time is complete. During the last 25% of bake time, the control will chime at regular intervals until the bake time is finished.
- When the bake time is completely finished the control will chime at regular intervals until the **CANCEL** key is pressed.



Figure 18: Check food reminder

To set convection convert for 30 minutes at 375°F (191°C):

1. Select **UPPER** or **LOWER OVEN**.
2. Press **conv bake**. **conv.
bake**
3. Enter **375** using numeric keys. **375**
4. Press **cook duration**. **cook
duration**
5. Enter **30** using numeric keys. **30**
6. Press **cook options**.
7. Press **conv convert**. **conv.
convert**
8. Press **START**. 
START

For best results:

- For best results it is recommended to preheat the oven before baking items like cookies, biscuits and breads.
- When using a single rack, position food in the center of the oven.
- Cookies and biscuits should be baked on pans with no sides or very low side to allow heated air to circulate around the food. Food items baked on pans with a dark finish will cook faster.
- When baking cookies on multiple pans using two oven racks do the following: when using a **flat rack with a glide rack**, the flat rack should be set in position 2 and the glide rack in 6; if the glide rack is used in position 2 then use a flat rack in position 7. If using two glide racks set the racks in positions 2 and 6.
- When placing multiple food items in the oven allow 2-4 inches (5-10cm) of space between the food items for proper air circulation.
- Do not open the oven door often. Doing so will reduce the oven temperature and may increase cook time. The convection fan will turn off when the door is opened and resume operation when the door is closed.

Cook Duration

The cook duration feature is used when a recipe calls for a specific temperature and cook duration. The maximum cook duration setting is 11 hours, 59 minutes. Cook duration instructions may be set with bake, convection bake, convection roast, slow cook, warm oven, rapid preheat, and my favorite.



Cook duration settings are not allowed in the **broil** (except when using broil as part of a multi-stage setting) or **clean** features.

To bake for 30 minutes with the oven at default temperature setting of 350°F (176°C):

1. Select **UPPER** or **LOWER OVEN**.
2. Press **bake**.
3. Press **cook options**.
4. Press **cook duration**.
5. Enter **30** using numeric keypads.
6. Press **START**.

cook
duration
30



START

Once active, oven will bake at the set temperature for the full 30 minutes and then automatically shut off. The timed bake can be ended at any time by pressing **CANCEL**.

When the cook duration runs out:

End will appear in the display window and the oven will shut off automatically. The control will sound an end chime every few seconds until the **CANCEL** is pressed.

To stop cooking at any time press **CANCEL**.

WARNING

FOOD POISONING HAZARD. Do not let food sit for more than one hour before or after cooking. Doing so can result in food poisoning or sickness.

CAUTION

Use caution when preparing foods with cook duration and end time instructions. Foods that can easily spoil such as milk, meat, fish or poultry, should be chilled in the refrigerator first. Even when chilled, they should not stand in the oven for more than one hour before cooking begins, and should be removed promptly when cooking ends.

Setting Cook Duration with End Time

Adding a cook duration with a specific end time allows the user to control exactly when the cooking process will begin and end.

Cook duration and end time instructions may be set with bake, Convection bake, convection roast, slow cook, defrost, dehydrate, bread proof, multi-stage, and warm oven. Before setting end time instructions be sure the time of day is set correctly on the oven clock.

To set the oven to bake at 375°F (190°C) for 50 minutes and to automatically shut off at 5:30:

1. Select **UPPER** or **LOWER OVEN** and press **bake**. **bake**
2. Enter **375** using numeric keys. **375**
3. Press **cook options**.
4. Press **cook duration**. **cook duration**
5. Enter **50** using the numeric keys. **50**
6. Press **end time**. **end time**
7. Enter **5 3 0** using numeric keys. **530**
8. Press **START**.



START

Once **START** is pressed, the oven will calculate the delayed start time. When the oven clock reaches the delayed starting time, the oven will automatically turn on and heat to the set temperature. The oven will maintain the set temperature throughout the set cook time until the set end time cancels the cooking function.



To change temperature settings during the cooking process, use the **hi +** or **lo -** keys on either side of the zero (**0**) on the numeric keypad to increase or decrease the oven temperature. The oven temperature will change by +5°F or -5°F (2°C) with each press of the **hi +** or **lo -** key.

When cook duration runs out:

The display will show the **End** message and the oven will shut off automatically. The control will chime every few seconds until **CANCEL** is pressed.

To stop cooking at any time press **CANCEL**.

Broil

Use the **broil** feature to cook meats that require direct exposure to radiant heat for optimum browning results. Broiling is direct heat cooking and will produce smoke. If smoke is excessive, place food further away from the broil element.

⚠ WARNING

Broil with oven door closed. Should an oven fire occur, turn oven off and do not open the door. If the fire continues, throw baking soda on the fire or use a fire extinguisher. Do not put water or flour on the fire. Flour may be explosive and water can cause a grease fire to spread possibly causing personal injury.

⚠ CAUTION

Use pot holders or oven mitts when working with a hot oven. When broiling, the oven interior, oven racks will become hot enough to cause burns. Do not use the broiler pan without the insert. Do not cover broil pan insert with aluminum foil; the exposed grease could ignite.

To prevent food from contacting the broil element and to prevent grease splattering, use the broil pan and insert when broiling. The broil pan insert has slots that allow grease and fat from the meat to drain into the broiler pan away from the hot element.

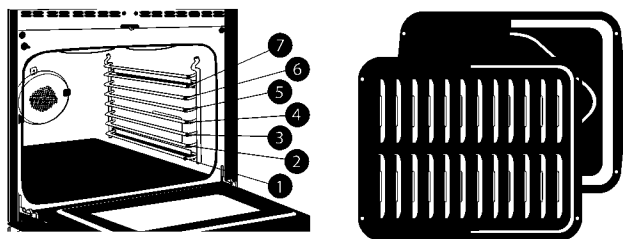

Figure 19: Rack positions (L) Broil pan and insert (R)

For optimum browning results, allow the oven to preheat for 2 minutes. Use the recommended pans and oven rack positions for the type and amount of meat being prepared.

Table 1: Suggested Settings for Broiling

Food	Rack Position	Oven Temperature	Cook time in minutes, 1st side	Cook time in minutes, 2nd side	Internal Temperature	Doneness
Steak 1" thick	6th** or 7th*	550°F (288°C)	5	4	140°F (60°C)	Rare
Steak 1" thick	6th** or 7th*	550°F (288°C)	6	4	145°F (63°C)	Medium
Steak 1" thick	6th** or 7th*	550°F (288°C)	7	5	160°F (71°C)	Med-well
Steak 1" thick	5th or 6th**	550°F (288°C)	8	7	170°F (77°C)	Well
Pork Chops 3/4" thick	6th	550°F (288°C)	8	6	170°F (77°C)	Well
Chicken bone-in	5th	450°F (232°C)	20	10	170°F (77°C)	Well
Chicken boneless	5th	450°F (232°C)	8	6	170°F (77°C)	Well
Fish	5th	500°F (260°C)	13	n/a	170°F (77°C)	Well
Shrimp	4th	550°F (288°C)	5	n/a	170°F (77°C)	Well
Hamburger 1" thick	7th	550°F (288°C)	9	7	145°F (63°C)	Medium
Hamburger 1" thick	7th	550°F (288°C)	10	8	170°F (77°C)	Well

*Use the off-set rack if you choose to use an oven rack in position 7 ** Use glide rack in position 6.

***The U.S. Department of Agriculture states, "Rare fresh beef is popular, but you should know that cooking it to only 140°F (60°C) means some food poisoning organisms may survive." (Source: Safe Food Book, Your Kitchen Guide, USDA Rev. June 1985.) The lowest temperature recommended by the USDA is 145°F (63°C) for medium rare fresh beef. For beef well done 170°F (76°C).

To set broil with the factory default temperature setting of 550°F (288°C):

1. Place the broiler insert on the broiler pan, then place the meat on the insert. Remember to follow all warnings and cautions.
2. Arrange the interior oven rack to rack position recommendations.
3. Select **UPPER** or **LOWER OVEN**.
4. Press **broil**. **550** will appear in the display.
5. Press **START**. Allow oven to preheat for 2 minutes.
6. Be sure to place the pan with the meat directly under the broil element. Close the oven door. To avoid burning food, watch the food carefully when broiling and turn meat when needed.
7. Turn meat when the first side is browned to the desired amount.
8. To stop **broil** at anytime press **CANCEL**.

Recommended Broiling Times

Use the broiling table below for approximate recommended broiling times for the types of meat listed. Depending on the type, the thickness, and the desired doneness of meat, it might be necessary to increase or decrease broiling times or adjust the broiling pan to different rack positions. If the food you are broiling is not listed in the table, follow the instructions provided in your recipe and watch the broiling process closely.



To change temperature settings use the **hi +** or **lo -** keys on either side of the zero (0) on the numeric keypad to increase or decrease the oven temperature. The oven temperature will change by 5° (F) with each press of the **hi +** or **lo -** key.

Convection Broil

Use convection broil for thicker cuts of meat, fish, and poultry. Convection broiling gently browns the exterior and seals in the juices by using the broil element and a fan to circulate the oven's heat evenly and continuously within the oven.

The oven can be programmed for convection broiling at any temperature between 300°F to 550°F with a default temperature of 550°F. Convection broil only works with the oven door closed.

CAUTION

Always use pot holders or oven mitts when working with a hot oven. When broiling, the oven interior, oven racks will become hot enough to cause burns.

Convection Broiling Tips:

- For optimum browning, preheat the broil element for 2 minutes.
- Always pull the rack out to the stop position before turning or removing food.
- Always use the broiler pan with the insert when broiling. It allows the dripping grease to be kept away from the high heat of the broil element.
- Do not cover the broil pan insert with foil. The exposed grease could catch fire. Do not use the roasting rack when broiling.
- Convection broiling is generally faster than conventional broiling. Check for doneness at the minimum recommended time.

To set convection broil with a default oven set temperature of 550°F (288°C):

1. Arrange oven racks. Select **UPPER** or **LOWER OVEN**.
2. Press **conv broil**.
3. Press **START**.

**conv
broil**



START

For best results:

- Be sure to carefully follow all the recommended broil pan and insert instructions and the directions for placing the oven racks as provided in the broil section.
- Since convection broil cooks food faster, reduce the cook time by 25% from the recommended cook time of your recipe (check the food at this time).

IMPORTANT! To change temperature settings use the **hi +** or **lo -** keys on either side of the zero (0) on the numeric keypad to increase or decrease the oven temperature. The oven temperature will change by +5°F or -5°F (2°C) with each press of the **hi +** or **lo -** key.

Convection Roast

Convection roast combines a cooking cycle with the convection fan and element to rapidly roast meats and poultry. Heated air circulates around the meat from all sides, sealing in juices and flavors. There is no need to reduce the oven temperature when using convection roast.

Convection roast may be set with the following options:

- Cook time
- Cook time with end time
- Probe

The following oven temperature settings apply for convection roast:

- Minimum convection roast setting: 170°F (76°C)
- Maximum convection roast setting: 550°F (288°C)

Benefits of convection roast:

- Some foods will cook faster, saving time and energy.
- Meats cooked with this feature are crispy and brown on the outside while staying moist inside.

To set convection roast with the factory default oven temperature setting of 350°F (176°C):

1. Select **UPPER** or **LOWER OVEN**.
2. Press **conv roast**.
3. Press **START**.

**conv
roast**



START

When activated, the control display will show **CONV ROAST** and the oven will begin heating. Once the oven reaches the set temperature a tone will sound indicating the oven is ready.

To stop convection roast at anytime press **CANCEL**.



Preheating for convection roast will not be necessary for most meats and poultry.

- Arrange food in center of oven rack.
- Convection roast cooks faster. Reduce cook times by 25% from the recommended time of your recipe. Then if needed, increase cook time until the desired doneness is obtained.
- Be sure to carefully follow your recipe's temperature and time recommendations or refer to the convection roast recommendations for additional information. See Table 2, "Convection Roasting Temperature and Time Recommendations," on the next page.
- Do not cover foods when dry roasting - covering will prevent the meat from browning properly.
- It is not recommended to roast chicken on a roasting rack. Use a deep pan instead and place on lowest rack position.

Convection Roast (cont'd)

When cooking meats using convection roast, it is recommended to use the broiler pan and insert with the roasting rack (some models). The broiler pan will catch grease spills and the insert helps prevent grease splatters. The roasting rack fits on top of the insert allowing the heated air to circulate under the food for even cooking and helps to increase browning on the underside.

To properly arrange food for roasting:

1. Place oven rack on bottom or next to the bottom oven rack position.
2. Place the insert on the broiler pan.
3. Make sure the insert is securely seated on top of the broiler pan. Do not use the broiler pan without the insert. Do not cover the insert with aluminum foil.
4. Place meat (fat side up) on roasting rack and the roasting rack onto the insert. (Figure 20). Place prepared food on oven rack and slide into oven.

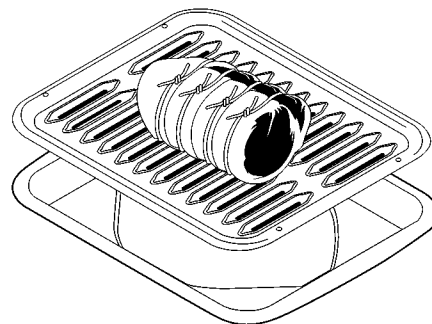

Figure 20: Broil pan with insert for convection roasting

Table 2: Convection Roasting Temperature and Time Recommendations

Meat		Weight	Oven Temp	Internal Temp	Minutes per lb.
Beef	Standing rib roast*	4 to 6 lbs.	350°F (176°C)	*160°F (71°C)	25-30
	Ribeye Roast*	4 to 6 lbs.	350°F (176°C)	*160°F (71°C)	25-30
	Tenderloin roast	2 to 3 lbs.	400°F (204°C)	*160°F (71°C)	15-25
Poultry	Turkey whole**	12 to 16 lbs.	325°F (163°C)	180°F (82°C)	8-10
	Turkey whole**	16 to 20 lbs.	325°F (163°C)	180°F (82°C)	10-15
	Turkey whole**	20 to 24 lbs.	325°F (163°C)	180°F (82°C)	12-16
	Chicken	3 to 4 lbs.	350°F-375°F (176°C-190°C)	180°F (82°C)	12-16
Pork	Ham roast, fresh	4 to 6 lbs.	325°F (163°C)	*160°F (71°C)	30-40
	Shoulder blade roast	4 to 6 lbs.	325°F (163°C)	*160°F (71°C)	20-30
	Loin	3 to 4 lbs.	325°F (163°C)	*160°F (71°C)	20-25
	Pre-cooked ham	5 to 7 lbs.	325°F (163°C)	*160°F (71°C)	30-40

*The U.S. Department of Agriculture states, "Rare fresh beef is popular, but you should know that cooking it to only 140°F (60°C) means some food poisoning organisms may survive." (Source: Safe Food Book, Your Kitchen Guide, USDA Rev. June 1985.) The lowest temperature recommended by the USDA is 145°F (63°C) for medium rare fresh beef. For beef well done 170°F (76°C).

** Stuffed turkey requires additional roasting time.

**Shield legs and breast with foil to prevent over browning and drying of skin.

⚠ WARNING

Should an oven fire occur, close the door. If the fire continues, throw baking soda on the fire or use a fire extinguisher. Do not put water or flour on the fire. Flour may be explosive and water can cause a grease fire to spread possibly causing personal injury.

⚠ CAUTION

Do not use the broiler pan without the insert and roasting rack. Do not cover the broil pan or insert with aluminum foil; the exposed grease could ignite.

⚠ CAUTION

Always use pot holders or oven mitts when working with a hot oven. When broiling, the oven interior, oven racks will become hot enough to cause burns.

Meat Probe

Checking the internal temperature of your food is the most effective way of insuring that your food has been properly cooked. When cooking meat such as roasts, hams or poultry you can use the probe to check the internal temperature without any guesswork.

Your oven will automatically change from cooking to warm oven once the probe has reached the set temperature.

The following temperature settings apply to the probe function:

- Default: 170°F (76°C)
- Minimum: 130°F (54°C)
- Maximum: 210°F (99°C)

Setting the Probe

- Always insert the probe so that the tip rests in the center of the thickest part of the meat. Do not allow the probe to touch bone, fat, gristle, or the pan.
- For bone-in ham or lamb, insert the probe into the center of the lowest large muscle or joint.
- For dishes such as meat loaf or casseroles, insert the probe into the center of the food. To find the center of the food visually measure with the probe.
- When cooking fish, insert the probe just above the gill.
- For whole poultry or turkey, insert the probe into the thickest part of the breast (Figure 21).

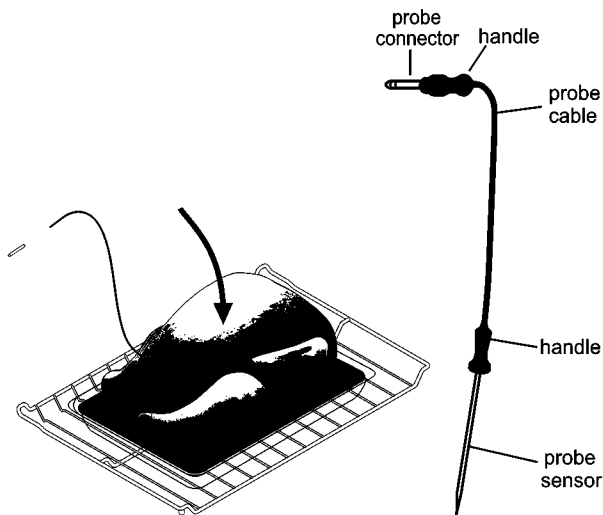

Figure 21: Components of meat probe (top) Proper placement for poultry (bottom)

IMPORTANT! Use only the probe supplied with your appliance. Any other may result in damage to the probe or the appliance.

CAUTION

Be sure the probe is fully inserted into the probe receptacle. The probe will not work properly until correctly connected (Figure 22).

- Handle the probe carefully when inserting and removing it from the food and the receptacle. Do not use tongs to pull the cable when inserting or removing it from the food or the receptacle.
- Defrost your food completely before inserting the probe to avoid damaging probe. Never leave or store the probe inside the oven when not in use.
- To prevent the possibility of burns, carefully unplug the probe using a pot holder or oven mitts.

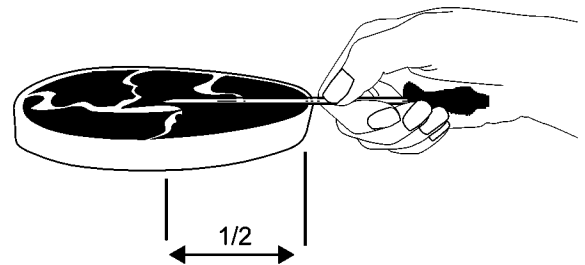

Figure 22: Measure with probe to insert half way into meat

The probe receptacle is located at the top of the oven cavity as shown in (Figure 23).

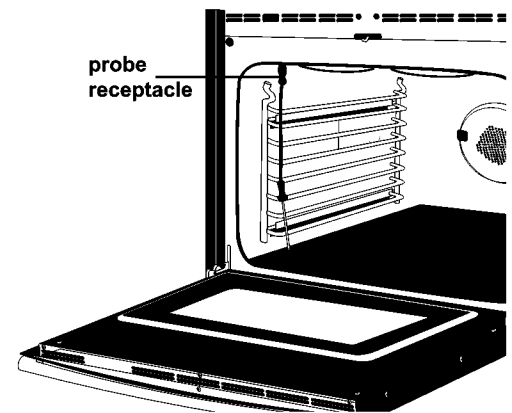

Figure 23: Probe receptacle top left of oven cavity

Setting the Probe

See the example below to set the probe target temperature to 180°F (82°C) when using the convection roast feature with oven set temperature for 325°F (162°C).



The default internal temperature when setting the probe is 170°F (76°C).

1. Insert the probe into the food and place the food into the oven of your choice.
2. Plug the **probe** completely into the **probe receptacle** inside the oven and close the oven door.
3. Press the selected oven for probe **UPPER** or **LOWER OVEN**.
4. Press **conv roast**.
5. Enter **3 2 5** using numeric keys.
6. Press **cook options**.
7. Press **probe**. The default temperature of 170°F will appear in the display.
8. Enter **180** using numeric keys.
9. Press **START**.

**conv
roast**

325

probe

180



START

IMPORTANT! By default, your oven will adjust to the warm oven setting once the probe has reached the set temperature.

- When the meat probe is connected to the receptacle and a cooking function is started, the display will show the current temperature reported by the meat probe.

To adjust the meat probe set temperature during this time if needed:

1. Press **probe**, (target temperature will appear)
2. Use **hi +**, **lo -** or **numeric keys** to raise or lower the set internal temperature.
3. Press **START** to accept.

Recommended Internal Temperatures

Food type	Internal Temp
Beef, veal, lamb-roasts, steaks and chops	
Medium	160°F (71°C)
Well done	170°F (76°C)
Fresh pork-roasts, steaks, and chops	
Medium	160°F (71°C)
Well done	170°F (76°C)
Ham	160°F (71°C)
Poultry	
Whole chicken, turkey	165°F (74°C)
Poultry breasts, roasts	165°F (74°C)
Stuffing (cooked alone or in bird)	165°F (74°C)
Leftovers	165°F (74°C)

Information courtesy the U.S. Department of Agriculture Food Safety and Inspection Service.

The U.S. Department of Agriculture states, "Rare fresh beef is popular, but you should know that cooking it to only 140°F/60°C means some food poisoning organisms may survive." (Source: Safe Food Book, Your Kitchen Guide, USDA Rev. June 1985.) The lowest temperature recommended by the USDA is 145°F/ 63°C for medium rare fresh beef.

⚠ WARNING

FOOD POISONING HAZARD. Do not let food sit for more than one hour before or after cooking. Doing so may cause bacteria to grow which can result in food poisoning or other illness.

Setting Defrost

Only frozen foods that can be defrosted and served without cooking should be used with this feature. Use the defrost feature to thaw small portions of delicate items such as cream cakes, frozen cream pies and cheesecake at room temperature. While in the defrost mode, the convection fan will operate to circulate room temperature air around the food, accelerating the natural defrosting of the food without using heat.

Defrost may be set with the following options:

- Cook time
- Cook time with end time

To set defrost:

1. Place food in **UPPER** or **LOWER OVEN**.
2. Press **defrost**.

defrost

3. Press **START**.



START



You may press **CANCEL** any time when setting the control or during the cooking process.

CAUTION

This feature is not meant for thawing frozen meats, poultry, seafood or other foods that need to be cooked before serving. Follow USDA recommendations for thawing foods.

Setting Dehydrate

The dehydrate feature dries with heat from the elements. The heat is circulated throughout the oven by the convection fan. Use dehydrate to dry and/or preserve foods such as fruits, vegetables, herbs and very thin slices of meat.

The following temperature settings apply to the dehydrate feature:

- Auto-suggest (default) setting: 120°F(48°C)
- Minimum dehydrate setting: 100°F(38°C)
- Maximum dehydrate setting: 225°F(108°C)

Dehydrate may be set with the following options:

- Cook time
- Cook duration with end time

To set dehydrate at the default temperature of 120°F:

1. Place food in **UPPER** or **LOWER OVEN**.
2. Press **dehydrate**.
3. Press **START**.

de-
hydrate



START

To turn off dehydrate at any time press **CANCEL**.

To add or change any cook settings after this feature has started:

- To change temperature settings, use the **hi +** or **lo-** keys on either side of the zero (**0**) on the numeric keypad to increase or decrease the oven temperature. The oven temperature will change by 5°(F) with each press of **hi +** or **lo -** key.
- If changing cooking times, select the cook duration or end time keys needed to make the changes.

For best results when using the dehydrate function:

- Dry most fruits and vegetables at 140°F. Dry herbs at 100°F. Drying times vary depending on the moisture and sugar content of the food, the size of the pieces, the amount being dried and the humidity in the air.
- Treat fruits with antioxidants to avoid discoloration.
- Tightly woven cooling racks can be used to allow the air to circulate around the food; or use drying racks to allow the air to circulate around the food (this type of oven rack is not supplied with this appliance). Consult a food preservation book or your local library for information.
- The convection fan will turn off when the door is opened. be sure to not open the oven door too often during the dehydrating process. The fan will resume operating when the door is closed.

Setting Bread Proof

The bread proof feature maintains a warm environment useful for rising yeast-leavened products. This function can be set in both the upper and lower oven.

The following temperature settings apply to the bread proof feature:

- Auto-suggest (default) setting: 100°F (38°C)
- Minimum bread proof setting: 85°F (30°C)
- Maximum bread proof setting: 100°F (38°C)

Bread proof may be set with the following options:

- Cook duration
- Cook duration with end time

For best results:

- Lightly cover the dough.
- Place a bowl of hot water on the rack below.
- Use the oven light to check progress. Do not open the oven door.

To set bread proof for 85°F (30°C)

1. Select **UPPER** or **LOWER OVEN** and place bread dough in oven.
2. Press **bread proof**. The default temperature of 100°F will appear in the display.
3. Enter **85** using the numeric keys (or use the **lo -** key next to the zero (**0**) on the numeric keypad and press until 85 appears in the display.
4. Press **START**.
5. To cancel at any time press **CANCEL**.

bread
proof

85



START

Slow Cook

The slow cook feature is used to cook foods slowly using lower temperatures. The cooking results will be much like that of a slow cooker. This feature is ideal when roasting beef, pork or poultry. Slow cook may be set with the following options:

- Cook duration
- Cook duration with End time
- Probe

⚠ CAUTION

FOOD POISONING HAZARD. Do not let food sit for more than one hour before or after cooking. Doing so may cause bacteria to grow which can result in food poisoning or other illness.

The following temperature settings apply to the slow cook feature:

- High: 275°F (134°C) use for cooking 4 to 5 hours
- Low: 225°F (108°C) use for cooking 8 to 9 hours

To set slow cook with low setting:

1. Position oven racks and cookware in oven. Close the oven door. Select **UPPER** or **LOWER OVEN**.
2. Press **slow cook** key. **HI** will appear in the oven display indicating the default setting is for high heat. If a low setting is needed, press the **hi +** or **lo -** key again to select the **LO** setting and release.

slow
cook



Figure 24: Slow cook settings

To stop slow cook at any time press **CANCEL**.

To add or change any cook settings after slow cook has started:

1. Press the **hi +** or **lo -** key on either side of the zero (**0**) on the numeric keypad again to toggle between the **Hi** or **Lo** setting and release.
- Slow cooking meats may result in the outside of the meat turning dark; this is normal. Completely thaw all frozen foods before cooking.
 - Arrange food in center of oven. Position multiple racks to accommodate size of cookware when cooking multiple food items. Add any cream or cheese sauces during the last hour of cooking.
 - Do not open the oven door often or leave the oven door open when checking food items. This can extend cooking time. Cover foods to keep them moist or use a loose or vented cover to allow foods to turn crisp or brown. Roasts may be left uncovered so browning can occur. Cook times will vary depending on the weight, fat content, bone and the shape of the roast. Preheating the oven is not necessary when using **slow cook**.

Warm Oven

Use the warm oven feature to keep hot foods warm. Warm oven may be set in the upper or lower oven with the following options:

- Cook duration
- Cook duration with end time

⚠ WARNING

FOOD POISONING HAZARD. Do not food let sit for more than one hour before or after cooking. Doing so may cause bacteria to grow which can result in food poisoning or other illness.

The following temperature settings apply to the warm oven feature:

- Auto-suggest default setting 170°F (76°C)
- Minimum warm oven setting 150°F (66°C)
- Maximum warm oven setting 190°F (88°C)

To set warm oven with the default setting:

1. Press **UPPER** or **LOWER OVEN** first.
2. Press **warm oven** to activate the warm oven function. The default temperature of 170°F will appear in the display.
3. Press **START**.



START

To set warm oven with a setting of 150°F:

1. Press **UPPER** or **LOWER OVEN** first. Press **warm oven** to activate the warm oven function.
2. Press **lo (-)** until the temperature shows **150** in the display.
3. Press **START**.



START

If changing cooking times, select the **cook duration** or **end time** keys needed to make changes.

To end warm oven at any time press **CANCEL**.

Warm Oven Temperature Selection

See the recommended settings chart below for **warm oven**. If a particular food is not listed, use the default temperature of 170°F. If more crispness is desired, remove the lid or aluminum foil from the food.

Most foods can be kept at serving temperatures using the default temperature of 170°F.

When a combination of foods are to be kept warm (for example a meat with 2 vegetables and rolls) use 170°F.

Warm Oven Recommended Food Settings

Food Item	Heating Level
Hot beverages	hi 190°F (86°C)
Fried foods	hi 190°F (86°C)
Vegetables	med 170°F (76°C)
Soups (Cream)	med 170°F(76°C)
Stews	med 170°F(76°C)
Sauces	med 170°F (76°C)
Meats	med 170°F (76°C)
Gravies	lo 150°F (66°C)
Eggs	lo 150°F (66°C)
Dinner plates with food	lo 150°F (66°C)
Casseroles	lo 150°F (66°C)
Breads and pastries	lo 150°F (66°C)

Setting Multi Stage

Multi stage will allow you to program up to 3 stages of cooking. Each stage may be programmed with a cooking feature, set temperature and a cook duration.

Multi stage is ideal when you want to add a warm oven after a cooking function.

This feature allows three types of cooking needs to be met. For example, the first stage might be a short duration with a higher than normal cooking temperature to rapidly start the cooking process. A second stage at a normal temperature would allow for a longer, more normal cooking time. A final stage can be set for holding the cooked food at serving temperature by setting warm oven as the final stage. If **broil** is used for any of the multi-stage settings the maximum allowable time is 10 minutes.

The following functions may be set with multi stage:

- Bake/conv bake
- Broil or conv broil (10 minutes maximum)
- Conv roast
- Warm oven

Be sure to follow recipe suggestions when determining how to best set the multi stage function.

Example of a (2) multi stage feature for a casserole.

- **For stage 1**, bake at 400°F (204°C) for 1 hr.
- **For stage 2**, to brown, broil for at 500°F (260°C) for 4 minutes using 2 stages of this feature:

1. Press **UPPER** or **LOWER OVEN**.
2. Press **multi stage**.

**multi
stage**

----- stage 1 -----

3. Press **bake**.
4. Enter **400°F**.
5. Press **START**.

**bake
400**



6. Enter **60 minutes**.
7. Press **START**.

60



This sets the first stage of cooking and stage 2 will show in the display allowing you to program the desired next step

----- stage 2 -----

8. Press **broil**.
9. Enter **500°F**.
10. Press **START**.

**broil
500**



START

11. Enter **4 minutes**.
12. Press **START**.

4



START

To stop multi stage cooking at any time press **CANCEL**.

Setting Multi Stage for 3 Stages

When all three stages of cooking are preferred, setting the multi stage feature requires a few easy steps. Each stage may be programmed with a cooking feature, set temperature and a cook duration. Using 3 stages is ideal when you want to add a **warm oven** after using two cooking functions.

For example: to program a (3 stage) multi stage feature for a casserole.

- **For stage 1**, bake at 375°F (190°C) for 1hr.
- **For stage 2**, to brown, broil for at 500°F (260°C) for 4 minutes.
- **For stage 3**, warm oven at 170°F (77°C) for 15 minutes.

----- stage 1 -----

1. Press **UPPER** or **LOWER OVEN**.
2. Press **multi stage**.

**multi
stage**

3. Press **bake**.
4. Enter **375°F**.
5. Press **START**.

**bake
375**



**START
60**

6. Enter **60 minutes**.
7. Press **START**.



START

----- stage 2 -----

8. Press **broil**.
9. Enter **500°F**.
10. Press **START**.

**broil
500**



**START
4**

11. Enter **4 minutes**.
12. Press **START**.



START

----- stage 3 -----

13. Press **warm oven**.
14. Press **START**.



**START
15**

15. Enter **15 minutes**.
16. Press **START**.



START

Stage one will start the bake stage for the time duration of one hour then switch to the broil for 4 minutes before switching to the warm oven stage.

The warm oven stage will turn off automatically after 15 minutes.

My Favorite

The **my favorite** feature stores and recalls up to three favorite recipe settings in each of the ovens. This feature will only store or recall one favorite recipe at a time.

My favorite feature may be used with the following:

Bake

Cook duration

Convection bake

Convection roast

Slow cook,

Warm oven

My favorite will not work with any other features including end time, broil or clean.

To set a favorite recipe (example: bake for 30 minutes with oven temperature of 325°F (162°C):

1. Select **UPPER or LOWER OVEN** and press **bake**. The default temperature of **350** will appear in the display.

bake

2. Enter **325** using numeric keys.

325

3. Press **cook options**.

4. Press **cook duration**.

**cook
duration**

5. Enter **30** minutes using numeric keys.

30

6. Press **START**.



START

7. To store the recipe, press and hold a **my favorite** key for 3 seconds and release when you hear acceptance tone.



To use a saved favorite recipe setting:

1. Select **UPPER or LOWER OVEN**.
2. Press the **my favorite** of your choice.
3. The saved recipe will appear in the display.
4. Press **START**.



To erase a favorite recipe setting:

Select oven in which the recipe you want to cancel is stored. Press **my favorite** and hold until the my favorite key beeps and the light turns off.



If a different favorite recipe is needed, you may record a new recipe over the old.

IMPORTANT! If you do not wish the oven to start the recipe when saving my favorite, be sure to press CANCEL for the last step.

Setting the Sabbath Mode

(For use on Jewish Sabbath and Holidays)

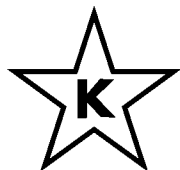

For further assistance, guidelines for proper usage and a complete list of models with the Sabbath feature, please visit the web at www.star-k.org.

This appliance provides special settings for use when observing the Jewish Sabbath/Holidays. Sabbath mode disables all audible

tones or visual display changes on the oven control. **Bake** is the only feature available while in the Sabbath mode.

You must first set the bake feature and temperature(s) needed for the oven, the cook duration option if needed, before setting the Sabbath mode. Any settings made prior to setting the Sabbath mode will be visible in the displays. The cook duration option, if set prior to the Sabbath mode, will give one audible alert at the end of cook duration.

The Sabbath mode will override the factory preset 12 Hour Energy Saving mode and the appliance will stay on until the cooking features are canceled. If any of the cooking features are canceled when the appliance is in the Sabbath mode, no audible or visual indicators will be available to verify the cancellation.

If the oven interior lights are needed, be sure to activate them prior to setting the Sabbath mode. Once the oven light is turned on and the Sabbath mode is active, the oven light will remain on until the Sabbath mode is turned off and the oven lights are turned off. The oven door will not activate the interior oven lights when the oven door is opened or closed.

It is recommended that any oven temperature modification made within an active Sabbath mode be followed with 2 presses of the **START** key. This will ensure the oven remains on even if an attempt is made to set the oven temperature outside of its temperature range. If the oven temperature is set outside of the temperature range, the oven will default to the nearest available temperature. Try to set the desired oven temperature again.

To set the oven for Sabbath mode to bake at 325°F(162°C):

1. Be sure the clock is set to the correct time of day.
2. Select **UPPER** or **LOWER OVEN**.
3. Press **bake**.
4. Enter **3 2 5** using numeric keys.
5. Press **START**.

3 2 5



START

6. If you need to add a cook duration or end time or both, proceed to the next step before entering the Sabbath mode.
7. Press **cook options**.
8. Enter the **cook duration** or **end time** settings. If entering both a cook duration and end time to set a delay bake, the oven will calculate the start time automatically.

9. Press **START**



START

10. To enter **Sabbath mode**, press and hold both the **lo -** and **hi +** keys together for 3 seconds. A tone will sound. Release the keys. Once properly set in Sabbath mode, **SAb** will show in the oven display.

SAb

Figure 25: Oven in Sabbath mode

You may change the oven temperature once baking has started and is in Sabbath Mode.

1. Press the **hi +** or **lo -** key on either side of the zero (0) on the numeric keypad.
2. Each press of the key will raise (+) or lower (-) the temperature in 5°F increments.

Remember that the oven control will no longer have audio or display further changes once the oven is set in Sabbath mode. All previously set features in the oven will automatically cancel once Sabbath mode has ended.

IMPORTANT! Remember the oven will shut off after completing a cook duration or end time and therefore may only be used once during the Sabbath/Jewish holidays. The maximum cook duration setting is 11 hours and 59 minutes.

Canceling Sabbath Mode

To cancel the Sabbath mode:

1. Press and hold both the **lo -** and **hi +** keys on either side of the zero (0) key on the **numeric keypad** together for 3 seconds. A tone will sound.
2. **Sab** will disappear from the display.

⚠ WARNING

FOOD POISONING HAZARD: Do not let food sit for more than one hour before or after cooking. Doing so may result in sickness or food poisoning.

What to do after a power failure or power interruption when Sabbath mode is active

Should a power failure or interruption occur during the Sabbath/Holidays, the appliance will shut off. **SF** will appear in the control display, indicating a Sabbath mode failure (Figure 26). Sabbath Failure mode will remain and the oven will not work until Sabbath mode is canceled.

SF

Figure 26: Display showing Sabbath failure

Adjusting the Oven Temperature

Your appliance has been factory calibrated and tested to ensure accurate baking temperatures. For the first few uses, follow your recipe times and temperature recommendations carefully. If you think the oven is cooking too hot or too cool for your recipe times, the control may be adjusted so the oven cooks hotter or cooler than the temperature displayed. The temperature may be increased +35°F (+19°C) or decreased -35°F (-19°C) by adjusting the **User Programmable Offset (UPO)**.

IMPORTANT! Do not use oven thermometers such as those found in grocery stores to check the temperature settings inside your oven. These oven thermometers could vary as much as 20° to 40° from actual oven temperatures.

How to offset the oven temperature by +30°F:

1. Select **UPPER** or **LOWER OVEN**.
2. Press **user pref** until **UPO** appears in the display. The default setting of **0** (zero) should display next to UPO. To increase the oven to cook 30 degrees hotter, press the **hi +** key until the UPO shows **30** in the oven selected.
3. To accept change, press **START**.
4. Press **CANCEL** to return the oven to programming mode.



Figure 27: Oven temperature offset by +30°

How to offset oven temperature by -30°F:

1. Select **UPPER** or **LOWER OVEN**.
2. Press **user pref** until **UPO** appears in the display. To decrease the oven to cook 30 degrees cooler, press the **lo -** key until the UPO shows **- 30**.
3. To accept change, press **START**.



Figure 28: Oven temperature offset by -30°



Oven temperature adjustments made by changing the UPO setting will not affect the broil or clean feature temperatures. UPO settings can be made for each oven individually.

Restoring Control to Factory Default Settings

Your appliance is set with a number of predetermined oven control settings. Over time you may make changes to the original factory settings.

The following functions or features have user programmable options or adjustments that may have been changed from the default settings.

- Clock 12-hour or 24-hour display mode
- 12-Hour Energy Savings or continuous bake mode
- Tone volume
- Oven temperature display mode (F° or C°)
- Any oven temperature adjustment made
- Any saved **my favorite** recipes

IMPORTANT! Before restoring, be aware that any previous changes made to the oven control settings will be erased once the keypad is pressed. This includes any temperature offset made for the oven.

To restore factory default settings:

1. Press **user pref** key until **rSt no** or **rSt YES** appears in the display (Figure 29).
2. Press **hi +** until **rSt yES** appears in the display. Press **START** to accept.

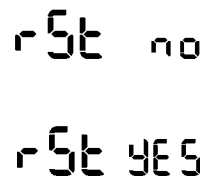

Figure 29: Display showing the options to reset to default (rSt yes) or to reject resetting to default (rSt no)

Before Starting Clean

Adhere to the following precautions before a clean cycle:

⚠ WARNING

Do not leave small children unattended near the appliance. During self clean the oven may become very hot to the touch. Do not touch the oven during the clean cycle.

⚠ WARNING

Do not force the oven door open when clean is active. This can damage the automatic door-locking system. Use caution when opening the door after cleaning. The oven may still be very hot and can cause burns. To avoid possible burns, stand to one side of the oven when opening the oven door to allow hot air or steam to escape.

⚠ CAUTION

The health of some birds is extremely sensitive to fumes given off during the clean cycle of any oven. Move birds to another well-ventilated room.

⚠ CAUTION

Do not line the oven walls, oven racks, oven bottom or any other part of the range with aluminum foil. Doing so will stop heat distribution, produce poor baking results and may cause permanent damage to the oven interior. Aluminum foil will melt to a hot oven surface during clean.

⚠ CAUTION

Clean any soil from the outer frame, the inside and outside of the door, the small area at the front and center of the oven bottom, and any areas outside the oven gasket. These areas heat sufficiently to burn on soils. Clean using soap and water before starting a self clean.

IMPORTANT! Remove **all items** from the oven including food, cookware, utensils, plastic, and any aluminum foil. Aluminum foil will not withstand high temperatures generated during the clean cycle and will melt.

Remove any excessive build up caused by spills. Any spill on the oven bottom should be wiped up and removed before starting a clean cycle. To clean, use hot, soapy water and a cloth. Large spill residue can cause heavy smoke or fire when subjected to high temperatures. Do not allow food spills with a high sugar or acid content (such as milk, tomatoes, sauerkraut, fruit juices, or pie filling) to remain on the surface as they may leave a dull spot even after cleaning.

⚠ CAUTION

Be sure the oven vent is clear. Be sure oven light shield is in place.

⚠ CAUTION

Do not clean the oven door gasket (Figure 30). Do not use any cleaning materials on the oven door gasket. Doing so may damage the gasket. The woven material of the oven door is essential for a good seal. Care should be taken not to rub, damage or remove the door gasket.

⚠ CAUTION

Do not use commercial oven cleaners or protective coatings of any kind inside oven. Residue from oven cleaners may damage the porcelain during the next clean cycle.

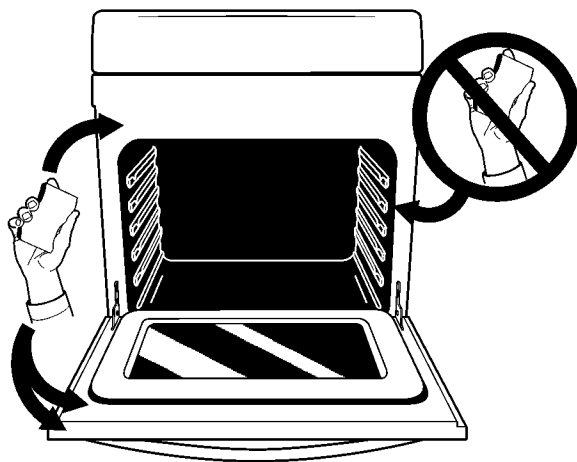

Figure 30: How to clean around oven gasket

Porcelain coated oven racks

- This oven comes with lubricated porcelain oven racks, which can remain in the oven during the clean cycle. Do not clean this vegetable oil lubrication off the racks. It is important that the sides of the oven racks always have a light coating of vegetable oil. To maintain optimal rack performance, re-apply a thin layer of vegetable oil to the sides of the rack after every clean cycle or when the rack becomes difficult to slide. Refer to "Caring for your porcelain enameled glide racks" on page 38.
- REMOVE RACKS** will flash in the display for several seconds as a reminder to remove the racks before starting a clean cycle. (Figure 31) It is recommended to remove racks from the oven during clean cycles, but porcelain racks may be left in the oven if they are soiled.

REMOVE RACKS

Figure 31: Reminder to remove racks before clean cycle

Setting Clean

A self cleaning oven automatically cleans itself using much higher temperatures than those used for cooking. The clean feature eliminates soils completely or reduces them to a fine powdered ash that, when the oven has cooled, can be wiped away easily with a damp cloth.

The clean function provides 3 different clean time settings for self cleaning. Set clean for 2 hours for light, 3 hours for normal or 4 hours for heavier soils.

To start a clean:

1. The oven should be empty and all oven racks removed. Be sure the oven door is completely closed.
2. Select **UPPER** or **LOWER OVEN**.
3. Press **clean**, then select clean preference:
 - **med** (normal) for a 3-hour clean
 - **heavy** for a 4-hour clean or
 - **lite** for a 2-hour clean.
4. **REMOVE RACKS** will flash in the display for several seconds as a reminder to remove the racks before starting a clean cycle. It is recommended to remove racks from the oven during clean cycles, but porcelain racks may be left in the oven if they are soiled. After a clean cycle, or anytime the gliding is rough, the glide racks should be treated with graphite lubrication. For instructions on how to care for your oven racks, see "Caring for your porcelain enameled glide racks" on page 38.
5. Press **START**.

Figure 32: 3 hour normal clean

Figure 33: 4 hour heavy clean

Figure 34: 2 hour light clean

Once active, the door lock motor will begin locking the oven door. **Loc** will appear in the display.

- Do not try to open the door when the **Loc** message is on (allow about 15 seconds for the oven door to completely lock).

- Do not force the oven door open. This could damage the door locking system. Once the oven door is locked the **CLn** message will appear in the display for the entire clean cycle.

When the clean cycle is finished:

1. The time of day and **Hot** will show in the display (Figure 35).
2. Once the oven has cooled (usually about 1 hour) and **Hot** is no longer displayed. When this message stops flashing in the display, the door is finished unlocking and may be opened.

Figure 35: Oven too hot for door to unlock

3. When the oven is cool, wipe away any residue or powdered ash from the oven interior using a damp cloth or paper towel.



A clean cycle will not start if the control lock feature is active. If a clean cycle was started but did not finish due to a power outage, your oven may not have completely cleaned.

To cancel clean:

1. Press  .
CANCEL
2. If the clean cycle has heated the oven to a high enough temperature, **Hot** (Figure 35) will appear in the display. Allow enough time for the oven to cool and the door to unlock before the oven door may be opened.

IMPORTANT! When the clean is over and the door unlocks, the oven may still be very hot. Be sure to stand to the side of the oven door when opening after a clean to allow hot air to escape. Wait until the oven has cooled thoroughly before wiping any residue from the oven bottom.

CAUTION

The oven bake and broil elements may appear to have cooled after the oven door is unlocked. The elements may still be hot and burns may occur if these elements are touched before they have cooled.

Setting Delayed Clean

You may wish to set the oven to perform a clean at a later time (up to 12 hours later). The end time key will determine when the cleaning will stop.

IMPORTANT! If you want to set a delayed clean to end between 12 and 24 hours, use the user pref key to set the 12hr energy saving mode (**ES**) to **Off** and also set the clock (**CLO**) to the **24 hr** mode.

The end time must be set far enough from the real time to allow for the type of clean cycle you select, whether 2, 3, or 4 hours. Remember to add 30 to 40 additional minutes of cooling time before using the oven for cooking.

In the example below, the clean will start at 4:00 o'clock. The number of hours before 4:00 o'clock will be the **delay time** before the clean begins.

Setting for a heavy (4 hour) clean cycle to end at 8:00 o'clock:

1. Be sure the clock is set with the correct time of day. In **this example the time of day should be earlier than 4:00 o'clock. Remove all oven racks.** Be sure the oven door is completely closed.

2. Press **UPPER** or **LOWER OVEN**.

3. Press **clean - heavy** (4hr).

•••
heavy

4. Press **cook options**.

5. Press **end time**.

6. Enter **8 0 0** using the numeric keys.

800

7. Press **START**.



START

8. The oven door will begin to lock and **CLn** will show in the display. Once locked, the oven will display the time remaining until clean begins. When the clean cycle begins, the display will show the time remaining in the clean cycle.

Press **CANCEL** at any time to stop clean

⚠ CAUTION

To avoid possible burns use caution opening the oven door after the clean cycle is finished. The oven may still be very hot. Stand to the side of the oven when opening the door to allow hot air to escape.

CARE AND CLEANING

Cleaning Recommendations

Surface	Type Cleaning Recommendation
Painted body parts Painted decorative trim Aluminum, plastic or vinyl trim	<ul style="list-style-type: none"> For general cleaning, use hot, soapy water and a cloth. For more difficult soils and built-up grease, apply a liquid detergent directly onto soil. Leave on soil for 30-60 minutes. Rinse with a damp cloth and dry. Do not use abrasive cleaners these surfaces; they can scratch.
Control panel Control key pad membrane Decorative trim (some models)	<ul style="list-style-type: none"> Before cleaning the control panel, turn all controls off, activate control lock (some models) and if needed remove knobs from panel (some models). Do not use abrasive cleaners on controls or trim; they can scratch. Clean using hot, soapy water and a dishcloth. Be sure to squeeze excess water from dishcloth before wiping control panel; especially when wiping around the controls area. Excess water in or around the controls may cause damage to the appliance. When rinsing, use clean water and a dishcloth and be sure to squeeze excess water from dishcloth before wiping the control panel.
Stainless Steel (some models)	<ul style="list-style-type: none"> Clean stainless with warm soapy water using a clean sponge or cloth. Rinse with clean water and dry with soft clean cloth. Do not use harsh scrubbing cleaners. Only use kitchen cleaners especially made for cleaning stainless steel. Always be sure to rinse cleaners from the surface as bluish stains may occur during heating that cannot be removed.
Porcelain enamel parts Broiler pan and broiler pan insert	<ul style="list-style-type: none"> Gentle scrubbing with a soapy non-abrasive cleaning pad will remove most spots. Rinse with a 1:1 solution of clear water and ammonia. If necessary, cover difficult spots with an ammonia-soaked paper towel for 30 to 40 mins. Rinse with clean water and a damp cloth, and then scrub with a soap-filled non-abrasive cleaning pad. Rinse and wipe dry with a clean cloth. Do not allow food spills with high sugar or acid content (milk, tomatoes, sauerkraut, fruit juices or pie filling) to remain on surfaces; they may cause a dull spot even after cleaning.
Porcelain coated oven racks	<ul style="list-style-type: none"> This oven comes with lubricated porcelain oven racks, which can remain in the oven during the clean cycle. Do not clean this vegetable oil lubrication off the racks. It is important that the sides of the oven racks always have a light coating of vegetable oil. To maintain optimal rack performance, re-apply a thin layer of vegetable oil to the sides of the rack after every clean cycle or when the rack becomes difficult to slide. Porcelain Glide racks may be left in the oven during a clean cycle. Anytime the gliding is rough, the glide racks should be treated with graphite lubrication as shown in "Caring for your porcelain enameled glide racks" on page 38.
Oven interior	<ul style="list-style-type: none"> Remove excessive spills from oven cavity bottom before starting clean. Clean any soils from oven frame and door liner outside the oven door gasket. For important preparation information be sure to read all the instructions in the self cleaning section.
Oven racks	<ul style="list-style-type: none"> Do not clean oven racks in oven during the self clean cycle. Remove and clean using a mild, abrasive cleaner following manufacturer's instructions. Thoroughly rinse and dry.
Oven door	<ul style="list-style-type: none"> Use soap and water to thoroughly clean the top, sides and front of the oven door. Rinse well. You may use a glass cleaner on the outside glass of the oven door. Do not immerse the door in water. Do not spray or allow water or glass cleaner to enter the door vents. To avoid scratches, do not use oven cleaners, cleaning powders or any harsh abrasive cleaning materials on the outside of the oven door. Do not clean the oven door gasket. On self cleaning models the oven door gasket is made of a woven material which is essential for a good seal. Care should be taken not to rub, damage or remove this gasket.

General Cleaning

Before manually cleaning any part of the oven, be sure all controls are turned off and the oven is cool.

Aluminum Foil and Oven Liners

Do not use oven bottom liners or use aluminum foil to cover the oven racks.

⚠ CAUTION

Protective liners—Do not use aluminum foil to line the oven bottom, except as suggested in the manual. Improper installation of these liners may result in a risk of electrical shock, or fire.

Using a liner in the oven restricts the heat and air flow needed to obtain the best possible cooking results for any oven.

During clean the oven temperature can become hot enough to melt aluminum cooking utensils or aluminum foil if left in the oven. This could result in permanent damage to the oven interior and porcelain finish.

Replacing the Oven Lights

Replacing the Dual Left and Right Corner Oven Lights

There are two interior oven lights located at the rear of the oven cavity and are covered with a glass shield. The glass shield must be in place whenever the oven is in use (Figure 36).

To replace the oven interior light bulb:

⚠ CAUTION

Be sure the oven is unplugged and all parts are cool before replacing oven light. Wear a leather-faced glove for protection against possible broken glass.

1. Turn electrical power off at the main source or unplug the appliance
2. Remove interior oven light shield by turning a quarter turn counter-clockwise.
3. Replace bulb with a new T-4 type Halogen 25 watt appliance bulb.

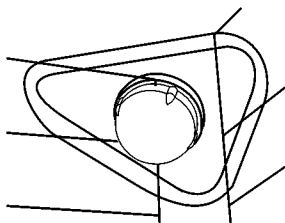

Figure 36: Oven light in rear of cavity

i

Do not allow your fingers to touch the new bulb when replacing. This will shorten the life of the bulb. Use a paper towel or cotton glove while handling the new bulb when installing.

4. Replace glass oven light shield by rotating clockwise.
5. Turn power back on again at the main source (or plug the appliance back in).
6. Reset the time of day on the clock.

Replacing the Dual Left or Right Side Oven Lights

An interior oven light will turn on automatically when the oven door is opened. The oven light may be turned on when the door is closed by using the oven light switch located on the control panel.

i

The lamp is covered with a glass shield. The glass shield can be removed to be cleaned manually or to change the oven light.

To replace the oven interior light bulb:

⚠ CAUTION

Be sure the range is unplugged and all parts are cool before replacing oven light. Wear a leather-faced glove for protection against possible broken glass.

1. Turn electrical power off at the main source or unplug the appliance.
2. To remove the glass shield, pull the back side of the shield toward the inside of the oven in a manner to lift it up from the oven side. The glass shield should come out easily by pushing a little toward front of the wall oven (See Figure 37).
3. Replace the Halogen appliance bulb.

i

Do not allow your fingers to touch the new bulb when replacing. This will shorten the life of the new bulb. Use a paper towel to cover the new bulb when installing.

4. Replace glass interior oven light shield.
5. Turn power back on again at the main source (or plug the appliance back in).
6. Be sure to reset the time of day on the clock.

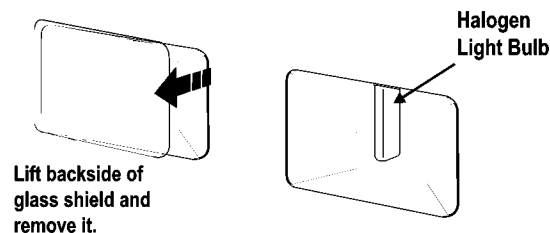

Figure 37: Light shield (L) and Halogen bulb (R)

Removing and Replacing the Oven Door

⚠ CAUTION To prevent possible burns, do not attempt to remove the oven door until the oven has completely cooled.

⚠ WARNING The oven door is heavy. Be careful when removing and lifting the door. Do not lift the oven door by the handle.

To remove the oven door:

1. Open oven door completely (Figure 38).
2. Pull the hinge locks on both left and right hinges down from the oven frame completely towards the oven door (Figure 40). A tool such as a small flat-blade screwdriver may be required.
3. Firmly grasp both sides of oven door along the door sides (Do not use the oven door handle).(Figure 41)
4. Before completing this step, be prepared to hold the whole weight of the door while grasping the sides of the oven door with both hands. Hold midway down the oven door sides. Close the oven door to about 4 inches from the door frame. The oven door should release from the frame on its own. (Figure 41).
5. With the oven door in this position, lift and carefully pull the oven door away from the oven frame. To avoid finish damage, be careful not to allow the oven door hinges to contact the front of the oven frame. After door has been removed, be sure to lay the door flat with the inside of the door downward (never rest the oven door with any weight on the door handle).

To replace oven door:

1. Firmly grasp both sides of oven door along the door sides. (Do not use the oven door handle).
2. Position the angle of the door to the door removal angle and carefully insert the door hinge arms fully and evenly into the door hinge slots. Carefully let the weight of the door transfer from your hands so that the oven now supports the oven door. (Figure 41).
3. Open the oven door down to the fully open position. (Figure 38).
4. Push both the door hinge locks up towards and into the oven frame to the locked position (Figure 39).
5. Close the oven door.

Special door care instructions - Most oven doors contain glass that can break.

Read the following recommendations:

- Do not close the oven door until all the oven racks are fully in place.
- Do not hit the glass with pots, pans, or any other object.
- Scratching, hitting, jarring or stressing the glass may weaken its structure causing an increased risk of breakage at a later time.

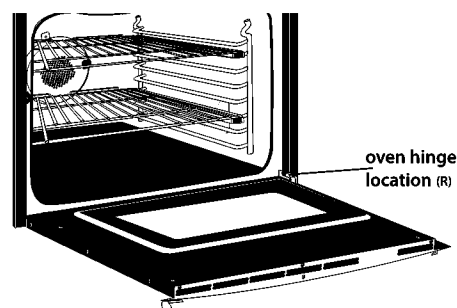

Figure 38: Oven hinge locations

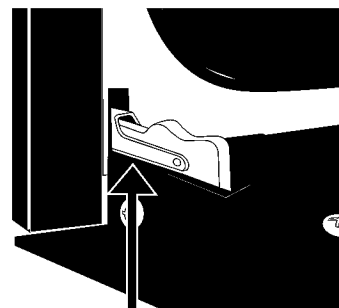

Figure 39: Hinge in locked position

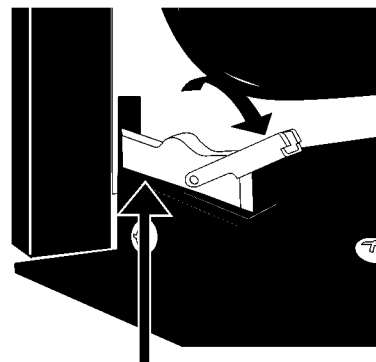

Figure 40: Unlock hinges to remove door

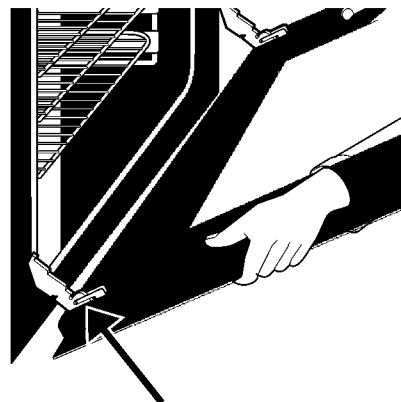

Figure 41: Carefully remove door grasping both sides and pulling hinges from door frame

Caring for your porcelain enameled glide racks

⚠ CAUTION

Handle oven racks only when they are cool.

After cooking or after the self clean cycle, racks will be very hot and can cause burns.

Important Notes:

- It is recommended to remove all racks from the oven during self-clean cycles, but porcelain racks may be left in the oven if they are soiled. After a self clean cycle, or anytime the gliding is rough, the glide racks should be treated with graphite lubrication.
- Do not use cooking oil, cooking spray, or other oil-based lubrication products on the glide rack extension tracks. Use only the graphite lubrication in this area.
- It is important that the parts of the rack that contact the oven sides always have a light coating of vegetable oil. Apply a thin layer of vegetable oil to the sides of the rack after every self-clean cycle and when the rack becomes difficult to reposition in the oven.

To lubricate the glide rack:

1. Remove the rack from the oven and place the rack on a large flat surface covered with newspaper or scrap cloth. Fully extend the rack.
2. Wipe away debris and crumbs from the glide track using a cloth or sponge.

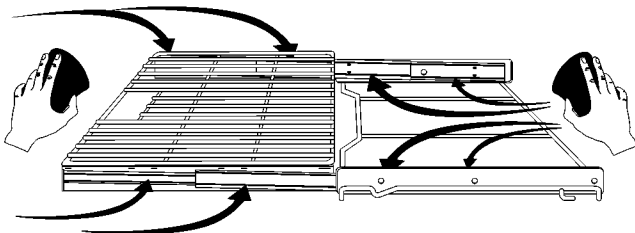

3. Shake graphite lubrication very well before applying. Place four drops of graphite lubrication along the tracks (see area circled on figure below). Repeat on both sides of the glide rack.

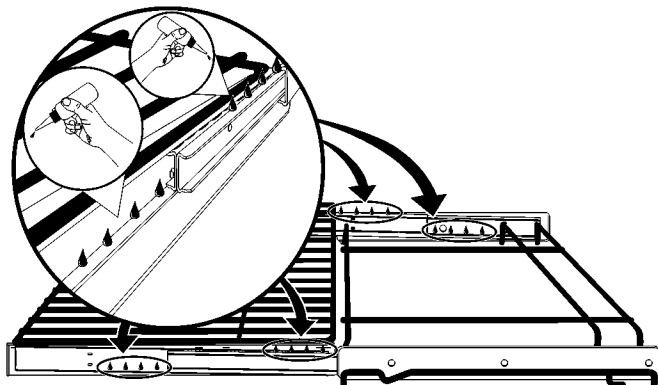

4. Extend and return the glide rack several times along the tracks to distribute the lubrication.

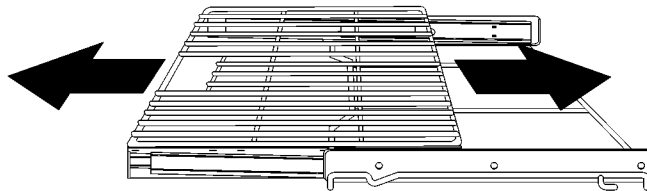

5. Turn glide rack over. Shake graphite lubrication very well before applying. Place four drops of graphite lubrication along the tracks. Repeat on both sides of the glide rack.

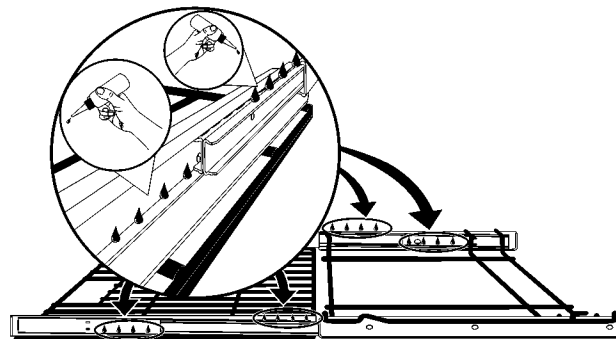

6. Extend and return the glide rack several times along the tracks to distribute the lubrication.

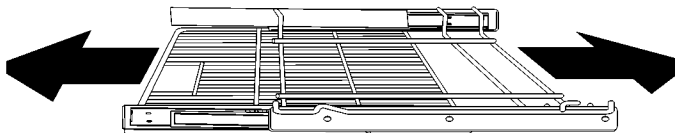

7. Apply a thin layer of cooking oil to the outer frame of the glide rack as shown below. Keeping the frame sides lightly lubricated allows the entire rack to slide easily when changing rack positions.

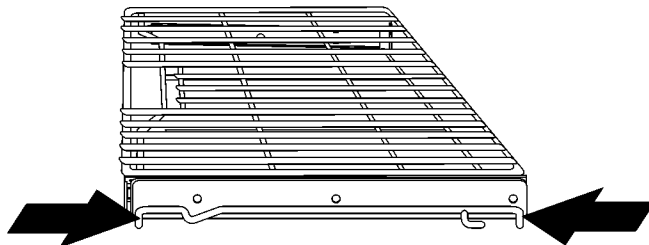

8. Replace rack in oven right side up.

SOLUTIONS TO COMMON PROBLEMS

Before You Call

Baking Problems and Solutions

For best cooking results, heat the oven before baking cookies, breads, cakes, pies or pastries, etc. There is no need to preheat the oven for roasting meat or baking casseroles.

The cooking times and temperatures needed to bake a product may vary slightly from your previously owned appliance.

Cookies and biscuits burn on the bottom.



- Cookies and biscuits put into oven before the preheating time is completed.
- Oven rack is overcrowded.
- Dark pans absorb heat too fast.
- Allow oven to preheat to desired temperature before placing food in oven.
- Choose pan sizes that will permit 2" to 4" of air space (5.1 cm o 10.2 cm) on all sides when placed in the oven.
- Use a medium weight baking sheet.

Cakes too dark on top or bottom.

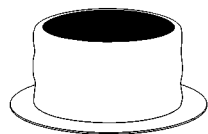

- Cakes put in oven before preheating time is completed.
- Rack position too high or too low.
- Oven too hot.
- Allow oven to preheat to the selected temperature before placing food in the oven.
- Use proper rack position for baking needs.
- Set oven temperature 25°F/13°C lower than recommended.

Cakes not done in center.

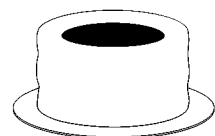

- Oven too hot.
- Incorrect pan size.
- Pan not centered in oven.
- Set oven temperature 25°F/13°C lower than recommended.
- Use pan size suggested in recipe.
- Use proper rack position and place pan so there is 2" to 4" (5.1 cm to 10.2 cm) of space on all sides of pan.

Cakes not level.



- Oven not level.
- Pan too close to oven wall or rack overcrowded.
- Pan warped.
- Oven light left on while baking.
- Place a marked glass measuring cup filled with water on the center of the oven rack. If the water level is uneven, refer to the installation instructions for leveling the oven.
- Be sure to allow 2" to 4" (5.1 cm to 10.2 cm) of clearance on all sides of each pan in the oven.
- Do not use pans that are dented or warped.
- Turn off oven light while baking.

Foods not done when cooking time is over.

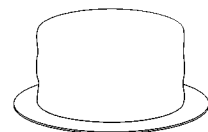

- Oven too cool.
- Oven overcrowded.
- Oven door opened too frequently.
- Set oven temperature 25°F/13°C higher than suggested and bake for the recommended time.
- Be sure to remove all pans from the oven except the ones to be used for baking.
- Open oven door only after shortest recommended baking time.

Before you call for service, review the following list. The list includes common occurrences that are not the result of defective workmanship or materials in this appliance. It may save you time and expense.

Problem	Solution
Appliance is not level	<ul style="list-style-type: none"> • Be sure floor of the cabinet or built-in is level, strong and stable enough to adequately support oven. If floor is sagging or sloping, contact a carpenter to correct the situation. • Poor installation. • Kitchen cabinet alignment may make oven appear not level. Be sure cabinets are square and have sufficient room for appliance clearance.
Cannot move appliance easily. Appliance must be accessible for service	<ul style="list-style-type: none"> • Cabinets not square or are built in too tightly. Contact builder or installer to make appliance accessible.
Entire appliance does not operate	<ul style="list-style-type: none"> • The time of day is not set. The time of day must first be set in order to operate the oven. See "Setting the Clock" in the Setting Oven Controls section. • Make sure cord is plugged or wired correctly into outlet. • Service wiring is not complete. Contact your dealer, installing agent or authorized service agent. • Electrical power outage. Check house lights to be sure. Call your local electric company for service.
Oven does not operate	<ul style="list-style-type: none"> • Be sure the oven controls are set properly for the desired cooking feature. See "Setting Oven Controls" in this Use and Care Guide or read the instructions "Entire appliance does not operate" in this checklist.
Oven light does not work	<ul style="list-style-type: none"> • Replace or tighten bulb. See "Replacing the Dual Left or Right Side Oven Lights" in this Use and Care Guide.
Flames inside oven or smoking from oven vent	<ul style="list-style-type: none"> • Excessive spills in oven. For example this will happen for pie spills or large amounts of grease left on the oven bottom. Wipe up excessive spills before starting oven. If flames or excessive smoke are present see "Broil" in the Setting Oven Controls section.
Oven control panel beeps and displays any F code error (for example F10)	<ul style="list-style-type: none"> • Oven control has detected a fault or error condition. Press CANCEL to clear the display and stop beeping. Try the bake or broil feature again. If F code error repeats, remove power supply to appliance, wait 5 minutes and then repower the appliance. Set clock for the time of day. Try the bake or broil feature again. If the fault recurs, record fault code and call for service.
Oven racks do not slide easily	<ul style="list-style-type: none"> • This oven comes with lubricated porcelain oven racks, which can remain in the oven during the clean cycle. Do not clean this vegetable oil lubrication off the racks. It is important that the sides of the oven racks always have a light coating of vegetable oil. To maintain optimal rack performance, re-apply a thin layer of vegetable oil to the sides of the rack after every clean cycle or when the rack becomes difficult to slide.
Glide racks do not slide smoothly	<ul style="list-style-type: none"> • Glide racks need lubrication. For instructions on how to care for your oven racks, See "Caring for your porcelain enameled glide racks" on page 38.

Questions or for service call: 1-877-4 ELECTROLUX (1-877-435-3287)

Problem	Solution
Poor Baking results	<ul style="list-style-type: none">• Many factors effect baking results. Use proper oven rack position. Center food in the oven and space pans to allow air to circulate. Preheat oven to the set temperature before placing food in the oven. Try adjusting the recipe's recommended temperature or baking time. See "Adjusting the Oven Temperature" on page 31 if you feel the oven is too hot or cold.• If your oven is cooking poorly, or clean is performing badly, perform the following check: Press Broil; Press START. Place your hand near the handle on the oven door. Between the door and the control panel you should feel a rush of air on your hand. If so, your unit is functioning properly and you have had a Power Failure in your home. If no air stream is present, call a service technician to replace your cooling fan
Oven smokes excessively during broiling	<ul style="list-style-type: none">• Control not set properly. Follow broiling instructions under "Broil" in "Setting Oven Controls".• Meat too close to the broil element. Reposition the broil rack to provide proper clearance between the meat and the element. Preheat the broil element for searing. Meat not properly prepared. Remove excess fat from meat. Cut remaining fatty edges to prevent curling, but do not cut into lean.• Insert on broiler pan wrong side up and grease not draining. Always place grid on the broiler pan with ribs up and slots down to allow grease to drip into pan (some models). Grease has built up on oven surfaces. Regular cleaning is necessary when broiling frequently. Old grease or food spatters cause excessive smoking.
Clean does not work or is performing poorly	<ul style="list-style-type: none">• Review steps for "Before Starting Clean" beginning on page 32.• Perform the following check: Press Broil; Press START. Place your hand near the handle on the oven door. Between the door and the control panel you should feel a rush of air on your hand. If so, your unit is functioning properly and you have had a Power Failure in your home. If no air stream is present, call a service technician to replace your cooling fan.

Questions or for service call: 1-877-4 ELECTROLUX (1-877-435-3287)

WARRANTY

Your appliance is covered by a one year limited warranty. For one year from your original date of purchase, Electrolux will repair or replace any parts of this appliance that prove to be defective in materials or workmanship when such appliance is installed, used, and maintained in accordance with the provided instructions. In addition, the glass cooktop or radiant surface element of your appliance (excluding built-in and free-standing range appliances) is covered by a two through five year limited warranty. During the 2nd through 5th years from your original date of purchase, Electrolux will provide a replacement glass cooktop or radiant surface element for your appliance which has proven to be defective in materials or workmanship when such appliance is installed, used, and maintained in accordance with the provided instructions.

Exclusions

This warranty does not cover the following:

1. Products with original serial numbers that have been removed, altered or cannot be readily determined.
2. Product that has been transferred from its original owner to another party or removed outside the USA or Canada.
3. Rust on the interior or exterior of the unit.
4. Products purchased "as-is" are not covered by this warranty.
5. Products used in a commercial setting.
6. Service calls which do not involve malfunction or defects in materials or workmanship, or for appliances not in ordinary household use or used other than in accordance with the provided instructions.
7. Service calls to correct the installation of your appliance or to instruct you how to use your appliance.
8. Expenses for making the appliance accessible for servicing, such as removal of trim, cupboards, shelves, etc., which are not a part of the appliance when it is shipped from the factory.
9. Service calls to repair or replace appliance light bulbs, air filters, water filters, other consumables, or knobs, handles, or other cosmetic parts.
10. Labor or in-home service costs during the additional limited warranty periods beyond the first year from your original date of purchase.
11. Pickup and delivery costs; your appliance is designed to be repaired in the home.
12. Surcharges including, but not limited to, any after hour, weekend, or holiday service calls, tolls, ferry trip charges, or mileage expense for service calls to remote areas, including the state of Alaska.
13. Damages to the finish of appliance or home incurred during transportation or installation, including but not limited to floors, cabinets, walls, etc.
14. Damages caused by: services performed by unauthorized service companies; use of parts other than genuine Electrolux parts or parts obtained from persons other than authorized service companies; or external causes such as abuse, misuse, inadequate power supply, accidents, fires, or acts of God.

DISCLAIMER OF IMPLIED WARRANTIES; LIMITATION OF REMEDIES

CUSTOMER'S SOLE AND EXCLUSIVE REMEDY UNDER THIS LIMITED WARRANTY SHALL BE REPAIR OR REPLACEMENT AS PROVIDED HEREIN. **CLAIMS BASED ON IMPLIED WARRANTIES, INCLUDING WARRANTIES OF MERCHANTABILITY OR FITNESS FOR A PARTICULAR PURPOSE, ARE LIMITED TO ONE YEAR OR THE SHORTEST PERIOD ALLOWED BY LAW, BUT NOT LESS THAN ONE YEAR.** ELECTROLUX SHALL NOT BE LIABLE FOR CONSEQUENTIAL OR INCIDENTAL DAMAGES SUCH AS PROPERTY DAMAGE AND INCIDENTAL EXPENSES RESULTING FROM ANY BREACH OF THIS WRITTEN LIMITED WARRANTY OR ANY IMPLIED WARRANTY. SOME STATES AND PROVINCES DO NOT ALLOW THE EXCLUSION OR LIMITATION OF INCIDENTAL OR CONSEQUENTIAL DAMAGES, OR LIMITATIONS ON THE DURATION OF IMPLIED WARRANTIES, SO THESE LIMITATIONS OR EXCLUSIONS MAY NOT APPLY TO YOU. THIS WRITTEN WARRANTY GIVES YOU SPECIFIC LEGAL RIGHTS. YOU MAY ALSO HAVE OTHER RIGHTS THAT VARY FROM STATE TO STATE.

If You Need Service

Keep your receipt, delivery slip, or some other appropriate payment record to establish the warranty period should service be required. If service is performed, it is in your best interest to obtain and keep all receipts. Service under this warranty must be obtained by contacting Electrolux at the addresses or phone numbers below.

This warranty only applies in the USA, Puerto Rico and Canada. In the USA and Puerto Rico, your appliance is warranted by Electrolux Major Appliances North America, a division of Electrolux Home Products, Inc. In Canada, your appliance is warranted by Electrolux Canada Corp. Electrolux authorizes no person to change or add to any obligations under this warranty. Obligations for service and parts under this warranty must be performed by Electrolux or an authorized service company. Product features or specifications as described or illustrated are subject to change without notice.

USA 1-877-435-3287

Electrolux Major Appliances North America
10200 David Taylor Drive
Charlotte, NC 28262

Canada 1-800-265-8352

Electrolux Canada Corp.
5855 Terry Fox Way
Mississauga, Ontario, Canada L5V 3E4

www.electrolux-store.com

