

## Use & Care Guide

Model No.

153.582400

40 Gallon Tall

153.582500

50 Gallon Tall



LOW LEAD  
CONTENT

# Kenmore® Electric Water Heater



For potable water heating only.

Not suitable for space heating.

**INSTALLER:** Affix these instructions to or near the water heater.

**OWNER:** Retain these instructions for future reference.

### ADVERTENCIA

Si no puede leer o entender el inglés y necesita el manual de instrucciones en español, puede solicitarlo al 1-800-821-2017. NO TRATE DE INSTALAR U OPERAR ESTE CALENTADOR DE AGUA SI NO ENTIENDE LAS INSTRUCCIONES. No hacer caso de esta advertencia podría originar lesiones graves o mortales.

P/N 100272307 (0516)

Sears Brands Management Corporation,  
Hoffman Estates, IL 60179 U.S.A.

[www.kenmore.com](http://www.kenmore.com)







# SAFE INSTALLATION, USE AND SERVICE

Your safety and the safety of others is extremely important in the installation, use and servicing of this water heater.

Many safety-related messages and instructions have been provided in this manual and on your own water heater to warn you and others of a potential injury hazard. Read and obey all safety messages and instructions throughout this manual. It is very important that the meaning of each safety message is understood by you and others who install, use or service this water heater.

	This is the safety alert symbol. It is used to alert you to potential personal injury hazards. Obey all safety messages that follow this symbol to avoid possible injury or death.
---	--

	DANGER indicates an imminently hazardous situation which, if not avoided, will result in death or injury.
	WARNING indicates a potentially hazardous situation which, if not avoided, could result in death or injury.
	CAUTION indicates a potentially hazardous situation which, if not avoided, could result in minor or moderate injury.
	CAUTION used without the safety alert symbol indicates a potentially hazardous situation which, if not avoided, could result in property damage.

All safety messages will generally tell you about the type of hazard, what can happen if you do not follow the safety message and how to avoid the risk of injury.

## IMPORTANT DEFINITIONS

- **Sears Service Center:** The Sears Service Center has the ability equivalent to a licensed tradesman in the fields of plumbing and electrical work including a thorough understanding of the requirements of the National Electrical Code as it relates to the installation of electric water heaters. The Sears Service Center also has a thorough understanding of this instruction manual, and is able to perform repairs strictly in accordance with the service guidelines provided by the manufacturer.

# GENERAL SAFETY

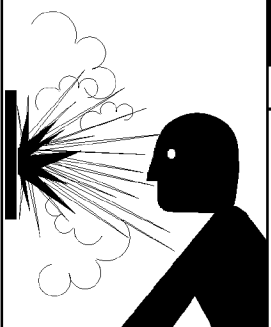

	<b>⚠ WARNING</b>
	<p>Read and understand instruction manual and safety messages before installing, operating or servicing this water heater.</p> <p>Failure to follow instructions and safety messages could result in death or serious injury.</p> <p>Instruction manual must remain with water heater.</p>

<b>CAUTION</b>
<b>Improper installation and use may result in property damage.</b>
<ul style="list-style-type: none"><li>• Do not operate water heater if flood damaged.</li><li>• Inspect and replace the anode as needed.</li><li>• Install in location with drainage.</li><li>• Fill tank with water before operation.</li><li>• Be alert for thermal expansion.</li></ul> <p>Refer to instruction manual for installation and service.</p>

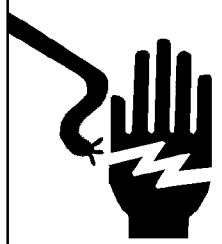
	<b>⚠ WARNING</b>
	<b>Explosion Hazard</b> <ul style="list-style-type: none"><li>• Overheated water can cause water tank explosion.</li><li>• Properly sized temperature and pressure relief valve must be installed in opening provided.</li></ul>

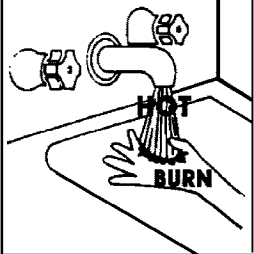
	<b>⚠ WARNING</b>
	<ul style="list-style-type: none"><li>• Before removing any access panels or servicing the water heater, make sure the electrical supply to the water heater is turned "OFF".</li><li>• Failure to do this could result in death, serious bodily injury, or property damage.</li></ul>

	<b>⚠ DANGER</b>
	<p>Water temperature over 125°F (52°C) can cause severe burns instantly resulting in severe injury or death.</p> <p>Children, the elderly, and the physically or mentally disabled are at highest risk for scald injury.</p> <p>Feel water before bathing or showering.</p> <p>Temperature limiting valves are available.</p> <p>Read instruction manual for safe temperature setting.</p>

<b>⚠ WARNING</b>		
<b>Fire Hazard / Electric Shock Hazard</b>		
	<ul style="list-style-type: none"><li>• Do not use this water heater with any voltage other than shown on the model rating plate.</li><li>• Failure to use the correct voltage shown on the model rating plate could result in death, serious bodily injury, or property damage.</li></ul>	

# TABLE OF CONTENTS

SAFE INSTALLATION, USE AND SERVICE.....	2
GENERAL SAFETY.....	3
PRODUCT WARRANTY .....	5
INTRODUCTION .....	6
PRODUCT SPECIFICATIONS .....	6
MATERIALS AND BASIC TOOLS NEEDED .....	7
Removing the Old Water Heater .....	8
INSTALLATION INSTRUCTIONS .....	8
Wiring.....	9
Water Piping.....	11
Temperature-Pressure Relief Valve.....	12
Filling the Water Heater.....	13
Wiring Diagram .....	14
Installation Checklist .....	15
KENMORE® SMART WATER HEATER MODULE (SOLD SEPARATELY).....	16
OPERATING YOUR WATER HEATER .....	17
Water Heater Start-Up.....	17
Safety Shut-Off.....	17
Water Temperature Regulation .....	17
Modes and Adjustments.....	18
Water Temperature Adjustment.....	18
Operating Mode Descriptions .....	18
The Electronic Thermostat .....	19
Diagnostic LED Light.....	19
Overriding The Energy Saver Module (ESM).....	19
SERVICE AND ADJUSTMENT .....	20
Anode Rod Inspection .....	20
Temperature-Pressure Relief Valve Operation.....	20-21
Draining and Flushing .....	21
Heating Element Replacement .....	21-22
Service .....	22
TROUBLESHOOTING .....	23
Start Up Conditions .....	23
Closed System/Thermal Expansion.....	23
Strange Sounds .....	23
Operational Conditions.....	23
Smelly Water.....	23-24
“Air” in Hot Water Faucets.....	24
Rumbling Noise.....	24
High Temperature Shut Off System .....	24
Not Enough or No Hot Water .....	25
Water Is Too Hot .....	25
Stacking .....	25
Diagnostic Code Chart: Energy Saver Module (ESM) .....	26-27
Diagnostic Code Chart: Electronic Thermostat (ET) .....	28-29
Troubleshooting Chart.....	30
LEAKAGE CHECKPOINTS.....	31
REPAIR PARTS LIST .....	32
NOTES .....	33-35

# PRODUCT WARRANTY

## KENMORE LIMITED WARRANTY

WITH PROOF OF SALE, the following warranty coverage applies when this water heater is correctly connected, installed, operated and maintained according to all supplied instructions. In all cases, replacement units, tanks or parts are warranted only for the unexpired portion of the warranty period from the original date of sale.

FOR ONE YEAR from the date of sale this water heater is warranted against defects in material or workmanship. A defective water heater will receive free repair or replacement at option of seller.

FOR TWELVE YEARS from the date of sale this water heater is warranted against leaks in the tank. If a tank leak occurs within the first year, a new water heater of equal capacity and quality will be supplied and installed at no charge. If a tank leak occurs after the first year, a new water heater of equal capacity and quality will be supplied but not installed at no charge. You are responsible for the labor cost of water heater installation after the first year from the date of sale.

FOR TWELVE YEARS from the date of sale all water heater parts are warranted against defects in material or workmanship. If a part is defective within the first year, a new part will be supplied and installed at no charge. If a part is defective after the first year, a new part will be supplied but not installed at no charge. You are responsible for the labor cost of part installation after the first year from the date of sale.

For warranty coverage details to obtain free repair or replacement, visit the web page: [www.kenmore.com/warranty](http://www.kenmore.com/warranty)

This warranty applies for only two years on the tank and one year on all parts if this water heater is ever used in a residence of more than one family or in a commercial, institutional or industrial installation.

**This warranty covers ONLY defects in material and workmanship, and will NOT pay for:**

1. Expendable items that can wear out from normal use, including but not limited to filters, belts, bags or screw-in base light bulbs.
2. A service technician to clean or maintain this appliance, or to instruct the user in correct appliance installation, operation and maintenance.
3. Service calls to correct appliance installation not performed by Sears authorized service agents, or to repair problems with house fuses, circuit breakers, house wiring, and plumbing or gas supply systems resulting from such installation.

4. Damage to or failure of this appliance resulting from installation not performed by Sears authorized service agents, including installation that was not in accord with electrical, gas or plumbing codes.
5. Damage to or failure of this appliance, including discoloration or surface rust, if it is not correctly operated and maintained according to all supplied instructions.
6. Damage to or failure of this appliance, including discoloration or surface rust, resulting from accident, alteration, abuse, misuse or use for other than its intended purpose.
7. Damage to or failure of this appliance, including discoloration or surface rust, caused by the use of detergents, cleaners, chemicals or utensils other than those recommended in all instructions supplied with the product.
8. Damage to or failure of parts or systems resulting from unauthorized modifications made to this appliance.
9. Service to an appliance if the model and serial plate is missing, altered, or cannot easily be determined to have the appropriate certification logo.

### Disclaimer of implied warranties; limitation of remedies

Customer's sole and exclusive remedy under this limited warranty shall be product repair or replacement as provided herein. Implied warranties, including warranties of merchantability or fitness for a particular purpose, are limited to one year on the water heater, and twelve years on the tank and parts, or the shortest period allowed by law. Seller shall not be liable for incidental or consequential damages. Some states do not allow the exclusion or limitation of incidental or consequential damages, or limitation on the duration of implied warranties of merchantability or fitness, so these exclusions or limitations may not apply to you.

This warranty applies only while this appliance is used in the United States.

This warranty gives you specific legal rights, and you may also have other rights which vary from state to state.

**Sears Brands Management Corporation,  
Hoffman Estates, IL 60179**

## Master Protection Agreements

Congratulations on making a smart purchase. Your new Kenmore® product is designed and manufactured for years of dependable operation. But like all products, it may require preventive maintenance or repair from time to time. That's when having a Master Protection Agreement can save you money and aggravation.

The Master Protection Agreement also helps extend the life of your new product. Here's what the Agreement\* includes:

- **Parts and labor** not just for repairing defects, but to help keep products operating properly **under normal use**. Our coverage goes **well beyond the product warranty**. No deductibles, no functional failure excluded from coverage— real protection.
- **Expert service** by experienced service technicians trusted in millions of homes every year.
- **Unlimited service calls and nationwide service**, as often as you want us, whenever you want us.
- **"No-lemon" guarantee** – replacement of your covered product after three separate product failures occur within twelve months and a fourth repair is required. Includes free delivery and installation, if necessary, of replacement product.
- **Product replacement** if your covered product can't be fixed.
- **Annual Preventive Maintenance Check** at your request – no extra charge.
- **Fast help by phone** – phone support from a service agent on all products to help trouble-shoot problems. Think of us as a "talking owner's manual."
- **Power surge protection** against electrical damage due to power fluctuations.
- **\$300 Food Loss Protection** for any food spoilage that is the result of mechanical failure of any covered refrigerator or freezer.
- **Service Promise: \$50** if first attempt repair of your covered kitchen or laundry product can't be accomplished and product is not usable while awaiting further repair service.
- **25% discount** off the regular price of any non-covered repair service and related installed parts.

Once you purchase the Agreement, a simple phone call is all that it takes for you to schedule service. You can call anytime day or night.

The Master Protection Agreement is a risk free purchase. If you cancel for any reason during the product warranty period, we will provide a full refund. Or, a prorated refund anytime after the product warranty period expires. Purchase your Master Protection Agreement today!

**Some limitations and exclusions apply. For prices and additional information in the U.S.A. call 1-800-827-6655.**

**\* Coverage in Canada varies on some items. For full details call Sears Canada at 1-800-361-6665.**

### Sears Installation Service

*For Sears professional installation of home appliances, garage door openers, water heaters, and other major home items, in the U.S.A. call 1-844-553-6667, and in Canada call 1-800-469-4663.*

**Thank You** for purchasing a Kenmore water heater. Properly installed and maintained, it should give you years of trouble free service. It is strongly suggested that this new water heater be professionally installed. Contact the local Sears Service Center or any Sears store. They will arrange for prompt, quality installation by Sears authorized contractors.

**Abbreviations Found In This Instruction Manual:**

UL – Underwriters Laboratories Inc.

NEC – National Electrical Code

ANSI – American National Standards Institute

- Read the “General Safety” section, page 3 of this manual first and then the entire manual carefully. If you don’t follow the safety rules, the water heater will not operate properly. It could cause DEATH, SERIOUS BODILY INJURY AND/OR PROPERTY DAMAGE.

This manual contains instructions for the installation, operation, and maintenance of this electric water heater. It also contains warnings throughout the manual that you must read and be aware of. All warnings and all instructions are essential to the proper operation of the water heater and your safety. Since we cannot put everything on the first few pages, READ THIS ENTIRE MANUAL BEFORE ATTEMPTING TO INSTALL OR OPERATE THE WATER HEATER.

- The installation must conform with the instructions in this manual; electric company rules; and Local Codes, or in the absence of Local Codes, with the current edition of the NEC - National Electrical Code, NFPA 70. This publication is available from your local government or public library or electric company or by writing Underwriters Laboratories Inc., 333 Pfingsten Road, Northbrook, IL 60062.

- If after reading this manual you have any questions or do not understand any portion of the instructions, call the Sears Service Center.
- The product is certified to comply with a maximum weighted average of 0.25% lead content as required in some areas.
- Carefully plan the place where you are going to put the water heater. Correct electrical wiring and connections are very important in preventing death from possible electrical shock and fires.
- Keep combustibles such as boxes, magazines, clothes, etc., away from water heater area.

Examine the location to ensure the water heater complies with the “Facts to Consider About the Location” section.

For California installation, this water heater must be braced, anchored, or strapped to avoid falling or moving during an earthquake. See instructions for correct installation procedures. Instructions may be obtained from California’s Office of the State Architect, 1102 Q Street, Suite 5100, Sacramento, CA 95811. Instructions can also be downloaded to your computer at [www.dsa.dgs.ca.gov](http://www.dsa.dgs.ca.gov).

Massachusetts Code requires this water heater to be installed in accordance with Massachusetts 248-CMR 2.00; State Plumbing Code and 248-CMR 5.00. In the Commonwealth of Massachusetts, this product must be installed by a licensed plumber or gasfitter.

**PRODUCT SPECIFICATIONS**

MODEL NUMBER	TANK CAPACITY		DIMENSIONS IN INCHES (mm)		RECOVERY RATE GALS.PER HOUR @90°F Rise	ELEMENT WATTAGE @240 VOLTS		MINIMUM WIRE SIZE* (GAUGE)	MAXIMUM FUSE OR CIRCUIT BREAKER SIZE (AMPS)
	Gals	Liters	DIA.	HEIGHT		UPPER	LOWER		
153.582400	40	151	20.0 (508)	60.25 (1530)	25	5500	5500	10	30
153.582500	50	189	22.0 (559)	60.50 (1537)	25	5500	5500	10	30

\* Wiring size based on standard 60°C copper wire. If distance from fuse box to water heater is more than 90 feet, refer to your local electrical code.

# MATERIALS AND BASIC TOOLS NEEDED

## Materials Needed

To simplify the installation Sears has available the installation parts shown below. You may or may not need all of these materials, depending on your type of installation.

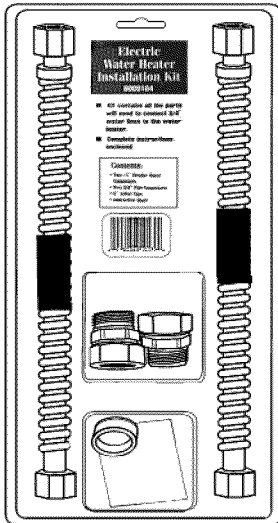

WATER HEATER INSTALLATION KIT WITH FLEXIBLE CONNECTORS FOR 3/4" THREADED OR COPPER PLUMBING.

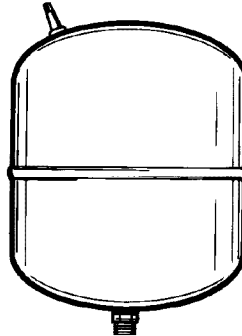

EXPANSION TANKS FOR THERMAL EXPANSION CONDITIONS AVAILABLE IN 2 GALLONS, AND 5 GALLONS CAPACITY THROUGH LOCAL SEARS STORE OR SERVICE CENTER.

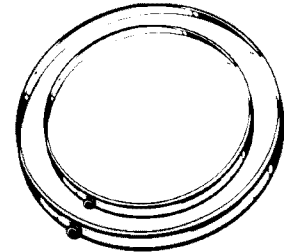

SUITABLE DRAIN PANS AVAILABLE IN 20" DIAMETER FOR WATER HEATERS HAVING A DIAMETER 18" OR LESS AND IN 24" DIAMETER FOR WATER HEATERS HAVING A DIAMETER OF 22" OR LESS.

## Basic Tools

You may or may not need all of these tools, depending on your type of installation. These tools can be purchased at your local Sears store.

- Pipe Wrench (2)
- Screwdriver
- 6 Foot Tape or Folding Rule
- Garden Hose
- Drill
- Pipe Dope or Thread Sealing Tape



ROLL OF THREAD SEALING TAPE (USE ON WATER CONNECTIONS)

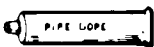

PIPE DOPE (SQUEEZE TUBE) USE FOR WATER CONNECTIONS



GARDEN HOSE



6 FOOT TAPE MINIMUM

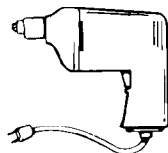

DRILL

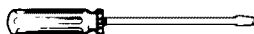

SLOT-HEAD SCREWDRIVER



PHILLIPS SCREWDRIVER



PIPE WRENCH

## Additional Tools Needed When Sweat Soldering

- Tubing Cutters or Hacksaw
- Propane Torch
- Soft Solder
- Solder Flux
- Emery Cloth
- Wire Brushes



TUBING CUTTER

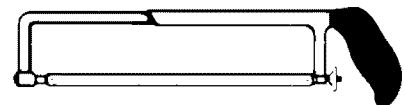

HACKSAW



PROPANE TORCH



ROLL OF EMERY CLOTH



ROLL OF LEAD-FREE SOFT SOLDER

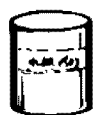

SOLDER FLUX



3/4" (19 mm) WIRE BRUSH

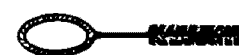

1/2" (13 mm) WIRE BRUSH

# INSTALLATION INSTRUCTIONS

## Removing the Old Water Heater

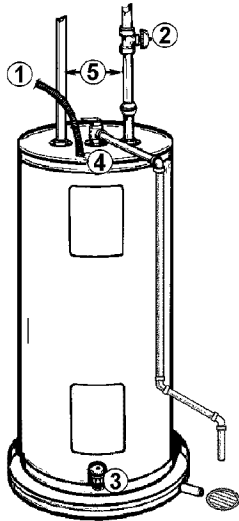

1. Turn "OFF" electrical supply to the water heater.

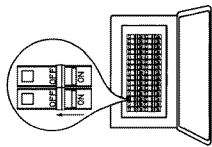

FIGURE 1

2. Open a nearby hot water faucet until the water is no longer hot. When the water has cooled, turn "OFF" the water supply to the water heater at the water shut-off valve or water meter.



FIGURE 2

3. Attach a hose to the water heater drain valve and put the other end in a floor drain or outdoors. Open the water drain valve. Open a nearby hot water faucet, which will relieve pressure in the water heater and speed draining.

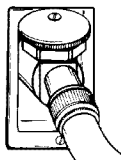

FIGURE 3

<b>⚠ DANGER</b>	
	<ul style="list-style-type: none"> <li>• Burn hazard</li> <li>• Hot water discharge.</li> <li>• Keep hands clear of drain valve discharge.</li> </ul>

The water passing out of the drain valve may be extremely hot. To avoid being scalded, make sure all connections are tight and that the water flow is directed away from any person.

4. Check again to make sure the electrical supply is turned "OFF" to the water heater. Next, unplug the water heater (cord set) or disconnect the electrical supply connection from the water heater junction box.

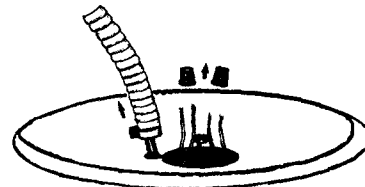

FIGURE 4

- 5a. If you have copper piping to the water heater, the two copper water pipes can be cut with a hacksaw approximately four inches away from where they connect to the water heater. This will avoid cutting off the pipes too short. Additional cuts can be made later if necessary. Disconnect the temperature-pressure relief valve drain line. When the water heater is drained, disconnect the hose from the drain valve. Close the drain valve. The water heater is now completely disconnected and ready to be removed.

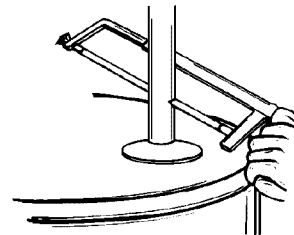

FIGURE 5

- 5b. If you have galvanized pipe to the water heater, loosen the two galvanized pipes with a pipe wrench at the union in each line. Also disconnect the piping remaining to the water heater. These pieces should be saved since they may be needed when reconnecting the new water heater. Disconnect the temperature-pressure relief valve drain line. When the water heater is drained, disconnect the hose from the drain valve. Close the drain valve. The water heater is now completely disconnected and ready to be removed.

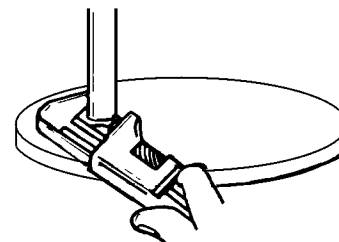

FIGURE 6



<b>CAUTION</b>
<b>Mineral Buildup or Sediment May Accumulate</b>
<ul style="list-style-type: none"> <li>• This causes the water heater to become much heavier than normal.</li> <li>• If spilled, could cause staining.</li> </ul>

Mineral buildup or sediment may have accumulated in the old water heater. This causes the water heater to be much heavier than normal and this residue, if spilled out, could cause staining.

**Facts to Consider About the Location**

You should carefully choose an indoor location for the new water heater, because the placement is a very important consideration for the safety of the occupants in the building and for the most economical use of the appliance. **This water heater is not intended for outdoor installation.**

Whether replacing an old water heater or putting the water heater in a new location, the following critical points must be observed.

- The location selected should be indoors as close to and as centralized with the water piping system as possible. This water heater, as well as all water heaters, will eventually leak. Do not install without adequate drainage provisions so water flow will not cause damage.

<b>CAUTION</b>
<b>Property Damage Hazard</b>
<ul style="list-style-type: none"> <li>• All water heaters eventually leak</li> <li>• Do not install without adequate drainage.</li> </ul>

**WATER HEATERS EVENTUALLY LEAK:** Installation of the water heater must be accomplished in such a manner that if the tank or any connections should leak, the flow of water will not cause damage to the structure. When such locations cannot be avoided, a suitable drain pan should be installed under the water heater. Drain pans are available at your local Sears stores. Such drain pans must be piped to an adequate drain.

Water heater life depends upon water quality, water pressure and the environment in which the water heater is installed. Water heaters are sometimes installed in locations where leakage may result in property damage, even with the use of a drain pan piped to a drain. However, unanticipated damage can be reduced or prevented by a leak detector or water shut-off device used in conjunction with a piped drain pan. These devices are available from some plumbing supply wholesalers and retailers, and detect and react to leakage in various ways:

- Sensors mounted in the drain pan that trigger an alarm or turn off the incoming water to the water heater when leakage is detected.

- Sensors mounted in the drain pan that turn off the water supply to the entire home when water is detected in the drain pan.
- Water supply shut-off devices that activate based on the water pressure differential between the cold water and hot water pipes connected to the water heater.

<b>CAUTION</b>
<b>Installations in Residential Garages</b>
<ul style="list-style-type: none"> <li>• Water heater must be located in a protective area.</li> </ul>

**INSTALLATION IN RESIDENTIAL GARAGES:** The water heater must be located and/or protected so it is not subject to physical damage by a moving vehicle.

- The location selection must provide adequate clearances for servicing and proper operation of the water heater.

**Wiring**

<b>⚠ WARNING</b>	
	<p style="text-align: center;"><b>Electric Shock Hazard</b></p> <p><b>Disconnect power before servicing.</b></p> <p><b>Replace all parts and panels before operating.</b></p> <p><b>Failure to do so can result in death or electric shock.</b></p>
	<b>⚠ WARNING</b>
	<p style="text-align: center;"><b>Fire Hazard</b></p> <p><b>Use 10 gauge solid copper wire.</b></p> <p><b>Use a UL approved strain relief.</b></p> <p><b>Connect ground wire to green ground screw.</b></p> <p><b>Failure to do so can result in death, fire, or electrical shock.</b></p>

If you lack the necessary skills required to properly install the electrical wiring to this water heater, do not proceed, but have a qualified electrician perform the installation.

When making the electrical connections, always make sure:

- The electrical supply has the proper overload fuse or circuit breaker protection.
- Wire sizes and connections comply with all applicable codes.
- Wiring is enclosed in approved conduit (if required by local codes).

- The water heater and electrical supply are properly grounded.
- Always reference the wiring diagram for the correct electrical connection. The complete wiring diagram can also be found on the top of the water heater near the junction box cover.
- Although this water heater is equipped with “Dry-fire” protection, be sure the tank is completely filled with water, and all air is purged from the tank before making any electrical connections. See Figure 7.

Heating Element

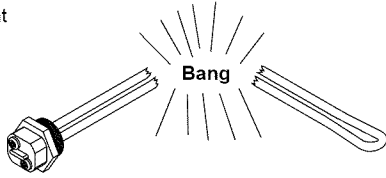

NOTE: Applying electrical power to elements that are not submerged in water will destroy them. The manufacturer will not warrant any elements damaged in this manner.

FIGURE 7

When you are finished, you will have THREE red wires under one wire nut (depending on the actual color of your home's electric wiring).

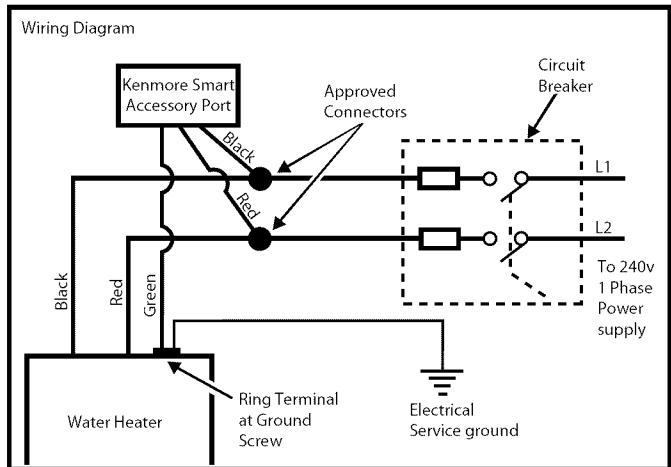

FIGURE 8

1. Check and turn off power to the electrical wiring of the water heater before making any electrical connections to the water heater.
2. Remove the junction box cover that is secured by one screw (Figure 9). Place the cover and screw aside and view the wiring diagram. Locate the four power wires inside the junction box (there will be TWO red wires and TWO black wires).
3. Connect the electrical supply to the water heater in accordance with the local utility requirements and codes. A standard 1/2 inch opening has been made in the junction box for the conduit connections (Figure 9). NOTE: Use only 10 gauge solid copper wire for the electrical connections and an appropriately-sized double pole circuit breaker.

⚠ WARNING

**Fire Hazard**

**Use 10 gauge solid copper wire.**

**Use a UL approved strain relief.**

**Connect ground wire to green ground screw.**

**Failure to do so can result in death, fire, or electrical shock.**

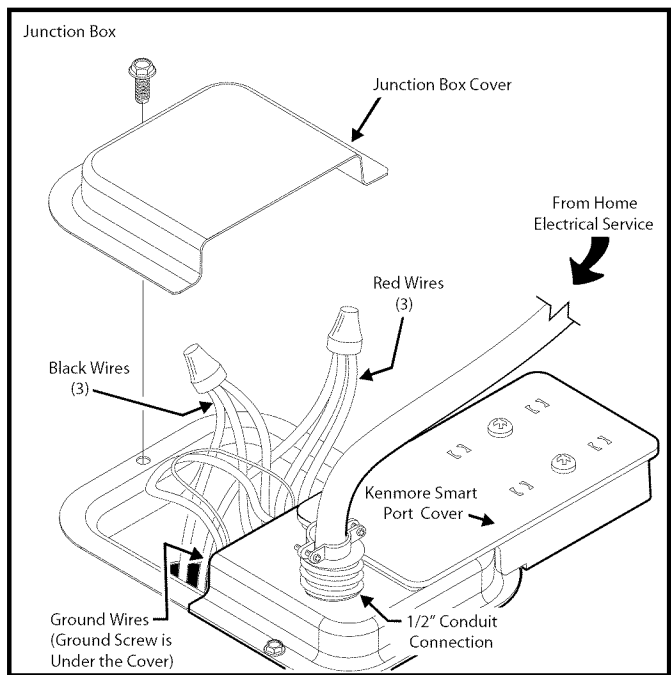

FIGURE 9

4. Ground the water heater by connecting the bare copper ground wire from the home's electrical service to the green ground screw (located inside the electrical junction box on top of the water heater). See Figure 8 and Figure 9.
5. There are TWO black wires and TWO red wires in the water heater. The smaller red and black wires are used by the Kenmore Smart accessory port.
6. Connect the black power wire from the home's electrical service to the heater's TWO black wires and secure with the appropriate size wire nut. When you are finished, you will have THREE black wires under one wire nut.
7. Locate and connect the remaining power wire (usually red, but in your home, this wire may be some other color) from the home's electrical service to the water heater's TWO red wires and secure with the appropriate size wire nut.

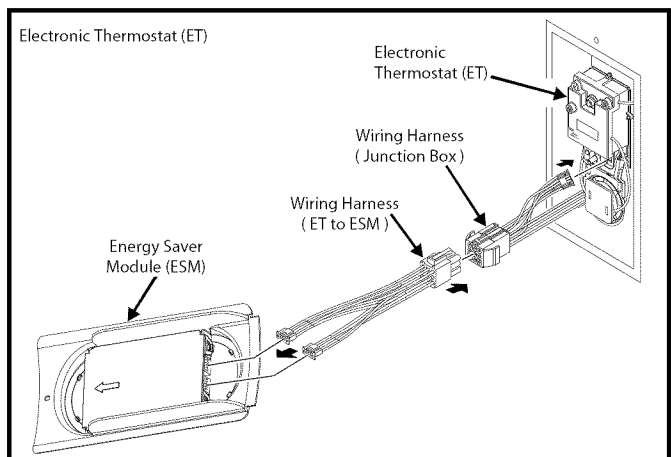
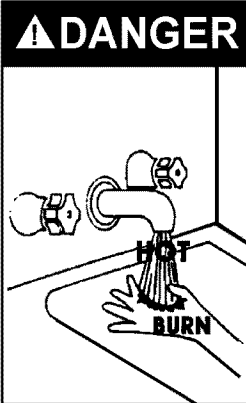

FIGURE 10

## Water Piping

	<p><b>Water temperature over 125°F (52°C) can cause severe burns instantly resulting in severe injury or death.</b></p> <p>Children, the elderly, and the physically or mentally disabled are at highest risk for scald injury.</p> <p>Feel water before bathing or showering.</p> <p>Temperature limiting valves are available.</p> <p>Read instruction manual for safe temperature setting.</p>
---	---

**HOTTER WATER CAN SCALD:** Water heaters are intended to produce hot water. Water heated to a temperature which will satisfy clothes washing, dish washing, and other sanitizing needs can scald and permanently injure you upon contact. Some people are more likely to be permanently injured by hot water than others. These include the elderly, children, the infirm, or physically/mentally challenged. If anyone using hot water in your home fits into one of these groups or if there is a local code or state law requiring a certain temperature water at the hot water tap, then you must take special precautions. Use the lowest possible temperature setting that satisfies your hot water needs. Also, to reduce the risk of scalding, the manufacturer of this water heater recommends installing a mixing valve at each point of use. Mixing valves are available at plumbing supply or hardware stores. Follow the manufacturer's instructions for installation of the valves. Before changing the factory setting on the thermostat, read the "Temperature Regulation" section in this manual.

Piping, fittings, and valves should be installed according to the installation drawing (Figure 11). If the indoor installation area is subject to freezing temperatures, the water piping must be protected by insulation.

Water supply pressure should be around 50 to 60 psi and should not exceed 80 psi. If this occurs, a pressure reducing valve should be installed in the cold water inlet line. This should be placed on the supply to the entire house in order to maintain equal hot and cold water pressures.

**IMPORTANT:** Heat cannot be applied to the water fittings on the heater as they may contain nonmetallic parts. If solder connections are used, solder the pipe to the adapter before attaching the adapter to the hot and cold water fittings.

**IMPORTANT:** Always use a good grade of joint compound and be certain that all fittings are drawn up tight.

1. Install the water piping and fitting as shown in Figure 11. Connect the cold water supply (3/4" NPT) to the fitting marked "Cold". Connect the hot water supply (3/4" NPT) to the fitting marked "Hot".

**IMPORTANT:** Some models may contain energy saving heat traps to prevent the circulation of hot water within the pipes. Do not remove these inserts.

2. The installation of dielectric unions in both the hot and cold water supply lines is recommended for ease of removing the water heater for service or replacement.
3. Install thermostatic mixing valves (temperature limiting valves) at each point of use (recommended). These valves reduce the point-of-use temperature of the hot water by mixing cold and hot water and are readily available. Contact a licensed plumber or the local plumbing authority.
4. If installing the water heater in a closed water system, install a relief valve or expansion tank in the cold water line as specified under "Closed System/Thermal Expansion".
5. Install a shut-off valve in the cold water inlet line. It should be located close to the water heater and be easily accessible. Know the location of this valve and how to shut off the water to the heater.

WATER PIPING INSTALLATION:

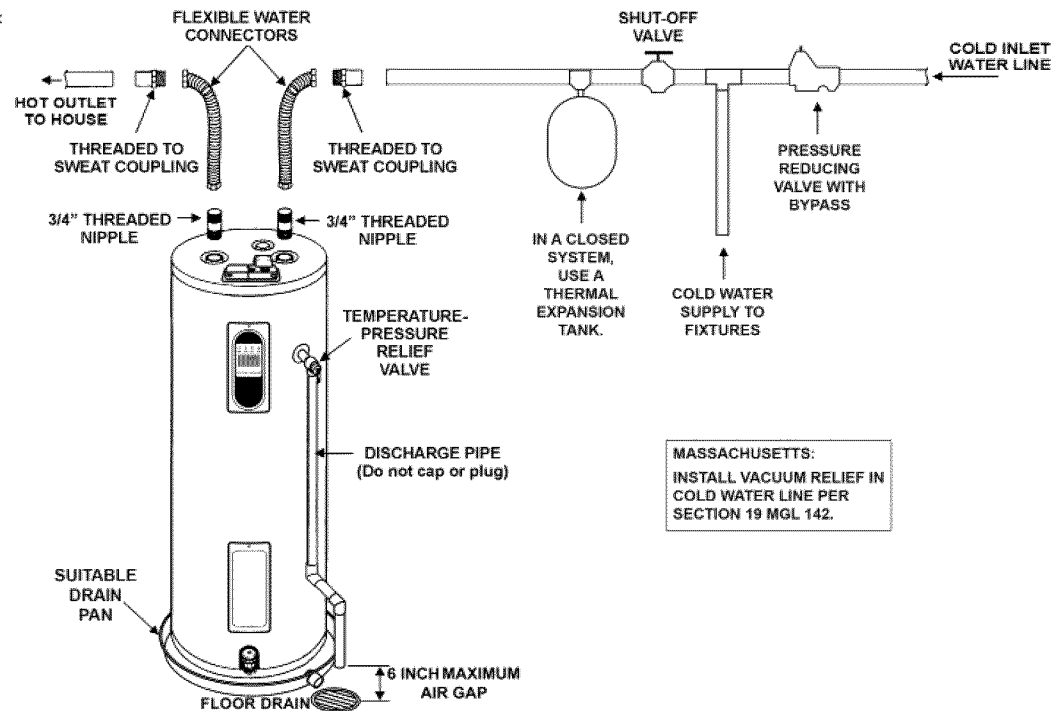

FIGURE 11

6. Install a discharge line from the temperature and pressure relief valve in the opening marked "T & P RELIEF VALVE". Install as specified under "Temperature and Pressure Relief Valve".
7. After piping has been properly connected to the water heater, open the nearest hot water faucet. Then open the cold water shut off valve and allow the tank to completely fill with water. To purge the lines of any excess air and sediment, keep the hot water faucet open for 3 minutes after a constant flow of water is obtained. Close the faucet and check all connections for leaks.

Please note the following:

- DO NOT install this water heater with iron piping. The system should be installed only with piping that is suitable for potable (drinkable) water such as copper, CPVC, or polyethylene (PEX).
- DO NOT use PVC water piping.
- DO NOT use any pumps, valves, or fittings that are not compatible with potable water.
- DO NOT use valves that may cause excessive restriction to water flow. Use full-flow ball or gate valves only.
- DO NOT use tin-lead solder in potable water lines. Use 95/5 tin antimony or other equivalent material.
- DO NOT tamper with the Energy Saver Module (ESM), electronic thermostat, temperature sensors, heating elements, electrical connections, or temperature and pressure relief valve. Tampering voids all warranties. Only qualified service technicians should service these components.
- DO NOT use with piping that has been treated with chromates, boiler seal, or other chemicals.
- DO NOT add any chemicals to the system piping which will contaminate the potable water supply.

## Temperature-Pressure Relief Valve

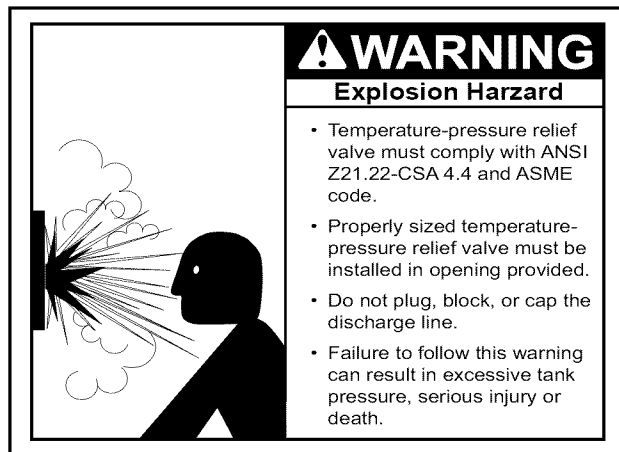

This heater is provided with a properly certified combination temperature - pressure relief valve by the manufacturer.

The valve is certified by a nationally recognized testing laboratory that maintains periodic inspection of production of listed equipment of materials as meeting the requirements for Relief Valves for Hot Water Supply Systems, ANSI Z21.22 • CSA 4.4, and the code requirements of ASME.

If replaced, the valve must meet the requirements of local codes, but not less than a combination temperature and pressure relief valve certified as indicated in the above paragraph.

The valve must be marked with a maximum set pressure not to exceed the marked hydrostatic working pressure of the water heater (150 psi = 1,035 kPa) and a discharge capacity not less than the water heater input rate as shown on the model rating plate. (For electric heaters, watts x 3.412 equals Btu/hr input rate).

For safe operation of the water heater, the relief valve must not be removed from its designated opening nor plugged.

The temperature-pressure relief valve must be installed directly into the fitting of the water heater designed for the relief valve. Position the valve opening downward and provide tubing so that any discharge will exit only within 6 inches above, or at any distance below the structural floor. Be certain that no contact is made with any live electrical part. The discharge opening must not be blocked or reduced in size under any circumstances. Excessive length, over 30 feet (9.14 m), or use of more than four elbows can cause restriction and reduce the discharge capacity of the valve.

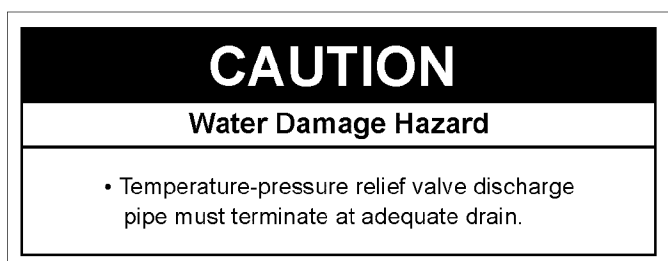

No valve or other obstruction is to be placed between the relief valve and the tank. Do not connect tubing directly to discharge drain unless a 6 inch air gap is provided. To prevent

bodily injury, hazard to life, or property damage, the relief valve must be allowed to discharge water in quantities should circumstances demand. If the discharge pipe is not connected to a drain or other suitable means, the water flow may cause property damage.

**The Discharge Pipe:**

- Must not be smaller in size than the outlet pipe size of the valve, or have any reducing couplings or other restrictions.
- Must not be plugged or blocked.
- Must be of material listed for hot water distribution.
- Must be installed so as to allow complete drainage of both the temperature-pressure relief valve, and the discharge pipe.
- Must terminate a maximum of six inches above a floor drain or external to the building. In cold climates, it is recommended that the discharge pipe be terminated at an adequate drain inside the building.
- Must terminate at an adequate drain.
- Must not have any shut-off valve between the relief valve and tank nor in the discharge pipe.

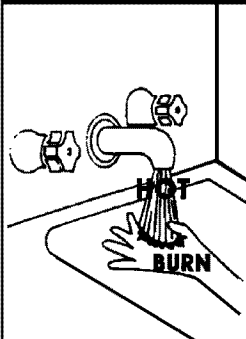
	<p><b>⚠ DANGER</b></p> <p>Water temperature over 125°F (52°C) can cause severe burns instantly resulting in severe injury or death.</p> <p>Children, the elderly, and the physically or mentally disabled are at highest risk for scald injury.</p> <p>Feel water before bathing or showering.</p> <p>Temperature limiting valves are available.</p> <p>Read instruction manual for safe temperature setting.</p>
--	---

See also "Temperature-Pressure Relief Valve Operation" on page 20.

## Filling the Water Heater

<p><b>CAUTION</b></p> <p><b>Property Damage Hazard</b></p> <ul style="list-style-type: none"><li>• Avoid water heater damage.</li><li>• Fill tank with water before operating.</li></ul>
--

Never use this water heater unless it is completely full of water. To prevent damage to the tank and heating element, the tank must be filled with water. Water must flow from the hot water faucet before turning "ON" power.

To fill the water heater with water:

1. Close the water heater drain valve by turning the handle to the right (clockwise). The drain valve is located on the lower front of the water heater.
2. Open the cold water supply valve to the water heater.  
**NOTE:** The cold water supply valve must be left open when the water heater is in use.
3. To ensure complete filling of the tank, allow air to exit by opening the nearest hot water faucet. Allow water to run until a constant flow is obtained. This will let air out of the water heater and the piping.
4. Check all new water piping for leaks. Repair as needed.

# Wiring Diagram

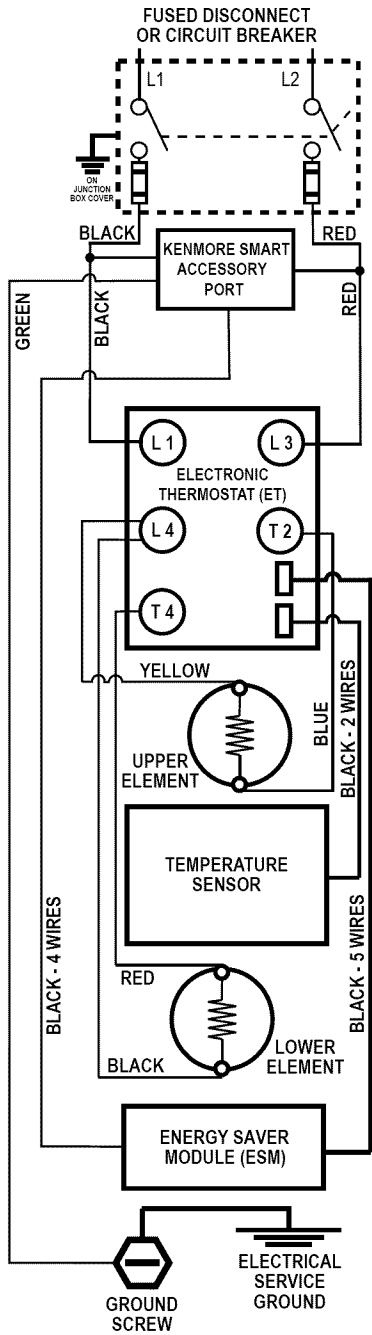

## ⚠ WARNING

- Before removing any access panels or servicing the water heater, make sure the electrical supply to the water heater is turned "OFF".
- Failure to do this could result in death, serious bodily injury, or property damage.

BRANCH CIRCUIT SIZING GUIDE						
Based on N.E.C. NFPA NO. 70 - 1999						
WATT LOAD	Recommend Over Current Protection Rating			Copper Wire Size AWG Based on N.E.C. Table 310-16 (60°C)		
				120 V	208 V	240 V
1500*	15	15	15	12	14	14
2000	20	15	15	10	14	14
2500	30	15	15	10	14	14
3000	30	20	15	8	12	12
3500	-	20	20	-	10	12
4000	-	25	20	-	10	10
4500	-	30	25	-	10	10
5000	-	30	30	-	10	10
5500	-	-	30	-	-	10

\* Wattages less than 1500 may be wired 14 gage with a maximum 15 amp protection.

FIGURE 12

## Installation Checklist

---

### WATER HEATER LOCATION:

- Centrally located with the water piping system.
- The flooring beneath the water heater must be able to support the weight of the water heater when filled with water.
- Located indoors and in a vertical position. Protected from freezing temperatures.
- Provisions made to protect the area from water damage. Suitable drain pan installed and piped to an adequate drain.
- Sufficient room to service the water heater.
- The site location must be free from any corrosive elements in the atmosphere such as sulfur, fluorine, and chlorine. These elements are found in aerosol sprays, detergents, bleaches, cleaning solvents, air fresheners, paint, and varnish removers, refrigerants, and many other commercial and household products.

### WATER SYSTEM PIPING

- Temperature and pressure relief valve properly installed with a discharge pipe run to an adequate drain and protected from freezing. See Figure 11 on page 11.
- All piping properly installed and free of leaks.
- Suitable drain pan lines installed and piped to an adequate drain. See Figure 11 on page 11.
- Heater completely filled with water.
- Closed system pressure buildup precautions installed (See “Closed System/Thermal Expansion” section).
- Mixing valves recommended, installed per manufacturer’s instructions at each point of use.

### ELECTRICAL CONNECTIONS

- Wiring and connections comply with all applicable codes.
- Water heater and electrical supply are properly grounded.
- Proper overload fuse or circuit breaker protection installed.

# KENMORE® SMART WATER HEATER MODULE

This water heater is a connected-ready appliance, allowing you to remotely monitor and control it from your smartphone via the Kenmore® Smart Water Heater Module, which is sold separately.

To get started, you will need the following:

- Kenmore Smart Water Heater Module
- WI-FI home router connected to the internet
- Smartphone
- Kenmore Smart app

For more information about the Kenmore® Smart Water Heater Module, visit [www.Kenmore.com/smart](http://www.Kenmore.com/smart).



# OPERATING YOUR WATER HEATER

## Water Heater Start-Up

1. Carefully read and understand "Water Temperature Regulation." If the instructions are not clear, contact a qualified service technician.
2. Make sure the water heater has been properly installed. See the "Installation Instructions" section.
3. Completely fill the tank with water; open faucet to allow air to purge. (See page 13.)
4. After the tank is completely filled with water, turn on power to the water heater at the breaker panel.
5. Power to the water heater will allow the water heater to run a system diagnostic. This typically takes eight minutes. Once complete, proceed to the next step. NOTE: if the system diagnostic yields any codes, reference the Diagnostic Code section in this manual.
6. Adjust the thermostat to the desired temperature setting as described under "Adjusting the User Interface Module/Operational Modes" section.

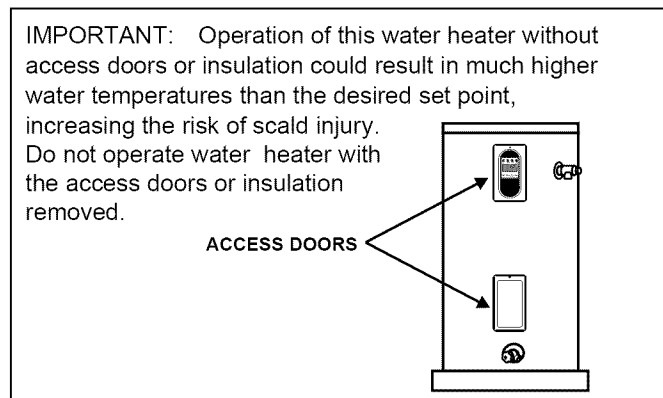

FIGURE 13

**IMPORTANT:** Do not attempt to operate this water heater if the temperature sensor(s), electronic control board, or surrounding insulation has been exposed to water in any way. Immediately call a qualified service technician to inspect the water heater and replace any temperature sensor(s), electronic control board, or insulation that has been exposed to water. Do not attempt to repair these parts. Water heaters subjected to flood conditions or any time the temperature sensor(s) or electronic thermostat have been submerged in water require replacement of the entire water heater.

## Safety Shut-Off

This water heater is designed to automatically shut-off in the event that the water temperature exceeds 180° F (82.2° C). A temperature limit switch, or ECO (Energy Cut Off), is used to shut off the power to the system if the water temperature exceeds 180° F or 82.2° C. The ECO can be reset by firmly pushing in the red reset button located on the electronic thermostat. (See Figure 15 on page 19.) If the ECO continues to shut-off the water heater contact a qualified service technician.

## Water Temperature Regulation

**⚠ DANGER**

Water temperature over 125°F (52°C) can cause severe burns instantly resulting in severe injury or death.

Children, the elderly, and the physically or mentally disabled are at highest risk for scald injury.

Feel water before bathing or showering.

Temperature limiting valves are available.

Read instruction manual for safe temperature setting.

The water heater is adjusted to a temperature setting of no higher than 120° F when shipped from the factory. Water temperature can be regulated by adjusting the Energy Saver Module to the preferred setting as shown in "Modes and Adjustments." The preferred starting point is 120° F. There is a hot water scald potential if the temperature set point is set too high.

**IMPORTANT:** Adjusting the temperature past 120° F on the Energy Saver Module will increase the risk of scald injury in the times shown below. To reduce the risk of scalding, install thermostatic mixing valves (temperature limiting valves) at each point of use (recommended).

Water Temperature °F (°C)	Time for 1st Degree Burn (Less Severe Burns)	Time for Permanent Burns 2nd & 3rd Degree (Most Severe Burns)
110°F (43°C)	(normal shower temp.)	
116°F (47°C)	(pain threshold)	
116°F (47°C)	35 minutes	45 minutes
122°F (50°C)	1 minute	5 minutes
131°F (55°C)	5 seconds	25 seconds
140°F (60°C)	2 seconds	5 seconds
149°F (65°C)	1 second	2 seconds
154°F (68°C)	instantaneous	1 second

(U.S. Government Memorandum, C.P.S.C., Peter L. Armstrong, Sept. 15, 1978)



When leaving your home for extended periods (vacations, etc.) set the water heater to Vacation Mode. This will maintain the water at low temperatures with minimum energy losses and prevent the tank from freezing during cold weather. See the "Modes and Adjustments" section for more information.

**NOTE:** When returning from an extended stay, remember to set the water heater back to the desired Operational Mode.

## Modes and Adjustments

### WATER TEMPERATURE ADJUSTMENT

**IMPORTANT:** Before attempting to adjust the thermostat, read the "Water Temperature Regulation" section. If the instructions are not clear, contact a qualified service technician.

The water temperature can be adjusted from 80° F to 150° F. Use the Up and Down Buttons   to set the desired temperature.



**ENERGY SAVER** - Pressing this button switches to the Energy Saver operating mode. This will reduce energy consumption by adjusting the temperature set point automatically to match water usage patterns. (Temperature set point can still be changed.)



**STANDARD** - Pressing this button will switch operation to Standard operating mode. The water heater will not adjust its temperature set point automatically; it will maintain the programmed temperature set point (like a standard electric water heater).



**VACATION MODE** - The Energy Saver control adjusts the set point to approximately 60°F, which is recommended when the water heater will not be in use for a long period of time. This mode minimizes energy consumption and prevents the water heater from freezing during cold weather. **NOTE:** If your water heater is in Vacation Mode, you can return it to its previous settings by pressing the Vacation Mode button again.



**REMOTE ACCESS** - Pressing this button will enable or disable remote monitoring and control through an optional Kenmore Smart Water Heater Module. See page 16.



**ENTER / LOCK** - Pressing this button once after a user setting has been changed confirms and saves the new setting. Holding this button for more than 3 seconds switches the lock mode on or off. When the User Module is locked, a symbol and "Lock" text will be visible on the display.

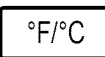

**°F/°C** - Pressing this button switches the display to show the set temperature in Fahrenheit or Celsius.



Fault condition will display an "E," followed by a two digit fault code (with Alert Icon flashing). See diagnostic code chart on page 26.



**Element Functioning Icon** - indicates power is on at either upper or lower element circuits and both are working properly.

### OPERATING MODE DESCRIPTIONS

The operating modes can be changed by touching the desired mode icon on the Energy Saver Module. (See below.)

**NOTE:** All buttons on the Energy Saver Module are touch sensitive and require only a light touch to actuate.

ENERGY SAVER MODULE (ESM)

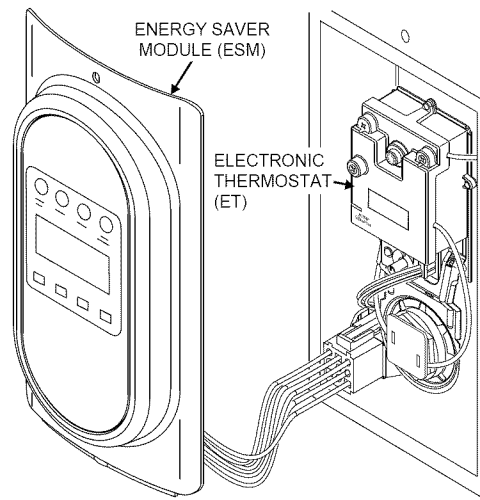
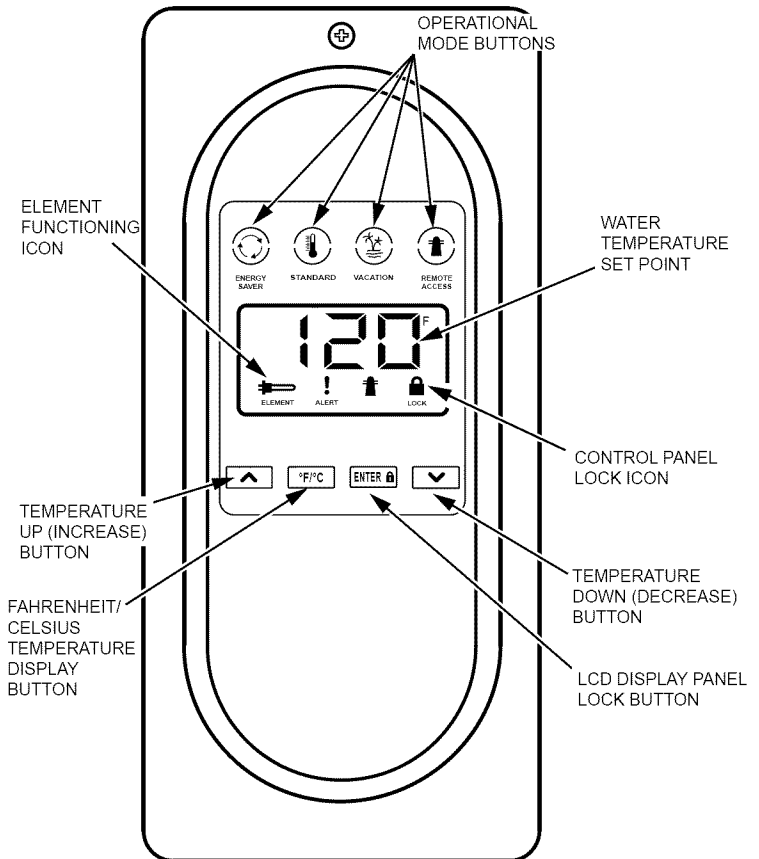

**NOTE:** THE ELECTRONIC THERMOSTAT (ET) IS DESIGNED SO THAT IT MAY CONTROL THE WATER HEATER WITHOUT THE ENERGY SAVER MODULE (ESM) BEING OPERATED. SEE PAGE 19.

FIGURE 14

## The Electronic Thermostat

**IMPORTANT:** The Energy Saver Module (ESM) must be removed before attempting to access the thermostat. **NOTE:** For the Electronic Thermostat (ET) changes to remain in effect, the Energy Saver Module (ESM) must not be reconnected. Also, read the "Water Temperature Regulation" under the "Operating Your Water Heater" section. If the instructions are not clear, contact a qualified service technician.

The Energy Saver Module (ESM) is intended to serve as the primary interface for operating the water heater; however, the Electronic Thermostat (ET) may control the water heater in the absence of the Energy Saver Module (ESM).

The Electronic Thermostat consists of an electronics box that contains a low voltage power supply, the thermostat set point knob, relays to switch between the upper and lower heating elements, one control thermistor, a connector for the lower element control thermistor, microelectronics to convert the thermistor signals and perform switching and other logic functions, and a connector to tie the Electronic Thermostat (ET) to the Energy Saver Module (ESM) located on the front of the water heater jacket. The majority of the self-diagnostics are located in the Electronic Thermostat (ET), including the dry-fire protection intelligence. The thermostat circuit is designed so that when the upper heating element calls for heat, the power is directed to that element even if the lower element is also calling for heat.

### Diagnostic LED Light

The Green/Red LED light indicates the status of the electronic thermostat (Figure 15).

- Green LED will signal normal operation. The green LED will blink 2 times per second to indicate that power is applied to the upper heating element and at a faster rate (4 times per second) to indicate that the lower heating element is powered.
- Red LED will flash error codes. If a fault is detected by the electronic thermostat, the LED light indicator will use the red LED to indicate the fault detected. The flash code sequence is to consist of 1/2 second flashes of the red LED each separated by a 1/2 second off period.

The number of flashes indicates the fault code number. (See diagnostic code chart section in this manual).

After the last 1/2 second "on" period, the LED will remain off until a total of 5 seconds has elapsed for the fault indication cycle (there is a 5 seconds delay before the fault flash pattern repeats). After the 5 seconds are completed, the fault indication cycle is repeated starting with the first 1/2 second-flash. The flash sequence will be repeated as long as the fault remains. Only one fault can be declared at a time. **NOTE:** the green LED is turned off when a fault code is being displayed, even though the heater may be operating in limp mode with an element on. See diagnostic code chart section in this manual.

### Overriding The Energy Saver Module (ESM)

If the Energy Saver Module (ESM) is not working, simply unplug the interface module and turn the set point knob on the Electronic Thermostat (ET) to the desired temperature (See Figure 15 and Figure 16). To replace a broken or damaged ESM module, see page 32 for ordering information.



ELECTRONIC THERMOSTAT (ET)

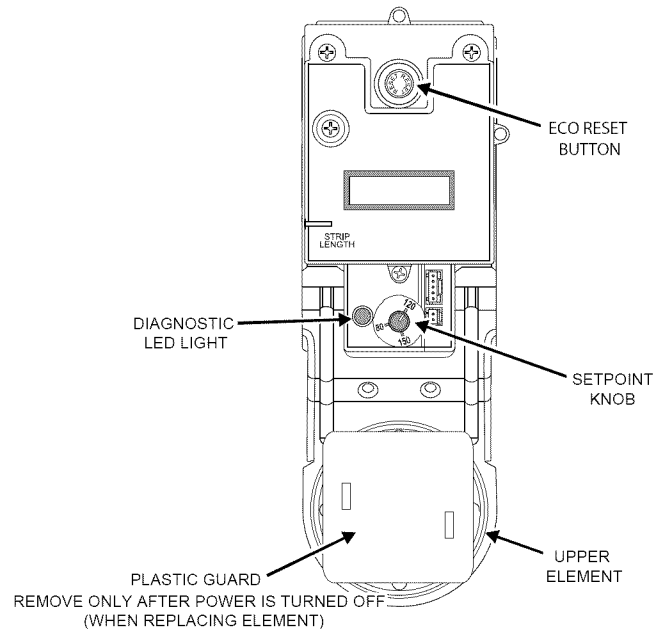

FIGURE 15

ELECTRONIC THERMOSTAT (ET)

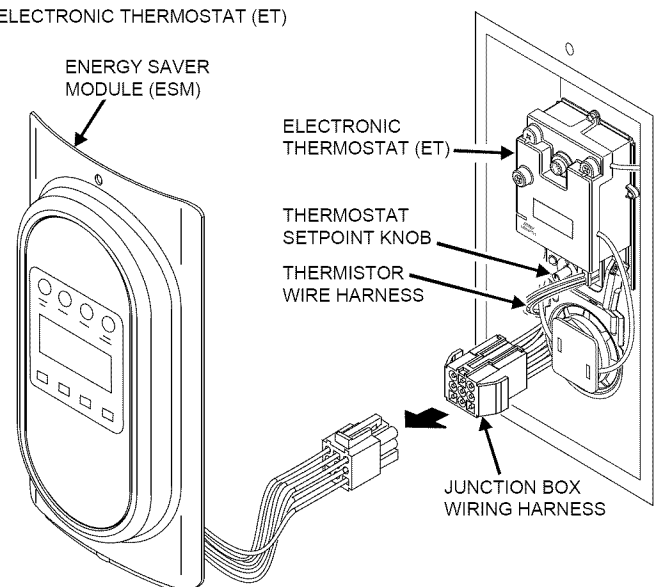

FIGURE 16

**NOTE:** Remote Access will be disabled when the Energy Saver Module (ESM) is disconnected from the junction box wiring harness.

# SERVICE AND ADJUSTMENT

If you lack the necessary skills required to service this water heater properly, or if you have difficulty following the instructions, you should not proceed. Have a qualified service technician perform the maintenance of this water heater.

## Anode Rod Inspection

### CAUTION

#### Property Damage Hazard

- Avoid water heater damage.
- Inspection and replacement of anode as needed.

See also "Smelly Water" on page 23.

Each water heater contains at least one anode rod, which will slowly deplete (due to electrolysis), prolonging the life of the water heater by protecting the glass-lined tank from corrosion. Adverse water quality, hotter water temperatures, high hot water usage, hydronic heating devices, and water softening methods can increase the rate of anode rod depletion. Once the anode rod is depleted, the tank will start to corrode, eventually developing a leak.

Certain water conditions will cause a reaction between the anode rod and the water. The most common complaint associated with the anode rod is a "rotten egg smell" produced from the presence of hydrogen sulfide gas dissolved in the water. **CAUTION:** Do not remove this rod permanently as it will void any warranties. A special anode rod may be available if water odor or discoloration occurs. **NOTE:** this rod may reduce but not eliminate water odor problems. The water supply system may require special filtration equipment from a water conditioning company to successfully eliminate all water odor problems.

Artificially softened water is exceedingly corrosive because the process substitutes sodium ions for magnesium and calcium ions.

The anode rod should be inspected after a maximum of three years and annually thereafter until the condition of the anode rod dictates its replacement. **NOTE:** Artificially softened water requires the anode rod to be inspected annually.

The following are typical (but not all) signs of a depleted anode rod:

- The majority of the rods diameter is less than 3/8".
- Significant sections of the support wire (approx. 1/3 or more of the anode rod's length) are visible.

If the anode rod shows signs of either or both it should be replaced (Figure 17). **NOTE:** Whether re-installing or replacing the anode rod, check for any leaks and immediately correct if found.

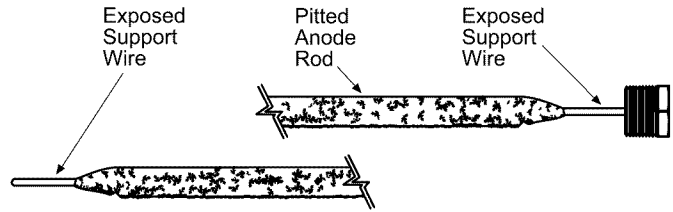

FIGURE 17

Follow these steps to replace the anode:

1. Turn off power to the water heater.
2. Shut off the water supply and open a nearby hot water faucet to depressurize the water tank.
3. Drain approximately 5 gallons of water from tank. (Refer to "Draining and Flushing" for proper procedures). Close drain valve.
4. Remove old anode rod.
5. Use Teflon<sup>®</sup> tape or approved pipe sealant on threads and install new anode rod.
6. Turn on water supply and open a nearby hot water faucet to purge air from water system. Check for any leaks and immediately correct any if found.
7. Restart the water heater as directed in this manual.

**NOTE:** The water heater will conduct a system diagnostic prior to operation. See the Repair Parts Illustration for anode rod location.

Teflon<sup>®</sup> is a registered trade mark of Chemours.

## Temperature-Pressure Relief Valve Operation

The temperature-pressure relief valve must be manually operated at least once a year.

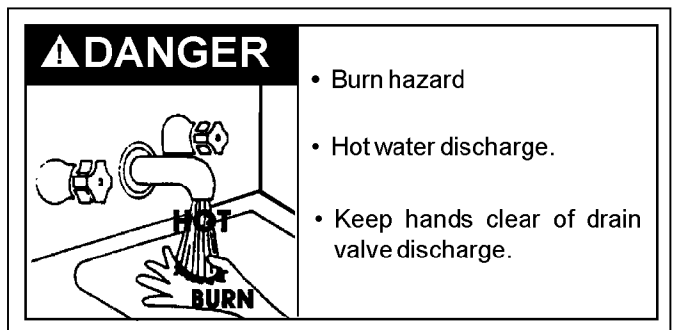

The temperature-pressure relief valve must be manually operated at least once a year. Caution should be taken to ensure that (1) no one is in front of or around the outlet of the temperature-pressure relief valve discharge line, and (2) the water manually discharged will not cause any property damage or bodily injury. The water may be extremely hot.

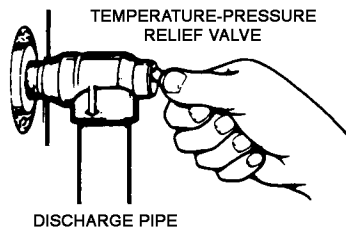

FIGURE 18

If after manually operating the valve, it fails to completely reset and continues to release water, immediately disconnect the electrical power, close the cold water inlet valve, then call a qualified service technician.

Failure to install and maintain a new properly listed temperature-pressure relief valve will release the manufacturer from any claim which might result from excessive temperature or pressure.

If the temperature-pressure relief valve on the appliance weeps or discharges periodically, this may be due to thermal expansion. Your water heater may have a check valve installed in the water line or a water meter with a check valve. Consult your local Sears Service Center for further information. Do not plug the temperature-pressure relief valve.

### Draining and Flushing

<b>⚠ DANGER</b>	<ul style="list-style-type: none"> <li>• Burn hazard</li> <li>• Hot water discharge.</li> <li>• Keep hands clear of drain valve discharge.</li> </ul>

It is recommended that the tank be drained and flushed every 6 months to remove sediment which may build up during operation. The water heater should be drained if being shut down during freezing temperatures. To drain the tank, perform the following steps:

	<b>⚠ WARNING</b>
	<ul style="list-style-type: none"> <li>• Before removing any access panels or servicing the water heater, make sure the electrical supply to the water heater is turned "OFF".</li> <li>• Failure to do this could result in death, serious bodily injury, or property damage.</li> </ul>

1. Turn off power to the water heater.
2. Open a nearby hot water faucet until the water is no longer hot.
3. Close the cold water inlet valve.
4. Connect a hose to the drain valve and terminate it to an adequate drain or external to the building.

5. Open the water heater drain valve and allow all of the water to drain from the tank. Flush the tank with water as needed to remove sediment.
6. Close the drain valve, refill the tank, and restart the heater as directed in this manual. **CAUTION:** Do not turn on power to the water heater unless it is completely filled with water.

If the water heater is going to be shut down for an extended period, the drain valve should be left open.

**IMPORTANT:** Condensation may occur when refilling the tank and should not be confused with a tank leak.

<b>CAUTION</b>
<b>Improper installation and use may result in property damage.</b>
<ul style="list-style-type: none"> <li>• Fill tank with water before operation.</li> </ul>

Never use this water heater unless it is completely full of water. To prevent damage to the tank and heating element, the tank must be filled with water. Water must flow from the hot water faucet before turning "ON" power.

### Heating Element Replacement

<b>⚠ WARNING</b>	
	<p style="text-align: center;"><b>Electrical Shock Hazard</b></p> <p><b>Disconnect power before servicing.</b></p> <p><b>Replace all parts and panels before operating.</b></p> <p><b>Failure to do so can result in death or electrical shock.</b></p>

Replacement heating elements must be of the same style and voltage/wattage rating as the ones originally in the water heater. This information can be found on the flange or terminal block of the element or on the water heater rating plate.

1. Turn off the electric power to the water heater.
2. Drain the water heater as directed under "Draining and Flushing" section.
3. Remove the access cover(s), then remove the insulation and element cover(s). Remove the plastic guard covering electric wiring.
4. Disconnect the electric wires from the heating element. (See Figure 19.) Remove the screw-in element by turning the element counterclockwise with an SAE 1-1/2 inch socket wrench or use an element wrench. Remove the existing gasket.

*Continued on the next page.*

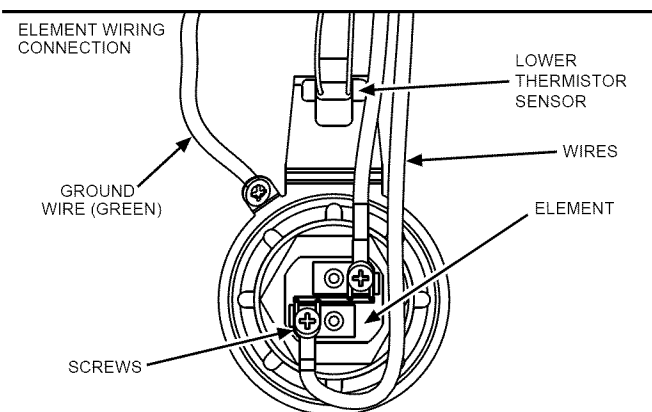

FIGURE 19

11. Reconnect the electric power to the water heater.
12. Turn on the electrical power to the water heater.  
**NOTE:** The water heater will conduct a system diagnostic prior to operation.

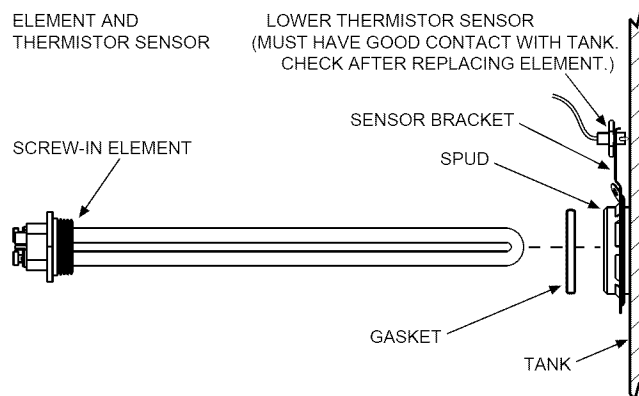

FIGURE 20

5. Clean the area with a soft cloth to remove any debris where the gasket fits to the tank. If replacing the bottom element, remove the accumulated sediment on the bottom of the tank. Refer to "Draining and Flushing."
6. Make sure the replacement element has the correct voltage and wattage rating. Lubricate the new gasket with a few drops of dishwashing soap, position the new gasket on the element and insert it into the water heater tank (Figure 20). Tighten the element by turning it clockwise until secure.
7. Close the drain valve. Open the nearest hot water faucet and allow the tank to fill completely with water. To purge the lines of any excess air and sediment debris, keep the hot water faucet open for 3 minutes after a constant flow of water is obtained. Close the faucet.
8. Check for leaks around element(s) and other connections.
9. Connect the electric wires to the heater element. Make sure all wires are secure. Reinstall plastic guard covering wiring.
10. Replace the insulation and access door(s).

**IMPORTANT:** Operation of this water heater without access doors or insulation could result in much higher temperatures than the desired set point, increasing the risk of scald injury. Do not operate the water heater with the access doors or insulation removed.

## Service

Before calling for repair service, read the "Start Up Conditions" and "Operational Conditions" found in the Troubleshooting section of this manual.

If a condition persists or you are uncertain about the operation of the water heater, let a qualified person check it out.

Contact Sears Repair Services at 1-844-553-6667.

# TROUBLESHOOTING

## Start Up Conditions

### CLOSED SYSTEM/THERMAL EXPANSION

## CAUTION

### Property Damage Hazard

- Avoid water heater damage.
- Install thermal expansion tank or device if necessary.
- Contact qualified installer or service agency.

As water is heated, it expands (thermal expansion). In a closed system, the volume of water will increase. As the volume of water increases, there will be a corresponding increase in water pressure due to thermal expansion. Thermal expansion can cause premature tank failure (leakage). This type of failure is not covered under the limited warranty. Thermal expansion can also cause intermittent temperature-pressure relief valve operation: water discharged from the valve due to excessive pressure build up. The temperature-pressure relief valve is not intended for the constant relief of thermal expansion. This condition is not covered under the limited warranty.

A properly-sized thermal expansion tank should be installed on all closed systems to control the harmful effects of thermal expansion. Thermal expansion tanks are available from Sears stores and through the Sears Service Centers. Contact the local plumbing inspector, water supplier and/or the Sears Service Center for assistance in controlling these situations.

### Thermal Expansion Tank Specifications

Model Number	Tank Capacity In Gallons	Dimensions in Inches		Pipe Fitting On Tank
		Diameter	Length	
153.331021	2	8 (203 mm)	12-3/4 (323 mm)	3/4" Male
153.331051	5	11 (279 mm)	14-3/4 (375 mm)	3/4" Male

### Expansion Tank Sizing Chart

	Inlet Water Pressure*	Water Heater Capacity (Gallons)				
		30	40	50	66	82
Expansion Tank Capacity Needed	40psi	2	2	2	5	5
	50psi	2	2	2	5	5
	60psi	2	2	5	5	5
	70psi	2	2	5	5	5
	80psi	2	5	5	5	5

\*Highest recorded inlet water pressure in a 24 hour period or regulated water pressure.

**NOTE: Expansion tanks are pre-charged with a 40 psi air charge. If the inlet water pressure is higher than 40 psi, the expansion tank's air pressure must be adjusted to match that pressure, but must not be higher than 80 psi.**

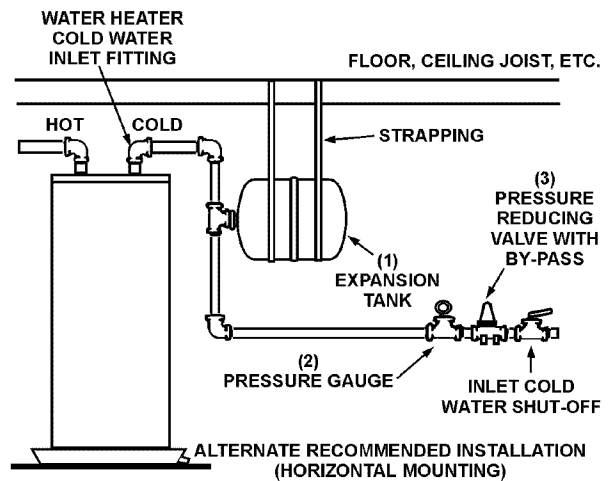
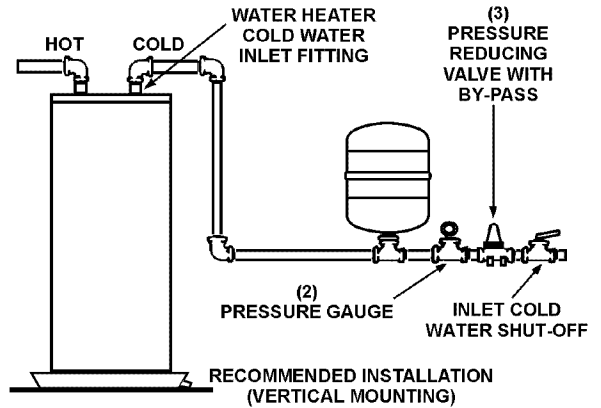

FIGURE 21

### STRANGE SOUNDS

Possible noises due to expansion and contraction of some metal parts during periods of heat-up and cool-down do not represent harmful or dangerous conditions.

### Operational Conditions

#### SMELLY WATER

See also "Anode Rod Inspection" on page 20.

In each glass-lined water heater there is installed at least one anode rod (see parts section) for corrosion protection of the tank. Certain water conditions will cause a reaction between this rod and the water. The most common complaint associated with the anode rod is one of a "rotten egg smell". This odor is derived from hydrogen sulfide gas dissolved in the water. The smell is the result of four factors which must all be present for the odor to develop:

- A concentration of sulfate in the supply water.
- Little or no dissolved oxygen in the water.
- A sulfate reducing bacteria within the water heater. (This harmless bacteria is non-toxic to humans.)
- An excess of active hydrogen in the tank. This is caused by the corrosion-protective action of the anode.

Smelly water may be eliminated or reduced in some water heater models by replacing the anode rod (s) with one of less active material, and then chlorinating the water heater tank and all hot water lines. Contact the local Sears Service Center for further information concerning an Anode Replacement Kit #9001453 and this Chlorination Treatment. **Anode replacement and chlorination of the tank are not covered by the water heater's limited warranty.**

If the smelly water persists after the anode replacement and chlorination treatment, then you should consider chlorinating or aerating your water supply.

**Do not remove the anode leaving the tank unprotected. By doing so, all warranty on the water heater tank is voided.**

**“AIR” IN HOT WATER FAUCETS**

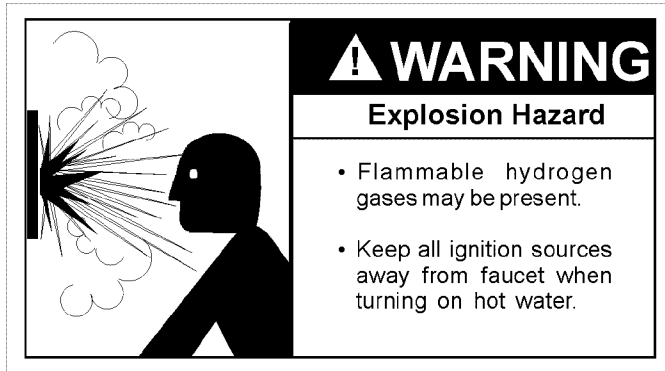

**HYDROGEN GAS:** Hydrogen gas can be produced in a hot water system that has not been used for a long period of time (generally two weeks or more). Hydrogen gas is extremely flammable and explosive. To prevent the possibility of injury under these conditions, we recommend the hot water faucet be opened for several minutes at the kitchen sink before any electrical appliances which are connected to the hot water system are used (such as a dishwasher or washing machine). If hydrogen gas is present, there will probably be an unusual sound similar to air escaping through the pipe as the hot water faucet is opened. There must be no smoking or open flame near the faucet at the time it is open.

**RUMBLING NOISE**

In some water areas, scale or mineral deposits will build up on your heating elements. This buildup will cause a rumbling noise. Follow “Element Cleaning/Replacement” instructions to clean and replace the elements.

**HIGH TEMPERATURE SHUT OFF SYSTEM**

The water heater has a high limit shut off system with a reset button located on the thermostat. Follow the resetting instructions which refer to the high limit behind the access panel.

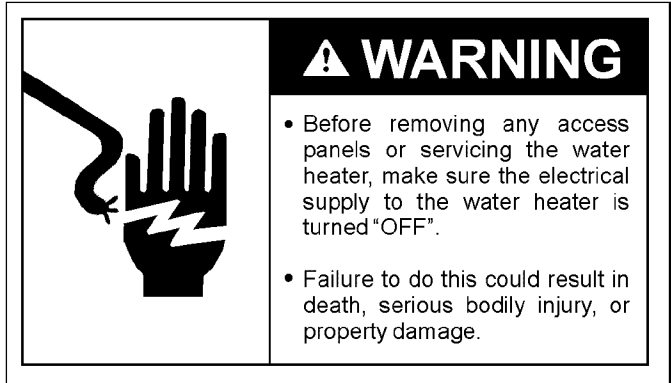

1. Before beginning, turn “OFF” electrical power supply to the water heater.

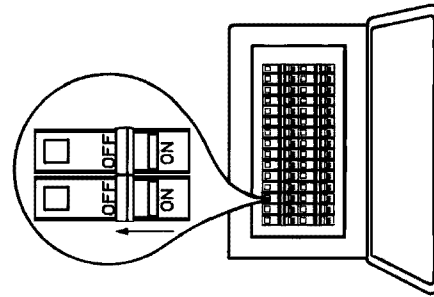

**FIGURE 22**

2. Remove the screw securing the access panel on the water heater and remove the panel.
3. Fold the insulation back to expose the thermostat.
4. Reset the high limit by pressing the ECO reset button on the electronic thermostat. See Figure 15 on page 19. Replace the insulation so that it completely covers the thermostat and element.
5. Replace the access panel.
6. Turn “ON” electric power to the water heater.

If the high limit must be reset again, call Sears Service Department to find out why the high limit turned “OFF” the electric power.



### **NOT ENOUGH OR NO HOT WATER**

1. In a new installation, the water heater may not be properly connected. Make sure the cold water supply valve is open. Review and check piping installation. Make sure that the cold water line is connected to the cold water inlet to the water heater and the hot water line to the hot water outlet on the water heater.
  2. Make sure the electrical supply to your water heater is "ON".
  3. Check for loose or blown fuses in your water heater circuit. Circuit breakers weaken with age and may not handle their rated load and should be replaced.
  4. Make certain the disconnect switch, if used, is in the "ON" position.
  5. Check to see the electric service to your house has not been interrupted. If this is the case, contact the electric company.
  6. Is the thermostat set to the desired temperature? See the "Temperature Regulation" and "Modes and Adjustments" sections.
  7. If you had experienced very hot water and now no hot water, the problem may be due to the high temperature shut off system. See "High Temperature Shut Off System" in the "Troubleshooting" section.
  8. During very cold weather, the incoming water will also be colder and it will require a longer time to become heated.
  9. The hot water usage may exceed the capacity of the water heater. If so, wait for water heater to recover after abnormal demand. Also examine pipes and faucets for possible water leaks.
  10. If you can not determine the problem, then call the Sears Service Department.
- 

### **WATER IS TOO HOT**

Adjust the thermostat to a lower setting. See the "Temperature Regulation" and "Modes and Adjustments" sections.

### **STACKING**

Certain water usage patterns can cause the water temperature to exceed the thermostat setting. This is known as "Stacking".

Stacking occurs when a series of short draws of hot water (3 gallons or less) are taken from the water heater tank. This causes increased cycling of the heater elements and can result in increased water temperatures at the hot water outlet. To reduce the risk of scalding, install thermostatic mixing valves (temperature limiting valves) at each point of use (recommended). Mixing valves are available at local hardware stores.

## Diagnostic Code Chart: Energy Saver Module (ESM)

Refer to the table below and on the following page.

**IMPORTANT:** Before attempting to adjust the thermostat, read the “Water Temperature Regulation” section on page 17.

The Electronic Thermostat (ET) is designed so that it may control the water heater without the Energy Saver Module (ESM) being operated. See page 19.

If the instructions are not clear, contact a qualified service technician.

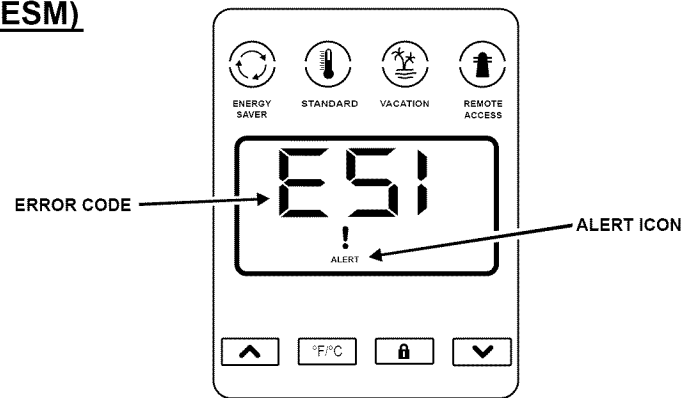

FIGURE 23

(ESM) ERROR CODE	INDICATES	CORRECTIVE ACTION*
<b>E01</b> with an alert icon flashing.	Dry-fire, electrical power on with the tank not completely full of water.	<ol style="list-style-type: none"> <li>1. Turn off electrical power at breaker, add water.</li> <li>2. Turn on electrical power at breaker.</li> <li>3. See “Water Heater Start-Up” on page 17.</li> </ol>
<b>E02</b> with an alert icon flashing.	Water temperature exceeded high limit.	<ol style="list-style-type: none"> <li>1. Turn off electrical power at the breaker.</li> <li>2. Press the reset button (see Figure 15, page 19).</li> <li>3. Turn on electrical power at breaker.</li> <li>4. If error returns call a service technician for assistance.</li> </ol>
<b>E03</b> with an alert icon flashing.	Upper thermistor sensor failure. Note: Upper thermistor sensor is part of the Electronic Thermostat (ET).	<ol style="list-style-type: none"> <li>1. Turn off electrical power at the breaker.</li> <li>2. Replace Electronic Thermostat (ET).</li> <li>3. Turn on electrical power at breaker.</li> </ol>
<b>E04</b> with an alert icon flashing.	Upper element circuit failure. (Note: Lower element is still operable)	<ol style="list-style-type: none"> <li>1. Turn off electrical power at the breaker.</li> <li>2. Check upper element circuit for resistance of 5-25 ohms (replace if required).</li> <li>3. Check wires at elements and Electronic Thermostat (ET) for damage. If this 4 flashes condition continues, replace Electronic Thermostat (ET).</li> <li>4. Turn on electrical power at breaker.</li> </ol>
<b>E05</b> with an alert icon flashing.	Lower element circuit failure. (Note: Upper element is still operable)	<ol style="list-style-type: none"> <li>1. Turn off electrical power at the breaker.</li> <li>2. Check lower element circuit for resistance of 5-25 ohms (replace if required).</li> <li>3. Check wires at elements and Electronic Thermostat (ET) for damage. If this 5 flashes condition continues, replace Electronic Thermostat (ET).</li> <li>4. Turn on electrical power at breaker.</li> </ol>
<b>E06</b> with an alert icon flashing.	Electronic Thermostat (ET) failure (Internal processor).	<ol style="list-style-type: none"> <li>1. Turn off electrical power at the breaker. Now turn on electrical power to see if error clears. If error has not cleared, replace Electronic Thermostat (ET).</li> <li>2. Turn on electrical power at breaker.</li> </ol>
<b>E07</b> with an alert icon flashing.	Lower thermistor sensor failure.	<ol style="list-style-type: none"> <li>1. Turn off electrical power at the breaker.</li> <li>2. Check electrical connections at Electronic Thermostat (ET).</li> <li>3. Replace Lower Thermistor Sensor.</li> <li>4. Turn on electrical power at breaker.</li> </ol>
<b>E08</b> with an alert icon flashing.	Energy Saver Module (ESM) failure.	<ol style="list-style-type: none"> <li>1. Turn off electrical power.</li> <li>2. Check wires at the interface module for damage.</li> <li>3. If this 8 flashes condition continues, replace module (ESM).</li> <li>4. See “Overriding The Energy Saver Module (ESM)” on page 19. Unplug the Electronic Thermostat (ET) as described. NOTE: the Electronic Thermostat (ET) will continue to be operate; hot water will still be available. Set point on ET may need to be adjusted to match ESM set point.</li> <li>5. Turn on electrical power at breaker.</li> </ol>

<b>E09</b> with an alert Icon flashing. <b>E10</b> <b>E11</b> <b>E12</b>	Electronic Thermostat (ET) error.	<ol style="list-style-type: none"> <li>1. Turn off electrical power.</li> <li>2. Check wiring at Electronic Thermostat (ET) for damage.</li> <li>3. Turn on electrical power at breaker.</li> <li>4. If this code flashes condition continues, replace the Electronic Thermostat (ET).</li> </ol>
<b>E51</b> with an alert Icon flashing.	A failure to communicate with the Electronic Thermostat (ET).	<ol style="list-style-type: none"> <li>1. Turn off electrical power at the breaker, check all electrical connections, and wiring for damage.</li> <li>2. Replace the Electronic Thermostat (ET).</li> <li>3. Turn on electrical power at breaker.</li> </ol>
<b>E52</b> with an alert Icon flashing.	Energy Saver Module (ESM) is receiving the wrong data from the Electronic Thermostat (ET).	<ol style="list-style-type: none"> <li>1. Turn off electrical power at the breaker, check all electrical connections, and wiring for damage.</li> <li>2. Replace the Energy Saver Module (ESM), if this does not correct the problem, also replace Electronic Thermostat (ET).</li> </ol>
<b>E71</b> with an alert Icon flashing.	Energy Saver Module (ESM) thermistor failure.	<ol style="list-style-type: none"> <li>1. Turn off electrical power at the breaker, check all electrical connections, and wiring for damage.</li> <li>2. Turn on electrical power at breaker.</li> <li>3. If error returns call service technician for assistance.</li> </ol>

\* These instructions are brief and are intended as guidance for a qualified service technician. If you lack the skills that are necessary to perform these procedures, call the Sears Service Center for assistance (1-844-553-6667).

## Diagnostic Code Chart: Electronic Thermostat (ET)

Refer to the table below and on the following page.

**IMPORTANT:** Before attempting to adjust the thermostat, read the "Water Temperature Regulation" section on page 17.

The Electronic Thermostat (ET) is designed so that it may control the water heater without the Energy Saver Module (ESM) being operated. See page 19.

If the instructions are not clear, contact a qualified service technician.

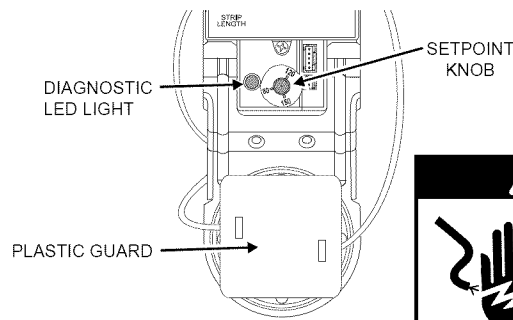

FIGURE 24



(ESM) ERROR CODE	(ET) DIAGNOSTIC LED	INDICATES	CORRECTIVE ACTION*
	LIGHT ON (Green Flash)	Normal operation.	None
	NO LIGHT	No electrical power to control board or diagnostic LED light burned out.	<ol style="list-style-type: none"> <li>1. Check for blown fuses or tripped breaker.</li> <li>2. If diagnostic LED light is burned out, replace Electronic Thermostat (ET).</li> <li>3. Check connections in junction box.</li> </ol>
E01	1 FLASH (Red)	Dry-fire, electrical power on with the tank not completely full of water.	<ol style="list-style-type: none"> <li>1. Turn off electrical power at breaker, add water.</li> <li>2. Turn on electrical power at breaker.</li> <li>3. See "Water Heater Start-Up" on page 17.</li> </ol>
E02	2 FLASHES (Red)	Water temperature exceeded high limit.	<ol style="list-style-type: none"> <li>1. Turn off electrical power at the breaker.</li> <li>2. Press the reset button (see Figure 15, page 19).</li> <li>3. Turn on electrical power at breaker.</li> <li>4. If error returns call a service technician for assistance.</li> </ol>
E03	3 FLASHES (Red)	Upper thermistor sensor failure. Note: Upper thermistor sensor is part of the Electronic Thermostat (ET).	<ol style="list-style-type: none"> <li>1. Turn off electrical power at the breaker.</li> <li>2. Replace Electronic Thermostat (ET).</li> <li>3. Turn on electrical power at breaker.</li> </ol>
E04	4 FLASHES (Red)	Upper element circuit failure. (Note: Lower element is still operable)	<ol style="list-style-type: none"> <li>1. Turn off electrical power at the breaker.</li> <li>2. Check upper element circuit for resistance of 5-25 ohms (replace if required).</li> <li>3. Check wires at elements and Electronic Thermostat (ET) for damage. If this 4 flashes condition continues, replace Electronic Thermostat (ET).</li> <li>4. Turn on electrical power at breaker.</li> </ol>
E05	5 FLASHES (Red)	Lower element circuit failure. (Note: Upper element is still operable)	<ol style="list-style-type: none"> <li>1. Turn off electrical power at the breaker.</li> <li>2. Check lower element circuit for resistance of 5-25 ohms (replace if required).</li> <li>3. Check wires at elements and Electronic Thermostat (ET) for damage. If this 5 flashes condition continues, replace Electronic Thermostat (ET).</li> <li>4. Turn on electrical power at breaker.</li> </ol>

<b>(ESM) ERROR CODE</b>	<b>(ET) DIAGNOSTIC LED</b>	<b>INDICATES</b>	<b>CORRECTIVE ACTION*</b>
<b>E06</b>	<b>6 FLASHES (Red)</b>	Electronic Thermostat (ET) failure (Internal processor).	<ol style="list-style-type: none"> <li>1. Turn off electrical power at the breaker. Now turn on electrical power to see if error clears. If error has not cleared, replace Electronic Thermostat (ET).</li> <li>2. Turn on electrical power at breaker.</li> </ol>
<b>E07</b>	<b>7 FLASHES (Red)</b>	Lower thermistor sensor failure.	<ol style="list-style-type: none"> <li>1. Turn off electrical power at the breaker.</li> <li>2. Check electrical connections at Electronic Thermostat (ET).</li> <li>3. Replace Lower Thermistor Sensor.</li> <li>4. Turn on electrical power at breaker.</li> </ol>
<b>E08</b>	<b>8 FLASHES (Red)</b>	Energy Saver Module (ESM) failure.	<ol style="list-style-type: none"> <li>1. Turn off electrical power.</li> <li>2. Check wires at the interface module for damage.</li> <li>3. If this 8 flashes condition continues, replace module (ESM).</li> <li>4. See "Overriding The Energy Saver Module (ESM)" on page 19. Unplug the Electronic Thermostat (ET) as described. NOTE: Electronic Thermostat (ET) will continue to be operate. Hot water will still be available.</li> <li>5. Turn on electrical power at breaker.</li> </ol>
<b>E9 E10 E11 E12</b>	<b>9, 10, 11 or 12 FLASHES (Red)</b>	Electronic Thermostat (ET) error	<ol style="list-style-type: none"> <li>1. Turn off electrical power.</li> <li>2. Check wiring at Electronic Thermostat (ET) for damage.</li> <li>3. Turn on electrical power at breaker.</li> <li>4. If this code flashes condition continues, replace the Electronic Thermostat (ET).</li> </ol>

\* These instructions are brief and are intended as guidance for a qualified service technician. If you lack the skills that are necessary to perform these procedures, call the Sears Service Center for assistance (1-844-553-6667).

## Troubleshooting Chart

PROBLEM	POSSIBLE CAUSE(S)	CORRECTIVE ACTION*
NO HOT WATER	<ol style="list-style-type: none"> <li>1. High temperature limit shut-down.</li> <li>2. Defective sensor.</li> <li>3. No power to heater.</li> </ol>	<ol style="list-style-type: none"> <li>1. Refer to "E02" of Diagnostic Code Chart- page 26.</li> <li>2. Refer to "E03 or E07" of Diagnostic Code Chart- page 26.</li> <li>3. Refer to "No Light" of Diagnostic Code Chart- page 28.</li> </ol>
INSUFFICIENT HOT WATER	<ol style="list-style-type: none"> <li>1. Defective lower element.</li> <li>2. Temperature set too low.</li> <li>3. Sediment or lime in tank.</li> <li>4. Defective Dip Tube.</li> <li>5. Heater too small for job.</li> <li>6. Wrong piping connections.</li> <li>7. Leaking faucets and/or plumbing system.</li> <li>8. Wasted hot water.</li> <li>9. Long runs of exposed pipe.</li> <li>10. Hot water piping on outside wall.</li> </ol>	<ol style="list-style-type: none"> <li>1. Refer to "E05" of Diagnostic Code Chart- page 26.</li> <li>2. Set temperature to desired setting.</li> <li>3. Drain, determine if water treatment is needed.</li> <li>4. Replace Dip Tube.</li> <li>5. Check and Install adequate water heater.</li> <li>6. Correct piping.</li> <li>7. Repair faucets and any leaks in the plumbing system.</li> <li>8. Reduce hot water usage.</li> <li>9. Insulate piping.</li> <li>10. Insulate piping.</li> </ol>
HIGH OPERATION COSTS	<ol style="list-style-type: none"> <li>1. Temperature set too high.</li> <li>2. Sediment or lime in tank.</li> <li>3. Heater too small for job.</li> <li>4. Leaking faucets and/or plumbing system.</li> <li>5. Wasted hot water.</li> <li>6. Long runs of exposed piping.</li> <li>7. Hot water piping in exposed wall.</li> <li>8. Elements covered with sediment or lime.</li> </ol>	<ol style="list-style-type: none"> <li>1. Lower temperature control or change to Energy Saver Mode.</li> <li>2. Drain, Flush-Provide water treatment if needed.</li> <li>3. Install adequate heater.</li> <li>4. Repair faucets and any leaks in the plumbing system.</li> <li>5. Advise customer.</li> <li>6. Insulate piping.</li> <li>7. Insulate piping.</li> <li>8. Replace elements.</li> </ol>
SLOW HOT WATER RECOVERY	<ol style="list-style-type: none"> <li>1. Upper element defective.</li> <li>2. Leaking faucets and/or plumbing system.</li> </ol>	<ol style="list-style-type: none"> <li>1. Refer to "E04" of Diagnostic Code Chart- page 26.</li> <li>2. Repair faucets and any leaks in the plumbing system.</li> </ol>
DRIP FROM T&P VALVE	<ol style="list-style-type: none"> <li>1. Excessive water pressure.</li> <li>2. Closed system.</li> <li>3. Defective T&amp;P valve.</li> </ol>	<ol style="list-style-type: none"> <li>1. Use pressure reducing valve and pressure relief valve (See page 12).</li> <li>2. See page 23, "Closed System/Thermal Expansion".</li> <li>3. Replace T&amp;P valve.</li> </ol>
WATER ODOR	<ol style="list-style-type: none"> <li>1. Sulfides in the water.</li> </ol>	<ol style="list-style-type: none"> <li>1. See "Smelly Water" on page 23. See also "Anode Rod Inspection" on page 20</li> </ol>

# LEAKAGE CHECKPOINTS

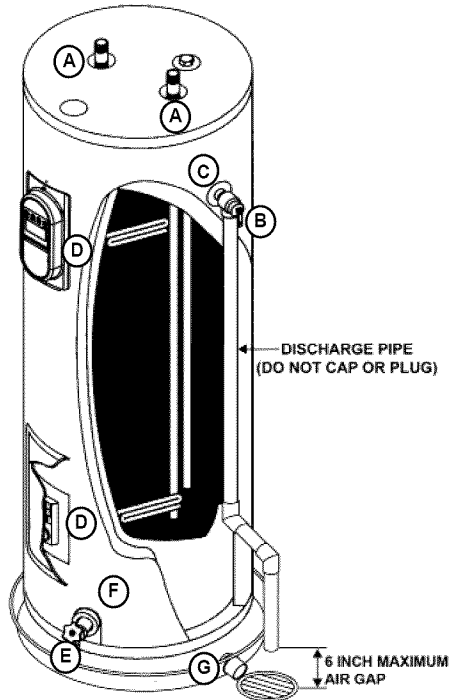
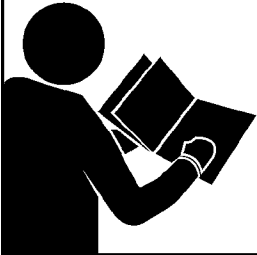

FIGURE 25

Never use this water heater unless it is completely full of water. To prevent damage to the tank and heating element, the tank must be filled with water. The water must flow from the hot water faucet before turning "ON" power.

- A \*Condensation may be seen on pipes in humid weather or pipe connections may be leaking.
- B Small amounts of water from the temperature-pressure relief valve may be due to thermal expansion or high water pressure in your area.
- C \*The temperature-pressure relief valve may be leaking at the tank fitting.
- D The element may be leaking at the tank fitting.



**⚠ WARNING**

Read and understand instruction manual and safety messages before installing, operating or servicing this water heater.

Failure to follow instructions and safety messages could result in death or serious injury.

Instruction manual must remain with water heater.

Read this manual first. Then before checking the water heater make sure the electric supply has been turned "OFF", and never turn the electric supply "on" before the tank is completely full of water.

Use this guide to check a "Leaking" water heater. Many suspected "Leakers" are not leaking tanks. Often the source of the water can be found and corrected.

If you are not thoroughly familiar with electric codes, the water heater, and safety practices, contact your local Sears Service Center to check the water heater.

**CAUTION**

**Improper installation and use may result in property damage.**

- Fill tank with water before operation.

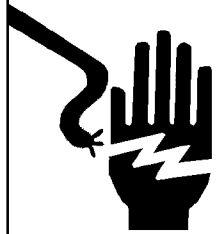

**⚠ WARNING**

- Before removing any access panels or servicing the water heater, make sure the electrical supply to the water heater is turned "OFF".
- Failure to do this could result in death, serious bodily injury, or property damage.

Turn electrical power "OFF", remove access panel and insulation cap with handle. If leaking around element, follow proper draining instructions and remove element. Reposition or replace gasket on element. Place element into opening and tighten securely. Then follow "Filling the Water Heater" instructions in the "Installation Instructions" section.

- E Water from drain valve may be due to the valve being opened slightly
- F \*The drain valve may be leaking at the tank fitting.
- G Water in the water heater bottom or on the floor may be from condensation, loose connections or the temperature-pressure relief valve. DO NOT replace the water heater until a full inspection of all possible water sources is made and necessary corrective steps taken.

Leakage from other appliances, water lines, or ground seepage should also be checked.

\* Note: To check where threaded portion enters tank, insert cotton swab between jacket opening and fitting. If cotton is wet, follow the "Draining" instructions in the "Service and Adjustment" section and then remove fitting. Put pipe dope or thread sealing tape on the threads and replace. Then follow "Filling the Water Heater" instructions in the "Installation Instructions" section.

# REPAIR PARTS LIST

## KENMORE 12 ELECTRIC WATER HEATERS

### MODEL NUMBERS

153.582400	40 Gallon
153.582500	50 Gallon

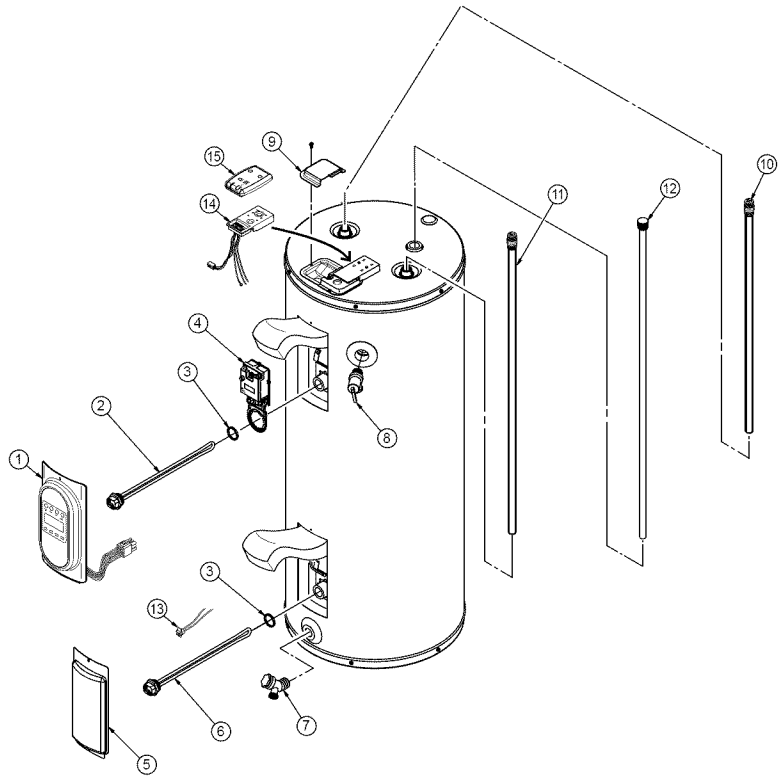

Key No.	Part Description	Model No.	
		153.582400	153.582500
1	Energy Saver Module (ESM) w/ Wiring Harness	100263931	100263931
2	Upper Element	9009129005	9009129005
3	Element Gasket	9000308005	9000308005
4	Electronic Thermostat (ET)	100263929	100263929
5	Access Door	9003900005	9003900005
6	Lower Element	9009129005	9009128005
7	Drain Valve	9009060015	9009060015
8	Temperature and Pressure Relief Valve (T&P)*	9002403015	9002403015
9	Junction Box Cover	N/A	N/A
10	Outlet Nipple/Heat Trap Assembly	9004333005	9009125005
11	Dip Tube (includes nipple with heat trap)	9009127005	9009126005
12	Anode Rod	9001829005	9001829005
13	Thermistor Sensor	100263932	100263932
14	Energy Saver Wire Harness Assembly	100263933	100263933
15	Kenmore Smart Water Heater Module (allows water heater to be controlled remotely; sold separately)*	Sears item #58000*	Sears item #58000*
16	Manual**	100272307	100272307

\* These parts are available at most Sears retail stores.

\*\* Not illustrated.

Now that you have purchased this water heater, should a need ever exist for repair parts or service, simply contact any Sears Service Center or call 1-844-553-6667. Be sure to provide all pertinent facts when you call or visit.

- MODEL NUMBER
- PART NUMBER
- SERIAL NUMBER
- PART DESCRIPTION

WHEN ORDERING REPAIR PARTS, ALWAYS GIVE THE FOLLOWING INFORMATION:

**THIS IS A REPAIR PARTS LIST, NOT A PACKING LIST.**



# NOTES

# NOTES

# NOTES

# Kenmore®

For Sears Home Services in-home repair  
of all Kenmore major appliances.

For the replacement parts, accessories and  
Use & Care Guides that you need to do-it-yourself.

For professional installation of major home appliances  
and items like air conditioners and water heaters.

## 1-844-553-6667

[www.kenmore.com](http://www.kenmore.com)

In Canada 1-800-469-4663

[www.sears.ca](http://www.sears.ca)

---

Call anytime for the location of your nearest  
Sears Parts & Repair Service Center

1-800-488-1222 (U.S.A.)

1-800-469-4663 (Canada)

---

To purchase a protection agreement on a serviceable product:

1-800-827-6655 (U.S.A.)

1-800-361-6665 (Canada)

---

Para pedir servicio de reparación  
a domicilio, y ordenar piezas:

1-888-SU-HOGAR®

(1-888-784-6427)

[www.kenmore.com](http://www.kenmore.com)

Au Canada pour service en français:

1-800-LE-FOYER<sup>MC</sup>

(1-800-533-6937)

[www.sears.ca](http://www.sears.ca)

