

Installation Instructions

If you have questions, call 800.626.2000 or visit our website at: www.monogram.com

36" Chimney Vent Hood

ZV800

49-80267-3

01-13 GE

monogram.com

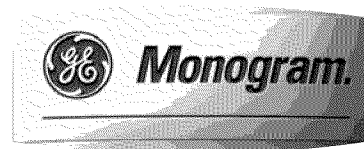

Safety Information

BEFORE YOU BEGIN

Read these instructions completely and carefully.

- **IMPORTANT** — Save these instructions for local inspector's use.
- **IMPORTANT** — Observe all governing codes and ordinances.
- **Note to Installer** — Be sure to leave these instructions with the Consumer.
- **Note to Consumer** — Keep these instructions with your Owner's Manual for future reference.
- **Skill Level** — Installation of this appliance requires basic mechanical and electrical skills.
- **Completion Time** — 1 to 3 Hours.
- Proper installation is the responsibility of the installer. Product failure due to improper installation is not covered under the warranty.

For Monogram local service in your area,
1.800.444.1845.

For Monogram service in Canada 1.888.880.3030

For Monogram Parts and Accessories, call
1.800.626.2002.

⚠CAUTION:

Due to the weight and size of these vent hoods and to reduce the risk of personal injury or damage to the product, **TWO PEOPLE ARE REQUIRED FOR PROPER INSTALLATION.**

⚠PRUDENCE :

À cause du poids et de la taille de ces hottes et pour réduire le risque de blessures et de dommages, **IL FAUT DEUX PERSONNES POUR FAIRE L'INSTALLATION CORRECTEMENT.**

⚠WARNING:

To reduce the risk of fire or electrical shock, do not use this range hood with any external solid-state speed control device. Any such alteration from original factory wiring could result in damage to the unit and/or create an electrical safety hazard.

⚠ADVERTISSEMENT :

Pour réduire le risque d'incendie ou de choc électrique, il ne faut pas utiliser cette hotte avec un régulateur de vitesse électronique externe. Toute modification de ce type du branchement d'usine peut endommager l'appareil ou créer un risque de choc électrique.

TO REDUCE THE RISK OF FIRE, USE ONLY METAL DUCTWORK.

⚠WARNING: TO REDUCE THE RISK OF FIRE, ELECTRICAL SHOCK OR INJURY TO PERSONS, OBSERVE THE FOLLOWING:

- A. Use this unit only in the manner intended by the manufacturer. If you have any questions, contact the manufacturer.
- B. Before servicing or cleaning unit, switch power off at the service panel and lock service panel to prevent power from being switched on accidentally. If the service panel cannot be locked, fasten a tag or prominent warning label to the panel.

⚠ADVERTISSEMENT :

POUR RÉDUIRE LE RISQUE D'INCENDIE, DE CHOC ÉLECTRIQUE OU DE BLESSURES, IL FAUT OBSERVER LES RÈGLES SUIVANTES:

- A. Utiliser cet appareil uniquement de la manière prévue par le fabricant. En cas de question, consulter le fabricant.
 - B. Avant toute intervention ou nettoyage, couper l'alimentation électrique au disjoncteur et verrouiller le panneau du disjoncteur pour éviter la mise sous tension accidentelle. S'il n'est pas possible de verrouiller le panneau du disjoncteur, attacher un placard ou une étiquette très visible au panneau.
- For general ventilating use only. Do not use to exhaust hazardous or explosive materials or vapors.
 - Structural framing, installation work and electrical wiring must be done by qualified person(s). In accordance with all applicable codes and standards including fire-rated construction.
 - Sufficient air is needed for proper combustion and exhausting of gases through the flue (chimney) of fuel burning equipment to prevent back drafting. Follow the heating equipment manufacturer's guideline and safety standards such as those published by the National Fire Protection Association (NFPA), and the American Society for Heating, Refrigeration and Air Conditioning Engineers (ASHRAE), and the local code authorities. When applicable, install any makeup (replacement) air system in accordance with local building code requirements. Visit GEAppliances.com for available makeup air solutions.
 - Local codes vary. Installation electrical connections and grounding must comply with applicable codes. In the absence of local codes, the vent should be installed in accordance with National Electrical Code ANSI/NFPA 70-1990 or latest edition.

⚠CAUTION: To reduce risk of fire and to properly exhaust air, be sure to duct air outside – do not vent exhaust air into spaces within walls or ceilings or into attics, crawl spaces, or garages.

⚠PRUDENCE : Il faut prendre soin d'installer un conduit vers l'extérieur pour réduire le risque d'incendie et pouvoir évacuer l'air correctement. Il ne faut pas évacuer l'air correctement. Il ne faut pas évacuer l'air dans l'espace entre les parois d'un mur, un plafond ou un grenier, un espace sanitaire ou un garage.

Design Information

CONTENTS

Design Information

Product Dimensions and Clearances	3
Installation Options	3
Advance Planning, Ductwork, Framing	4
Power Supply.....	4
Duct Fittings.....	5

Installation Preparation

Tools and Materials Required.....	6
Remove the Packaging.....	6
Wall Mount Installations	7
Installation Below a Wall Cabinet	7
Check Installation Hardware	8
Ductwork, Wiring Locations	9

Wall-Mounted Installation – Vented to the Outside

Step 1, Install Framing for Hood Support	9
Step 2, Install Mounting Bracket.....	10
Step 3, Install Duct Bracket	10
Step 4, Prepare the Hood	11
Step 5, Mount the Hood.....	11
Step 6, Connect Ductwork.....	12
Step 7, Connect Electrical.....	12
Step 8, Install Duct Covers.....	13
Step 9, Install Filters.....	13
Step 10, Finalize Installation	13

Wall-Mounted Installation – Recirculating

Ductwork, Wiring Locations.....	14
Step 1, Install Framing for Hood Support	14
Step 2, Install Mounting Bracket.....	15
Step 3, Prepare the Hood	15
Step 4, Mount the Hood	16
Step 5, Size and Cut Duct Piece	16
Step 6, Connect Electrical.....	17
Step 7, Install Duct Covers	17
Step 8, Install Filters.....	18
Step 9, Finalize Installation	18

Under-Cabinet Installation

Cabinet Requirements	19
Ductwork, Wiring.....	19
Step 1, Install Framing for Hood Support	20
Step 2, Prepare the Hood	20
Step 3, Cut the Opening	21
Step 4, Install Side "L" Brackets	21
Step 5, Remove Side Screw	21
Step 6, Mount the Hood	22
Step 7, Complete Installation and Connect Ductwork	22
Step 8, Connect Electrical.....	23
Step 9, Install Rear Mounting Screws.....	23
Step 10, Install Filters.....	23

PRODUCT DIMENSION AND CLEARANCE

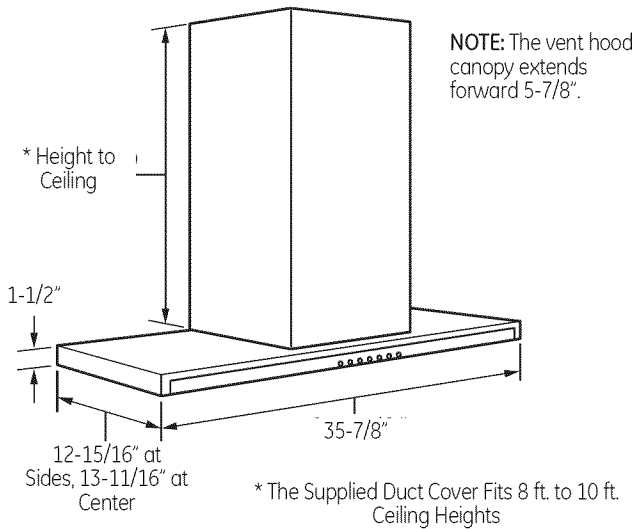

The vent hood must be installed 24" min., and 30" max. above the cooking surface. The telescopic duct cover conceals the ductwork running from the top of the hood to the ceiling. The duct cover is sized to reach 8 ft. to 10 ft. ceiling heights. The hood installation height, from the cooking surface to the bottom of the hood, depends upon ceiling height.

INSTALLATION OPTIONS

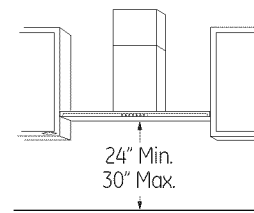

WALL-MOUNTED INSTALLATIONS

This hood may be installed onto a wall and vented to the outdoors, or it can be installed for recirculating operation. All necessary parts for a recirculating operation are shipped with the hood. No kits required.

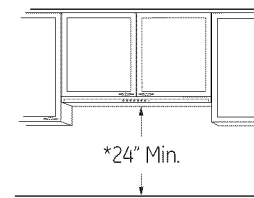

*Depending on Cabinet Height

UNDER-CABINET INSTALLATIONS

The hood may be installed beneath a cabinet. The cabinet must measure at least 20" from the bottom frame to the inside top.

See page 19.

- Both vented and recirculating operation can be accomplished in an under-cabinet installation. (Custom cabinet modification is required for recirculating operation.)

Installation Preparation

ADVANCE PLANNING

- Determine the exact location of the vent hood.
- Plan the route for venting exhaust to the outdoors.
- Use the shortest and straightest duct route possible. For satisfactory performance, duct run should not exceed 100 ft. equivalent length for any duct configurations.
- Refer to “Duct Fittings” chart to compute the maximum permissible length for duct runs to the outdoors.
- When applicable, install any makeup (replacement) air system in accordance with local building code requirements. Visit GEAppliances.com for available makeup air solutions.

⚠CAUTION: To reduce risk of fire and to properly exhaust air, be sure to duct air outside – do not vent exhaust air into spaces within walls or ceilings or into attics, crawl spaces, or garages.

⚠PRUDENCE : Il faut prendre soin d'installer un conduit vers l'extérieur pour réduire le risque d'incendie et pouvoir évacuer

l'air correctement. Il ne faut pas évacuer l'air correctement. Il ne faut pas évacuer l'air dans l'espace entre les parois d'un mur, un plafond ou un grenier, un espace sanitaire ou un garage.

- Use metal ductwork only. These hoods must use 6” round duct. It can transition to 3-1/4” x 12”, reducing the maximum equivalent duct length to 75 feet.
- Install a wall cap with damper or roof cap at the exterior opening. Order the wall or roof cap and any transition needed in advance.

Wall Framing for Adequate Support

- This vent hood is heavy. Adequate structural support must be provided in all types of installations. The hood must be secured to vertical studs in the wall, or to a horizontal support. For wall mounting installations, see pages 9 and 14. For under-cabinet installations, see page 20.
- The vent hood and wall cabinet, if used, should be on site before final framing and wall finishing. This will also help to accurately locate the duct work and electrical service.

POWER SUPPLY

IMPORTANT – (Please read carefully)

⚠WARNING:

FOR PERSONAL SAFETY, THIS APPLIANCE MUST BE PROPERLY GROUNDED.

⚠ADVERTISSEMENT :

POUR DES RAISONS DE SÉCURITÉ, CET APPAREIL DOIT ÊTRE CORRECTEMENT MIS À LA TERRE.

Remove house fuse or open circuit breaker before beginning installation.

Do not use an extension cord or adapter plug with this appliance. Follow National electrical codes or prevailing local codes and ordinances.

Electrical supply

These vent hoods must be supplied with 120V, 60Hz, and connected to an individual, properly grounded branch circuit, and protected by a 15 or 20 amp circuit breaker or time delay fuse.

- Wiring must be 2 wire with ground.
- If the electrical supply does not meet the above requirements, call a licensed electrician before proceeding.

- Route house wiring through conduit as close to the installation location as possible, in the ceiling or back wall.
- Use a conduit connector to secure the conduit to the junction box.
- Connect the wiring to the house wiring in accordance with local codes.

Grounding instructions

The grounding conductor must be connected to a ground metal, permanent wiring system, or an equipment-grounding terminal or lead on the hood.

⚠WARNING: The improper connection of the equipment-grounding conductor can result in a risk of electric shock. Check with a qualified electrician or service representative if you are in doubt whether the appliance is properly grounded.

⚠ADVERTISSEMENT :

Le mauvais branchement du fil de mise à la terre peut causer un choc électrique. En cas de doute, consulter un électricien qualifié ou un technicien pour déterminer si l'appareil est à la terre.

Installation Preparation

DUCT FITTINGS

Use this chart to compute maximum permissible lengths for duct runs to outdoors.

NOTE: Do not exceed maximum permissible equivalent lengths!

Maximum duct length:
100 foot for 6" round duct
75 foot for 3-1/4" x 12" duct











Flexible ducting:

If flexible metal ducting is used, all the equivalent feet values in the table should be doubled. The flexible metal duct should be straight and smooth and extended as much as possible.

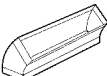
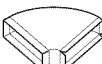
DO NOT use flexible plastic ducting.

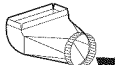
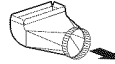
NOTE: Any home ventilation system, such as a ventilation hood, may interrupt the proper flow of combustion air and exhaust required by fireplaces, gas furnaces, gas water heaters and other naturally vented systems. To minimize the chance of interruption of such naturally vented systems, follow the heating equipment manufacturer's guidelines and safety standards such as those published by NFPA and ASHRAE. When applicable, install any makeup (replacement) air system in accordance with local building code requirements. Visit GEAppliances.com for available makeup air solutions.

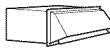
This Hood Must Use a 6" Round Duct. It Can Transition To 3-1/4" x 12" Duct

Duct Piece	Dimensions	Equivalent Length*	Quantity Used	Total Equivalent Length
	Round, straight	1 ft. (per foot length)		
	3-1/4" x 12" 3-1/4" x 24" straight	1 ft. (per foot length)		
	6" Round 90° elbow	15 ft.		
	6" Round 45° elbow	8 ft.		
	3-1/4" x 12" 90° elbow	11 ft.		
	3-1/4" x 12" or 45° elbow	6 ft.		
	3-1/4" x 12" 90° flat elbow	24 ft.		
	6" round to 3-1/4" x 12" or 3-1/4" x 24" transition	1 ft.		
	3-1/4" x 12" to 6" round transition	8 ft.		
	6" round to 3-1/4" x 12" or transition 90° elbow	16 ft.		
	3-1/4" x 12" to 6" round round transition 90° elbow	17 ft.		
	6" round wall cap with damper	30 ft.		
	3-1/4" x 12" wall cap with damper	30 ft.		
	6" Round roof cap	26 ft.		
	6" Round roof vent	26 ft.		

*Actual length of straight duct plus duct fitting equivalent. Equivalent length of duct pieces are based on actual tests conducted by GE Evaluation Engineering and reflect requirements for good venting performance with any ventilation hood.

Total Duct Run _____

Installation Preparation

TOOLS AND MATERIALS REQUIRED (NOT SUPPLIED)

- Tape measure
- Knife
- Spirit level
- Wire cutter/stripper
- Wire nuts
- Electric drill with 1/8" and 3/8" bits
- Phillips and flat blade screwdrivers
- Hammer
- Pliers
- Safety glasses
- Duct tape
- Tape to mount template
- Gloves to protect against sharp edges
- 120V 60Hz. 15 or 20 Amp, 2 wire with ground Properly grounded branch circuit
- Strain relief for junction cover
- 6" round metal duct, length to suit installation
- Saw or jig saw
- Conduit for house wiring and conduit connector

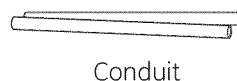
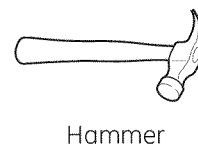
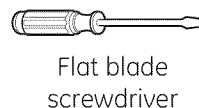
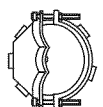
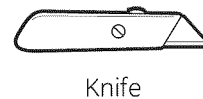
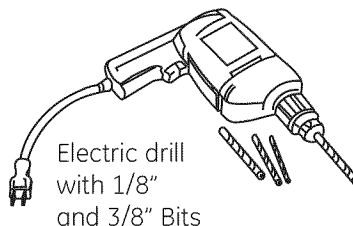
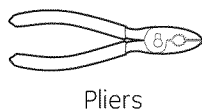
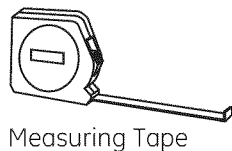

REMOVE THE PACKAGING

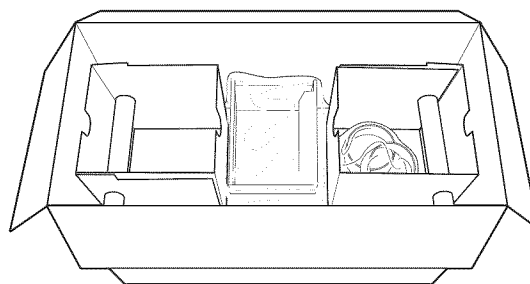
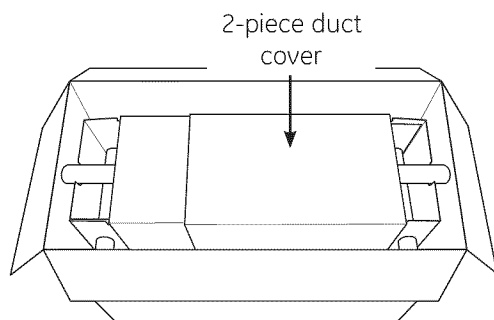

- Remove the duct cover, parts box and other packaging.

- Lift the hood out of the box.
- Remove and properly discard the plastic wrapping.
- Remove junction box cover.

Installation Preparation

WALL MOUNT INSTALLATIONS

These hoods may be installed onto a wall or below a wall cabinet.

- Telescopic duct covers are provided to conceal the ductwork, running to the ceiling.
- This hood can be installed for recirculating operation. No kits required.

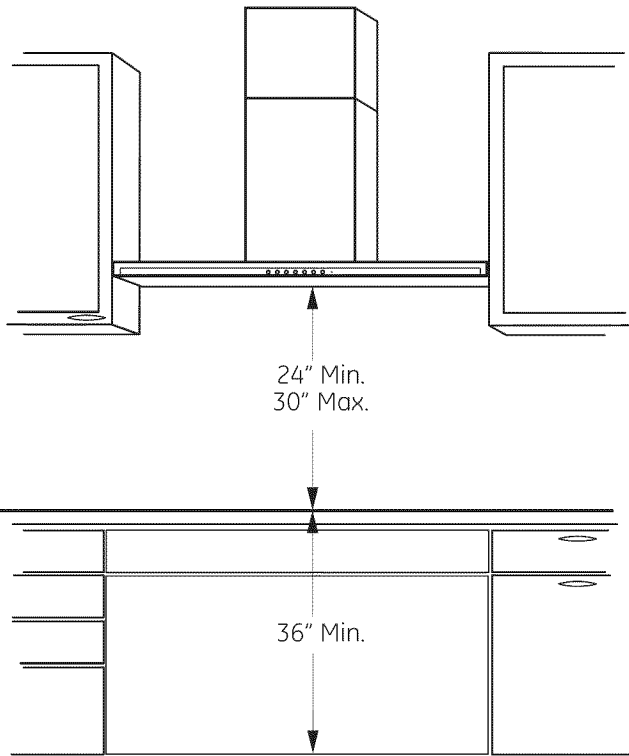

The vent hood must be installed 24" min. and 30" max. above the cooking surface. The hood installation height, from the cooking surface to the bottom of the hood, depends upon ceiling height.

INSTALLATION BELOW A CABINET

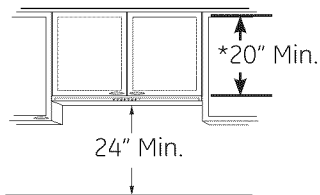

*The cabinet must measure at least 20" from the bottom frame to the inside top. The hood housing will occupy the interior cabinet space.

Wall Mount ZV800 Installation Heights

Actual Ceiling Height	*Possible VENTED Installation Height	*Possible RECIRCULATING Installation Height
7' 11"	24" to 27"	24" to 25"
8' 0"	24" to 28"	24" to 26"
8' 1"	24" to 30"	24" to 27"
8' 2"	24" to 30"	24" to 28"
8' 3"	24" to 30"	24" to 29"
8' 4"	24" to 30"	24" to 30"
8' 5"	24" to 30"	24" to 30"
8' 6"	24" to 30"	24" to 30"
8' 7"	24" to 30"	24" to 30"
8' 8"	24" to 30"	24" to 30"
8' 9"	24" to 30"	24" to 30"
8' 10"	24" to 30"	24" to 30"
8' 11"	24" to 30"	24" to 30"
9' 0"	24" to 30"	24" to 30"
9' 1"	24" to 30"	24" to 30"
9' 2"	24" to 30"	24" to 30"
9' 3"	24" to 30"	24" to 30"
9' 4"	24" to 30"	24" to 30"
9' 5"	24" to 30"	24" to 30"
9' 6"	24" to 30"	24" to 30"
9' 7"	25" to 30"	24" to 30"
9' 8"	26" to 30"	24" to 30"
9' 9"	27" to 30"	24" to 30"
9' 10"	28" to 30"	24" to 30"
9' 11"	29" to 30"	25" to 30"
10'	30"	26" to 30"

*Based on 36" countertop height.

INSTALLATION BELOW A WALL CABINET

Order a cabinet that is at least 20" high from the bottom frame to the inside top. The cabinet must be at least 12" deep.

- The hood installation height is determined by the ceiling height.
- The hood installation height must be 24" Min. above the cooking surface.

Installation Preparation

CHECK INSTALLATION HARDWARE

Locate the hardware accessory box packed with the hood and check contents.

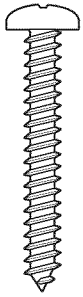

4 wood screws

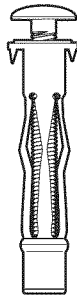

4 wall fasteners

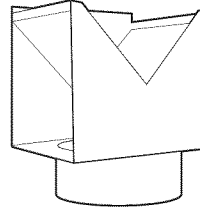

Air deflector for recirculating installations only

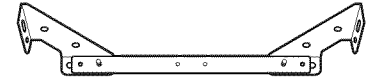

Duct bracket



Mounting bracket

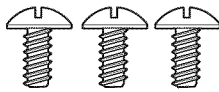

3 Phillips head screws to secure electrical box to top of motor compartment

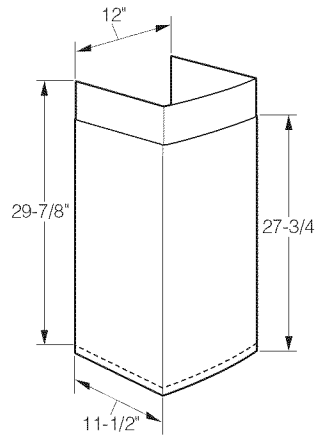

2-piece decorative duct cover (dimension shown for reference only)

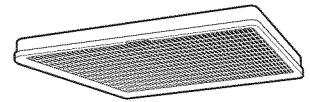

1 charcoal filter for recirculating installations

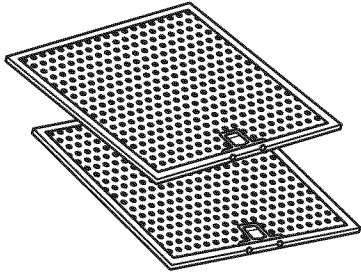

2 stainless steel filters

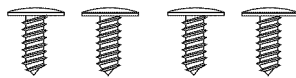

4 Phillips head decorative screws to secure duct cover to ceiling bracket

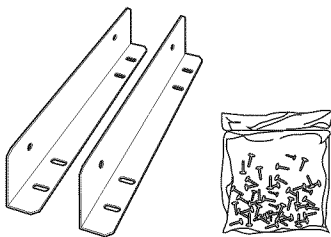

"L" Brackets with hardware package for cabinet-mounted installations.

Contains 10 Phillips head screws to secure the brackets to the cabinet (8 required, 2 extra)

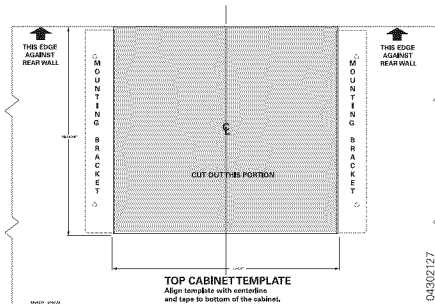

Cabinet installation template

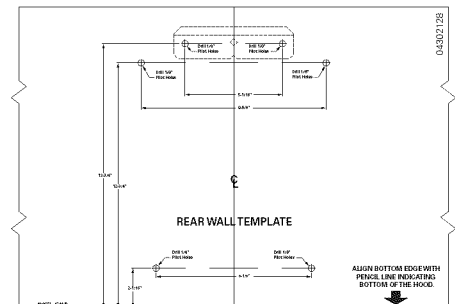

Wall mount template

Installation Instructions

WALL-MOUNTED INSTALLATION—VENTED TO THE OUTSIDE

DUCTWORK, WIRING LOCATIONS

Determine the exact location of the vent hood.

- Locate the template packed with the literature.
 - Measure 36" from the floor to the top of the cooking surface. Add hood installation height determined on page 7. Mark that location.
 - Use a level to draw a straight pencil line on the wall.

3-3/4" centerline to wall → for ceiling vent ducting

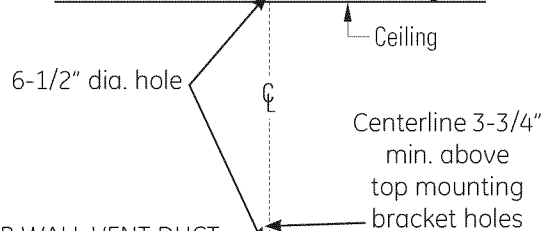

FOR WALL VENT DUCT →

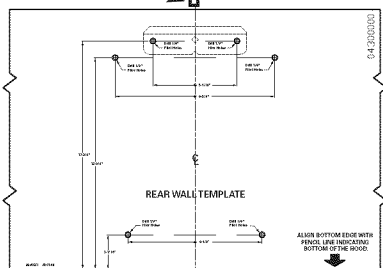

- Tape the template in position along the penciled line. CHECK TO BE SURE THE TEMPLATE IS LEVEL.

Ceiling ducting:

If ductwork will vent straight up to the ceiling:

- Use a level to draw a line straight up, from the centerline on the template to the ceiling.
- Measure 3-3/4" from the back wall to the centerline of a 6-1/2" hole on the ceiling.

NOTE: If drywall is not present, add drywall thickness to the 3-3/4" dimension.

Wall Ducting:

If ductwork will vent to the rear:

- Use a level to draw a line straight up from the centerline on the template.
- Measure at least 3-3/4" above the top mounting bracket holes shown on the template to the centerline of a 6-1/2" dia. duct hole. (Hole may be elongated for duct elbow.)

HOUSE WIRING LOCATION:

- The junction box is located on the top right side of the hood.
- Wiring should enter the back wall 20" to 26" above the bottom of the hood, and within 4" of the right side of the centerline. Wiring should enter at least 4" above the bracket on the right side.

1 INSTALL FRAMING FOR HOOD SUPPORT

IMPORTANT – Framing must be capable of supporting 100 lbs.

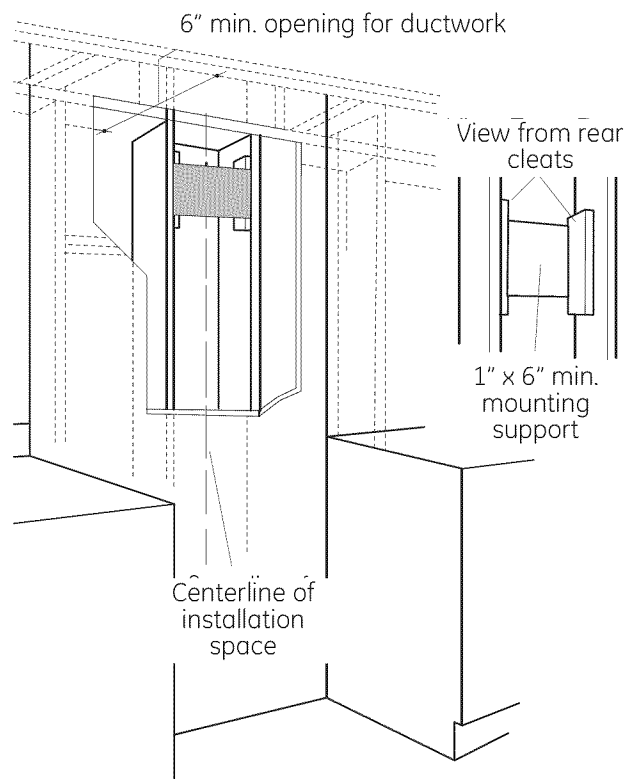

If drywall is present, mark the screw hole locations for the top mounting brackets. Remove the template.

- Cut away enough drywall to expose 2 vertical studs at the bracket location indicated on the template.
- Install a horizontal support at least 1" x 6" between two wall studs at the top bracket installation location. **The horizontal support must be flush with the room side of the studs.** Use cleats behind both sides of the support to secure to wall studs.
- Reinstall drywall.

Installation Instructions

WALL-MOUNTED INSTALLATION—VENTED TO THE OUTSIDE

2 INSTALL MOUNTING BRACKET

This vent hood must be secured to the horizontal support or wall studs.

- With the template taped in place, use a punch to mark all mounting screw locations.
- Drill 1/8" pilot holes at the 6 punched locations.
- Remove the template.
- The 2 holes in the support bracket holes must enter studs or the horizontal support.

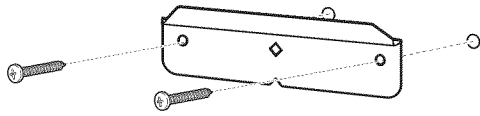

- Use wood screws to secure the mounting bracket to the wall. The screws must engage wall studs or the installed horizontal mounting support.
- Check to be sure that the bracket is level. There is no way to level the hood after hanging it from this bracket.

3 INSTALL DUCT BRACKET

The duct bracket must be installed against the ceiling. This bracket will hold the duct cover in place at the top.

Secure the bracket to the ceiling and wall:

- Align the marked centerline on the bracket with the centerline on the wall.
- Mark the 2 screw hole locations in the ceiling.
- Drill 1/8" pilot holes in the marked locations.
- If pilot holes do not enter studs, enlarge the holes to 3/8" and install wall fastener anchors.
- Drive screws, by hand, into the fasteners to allow anchors to expand. Remove the screws.
- Secure the bracket to the ceiling and wall with wood screws and/or fasteners.

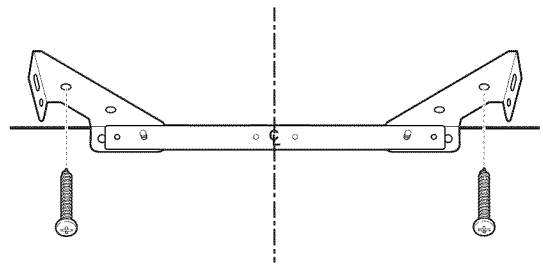

Installation Instructions

WALL-MOUNTED INSTALLATION—VENTED TO THE OUTSIDE

4 PREPARE THE HOOD

- Remove the hood from the box. Remove packaging and tape.

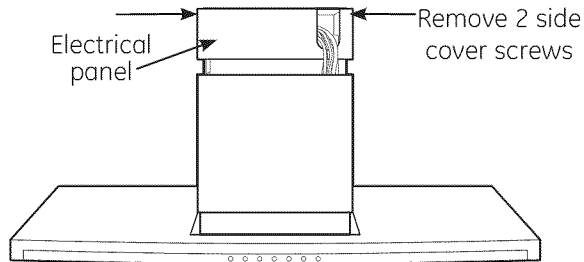

- Remove one screw on each side of the cover on the electrical panel. Lift off the cover and set aside with screws.

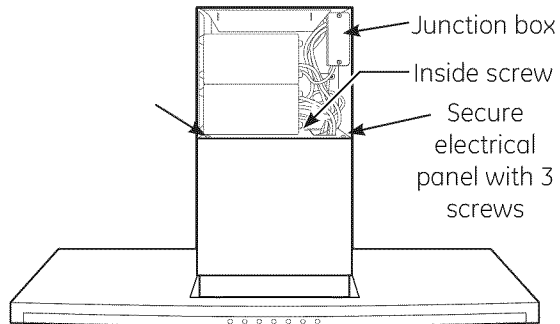

- Stand the electrical panel upright.
- Align the screw holes in the bottom of the panel with the holes on the base of the hood at the front side.
- Install 3 screws provided.

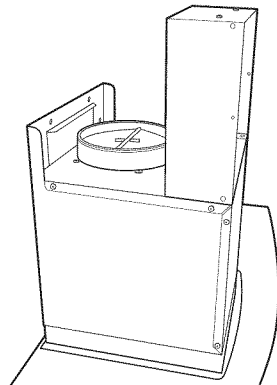

5 MOUNT THE HOOD

- Install a wood screw on each side of the mounting frame.

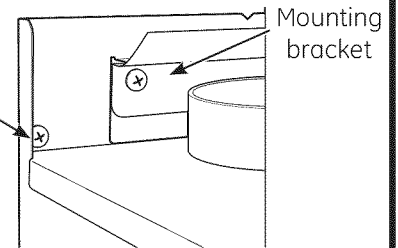

- Lift the hood onto the mounting bracket.
- Check to be sure it is level.
- Install wood screws through the hood and into the wall on each side of the mounting bracket.

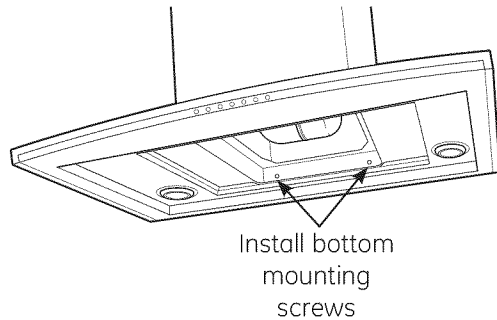

- Extend the canopy forward for better access to the rear mounting screw holes.
- Install 2 wood screws or fasteners through the bottom of the hood into the wall.

Installation Instructions

WALL-MOUNTED INSTALLATION—VENTED TO THE OUTSIDE

6 CONNECT DUCTWORK

- Install ductwork, making connections in direction of airflow as illustrated.
- Push duct over the exhaust outlet and damper.
- Secure joints in ductwork with sheetmetal screws.
- Wrap all duct joints with duct tape for an airtight seal.
- Use duct tape to seal the flange connections.

⚠ CAUTION: Do not use sheet metal screws at the hood flange connection. Doing so will prevent proper damper operations. Seal connection with tape only.

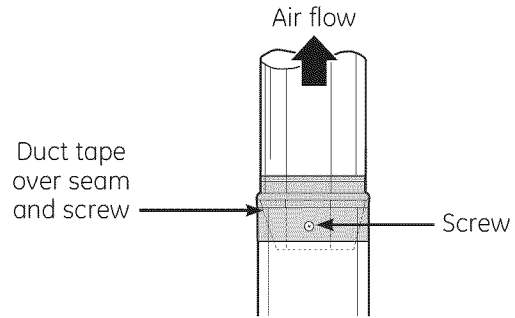

⚠ PRUDENCE :

Il ne faut pas utiliser de vis autotourneuses à la connexion du collet de la hotte. Ceci empêcherait le bon fonctionnement du registre. N'utiliser que du ruban adhésif pour assurer l'étanchéité du raccord.

7 CONNECT ELECTRICAL

Verify that power is turned off at the source.

⚠ WARNING: If house wiring is not 2-wire with a ground wire, a ground must be provided by the installer. When house wiring is aluminum, be sure to use U.L. approved anti-oxidant compound and aluminum-to-copper connectors.

⚠ ADVERTISSEMENT :

Si la maison n'est pas câblée avec deux fils et un fil de terre, l'installateur doit installer un fil de terre. Quand les fils sont en aluminium, il faut prendre soin d'utiliser des connecteurs aluminium à cuivre avec une pâte antioxydante approuvée par U.L.

- Remove junction box cover and knockout.
- Use a conduit connector to secure the conduit to the junction box.
- Connect white leads to branch circuit white lead.
- Connect black leads to branch circuit black lead.
- Connect green/yellow leads to branch circuit green lead or bare ground lead.
- Secure all connections with wire nuts on each electrical connector.
- Push wires into junction box and replace cover. Be sure wires are not pinched.
- Secure electrical panel cover with original screws.

Installation Instructions

WALL-MOUNTED INSTALLATION—VENTED TO THE OUTSIDE

8 INSTALL DUCT COVERS

- Place the decorative duct covers on top of the hood.

NOTE: The inside (upper) duct piece has holes on one end. The holes are intended for use when the hood is installed for recirculating purposes. Slide the vented end into the outer piece, the vent holes should not be visible in this installation.

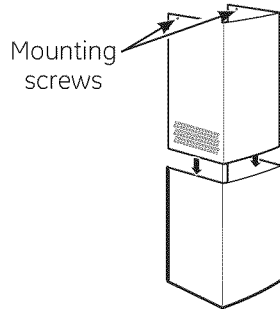

The inside duct piece must slip into the folded ends of the outer section.

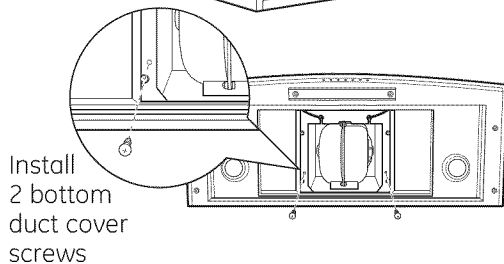
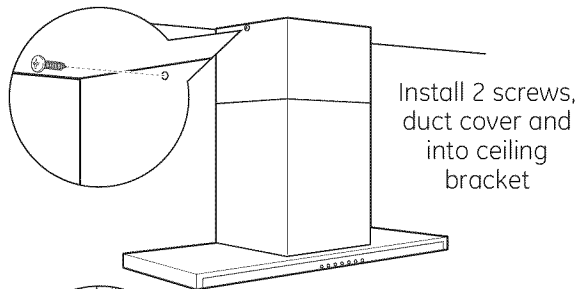

- Extend the inner duct upwards to the ceiling bracket.
- Secure duct cover to ceiling bracket with 2 screws.
- Secure the lower duct cover to the hood by installing 2 screws from the bottom of the hood into the duct cover.

9 INSTALL FILTERS

- Remove protective film on the filters.

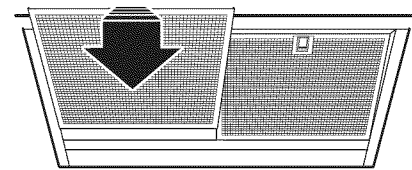
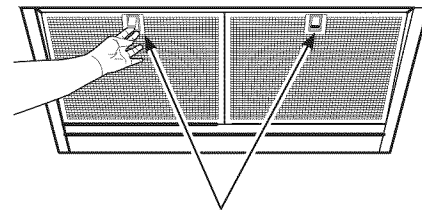

NOTE: The charcoal filter is not required for this installation.

- Tip the filter into the slots at the rear of the opening. Lift the filter lock and pull forward until the filter rests in the slots.
- Install both metal grease filters.
- To remove the filters, press inwards on the handle and pull the filter downwards.

10 FINALIZE INSTALLATION

- Remove all packaging materials.
- Refer to the Owner's Manual for operating instructions.

Installation Instructions

WALL-MOUNTED INSTALLATION—RECIRCULATING

DUCTWORK, WIRING LOCATIONS

- Determine the exact location of the vent hood.
- Locate the template packed with the literature.
- Measure 36" from the floor to the top of the cooking surface. Add hood installation height determined on page 7. Mark that location.

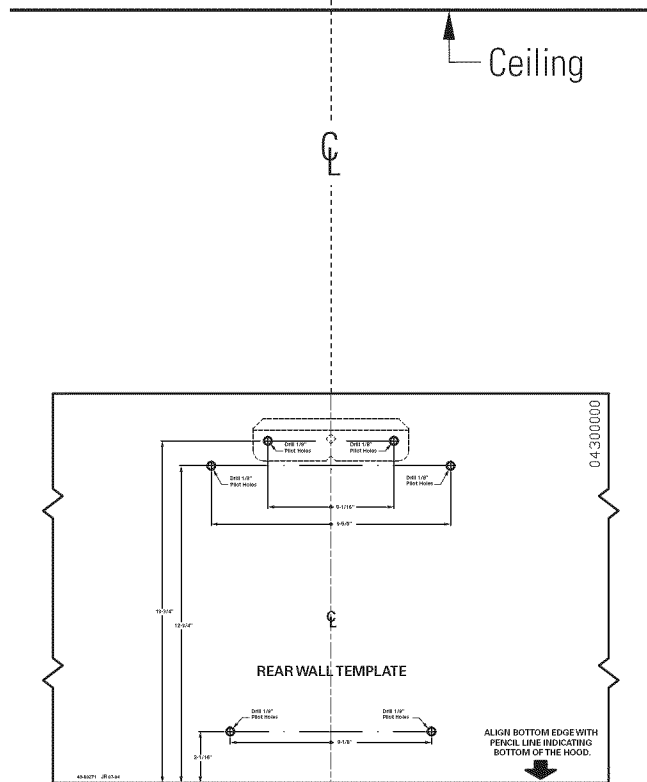

- Tape the template in position along the penciled line. CHECK TO BE SURE THE TEMPLATE IS LEVEL.
- Use a level to draw a line straight up, from the centerline on the template to the ceiling.

HOUSE WIRING LOCATION:

- The junction box is located on the top right side of the hood.
- Wiring should enter the back wall 20" to 26" above the bottom of the hood, and within 4" of the right side of the centerline.

1 INSTALL FRAMING FOR HOOD SUPPORT

IMPORTANT: Framing must be capable of supporting 100 lbs.

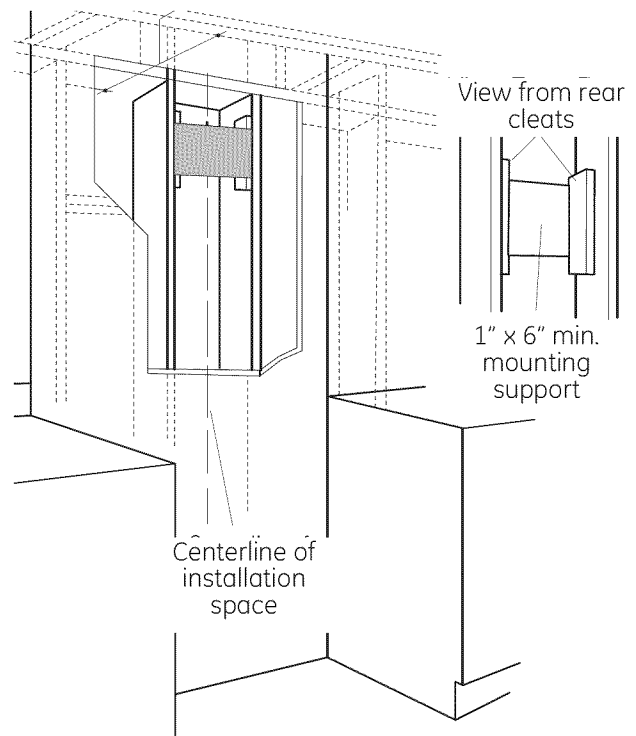

If drywall is present, mark the screw hole locations for the top mounting brackets. Remove the template.

- Cut away enough drywall to expose 2 vertical studs at the bracket location indicated on the template.
- Install a horizontal support at least 1" x 6" between two wall studs at the top bracket installation location. **The horizontal support must be flush with the room side of the studs.** Use cleats behind both sides of the support to secure to wall studs.
- Reinstall drywall.

Installation Instructions

WALL-MOUNTED INSTALLATION—RECIRCULATING

2 INSTALL MOUNTING BRACKET

This vent hood must be secured to the horizontal support or wall studs.

- With the template taped in place, use a punch to mark all mounting screw locations.
- Drill 1/8" pilot holes at the 6 punched locations.
- Remove the template.
- The 2 holes in the support bracket holes must enter studs or the horizontal support.

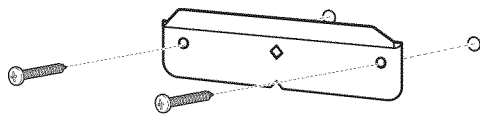

- Use wood screws to secure the mounting bracket to the wall. The screws must engage wall studs or the installed horizontal mounting support.
- Check to be sure that the bracket is level. There is no way to level the hood after hanging it from this bracket.

3 PREPARE THE HOOD

- Remove the hood from the box. Remove packaging and tape.

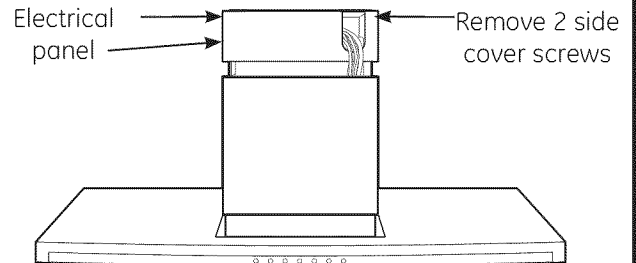

- Remove one screw on each side of the cover on the electrical panel. Lift off the cover and set aside with screws.

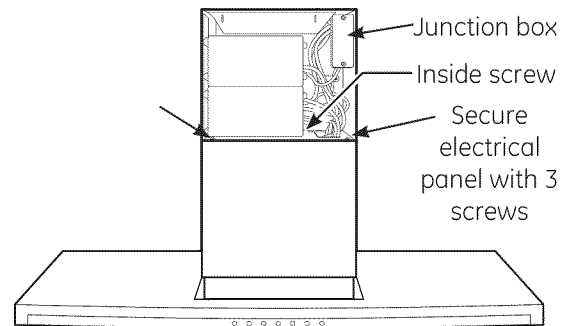

- Stand the electrical panel upright.
- Align the screw holes in the bottom of the panel with the holes on the base of the hood at the front side.
- Install 3 screws provided.

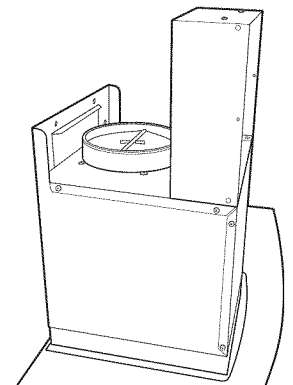

Installation Instructions

WALL-MOUNTED INSTALLATION—RECIRCULATING

4 MOUNT THE HOOD

Install a wood screw on each side of the mounting frame

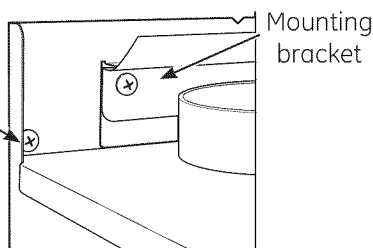

- Lift the hood onto the mounting bracket.
- Check to be sure it is level.
- Install wood screws through the hood and into the wall on each side of the mounting bracket.

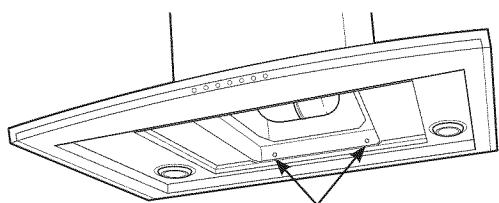

- Extend the canopy forward for better access to the rear mounting screw holes.
- Install 2 wood screws or fasteners through the bottom of the hood into the wall.

5 SIZE AND CUT DUCT PIECE

- Hold upper air deflector with duct connector against the ceiling.
- Measure from the bottom of the air deflector to the top of the hood as shown. Reduce that dimension by 1" to facilitate installation. The duct will cover and overlap the deflector and the hood outlets.

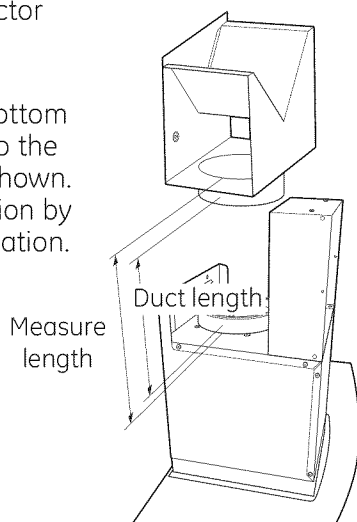

5 SIZE AND CUT DUCT PIECE (cont.)

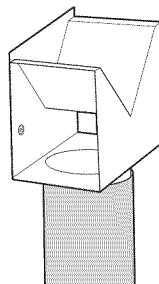

- Cut the duct piece to size and slip onto the bottom of the duct connector.
- Use duct tape to seal and secure the duct piece to the connector.

- Place the assembly over the hood outlet.
- Hold the assembly against the ceiling. The penciled centerline should show through the slot in the deflector. Mark the screw holes on the sides of the assembly.
- Remove the assembly and drill 1/8" pilot holes into the wall studs.
- Enlarge holes that did not enter studs to 3/8" and tap plastic or metal anchors into the holes, flush with the wall.
- Mount the assembly onto the hood outlet, push up against the ceiling and install the screws provided.

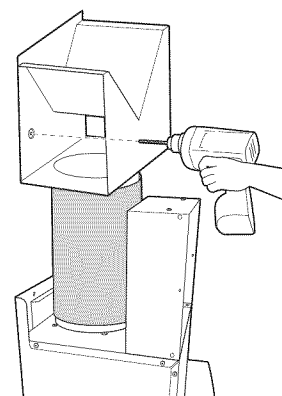

CAUTION: Do not use sheet metal screws at the hood flange connection. Doing so will prevent proper damper operations. Seal connection with tape only.

ATTENTION : N'utilisez pas de vis autotaraudeuses pour connecter le rabat de la hotte. En utilisant des vis, vous empêchez le bon fonctionnement du volet de fermeture. Scellez la connection uniquement avec du ruban adhésif.

Installation Instructions

WALL-MOUNTED INSTALLATION—RECIRCULATING

6 CONNECT ELECTRICAL

Verify that power is turned off at the source.

⚠WARNING: If house wiring is not 2-wire with a ground wire, a ground must be provided by the installer. When house wiring is aluminum, be sure to use U.L. approved anti-oxidant compound and aluminum-to-copper connectors.

⚠ADVERTISSEMENT

Si la maison n'est pas câblée avec deux fils et un fil de terre, l'installateur doit installer un fil de terre. Quand les fils sont en aluminium, il faut prendre soin d'utiliser des connecteurs aluminium à cuivre avec une pâte antioxydante approuvée par U.L.

- Remove junction box cover and knockout.
- Use a conduit connector to secure the conduit to the junction box.
- Connect white leads to branch circuit white lead.
- Connect black leads to branch circuit black lead.
- Connect green/yellow leads to branch circuit green lead or bare ground lead.
- Secure all connections with wire nuts on each electrical connector.
- Push wires into junction box and replace cover. Be sure wires are not pinched.
- Secure electrical panel cover with original screws.

7 INSTALL DUCT COVERS

- Place the decorative duct covers on top of the hood.

NOTE: The inside piece has holes on one end intended for use when the hood is installed for recirculating purposes. Be sure the vented end is at the top, the vent holes will be visible in this installation.

The inside duct piece must slip into the folded ends on the outer section.

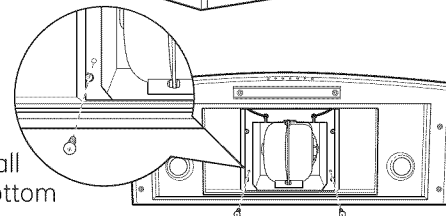
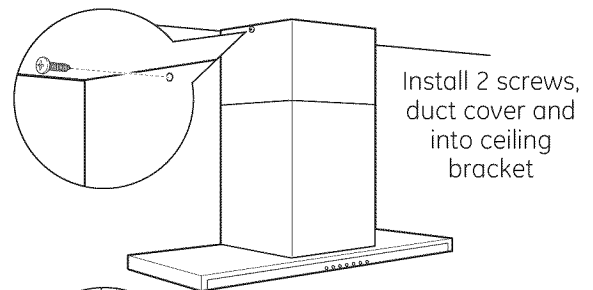
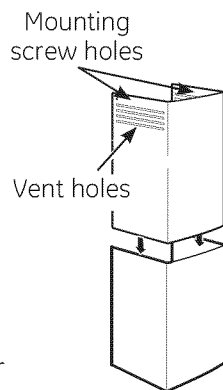

- Extend the inner duct piece upwards to the ceiling mounted air deflector.
- Secure the duct cover to the air deflector, driving one screw on each side.
- Locate the screw holes on the bottom outside edge of the hood.
- Secure the lower duct cover to the hood by installing 2 screws from the bottom of the hood into the duct cover.

Installation Instructions

WALL-MOUNTED INSTALLATION—RECIRCULATING

8 INSTALL FILTERS

Charcoal filter

- Remove protective film on the filters.

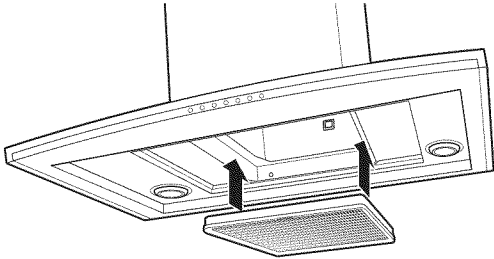

- Install the black charcoal filter into the center opening.

Metal grease filters

- Tip filters into the slots at the rear of the opening. Lift the filter lock and pull forward until the filter rests in the slots.

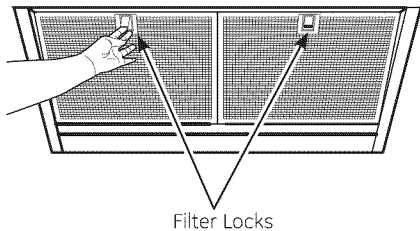

Filter Locks

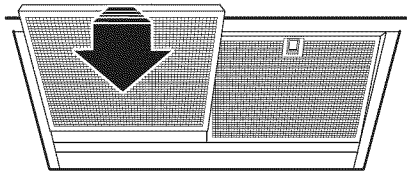

- Install both metal grease filters.
- To remove the filters, press inwards on the handle and pull the filter downwards.

9 FINALIZE INSTALLATION

- Remove all packaging materials.
- Refer to the Owner's Manual for operating instructions.

Installation Instructions

UNDER-CABINET INSTALLATION

CABINET REQUIREMENTS

This hood may be installed beneath a wall-mounted cabinet.

- If the cabinet has been installed, it must be removed so that wall framing supports can be added.

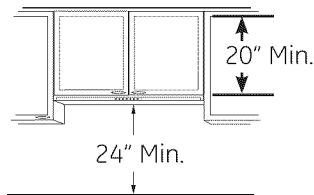

The cabinet must be at least 20" high between the bottom frame and the inside top. If the cabinet is not 20" from bottom to inside top, a custom cabinet or modifications to a different size cabinet and/or soffit may be required to accommodate the hood housing.

- The cabinet must be 36" wide and at least 12" deep.
- The cabinet must be firmly secured to wall studs or the added framing support and capable of supporting 100 pounds.

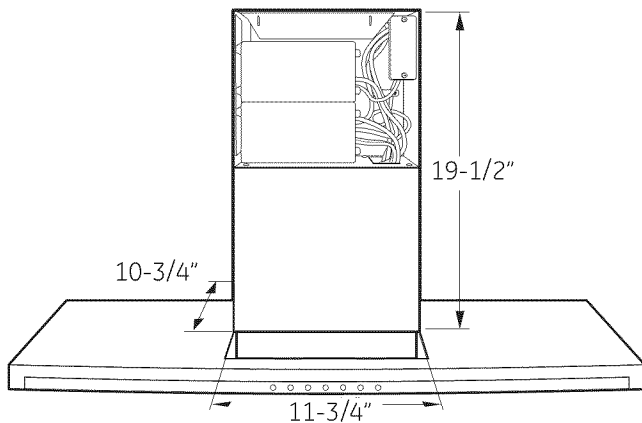

DUCTWORK, WIRING

- Determine the exact location of the vent hood.
- Locate the Rear Wall Template packed with the literature.
- Measure 36" from the floor to the top of the cooking surface. Add the pre-determined hood installation height. Mark that location.
- Use a level to draw a straight pencil line on the wall.

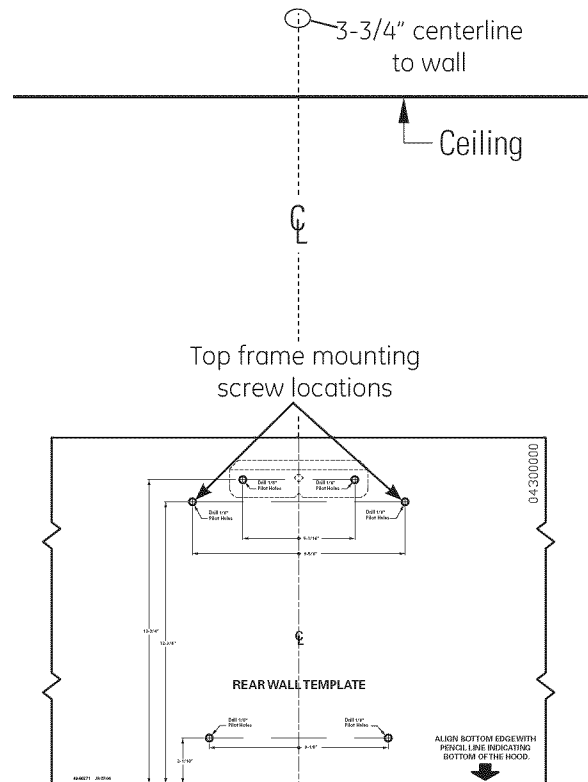

- Tape the template in position along the penciled line. Check to be sure the template is level.
- Use the level to draw a line straight up, from the centerline on the template to the ceiling.
- Measure 3-3/4" from the back wall to the centerline of a 6-1/2" hole on the ceiling.

NOTE: If drywall is not present, add drywall thickness to the 3-3/4" dimension.

HOUSE WIRING LOCATION:

- The junction box is located on the top right side of the hood.
- Wiring should enter the back wall 20" to 26" above the bottom of the hood, and within 4" of the right side of the centerline. Wiring should enter at least 4" above the right side of the frame.

Installation Instructions

UNDER-CABINET INSTALLATION

1 INSTALL FRAMING FOR HOOD SUPPORT

IMPORTANT: Framing must be capable of supporting 100 lbs.

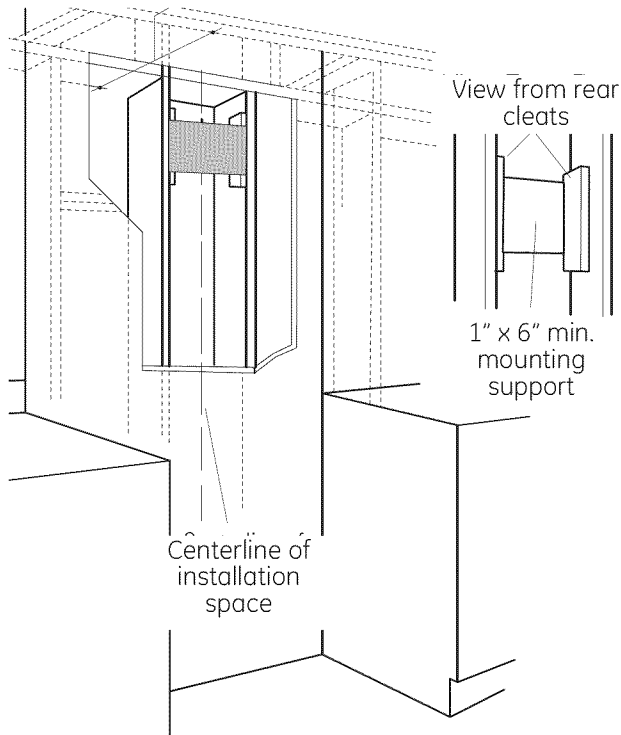

If drywall is present, mark the screw hole locations for the top mounting brackets. Remove the template.

- Cut away enough drywall to expose 2 vertical studs at the bracket location indicated on the template.
- Install a horizontal support at least 1" x 6" between two wall studs at the top bracket installation location. **The horizontal support must be flush with the room side of the studs.** Use cleats behind both sides of the support to secure to wall studs.
- Reinstall drywall.

2 PREPARE THE HOOD

- Remove the hood from the box. Remove packaging and tape.

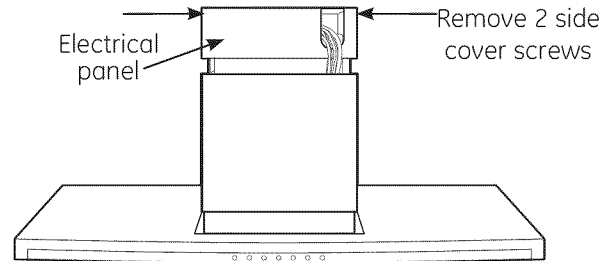

- Remove one screw on each side of the cover on the electrical panel. Lift off the cover and set aside with screws.

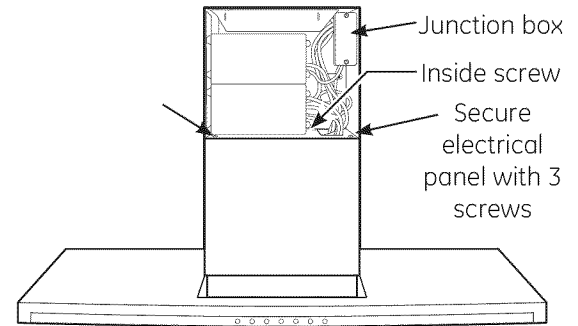

- Stand the electrical panel upright.
- Align the screw holes in the bottom of the panel with the holes on the base of the hood at the front side.
- Install 3 screws provided.

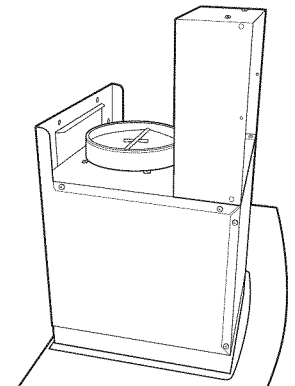

Installation Instructions

UNDER-CABINET INSTALLATION

3 CUT THE OPENING

If the cabinet has been installed, remove it from the wall.

- Use the Top Cabinet Template to locate and cut a hole in the bottom of the cabinet.
- If necessary, place the template on top of the cabinet to accurately cut a matching hole.
- Install the cabinet onto the wall.

The cabinet must be firmly secured to the wall and be capable of supporting 100 lbs.

INSTALL WOOD BLOCKS IF NECESSARY

- Install filler blocks whenever the cabinet frame hangs below the cabinet bottom.
- Install filler blocks whenever the cabinet bottom is less than 3/4" thick.
- Install the filler blocks on each side of the cutout. The filler blocks will accept the hood mounting screws.

NOTE: Additional filler blocks may be required along the outside edges to accept the outside screws. See Step 5.

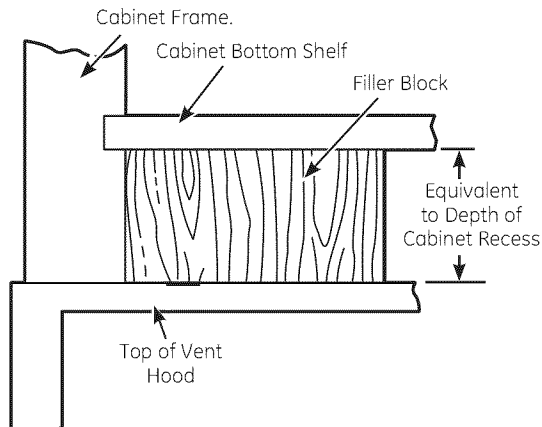

IMPORTANT: If filler blocks are not used, the hood may not be secured to the cabinet.

4 INSTALL SIDE "L" BRACKETS

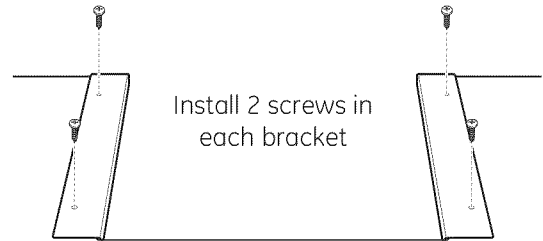

- Install the "L" brackets onto each side of the cutout. The wide flat portion should be on top of the opening. Install 2 screws into the top of each bracket.

5 REMOVE SIDE SCREW

The top center screw on both sides of the hood can be used to close up any noticeable gaps at the outside edges. See illustration.

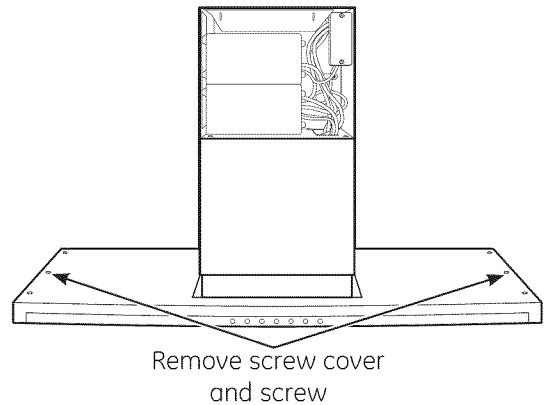

- Remove the center screw cover and screw on each side as shown.

Installation Instructions

UNDER-CABINET INSTALLATION

6 MOUNT THE HOOD

Install a wood screw on each side of the mounting frame

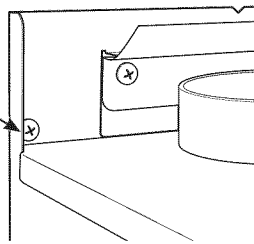

- Carefully, lift the hood into the cabinet. Guide the hood upwards to meet the ductwork.

IMPORTANT: One person must hold the hood in place while the other drives the screws into the mounting frame.

7 COMPLETE THE INSTALLATION AND CONNECT DUCTWORK

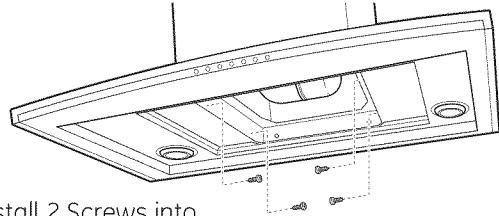

Install 2 Screws into Each Side Bracket

- Drive 2 screws into each side bracket. Be sure the screws engage the filler blocks or the cabinet bottom.
- Pull the glass canopy forward to access and install 2 screws through the hood and into the brackets on both sides.
- Use duct tape to secure the duct to the exhaust outlet in the top of the hood. Do not use screws at this location.

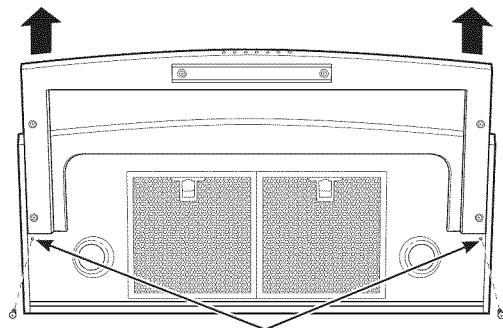

Install original top screws

If there is a noticeable gap between the hood and the bottom of the cabinet on the sides:

- Slide canopy forward and install original top screws through the bottom of the hood and into cabinet bottom or frame.

NOTE: Install wood filler blocks if necessary to accept the screws.

Installation Instructions

UNDER-CABINET INSTALLATION

8 CONNECT ELECTRICAL

WARNING: If house wiring is not 2-wire with a ground wire, a ground must be provided by the installer. When house wiring is aluminum, be sure to use U.L. approved anti-oxidant compound and aluminum-to-copper connectors.

ADVERTISSEMENT :

Si la maison n'est pas câblée avec deux fils et un fil de terre, l'installateur doit installer un fil de terre. Quand les fils sont en aluminium, il faut prendre soin d'utiliser des connecteurs aluminium à cuivre avec une pâte antioxydante approuvée par U.L.

- Remove junction box cover and knockout.
- Use a conduit connector to secure the conduit to the junction box.
- Connect white leads to branch circuit white lead.
- Connect black leads to branch circuit black lead.
- Connect green/yellow leads to branch circuit green lead or bare ground lead.
- Secure all connections with wire nuts on each electrical connector.
- Push wires into junction box and replace cover. Be sure wires are not pinched.
- Secure electrical panel cover with screws provided.

10 INSTALL FILTERS

- Remove protective film on the filters.

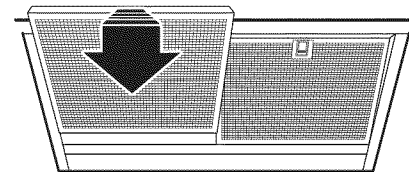
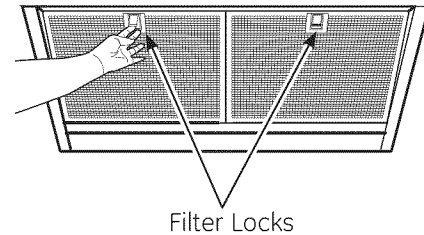

NOTE: It is not necessary to install the charcoal filter in a vented installation.

- Tip the filter into the slots at the rear of the opening. Lift the filter lock and pull forward until the filter rests in the slots.
- Install both metal grease filters.
- To remove the filters, press inwards on the handle and pull the filter downwards.

9 INSTALL REAR MOUNTING SCREWS

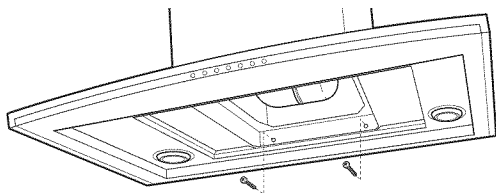

Install 2 Wood Screws

- Pull the glass canopy forward to access and install 2 wood screws or fasteners through the bottom of the hood and into the wall.

NOTE: While performing installations described in this book, safety glasses or goggles should be worn.

For Monogram® local service in your area, call 1.800.444.1845.

NOTE: Product improvement is a continuing endeavor at General Electric. Therefore, materials, appearance and specifications are subject to change without notice.