

**Electrolux**

## Table of contents

Finding information.....	2
Important Safety Instructions .....	3-5
Getting Started.....	6
• Grounding Instructions .....	6
• Liquefied Petroleum (Propane) Gas Conversion...	6
Surface Cooking .....	7-12
• Surface Cooking Utensils .....	7
• Using the Griddle.....	7
• Using the Wok Stand (accessory not included).....	8
• Using the Simmer Plate (accessory not included).....	9
• Locations of the Burners.....	9
• Placement of Burner Grates .....	9
• Placement of Burner Caps .....	10
• Flame Size.....	11
• Proper Burner Adjustments .....	11
• Setting Surface Controls.....	12
General Care and cleaning .....	13-14
• Care and Cleaning Table .....	13
• Care and Cleaning of Stainless Steel.....	13
• Cleaning burner Grates, Caps, heads and glass cooktop.....	13-15
Solutions to common problems.....	16
• Surface Burners Do Not Light.....	16
• Burner Flame Only Lights Half Way Around Burner .....	16
• Burner Flame is Orange .....	16
• Scratches or Abrasion on Ceramic Glass Cooktop Surface.....	16
• Metal Mark on Ceramic Glass .....	16
• Brown Streaks and Specks on Ceramic Glass....	16
• Areas of Discoloration on Ceramic Glass.....	16
Warranty information .....	17

### NOTE

Registering your product with Electrolux enhances our ability to serve you. You can register online at [www.electroluxappliances.com](http://www.electroluxappliances.com) or by dropping your Product Registration Card in the mail.

## Questions?

For toll-free telephone support in the U.S. and Canada:

**1-877-4ELECTROLUX (1-877-435-3287)**

For online support and Internet production information visit <http://www.electroluxappliances.com>

## Please read & save this guide

Thank you for choosing **Electrolux**, the new premium brand in home appliances. This *Use & Care Guide* is part of our commitment to customer satisfaction and product quality throughout the service life of your new appliance.

We view your purchase as the beginning of a relationship. To ensure our ability to continue serving you, please use this page to record important product information.

## Keep a record for quick reference

---

Purchase date

---

Electrolux model number

---

Electrolux serial number

## What you need to know about safety instructions

Warning and Important Instructions appearing in this guide are not meant to cover all possible conditions and situations that may occur. Common sense, caution and care must be exercised when installing, maintaining or operating a microwave.

**ALWAYS** contact your dealer, distributor, service agent or manufacturer about problems or conditions you do not understand.

## Recognize Safety Symbols, Words, Labels

### **WARNING**

**WARNING** — Hazards or unsafe practices which **COULD** result in severe personal injury or death.

### **CAUTION**

**CAUTION** — Hazards or unsafe practices which **COULD** result in minor personal injury.

### **WARNING**

If the information in this manual is not followed exactly, a fire or explosion may result causing property damage, personal injury or death.

#### **FOR YOUR SAFETY:**

- Do not store or use gasoline or other flammable vapors and liquids in the vicinity of this or any other appliance.
  - **WHAT TO DO IF YOU SMELL GAS:**
    - Do not try to light any appliance.
    - Do not touch any electrical switch; do not use any phone in your building.
    - Immediately call your gas supplier from a neighbor's phone. Follow the gas supplier's instructions.
    - If you cannot reach your gas supplier, call the fire department.
  - Installation and service must be performed by a qualified installer, servicer or the gas supplier.
- 
- **Remove all tape and packaging wrap before using the appliance. Destroy the carton and plastic bags after unpacking the appliance.** Never allow children to play with packaging material. Do not remove the model/serial plate attached to the cooktop.
  - **Proper Installation-Be sure your appliance is properly installed and grounded by a qualified technician in accordance with the National Fuel Gas Code ANSI Z223.1—latest edition in the United States, or in Canada CAN/CGA B149.1, and CAN/CGA B149.2, and the National Electrical Code ANSI/NFPA No. 70—latest edition in United States, or in Canada CSA Standard C22.1, Canadian Electrical Code, Part 1, and local code requirements.** Install and/or adjust only per installation instructions provided in the literature package for this cooktop.
- Ask your dealer to recommend a qualified technician and an authorized repair service. Know how to shut off gas supply at the meter and disconnect the electrical power to the cooktop at the circuit breaker or fuse box in case of an emergency.
- **User servicing—Do not repair or replace any part of the appliance unless specifically recommended in the manuals.** All other servicing should be done only by a qualified technician, This may reduce the risk of personal injury and damage to the cooktop.
  - **Never modify or alter the construction of a cooktop by removing panels, wire covers or any other part of the product.**
  - **Air curtain or other overhead hoods, which operate by blowing a downward air flow on to a range, shall not be used in conjunction with gas ranges other than when the hood**

# 4 Important Safety Instructions

and range have been designed, tested and listed by an independent test laboratory for use in combination with each other.

## WARNING

- **Stepping, leaning or sitting on this cooktop can result in serious injuries and also cause damage to the cooktop. Do not allow children to climb or play around the cooktop.**
- **NEVER use this appliance as a space heater to heat or warm the room.** Doing so may result in carbon monoxide poisoning and overheating of the oven.
- **Storage on Appliance—Flammable materials should not be stored on the cooktop or near surface units.** This includes paper, plastic and cloth items, such as cookbooks, plasticware and towels, as well as flammable liquids. Do not store explosives, such as aerosol cans, on or near the cooktop. Flammable materials may explode and result in fire or property damage.
- **Do Not Leave Children Alone—Children should not be left alone or unattended in the area where appliance is in use.** They should never be allowed to sit or stand on any part of the appliance.

## CAUTION

**Do not store items of interest to children in the cabinets above the cooktop.** Children climbing on the cooktop to reach items could be seriously injured.

- **DO NOT TOUCH SURFACE BURNERS/UNIT, GRATES OR AREAS NEAR THESE BURNERS/UNIT.** Surface burners/unit may be hot even though flames are not visible/ unit is dark in color. Areas near surface burners/unit may become hot enough to cause burns. During and after use, do not touch, or let clothing or other flammable materials touch these areas until they have had sufficient time to cool. Among these areas are the cooktop and surfaces facing the cooktop.
- **Wear Proper Apparel—Loose-fitting or hanging garments should never be worn while using the appliance.** Do not let clothing or other flammable materials contact hot surfaces.

- **Do Not Use Water or Flour on Grease Fires—Smother the fire with a pan lid, or use baking soda, a dry chemical or foam-type extinguisher.**
- **When heating fat or grease, watch it closely.** Fat or grease may catch fire if allowed to become too hot.
- **Use Only Dry Potholders—Moist or damp potholders on hot surfaces may result in burns from steam.** Do not let potholders touch hot heating elements, the flame or burners. Do not use a towel or other bulky cloth instead of a potholder.
- **Do Not Heat Unopened Food Containers—Buildup of pressure may cause container to burst and result in injury.**

## WARNING

- **Use Proper Flame Size—Adjust flame size so it does not extend beyond the edge of the utensil.** The use of undersized utensils will expose a portion of the burner flame to direct contact and may result in ignition of clothing. Proper relationship of utensil to flame will also improve efficiency.
- **Do Not Use Stove Top Grills on Your Sealed Gas Burners—** If you use a stove top grill on a sealed gas burner, it will cause incomplete combustion and can result in exposure to carbon monoxide levels above allowable current standards. This can be hazardous to your health.
- **Use proper pan size.** This cooktop can be equipped with one or more surface units of different sizes. Select utensils having flat bottoms large enough to cover the surface unit. The use of undersized utensils will expose a portion of the surface heating unit to direct contact and may result in ignition of clothing. Proper relationship of utensil to the surface unit will also improve efficiency.
- **Know which knob controls each surface burner.** Place a pan of food on the burner before turning it on, and turn the burner off before removing the pan.
- **Always turn the knob to the LITE position when igniting the burners.** Visually check that the burner has lit. Then adjust the flame so it does not extend beyond the edge of the utensil.
- **Clean the appliance regularly to keep all parts free of grease that could catch fire.** Exhaust fan ventilation hoods and grease filters should be kept clean. Do not allow grease to accumulate on hood or filter. Greasy deposits in the fan could catch fire. When flaming food

under the hood, turn fan on. Refer to hood manufacturer's instructions for cleaning.

- **Utensil Handles Should Be Turned Inward and Not Extend Over Adjacent Surface Burners/Unit** —To reduce the risk of burns, ignition of flammable materials, and spillage due to unintentional contact with the utensil, the handle of the utensil should be positioned so that it is turned inward, and does not extend over adjacent surface burners.
- **Never Leave Surface Burners/Unit Unattended at High Heat Settings**—Boilovers cause smoking and greasy spillovers that may ignite, or a pan that has boiled dry may melt.
- **Protective Liners**—Do not use aluminum foil to line any part of the cooktop, use aluminum foil only to cover food during cooking. Improper installation of these liners may result in risk of electric shock, or fire.
- **Glazed Cooking Utensils**—Only certain types of glass, glass/ceramic, ceramic, earthenware, or other glazed utensils are suitable for cooktop service without breaking due to the sudden change in temperature. Check the manufacturer's recommendations for cooktop use.  
Do not use Searing Grill on the cooktop. The Searing Grill is not designed for use on the cooktop. Doing so may result in a fire.
- **Do Not Use Decorative Surface Burner Covers.** If a burner/unit is accidentally turned on, the decorative cover will become hot and possibly melt. You will not be able to see that the

burner is on. Burns will occur if the hot covers are touched. Damage may also be done to the cooktop or burners because the covers may cause overheating. Air will be blocked from the burner/unit and cause combustion problems.

## IMPORTANT INSTRUCTIONS FOR USING YOUR GLASS COOKTOP

- **Do Not Operate or Clean a Broken Cooktop Glass**— If glass top should break, cleaning solutions and spillovers may penetrate the broken cooktop and create a risk of electric shock. Contact a qualified technician immediately.
- **Clean Cooktop Glass with Caution**— If a wet sponge or cloth is used to wipe spills on a hot cooking area, be careful to avoid a steam burn. Some cleaners can produce harmful fumes if applied to a hot surface.
- **Avoid scratching the Cooktop Glass with Sharp Objects.**

## Important safety notice

The California Safe Drinking Water and Toxic Enforcement Act requires the Governor of California to publish a list of substances known to the state to cause cancer, birth defects or other reproductive harm, and requires businesses to warn customers of potential exposure to such substances.

### NOTE

Save these important safety instructions for future reference.

## Grounding Instructions

For personal safety, the cooktop must be properly grounded. For maximum safety, the power cord must be plugged into an electrical outlet that is correctly polarized and properly grounded.

**DO NOT** operate the cooktop using a 2-prong adapter or an extension cord. If a 2-prong wall receptacle is the only available outlet, it is the personal responsibility of the consumer to have it replaced with a properly grounded 3-prong wall receptacle installed by a qualified electrician.

See the **INSTALLATION INSTRUCTIONS** packaged with this cooktop for complete installation and grounding instructions.

Grounding  
type wall  
receptacle

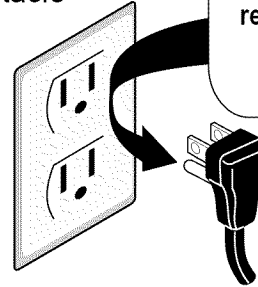

Do not, under any circumstances, cut, remove, or bypass the grounding prong.

Power supply  
cord with 3-prong  
grounding plug

### **WARNING**

This appliance is equipped with a 3-prong grounding plug for your protection against shock hazard and should be plugged directly into a properly grounded receptacle. **DO NOT** cut or remove the grounding prong from this plug.

Avoid fire hazard or electrical shock. **DO NOT** use an adapter plug, an extension cord, or remove grounding prong from electrical power cord. Failure to follow this warning can cause serious injury, fire or death.

## Liquefied Petroleum (Propane) Gas Conversion

This appliance can be used with Natural Gas and Propane Gas. It is shipped from the factory for use with natural gas.

A kit for converting to LP gas is supplied with your cooktop. The kit is marked "FOR LP/PROPANE GAS CONVERSION". Follow the installation instructions which are inside the envelope.

The conversion must be performed by a qualified service technician in accordance with the kit instructions and all local codes and requirements. Failure to follow instructions could result in serious injury or property damage. The qualified agency performing this work assumes responsibility for the conversion.

### **WARNING**

Severe shock, or damage to the cooktop may occur if the cooktop is not installed by a qualified installer or electrician.

### **CAUTION**

Any additions, changes or conversions required in order for this appliance to satisfactorily meet the application needs must be made by a qualified service technician in accordance with the manufacturer's instructions and all codes and requirements of the authority having jurisdiction. Failure to follow the instructions could result in serious injury or property damage. The qualified agency performing this work assumes responsibility for the conversion.

## Surface cooking utensils

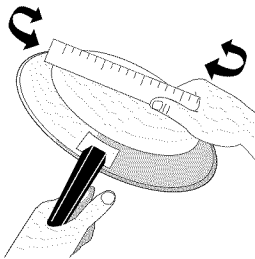

Pans should have flat bottoms. Check for flatness by rotating a ruler across the bottom. There should be no gaps between the pan and ruler.

\* Specialty pans such as lobster pots, griddles and pressure cookers may be used but must conform to the above recommended cookware requirements.

### \*GOOD

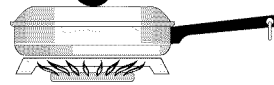

- Flat bottom and straight sides.
- Tight fitting lids.
- Weight of handle does not tilt pan. Pan is well balanced.
- Pan sizes match the amount of food to be prepared and the size of burner.
- Made of material that conducts heat well.
- Easy to clean.

### POOR

- Curved and warped pan bottoms.

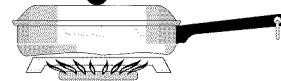

- Pan overhangs unit by more than 2.5 cm (1").

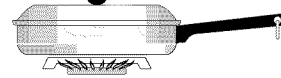

- Heavy handle tilts pan.

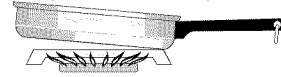

- Flame extends beyond unit.

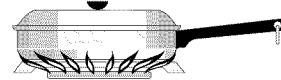

**Note:** Always use a utensil for its intended purpose. Follow manufacturer's instructions. Some utensils were not made to be used in the oven or on the cooktop.

## Using the griddle

The griddle is intended for direct food cooking and can be used on both sides (Figures 2 or 3). **Do not** use pans or other cookware on the griddle. Doing so could damage the finish. With the grate in position over the burner, set the griddle on top of the grate positioning the notches in the griddle over the grate fingers (refer to figures 1 and 2 for optimal positioning).

### CAUTION

Always place the griddle on the grate before to turn on the burner.

Always use potholders to remove the griddle from the grate. Allow the griddle to cool before removing. Do not set hot griddle on surfaces that cannot withstand high heat; such as countertops.

Be sure the griddle is positioned correctly and stable before use to prevent hot spills and possible burns

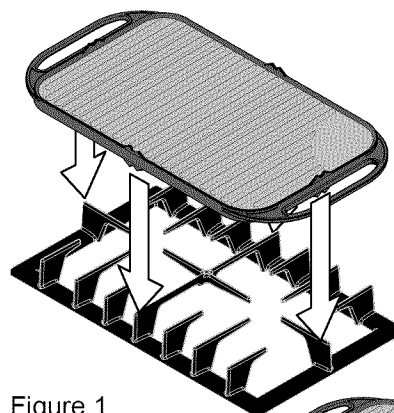

Figure 1

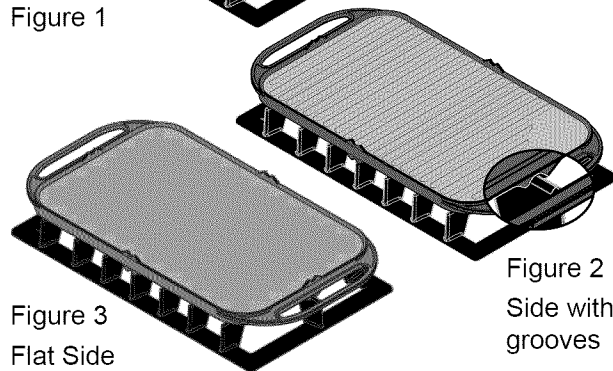

Figure 2  
Side with grooves

Figure 3  
Flat Side

## Using the wok stand (accessory not included)

The Wok Stand is designed to allow round-bottomed woks to be used. **It is recommended that you use a 14 inch diameter (35.5 cm) or less Wok.** It is recommended that you use the **POWER** burner with the wok stand for best performance. If properly positioned, the Wok Stand will not slide off the grate.

### CAUTION

Always use potholders to remove the wok stand from the grate. Allow the wok stand to cool before removing. Do not set hot wok stand on surfaces that cannot withstand high heat; such as countertops.

Be sure the Wok Stand is positioned correctly and stable before use to prevent hot spills and possible burns.

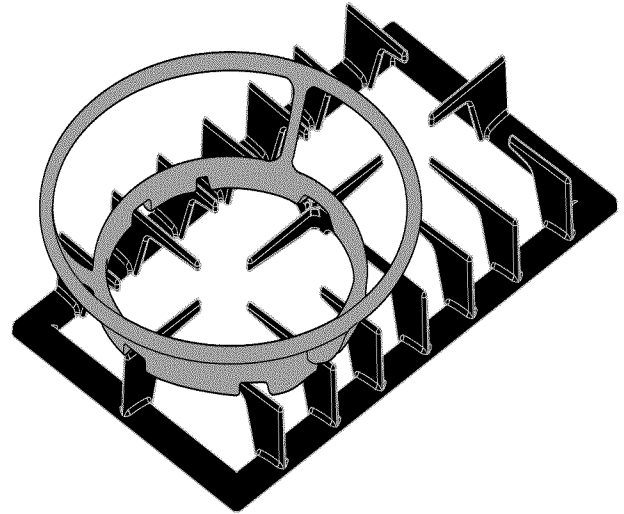

Figure 1

### To Properly Position the Wok Stand:

With the grate in position over the burner, set the Wok Stand on top of the grate positioning the notches in the Wok Stand over the cooktop grate fingers (See Figure 1).

### NOTE

The Wok cooking performance is best on the POWER burner.

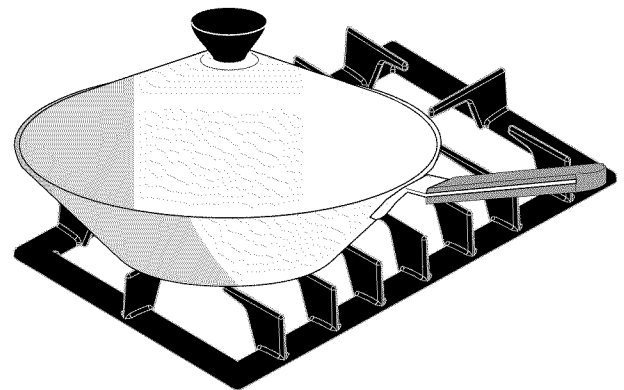

Proper use of flat-bottom wok on Surface Burner Grate

Figure 2

### CAUTION

Be sure to **ALWAYS** use the Wok Stand if the stability of the wok is uncertain. If cooking large amounts of liquid food without the Wok Stand, the wok may tip and spill over causing burns.

**Flat-bottom woks** with large flat bottoms may also be used on your cooktop Surface Burner Grates without the Wok Stand (See Figure 2). Insure the stability of the flat-bottom wok before cooking without the Wok Stand. If unstable, **DO NOT** use the flat-bottom wok without the Wok Stand.

**Round-bottom woks (with a support ring)** should **NOT** be used (See Figure 3). The supporting ring was not designed for proper or stable use on the Surface Burner Grates.

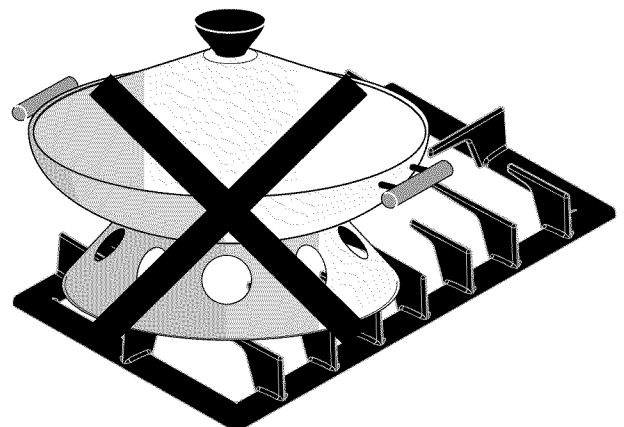

Improper use of round-bottom wok on Surface Burner Grate

Figure 3



## Using the simmer plate (accessory not included)

The simmer plate (Figure 1) is intended to diffuse lower temperature of the burner to help cooking delicate aliment such as chocolate, milk, bechamel, etc. It can also be use for cooking sauce during long period. With the grate in position over the burner, set the simmer plate on top of the grate positioning the notches in the simmer plate over the grate fingers (See Figure 2) and then place the utensil on the simmer plate.

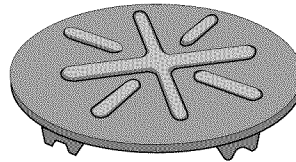

Figure 1

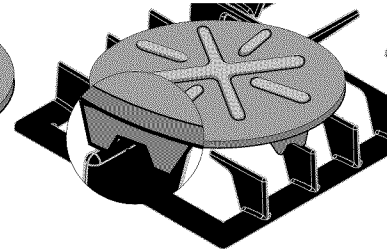

Figure 2

### **CAUTION**

Always place the simmer plate on the grate before to turn on the burner.

Always use potholders to remove the simmer plate from the grate. Allow the simmer plate to cool before removing.

Do not set hot simmer plate on surfaces that cannot withstand high heat; such as countertops.

Be sure the simmer plate is positioned correctly and stable before use to prevent hot spills and possible burns.

## Location of the Burners

The cooktop is equipped with different sized burners. The surface burners are located on the cooktop as follows:

- a **5 000 BTU** (natural gas) burner located at the center rear position;
- a **9 500 BTU** (natural gas) burner located at the right rear position;
- two **14 000 BTU** (natural gas) burners located at the left rear and center front position;
- and two **20 000 BTU** (natural gas) burners located at the left front and right front position.

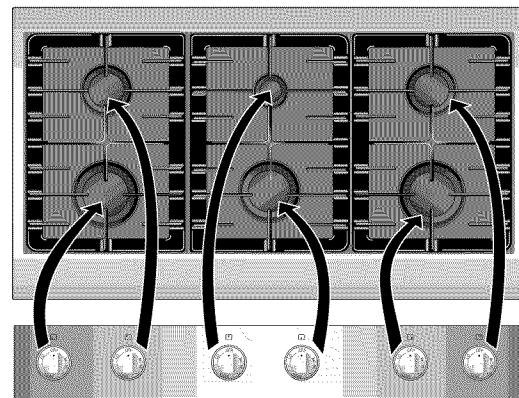

## Placement of burner grates

Place grates on the Ceramic Glass Cooktop. Be sure they are right located inside the stainless steel frame.

**ATTENTION:** Do not slide the grates on the stainless steel frame, doing so can damage the surface.

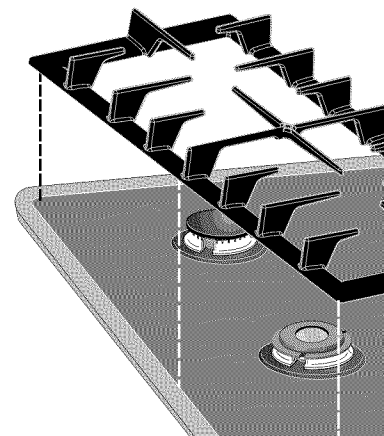

# 10 Surface Cooking

## Placement of burner caps

Place a burner cap on each burner head, matching the cap size to the head size. The cap for each burner has an inner locating ring which centers the cap correctly on the burner head. Be sure that all the burner caps and burner heads are correctly placed **BEFORE** using your appliance.

Make sure each burner cap is properly aligned and level.

Turn the burner on to determine if it will light. If the burner does not light, contact a Service Center. Do not service the sealed burner yourself.

**ATTENTION:** Do not slide the burner caps on the cooktop, doing so can damage the surface.

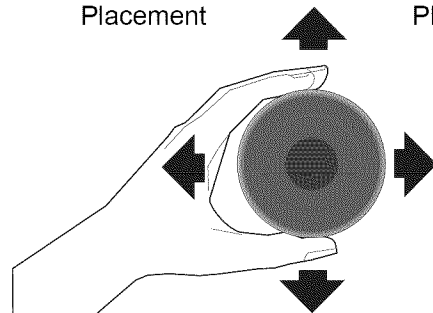
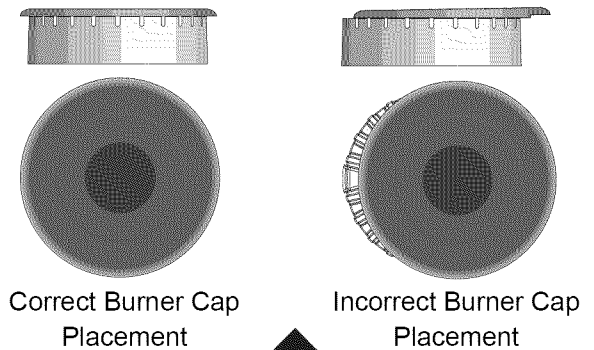
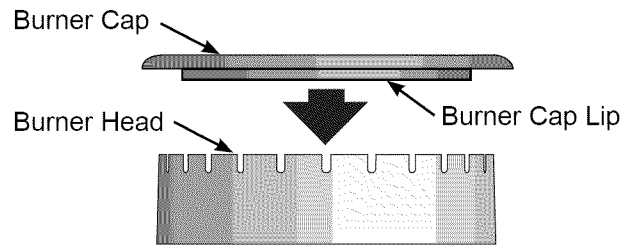

### ➔ IMPORTANT

**For Proper Ignition: Burner Ring Alignment Tab Must Align with Burner Base Alignment Tab Slot**

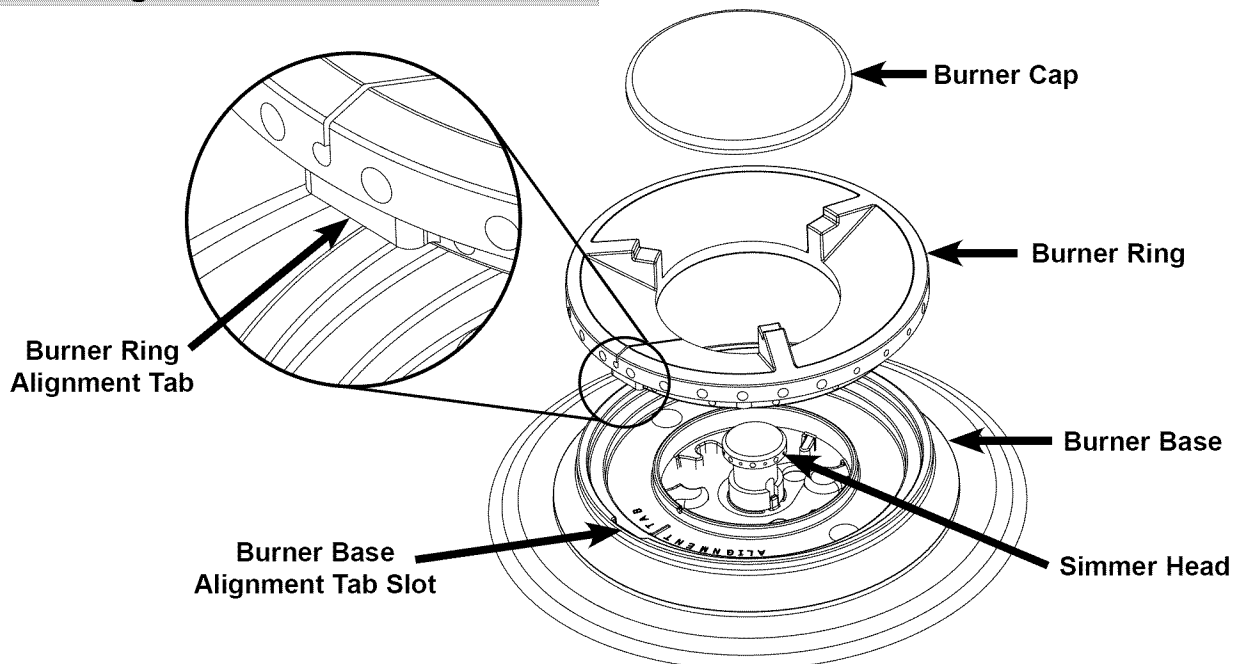

## Flame Size

**For most cooking**, start on the highest control setting and then turn to a lower one to complete the process. Use the chart below as a guide for determining proper flame size for various types of cooking. The size and type of utensil used and the amount of food being cooked will influence the setting needed for cooking.

**For deep fat frying**, use a thermometer and adjust the surface control knob accordingly. If the fat is too cool, the food will absorb the fat and be greasy. If the fat is too hot, the food will brown so quickly that the center will be undercooked. Do not attempt to deep fat fry too much food at once as the food will neither brown nor cook properly.

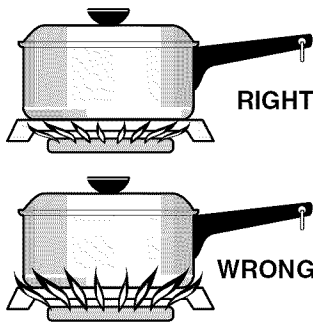

*Flame Size	Type of Cooking
High Flame	Start most foods; bring water to a boil; pan broiling
Medium Flame	Maintain a slow boil; thicken sauces, gravies; steam
Low Flame	Keep foods cooking; poach; stew

**\*These settings are based on using medium-weight aluminum pans with lids. Settings may vary when using other types of pans.**

Never extend the flame beyond the outer edge of the utensil. A higher flame simply wastes heat and energy, and increases your risk of being burned by the flame.

## Proper Burner Adjustments

The color of the flame is the key to proper burner adjustment. A good flame is clear, blue and hardly visible in a well-lighted room. Each cone of flame should be steady and sharply defined. Adjust or clean burner if flame is yellow-orange. To clean burner, see instructions under **General Care & Cleaning**.

# 12 Surface Cooking

## Setting surface controls

Your cooktop may be equipped with any combination of the following burners:

**Simmer Burner:** best used for simmering delicate sauces, etc.

**Standard Burner:** used for most all surface cooking needs.



**Large Burner:** best used when bringing large quantities of liquid to temperature and when preparing larger quantities of food.

Regardless of size, always select a utensil that is suitable for the amount and type of food being prepared. Select a burner and flame size appropriate to the pan. Never allow flames to extend beyond the outer edge of the pan.

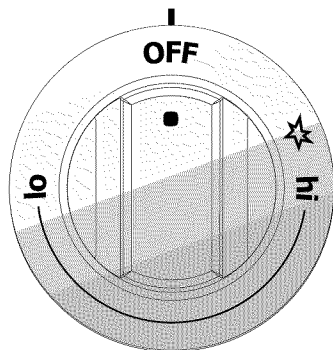
Your cooktop is equipped with 270° rotation flame control valves. These valves provide enhanced control of the burner flame. Each burner lights automatically from an electric ignitor when its control knob is turned to the  position.



## To operate the surface burner:

1. Place cooking utensil on burner.
  2. **Push in and turn** the Surface Control knob to .
- Note:** All electronic ignitors will click at the same time when the knob is pushed in. However, only the burner you are turning on will ignite.
3. Visually check that the burner has lit.
  4. **Turn** the control knob to the desired flame size. The control knobs do not have to be set at a particular mark. Use the guides and adjust the flame as needed. **DO NOT** cook with the Surface Control knob in the  position. (The electronic ignitor will continue to click if left in the  position, causing premature wear.)

## CAUTION

**Do not place plastic items such as salt and pepper shakers, spoon holders or plastic wrappings on top of the cooktop when it is in use.** These items could melt or ignite. Potholders, towels or wood spoons could catch fire if placed too close to a flame.

In the event of an electrical power outage, the surface burners can be lit manually. To light a surface burner, hold a lit match to the burner head, then slowly turn the Surface Control knob to . Use caution when lighting surface burners manually.

## Care and cleaning table

Cleaning Recommendations	
Surface Type	Cleaning Recommendation
<ul style="list-style-type: none"> <li>Painted and Plastic Control Knobs</li> </ul>	<p>For general cleaning, use hot, soapy water and a cloth. For more difficult soils and built-up grease, apply a liquid detergent directly onto the soil. Leave on soil for 30 to 60 minutes. Rinse with a damp cloth and dry. <b>DO NOT</b> use abrasive cleaners on any of these materials; they can scratch.</p>
<ul style="list-style-type: none"> <li>Glass surface</li> </ul>	<p>Before cleaning, turn all controls to OFF. Clean the glass as instructions in General Care &amp; Cleaning section under <b>Cooktop Cleaning Maintenance</b>.</p>
<ul style="list-style-type: none"> <li>Porcelain Enamel</li> <li>Burner Grates, Burner Caps</li> </ul>	<p>Clean burner grates in the dishwasher and dry upon removal. Gentle scouring with a soapy scouring pad will remove most spots. Rinse with a 1:1 solution of clean water and ammonia. <i>If necessary</i>, cover difficult spots with an ammonia-soaked paper towel for 30 to 40 minutes. Rinse with clean water and a damp cloth, then scrub with a soap-filled scouring pad. Rinse and wipe dry with a clean cloth. Remove all cleaners or the porcelain may become damaged during future heating. <b>DO NOT</b> use spray oven cleaners on the cooktop.</p>
<ul style="list-style-type: none"> <li>Surface Burners</li> </ul>	<p>The holes in the burners of your cooktop must be kept clean at all times for proper ignition and a complete, even flame. Clean the burner holes routinely with a small gauge wire or needle and especially after bad spillovers which could clog these holes.</p> <p>To remove, clean and replace sealed burner units; follow the instructions in General Care &amp; Cleaning section under <b>Cleaning Burners, Grates and Trivets</b>. For stubborn stains, scrub with soap and water or a mild abrasive cleanser and damp cloth. Dry the burners thoroughly in a warm oven for 30 minutes. Then replace them, making sure they are seated and level. <b>DO NOT</b> put burner units in the dishwasher.</p>
<ul style="list-style-type: none"> <li>Stainless Steel</li> </ul>	<p>Clean <b>stainless steel</b> with hot, soapy water and a dishcloth. Rinse with clean water and a cloth. <b>Do not use cleaners with high concentrations of chlorides or chlorines</b>. Do not use harsh scrubbing cleaners. Only use kitchen cleaners that are especially made for cleaning stainless steel. Always be sure to rinse the cleaners from the surface as bluish stains may occur during heating that cannot be removed.</p>

## Care and cleaning of stainless steel

Special care and cleaning are **required** for maintaining the appearance of stainless parts. Please refer to the table provided at the beginning of the **General Care & Cleaning** section in this Use & Care Manual.

## Cleaning burner grates, caps, heads and glass cooktop

The cooktop is designed to make cleaning easier. Because the gas burner are sealed, cleanups are easy when spillovers are cleaned up immediately.

### CAUTION

Do not remove any parts from the cooktop until they have completely cooled and are safe to handle.

### IMPORTANT

Do not use spray oven cleaners on the cooktop.

### Cleaning the burner grates

The burner grates are dishwasher safe and may be cleaned in the dishwasher. Remove any excessive soils before placing in the dishwasher.

### IMPORTANT

- For proper gas flow and ignition of the burners — **DO NOT allow spills, food, cleaning agents or any other material to enter the gas orifice opening.**
- The cooktop is not removable. Do not attempt to remove or lift the cooktop.

## Cleaning burner grates, caps, heads and glass cooktop

### CAUTION

- To avoid possible burns use care when cleaning the cooktop. **DO NOT** attempt to clean the cooktop whenever the cooktop or burner heads are still hot.
- To avoid possible burns **DO NOT** attempt any of the following cleaning instructions provided before turning OFF all of the surface burners and allow them to cool.
- To avoid possible burns **DO NOT** attempt to operate the surface burners without the burner caps.

Your appliance is shipped with the burner heads and burner caps in the correct locations. Before using your gas appliance be sure to:

- Follow installation instructions before operating.
- Remove all packing tape from cooktop area.

### Cleaning the burner Caps

Should you ever need to remove the burner caps for cleaning lift the burner cap off the burner head. Clean heavy soils with an absorbent cloth. Rinse with a clean, damp cloth and immediately thoroughly dry including the bottom and inside of the cap. Do not use harsh abrasive cleaners. They can scratch the porcelain on the cap. Do not clean burner caps in dishwasher. When placing the burner caps, see Important note below.

### IMPORTANT

When placing the burner caps on the cooktop, be sure the burner caps are seated firmly on top of burner heads. Improper flame size and uneven heating may result when any surface burners are turned ON and the burner caps are not seated correctly.

### Cleaning the burner heads

Lift the burner cap from the burner head. The surface burner heads are secured to the cooktop and **must be cleaned in place**.

For proper gas flow it may be necessary to clean the burner heads and slots. To clean, first use a clean DAMP cloth to soak up any spills. Remove any food from between the burner slots using a small nonabrasive brush like a toothbrush and afterwards wipe using a damp cloth. For stubborn soils located in the slots, use a small-gauge wire or needle to clean.

Should you experience ignition problems it may be that an ignition port hole is partially blocked with soil (see figure below). With the burner head in place, use a small wire gauge needle or the end of a paper clip to clear the ignition port or ports.

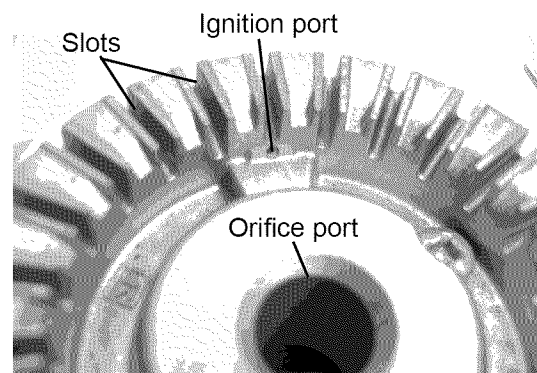

### Cleaning the cooktop glass

#### Consistent and proper cleaning is essential to maintaining your ceramic glass cooktop

Prior to using your cooktop for the first time, apply a ceramic cooktop cleaning cream (available in most hardware, grocery and department stores) to the ceramic surface. Clean and buff with a clean paper towel. This will make cleaning easier when soiled from cooking. Cooktop cleaning creams leave a protective finish on the glass to help prevent scratches and abrasions.

Sliding aluminum or copper clad bottom pans on the cooktop glass can cause metal markings on the cooktop surface. These marks should be removed **immediately** after the cooktop has cooled using the cooktop cleaning cream. Metal marks can become permanent if not removed prior to future use.

Cookware (cast iron, metal, ceramic or glass) with rough bottoms can mark or scratch the cooktop surface. **Do not slide anything metal or glass** across the cooktop. **Do not** use your cooktop as a cutting board or work surface in the kitchen. **Do not** cook foods directly on the cooktop surface without a pan. **Do not** drop heavy or hard objects on the glass cooktop, they may cause it to crack.

## Cleaning burner grates, caps, heads and glass cooktop

### Cleaning recommendations for the ceramic glass cooktop

#### CAUTION

Before cleaning the cooktop, be sure the controls are turned to OFF and the cooktop is COOL.

#### WARNING

DO NOT use a cooktop cleaner on a hot cooktop. The fumes can be hazardous to your health, and can chemically damage the ceramic-glass surface.

#### For light to moderate soil:

Apply a few drops of cooktop cleaning cream directly to the cooktop. Use a clean paper towel to clean the entire cooktop surface. Make sure the cooktop is cleaned thoroughly, leaving no residue. Do not use the towel you use to clean the cooktop for any other purpose.

#### For heavy, burned on soil:

First, clean the surface as described above. Then, if soils remain, protect your hand with a potholder and carefully scrape soils with a metal razor blade scraper, holding scraper at a 30 degree angle to the surface. Remove loosened soils with cooktop cleaning cream and buff surface clean.

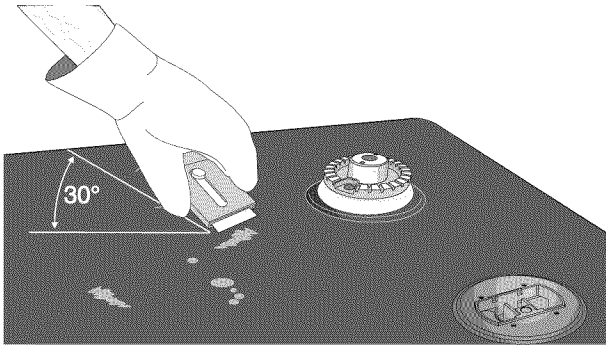

#### CAUTION

Damage to the ceramic glass cooktop may occur if you use scrub pad.

#### Plastic or foods with a high sugar content:

These types of soils need be removed immediately if spilled or melted onto the ceramic cooktop surface. Permanent damage (such as pitting of the cooktop surface) may occur if not removed **immediately**. After turning the surface elements OFF, use a razor blade scraper or a metal spatula with a mitt and scrape the soil from the hot surface (as illustrated on previous page). Allow the cooktop to cool, and use the same method for heavy or burned on soils.

#### Do not use the following on the ceramic glass cooktop:

- Do not use abrasive cleaners and scouring pads, such as metal and some nylon pads. They may scratch the cooktop, making it more difficult to clean.
- Do not use harsh cleaners, such as chlorine bleach, ammonia or oven cleaners, as they may etch or discolor the cooktop.
- Do not use dirty sponges, cloths or paper towels, as they can leave soil or lint on the cooktop which can burn and cause discoloration.



#### Special Caution for Aluminum Foil and Aluminum Cooking Utensils

- **Aluminum foil** - Use of aluminum foil will damage the cooktop. Do not use thin aluminum cooking utensils or allow foil to touch the ceramic cooktop under ANY circumstances.
- **Aluminum utensils** - The melting point of aluminum is much lower than that of other metals. Care must be taken when aluminum pots or pans are used on the cooktop. If allowed to boil dry, not only will the utensil be destroyed, but it may fuse to, break or mark the ceramic glass surface, permanently damaging the cooktop surface.

**Before you call for service**, review the following list. It may save you time & expense. The list includes common occurrences that are not the result of defective workmanship or materials in this appliance.

Before you call	
Problem	Solution
<b>Surface burners do not light.</b>	<ul style="list-style-type: none"> <li>• Surface control knob has not been completely turned to ★ position. Turn the Surface Control knob to ★ and push in and until burner ignites and then turn control knob to desired flame size.</li> <li>• Be sure gas supply valve is open.</li> <li>• Burner ports are clogged. Clean burner. See Cleaning the burner grates, burner caps, burner heads in general care &amp; Cleaning section. With the burner off, clean ports with a small-gauge wire or needle.</li> <li>• Power cord is disconnected from outlet (Electric ignition models only). Be sure cord is securely plugged into the outlet.</li> <li>• Electrical power outage (electric ignition models only). Burners can be lit manually. See Setting Surface Controls in this Use and Care Guide.</li> </ul>
<b>Burner flame only lights half way around burner</b>	<ul style="list-style-type: none"> <li>• Burner ports are clogged. With the burner off, clean ports by using a small-gauge wire and needle.</li> <li>• Moisture is present after cleaning. Lightly fan the flame and allow burner to operate until flame is full. Dry the burners thoroughly following instructions in the General Cleaning section.</li> </ul>
<b>Burner flame is orange</b>	<ul style="list-style-type: none"> <li>• Dust particles in main line. Allow the burner to operate a few minutes until flame turns blue.</li> <li>• In coastal areas, a slightly orange flame is unavoidable due to salt air.</li> </ul>
<b>Scratches or abrasion on ceramic glass cooktop surface</b>	<ul style="list-style-type: none"> <li>• Coarse particles (such as salt or sand) are between cooktop and utensil. Be sure cooktop surface and bottom of utensils are clean before use. Small scratches do not affect cooking and will become less visible with use.</li> <li>• Cleaning materials not recommended for glass ceramic cooktop have been used. See <b>Ceramic-Glass Cooktop</b> section in this Use and Care Guide.</li> </ul>
<b>Metal marks on ceramic glass</b>	<ul style="list-style-type: none"> <li>• Sliding or scraping of metal utensils on cooktop surface. Do not slide metal utensils on cooktop surface. Use a mildly abrasive cleanser to remove marks.</li> </ul>
<b>Brown streaks and specks on ceramic glass</b>	<ul style="list-style-type: none"> <li>• Boilovers have cooked onto surface. Use razor blade scraper to remove soil. See instructions under <b>General Care &amp; Cleaning</b>.</li> <li>• Cleaning materials not recommended for ceramic-glass cooktop have been used. Use recommended cleaners and cleaning method. See Ceramic Glass Cooktop section in this Use and Care Guide.</li> </ul>
<b>Areas of discoloration on ceramic glass</b>	<ul style="list-style-type: none"> <li>• Mineral deposits from water and food. Wet surface with water and sprinkle on a cooktop cleaning creme, Scrub with a clean damp paper towel until the stain disappears. Wipe remaining paste away, then apply a small amount of cooktop cleaning creme and polish with a clean paper towel. Use cookware with clean, dry bottoms. See <b>Ceramic Glass Cooktop</b> section in this Use and Care Guide.</li> </ul>



Your appliance is covered by a one year limited warranty. For one year from your original date of purchase, Electrolux will repair or replace any parts of this appliance that prove to be defective in materials or workmanship when such appliance is installed, used, and maintained in accordance with the provided instructions. In addition, the glass cooktop or radiant surface element of your appliance (excluding built-in and free-standing range appliances) is covered by a two through five year limited warranty. During the 2nd through 5th years from your original date of purchase, Electrolux will provide a replacement glass cooktop or radiant surface element for your appliance which has proven to be defective in materials or workmanship when such appliance is installed, used, and maintained in accordance with the provided instructions.

#### Exclusions

This warranty does not cover the following:

1. Products with original serial numbers that have been removed, altered or cannot be readily determined.
2. Product that has been transferred from its original owner to another party or removed outside the USA or Canada.
3. Rust on the interior or exterior of the unit.
4. Products purchased "as-is" are not covered by this warranty.
5. Products used in a commercial setting.
6. Service calls which do not involve malfunction or defects in materials or workmanship, or for appliances not in ordinary household use or used other than in accordance with the provided instructions.
7. Service calls to correct the installation of your appliance or to instruct you how to use your appliance.
8. Expenses for making the appliance accessible for servicing, such as removal of trim, cupboards, shelves, etc., which are not a part of the appliance when it is shipped from the factory.
9. Service calls to repair or replace appliance light bulbs, air filters, water filters, other consumables, or knobs, handles, or other cosmetic parts.
10. Labor or in-home service costs during the additional limited warranty periods beyond the first year from your original date of purchase.
11. Pickup and delivery costs; your appliance is designed to be repaired in the home.
12. Surcharges including, but not limited to, any after hour, weekend, or holiday service calls, tolls, ferry trip charges, or mileage expense for service calls to remote areas, including the state of Alaska.
13. Damages to the finish of appliance or home incurred during transportation or installation, including but not limited to floors, cabinets, walls, etc.
14. Damages caused by: services performed by unauthorized service companies; use of parts other than genuine Electrolux parts or parts obtained from persons other than authorized service companies; or external causes such as abuse, misuse, inadequate power supply, accidents, fires, or acts of God.

#### DISCLAIMER OF IMPLIED WARRANTIES; LIMITATION OF REMEDIES

CUSTOMER'S SOLE AND EXCLUSIVE REMEDY UNDER THIS LIMITED WARRANTY SHALL BE REPAIR OR REPLACEMENT AS PROVIDED HEREIN. CLAIMS BASED ON IMPLIED WARRANTIES, INCLUDING WARRANTIES OF MERCHANTABILITY OR FITNESS FOR A PARTICULAR PURPOSE, ARE LIMITED TO ONE YEAR OR THE SHORTEST PERIOD ALLOWED BY LAW, BUT NOT LESS THAN ONE YEAR. ELECTROLUX SHALL NOT BE LIABLE FOR CONSEQUENTIAL OR INCIDENTAL DAMAGES SUCH AS PROPERTY DAMAGE AND INCIDENTAL EXPENSES RESULTING FROM ANY BREACH OF THIS WRITTEN LIMITED WARRANTY OR ANY IMPLIED WARRANTY. SOME STATES AND PROVINCES DO NOT ALLOW THE EXCLUSION OR LIMITATION OF INCIDENTAL OR CONSEQUENTIAL DAMAGES, OR LIMITATIONS ON THE DURATION OF IMPLIED WARRANTIES, SO THESE LIMITATIONS OR EXCLUSIONS MAY NOT APPLY TO YOU. THIS WRITTEN WARRANTY GIVES YOU SPECIFIC LEGAL RIGHTS. YOU MAY ALSO HAVE OTHER RIGHTS THAT VARY FROM STATE TO STATE.

#### If You Need Service

Keep your receipt, delivery slip, or some other appropriate payment record to establish the warranty period should service be required. If service is performed, it is in your best interest to obtain and keep all receipts. Service under this warranty must be obtained by contacting Electrolux at the addresses or phone numbers below.

This warranty only applies in the USA, Puerto Rico and Canada. In the USA and Puerto Rico, your appliance is warranted by Electrolux Major Appliances North America, a division of Electrolux Home Products, Inc. In Canada, your appliance is warranted by Electrolux Canada Corp. Electrolux authorizes no person to change or add to any obligations under this warranty. Obligations for service and parts under this warranty must be performed by Electrolux or an authorized service company. Product features or specifications as described or illustrated are subject to change without notice.

#### USA

**1.800.944.9044**

Electrolux Home Products, Inc.,  
10200 David Taylor Drive  
Charlotte, NC 28262

#### Canada

1-800-265-8352

Electrolux Canada Corp.  
5855 Terry Fox Way  
Mississauga, Ontario, Canada L5V 3E4



electrolux.com/shop



CE

Electrolux is a leading manufacturer of home appliances, including refrigerators, freezers, and ovens. The company is committed to providing high-quality products and excellent customer service. For more information, please visit our website at [electrolux.com/shop](http://electrolux.com/shop).