

# FRIGIDAIRE

# Use & Care

## TABLE OF CONTENTS

Welcome & Congratulations .....	2	Setting Surface Controls .....	10
Important Safety Instructions.....	3	Care & Cleaning (Cleaning Chart) .....	11
Features at a Glance.....	6	Care & Cleaning .....	11
Before Setting Surface Controls .....	6	Before You Call .....	13
Surface Cookware Recommendations.....	7	Major Appliance Warranty .....	14
Before Setting Surface Controls .....	9		

# WELCOME & CONGRATULATIONS

## Product Registration

### Register Your Product

The **PRODUCT REGISTRATION CARD** should be filled in completely, signed and returned to Electrolux Home Products.

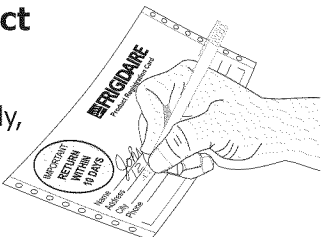

Congratulations on your purchase of a new appliance! At **Electrolux Home Products**, we are very proud of our product and are completely committed to providing you with the best service possible. Your satisfaction is our number one priority.

We know you'll enjoy your new appliance and Thank You for choosing our product. We hope you consider us for future purchases.

## PLEASE CAREFULLY READ AND SAVE THESE INSTRUCTIONS

This Use & Care Manual contains general operating instructions for your appliance and feature information for several models. Your product may not have all the described features. The graphics shown are representative. The graphics on your appliance may not look exactly like those shown. These instructions are not meant to cover every possible condition and situation that may occur. Common sense and caution must be practiced when installing, operating and maintaining any appliance.

## Serial Plate Location

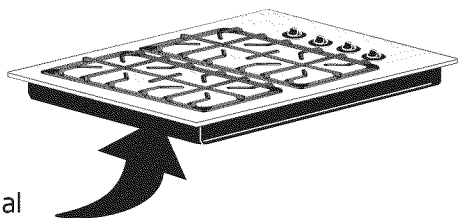

Cooktop Serial Plate Location

**Please record your model and serial numbers below for future reference.**

Model Number: \_\_\_\_\_

Serial Number: \_\_\_\_\_

Purchase Date: \_\_\_\_\_

## NOTE

Please attach sales receipt here for future reference.



# IMPORTANT SAFETY INSTRUCTIONS

Read all instructions before using this appliance.  
Save these instructions for future reference.

## WARNING

If the information in this manual is not followed exactly, a fire or explosion may result causing property damage, personal injury or death.

## FOR YOUR SAFETY

- Do not store or use gasoline or other flammable vapors and liquids in the vicinity of this or any other appliance.
- **WHAT TO DO IF YOU SMELL GAS:**
  - Do not try to light any appliance.
  - Do not touch any electrical switch; do not use any phone in your building.
  - Immediately call your gas supplier from a neighbor's phone. Follow the gas supplier's instructions.
  - If you cannot reach your gas supplier, call the fire department.
- Installation and service must be performed by a qualified installer, servicer or the gas supplier.

## DEFINITIONS

 This is the safety alert symbol. It is used to alert you to potential personal injury hazards. Obey all safety messages that follow this symbol to avoid possible injury or death.

## WARNING

This symbol will help alert you to situations that may cause serious bodily harm, death or property damage.

## CAUTION

This symbol will help alert you to situations that may cause bodily injury or property damage.

## IMPORTANT

IMPORTANT indicates installation, operation or maintenance information which is important but not hazard-related.

- Remove all tape and packaging wrap before using the cooktop. Destroy the carton and plastic bags after unpacking the cooktop. Never allow children to play with packaging material. Do not remove the model/serial plate attached to the cooktop.
- **Proper Installation—Be sure your appliance is properly installed and grounded by a qualified technician in accordance with the National Fuel Gas Code ANSI Z223.1 latest edition and CAN/CGA B149.2, and the National Electrical Code ANSI/NFPA No. 70—latest edition, and local code requirements.** Install and/or adjust only per installation instructions provided in the literature package for this cooktop.

Ask your dealer to recommend a qualified technician and an authorized repair service. Know how to shut off gas supply at the meter and disconnect the electrical power to the cooktop at the circuit breaker or fuse box in case of an emergency.

- **User Servicing—Do not repair or replace any part of the appliance unless specifically recommended in the manuals.** All other servicing should be done only by a qualified technician. This may reduce the risk of personal injury and damage to the cooktop.
- **Never modify or alter the construction of a cooktop by removing panels, wire covers, or any other part of the product.**

## WARNING

Stepping or leaning on this cooktop can result in serious injuries and may also cause damage to the cooktop. Do not allow children to climb or play around the cooktop.

- **Storage on Appliance—Flammable materials should not be stored on the cooktop, near surface burners.** This includes paper, plastic and cloth items, such as cookbooks, plasticware and towels, as well as flammable liquids. Do not store explosives, such as aerosol cans, on the cooktop. Flammable materials may explode and result in fire or property damage.

## CAUTION

Do not store items of interest to children in the cabinets above the cooktop.

- **Do not leave children alone—Children should not be left alone or unattended in the area where an appliance is in use.** They should never be allowed to sit or stand on any part of the appliance.

## IMPORTANT SAFETY INSTRUCTIONS

- **DO NOT TOUCH SURFACE BURNERS, GRATES, OR AREAS NEAR THESE BURNERS.** Surface burners may be hot even though the flames are not visible. Areas near surface burners may become hot enough to cause burns. During and after use, do not touch or let clothing or other flammable materials touch these areas until they have had sufficient time to cool. Among these areas are the cooktop and the surfaces facing the cooktop.
- **Wear Proper Apparel—Loose-fitting or hanging garments should never be worn while using the appliance.** Do not let clothing or other flammable materials contact hot surfaces.

### WARNING

**NEVER use this appliance as a space heater to heat or warm the room. Doing so may result in carbon monoxide poisoning.**

- **Do Not Use Water or Flour on Grease Fires—Smother the fire with a pan lid, or use baking soda, a dry chemical or foam-type extinguisher.**
- **When heating fat or grease, watch it closely.** Fat or grease may catch fire if allowed to become too hot.
- **Use Only Dry Pot holders—Moist or damp pot holders on hot surfaces may result in burns from steam.** Do not let the pot holders touch the flame or burners. Do not use a towel or other bulky cloth instead of a pot holder.
- **Do Not Heat Unopened Food Containers—Buildup of pressure may cause container to burst and result in injury.**
- **Know which knob controls each surface burner.** Always turn the knob to the LITE position when igniting the burners. Visually check that the burner has lit. Then adjust the flame so it does not extend beyond the edge of the utensil.

### WARNING

**Use Proper Flame Size—Adjust flame size so it does not extend beyond the edge of the utensil. The use of undersized utensils will expose a portion of the burner flame to direct contact and may result in ignition of clothing. Proper relationship of utensil to flame will also improve efficiency.**

- **Use proper pan size—**This appliance is equipped with one or more surface burners of different sizes. Select utensils having flat bottom large enough to cover the surface burner. The use of undersized utensils will expose a portion of the surface burner to direct contact and may result in ignition of clothing. Proper relationship of utensil to the surface burner will also improve efficiency.

### WARNING

**Do not use stove top grills on your sealed gas burners. If you use a stove top grill on a sealed gas burner, it will cause incomplete combustion and can result in exposure to carbon monoxide levels above allowable current standards. This can be hazardous to your health.**

- **Utensil Handles Should Be Turned Inward and Not Extend Over Adjacent Surface Burners—**To reduce the risk of burns, ignition of flammable materials, and spillage due to unintentional contact with the utensil, the handle of the utensil should be positioned so that it is turned inward, and does not extend over adjacent surface burners.
- **Never Leave Surface Burners Unattended at High Heat Settings—**Boilovers cause smoking and greasy spillovers that may ignite, or a pan that has boiled dry may melt.
- **Protective Liners—**Do not use aluminum foil to line surface burner pans. Protective liners or aluminum foil may interfere with heat and air distribution, and combustion. Damage to the cooktop or personal injury may result.
- **Glazed Cooking Utensils—**Only certain types of glass, glass/ceramic, ceramic, earthenware, or other glazed utensils are suitable for cooktop service without breaking due to the sudden change in temperature. Check the manufacturer's recommendations for cooktop use.
- **Do Not Use Decorative Surface Burner Covers.** If a burner is accidentally turned on, the decorative cover will become hot and possibly melt. You will not be able to see that the burner is on. Burns will occur if the hot covers are touched. Damage may also be done to the cooktop or burners because the covers may cause overheating. Air will be blocked from the burner and cause combustion problems.

### IMPORTANT SAFETY NOTICE

The California Safe Drinking Water and Toxic Enforcement Act requires the Governor of California to publish a list of substances known to the state to cause cancer, birth defects or other reproductive harm, and requires businesses to warn customers of potential exposure to such substances.

# IMPORTANT SAFETY INSTRUCTIONS

## GROUNDING INSTRUCTIONS

For personal safety, the cooktop must be properly grounded. For maximum safety, the power cord must be plugged into an electrical outlet that is correctly polarized and properly grounded.

**DO NOT** operate the cooktop using a 2-prong adapter or an extension cord. If a 2-prong wall receptacle is the only available outlet, it is the personal responsibility of the consumer to have it replaced with a properly grounded 3-prong wall receptacle installed by a qualified electrician.

See the **INSTALLATION INSTRUCTIONS** packaged with this cooktop for complete installation and grounding instructions.

### **WARNING**

This appliance is equipped with a 3-prong grounding plug for your protection against shock hazard and should be plugged directly into a properly grounded receptacle. **DO NOT** cut or remove the grounding prong from this plug.

Grounding  
type wall  
receptacle

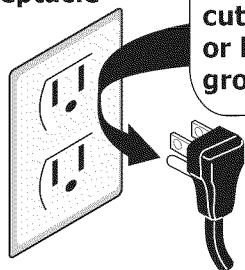

Do not, under any circumstances, cut, remove, or bypass the grounding prong.

Power supply cord with  
3-prong grounding plug

### **WARNING**

Avoid fire hazard or electrical shock. **DO NOT** use an adapter plug, an extension cord, or remove grounding prong from electrical power cord. Failure to follow this warning can cause serious injury, fire or death.

## CONVERSION TO LIQUEFIED PETROLEUM GAS (OR L.P. GAS)

This natural gas range is designed to allow for conversion to Liquefied Petroleum (L.P.) Gas.

If L.P. conversion is needed, contact the service center for assistance. The L.P. Conversion Kit is provided with this cooktop and is located in the literature envelope. Before installing the kit be sure to follow the L.P. Installation Instructions carefully.

### **WARNING**

Personal injury or death from electrical shock may occur if the range is not installed by a qualified installer or electrician.

### **CAUTION**

Any additions, changes or conversions required in order for this appliance to satisfactorily meet the application needs must be made by an authorized Service Center.

## ASSEMBLY OF THE SURFACE BURNER CAPS AND BURNER GRATES

It is very important to make sure that all of the Surface Burner Caps and Surface Burner Grates are installed correctly and at the correct locations.

- 1 Remove all packing material from cooktop area.
- 2 Discard all packing material (if applicable).
- 3 Unpack Burner Grates and position on the cooktop.

**REMEMBER — DO NOT ALLOW SPILLS, FOOD, CLEANING AGENTS OR ANY OTHER MATERIAL TO ENTER THE GAS ORIFICE HOLDER OPENING.** Always keep the Burner Caps and Burner Heads in place whenever the surface burners are in use.

## FEATURES AT A GLANCE

### LOCATIONS OF THE GAS SURFACE BURNERS

- ① The SIMMER burner is best used for simmering delicate sauces, etc.
- ② The STANDARD sized burners are used for most surface cooking needs.
- ③ The POWER burner is best used for bringing large quantities of liquid rapidly up to temperature or when preparing larger quantities of food.

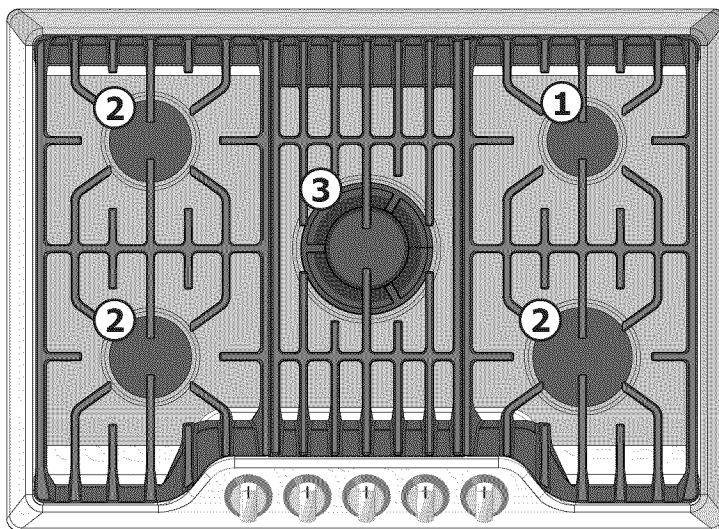

Figure 1 - Model FPGC3077RS

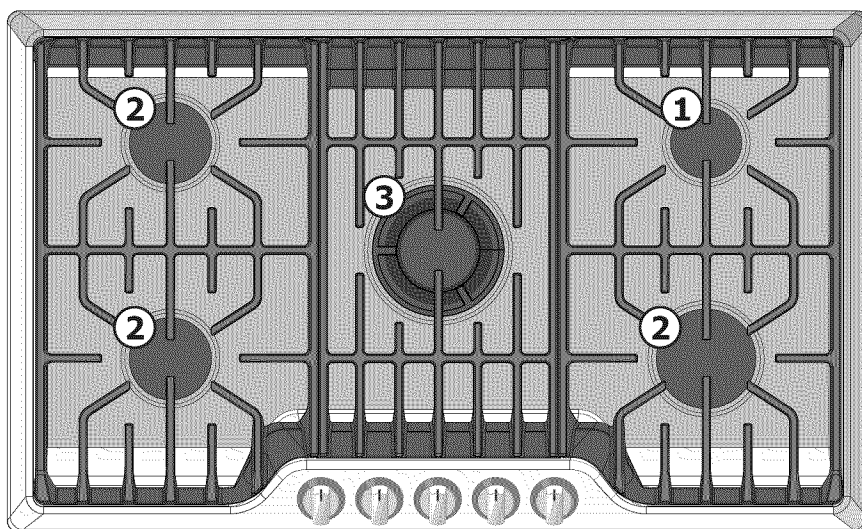

Figure 2 - Model FPGC3677RS

# SURFACE COOKWARE RECOMMENDATIONS

## USE PROPER COOKWARE

Cookware should have flat bottoms that make good contact with the cooktop grate. Check for flatness by rotating a ruler across the bottom of the cookware (See Figure 1). Be sure to follow the recommendations for using cookware as shown in Figure 2.

Note: The size and type of cookware used will influence the setting needed for best cooking results.

Note: Always use a utensil for its intended purpose. Follow manufacturer's instructions. Some utensils were not made to be used in the oven or on the cooktop.

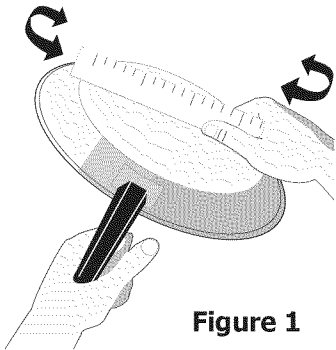

Figure 1

## COOKWARE MATERIAL TYPES

The cookware material determines how evenly and quickly heat is transferred from the surface unit to the pan bottom. The most popular materials available are:

**ALUMINUM** - Excellent heat conductor. Some types of food will cause it to darken (Anodized aluminum cookware resists staining & pitting).

**COPPER** - Excellent heat conductor but discolors easily.

**STAINLESS STEEL** - Slow heat conductor with uneven cooking results. Is durable, easy to clean and resists staining.

**CAST IRON** - A poor heat conductor however will retain heat very well. Cooks evenly once cooking temperature is reached.

**PORCELAIN-ENAMEL on METAL** - Heating characteristics will vary depending on base material.

**GLASS** - Slow heat conductor.

### CORRECT

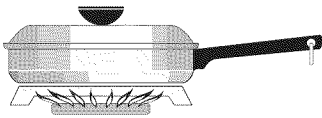

- Flat bottom and straight sides.
- Tight fitting lids.
- Weight of handle does not tilt pan. Pan is well balanced.
- Pan sizes match the amount of food to be prepared.
- Made of material that conducts heat well.
- Easy to clean.

### INCORRECT

- Curved and warped pan bottoms.

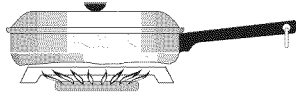

- Pan overhangs unit by more than 2.5 cm (1").

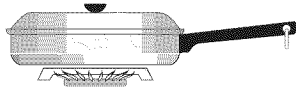

- Heavy handle tilts pan.

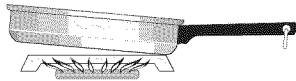

- Flame extends beyond unit.

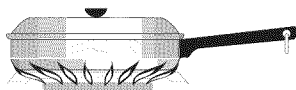

Figure 2

\* Specialty pans such as lobster pots, griddles and pressure cookers may be used but must conform to the above recommended cookware requirements.

## SURFACE COOKWARE RECOMMENDATIONS

### USING THE GRIDDLE

#### Before first use:

- Wash Griddle in hot soapy water. Rinse and then dry completely.
- Apply a thin coat of vegetable oil to the entire surface (front and back of griddle).
- Preheat your oven to 350°F. Place the griddle on the upper rack in your oven.
- Bake griddle for 1 hour at 350°F, then turn oven OFF and let cool before removing.
- The surface may appear to have a tacky feel to it from this seasoning process. If desired, wash the griddle in hot soapy water, rinse well, and dry completely.

#### After each use:

- To prevent rusting, store in a dry place and keep uncovered.
- After each use, clean with a stiff brush and hot water only.
- DO NOT CLEAN GRIDDLE IN DISHWASHER.
- Dry immediately and apply a light coating of vegetable oil to griddle before storing.

#### Using the Griddle:

- Place either side of the griddle centered over the left side gas burners.
- Preheat the griddle for 5 minutes on medium to medium low setting.  
Slow preheat ensures even heat distribution during the cooking process.
- DO NOT preheat the griddle on HI setting. Preheating on HI may warp the griddle and prevent even heat distribution.

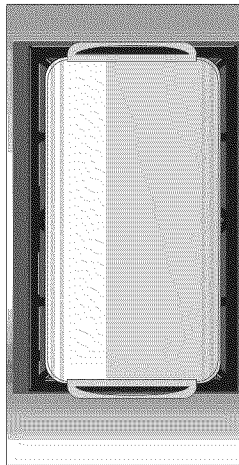

### CAUTION

- Always place the griddle on the grate before turning on the burner.
- Always use potholders to remove the griddle from the grate. Allow the griddle to cool before removing. Do not set hot griddle on surfaces that cannot withstand high heat such as countertops.
- Be sure the griddle is positioned correctly and is stable before use to prevent hot spills and possible burns.

### USING A WOK (NOT SUPPLIED)

**Woks** with flat bottoms suitable for use on your cooktop are available in most cookshop or hardware stores. Round-bottomed woks (with a support ring that does not extend beyond the burner unit) may also be used. The metal ring was designed to support the wok safely when it is filled with large amounts of liquids (soup making) or fat (frying).

**Wire trivets:** Do not use wire trivets. Cookware bottoms must be in direct contact with the grates.

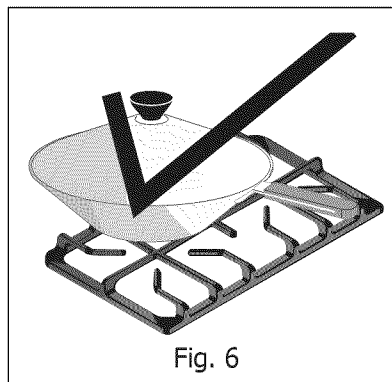

Fig. 6

**DO NOT** use a wok if it is equipped with a metal ring that extends beyond the burner unit. Because this ring traps heat, the surface unit and cooktop surface could be damaged.

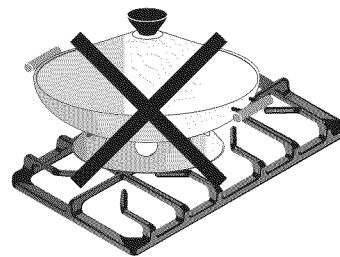

Fig. 7



## BEFORE SETTING SURFACE CONTROLS

### PLACEMENT OF BURNER CAPS

Place a burner cap on each burner head, matching the cap size to the head size. The cap for each burner has an inner locating ring which centers the cap correctly on the burner head. Be sure that all the burner caps and burner heads are correctly placed BEFORE using your appliance.

Make sure each burner cap is properly aligned and level.

Turn the burner on to determine if it will light. If the burner does not light, contact a Service Center. Do not service the sealed burner yourself.

**ATTENTION:** Do not slide the burner caps on the cooktop, doing so can damage the surface.

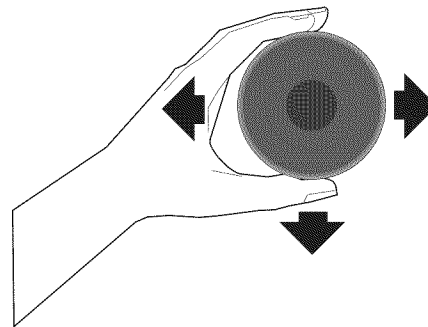
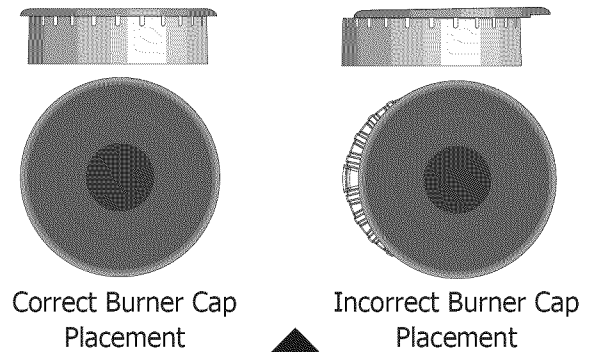
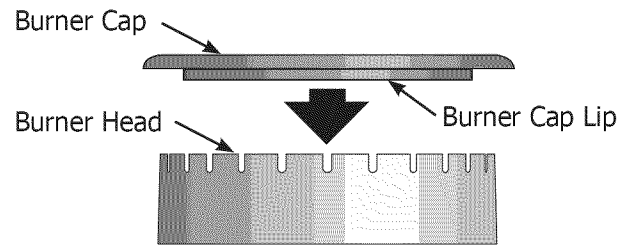

### ➔ IMPORTANT

**For Proper Ignition: Burner Ring Alignment Tab Must Align with Burner Base Alignment Tab Slot**

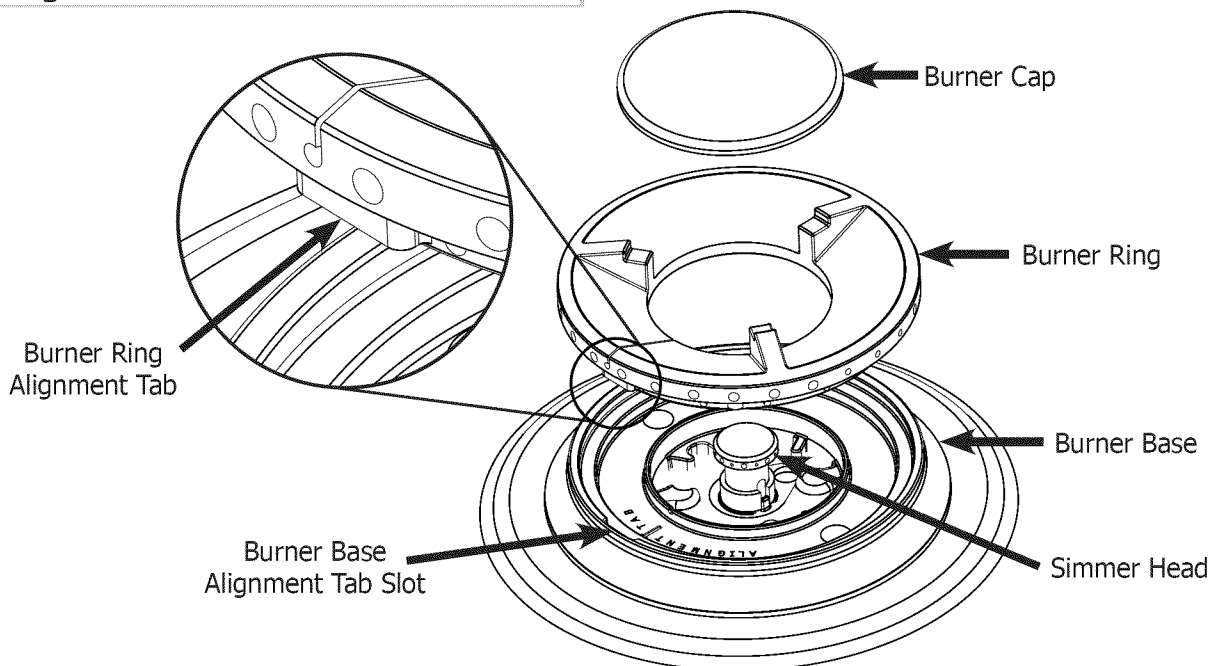

## SETTING SURFACE CONTROLS

### SETTING PROPER SURFACE BURNER FLAME SIZE

**For most cooking** - start on the highest control setting and then turn to a lower one to complete the process. Use the recommendations below as a guide for determining proper flame size for various types of cooking. The size and type of utensil used and the amount of food being cooked will influence the setting needed.

**For deep fat frying** - use a thermometer and adjust the surface control knob accordingly. If the fat is too cool, the food will absorb the fat and be greasy. If the fat is too hot, the food will brown so quickly that the center will be under cooked. Do not attempt to deep fat fry too much food at once as the food will neither brown nor cook properly.

*Flame Size	Type of Cooking
High Flame	Start most foods; bring water to a boil; pan broiling.
Medium Flame	Maintain a slow boil; thicken sauces, gravies; steaming.
Low Flame	Keep foods cooking; poach; stewing.

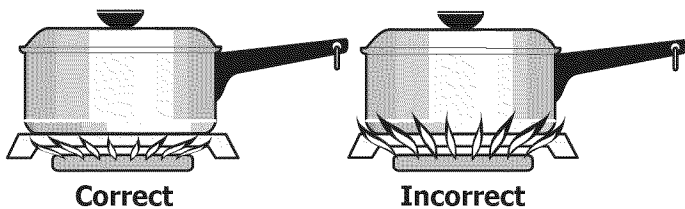

### ➔ IMPORTANT

Never extend the flame beyond the outer edge of the utensil. A higher flame simply wastes heat and energy, and increases the risk of being burned by the gas flame.

### 📌 NOTE

**\*Note: Settings are based on using medium-weight metal or aluminum pans. Settings may vary when using other types of pans.** The color of the flame is the key to proper burner adjustment. A good flame is clear, blue and hardly visible in a well-lighted room. Each cone of flame should be steady and sharp. Clean burner if flame is yellow-orange.

### OPERATING THE GAS SURFACE CONTROLS

- 1 Place cooking utensil on surface burner.
- 2 Push the surface control knob down and turn **counterclockwise** out of the OFF position.
- 3 Release the knob and rotate to the LITE position (see figure 1). Note: All four electronic surface igniters will spark at the same time. However, only the burner you are turning on will ignite.
- 4 Visually check that the burner has a flame.
- 5 Turn the control knob **counterclockwise** to the desired flame size. The control knobs do not have to be set at a particular setting. Use the knob indicator settings to adjust the flame as needed. **DO NOT** cook with the surface control knob in the LITE position. (The electronic ignitor will continue to spark if the knob is left in the LITE position.)

### ⚠ CAUTION

**Do not place plastic items such as salt and pepper shakers, spoon holders or plastic wrappings on top of the range when it is in use.** These items could melt or ignite. Pot holders, towels or wood spoons could catch fire if placed too close to a flame.

### ⚠ CAUTION

**Do not operate the burner for an extended period of time without cookware on the grate.** The finish on the grate may chip without cookware to absorb the heat.

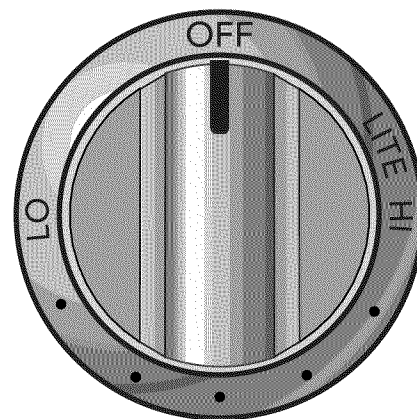

### ➔ IMPORTANT

In the event of an electrical power outage, the surface burners can be lit manually. To light a surface burner, hold a lit match to the burner head, then slowly turn the surface control knob to LITE. After burner lights turn the knob to desired setting. Use caution when lighting surface burners manually.

## CARE & CLEANING (Cleaning Chart)

### CLEANING VARIOUS PARTS OF YOUR COOKTOP

Before cleaning any part of the cooktop, be sure all controls are turned OFF and the cooktop is COOL. REMOVE SPILLOVERS AND HEAVY SOILING AS SOON AS POSSIBLE. REGULAR CLEANING WILL REDUCE THE NUMBER OF MAJOR CLEANING LATER.

Surfaces	How to Clean
<b>Glass, Painted and Plastic Control Knobs, Body Pieces, and Decorative Trim</b>	Using a soft cloth, clean with mild dish detergent and water or a 50/50 solution of vinegar and water. Follow by rinsing the area with clean water; dry and polish with a soft cloth. Glass cleaners may be used if sprayed on a soft cloth first. <b>DO NOT</b> spray liquids directly on the control pad and display area. Do not use large amounts of water on the control panel - excess water on the control area may cause damage to the appliance. Do not use other liquid cleaners, abrasive cleaners, scouring pads, or some paper towels - they will damage the finish.
<b>Control Panel</b>	Wipe the control panel clean after each use. Before cleaning the control panel, turn all controls to OFF and remove the control knobs. To remove, pull each knob straight off the shaft. Clean using hot, soapy water and a cloth. Be sure to squeeze excess water from the cloth before wiping the panel; especially when wiping around the controls. Excess water in or around the controls may cause damage to the appliance. To replace knobs after cleaning, line up the flat sides of both the knob and the shaft; then push the knob into place.
<b>Stainless Steel, Chrome Decorative Trim (some models)</b>	Clean <b>stainless steel</b> with hot, soapy water and a dishcloth. Rinse with clean water and a cloth. <b>Do not use cleaners with high concentrations of chlorides or chlorine.</b> Do not use harsh scrubbing cleaners. Only use kitchen cleaners that are especially made for cleaning stainless steel. Always be sure to rinse the cleaners from the surface as bluish stains may occur during heating that cannot be removed.
<b>Porcelain Enamel Burner Grates, Burner Rings (some models), Cooktop Surface (some models)</b>	Gentle scouring with a soapy scouring pad will remove most spots. Rinse with a 1:1 solution of clear water and ammonia. If necessary, cover difficult spots with an ammonia-soaked paper towel for 30 to 40 minutes. Rinse with clean water and a damp cloth, and then scrub with a soap-filled scouring pad. Rinse and wipe dry with a clean cloth or paper towel. Remove all cleaners or the porcelain may become damaged during future heating. <b>DO NOT</b> use spray oven cleaners on the cooktop.

## CARE & CLEANING

### Cleaning the Cooktop and Surface Burners

#### CAUTION

To avoid possible burns DO NOT attempt any of the cooktop cleaning instructions provided before turning OFF all of the surface burners and allow them to completely cool.

#### CAUTION

Any additions, changes or conversions required in order for this appliance to satisfactorily meet the application needs must be made by an authorized qualified agency.

Routinely clean the cooktop. Wipe with a clean, damp cloth and wipe dry to avoid scratches.

Keeping the surface burner head ports and slots clean will prevent improper ignition and an uneven flame. See the following sections for more instructions.

### Cleaning recessed and contoured areas of cooktop

If a spill occurs on or in the recessed or contoured areas, blot up spill with an absorbent cloth. Rinse with a clean, damp cloth and wipe dry.

### Cleaning surface burner grates

- Clean only after the grates are completely cool.
- Use nonabrasive plastic scrubbing pad and mild abrasive cleanser or clean in the dishwasher.
- Food soils containing acids may affect the finish. Clean immediately after the grates are cool.
- Thoroughly dry grates immediately following cleaning.

### Cleaning burner caps

- Remove caps from burner heads after they have cooled.
- Clean heavy soils with a plastic scrubbing pad and absorbent cloth.
- Thoroughly dry burner caps immediately following cleaning including the bottom and inside of cap.

## CARE & CLEANING

- Do not use abrasive cleaners. They can scratch porcelain.
- Do not clean burner caps in the dishwasher.
- Do not operate surface burners without burner caps properly in place. Read important notes.

### Cleaning surface burner heads

For proper gas flow it may be necessary to clean the burner head and slots. To clean, first use a clean DAMP cloth to soak up any spills. Remove any food from between the burner slots using a small nonabrasive brush like a toothbrush and afterwards wipe up using a damp cloth. For stubborn soils located in the slots, use a small-gauge wire or needle to clean.

Any spill on or around the electrode must be carefully cleaned. Take care not to hit the electrode with anything hard or it could be damaged.

### To clean the burner head ignition ports

Each burner head has a small ignition port located as shown. Should you experience ignition problems it may be that this port hole is partially blocked with soil. With the burner head in place, use a small wire gauge needle or the end of a paper clip to clear the ignition port (See to Fig. 1 and 2).

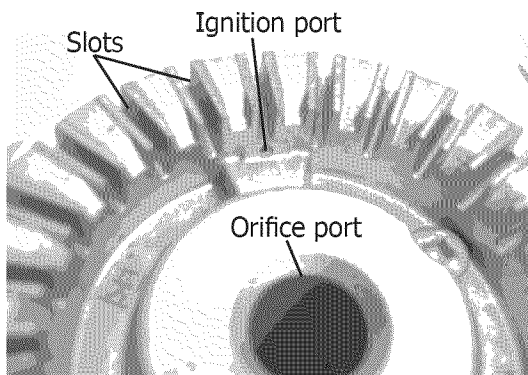

Figure 1- Cooktop regular burner head

### ➔ IMPORTANT

- The surface burner heads are secured to the cooktop and must be cleaned in place on the cooktop.
- Always keep the surface burner caps in place **whenever a surface burner is in use.**
- When replacing the burner caps, be sure the burner caps are **seated firmly on top of the burner heads.**
- For proper flow of gas and ignition of burners DO NOT allow spills, food, cleaning agents or any other material to enter the gas orifice port opening.

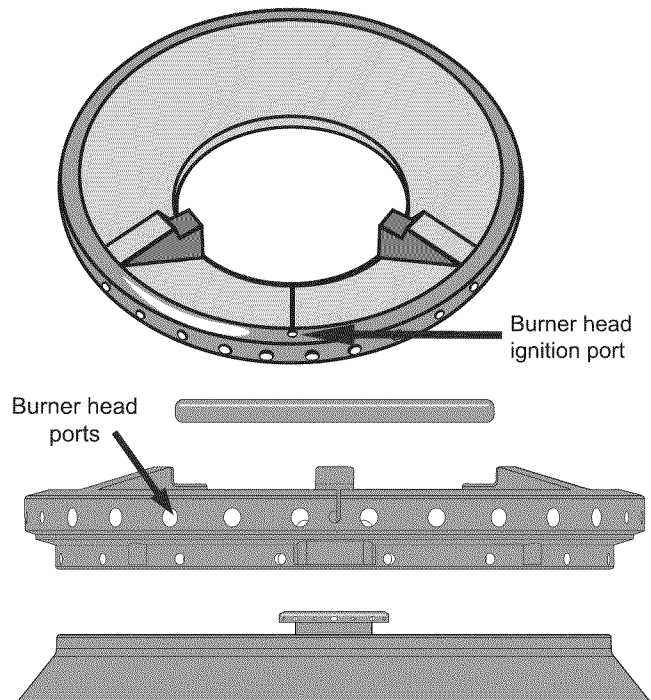

Figure 2- Cooktop G5 burner head

## ➔ IMPORTANT

**Before you call for service,** review this list. It may save you time and expense. The list includes common occurrences that are not the result of defective workmanship or materials in this appliance.

OCCURRENCE	POSSIBLE CAUSE/SOLUTION
<b>Surface burners do not light.</b>	Surface Control knob has not been completely turned to LITE. Push in and turn the Surface Control knob to LITE until burner ignites and then turn control to desired flame size.
	Be sure gas supply valve is open.
	Burner ports or slots are clogged. With the burner off, use a small-gauge wire or needle to clean ports or slots.
	Power cord is disconnected from outlet (electric ignition models). Be sure cord is plugged securely into outlet.
	Electrical power outage (electric ignition models). Burners can be lit manually. See Setting Surface Controls in this Owner's Guide.
<b>Surface burner flame burns half way around.</b>	Burner ports or slots are clogged. With the burner off, clean ports with a small-gauge wire or needle to clean ports or slots.
	Moisture is present after cleaning. Lightly fan the flame and allow burner to operate until flame is full. Dry the burners thoroughly following instructions under General Cleaning.
<b>Surface burner flame is orange.</b>	Dust particles in main line. Allow the burner to operate a few minutes until flame turns blue.
	In coastal areas, a slightly orange flame is unavoidable due to salt air.

## MAJOR APPLIANCE WARRANTY

Your appliance is covered by a one year limited warranty. For one year from your original date of purchase, Electrolux will pay all costs for repairing or replacing any parts of this appliance that prove to be defective in materials or workmanship when such appliance is installed, used and maintained in accordance with the provided instructions.

**Exclusions This warranty does not cover the following:**

- 1 Products with original serial numbers that have been removed, altered or cannot be readily determined.
- 2 Product that has been transferred from its original owner to another party or removed outside the USA or Canada.
- 3 Rust on the interior or exterior of the unit.
- 4 Products purchased "as-is" are not covered by this warranty.
- 5 Food loss due to any refrigerator or freezer failures.
- 6 Products used in a commercial setting.
- 7 Service calls which do not involve malfunction or defects in materials or workmanship, or for appliances not in ordinary household use or used other than in accordance with the provided instructions.
- 8 Service calls to correct the installation of your appliance or to instruct you how to use your appliance.
- 9 Expenses for making the appliance accessible for servicing, such as removal of trim, cupboards, shelves, etc., which are not a part of the appliance when it is shipped from the factory.
- 10 Service calls to repair or replace appliance light bulbs, air filters, water filters, other consumable, or knobs, handles, or other cosmetic parts.
- 11 Surcharges including, but not limited to, any after hour, weekend, or holiday service calls, tolls, ferry trip charges, or mileage expense for service calls to remote areas, including the state of Alaska.
- 12 Damages to the finish of appliance or home incurred during installation, including but not limited to floors, cabinets, walls, etc.
- 13 Damages caused by: services performed by unauthorized service companies; use of parts other than genuine Electrolux parts or parts obtained from persons other than authorized service companies; or external causes such as abuse, misuse, inadequate power supply, accidents, fires, or acts of God.

**DISCLAIMER OF IMPLIED WARRANTIES; LIMITATION OF REMEDIES**

Customer's sole and exclusive remedy under this limited warranty shall be product repair or replacement as provided herein. Claims based on implied warranties, including warranties of merchantability or fitness for particular purpose, are limited to one year or the shortest period allowed by law, but not less than one year. Electrolux shall not be liable for consequential or incidental damages such as property damage and incidental expenses resulting from any breach of this written limited warranty or any implied warranty. Some states and provinces do not allow the exclusion or limitation of incidental or consequential damages, or limitations on the duration of implied warranties, so these limitations or exclusions may not apply to you. This written warranty gives you specific legal rights. You may also have other rights that vary from state to state.

**If You  
Need  
Service**

Keep your receipt, delivery slip, or some other appropriate payment record to establish the warranty period should service be required. If service is performed, it is in your best interest to obtain and keep all receipts. Service under this warranty must be obtained contacting Electrolux at the addresses or phone numbers below.

This warranty only applies in the USA and Canada. In the USA, your appliance is warranted by Electrolux Major Appliances North America, a division of Electrolux Home Products, Inc. In Canada, your appliance is warranted by Electrolux Canada Corp. Electrolux authorizes no person to change or add to any obligations under this warranty. Obligations for service and parts under this warranty must be performed by Electrolux or an authorized service company. Product features or specifications as described or illustrated are subject to change without notice.

**USA**  
**1.800.944.9044**  
**Electrolux Major Appliances**  
**North America**  
**P.O. Box 212378**  
**Augusta, GA 30907**



**Canada**  
**1.800.265.8352**  
**Electrolux Canada Corp.**  
**5855 Terry Fox Way**  
**Mississauga, Ontario, Canada**  
**L5V 3E4**