

Gas Slide-in Range

User manual

NX58K9850S* / NX58K9852S*

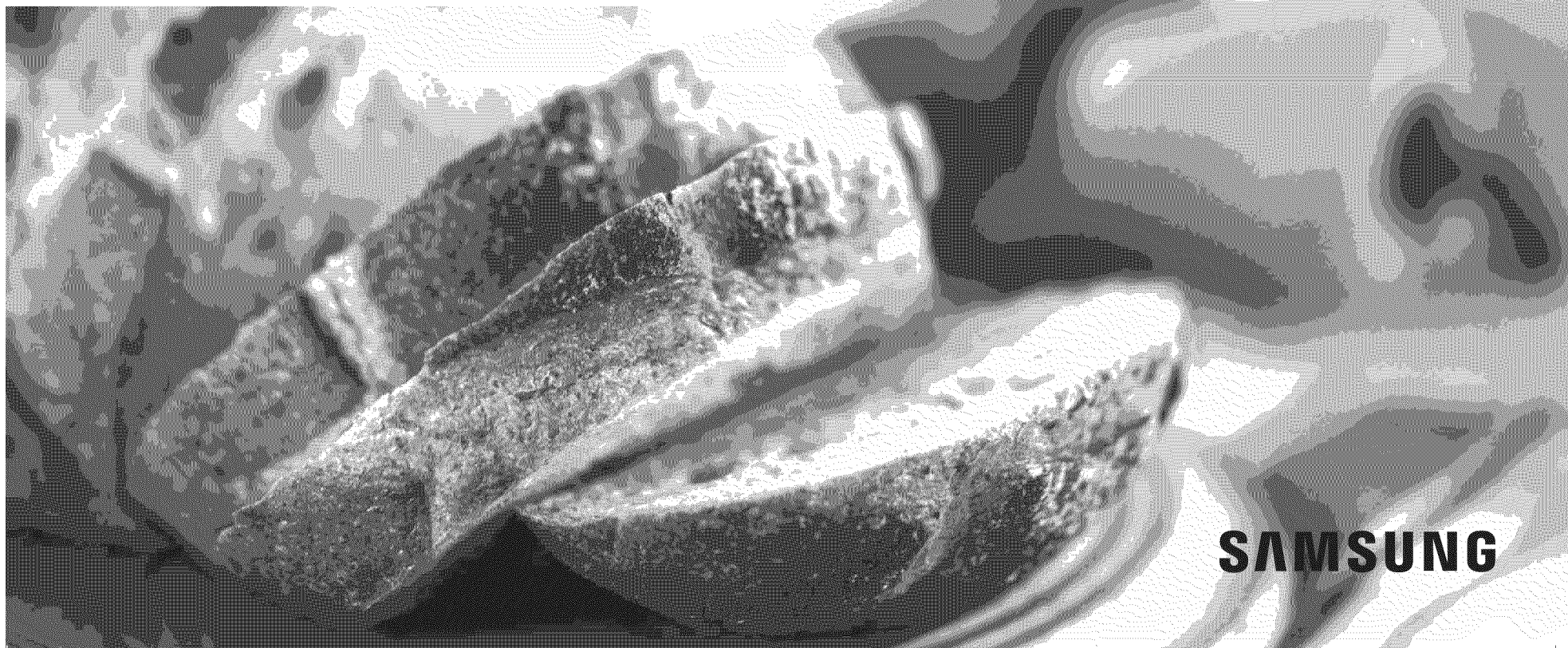

SAMSUNG

WARNING: If the information in this manual is not followed exactly, a fire or explosion may result causing property damage, personal injury, or death.

- DO NOT store or use gasoline or other flammable vapors and liquids in the vicinity of this or any other appliance.
- WHAT TO DO IF YOU SMELL GAS:
 - DO NOT try to light any appliance.
 - DO NOT touch any electrical switch.
 - DO NOT use any phone in your building.
 - Immediately call your gas supplier from a neighbor's phone. Follow the gas supplier's instructions.
 - If you cannot reach your gas supplier, call the fire department.
- Installation and service must be performed by a qualified installer, service agency, or the gas supplier.

ANTI-TIP DEVICE



▲ WARNING

ALL RANGES CAN TIP, RESULTING IN PERSONAL INJURY. TIPPING RANGES CAN CAUSE BURNS FROM SPILLS, PERSONAL INJURY, AND/OR DEATH. INSTALL AND CHECK THE ANTI-TIP BRACKET USING THE INSTRUCTIONS AND TEMPLATE SUPPLIED WITH THE BRACKET.



- To prevent accidental tipping of the range, attach an approved anti-tip device to the floor. (See Installing the Anti-Tip Device in the Installation Instructions.) Check for proper installation by carefully tipping the range forward. The anti-tip device should engage and prevent the range from tipping over.
- If the range is pulled out away from the wall for any reason, make sure the anti-tip device is reengaged after the range has been pushed back into place.
- Follow the installation instructions found in the Installation Manual. Failure to follow these instructions can result in death, serious personal injury, and/or property damage.
- To prevent the range from tipping, do not step/sit/lean on the door or drawer.
- If the range is pulled out away from the wall for service or cleaning, make sure the anti-tip device is reengaged after the range has been pushed back into place. See "Installing the Anti-Tip Device" in the installation instructions.

Regulatory Notice

1. FCC Notice

CAUTION

FCC CAUTION: Any changes or modifications not expressly approved by the party responsible for compliance could void the user's authority to operate the equipment.

This device complies with Part 15 of FCC Rules. Operation is Subject to following two conditions:

- 1) This device may not cause harmful interference, and
- 2) This device must accept any interference received including interference that cause undesired operation.

For products available in the US/Canadian markets, only channels 1~11 are available. You cannot select any other channels.

FCC STATEMENT:

This equipment has been tested and found to comply within the limits for a Class B digital device, pursuant to part 15 of the FCC Rules. These limits are designed to provide reasonable protection against harmful interference in a residential installation.

This equipment generates, uses, and can radiate radio frequency energy and, if not installed and used in accordance with the instructions, may cause harmful interference to radio communications. However, there is no guarantee that interference will not occur in a particular installation. If this equipment does cause harmful interference to radio or television reception, which can be determined by turning the equipment off and on, the user is encouraged to try to correct the interference by one or more of the following measures:

- Reorienting or relocating the receiving antenna
- Increasing the separation between the equipment and receiver
- Connecting the equipment to an outlet that is on a different circuit than the radio or TV
- Consulting the dealer or an experienced radio/TV technician for help.

Regulatory Notice

FCC RADIATION EXPOSURE STATEMENT:

This equipment complies with FCC radiation exposure limits set forth for an uncontrolled environment. This equipment should be installed and operated so there is at least 8 inches (20 cm) between the radiator and your body. This device and its antenna(s) must not be co-located or operated in conjunction with any other antenna or transmitter.

2. IC Notice

The term “IC” before the radio certification number only signifies that Industry Canada technical specifications were met. Operation is subject to the following two conditions: (1) this device may not cause interference, and (2) this device must accept any interference, including interference that may cause undesired operation of the device.

This Class B digital apparatus complies with Canadian ICES-003. For products available in the US/Canadian markets, only channels 1~11 are available. You cannot select any other channels.

IC RADIATION EXPOSURE STATEMENT:

This equipment complies with IC RSS-102 radiation exposure limits set forth for an uncontrolled environment. This equipment should be installed and operated so there is at least 8 inches (20 cm) between the radiator and your body. This device and its antenna(s) must not be co-located or operated in conjunction with any other antenna or transmitter.

General safety instructions

This unit has been tested and found to comply with the limits for a class B digital device, pursuant to Part 18 of the FCC rules. These limits are designed to provide reasonable protection against harmful interference in a residential installation. This unit generates, uses and can radiate radio frequency energy and, if not installed and used in accordance with the instructions, may cause harmful interference to radio communications.

However, there is no guarantee that interference will not occur in a particular installation. If this unit does cause harmful interference to radio or television reception, which can be determined by turning the unit off and on, the user is encouraged to try to correct the interference by one or more of the following measures:

- Reorienting or relocating the receiving antennae.
- Increasing the distance between the unit and receiver.
- Connecting the equipment to an outlet that is on a different circuit than the radio or TV.

Key features

Bigger is better

With a capacity of 5.8 cubic feet, this Samsung gas oven range offers more space than many other leading brands in the United States and Canadian markets. The enhanced capacity means a better cooking experience.

A cooktop with 5 burners

Power burners, simmer burners, as well as a center oval burner provide flexible cooktop heat for a variety of cookware. The center oval burner delivers heat evenly over a large area, and provides the optimum temperatures for griddle cooking.

Enhanced convenience with easy maintenance

The Samsung gas oven range combines all the benefits of 3 separate home appliances - a gas range, a gas oven, and a storage drawer - to maximize customer convenience with its careful, stylish design.

Contents

Important safety information	7	Non-Cooking functions	38
Overview	14	Smart control	40
Layout	14	Maintenance	41
What's included	14	Cleaning	41
Control panel	15	Replacing the oven light	47
Before you start	16	Removing and re-installing the oven door	48
Display mode	16	Troubleshooting	49
Clock	16	Checkpoints	49
Kitchen timer	17	Information codes	55
Oven vent/cooling vent	17	Warranty	55
Cooktop	17	Open Source Announcement	57
Ignition	18		
Cookware	19		
Wok grate	19		
Griddle	20		
Dual Door™	21		
How to use the upper door	21		
How to use the full door	21		
Gas oven	22		
Single mode	22		
Twin mode	22		
Cooking mode	24		
Broiling	26		
Recipe guide	28		
Temperature setting guides	29		
Using the oven racks	30		
Cooking options	32		
Special features	35		
Changing option settings	38		

Important safety information

Read all instructions before using this appliance

- All electrical and gas equipment with moving parts can be dangerous. Please read the important safety instructions for this appliance in this manual. The instructions must be followed to minimize the risk of injury, death, or property damage.
- Save this manual. Please Do Not Discard.

Symbols used in this manual

WARNING

Hazards or unsafe practices that may result in severe personal injury or death.

CAUTION

Hazards or unsafe practices that may result in electric shock, personal injury, or property damage.

NOTE

Useful tips and instructions.

These warning icons and symbols are here to prevent injury to you and others. Please follow them explicitly. After reading this section, keep it in a safe place for future reference.

State of California Proposition 65 warning (US only)

WARNING : This product contains chemicals known to the State of California to cause cancer and birth defects or other reproductive harm.

Gas appliances can cause low-level exposure to Proposition 65 listed substances, including but not limited to, benzene, carbon monoxide, formaldehyde and soot, substances resulting from the incomplete combustion of natural gas or LP fuels.

Commonwealth of Massachusetts

- This product must be installed by a licensed plumber or gas fitter qualified or licensed by the State of Massachusetts. When using ball-type gas shut-off valves, you must use the T-handle type. Multiple flexible gas lines must not be connected in series.

General safety

WARNING

To reduce the risk of fire, electric shock, personal injuries, and/or death, observe the following precautions.

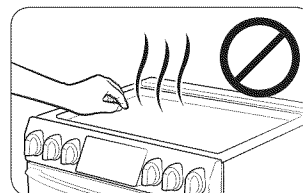

- **Do not touch** any part of the range, including but not limited to, oven burners, surface burners, or interior surfaces during or immediately after cooking.
- **Know** the location of the gas shut-off valve and how to shut it off.
- **Make sure** the anti-tip device is properly installed on the range. See the installation instructions for more information.
- **Do not let children near** the range. Do not let children go into the range or onto the range. Do not let children play with the range or any part(s) of the range. Do not leave children unattended in an area where the range is in use. For children's safety, we recommend utilizing the control/door lockout feature.
- **Remove** all packaging materials from the range before operating to prevent ignition of these materials. Keep all packaging materials out of children's reach. Properly dispose the packaging materials after the range is unpacked.

Important safety information

- **Do not store** any object of interest to children on the cooktop or backguard of the range. Children climbing on the range to reach items could be killed or seriously injured.
- **Do not operate** the range if the range or any part of the range is damaged, malfunctioning, or missing parts.
- **Do not use** the range as a space heater. Use the range for cooking only.
- **Do not use** oven cleaners or oven liners in or around any part of the oven.
- **Use** only dry pot holders. Pot holders with moisture in them can release steam and cause burns if they come in contact with hot surfaces. Keep pot holders away from open flames when lifting cookware. **Never use** a towel or bulky cloth in place of a pot holder.
- **Do not use** the range to heat unopened food containers.
- **Do not strike** the oven glass.
- When disposing of the range, **cut off** the power cord and **remove** the door to prevent children and animals from getting trapped.
- **Unplug** or **disconnect** power before servicing.
- **Make sure** all meat and poultry is cooked thoroughly. Meat should always be cooked to an internal temperature of 160 °F (71 °C). Poultry should always be cooked to an internal temperature of 180 °F (82 °C).
- Do not make any attempt to operate the electric ignition oven during an electrical power failure.
- Keep the appliance area clear and free of combustible materials, gasoline, and other flammable vapors and liquids.
- **Teach** children not to touch or play with the controls or any part of the range. We recommend you utilize the control / door lockout feature to reduce the risk of misuse by children.

Fire safety

⚠ WARNING

To reduce the risk of fire, electric shock, personal injuries, and/or death, observe the following precautions.

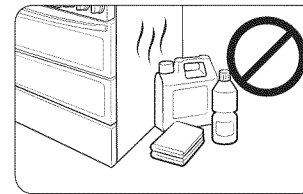

- **Do not store, place, or use** flammable or combustible materials such as paper, plastic, pot holders, linens, curtains, gasoline or other flammable vapors or liquids near the range.
- **Do not wear** loose fitting or hanging garments while using the range.
- To avoid grease buildup, **regularly clean** the vents.
- **Do not let** pot holders or other flammable materials touch a heating element. Do not use a towel or other bulky cloths in place of a pot holder.
- **Do not use** water on a grease fire. To put out a grease fire, turn off the heat source and smother the fire with a tight-fitting lid or use a multipurpose dry chemical or foam-type fire extinguisher.
- If a grease fire should occur in the oven, **turn off the oven** by pressing the **OFF/CLEAR** pad. **Keep** the oven door closed until the fire goes out. If necessary, **use** a multipurpose dry chemical or foam-type **fire extinguisher**.
- **Do not heat** unopened food containers. The buildup of pressure may cause the containers to burst and result in injury.
- **NEVER use** this appliance as a space heater to heat or warm the room. Doing so may result in carbon monoxide poisoning and overheating of the oven. Do not use the oven for storage. Paper and other flammable items stored in the oven can ignite.
- **Do not** leave items such as paper, cooking utensils or food in the oven when not in use. Items stored in an oven can ignite.
- **Do not put** any combustible material or items around the range.

Gas safety

⚠ WARNING

To reduce the risk of fire, electric shock, personal injuries, and/or death, observe the following precautions.

If you smell gas:

- Close the valve and do not use the range.
- Do not light a match, candle, or cigarette.
- Do not turn on any gas or electric appliances.

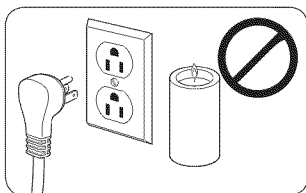

- Do not touch any electrical switches or plug a power cord into an outlet.
- Do not use any phone in your building.
- Evacuate the room, building, or area of all occupants.
- Immediately call your gas supplier from a neighbor's phone. Follow the gas supplier's instructions.
- If you cannot reach your gas supplier, call the fire department.

Checking for gas leaks

- Leak testing of the appliance must be conducted according to the manufacturer's instructions. Do not use a flame to check for gas leaks. Use a brush to spread a soapy water mixture around the area you are checking. If there is a gas leak, you will see small bubbles in the soapy water mixture at the leak point.

Electrical and grounding safety

⚠ WARNING

To reduce the risk of fire, electric shock, personal injuries, and/or death, observe the following precautions.

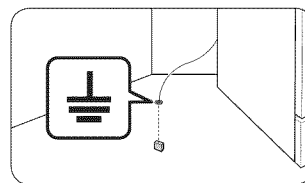

- Plug the range into a grounded 3-prong outlet.
- Do not remove the ground prong.
- Do not use an adapter or an extension cord.
- Do not use a damaged power plug, power cord, or loose power outlet.
- Do not modify the power plug, power cord, or power outlet in any way.
- Do not put a fuse in a neutral or ground circuit.
- Use a dedicated 120-volt, 60-Hz, 20-amp, AC electrical circuit with a time-delay fuse or circuit breaker for this range. Do not plug more than one appliance into this circuit.
- Do not connect the ground wire to plastic plumbing lines, gas lines, or hot water pipes.
- This range must be Earth grounded. In the event of a malfunction or breakdown, grounding will reduce the risk of electrical shock by providing a path for the electric current. This range is equipped with a cord having a grounding plug. The plug must be firmly plugged into an outlet that is properly installed and grounded in accordance with the local codes and ordinances. If you are unsure whether your electrical outlet is properly grounded, have it checked by a licensed electrician.
- The range is supplied with a 3-pronged grounded plug. This cord must be plugged into a mating, grounded 3-prong outlet that meets all local codes and ordinances. If codes permit the use of a separate ground wire, we recommend that a qualified electrician determine the proper path for this ground wire.
- Electrical service to the range must conform to local codes. Barring local codes, it should meet the latest ANSI/NFPA No. 70 - Latest Revision (for the U.S.) or the Canadian Electrical Code CSA C22.1 - Latest Revisions.
- It is the personal responsibility of the range owner to provide the correct electrical service for this range.

Important safety information

Installation safety

⚠ WARNING

To reduce the risk of fire, electric shock, personal injuries, and/or death, observe the following precautions.

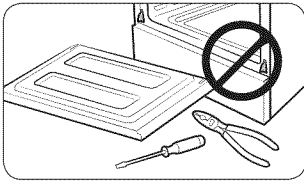

- Have your range installed and properly grounded by a **qualified installer**, in accordance with the installation instructions. Any adjustment and service should be performed only by qualified gas range installers or service technicians.

- **Do not attempt** to service, modify, or replace your range or any part of your range unless it is specifically recommended in this manual. All other service should be referred to a qualified technician.
- Always use new flexible connectors when installing a gas appliance. **Do not use** old flexible connectors.
- **Make sure** the anti-tip device is properly installed on the range. See the installation instructions for more information.
- Due to the size and weight of the range, have **two or more people** move the range.
- **Remove** all tape and packaging materials.
- **Remove** all accessories from the cooktop, oven, and/or lower drawer. Grates and griddles are heavy. Use caution when handling them.
- **Make sure** no parts came loose during shipping. Do not install in an area exposed to dripping water or outside weather conditions.
- **Make sure** your range is correctly installed and adjusted by a qualified service technician or installer for the type of gas (natural or LP) you will use. For your range to utilize LP gas, the installer must replace the 5 surface burner orifices and 2 oven orifices with the provided LP orifice set, and reverse the GPR adapter. These adjustments must be made by a qualified service technician in accordance with the manufacturer's instructions and all codes and requirements of the authority having jurisdiction. The qualified agency performing this work assumes the gas conversion responsibility.

- Installation of this range must conform with local codes or, in the absence of local codes, with the National Fuel Gas Code, ANSI Z223.1/NFPA.54, latest edition. In Canada, installation must conform with the current Natural Gas Installation Code, CAN/CGA-B149.1, or the current Propane Installation Code, CAN/CGA-B149.2, and with local codes where applicable. This range has been design-certified by ETL according to ANSI Z21.1, latest edition, and Canadian Gas Association according to CAN/CGA-1.1, latest edition.

Location safety

⚠ WARNING

To reduce the risk of fire, electric shock, personal injuries, and/or death, observe the following precautions.

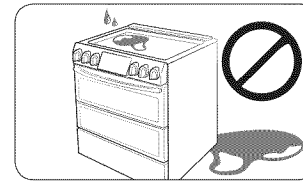

- This range is for indoor, household use only. **Do not install** the range in areas exposed to the weather and/or water.
- **Do not install** the range in a place which is exposed to a strong draft.
- Select a level, well-constructed floor that can support the range's weight. Synthetic flooring, such as linoleum, must withstand 180 °F (82 °C) temperatures without shrinking, warping, or discoloring. **Do not install** the range directly over interior kitchen carpeting unless a sheet of ¼ inch plywood or a similar insulator is placed between the range and carpeting.
- Select a location where a grounded, 3-prong outlet is easily accessible.
- If the range is located near a window, **do not hang** long curtains or paper blinds on that window.
- For the range to ventilate properly, make sure the range's vents are not blocked, and that there is enough clearance at the top, back, sides, and underneath the range. The vents allow the necessary exhaust for the range to operate properly with correct combustion.
- **Make sure** the wall coverings around the range can withstand heat up to 200 °F (93 °C) generated by the range.

- Cabinet storage above the surface of the range should be avoided. If cabinet storage above the range is necessary, allow a minimum clearance of 40 inches (102 cm) between the cooking surface and the bottom of the cabinets or install a range hood that projects horizontally a minimum of 5 inches (12.7 cm) beyond the bottom of the cabinets.
- **Locate** the range out of kitchen traffic paths and drafty locations to prevent poor air circulation.
- If the range is located near a window, **NEVER** hang long curtains or paper blinds on that window. They could blow over the surface burners and ignite, causing a fire hazard.

Cooktop safety

▲ WARNING

To reduce the risk of fire, electric shock, personal injuries, and/or death, observe the following precautions.

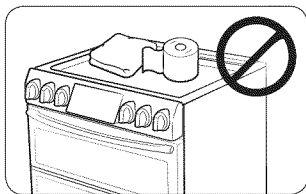

- **Make sure** all burners are off when you are not using the range.
- **Do not use** aluminium foil to line the grates or any part of the cooktop. This can cause carbon monoxide poisoning. Aluminum foil linings may also trap heat, causing a fire hazard. **Do not leave** burners unattended on medium or high heat settings.
- Before igniting the burners, **make sure** all burner caps are properly in place and all burners are level.
- **Always use** the LITE position when igniting the burners and make sure the burners have ignited. If ignition fails, turn the knob to OFF and wait until the gas has dissipated.
- When you set a burner to simmer, **do not turn** the knob quickly. Make sure the flame stays on.
- **Do not place** any objects other than cookware on the cooktop.
- This cooktop is designed for use with a wok or wok ring attachment.

- To flame food, you must have a ventilation hood. When you flame food, the hood must be on.
- Before removing or changing cookware, turn off the burners.
- Remove food and cookware immediately after cooking.
- Before removing any parts of the burner for cleaning, make sure the range is off and completely cool.
- After cleaning the burner spreader, make sure it is completely dry before re-assembling.
- **Make sure** the spark mark on the dual burner spreader is placed beside the electrode when it is assembled.
- To avoid carbon monoxide poisoning, do not pour water into the cooktop well while cleaning.
- Select cookware that is designed for range top cooking. Use cookware that is large enough to cover the burner grates. Adjust the burner flames so that the flames do not extend beyond the bottom of the cookware.
- To avoid cookware discoloration, deformity, and/or carbon monoxide poisoning, do not use cookware that is substantially larger than the grate.
- Make sure cookware handles are turned to the side or rear of the cooktop, but not over other surface burners.
- Stand away from the range while frying.
- Always heat frying oils slowly, and watch as they heat. If you are frying foods at high heat, carefully watch during the cooking process. If you are going to use a combination of fats or oils when frying, mix them together before heating.
- Use a deep-fryer thermometer whenever possible. This prevents overheating the fryer beyond the smoking point.
- Use a minimum amount of oil when shallow pan-frying or deep-frying. Avoid cooking unthawed food or food with excessive amounts of ice.

Important safety information

- Before moving cookware full of fats or oils, make sure it has completely cooled.
- To prevent delayed eruptive boiling, always allow heated liquids to stand at least 20 seconds after you have turned off the burner so that the temperature in the liquid can stabilize. In the event of scalding, follow these first aid instructions:
 1. Immerse the scalded area in cool or lukewarm water for at least 10 minutes.
 2. Do not apply any creams, oils, or lotions.
 3. Cover with a clean, dry cloth.

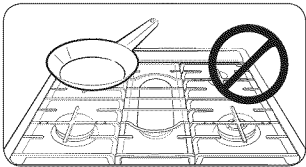

- Place pots in the center of the grate. Do not place a pot larger than 9" in diameter on the rear burners. If you place an oversized pot in the wrong position, it might disrupt necessary air circulation and make the flame on the burner sputter and burn inefficiently.

- **Do not wear** loose or hanging garments when using the range. They could ignite and burn you if they touch a surface burner.
- **Never leave** plastic items on the cooktop. Hot air from the vent can melt or ignite plastic items or cause a build up of dangerous pressure in closed plastic containers.
- **Do not place** portable appliances, or any other object other than cookware on the cooktop. Damage or fire could occur if the cooktop is hot.
- **Always make sure** foods being fried are thawed and dry. Moisture of any kind can cause hot fat to bubble up and over the sides of the pan.
- **Always make sure** the controls are OFF and the grates are cool before you remove them to prevent any possibility of being burned.
- **Do not put** any combustible material or items around the range.
- **Take care** that your hands do not touch the burners when they are on. Turn off the burners when you change a pan or pot.
- To warm liquid such as sauces, stir it while warming.

Oven safety

⚠ WARNING

To reduce the risk of fire, electric shock, personal injuries, and/or death, observe the following precautions.

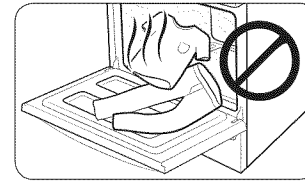

- **Do not use** the oven for non-cooking purposes such as drying clothes or storage. Use the oven for cooking only.
- **Make sure** the inner portion of the split oven-rack is in the proper position within the outer rack.
- **Make sure** the oven racks are placed on the same level on each side.
- **Do not damage, move, or clean** the door gasket.
- **Do not spray** water on the oven glass while the oven is on or just after you have turned it off.
- **Do not use** aluminium foil or foil liners anywhere in the oven. Do not use aluminium foil or similar material to cover any holes or passages in the oven bottom or to cover an oven rack. This can cause carbon monoxide poisoning. Aluminum foil linings may also trap heat, causing a fire hazard.
- Stand away from the oven when opening the oven door.
- Keep the oven free from grease buildup.
- When repositioning the oven racks, **make sure** the oven is completely cool.
- **Only use** cookware that is recommended for use in gas ovens.
- To avoid damaging the burner control knobs, always bake and/or broil with the oven door closed.
- **Do not broil** meat too close to the burner flame. Trim excess fat from meat before cooking.
- When using cooking or roasting bags in the oven, follow the manufacturer's directions.
- **NEVER cover** any slots, holes, or passages in the oven bottom or cover an entire rack with material such as aluminum foil. Doing so blocks air flow through the oven and may cause carbon monoxide poisoning. Aluminum foil linings may also trap heat, causing a fire hazard.

Storage drawer safety

⚠ WARNING

To reduce the risk of fire, electric shock, personal injuries, and/or death, observe the following precautions.

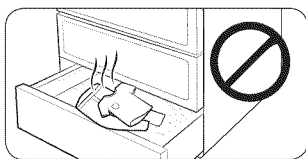

- **Do not use** the drawer for non-cooking purposes such as drying clothes or storage. Use the drawer for cooking purposes only.
- **Do not touch** the interior drawer surface or heating element. These surfaces may be hot and could burn you.

- To avoid steam burns, use caution when opening the drawer.
- **Do not use** aluminium foil to line the drawer.
- **Do not put** the drawer in the oven. Do not put the drawer in the oven during a self-cleaning cycle.
- **Do not leave** containers of fat drippings in or near the drawer.

Self-cleaning oven safety

⚠ WARNING

To reduce the risk of fire, electric shock, personal injuries, and/or death, observe the following precautions.

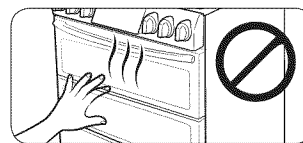

- The self-cleaning feature operates the oven at temperatures high enough to burn away food soils in the oven. The range is extremely hot during a self-cleaning cycle. **Do not touch** any surfaces of the range during a self-cleaning cycle.
- Keep children away from the oven during a self-cleaning cycle.
- Before starting a self-cleaning cycle, **remove** all racks, cookware, and utensils from the oven. Only porcelain-coated oven racks may be left in the oven.
- Before starting a self-cleaning cycle, wipe grease and food soils from the oven.
- **Do not** put the lower drawer into the oven cavity when you run a self-cleaning cycle.
- When opening the door after a self-cleaning cycle, stand away from the oven.
- If the self-cleaning cycle malfunctions, turn off the oven, disconnect the power supply, and contact a qualified service technician.

Overview

Layout

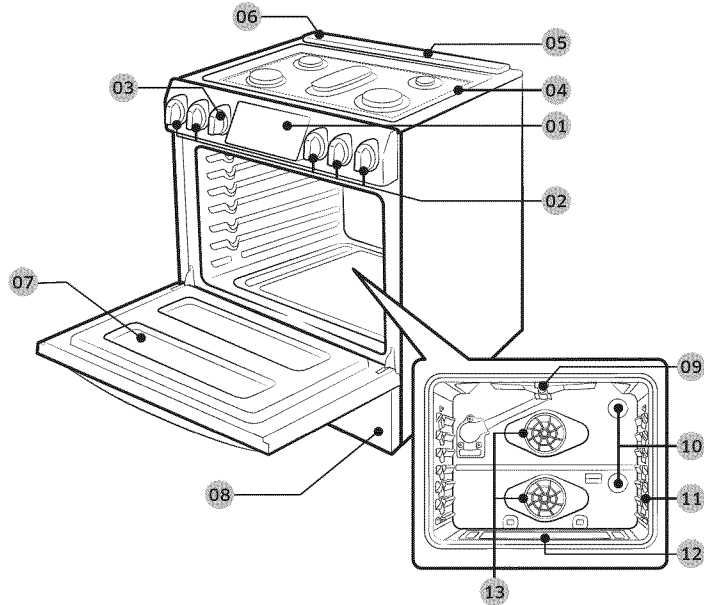

- | | | |
|--|--|-----------------------------------|
| 01 Touch display | 02 Surface burner knobs (5 pcs) | 03 Oven lights Knob (1 pc) |
| 04 Surface burners | 05 Oven vents | 06 Cooling vent |
| 07 Removable dual oven door | 08 Storage drawer | 09 Broil oven burner |
| 10 Oven light (2 locations) | 11 Oven rack system | 12 Bake oven burner |
| 13 Convection fan / Upper convection heater | | |

NOTE

If you need a part marked with an asterisk (*), you can buy it from the Samsung Contact Center (1-800-726-7864).

What's included

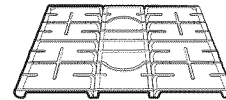

Surface burner grates (3) *



Surface burners and caps (5) *

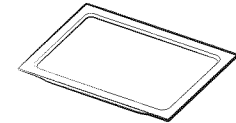

Smart divider (1) *

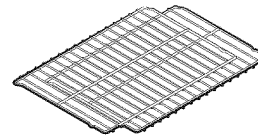

Flat rack (2) *

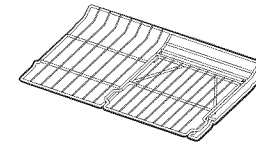

Split rack (1) *

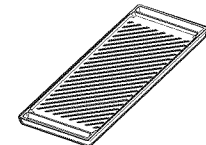

Griddle (1) *

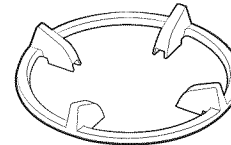

Wok grate (1) *

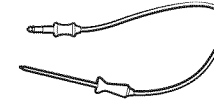

Temp probe (1) *

NOTE

If you need an accessory marked with an asterisk (*), you can buy it from the Samsung Contact Center (1-800-726-7864).

Control panel

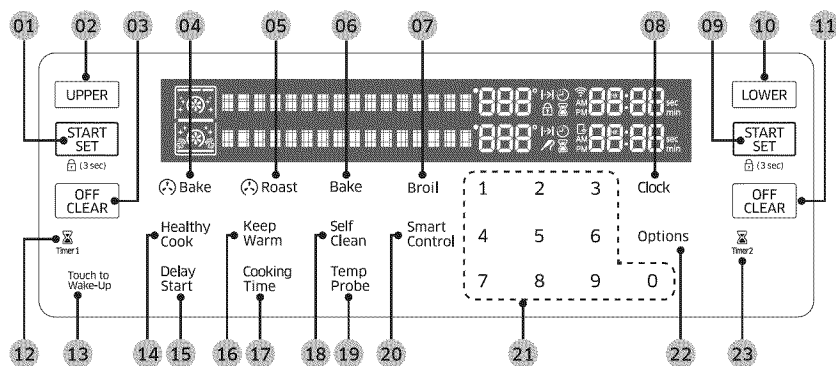

- 01 START/SET:** Start a function or set the time.
- 02 UPPER:** Select the upper cooking cavity.
- 03 OFF/CLEAR:** Cancel the current operation but not the timer.
- 04 Convection Bake:** Activate convection baking for large amounts of food on multiple racks.
- 05 Convection Roast:** Activate convection roasting for large cuts of meat.
- 06 Bake:** Bake food evenly using the lower oven burner.

- 07 Broil:** Broil food using the upper oven burner only.
- 08 Clock:** Set the clock time.
- 09 START/SET(Lock):** Start a function or set the time. Lock the control panel and the door to prevent accidents.
- 10 LOWER:** Select the lower cooking cavity.
- 11 OFF/CLEAR:** Cancel the current operation but not the timer.
- 12 Timer1:** Activate or deactivate the timer (upper).

13 Touch to Wake-Up: Activate the control panel display.

14 Healthy Cook: Bring up the Healthy Cook recipes that are specially designed for different food types.

15 Delay Start: Set the oven to start at a certain time.



16 Keep Warm: Keep cooked food warm at lower temperatures between 150 °F and 200 °F (66 °C and 93 °C).

17 Cooking Time: Set the cooking time.

18 Self Clean: Burn off food residues in the oven at very high temperatures.

19 Temp Probe: Activate the temperature probe mode.

20 Smart Control: Activates the Easy-connection.

- : When you use the Easy connection, this icon appears in the display.
- : When the oven is connected to Wifi, this icon appears in the display.

21 Numbers: Use to set the time, temperature, or preset.

22 Options: Display the 9 user options available.

23 Timer2: Activate or deactivate the timer.(Lower)



Before you start

You should know about the following features and components before you use your range for the first time.

Display mode

Sleep

After 2 minutes of inactivity (or 1 minute when the oven is in standby mode), the control panel enters Sleep mode. In Sleep mode, the control panel is inactive, displaying only the time, until it is reactivated by the user.

Wake-Up



To activate the control panel, press **Touch to Wake-Up**. User preferences are available in this mode including the timer, oven light, and/or control lock.

Before you start

Clock

You must set the clock correctly to ensure the automatic features work properly. This product supports two time formats: 12-hour (default) and 24-hour.

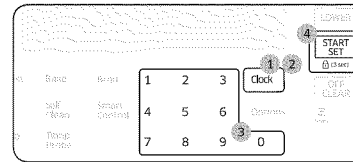

To set the clock time

1. Press the **Clock** pad.
2. To select AM/PM, press the **Clock** pad again.
3. Enter the current time using the number pad.
4. Press the **START/SET** pad to confirm the settings.

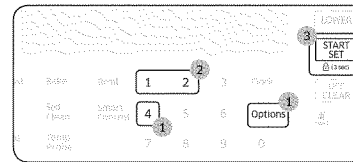

To change the time format (12hr/24hr)

1. Press the **Options** pad, and then **4** on the number pad.
2. Press **1** for the 12-hour format or **2** for the 24-hour format.
3. Press the **START/SET** pad.

NOTE

You can set/change the clock or the kitchen timer before you start a cooking mode or while most cooking modes are operating. However, you cannot set or change the time if a time based function is operating (Time Bake, for example) or the Sabbath option is enabled.



Kitchen timer

The kitchen timer gives you an extra timer you can use to time cooking tasks such as boiling eggs. It does not, however, start or stop any cooking operation. You can set the timer from 1 minute to 9 hours and 59 minutes.

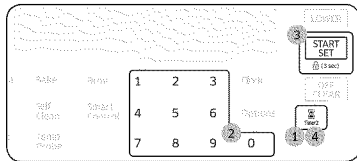

1. Press the **Timer1** or **Timer2** pad.
2. Enter a desired time using the number pad.
3. When done, press the **START/SET** or **Timer** pad.
4. To cancel the Timer settings, press the **Timer** pad again.
5. When the set time elapses, the oven beeps and displays the "End" message. Press the **Timer** pad to delete the message.

Oven vent/cooling vent

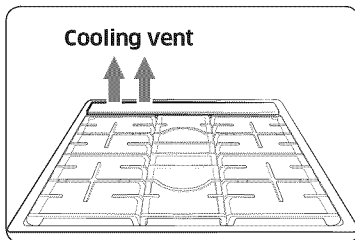

- The cooling vents are located at the back of the oven range. Proper air circulation prevents combustion problems and ensures good performance.
- Do not block the vent or its surroundings.
 - Use caution when placing items near the vent. Hot steam can cause them to overheat or melt.

Cooktop

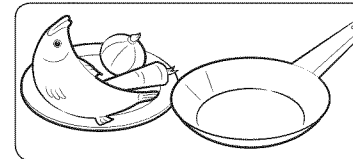

STEP 1

Put all ingredients into a cooking container (pan, pot, etc).

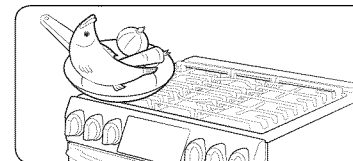

STEP 2

Place the container on a surface burner.

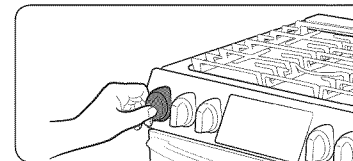

STEP 3

Ignite the surface burner.
An LED on the control knob illuminates when you turn the control knob.

Cooktop

Gas burners

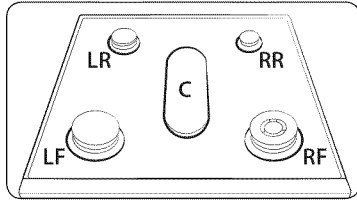

Each burner has a corresponding knob that lets you to set the flame level from LO to HI. In addition, each burner knob has a Lite setting. Turning a knob to Lite ignites the corresponding burner. The burner indicators are located above each knob and show which burner the knob controls. Each burner is designed for specific cooking purposes. See the table below.

Position	Purpose	Food type	Characteristics
Right Front (RF) 22,000 BTU	Power heating	Boiling food	Maximum output
Right Rear (RR) 5,000 BTU	Low simmering	Chocolate, casseroles, sauces	Delicate food that requires low heat for a long time
Center (C) 9,500 BTU	Grilling/Griddling	Pancakes, hamburgers, fried eggs, hot sandwiches	General-purpose cooking
Left Front (LF) 15,000 BTU	Quick heating	General	General-purpose cooking
Left Rear (LR) 9,500 BTU	General heating/ Low simmering	General food, casseroles, tomato sauce*	General-purpose cooking

* Tomato sauce needs to be stirred while it is simmering.

Ignition

⚠ CAUTION

The knob LED indicates if a burner knob has been turned on. It does not indicate if the burner flame is on. Check for an actual flame, whether the knob LED is on or off.

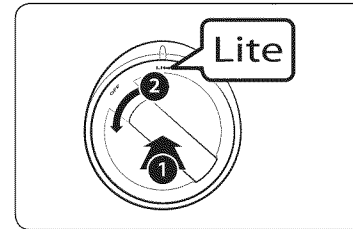

Make sure all surface burners are properly installed. To light a burner:

1. Push in the control knob, and then turn it to the Lite position. The knob LED is on and you will hear a “clicking” sound indicating the electronic ignition system is working properly.
2. After the surface burner lights, turn the control knob to shift it out of the Lite position and turn off the electronic ignition system.
3. Turn the control knob to adjust the flame level.

Manual ignition

If there is a power failure, you can ignite the burner manually. Use caution when doing this.

1. Hold a long gas grill lighter to the surface burner you want to light.
2. Push in the control knob for that burner, and then turn it to the Lite position. Turn on the grill lighter to ignite the burner.
3. After the burner is lit, turn the control knob to adjust the flame level.

Flame level

The flames on the burners should always stay under the cookware, and should not extend beyond the cookware bottom at any time.

⚠ WARNING

- Flames larger than the cookware bottom may result in a fire or physical injury.
- When you set a burner to simmer, do not turn the burner knob quickly. Watch the flame to make sure it stays on.

- After turning on a surface burner, make sure that the burner has ignited even if the knob LED is on. Adjust the level of the flame by turning the burner knob.
- Always turn off the surface burner controls before removing cookware. All surface burner controls should be turned OFF when you are not cooking.
- Always turn the burners off before you go to sleep or go out.
- If you smell gas, turn off the gas to the range and call a qualified service technician. NEVER use an open flame to locate a leak.
- If the LED on the control knob doesn't go on when the surface burner has ignited, call a qualified service technician.
- If the knob LED illuminates, but the surface burner does not ignite, turn off the control knob immediately.

Cookware

Requirements

- Flat bottom and straight sides
- Tight-fitting lid
- Well-balanced with the handle weighing less than the main portion of the pot or pan.

Material characteristics

- **Aluminum:** An excellent heat conductor. Some types of food may cause the aluminum to darken. However, anodized aluminum cookware resists staining and pitting.
- **Copper:** An excellent heat conductor but discolors easily.
- **Stainless steel:** A slow heat conductor with uneven cooking performance but is durable, easy to clean, and resists staining.
- **Cast-Iron:** A poor conductor but retains heat very well.
- **Enamelware:** Heating characteristics depend on the base material.
- **Glass:** A slow heat conductor. Use only glass cookware that is specified for range top cooking or oven use.

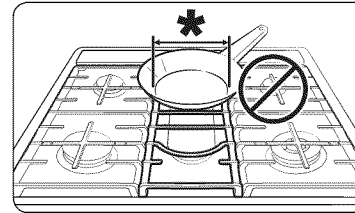

Size limitations

⚠ CAUTION

- Do not place a small pan or pot with a bottom diameter of about 6 inches or less on the center grate. This cookware may tip over. Use the rear burners for this small-sized cookware.

* : 6 inches or less

- Always make sure cookware handles are turned to the side or rear of the cooktop and not over other surface burners. This will minimize the chance of burns, spillovers, and the ignition of flammable materials that can be caused if pots or pans are bumped accidentally.
- When using glass cookware, make sure it is designed for range top cooking.
- Never leave plastic items on the cooktop. Hot air from the vent can melt or ignite plastic items or cause a building up of dangerous pressure in closed plastic containers.
- Make sure you hold the handle of a wok or a small one-handed pot while cooking.

Wok grate

Woks are often used for stir frying, pan frying, deep frying, and poaching. The provided wok grate supports 12" to 14" woks.

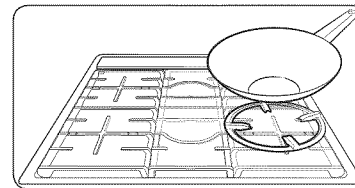

1. Turn off all burners, and wait until the grates completely cool down.
2. Place the wok grate on either side grate.
3. Put a wok on the wok grate. Make sure the wok settles on the wok grate.
4. Turn on the burner, and adjust the flame level as appropriate.



Cooktop

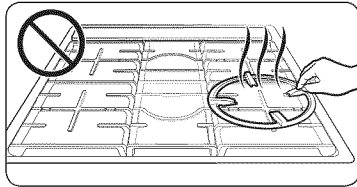

⚠ CAUTION

- Do not remove the wok grate until the cooktop grates, surfaces, and wok grate completely cool down.
- When you use the wok with the cooktop or when the oven is on, the wok grate on the cooktop may become very hot. Use oven gloves when placing or removing the wok grate.
- Do not use pans with a flat bottom or woks with a diameter less than the wok ring diameter. The pan or wok may tip over.
- Do not use an oversized pan. The burner flames may spread out, causing damage nearby.
- Do not use the wok grate and the griddle at the same time.
- This cooktop is not designed to flame foods or cook with a wok or wok ring attachment. If foods are flamed, they should only be flamed under a ventilation hood that is on.

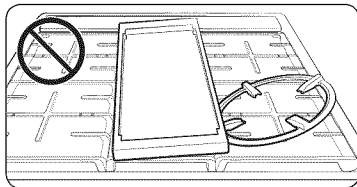

Griddle

The removable coated griddle provides an extra cooking surface. This is useful especially when cooking meat, pancakes, or other foods requiring a large cooking area.

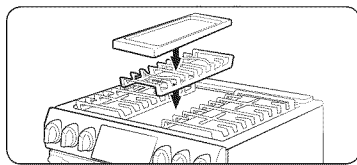

The griddle can be used only with the center burner on the center grate. Use caution when putting the griddle on the center grate.

In most cases, you should preheat the griddle before cooking. See the table below.

Type of Food	Preheating Time	Preheat setting	Cook setting
Pancakes	5-10 min.	HI	MED-HI
Hamburgers	5-10 min.	HI	HI
Fried Eggs	5-10 min.	HI	MED-LO
Bacon	5-10 min.	HI	HI
Breakfast Sausages	5-10 min.	HI	HI
Grilled Cheese Sandwich	4-8 min.	HI	HI

⚠ CAUTION

- Do not remove the griddle until the cooktop grates, surfaces, and griddle itself cool down.
- If you leave the griddle on the cooktop, it may become very hot when you use the cooktop or oven. Use oven gloves when placing or removing the griddle.
- Do not overheat the griddle. This can damage the coating of the griddle.
- Do not use metal utensils that can damage the griddle surface.
- Do not use the griddle for other purposes, for example, as a cutting board or a storage shelf.
- Do not cook excessively greasy foods. The grease may spill over.
- The griddle is quite heavy because it is made of cast iron. Use both hands when placing or removing the griddle.

📖 NOTES

- You may need to adjust heat settings for the griddle over time.
- The griddle may discolor over time as it becomes seasoned with use.
- Do not let rust remain on the griddle. If rust appears on the griddle, remove it as soon as possible.



Dual Door™

This oven has a unique Dual Door™ that is hinged in the middle. If you have inserted the Smart Divider and divided the oven in two (so it is in Twin Mode), you only need to open the top half to access the upper cavity. When you're using the Flex Duo™ capability, you can access the top oven space much more easily and with greater energy efficiency.

How to use the upper door

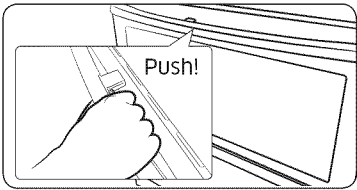

1. Hold the handle and the lever. Press the lever to release the door latch, and then pull the handle.

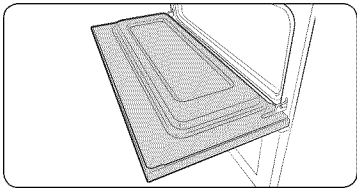

2. This will open only the upper door as shown.

How to use the full door

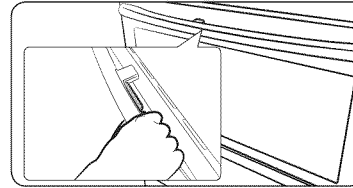

1. Hold the lever-less area of the handle, and then pull.

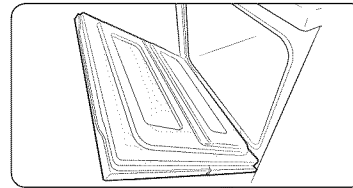

2. This will open the whole door as shown.

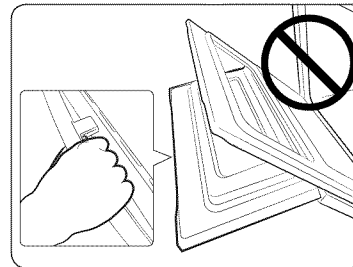

⚠ CAUTION

- When opening the whole door, make sure to grasp the handle by the lever-less portion. If you press the lever halfway through opening the whole door, the upper door may open, causing physical injury.

📖 NOTES

- Do not put heavy objects on, or apply excessive force, to the upper door.
- Do not let children play with or on the upper door.

Gas oven

Single mode

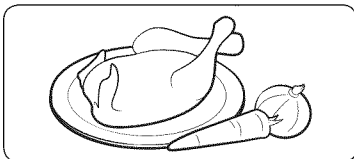

STEP 1

Put all ingredients in a heat-safe container.

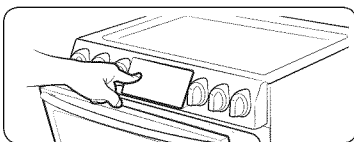

STEP 2

Select a cooking mode, and then start preheating.

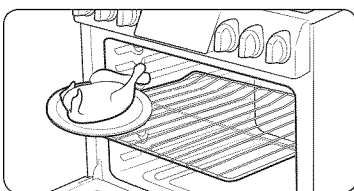

STEP 3

Place the container on a rack.

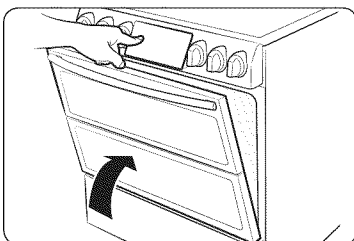

STEP 4

Close the door and start cooking.

NOTES

- The cooling fan automatically runs for a certain amount of time after cooking is complete.
- There can be slight popping sound during oven cooking. This sound may occur during the normal oven burner cycling, when the oven burner flame is extinguished.

Twin mode

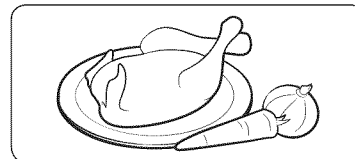

STEP 1

Put all ingredients in a heat-safe container.

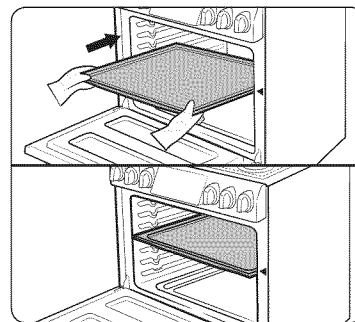

STEP 2

Insert the Smart Divider into the 4th rack position and push in until the range beeps.

CAUTION

When the Smart Divider is properly inserted, the “-” icon appears.

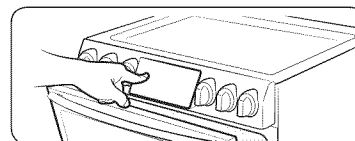

STEP 3

Select a cooking mode, and then start preheating.

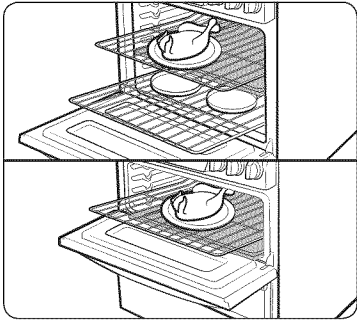

STEP 4

Arrange food containers on the racks.

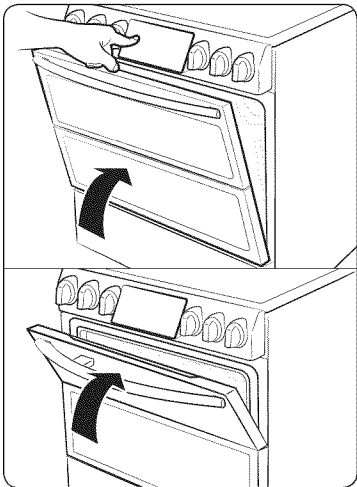

STEP 5

Close the door and start cooking.

NOTES

- To use Twin mode operation, insert the Smart Divider.
- The cooling fan automatically runs for a certain amount of time after cooking is complete.
- When you are not using the Smart Divider, store it at room temperature.
- Handle the Smart Divider with both hands.
- Use oven gloves when inserting or removing the Smart Divider.
- Please note that the time for the upper and lower ovens to preheat is different.
- Do not put food containers directly on the Smart Divider for cooking purposes.

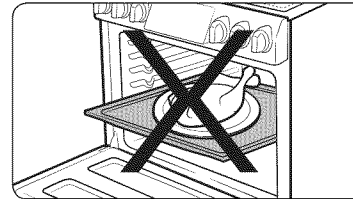

CAUTION

Range displays “-dc-”

- Check the Smart Divider to see if it is installed correctly.
- Do not insert/remove the Smart Divider during cooking.

Gas oven

Cooking mode

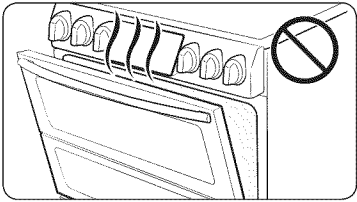

- Make sure to close the door before you start cooking.
- If you leave the door open for 20-30 seconds while the oven is in convection baking/roasting, baking, or broiling modes, the oven burner shuts off. To restart the burner, close the door.

Baking and roasting (Single mode)

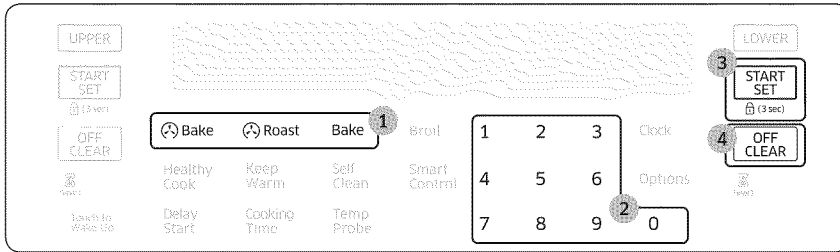

1. Press the **Bake**, **Roast**, or **Bake** pad.
2. If necessary, use the number pad to change the default temperature (350 °F). You can set the oven to any temperature from 175 °F to 550 °F.
3. Press the **START/SET** pad.
 - The oven preheats until it reaches the temperature you set.
 - It beeps six times when the temperature reaches you set.
 - When preheating is complete, place the food in the oven, and then close the door.
4. When cooking is complete, press the **OFF/CLEAR** pad, and then take out the food.

NOTE

To change the temperature during cooking, repeat steps 1 through 3 above.

Baking and Roasting (Twin mode upper)

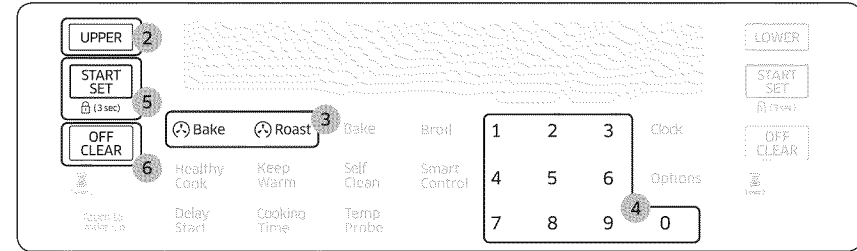

1. Insert the Smart Divider into the cavity.
2. Press the **UPPER** pad.
3. Press the **Bake** or **Roast** pad.
4. If necessary, use the number pad to change the default temperature (350 °F). You can set the oven to any temperature from 175 °F to 480 °F.
5. Press the **START/SET** pad.
 - The oven preheats until it reaches the temperature you set.
 - It beeps six times when the temperature reaches you set.
 - When preheating is complete, place the food in the upper oven, and then close the door.
6. When cooking is complete, press the **OFF/CLEAR** pad.

Baking (Twin mode lower)

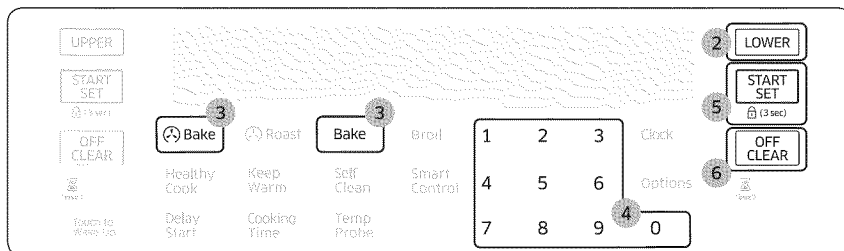

1. Insert the Smart Divider into the cavity.
2. Press the **LOWER** pad.
3. Press the **Bake** or **Bake** pad.
4. If necessary, use the number pad to change the default temperature (350 °F). You can set the oven to any temperature from 175 °F to 480 °F.
5. Press the **START/SET** pad.
 - The oven preheats until it reaches the temperature you set.
 - It beeps six times when the temperature reaches you set.
 - When preheating is complete, place the food in the lower oven, and then close the door.
6. When cooking is complete, press the **OFF/CLEAR** pad.

NOTE

Your oven has different temperature setting ranges when you use the upper oven and lower oven simultaneously. See "Temperature setting guides" on page 29 for details.

Convection cooking

The convection fan at the back of the oven circulates hot air evenly throughout the oven cavities so that food is evenly cooked and browned in less time than with regular heat.

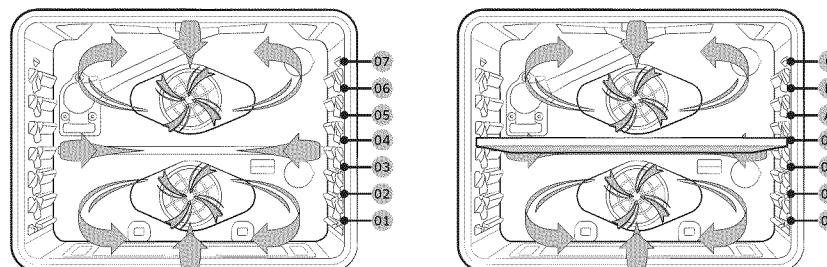

NOTE

When using convection cooking, always pre-heat the oven for the best results.

Convection baking

- Ideal for foods being cooked using multiple racks.
- Good for large quantities of food.
- Provides the best performance for cookies, biscuits, brownies, cupcakes, cream puffs, sweet rolls, angel food cake, and bread.
- Cookies bake best when cooked on flat cookie sheets.
- When convection baking using a single rack, place the rack in rack position 3 or 4. (In Twin mode, position A or 1)
- When convection baking using two racks, place the racks in positions 2 and 5 (Cakes, Cookies). When convection baking using three racks, place the racks in position 2, 4 and 6.
- The oven automatically adjusts the temperature for convection baking.

Gas oven

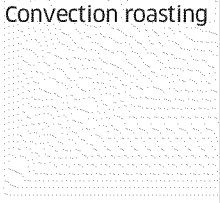
 <p>Convection roasting</p>	<ul style="list-style-type: none"> • Good for larger, tender cuts of meat, uncovered. • For best performance, place a broiler pan and grid under the meat or poultry. The pan catches grease spills and the grid prevents grease spatters. • Heated air circulates over, under, and around the food. Meat and poultry are browned on all sides as if they were cooked on a rotisserie.
---	---

Broiling

Broiling uses the oven broil burner at the top of the oven to cook and brown food. Meat or fish must be put on a broiling grid in a broiling pan. Preheating for 5 minutes before broiling is recommended.

Broiling (Single mode)

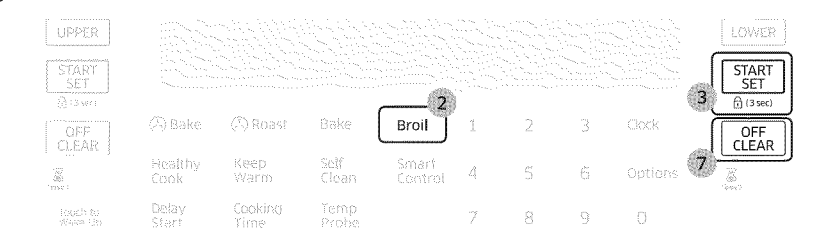

1. Put food on a broiling grid in a broiling pan.
2. Press the **Broil** pad once for high temperature broiling or twice for low.
3. Press the **START/SET** pad to start the broiler.
4. Let the oven pre-heat for 5 minutes.
5. Place the pan on the desired rack, and then close the oven door.
6. When one side of the food is browned, turn it over, close the oven door, and start cooking the other side.
7. When cooking is complete, press the **OFF/CLEAR** pad.

NOTE

Make sure to close the door before you start cooking.

Broiling (Twin mode)

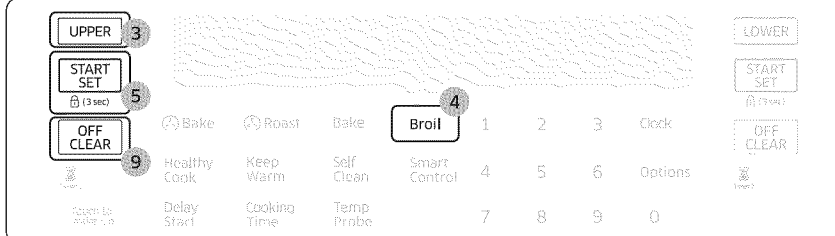

1. Insert the Smart Divider into the cavity.
2. Put food on a broiling grid in a broiling pan.
3. Press the **UPPER** pad.
4. Press the **Broil** pad once for high temperature broiling or twice for low.
5. Press the **START/SET** pad to start the broiler.
6. Let the oven pre-heat for 5 minutes.
7. Place the pan on the desired rack in the upper oven, and then close the oven door.
8. When one side of the food is browned, turn it over, close the oven door, and start cooking the other side.
9. When cooking is complete, press the **OFF/CLEAR** pad.

NOTES

- Use the low temperature setting for poultry or thick cuts of meat to prevent overbroiling.
- In general, to prevent overbroiling, press the **Broil** pad to switch from High to Low.
- Use caution when you open the oven door to turn over the food. The air escaping from the oven will be very hot.
- Your oven has different temperature setting ranges when you use the upper oven and lower oven simultaneously. See "Temperature setting guides" on page **29** for details.

Temperature probe (Single Mode Only)

The temperature probe lets you cook roasts and poultry to the exact internal temperature you want, taking the guess work out of determining whether a piece of meat is done or not.

You can use the temperature probe with the oven set to **Bake**, **Convection Bake**, or **Convection Roast**. When you use the temperature probe, the internal temperature is shown on the display when it reaches 100 °F.

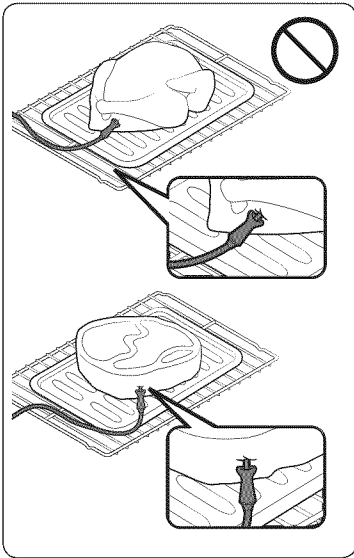

1. Push the temperature probe into the meat so that the tip of the probe reaches the center of the meat.

- When you insert the temperature probe, make sure it does not contact bone, fat, or gristle.
- For bone-in meats, insert the probe into the center of the lowest and thickest portion of the piece.
- For whole poultry (turkey, large chickens, etc.), insert the probe into the thickest part of the inner thigh, parallel to the leg.
- If you activate Keep Warm after cooking is complete using the temperature probe, the meat's internal temperature will exceed your initial settings.
- If you remove the temperature probe while cooking is in process, the oven shuts off in 60 seconds.
- The temperature probe may not function properly if inserted into frozen food. (The temperature probe icon doesn't appear.)

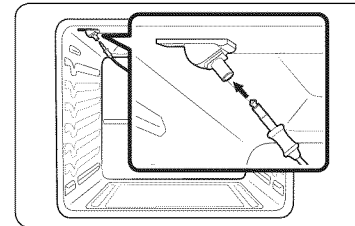

2. Insert the temperature probe plug into the socket on the top side wall of the oven.
3. Select the cooking operation (⌚ Bake, ⌚ Roast, or Bake) and the temperature.
4. Press the **Temp Probe** pad, and then set the internal temperature between 100 °F to 200 °F using the number pad.

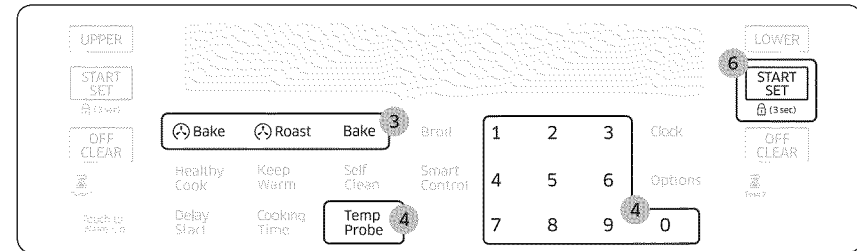

5. Set an option (Cooking Time, Delay Start, or Keep Warm) if necessary.

6. Press the **START/SET** pad. When the food reaches the set internal temperature, the oven automatically shuts off, and then beeps.

NOTES

Temperature probe operation will shut off either :

- When cooking time is over.
- When the temperature reaches the temperature you set.

Gas oven

Temperature table

Type of Food		Internal temperature (°F)
Beef / Lamb	Rare	140-150
	Medium	160-170
	Well done	170-180
Pork		170-180
Poultry		165-185

⚠ CAUTION

- To protect the temperature probe, be careful not to insert the probe so that it comes out of the meat. Make sure that the probe is inserted around the center of the meat.
- Do not store the probe in the oven.
- Do not leave the probe inside the oven during the Self-Cleaning or Broiling cycle. This will cause permanent damage to the probe.
- To avoid damage to the probe, defrost food in advance.
- Do not use tongs when inserting or removing the probe. Tongs can damage the probe.
- Use the temperature probe only for the applicable cooking operations.

📖 NOTE

If you have covered the meat with aluminum foil and you let it stand covered for 10 minutes after cooking is complete, the internal temperature increases by 5-10 °F degrees.

Recipe guide

Broiling guide

For detailed instructions, see page **26**.

📖 NOTES

- This is for reference only.
- Preheating for 5 minutes before broiling is recommended.
- The size, weight, thickness, starting temperature, and your doneness preference will affect broiling times.
- This guide is based on meats at refrigerator temperature.

Food	Doneness	Size	Thickness	Broil setting	Rack position		Cooking time	
					Single	Upper	1st side	2nd side
Hamburgers	Medium	9 patties	1"	HI	6	B	5:00-5:30	4:00-4:30
	Medium	9 patties	¾"	HI	6	B	5:00	4:00
Beef steak	Medium	-	1"	HI	6	B	7:00-6:00	6:00-5:00
	Medium	-	1½"	HI	6	B	9:00-10:00	6:00-7:00
Chicken pieces	Well done	2-2½ lbs.	¾"-1"	HI	5	A	15:00-17:00	13:00-15:00
Chicken breasts	Well done	2-3 pcs	-	HI	5	A	15:00-18:00	12:00-15:00
Pork chops	Well done	1 lb.	½"	HI	5	A	9:00-11:00	6:00-9:00
Lamb chops	Medium	10 oz.	1"	HI	4	A	8:00-12:00	5:00-8:00
	Well done	1 lb.	1½"	HI	4	A	10:00-15:00	7:00-11:00

⚠ CAUTION

Make sure to close the door after turning over the food.

Temperature setting guides

Twin Mode Temperature setting ranges

Your oven has different temperature setting ranges when you use the upper oven and lower oven simultaneously. The range for each oven changes, depending on the function and temperature setting of the other oven. See the tables below and on the next page for details.

Upper Oven		Lower Oven Available Setting Function and Temp.			
Mode	Set Temp.	Bake		🌀 Bake	
		Min	Max	Min	Max
Broil	HI	400 °F	480 °F	400 °F	480 °F
	LO	325 °F	480 °F	325 °F	480 °F
🌀 Bake 🌀 Roast	480 °F	400 °F	480 °F	400 °F	480 °F
	450 °F	350 °F	480 °F	350 °F	480 °F
	300 °F	250 °F	375 °F	250 °F	375 °F
	250 °F	225 °F	300 °F	225 °F	300 °F
	175 °F	175 °F	200 °F	175 °F	200 °F

(O - Available, X - Not available)

Lower Oven		Upper Oven Available Setting Function and Temp.			
Mode	Set Temp.	Broil		🌀 Bake and 🌀 Roast	
		LO	HI	Min	Max
Bake	480 °F	O	O	400 °F	480 °F
	450 °F	O	O	350 °F	480 °F
	350 °F	O	X	275 °F	450 °F
	325 °F	O	X	275 °F	400 °F
	250 °F	X	X	225 °F	300 °F
	175 °F	X	X	175 °F	200 °F
🌀 Bake	480 °F	O	O	400 °F	480 °F
	450 °F	O	O	350 °F	480 °F
	350 °F	O	X	275 °F	450 °F
	325 °F	O	X	275 °F	400 °F
	250 °F	X	X	225 °F	300 °F
	175 °F	X	X	175 °F	200 °F

Gas oven

Gas oven

Temperature Limitations by Mode

Feature	Single Mode		Twin Mode	
	Min	Max	Min	Max
Bake	175 °F (80 °C)	550 °F (285 °C)	175 °F (80 °C)	480 °F (250 °C)
Broil	LO	HI	LO	HI
Bake	175 °F (80 °C)	550 °F (285 °C)	175 °F (80 °C)	480 °F (250 °C)
Roast	175 °F (80 °C)	550 °F (285 °C)	175 °F (80 °C)	480 °F (250 °C)
Self Clean	2 hours	5 hours	-	-
Storage Drawer	-	-	-	-
Keep Warm	-	3 hours	-	-

For Bake or Roast, use **Auto Conversion** to set the minimum temperature to 200 °F (95 °C) if necessary. See “Auto Conversion” on page 39 for details.

Using the oven racks

Single Mode - One Oven Cavity

Your oven range comes with 3 racks and 7 rack positions. The rack positions are delineated by rack guides which support the racks. Each rack guide has a stop that prevents the rack from loosening during the oven's operation. Each rack has stoppers that need to be placed correctly on the rack guides. The stoppers prevent the racks from accidentally coming out of the oven completely when you pull the racks out.

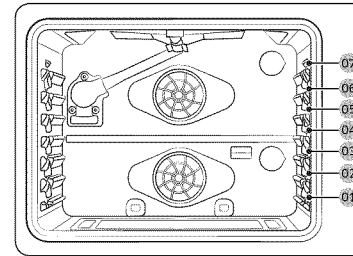

Type of food	Rack position
Broiling hamburgers	6
Broiling meats or small cuts of poultry, fish	5-4
Bundt cakes, Pound cakes, Frozen pies, casseroles	4 or 3
Fresh Pizza, Angel food cakes, Small roasts	2
Turkey, Large roasts, Hams	1

CAUTION

- Do not cover an oven rack with aluminum foil. This will hamper heat circulation, resulting in poor baking.
- Do not place aluminum foil on the oven bottom. The aluminum can melt and damage the oven.
- Arrange the oven racks only when the oven is cool.
- When placing an oven rack in the top-most rack position (position 7), make sure the rack is situated stably on the embossed stop.

NOTE

This table is for reference only.

Twin Mode - Two Oven Cavities

In Twin mode, the Smart Divider separates the oven into an upper oven and lower oven. The upper oven and lower oven each have 3 rack positions.

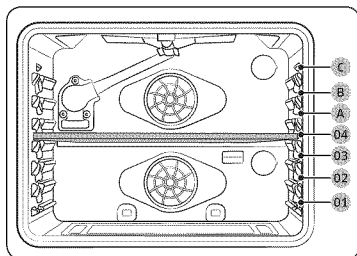

- The upper oven has 3 racks positions (A, B, C).
- The lower oven has 3 racks positions (1, 2, 3).

Type of food	Rack position	
	Upper	Lower
Frozen Pies	A	1
Angle Food Cakes	-	1
Bundt or pound cakes	-	1
Muffins, Brownies, Cookies, Cup cakes, Layer cakes, Pies, Biscuits	A	1
Casseroles	A	1
Small roasts, Hams	A	1
Small chickens, Turkey pieces, Medium roasts.	-	1

⚠ CAUTION

Precautions for using only the upper oven:

- You must preheat the oven. If you do not, the food may be overcooked or burnt on the surface and undercooked inside.
- To change the temperature during cooking, first remove the food and change the temperature. Then, put the food back inside the oven. Otherwise, the food may be burnt by the broil burner while the upper oven is preheating.
- In Convection baking mode, do not bake food over 2 inches (50 mm) in height.
- The cooking time may be longer than with single-oven cooking.

📖 NOTES

- This table is for reference only.
- When using the upper oven mode, always pre-heat before cooking items such as pizza.

- We recommend cooking pizza and pies using the 2nd rack position in Single mode or the 2nd rack position of the lower oven in Twin mode for crispy bottoms.

Inserting and removing an oven rack

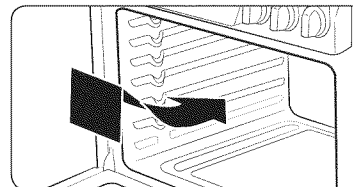

To insert an oven rack

1. Place the rear end of the rack on a rack guide.
2. Slide the rack into the rack guide while holding the front end of the rack.

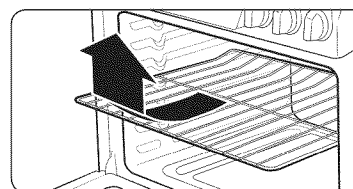

To remove an oven rack

1. Pull out the rack until it stops.
2. Pull up the front end of the rack and remove it from the rack guide.

Gas oven

Rack and Pan placement

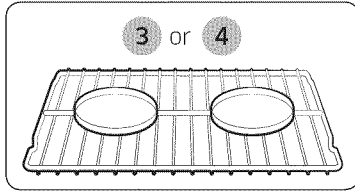

Single Oven Rack

Centering the baking pans in the oven as much as possible will produce better results. If baking with more than one pan, place the pans so each has at least 1" to 1½" of air space around it.

When baking on a single oven rack, place the oven rack in **position 3 or 4**. See the figure on the left.

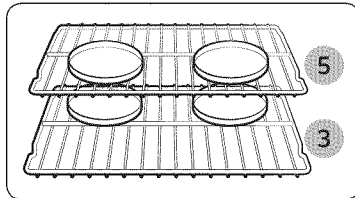

Multiple Oven Rack

When baking cakes and cookies on multiple racks, place the oven racks in **positions 3 and 5**. See the figure on the left.

Using Multiple Oven Racks

Type of Baking	Rack Positions
Cakes	3 and 5
Cookies	2 and 5

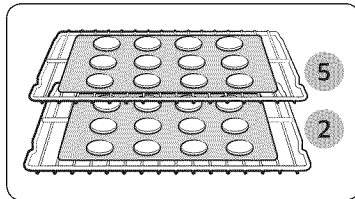

Multiple Oven Rack

Cooking options

⚠ CAUTION

Food that can easily spoil, such as milk, eggs, fish, poultry, and meat, should be chilled in a refrigerator before they are placed in the oven. Even when chilled, they should not stand for more than 1 hour before cooking begins and should be removed promptly when cooking is completed.

Timed Cook (Single mode)

Timed cooking sets the oven to cook foods at a set temperature for a set length of time. The oven automatically turns off when it finishes.

Mode: Bake / ⌚ Bake / ⌚ Roast / Healthy Cook

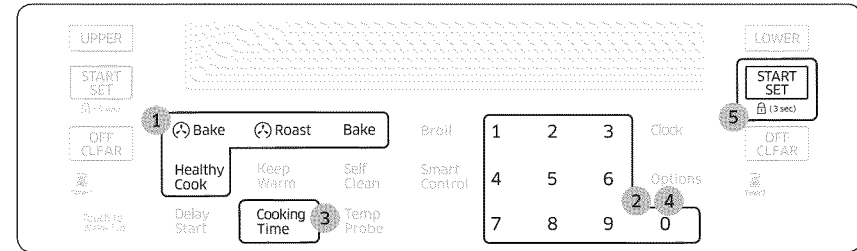

1. Press the pad corresponding to a desired cooking mode such as **Bake**.
2. If necessary, change the temperature using the number pad.
3. Press the **Cooking Time** pad.
4. Set the cooking time between 1 minute and 9 hours and 59 minutes (9:59) using the number pad.
5. Press the **START/SET** pad. The oven will automatically turn on and start preheating. The temperature will increase until it reaches the temperature you set.
6. When preheating is complete, put the container with the food on a rack, and then close the door. The oven starts cooking for the amount of time you set.
7. When the cooking time has elapsed, the oven will automatically shut off and then beep.

NOTE

To change the programmed cooking time, press the **Cooking Time** pad and enter a different time. Then, press the **START/SET** pad.

Timed Cook (Upper oven mode)

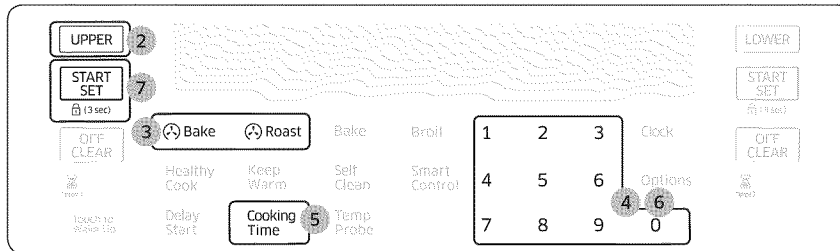

1. Insert the Smart Divider into the cavity.
2. Press the **UPPER** pad.
3. Press the pad corresponding to a desired cooking mode such as **Bake**.
4. If necessary, change the temperature using the number pad.
5. Press the **Cooking Time** pad.
6. Set the cooking time between 1 minute and 9 hours and 59 minutes (9:59) using the number pad.
7. Press the **START/SET** pad. The oven will automatically turn on and start preheating. The temperature will increase until it reaches the temperature you set.
8. When preheating is complete, put the container with the food on a rack in the upper oven, and then close the door. The oven starts cooking for the amount of time you set.
9. When the cooking time has elapsed, the oven will automatically shut off and then beep.

Timed Cook (Lower oven mode)

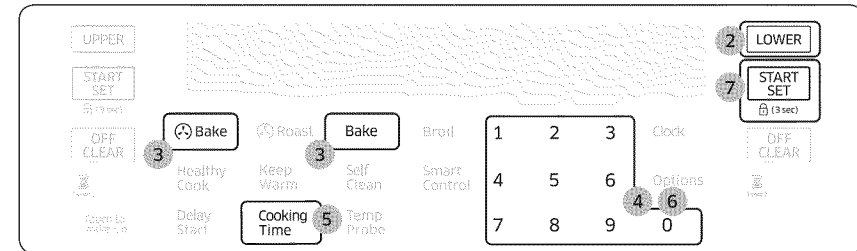

1. Insert the Smart Divider into the cavity.
2. Press the **LOWER** pad.
3. Press the pad corresponding to a desired cooking mode such as **Bake**.
4. If necessary, change the temperature using the number pad.
5. Press the **Cooking Time** pad.
6. Set the cooking time between 1 minute and 9 hours and 59 minutes (9:59) using the number pad.
7. Press the **START/SET** pad. The oven will automatically turn on and start preheating. The temperature will increase until it reaches the temperature you set.
8. When preheating is complete, put the container with the food on a rack in the lower oven, and then close the door. The oven starts cooking for the amount of time you set.
9. When the cooking time has elapsed, the oven will automatically shut off and then beep.

Gas oven

Delay Start (Single mode)

The Delay Start function lets you use the kitchen timer to automatically start and stop another cooking program. You can set Delay Start so that it delays the automatic start of a cooking operation you select by up to 12 hours.

Mode: Bake / Bake / Roast / Healthy Cook / Self-clean

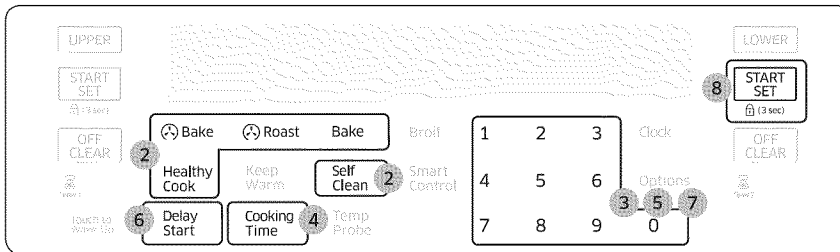

1. Place the container with the food on a rack, and then close the door.
2. Press the pad corresponding to a desired cooking mode such as **Bake**.
3. If necessary, change the temperature using the number pad.
4. Press the **Cooking Time** pad.
5. Set the cooking time between 1 minute and 9 hours and 59 minutes (9:59) using the number pad.
6. Press the **Delay Start** pad to change the time elements (AM/PM).
7. Set the starting time using the number pad.
8. Press the **START/SET** pad.
9. The oven starts cooking at the set time, and turns off automatically when it completes cooking.

NOTE

To change the starting time, press the **Delay Start** pad, and enter a new starting time. Then, press the **START/SET** pad.

Delay Start (Upper mode)

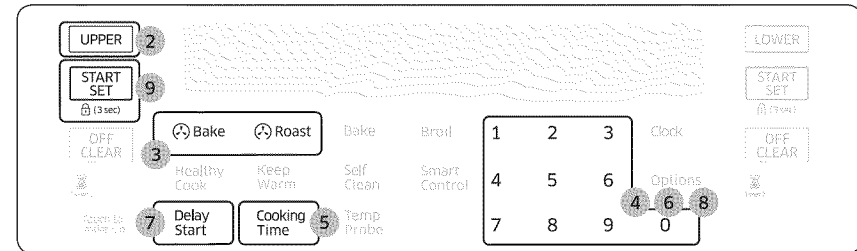

1. Insert the Smart Divider into the cavity. Place the container with the food on a rack in the upper oven, and then close the door.
2. Press the **UPPER** pad.
3. Press the pad corresponding to a desired cooking mode such as **Bake**.
4. If necessary, change the temperature using the number pad.
5. Press the **Cooking Time** pad.
6. Set the cooking time between 1 minute and 9 hours and 59 minutes (9:59) using the number pad.
7. Press the **Delay Start** pad.
8. Set the starting time using the number pad.
9. Press the **START/SET** pad.
10. The oven starts cooking at the set time, and turns off automatically when it completes cooking.

Delay Start (Lower mode)

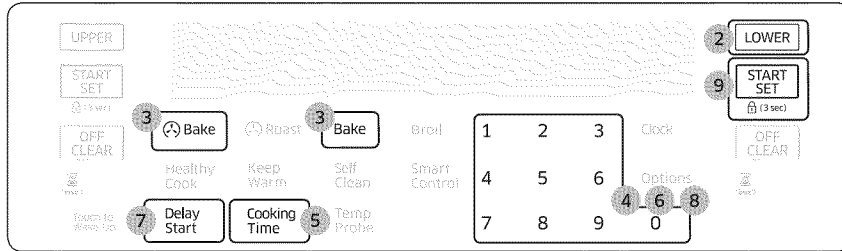

1. Insert the Smart Divider into the cavity. Place the container with the food on a rack in the lower oven, and then close the door.
2. Press the **LOWER** pad.
3. Press the pad corresponding to a desired cooking mode such as **Bake**.
4. If necessary, change the temperature using the number pad.
5. Press the **Cooking Time** pad.
6. Set the cooking time between 1 minute and 9 hours and 59 minutes (9:59) using the number pad.
7. Press the **Delay Start** pad.
8. Set the starting time using the number pad.
9. Press the **START/SET** pad.
10. The oven starts cooking at the set time, and turns off automatically when it completes cooking.

Special features

Healthy Cook (Single mode only)

Healthy Cook provides 6 different specialized cooking options. To use a Healthy Cook option, follow the instructions below.

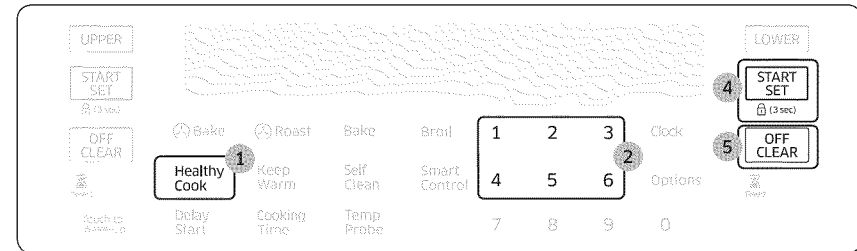

1. Press the **Healthy Cook** pad.
2. Press the number that corresponds to the option you want. See the table below.

1	2	3
Baked potato	Grilled chicken	Salmon steak
4	5	6
White fish fillet	Dehydrate	Bread proof

3. Set the temperature between 100 °F and 550 °F using the number pad. See page 36 for more information.
4. Press the **START/SET** pad to start cooking.
5. When the cooking is complete, press the **OFF/CLEAR** pad.

NOTES

- Preheating is not necessary.
- An error beep sounds if the temperature setting is out of the set range.

Gas oven

Specialized items

1. Baked potato

Baked potato is specially designed to bake potatoes or sweet potatoes.

2. Grilled chicken

Grilled chicken is specially designed to cook chicken pieces or chicken breasts. To prevent the skin from over-browning and drying, wrap each chicken piece or breast in foil.

3. Salmon steak

Salmon steak is specially designed to cook salmon steaks.

4. White fish fillet

White fish fillet is specially designed to cook white fish fillets.

5. Dehydrate

Dehydrate dries food or removes moisture from food via heat circulation. After drying the food, keep it in a cool and dry place. For fruit, adding lemon or pineapple juice or sprinkling sugar on the fruit helps the fruit retain sweetness. See the table below for Dehydrate settings.

Category	Rack position		Weight (oz)	Temperature (°F)
	Single rack	Two racks		
Vegetables	3 or 4	2 and 5	9-21 (250-600 g)	100-150
Fruit	3 or 4	2 and 5	9-21 (250-600 g)	100-150
Meat	3 or 4	2 and 5	14-30 (400-850 g)	145-175

6. Bread proof

Bread proof provides an optimal temperature for the bread proofing process, and therefore does not require a temperature adjustment. For the best results, always start the Bread proof option with a cool oven.

⚠ CAUTION

- Do not use Bread proof when the oven temperature is above 125 °F. If the temperature is above 125 °F, this mode will not heat the oven to the optimal temperature. Wait until the oven cools down.
- Do not use Bread proof for warming food. The proofing temperature is not hot enough to keep food warm.

- Place the dough in a heat-safe container on rack position 3 or 4 and cover it with a cloth or with plastic wrap. You may need to anchor the plastic wrap underneath the container so that the oven does not blow it off the dough.
- To avoid lowering the temperature and extending proofing time, do not open the oven door.

Keep Warm (Single mode only)

Keep cooked food warm at a low temperature up to 3 hours.

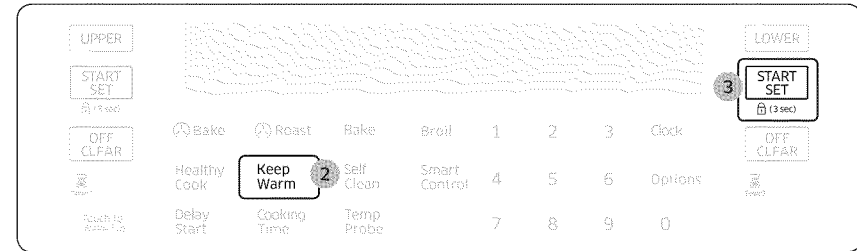

1. Place the container with the food on a rack, and then close the door.
2. Press the **Keep Warm** pad.
3. Press the **START/SET** pad. The oven heats up to 170 °F (77 °C).

📖 NOTES

- You can cancel warming at any time by pressing the **OFF/CLEAR** pad.
- To set the warming function during a timed cooking, press the **Keep Warm** pad in timed cooking mode. When the timed cooking is complete, the oven will lower the temperature to the warming default, and keep that temperature until the warming finishes or is canceled.
- Use this function in Single mode only. The oven cannot maintain the low temperature required for this function during Twin mode cooking.

The Sabbath Option (Single mode only)



(For use on the Jewish Sabbath and Holidays)

Use this option only for baking on the Jewish Sabbath and Holidays. For more information, visit the website at <http://www.star-k.org>

With the Sabbath option

- The oven temperature can be set higher or lower after you have set this option.
- The display doesn't change and no beep sounds when you change the temperature.
- Once the oven is properly set for baking with the Sabbath option active, the oven will remain continuously on until the Sabbath feature is cancelled. This will override the factory preset 12 hour energy saving feature.
- If the oven light is needed during the Sabbath, press **OVEN LIGHT** before activating the Sabbath feature. Once the oven light is turned on and the Sabbath option is active, the oven light will remain on until the Sabbath option is turned off.
- If you want the oven light off, be sure to turn it off before activating the Sabbath feature.
- Do not use the surface cooktop when the Sabbath option is on.

To enable the Sabbath option

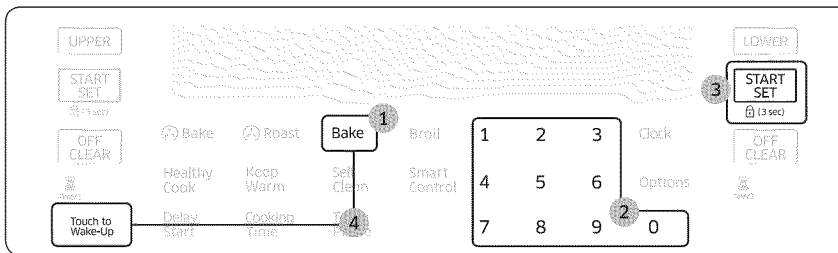

1. Press the **Bake** pad.
2. Enter a desired temperature using the number pad. The default temperature is 350 °F.
3. Press the **START/SET** pad. The display temperature changes after the oven temperature reaches 175 °F.

4. Press the **Bake** and **Touch to Wake-Up** pads simultaneously for 3 seconds to display "SAb". Once "SAb" appears, the oven control no longer beeps or displays any further changes.

NOTES

- You can change the oven temperature once baking starts, but the display will not change or beep. After changing the temperature, it takes 15 seconds before the oven recognizes the change.
- You can turn off the oven at any time by pressing **OFF/CLEAR**. However, this doesn't deactivate the Sabbath option.
- To deactivate the Sabbath option, hold down **Bake** and **Touch to Wake-Up** simultaneously for 3 seconds.
- You can set the cooking time before activating the Sabbath option.
- After a power failure, the oven will not resume operation automatically. "SAb" will appear in the control panel, but the oven will not go back on. Food can be safely removed from the oven, but you should not turn off the Sabbath option and turn the oven back on until after the Sabbath/Holidays.
- After the Sabbath observance, turn off the Sabbath option by pressing and holding **Bake** and **Touch to Wake-Up** simultaneously for at least 3 seconds.

CAUTION

- Do not attempt to activate any other functions except for Bake when the Sabbath option is on. Only the following pads will function properly: Number Pad, Bake, Oven Start/Set, and Oven Off.
- Do not open the oven door or change the oven temperature for about 30 minutes after you have started the Sabbath option. Let the oven reach the set temperature. The oven fan operates only when the oven temperature increases.



Gas oven

Changing option settings

Press the Options pad to change various settings of the range to your preference. The Options menu is available only when the oven is off.

Setting	Description
0	Demo mode Used by retailers for display purposes only.
1	Temperature Recalibrate the oven temperature.
2	Temp. Unit (°F / °C) Set the oven control to display temperatures in Fahrenheit or Centigrade.
3	Auto Conversion Converts regular baking temperatures to convection baking temperatures.
4	Time/date (12hr / 24hr) Set the clock to display the time in the 12-hour or 24-hour format.
5	Energy saving Automatically turns off the oven 12 hours after baking starts or 3 hours after broiling starts.
6	Language Select a preferred language from English, French, or Spanish.
7	Sound Turn the oven's sound (beeps) on or off.
8	WI-FI On/Off Set the WI-FI mode to ON/Off

Non-Cooking functions

Demo mode

This is used by retailers for display purposes only. In this mode, the heating element does not operate.

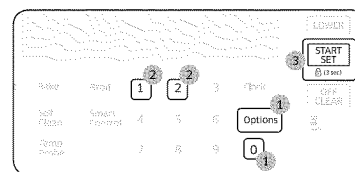

1. Press the **Options** pad, and then **0** on the number pad.
2. Press **1** (On) or **2** (Off) on the number pad.
3. Press the **START/SET** pad to save the changes.

Temperature adjust

The oven temperature has been calibrated at the factory. When first using the oven, follow the recommended recipe times and temperatures. If it appears that the oven is too hot or too cool, you can recalibrate the oven temperature. Before recalibrating, test a recipe by using a temperature setting that is higher or lower than recommended. The baking results should help you decide how much of an adjustment is needed. The oven temperature can be adjusted by ±35 °F (±19 °C).

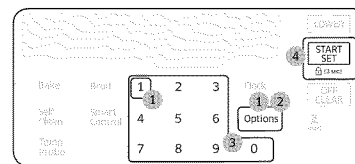

1. Press the **Options** pad, and then **1** on the number pad.
2. Press the **Options** pad to select a higher (+) or lower (-) temperature.
3. Enter an adjusting temperature value (0-35) using the number pad.
4. Press the **START/SET** pad to save the changes.

NOTE

This adjustment does not affect the broiling or the self-cleaning temperature, and is retained in memory after a power failure.





Temp. Unit (°F / °C)

Change the temperature format of the oven to Fahrenheit or Centigrade. The default is Fahrenheit.

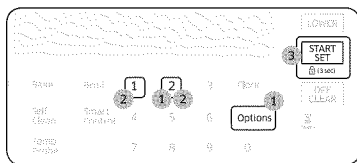

1. Press the **Options** pad, and then **2** on the number pad.
2. Press **1** (Fahrenheit) or **2** (Celsius) on the number pad.
3. Press the **START/SET** pad to save the changes.

Auto Conversion

Auto Conversion automatically converts regular baking temperatures to convection baking temperatures. For example, if you enter a regular recipe temperature of 350 °F and press **START/SET**, the oven displays the converted temperature of 325 °F.

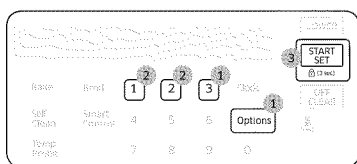

1. Press the **Options** pad, and then **3** on the number pad.
2. Press **1** (On) or **2** (Off) on the number pad. (Default setting is "Off".)
3. Press the **START/SET** pad to save the changes.

Time/date (12hr / 24hr)

Set the clock to display the time in the 12-hour or 24-hour format.

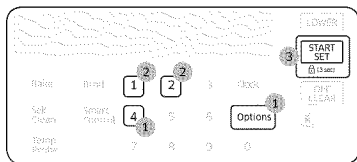

1. Press the **Options** pad, and then **4** on the number pad.
2. Press **1** (12hr) or **2** (24hr) on the number pad. (Default setting is "12-hour".)
3. Press the **START/SET** pad to save the changes.

Energy saving

This will automatically turn off the oven 12 hours after baking starts or 3 hours after broiling starts.

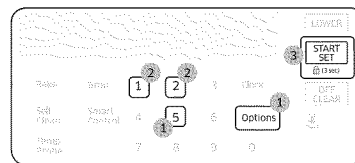

1. Press the **Options** pad, and then **5** on the number pad.
2. Press **1** (On) or **2** (Off) on the number pad.
3. Press the **START/SET** pad to save the changes.

Language

Select a preferred language from English, French, or Spanish.

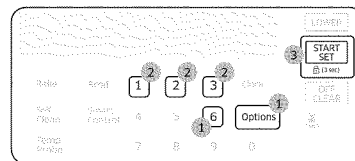

1. Press the **Options** pad, and then **6** on the number pad.
2. Press **1** (EN), **2** (FR), or **3** (SP) on the number pad.
3. Press the **START/SET** pad to save the changes.

Sound

Turn sound (beeps) On/Off

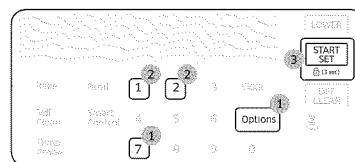

1. Press the **Options** pad, and then **7** on the number pad.
2. Press **1** (On) or **2** (Off) on the number pad.
3. Press the **START/SET** pad to save the changes.



Gas oven

Oven lock

Lock the control panel and the door to prevent accidental operations and/or product tipping.

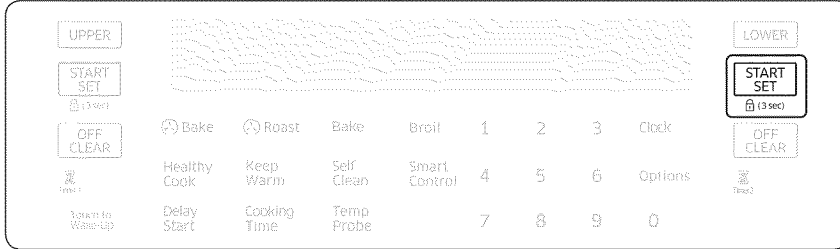

Press and hold the **START/SET** pad for 3 seconds to lock or unlock both the control panel and the door. When the Oven Lock is on, the oven panel does not operate and the oven door is locked and cannot be opened.

Smart control

How to connect the oven

1. Download and open the Samsung Smart Home app on your smart device.
2. Follow the app's on-screen instructions to connect your range.
3. Once the process is complete, the connected icon located on your range displays and the app will confirm you are connected.
4. If the connection icon does not turn on, follow the instruction on the app to reconnect.

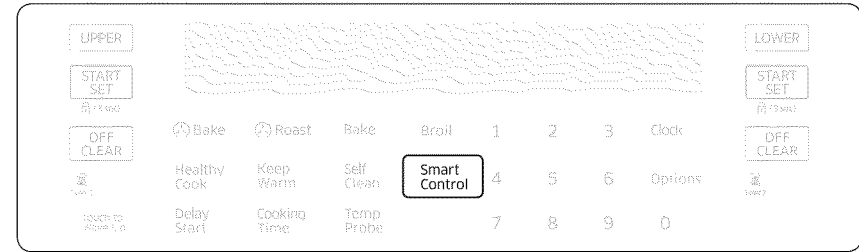

To control the oven remotely

1. Press **Smart Control**. appears in the display. The oven can now be controlled remotely with a connected remote device.
2. Select the oven icon on the Samsung Smart Home app to open the Oven Control app. When the app is connected to the oven, you can perform the following functions through the application:

Oven remote control using the Samsung Smart Home app	
Oven/ Cooktop Monitoring	<ul style="list-style-type: none"> • Check the status of the oven • Monitor the on/off status of each cooktop burner.
Oven Remote Control	<ul style="list-style-type: none"> • Set or adjust oven settings remotely.
My Cooking	<ul style="list-style-type: none"> • Turn the oven off remotely. • Once cooking starts, change the set cooking time and temperature remotely.

Oven remote control using the Samsung Smart Home app	
Error Check	<ul style="list-style-type: none"> Automatically recognize errors.
Temp Probe	<ul style="list-style-type: none"> Monitor the current temperature and reset the probe setting.
<ul style="list-style-type: none"> If  is not shown in the display, you are still able to monitor the oven and cooktop status and turn the oven off. 	

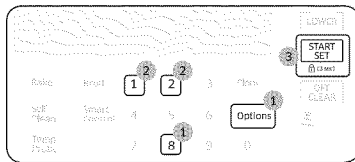

WI-FI On/Off

If you set the WI-FI mode to Off, mobile devices cannot connect to the range.



1. Press the **Options** pad, and then **8** on the number pad.
2. Press **1** (On) or **2** (Off) on the number pad.
3. Press the **START/SET** pad to save the changes.

NOTES

- Opening the oven door or pressing **Smart Control** will delete  from the display and prevent most of the remote functions from operating.
- When oven cooking is finished or cancelled,  is removed from the display.
- For safety reasons, you cannot turn on the gas oven remotely.
- For safety reasons, you must specify the cooking time to enable remote control.
- The oven continues operating even if the Wi-Fi connection is lost.
- Smart Control** will not work properly if the Wi-Fi Connection is unstable.
- See the Samsung Smart Home App manual for detailed information.

Maintenance

Cleaning

Control panel

First, lock the control panel and the door to prevent accidental operations and/or product tipping.

1. Press and hold the **START/SET** pad for 3 seconds to lock both the control panel and the door.
2. Clean the control panel using a soft cloth dampened with plain water, warm soapy water, or glass cleaner. Do not spray cleansers directly onto the control panel.
3. When done, press and hold the **START/SET** pad again for 3 seconds.

⚠ WARNING

- Make sure the control panel turns off and all surfaces of the range are cool before cleaning. Otherwise, you can get burned.
- If the range has been moved away from the wall, make sure the anti-tip device is reinstalled properly when the range has been put into place again. Otherwise, the range may tip over, causing physical injuries.
- Do not use steel-wool or abrasive cleansers of any kind. These can scratch or damage the surface.

Stainless steel surface

1. Remove any spills, spots, and grease stains using a soft, wet cloth.
2. Apply an approved stainless steel cleanser to a cloth or paper towel.
3. Clean one small area at a time, rubbing with the grain of the stainless steel if applicable.
4. When done, dry the surface using a soft, dry cloth.
5. Repeat steps 2 through 4 as many times as necessary.

⚠ CAUTION

- Do not use a steel-wool pad or abrasive cleanser on stainless steel surfaces. It will scratch the surface.
- Do not spray any type of cleanser into the manifold holes. The ignition system is located in those holes and must be kept free of moisture.

Maintenance

Racks

To keep the racks clean, remove them from the cavity, and soak them in lukewarm soapy water. Then, scour soil off of the racks using a plastic scouring pad. If the racks do not slide in and out smoothly after you have cleaned them, rub the side rail guides with wax paper or a cloth containing a few drops of cooking oil. This will help the racks glide more easily on their tracks.

NOTES

- Do not put the racks in a dishwasher.
- If a rack does not slide in and out smoothly, apply a few drops of cooking oil to the oven rack guides.
- If a rack becomes too difficult to slide in or out, lubricate the rack with graphite lubricant.
- To purchase the graphite lubricant, contact us at 1-800-SAMSUNG (726-7864).
- For online shopping, visit <http://www.samsungparts.com/Default.aspx> and search for part DG81-01629A.

CAUTION

- Do not leave the racks in the oven during the self-cleaning cycle. The extreme heat generated in this cycle can permanently peel off the rack coating and make it difficult to slide the racks on the guide rails.
- Do not spray cooking oil or lubricant directly onto the racks.

Door

Do not remove the inner gasket of the oven door for cleaning.

Door inner side

- **Inner surface:** Clean the inner side of the door manually using a soapy plastic scouring pad, and then wipe with a dry cloth. Take care not to get the gasket wet or allow moisture into the door.
- **Inner glass:** The inner glass is cleaned automatically during the self-cleaning cycle.

Door outer side

- **Outer surface:** Follow the cleaning instructions for the stainless steel surface in the previous section.
- **Outer glass:** Clean the outer glass using a glass cleanser or soapy water. Rinse and dry thoroughly. Take care not to get the gasket wet or allow moisture into the door.

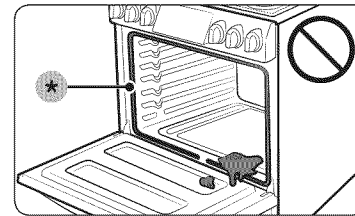

CAUTION

Do not let moisture enter the door or contact the door gasket (*). Moisture may reduce the gasket's performance.

Burner controls

Make sure all surface burner knobs are in the OFF position.

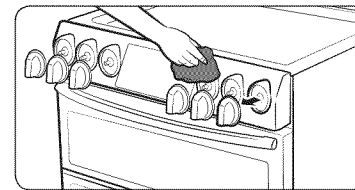

1. Pull knobs off the control valve stems.
2. Clean the knobs in warm, soapy water. Then, rinse and dry them thoroughly.
3. Clean the stainless steel surfaces using stainless steel cleaner.
4. Re-attach the knobs to the control valve stems.

CAUTION

- Do not clean the control knobs in a dish washer.
- Do not spray cleansers directly onto the control panel. Moisture entering the electric circuits may cause electric shock or product damage.

Cooktop surface

The porcelain-enameled cooktop surface needs to be kept clean. We recommend that you remove food spills immediately after they take place.

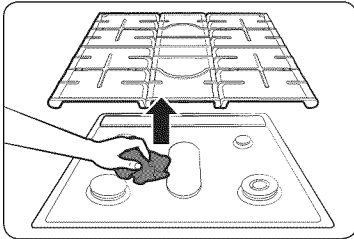

1. Turn off all surface burners.
2. Wait until all burner grates cool down, and then remove them.
3. Clean the cooktop surface using a soft cloth. If food spills run into gaps of the burner components, remove the burner cap and the head, and wipe up the spills.
4. When cleaning is finished, reinsert the burner components, and then put the burner grates back into position.

⚠ CAUTION

- Do not use a steel-wool pad or abrasive cleaner, which can scratch or damage the enamel surface.
- Do not remove the cooktop surface to clean it. The gas lines leading to the burner manifolds can be damaged, resulting in a fire or system failure.
- Do not pour water into the cooktop well while cleaning the cooktop. This could leak down into the range gas and electrical systems creating a risk of electrical shock or high levels of Carbon Monoxide, due to corrosion of the gas valves or ports.
- Keep oven vent ducts unobstructed. Clean vents frequently to avoid grease buildup.

Burner grates and components

Turn off all surface burners and make sure they have all cooled down.

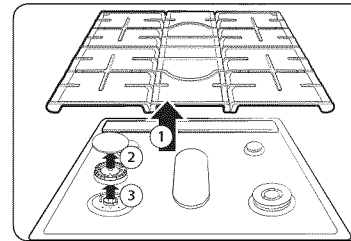

1. Remove the burner grates.
2. Remove the burner caps from the burner heads.
3. Remove the burner heads from the valve manifolds to reveal the starter electrodes.
4. Clean all removable grates and burner components in warm, soapy water. Do not use steel-wool pads or abrasive cleaners.
5. Rinse and dry grates and burner components thoroughly.
6. Return the burner heads to their positions on top of the manifold valves. Make sure a starter electrode is inserted through the hole in each burner head.

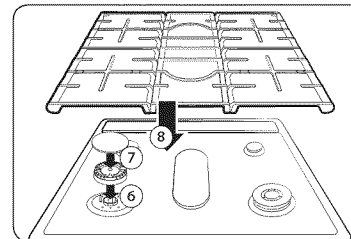

📖 NOTE

See the next page for detailed burner component re-assembly instructions.

7. Return the burner caps to their positions on top of the burner heads. To ensure proper and safe operation, make sure the burner caps lie flat on top of the burner heads.
8. Re-install the burner grates in their respective positions.
9. Turn on each burner and check if it operates properly. After verifying that a burner operates normally, turn it off.

Maintenance

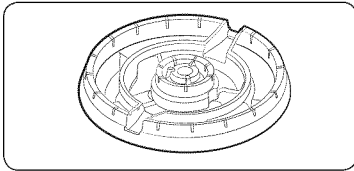

Brass burner head

NOTES

- The brass parts of your burner will change color with use. However, this will not affect performance and you can clean the brass parts with a brass cleaner.
- After cleaning, confirm that the burner port openings aren't plugged.
- Do not wash any burner components in a dish washer.

CAUTION

- The starter electrodes are not removable. Do not attempt to remove them by force.
- To avoid chipping, do not bang grates and caps against each other or against hard surfaces such as cast iron cookware.
- The burner spreader can be blocked by food or dust. Clean the spreader if it appears blocked. If you clean the spreader with water, assemble it only after it is completely dry. If the spreader is wet, it might prevent the burners from igniting.

Burner reinstall guide

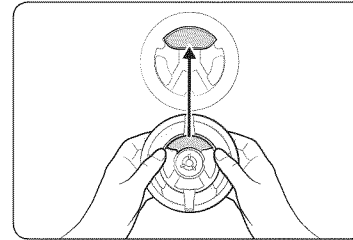

Dual Burner head

1. Orient the burner head so that the opening for the electrode lines up with the electrode.

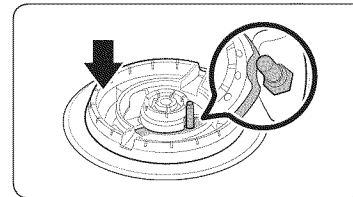

2. Install the burner head so that the electrode passes through the opening for the electrode. Make sure the burner head lies flat on the stove top.

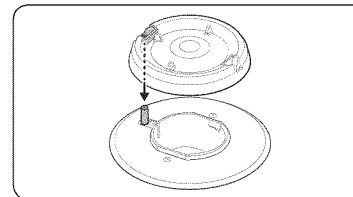

Round Burner head

1. Orient the burner head so that the opening for the electrode lines up with the electrode.

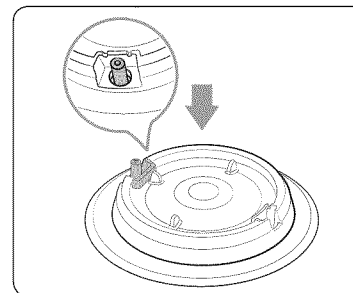

2. Install the burner head so that the electrode passes through the opening for the electrode. Make sure the burner head lies flat on the stove top.

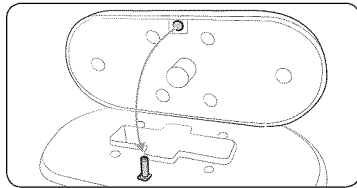

Oval Burner

1. Orient the burner head so that the opening for the electrode lines up with the electrode.

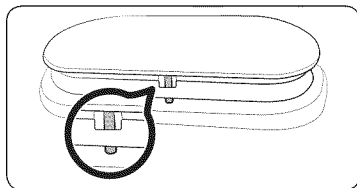

2. Install the burner head so that the electrode passes through the opening for the electrode. Make sure the burner head lies flat on the stove top.

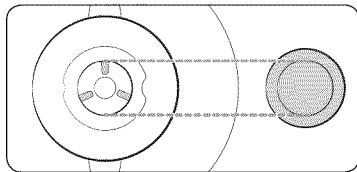

Burner Cap

1. Match the burner caps to the burners by size, and then re-install the caps on the burner heads.

⚠ CAUTION

Make sure each cap is re-installed on the correct burner head, is centered on the burner head, and lies flat.

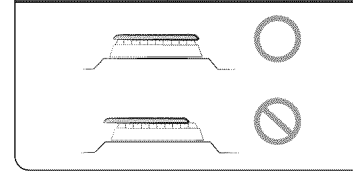
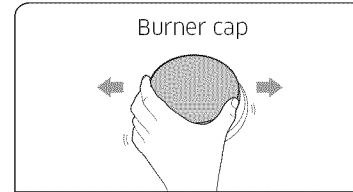
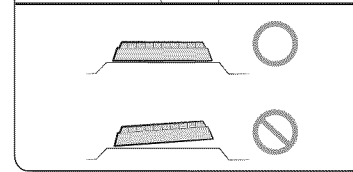
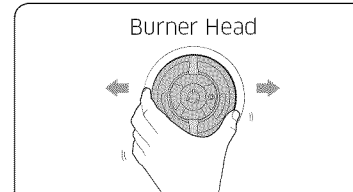
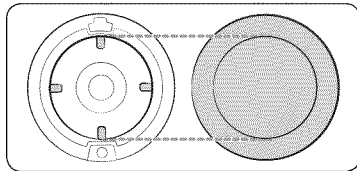
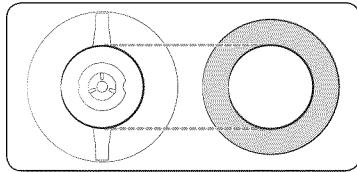

Top	Bottom

⚠ CAUTION

Make sure all burner components (heads and caps) are reinstalled properly. They will be stable and rest flat when correctly installed.

📖 NOTE

The precise simmer burner (RR) cap and the inner Dual burner (RF) cap are interchangeable.

Maintenance

Self-cleaning (Single mode only)

This self-cleaning oven uses high temperatures (well above cooking temperatures) to burn off leftover grease and residue completely or reduce them to a finely powdered ash that you can wipe away with a damp cloth.

⚠ CAUTION

- Do not leave small children unattended near the range during the self-cleaning cycle. The outside surfaces of the range can get extremely hot.
- Some birds are extremely sensitive to fumes from a self-cleaning oven. Relocate birds to a well-ventilated room away from the range.
- Do not line the oven, oven racks, or oven bottom with aluminum foil. Doing so will result in poor heat distribution, produce poor baking results, and cause permanent damage to the oven interior. The aluminum foil will melt onto and adhere to the interior oven surfaces.
- Do not force the oven door open during the self-cleaning cycle. This will damage the automatic door-locking system. The door automatically locks when the self-cleaning cycle is started and stays locked until the cycle is cancelled and the oven temperature is below 400 °F.
- Use caution when opening the oven door after the self-cleaning cycle. The gas oven will still be VERY HOT and hot air and steam might escape when the door is open.
- Wipe off any excess spillage before using the self-cleaning operation.
- Do not use oven cleaners. Commercial oven cleaners or oven liners should NEVER be used in or around any part of the oven. Residue from oven cleaners will damage the inside of the oven during a self-cleaning operation.

To perform the self-cleaning cycle

Make sure the door lock is released. Remove all racks from the oven cavity.

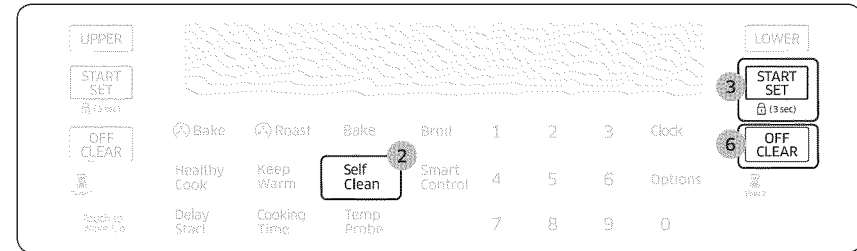

1. Make sure the oven door is closed completely and unlocked.
2. Press the **Self Clean** pad once. Then, select the cleaning time by pressing the **Self Clean** pad one or more times in accordance with the table below.

Once	Twice	Three times
3-hour cycle	5-hour cycle	2-hour cycle

3. Press the **START/SET** pad. The oven door is locked and the oven begins to heat up.
4. When the self-cleaning cycle is complete, the oven beeps 10 times. The door will remain locked and the Lock icon will blink until the oven temperature falls below 400 °F (200 °C).
5. When the Lock icon changes to an open lock, you can open the oven door. The Lock icon changes to an open lock when the oven temperature drops below 400 °F (200 °C).
6. Press the **OFF/CLEAR** pad to display the time of the day.

⚠ CAUTION

Do not use the surface burners while the gas oven is performing a self-cleaning cycle.

⚠ WARNING

Be sure all controls are OFF and all surfaces are COOL before cleaning any part of the range.

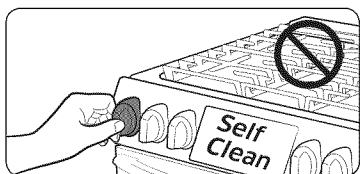

NOTE

Make sure all surface burners are off while the oven is performing a self cleaning cycle. Self-clean will not operate if a surface burner is on.

To delay starting a self-cleaning cycle

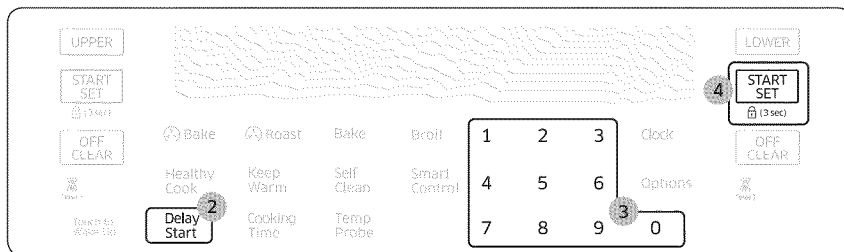

1. Repeat steps 1 and 2 on the previous page.
2. Press the **Delay Start** pad. The oven door locks.
3. Set the time you want the oven to start self-cleaning using the number pad.
4. Press the **START/SET** pad. The oven will start self-cleaning at your specified time.

To cancel the self-cleaning cycle

You may find it necessary to stop or interrupt a self-cleaning cycle due to smoke in the oven. To turn off the self-cleaning cycle, press the **OFF/CLEAR** pad. The cycle turns off, but the door remains locked and the Lock icon blinks until the oven temperature falls below 400 °F (200 °C).

After self-cleaning

- The door stays locked until the internal oven temperature falls below 400 °F.
- When the oven has cooled down, wipe the oven surfaces with a cloth to remove ash residue.
- Stubborn stains can be removed using a steel-wool pad. Lime deposits can be removed using a vinegar-soaking cloth.

- If you are not satisfied with the cleaning results, repeat the cycle. "HOT" appears on the display until the oven cools down. Wait until the message disappears, and then start a new cycle.
- The cooling fan automatically runs for certain amount of time after self-cleaning.

CAUTION

Do not attempt to open the oven door immediately after the self-cleaning cycle is complete. The oven is still very hot when the door unlocks. Escaping hot air and/or steam could burn you.

Replacing the oven light

Oven light

The oven light is a standard 40-watt appliance bulb. It comes on when you open the oven door.

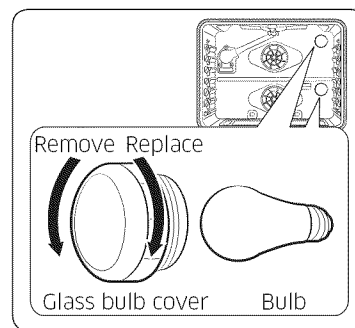

1. Turn off the oven.
2. Make sure the oven and oven light are cool.
3. Open the door, and remove the glass cover by turning it counterclockwise.
4. Remove the oven light from the socket by turning it counterclockwise.
5. Insert a new 40-watt appliance bulb into the socket, and then turn it clockwise to tighten.
6. Reinsert the glass cover, and then turn it clockwise to tighten.

CAUTION

To prevent electric shock, make sure the oven is turned off and cool before replacing the oven light.

NOTES

- The oven light does not operate during the self-cleaning cycle.
- Remove the racks if they prevent you from accessing the oven light.

Maintenance

Removing and re-installing the oven door

How to remove the door

NOTE

You can remove the upper door the same way you remove the full door.

CAUTION

- The door is very heavy. Be careful when removing and lifting the door. Do not lift the door by the handle.
 - Turn the power OFF before removing the door.
1. Open the door completely.
 2. Pull the hinge locks down toward the door frame to the unlocked position.

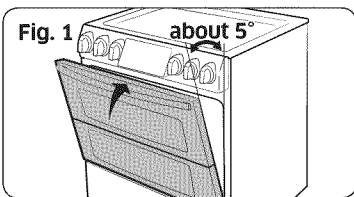
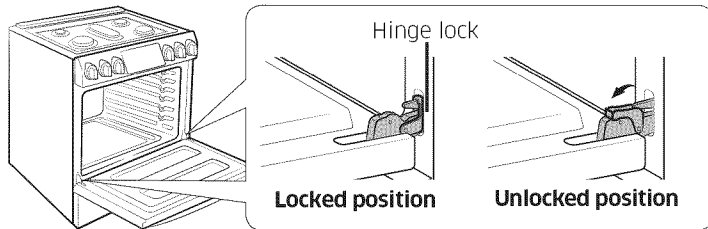

3. Firmly grasp both sides of the door at the top.
4. Close the door to the door removal position, which is approximately 5 degrees from vertical (Fig. 1).
5. Lift the door up and out until the hinge arm is clear of the slot (Fig. 2).

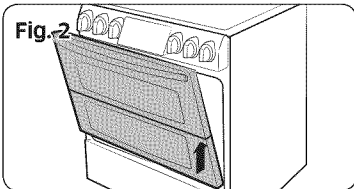

How to re-install the door

You can re-install the upper door the same way you re-install the full door.

1. Firmly grasp both sides of the door at the top.
2. With the door at the same angle as the removal position, slide the indentation of the hinge arm into the bottom edge of the hinge slot. The notch in the hinge arm must be fully inserted into the bottom of the slot.

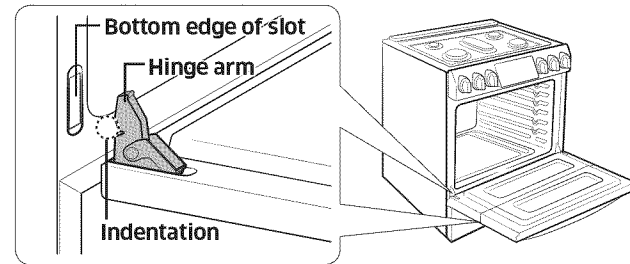

3. Open the door fully. If the door will not open fully, the indentation is not inserted correctly in the bottom edge of the slot.
4. Push the hinge locks up against the front frame of the oven cavity into the locked position.

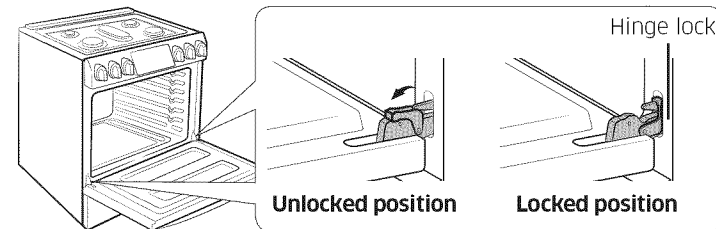

5. Close the oven door.



Troubleshooting

How to remove and re-install the Storage drawer

Storage drawer

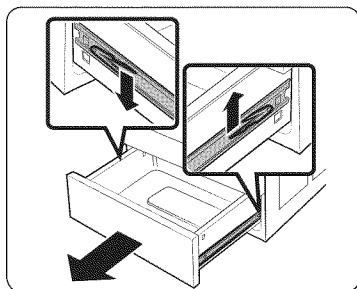

1. Slide open the drawer until it stops.
2. Locate the roller guide clips on either side. Using both hands, pull down the left clip while lifting the right clip, and then remove the drawer.
3. Clean the drawer in warm, soapy water using a cloth or soft brush. Then, rinse and dry it thoroughly.

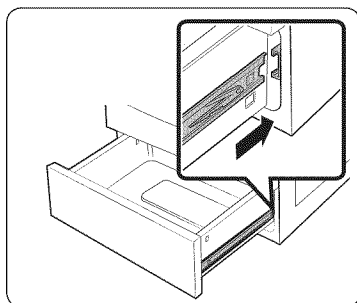

4. Put the drawer in the roller guides on either side, and then snap the clips into place.

If you encounter a problem with the range, check the tables starting below, and then try the suggested actions.

Checkpoints

Gas safety

Problem	Possible cause	Action
You smell gas.	The surface burner knob is not in the OFF position and the burner is not lit.	Turn the burner knob to OFF
	There is a gas leak.	Clear the room, building, or area of all occupants. Immediately call your gas supplier from a neighbor's phone. Do not call from your phone. It is electrical and could cause a spark that could ignite the gas. Follow the gas supplier's instructions. If you cannot reach your gas supplier, call the fire department.



Troubleshooting

Surface burner

Problem	Cause	Action
All burners do not light.	The power cord is not plugged into the electrical outlet.	Make sure the electrical plug is plugged into a live, properly grounded outlet.
	A fuse in your home may be blown or the circuit breaker may have tripped.	Replace the fuse or reset the circuit breaker.
	The gas supply is not properly connected or turned on.	See the Installation Instructions that came with your range.
Surface burners do not light.	The control knob is not set properly.	Push in the control knob and turn it to the Lite position.
	The burner caps are not in place. The burner base is misaligned.	Clean the electrodes. Put the burner cap on the burner head. Align the burner base.
Surface burner clicks during operation.	The control knob has been left in the Lite position.	After the burner lights, turn the control knob to a desired setting. If the burner still clicks, contact a service technician.
The burners do not burn evenly.	Surface burner components and caps are not assembled correctly and level.	See page 43 .
	The surface burners are dirty.	Clean the surface burner components. (See page 43 .)

Problem	Cause	Action
Very large or yellow surface burner flames.	The wrong burner orifice is installed.	Check the burner orifice size. Contact your installer if you have the wrong orifice (LP gas instead of natural gas or natural gas instead of LP gas).
Surface burners light but oven burners do not light.	The oven door lock is turned on.	The display will show the Lock icon. Hold the oven door open and press the START/SET pad for 3 seconds. The oven will beep and the Lock icon will turn off.
	The Gas Pressure Regulator shut off switch is in the off position.	Call a qualified service technician.

Oven

Problem	Cause	Action
The oven control beeps and displays an information code.	There may be an issue with your oven. See the "Information codes" chart on page 55 .	Press the OFF/CLEAR pad, and then restart the oven. If the problem persists, disconnect all power to the range for at least 30 seconds and then reconnect the power. If this does not solve the problem, call for service.

Problem	Cause	Action
The oven will not turn on.	The oven is not completely plugged into the electrical outlet.	Make sure the electrical plug is fully inserted into a live, properly grounded outlet.
	A fuse in your home may be blown or the circuit breaker may have tripped.	Replace the fuse or reset the circuit breaker.
The oven temperature is too hot or cold.	The oven thermostat needs adjustment.	See page 38 .
The oven burner will not shut off.	The oven door lock is turned on.	The display will show the Lock icon. Hold the oven door open and press the START/SET pad for 3 seconds. The oven will beep and the Lock icon will turn off.
	The Sabbath function has been activated.	SAb and the time of day will show in the display. All other controls and signals will be deactivated. To turn off the oven only, press the OFF/CLEAR pad. To cancel the Sabbath function and reactivate the controls and signals, press and hold the Bake and Touch to Wake Up pads simultaneously for 3 seconds.

Problem	Cause	Action
The oven light (lamp) will not turn on.	The oven door lock is turned on.	The display will show the Lock icon. Hold the oven door open, and then press the START/SET pad for 3 seconds. The oven will beep and the Lock icon will turn off.
	The Sabbath function has been activated.	SAb and the time of day will show in the display. All other controls and signals will be deactivated. To cancel the Sabbath function and reactivate the light switch and other controls, press and hold the Bake and Touch to Wake Up pads simultaneously for 3 seconds.
	A loose or burned-out bulb.	See page 47 .
	The switch operating the oven light needs to be replaced.	Call for a qualified service technician.
The oven smokes excessively during broiling.	Meat or food was not properly prepared before broiling.	Cut away excess fat and/or fatty edges that may curl.
	Improperly positioned top oven rack.	See the broiling guide on page 28 .
	The controls are not being set properly.	See page 26 .
	Greasy buildup on oven surfaces.	Regular cleaning is necessary when broiling frequently.

Troubleshooting

Problem	Cause	Action
Cooking is finished, but the cooling fan is still running.	The fan automatically runs for a certain amount of time to ventilate the inside of the oven.	This is not a product malfunction. The fan is designed to run automatically for a period of time to cool down the oven.
The oven will not self-clean.	The oven door lock is turned on.	The display will show the Lock icon. Hold the oven door open, and then press the START/SET pad for 3 seconds. The oven will beep and the Lock icon will turn off.
	The Smart Divider is installed in the oven.	Self-clean will not operate with the Smart Divider installed. Remove it from the oven.
	The oven is too hot.	Let the oven cool down, and then reset the controls. The self-clean cycle will not lock the oven door if the oven temperature is too hot. The door must lock before the self-clean cycle can start.
	The self-cleaning oven controls are not properly set.	Reset the self-cleaning oven controls. (See page 46 .)
	A surface burner is on.	Turn off the surface burner. Self-clean will not operate if a surface burner is on.

Problem	Cause	Action
A crackling or popping sound.	This is normal.	This is the sound of the metal heating and cooling during any cooking or cleaning function.
Excessive smoking during a self-cleaning cycle.	This is the first time the oven has been cleaned.	This is normal. The oven will always smoke more the first time it is cleaned. Wipe up all excessive soil before starting the self-cleaning cycle. If smoke persists, press the OFF/CLEAR pad. Open the windows to clear the smoke from the room. After the oven has cooled and unlocked, wipe up excessive soil, and then reset the oven for self-cleaning.
The oven door will not open after a self-cleaning cycle.	This is normal.	The oven door will stay locked until the oven temperature drops below 400 °F.

Problem	Cause	Action
The oven is not clean after a self-cleaning cycle.	A fine dust or ash is normal.	This can be wiped clean with a damp cloth. Set the self-cleaning cycle for a longer cleaning time. The cycle was not long enough to burn off the dirt buildup. Extremely dirty ovens require hand-cleaning of excessive spillovers and food buildup before you start a self-cleaning cycle. Multiple self-cleaning cycles may be necessary to completely clean the oven.
There is steam or smoke coming from under the control panel.	This is normal.	The oven vent is located there. More steam is visible when you are using the convection functions or when baking or roasting multiple items at the same time.
A burning or oily odor coming from the vent.	This is normal for a new oven and will disappear within 1/2 hour of the first bake cycle.	To speed the process, set a self-cleaning cycle for a minimum of 3 hours. (See page 46 .)
Strong odor.	This is temporary.	The insulation around the inside of the oven emits an odor the first few times the oven is used.

Problem	Cause	Action
The oven racks are difficult to slide.	This is normal.	Apply a small amount of vegetable oil to a paper towel, and then wipe the edges of the oven racks with the paper towel. Racks become dull and hard to slide if they are left in the oven during a self-clean cycle.
Fan noise.	This is normal.	The convection fan runs until the function is over or the door is opened.
The convection fan is not working.	This is normal.	The fan starts automatically when the oven reaches the preheat temperature.

Troubleshooting

Others

Problem	Cause	Action
The product is not level.	The appliance has been installed improperly. The leveling leg(s) is (are) damaged or uneven.	Make sure the floor is level, strong, and stable. If the floor sags or slopes, contact a carpenter. Check and level the range. (See the Installation Instructions.)
	The kitchen cabinets are not properly aligned and make the range appear to be not level.	Ensure that cabinets are square and provide sufficient room for installation.
The display goes blank.	The electrical outlet Ground Fault Interrupter (GFI or GFCI) has been tripped and needs to be reset. Your digital control has been damaged.	Replace fuse or reset circuit breaker.

Problem	Cause	Action
Food does not bake or roast properly in the oven.	The wrong cooking mode is selected.	See page 24 .
	The oven racks have not been positioned properly for the foods being cooked.	See page 30 .
	Incorrect cookware or cookware of improper size is being used.	See page 18 .
	The oven thermostat needs adjustment.	See page 38 .
	There is aluminum foil on racks and/or oven bottom.	Remove foil.
	The clock or timers are not set correctly.	See page 17 .
Food does not broil properly in the oven.	The oven controls are not set properly.	See page 26 .
	The oven door was not closed during broiling.	See page 24 .
	The rack has not been properly positioned.	See the broiling guide on page 28 .

Information codes

Code symbol	Meaning	Solution
C-20	Oven sensor malfunction.	<ol style="list-style-type: none"> 1. Press the OFF/CLEAR pad, and then restart the oven. 2. If the problem persists, disconnect all power to the oven range for at least 30 seconds and then reconnect the power.
C-21	The oven is overheating.	
C-23	Temp probe malfunction.	
C-30	C-30 Check the PBA NTC Sensor	
C-31	C-31 Check the PBA NTC Sensor	
C-A2	Check the cooling system.	
C-d0	Control pad malfunction.	
C-d1	Door lock malfunction.	
C-F0	PCB signal malfunction.	
C-F2	Touch IC and PCB signal malfunction.	
-dC-	Divider switch malfunction.	<ol style="list-style-type: none"> 1. If the Divider is in the oven, make sure it is pushed in all the way. 2. If the Divider is not in the oven, see if something is pressing against the divider switch in the back of the oven. 3. If the Divider is all the way in or there is nothing pressing against the Divider switch, press the OFF/CLEAR pad, and then restart the oven. If the problem persists, disconnect all power to the oven range for at least 30 seconds, and then reconnect the power.
<p>** If these solutions do not solve the problem, contact a local Samsung service center or call 1-800-SAMSUNG (1-800-726-7864).</p>		

Warranty

PLEASE DO NOT DISCARD.

SAMSUNG GAS RANGE

LIMITED WARRANTY TO ORIGINAL PURCHASER

This SAMSUNG brand product, as supplied and distributed by SAMSUNG ELECTRONICS AMERICA or CANADA INC. (SAMSUNG) and delivered new, in the original carton to the original consumer purchaser, is warranted by SAMSUNG against manufacturing defects in materials and workmanship for a limited warranty period of:

One (1) Year Parts and Labor

This limited warranty begins on the original date of purchase, and is valid only on products purchased and used in the United States or Canada. To receive warranty service, the purchaser must contact SAMSUNG for problem determination and service procedures. Warranty service can only be performed by a SAMSUNG-authorized service center, and any unauthorized service will void this warranty. The original dated bill of sale must be presented upon request as proof of purchase to SAMSUNG or SAMSUNG's authorized service center. Samsung will provide in-home service during the one (1) year warranty period at no charge subject to availability within the contiguous United States or Canada. In-home service is not available in all areas. To receive in-home service, product must be unobstructed and accessible to the service agent. If service is not available, Samsung may elect to provide transportation of the product to and from an authorized service center.

SAMSUNG will repair or replace this product, at our option and at no charge as stipulated herein, with new or reconditioned parts or products if found to be defective during the limited warranty period specified above. All replaced parts and products become the property of SAMSUNG and must be returned to SAMSUNG. Replacement parts and products assume the remaining original warranty, or ninety (90) days, whichever is longer.

Warranty

This limited warranty shall not cover cases of incorrect electric current, voltage or supply, light bulbs, house fuses, house wiring, cost of a service call for instructions, or fixing installation errors. Furthermore, damage to the cooktop caused by the use of cleaners other than the recommended cleaners and pads and damage to the cooktop caused by hardened spills of sugary materials or melted plastic that are not cleaned according to the directions in the use and care guide are not covered. SAMSUNG does not warrant uninterrupted or error-free operation of the product.

EXCEPT AS SET FORTH HEREIN, THERE ARE NO WARRANTIES OR CONDITIONS ON THIS PRODUCT EITHER EXPRESS OR IMPLIED AND SAMSUNG DISCLAIMS ALL WARRANTIES AND CONDITIONS INCLUDING, BUT NOT LIMITED TO, ANY IMPLIED WARRANTIES AND CONDITIONS OF MERCHANTABILITY, INFRINGEMENT, OR FITNESS FOR A PARTICULAR PURPOSE.

NO WARRANTY OR GUARANTEE GIVEN BY ANY PERSON, FIRM, OR CORPORATION WITH RESPECT TO THIS PRODUCT SHALL BE BINDING ON SAMSUNG.

SAMSUNG SHALL NOT BE LIABLE FOR LOSS OF REVENUE OR PROFITS, FAILURE TO REALIZE SAVINGS OR OTHER BENEFITS, OR ANY OTHER GENERAL, INDIRECT, SPECIAL, INCIDENTAL, OR CONSEQUENTIAL DAMAGES CAUSED BY THE USE, MISUSE, OR INABILITY TO USE THIS PRODUCT, REGARDLESS OF THE LEGAL THEORY ON WHICH THE CLAIM IS BASED, AND EVEN IF SAMSUNG HAS BEEN ADVISED OF THE POSSIBILITY OF SUCH DAMAGES.

NOR SHALL RECOVERY OF ANY KIND AGAINST SAMSUNG BE GREATER IN AMOUNT THAN THE PURCHASE PRICE OF THE PRODUCT SOLD BY SAMSUNG AND CAUSING THE ALLEGED DAMAGE. WITHOUT LIMITING THE FOREGOING, PURCHASER ASSUMES ALL RISK AND LIABILITY FOR LOSS, DAMAGE, OR INJURY TO PURCHASER AND PURCHASER'S PROPERTY AND TO OTHERS AND THEIR PROPERTY ARISING OUT OF THE USE, MISUSE, OR INABILITY TO USE THIS PRODUCT.

THIS LIMITED WARRANTY SHALL NOT EXTEND TO ANYONE OTHER THAN THE ORIGINAL PURCHASER OF THIS PRODUCT, IS NONTRANSFERABLE, AND STATES YOUR EXCLUSIVE REMEDY.

Some states or provinces do not allow limitations on how long an implied warranty lasts, or the exclusion or limitation of incidental or consequential damages, so the above limitations or exclusions may not apply to you.

This warranty gives you specific legal rights, and you may also have other rights which vary from state to state or province to province.

To obtain warranty service, please contact SAMSUNG at:

Samsung Electronics America, Inc.
85 Challenger Road Ridgefield Park, NJ 07660
1-800-SAMSUNG (726-7864) and www.samsung.com/us/support

Samsung Electronics Canada Inc.
2050 Derry Road West, Mississauga, Ontario L5N 0B9 Canada
1-800-SAMSUNG (726-7864) and www.samsung.com/ca/support (English)
www.samsung.com/ca_fr/support (French)

Registration

Please register your product online at www.samsung.com/register.

Questions

For questions about features, operation/performance, parts, accessories, or service, call 1-800-726-7864, or visit our Web site at www.samsung.com/us/support, www.samsung.com/ca/support (English), or www.samsung.com/ca_fr/support (French).

Model #

Serial #

Please attach your receipt (or a copy) to this manual. You may need it, along with your model and serial number, when calling for assistance.

Open Source Announcement

The software included in this product contains open source software. You may obtain the complete corresponding source code for a period of three years after the last shipment of this product by sending an email to <mailto:oss.request@samsung.com>.

It is also possible to obtain the complete corresponding source code in a physical medium such as a CD-ROM; a minimal charge will be required.

The following URL <http://opensource.samsung.com/opensource/SimpleConnectTP/seq/0> leads to the download page of the source code made available and open source license information as related to this product. This offer is valid to anyone in receipt of this information.



Memo

Memo



Scan the QR code* or visit www.samsung.com/spsn to view our helpful How-to Videos and Live Shows
*Requires reader to be installed on your smartphone

Scan this with your smartphone

Please be advised that the Samsung warranty does NOT cover service calls to explain product operation, correct improper installation, or perform normal cleaning or maintenance.

QUESTIONS OR COMMENTS

COUNTRY	CALL	OR VISIT US ONLINE AT
U.S.A Consumer Electronics	1-800-SAMSUNG (726-7864)	www.samsung.com/us/support
CANADA	1-800-SAMSUNG (726-7864)	www.samsung.com/ca/support (English) www.samsung.com/ca_fr/support (French)

DG68-00779A-01