

**SAMSUNG**

# E-MANUAL

Thank you for purchasing this Samsung product.  
To receive more complete service, please register your  
product at

[www.samsung.com/register](http://www.samsung.com/register)

Model \_\_\_\_\_ Serial No. \_\_\_\_\_

# Contents

## Quick Guides

Connecting the Samsung Smart Remote to the TV

Using Smart Hub

- 2 Using Smart Hub

Using Voice Interaction

- 3 Setting up Voice Interaction
- 3 Running Voice Interaction

## Connections

Connecting an Antenna

Connecting to the Internet

- 4 Connecting to your Internet network

Troubleshooting Internet Connectivity Issues

- 6 Troubleshooting wired Internet connectivity issues
- 7 Troubleshooting wireless Internet connectivity issues

Connecting Video Devices

- 8 Connecting with an HDMI cable
- 8 Connecting with a component cable (only for models with COMPONENT IN / AV IN)
- 9 Connecting with a composite cable (only for models with COMPONENT IN / AV IN)

Audio Input and Output Connections

- 10 Connecting with an HDMI (ARC) cable
- 10 Connecting with a digital audio (optical) cable
- 11 Connecting through wireless network
- 11 Connecting Bluetooth Devices

Connecting a Computer

- 12 Connecting through the HDMI port — Screen sharing
- 12 Connecting through the Smart View app — Content sharing

Connecting a Mobile Device

- 13 Using Smart View (Screen Mirroring) or contents sharing
- 13 Connecting mobile devices without a wireless router (Wi-Fi Direct)
- 13 Connecting a mobile device via the Smart View App

Switching between external devices connected to the TV

- 14 Changing the input signal
- 14 Editing external devices
- 14 Using additional functions

Connection Notes

- 15 Connection notes for HDMI
- 16 Connection notes for audio devices
- 16 Connection notes for computers
- 16 Connection notes for mobile devices

## Remote Control and Peripherals

About the Samsung Smart Remote (Voice Interaction version)

About the Samsung Smart Remote (No Voice Interaction)

Connecting to the Samsung Smart Remote

Controlling External Devices with the Samsung Smart Remote - Using the Universal Remote

Controlling the TV with a Keyboard or Gamepad

- 22 Connecting a USB keyboard
- 22 Connecting a Bluetooth keyboard and gamepad
- 22 Using the keyboard

Entering Text using the On-Screen QWERTY Keyboard

- 23 Using additional functions

## Smart Features

### Smart Hub

- 24 Displaying the Home Screen
- 26 Launching Smart Hub automatically
- 26 Testing Smart Hub connections
- 26 Resetting Smart Hub

### Using a Samsung account

- 26 Creating a Samsung account
- 27 Signing in to a Samsung account

### Using the GAMES Service

- 28 Installing and running a game
- 29 Managing purchased or installed games
- 30 Rating games

### Using the APPS Service

- 31 Installing and running an app
- 31 Managing purchased or installed apps
- 33 Rating apps
- 33 Using other app features and functions

### Using the e-Manual

- 33 Launching the e-Manual
- 33 Using the buttons in the e-Manual

### Using the Web Browser

### Playing pictures/video/music

- 35 Playing media content
- 35 Functions on the media content list screen

### Using Voice Interaction

- 36 Setting up Voice Interaction
- 36 Running Voice Interaction

## TV Viewing

### Viewing Broadcast Information at a Glance

- 37 Using the guide
- 38 Changing the broadcast signal
- 38 Checking digital channel signal info and strength

### Recording Programs

- 38 Recording programs
- 39 Managing the schedule recording list
- 39 Viewing recorded programs

### Setting Up a Schedule Viewing

- 40 Setting up a schedule viewing for a channel
- 40 Editing a schedule viewing

### Using Timeshift

### Using the Channel List

### Editing channels

- 42 Re-registering and deleting a channel
- 42 Editing registered channels
- 42 Using Program Rating Lock

### Creating a Personal Favorites List

- 43 Registering channels as favorites
- 43 Viewing and selecting channels on Favorites lists only

### Editing a Favorites List

- 44 Removing channels from a favorites list
- 44 Rearranging a favorites list
- 44 Renaming a favorites list

### Making Sports Programs More Realistic with Sports Mode

- 44 Extracting highlights automatically
- 45 Viewing a game recorded in sports mode

### TV-Viewing Support Functions

- 45 Scanning for available channels
- 46 Configuring advanced broadcasting settings
- 46 Selecting the broadcast audio language
- 46 Fine-tuning analog broadcasts

# Picture and Sound

## Adjusting the Picture Quality

- 47 Choosing a picture mode
- 47 Configuring advanced picture settings

## Picture Support Functions

- 49 Viewing a picture-in-picture (PIP)
- 49 Changing the picture size

## Adjusting the Sound Quality

- 50 Choosing a sound mode
- 50 Configuring advanced sound settings

## Using the Sound Support Functions

- 51 Selecting speakers
- 51 Listening to the TV with a Samsung audio device
- 52 Listening to the TV through Bluetooth devices
- 52 Listening to the TV through a Multiroom speaker

# System and Support

## Setting the Time and Using the Timer

- 53 Setting the current time
- 54 Using the timers

## Using the Screen Burn Protection and Energy Saving Functions

- 55 Preventing screen burn
- 55 Reducing the energy consumption of the TV

## Using Anynet+ (HDMI-CEC)

- 56 Connecting an external device through Anynet+ and using their menus

## Updating the TV's Software

- 57 Updating the TV's software to the latest version
- 57 Updating the TV automatically

## Protecting the TV from Hacking and Malicious Code

- 58 Checking the TV and connected storage for malicious code
- 58 Scanning for viruses in real time
- 58 Viewing scan results

## Using Other Functions

- 59 Running the accessibility functions
- 59 Enabling voice guides for the visually impaired
- 59 Enabling audio for the video description function
- 60 Showing captions
- 60 Adjusting the menu transparency
- 60 White text on black background (high contrast)
- 61 Enlarging the font (for the visually impaired)
- 61 Learning about the remote control (for the visually impaired)
- 61 Listening to the TV through Bluetooth devices (for the hearing impaired)
- 61 Configuring advanced system settings
- 63 Enabling game mode
- 63 Restoring the TV to the factory settings

# Troubleshooting

## Getting Support

- 64 Getting support through Remote Management
- 64 Finding the contact information for service
- 65 Requesting service

## Diagnosing TV operational issues

### There Is a Problem with the Picture

- 65 Testing the picture

### I Can't Hear the Sound Clearly

- 67 Testing the sound

### There Is a Problem with the Broadcast

### My Computer Won't Connect

### The TV Won't Connect to the Internet

### The Schedule Recording/Timeshift Function Isn't Working

### Anynet+ (HDMI-CEC) Isn't Working

### I Have Trouble Launching/Using Apps

### My File Won't Play

### I Want to Reset the TV

### Other Issues

# Precautions and Notes

## Before Using the Recording and Timeshift Functions

- 74 Before using the recording and schedule recording functions
- 75 Before using the timeshift function

## Supported Resolutions for UHD Input Signals

- 76 If HDMI UHD Color is set to Off
- 76 If HDMI UHD Color is set to On

## Read Before Using Voice Interaction

- 77 Precautions for voice interaction
- 77 Requirements for using voice interaction

## Read Before Using Apps

## Read Before Using the Internet

## Read Before Playing Photo, Video, or Music Files

- 80 Limitations on use of photo, video, and music files
- 81 Supported external subtitles
- 81 Supported internal subtitles
- 82 Supported image formats and resolutions
- 82 Supported music formats and codecs
- 83 Supported video codecs

## Read After Installing the TV

- 85 Picture sizes and input signals
- 86 Installing an anti-theft lock
- 86 Read before setting up a wireless Internet connection

## Read Before Connecting a Computer (Supported Resolutions)

- 87 IBM
- 87 MAC
- 88 VESA DMT

## Supported Resolutions for Video Signals

89 CEA-861

## Read Before Using Bluetooth Devices

90 Restrictions on using Bluetooth

## Blocking programs based on their TV Rating

92 Blocking movies base on their Movie Rating (MPAA)

92 Blocking programs based on their Canadian English Rating

93 Blocking programs based on their Canadian French Rating

93 Blocking Programs based on their Downloadable U.S. Rating

## Buttons and Functions

94 Buttons and functions available while playing multimedia content

96 Buttons and functions available while using sports mode

97 Buttons and functions available while recording a program or Timeshift



## License

# Connecting the Samsung Smart Remote to the TV

Connect the Samsung Smart Remote to your TV to operate the TV.

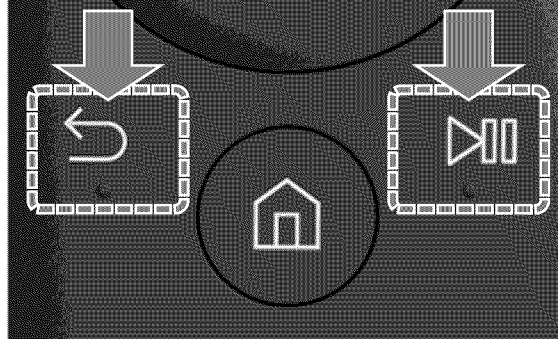
When you turn on the TV for the first time, the Samsung Smart Remote pairs to the TV automatically. If the Samsung Smart Remote does not pair to the TV automatically, point it at the remote control sensor of the TV, and then press and hold the Return and Play/pause buttons simultaneously for 3 seconds or more.



-  The images, buttons, and functions of the Samsung Smart Remote may differ by model.
-  For more information, refer to "[About the Samsung Smart Remote \(Voice Interaction version\)](#)."
-  Availability depends on the specific model.

# Using Smart Hub

Connect to Smart Hub for apps, games, movies, and more.

## Using Smart Hub

Enjoy the multiple functions provided by Smart Hub simultaneously on a single screen.

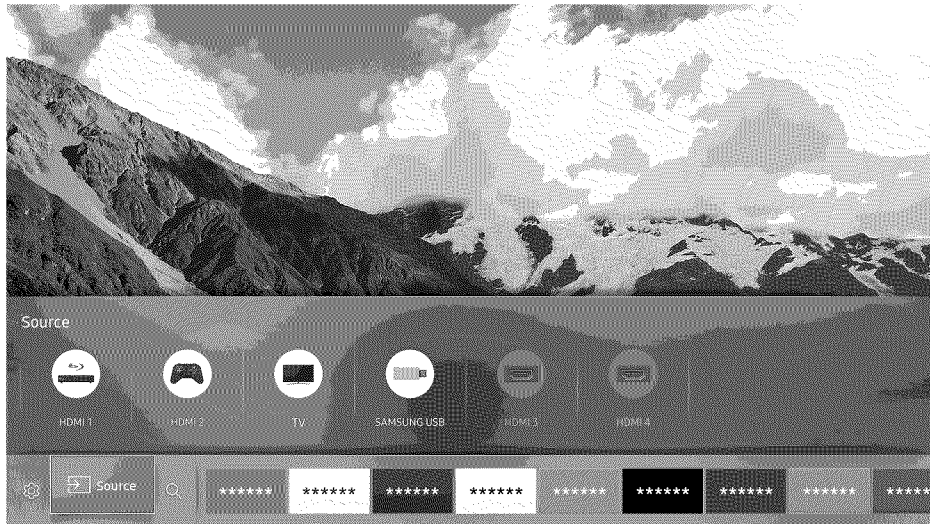

When you press the  button on your remote control, you can use the following functions and features.

-  Settings

When the focus is moved, a quick settings appears on the top of the menu. You can quickly set frequently used functions.

-  Source

You can select an external device connected to the TV.

 For more information, refer to "[Switching between external devices connected to the TV.](#)"

-  Search

You can search data for channels, programs, movie titles, and apps from Smart Hub.

 The image on your TV may differ from the image above depending on your model and geographical area.

 For more information, refer to "[Smart Hub.](#)"



# Using Voice Interaction

Speak into the microphone on your Samsung Smart Remote to control your TV.

 Availability depends on the specific model.

## Setting up Voice Interaction

Turning the TV's verbal response (voice) on/off

 >  Settings > System > Expert Settings > Voice Interaction > Voice Feedback



Turn Voice Feedback on to have the TV respond verbally to your voice commands.

Selecting the voice's gender

 >  Settings > System > Expert Settings > Voice Interaction > Voice Gender

You can select the gender of the voice that responds to your voice commands.

## Running Voice Interaction

Press and hold the  button on your Samsung Smart Remote, say a command, and then release the  button. The TV recognizes the voice command.

 If the command is not recognized, try again with clearer pronunciation.



## Connecting an Antenna

You can connect an antenna cable to your TV.

- ✎ An antenna connection is not necessary if you connect a cable or satellite box.

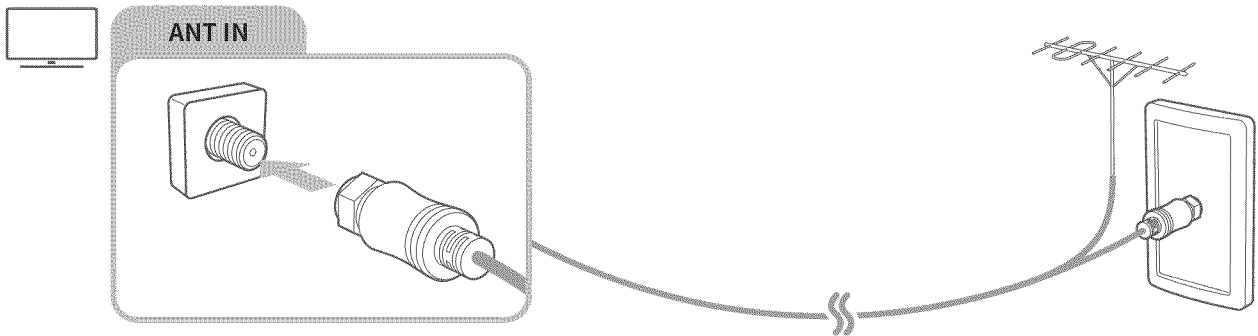

## Connecting to the Internet

You can get access to the Internet through your TV.

### Connecting to your Internet network

🏠 > ⚙️ Settings > Network > Open Network Settings **TV/PC**

Connect to an available network.

### Establishing a wired Internet connection

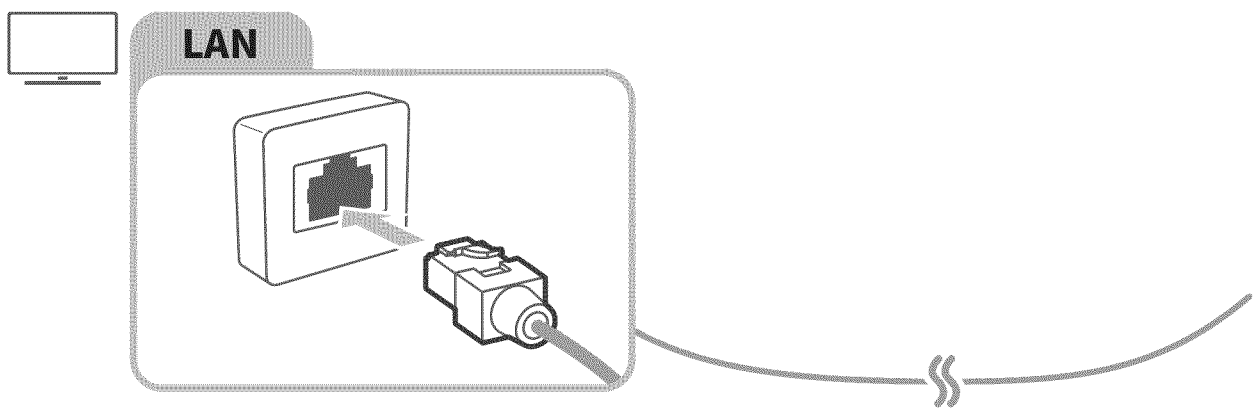

- ✎ If you connect a LAN cable, the TV automatically accesses the Internet.
- ✎ Use a CAT 7 (\*STP type) cable for the connection.  
\* Shielded Twist Pair
- ✎ The TV will not be able to connect to the Internet if your network speed is below 10 Mbps.

## Establishing a wireless Internet connection

🏠 > ⚙️ Settings > Network > Open Network Settings > Wireless

Make sure that you have the wireless router's SSID (name) and password settings before attempting to connect, and then follow the directions on the screen.

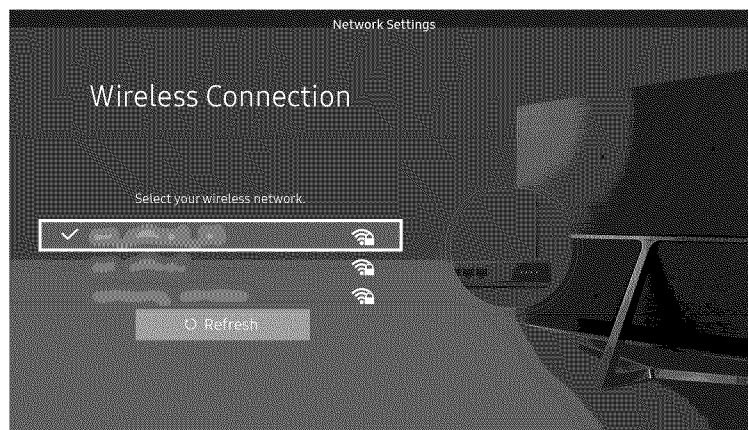
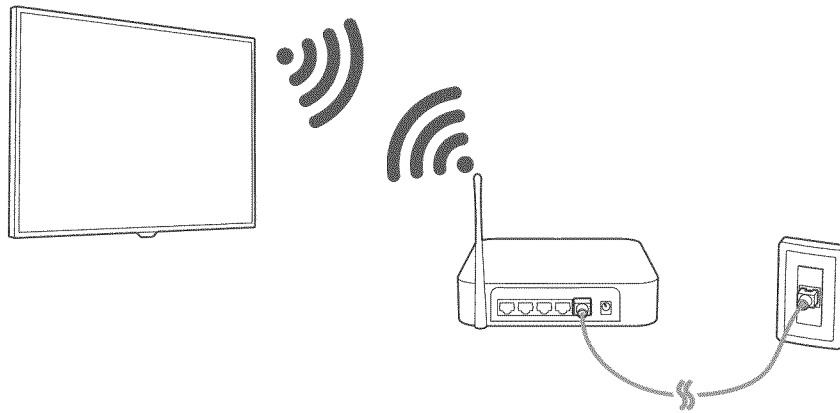

- ✎ The image on your TV may differ from the image above depending on your model and geographical area.
- ✎ If there is no wireless router found, select **Add Network** at the bottom of the list and enter the network name (SSID).
- ✎ If a wireless router has a WPS or PBC button, select **Use WPS** at the bottom of the list and click the button. Then the TV is automatically connected.

## Checking the Internet connection status

🏠 > ⚙️ Settings > Network > Network Status **Try Now**

View the current network and Internet status.

## Changing the name of the TV on a network

🏠 > ⚙️ Settings > Network > Device Name **Try Now**

You can change the name of the TV on the network. Select **User Input** at the bottom of the list and change the name.

# Troubleshooting Internet Connectivity Issues

If your TV won't connect to the Internet, try the solutions below.

## Troubleshooting wired Internet connectivity issues [Try Now](#)

After reading the following content, troubleshoot the wired Internet connection issue. If the problem persists, contact your Internet Service Provider.

### No network cable found

Make sure that the LAN cable is plugged in on both ends. If it is plugged in, make sure that the router is turned on. If the router is on, try turning it off and then on.

### IP auto setting failed

1. Configure the settings in IP Settings.
2. Make sure that the DHCP server is enabled on the router, and then reset the router.

### Unable to connect to the network

1. Check all IP Settings.
2. After checking the DHCP server status (must be active) on the router, remove the LAN cable and connect it again.

### Connected to a local network, but not to the Internet

1. Make sure that the Internet LAN cable is connected to the router's external LAN port.
2. Check the DNS values in IP Settings.

### Network setup is complete, but unable to connect to the Internet

If the problem persists, contact your Internet Service Provider.

## Troubleshooting wireless Internet connectivity issues

After reading the following content, troubleshoot the wireless Internet connection issue. If the problem persists, contact your Internet Service Provider.

### Wireless network connection failed

If a selected wireless router is not found, go to **Open Network Settings**, and then select the correct router.

### Unable to connect to a wireless router

1. Check if the router is turned on. If it is, turn it off and then on.
2. Enter the correct password if required.

### IP auto setting failed

1. Configure the settings in **IP Settings**.
2. Make sure that the DHCP server is enabled on the router. Then, unplug the router and plug it back in.
3. Enter the correct password if required.

### Unable to connect to the network

1. Check all **IP Settings**.
2. Enter the correct password if required.

### Connected to a local network, but not to the Internet

1. Make sure that the Internet LAN cable is connected to the router's external LAN port.
2. Check the DNS values in **IP Settings**.

### Network setup is complete, but unable to connect to the Internet

If the problem persists, contact your Internet Service Provider.

# Connecting Video Devices

Make the correct video connections between your TV and your external devices.

## Connecting with an HDMI cable

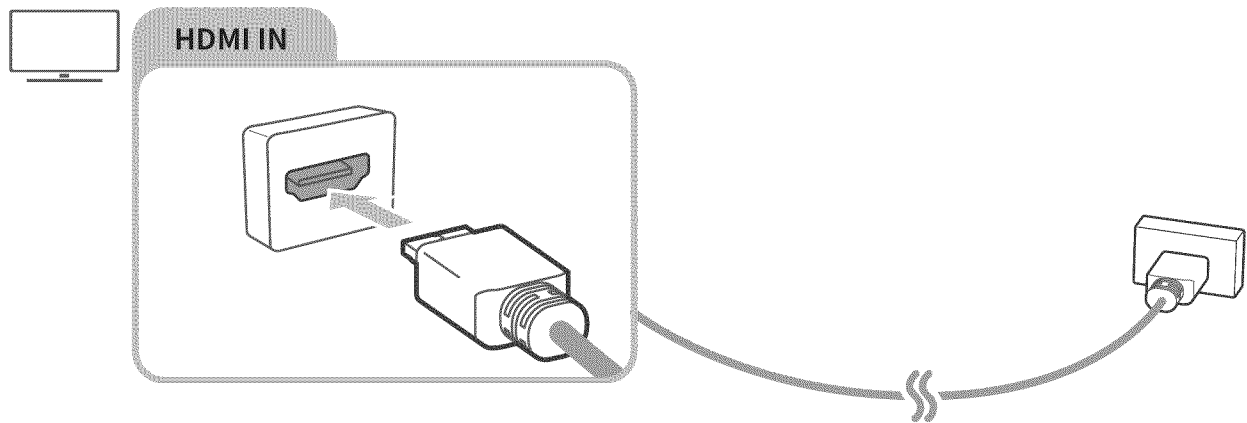

## Connecting with a component cable (only for models with COMPONENT IN / AV IN)

After referencing the figure below, connect the Component IN on the TV to the Component OUT of the external device by using the provided adapter and component cable. Make sure to connect the same color connectors together. (blue to blue, yellow to yellow, etc.)

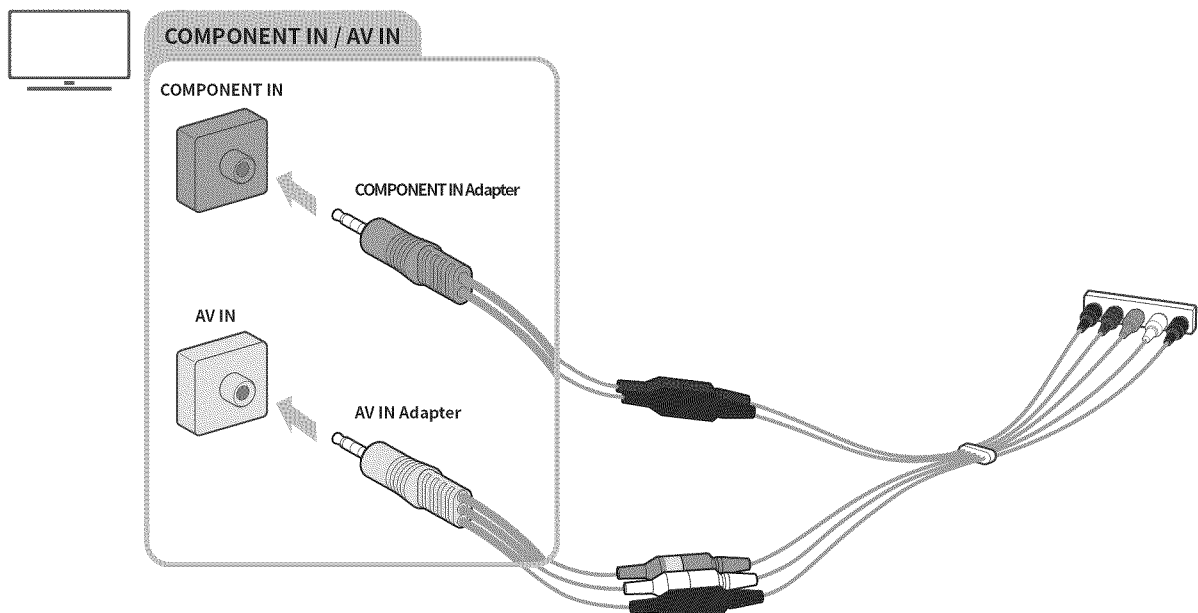

 To use component equipment, connect both a component cable (blue) and an AV cable (yellow).

## Connecting with a composite cable (only for models with COMPONENT IN / AV IN)

After referencing the figure below, connect the AV IN on the TV to the AV OUT of the external device by using the provided adapter and composite cable. When connecting the cables, be sure to match the colors between the cables and ports.

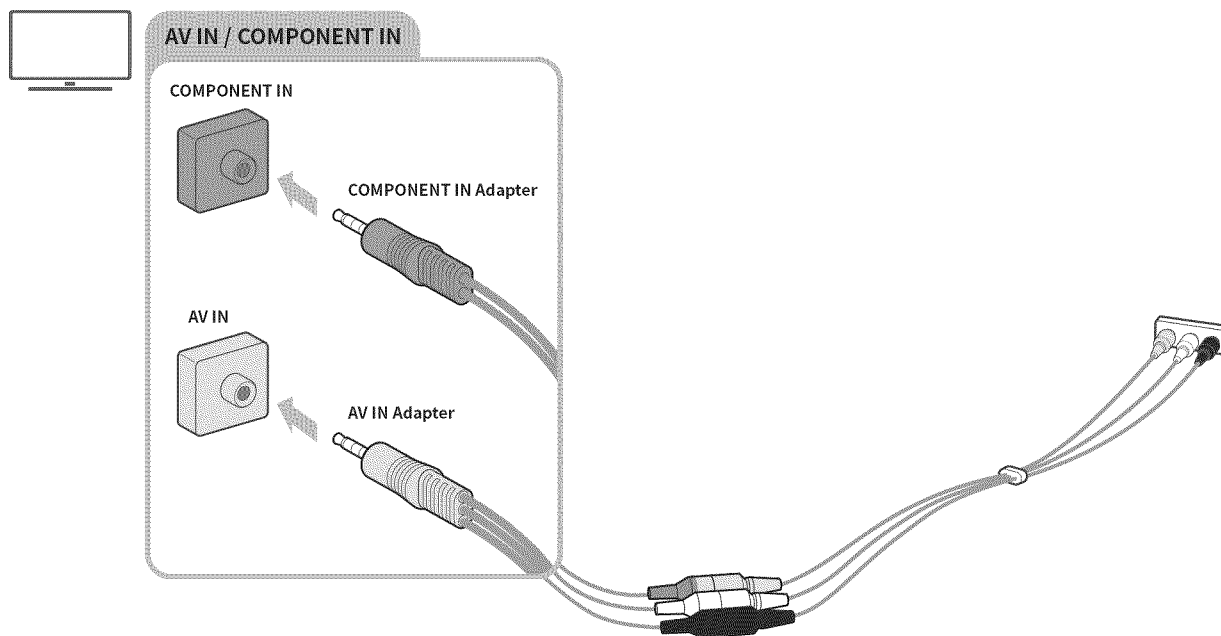

 Connect AV (composite) equipment to AV In only. Do not connect to Component In.

# Audio Input and Output Connections

Make the correct audio connections between your TV and your external devices.

## Connecting with an HDMI (ARC) cable

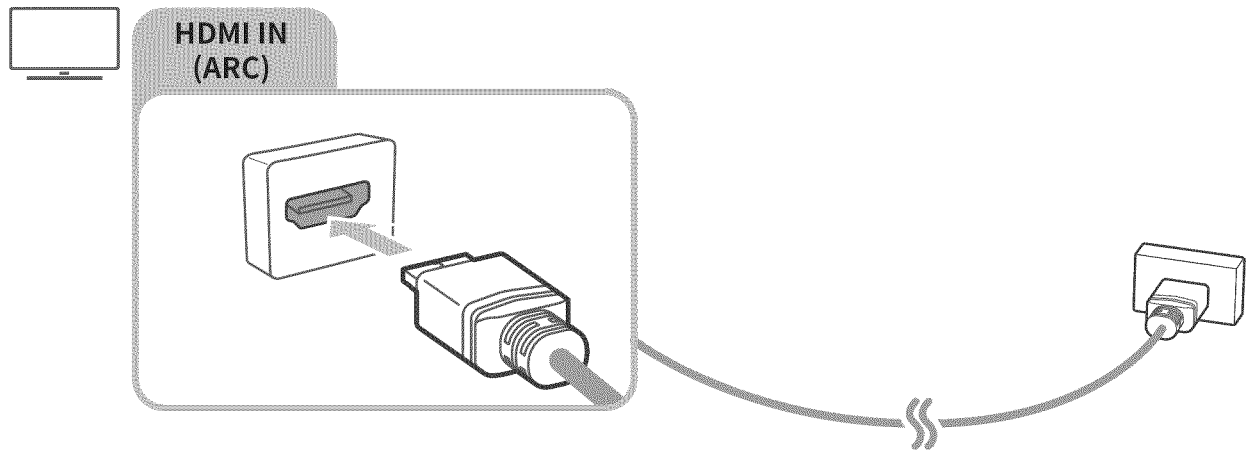

## Connecting with a digital audio (optical) cable

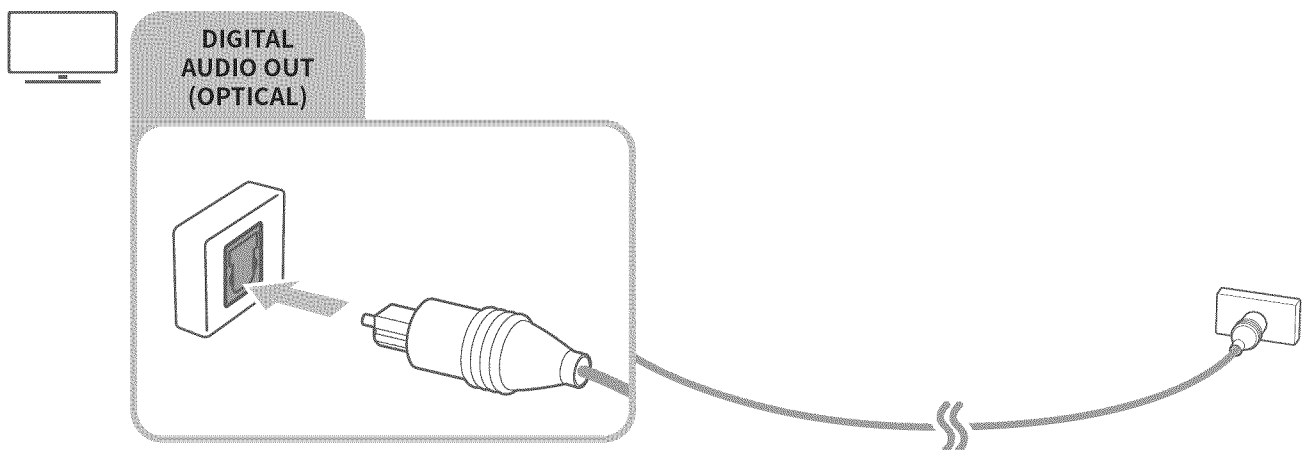



## Connecting through wireless network

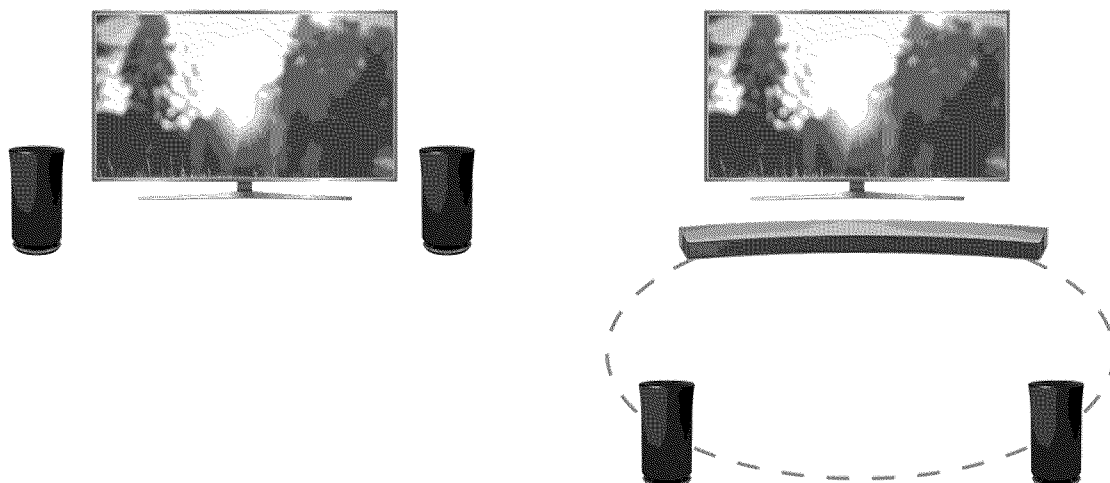

You can connect the TV to a Samsung wireless audio device through wireless network. At this time, two devices must be connected on the same network. For more information, refer to [Wireless Speaker Manager](#) (🏠 > ⚙️ Settings > Sound > Expert Settings > Wireless Speaker Manager).

## Connecting Bluetooth Devices

You can connect the TV or audio devices via Bluetooth. For more information, refer to the [Connection Guide](#) (🏠 > 📧 Source > Connection Guide).

 This function is not available on certain models in specific geographical areas.

# Connecting a Computer

Use the TV as a computer monitor or connect the TV to a computer via your network and access the computer's content.

## Connecting through the HDMI port — Screen sharing

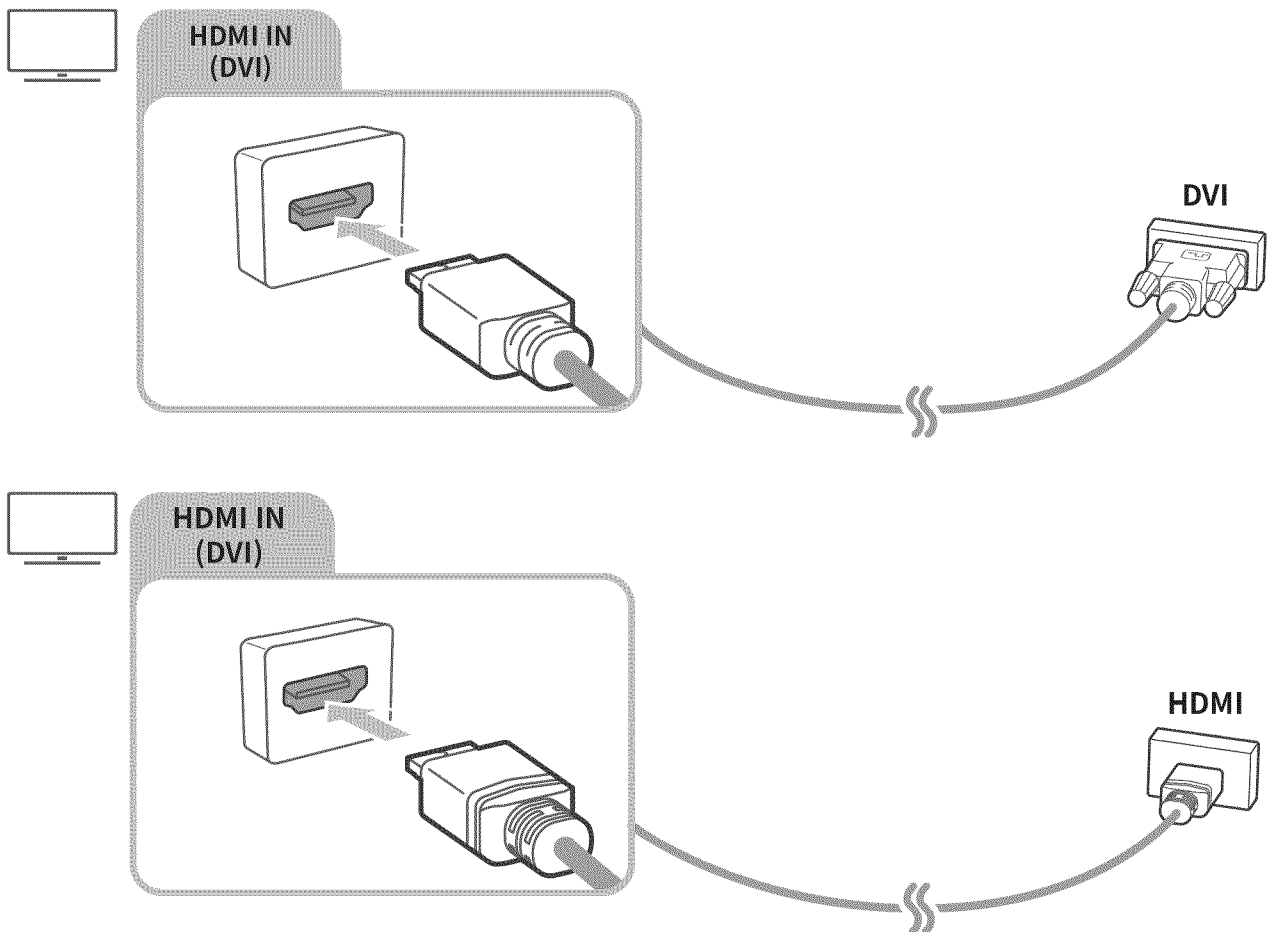

 When your PC is connected, select PC for the **Device Icon**. For more information about the port settings, refer to "[Editing external devices.](#)"

## Connecting through the Smart View app — Content sharing



When the TV is connected through the Smart View program on your PC, you can easily play content for photos, videos, and audios through the TV. For more information, refer to the Connection Guide ([Home > Source > Connection Guide](#)).

# Connecting a Mobile Device

View a mobile device's screen by connecting the mobile device to your TV or network.

## Using Smart View (Screen Mirroring) or contents sharing

You can play media content saved on your mobile device on the TV's screen and share contents by connecting with the mirroring function.

1. Launch the Smart View (Screen Mirroring) function on your mobile device. The mobile device searches for available devices to connect to.
2. Select the TV from the list. The TV connects to the mobile device.
  -  If your mobile device does not find your TV, turn the TV and the mobile device off and then on and try again.
  -  If there are multiple TVs, you can easily select any of different TV names in [Home](#) > [Settings](#) > [Network](#) > [Device Name](#).

## Connecting mobile devices without a wireless router (Wi-Fi Direct)

[Home](#) > [Settings](#) > [Network](#) > [Expert Settings](#) > [Wi-Fi Direct](#)

-  To use Wi-Fi Direct, the Wi-Fi Direct function in the mobile device must be active.

## Connecting a mobile device via the Smart View App

When you install the Smart View App on your mobile device, you can play the mobile device's multimedia content on your TV or control the TV using the mobile device. You can download the app from Google Play Store, Samsung Apps, or the App Store.

-  To use the Smart View function, the mobile device must support the mirroring function such as AllShare Cast and Smart View. To check whether your mobile device supports the mirroring function, please visit the mobile device manufacturer's website.

# Switching between external devices connected to the TV

You can switch between TV programs and the content of external devices.

## Changing the input signal

🏠 > 📺 Source

When you select a connected external device on the Source screen, the output of the selected device is displayed on the TV's screen.

- ✎ In case of the models that support the universal remote control, connect an external device (e.g. Blue-ray device, game console) to the HDMI port and turn on the device. Then a pop-up message appears to switch to the device or automatically configure the settings. For automatic configuration for the universal remote control, turn on the external device and point the remote control to the device. Note that this function may not be supported depending on the device type.
- ✎ When a USB device is connected to the USB port, a pop-up message appears that lets you switch easily to the media content listed on the device.

## Editing external devices

🏠 > 📺 Source

You can change the port name for a connected external device or add it to Home Screen.

1. Move the focus to the device to edit.
2. Press the Up directional button. The following functions become available. (Note that available functions may differ with the port type.)
  - Edit: You can change the port name of an external device for easy identification.
  - Add to Home: You can add the port of an external device to the Home Screen for quick switching.



## Using additional functions

You can use the following features on the Source screen.

- **Connection Guide:** The guide to device connections
- **Universal Remote Setup:** The function that lets you register external devices to your Samsung Smart Remote
  - ✎ This function is not available on certain models in specific geographical areas.
  - ✎ For more information, refer to "[Controlling External Devices with the Samsung Smart Remote - Using the Universal Remote.](#)"

# Connection Notes

When connecting an external device, note the following:

-  The number of connectors and their names and locations may differ with the model.
-  Refer to the external device's operating manual when connecting it to the TV. The number of external device connectors and their names and locations may differ with the manufacturer.

## Connection notes for HDMI

- The following types of HDMI cables are recommended:
  - High-Speed HDMI Cable
  - High-Speed HDMI Cable with Ethernet
- Use an HDMI cable with a thickness of 0.66 inches (17 mm) or less.
- Using a non-certified HDMI cable may result in a blank screen or a connection error.
- Some HDMI cables and devices may not be compatible with the TV due to different HDMI specifications.
- This TV does not support HDMI Ethernet Channel. Ethernet is a Local Area Network (LAN) built with coaxial cables standardized by the IEEE.
- Use a cable shorter than 10 feet (3m) to get the best UHD viewing quality.
- Many computer graphics adaptors do not have HDMI ports, but have DVI ports instead. When the PC that does not support HDMI video out, connect your PC with the HDMI-DVI cable.
-  For more information, refer to "[Connecting a Computer](#)."

## Connection notes for audio devices

- For better audio quality, it is a good idea to use an AV receiver.
- Connecting a device using an optical cable does not automatically turn off the TV speakers. To turn off the TV's speakers, set **Sound Output** to something other than **TV Speaker**.
- An unusual noise coming from a connected audio device while you are using it may indicate a problem with the audio device itself. If this occurs, ask for assistance from the audio device's manufacturer.
- Digital audio is only available with 5.1-channel broadcasts.

## Connection notes for computers

- For the resolutions supported by the TV, refer to "[Read Before Connecting a Computer \(Supported Resolutions\)](#)."
- As long as file sharing is activated, unauthorized access may occur. When you do not need to access data, disable file sharing.
- Your PC and Smart TV must be connected to each other on the same network.







## Connection notes for mobile devices

- To use the Smart View function, the mobile device must support a mirroring function such as AllShare Cast or Smart View. To check whether your mobile device supports the mirroring function, please visit the mobile device manufacturer's website.
- To use Wi-Fi Direct, the mobile device must support the Wi-Fi Direct function. Please check if your mobile device supports Wi-Fi Direct.
- The mobile device and your Smart TV must be connected to each other on the same network.
- The video or audio may stop intermittently, depending on network conditions.

## About the Samsung Smart Remote (Voice Interaction version)

Voice Interaction is available for Samsung Smart Remotes that have a microphone. However, this function may not be supported depending on the model or geographical region.



Button	Description
 (Voice recognition)	Runs Voice Interaction. Press the button, say a voice command, and then release the button to run Voice Interaction. When pressed once, the guide to Voice Interaction appears.
123 (Number pad)	When pressed, a number strip appears on the screen. Select numbers and then select Done to enter a numeric value. Use to change the channel, enter a PIN, enter a ZIP code, etc. If the Color Button appears with a number strip on the screen, select the Color Button and then select a specific color by using the directional pad (up/down/left/right). Use this to access additional options that are specific according to the feature in use.
EXTRA	While watching content, press to display extra information from the content provider.
	Use these colored buttons to access additional options that are specific according to the feature in use.  These buttons are not available in the U.S.A. and Canada.
Directional pad (up/down/left/right)	Moves the focus and changes the values seen on the TV's menu.
Select	Selects or runs a focused item. When pressed while you are watching content, detailed program information appears.
 (Return)	Press to return to the previous menu. When pressed for 1 second or more, the running function is terminated. When pressed while you are watching a program, the previous channel appears.
 (Smart hub)	Press to return to the Home Screen.
 (Play/pause)	When pressed, the playback controls appear. Using these controls, you can control the media content that is playing.
VOL (Volume)	Move the button up or down to adjust the volume. To mute the sound, press the button. When pressed for 1 second or more, the Accessibility Shortcuts appears.
CH (Channel)	Move the button up or down to change the channel. To see the Guide screen, press the button.

 Use the Samsung Smart Remote less than 20 feet from the TV. The usable distance may vary with the wireless environmental conditions.

 The images, buttons, and functions of the Samsung Smart Remote may differ with the model.





 To use the Samsung Smart Remote through the external device, it is required to configure its settings. For more information, refer to "[Controlling External Devices with the Samsung Smart Remote - Using the Universal Remote.](#)"



# About the Samsung Smart Remote (No Voice Interaction)

Functions available on the Samsung Smart Remote may differ by model or geographical region.



Button	Description
123 (Number pad)	<p>When pressed, a number strip appears on the screen.</p> <p>Select numbers and then select Done to enter a numeric value. Use to change the channel, enter a PIN, enter a ZIP code, etc.</p> <p>If the Color Button appears with a number strip on the screen, select the Color Button and then select a specific color by using the directional pad (up/down/left/right). Use this to access additional options that are specific according to the feature in use.</p>
EXTRA	While watching content, press to display extra information from the content provider.
	<p>Use these colored buttons to access additional options that are specific according to the feature in use.</p> <p>These buttons are not available in the U.S.A. and Canada.</p>
Directional pad (up/down/left/right)	Moves the focus and changes the values seen on the TV's menu.
Select	Selects or runs a focused item. When pressed while you are watching content, detailed program information appears.
 (Return)	Returns to the previous menu. When pressed for 1 second or more, the running function is terminated. When pressed while you are watching a program, the previous channel appears.
 (Smart hub)	Press to return to the Home Screen.
 (Play/pause)	When pressed, the playback controls appear. Using these controls, you can control the media content that is playing.
VOL (Volume)	Move the button up or down to adjust the volume. To mute the sound, press the button. When pressed for 1 second or more, the Accessibility Shortcuts appears.
CH (Channel)	Move the button up or down to change the channel. To see the Guide screen, press the button.

 The images, buttons, and functions of the Samsung Smart Remote may differ with the model.

 Some Samsung Smart Remotes do not support certain functions. They are listed below.

**BN59-01260A:** Does not support Voice Interaction.

**BN59-01259B and BN59-01259E:** Does not support Voice Interaction, pairing, and Universal Remote Control.

You can find the model number of the remote on the inside of the battery cover. Open the battery cover to view.

# Connecting to the Samsung Smart Remote

Pair the TV with the Samsung Smart Remote.

 Availability depends on the specific model.

When you turn on the TV for the first time, the Samsung Smart Remote pairs to the TV automatically. If the Samsung Smart Remote does not pair to the TV automatically, point it at the remote control sensor of the TV, and then press and hold the Return and Play/pause buttons simultaneously for 3 seconds or more.

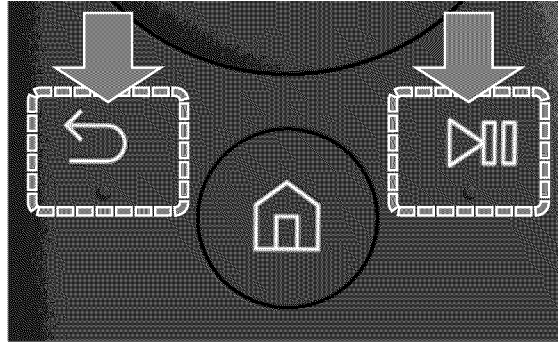





## Controlling External Devices with the Samsung Smart Remote - Using the Universal Remote

Control the TV and connected external devices with the Samsung Smart Remote.

 >  Source > Universal Remote Setup

You can control external devices connected to the TV by using the remote control. To control external devices, register them by following the instructions on the screen.

-  Availability depends on the specific model.
-  You can also use the **Anynet+ (HDMI-CEC)** function to operate external Samsung devices with your TV's remote control without any additional setup. For more information, refer to "[Using Anynet+ \(HDMI-CEC\)](#)."
-  Certain external devices connected to the TV may not support the universal remote feature.
-  Do not place any obstacles in front of an external device. It may cause signals from the remote control not to be transmitted properly.
-  The TV memorizes both the external device and its connection port (HDMI 1, HDMI 2, etc.).

# Controlling the TV with a Keyboard or Gamepad

Connecting a keyboard or gamepad makes it easier to control the TV.

## Connecting a USB keyboard





Plug the keyboard cable into the USB port.

## Connecting a Bluetooth keyboard and gamepad

🏠 > ⚙️ Settings > System > Input Device Manager > Add Bluetooth Keyboard & Gamepad

- ✎ This function is not available on certain models in specific geographical areas.
- ✎ If your device was not detected, position the keyboard close to the TV, and then select **Refresh**. The TV scans for available devices again.

## Using the keyboard

Keyboard	Remote control functions
Directional keys	Moves the focus
Windows key	Displays the TV settings
Enter key	Selects or runs a focused item
ESC key	Returns to the previous screen
F1 / F2 / F3 / F4 key	Color buttons —  /  /  / 
F5 key	Launches the Home Screen
F6 key	Displays the source screen
F7 key	Launches the Channel List
F8 key	Mutes the sound
F9 / F10 key	Adjusts the volume
F11 / F12 key	Changes the channel

## Setting up the keyboard

In  >  Settings > System > Input Device Manager, you can set the following functions.

- Keyboard Language
- Keyboard Type
- Input Language Shortcut

## Entering Text using the On-Screen QWERTY Keyboard

Use the QWERTY keyboard to enter text on your TV.

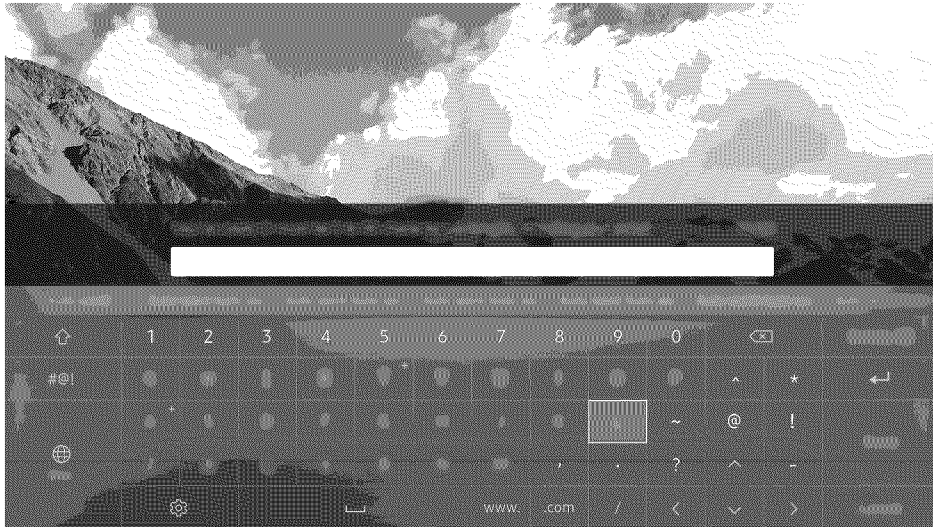

 The image on your TV may differ from the image above depending on your model and geographical area.

## Using additional functions

Select  on the QWERTY keyboard screen. The following options are available:

 The options available may differ depending on the function running currently.

- Recommended text
- Reset recommended text data
- Predict Next Character (when using direction buttons)
- Language

# Smart Hub





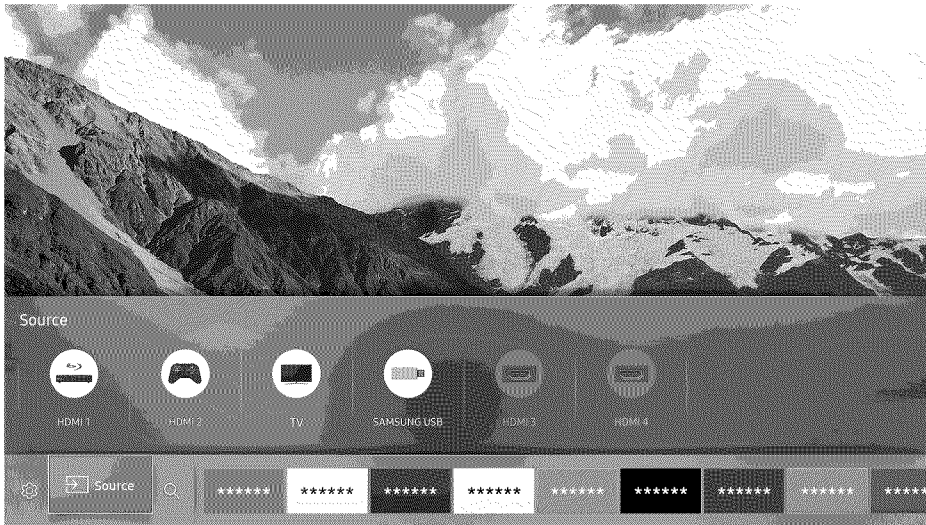



View descriptions of Smart Hub's basic functions.

Press the  button.



 The image on your TV may differ from the image above depending on your model and geographical area.

After pressing the  button on your remote control, you can surf the web and download apps with Smart Hub.

-  Some of the **Smart Hub** services are paid services. To use a paid service, you must have an account with the service provider or a Samsung account. For more information, refer to "[Using a Samsung account.](#)"
-  To use Smart Hub, the TV must be connected to the Internet.
-  Some **Smart Hub** features may not be available depending on the service provider, language, or region.
-  Smart Hub service outages can be caused by disruptions in your Internet service.
-  You can view the entire text of the **Terms & Policy** document by navigating to  >  **Settings** > **Support** > **Terms & Policy**. If you want to stop using **Smart Hub**, you can cancel the agreement. 

## Displaying the Home Screen

On the Home Screen, you can easily run the apps that have been used previously or frequently. The apps can also be moved or deleted from the screen.

When you press the  button on your remote control, you can use the following functions and features.

-  **Settings**

When the focus is moved, a quick settings appears on the top of the menu. You can quickly set frequently used functions.

- **Picture Mode**

You can select the picture mode that provides the best viewing experience.

- **Sound Output**

You can select which speakers the TV uses for audio output.

- **Sound Mode**

You can select a sound mode to optimize your listening experience.

- **Caption**

You can watch TV broadcasts with captions.

 This function is not available on certain models in specific geographical areas.

- **PIP**

While using a connected external device, you can watch a TV broadcast in a small picture-in-picture (PIP) window.

 This function is not available in the U.S.A. and Canada.

 This function is not available on certain models in specific geographical areas.

- **Network**

You can view the current network and Internet status.

- **Sleep Timer**

You can automatically shut off the TV after a pre-set period of time.

- **More**

Displays TV settings.

-  **Source**

You can select an external device connected to the TV.

 For more information about connecting external devices, refer to "[Switching between external devices connected to the TV.](#)"

-  **Search**

You can search the apps or games in Smart Hub services.

## Removing an item on the Home Screen

To remove an item on the Home Screen, move the focus to the item you want to remove, press the down directional button, and then select Remove.

## Moving an item on the Home Screen

To move an item on the Home Screen, move the focus to the item you want to move to a new position, press the down directional button, and then select Move.

## Launching Smart Hub automatically

🏠 > ⚙️ Settings > System > Expert Settings > Autorun Smart Hub

When you set Autorun Smart Hub to On, the TV displays the Home Screen automatically when you turn the TV on.

## Testing Smart Hub connections

🏠 > ⚙️ Settings > Support > Self Diagnosis > Start Smart Hub Connection Test

## Resetting Smart Hub

🏠 > ⚙️ Settings > Support > Self Diagnosis > Reset Smart Hub

## Using a Samsung account

Create and manage your own Samsung account.



## Creating a Samsung account

🏠 > ⚙️ Settings > System > Samsung Account > Create Account

Some of the Smart Hub services are paid services. To use a paid service, you must have an account with the service provider or a Samsung account.

- ✎ You can view the entire text of the Terms & Policy in 🏠 > ⚙️ Settings > System > Samsung Account > Samsung account Terms & Conditions, Privacy Policy after logging in to your Samsung account.
- ✎ You can also create a Samsung account at <http://content.samsung.com>. Once you have an account, you can use the same ID on both the TV and the Samsung website.





-  If you want to review the Terms and Conditions, select **View Details**.
-  If you want your account to be protected, select **Profile image selection and password entry (High security)** in the field below the password field.
-  If you want the TV to log you in to your account automatically when you turn the TV on, click **Sign me in automatically**.

## Creating a Samsung account using a Facebook account

 >  **Settings** > **System** > **Samsung Account** > **Create with Facebook**

## Signing in to a Samsung account

 >  **Settings** > **System** > **Samsung Account** > **Sign In**

## Changing and adding information to a Samsung account

 >  **Settings** > **System** > **Samsung Account** > **Edit Profile**

-  To change the account information, you must be logged in to your Samsung account.

## Managing payment information saved on the TV

 >  **Settings** > **System** > **Samsung Account** > **Payment info**

-  To manage the payment information, you must be logged in to your Samsung account.

## Deleting a Samsung account from the TV

 >  **Settings** > **System** > **Samsung Account** > **Remove Account**

-  To remove the account information, you must be logged in to your Samsung account.

# Using the GAMES Service

Enjoy games provided with Smart Hub.

 Availability depends on the specific model.

 > GAMES

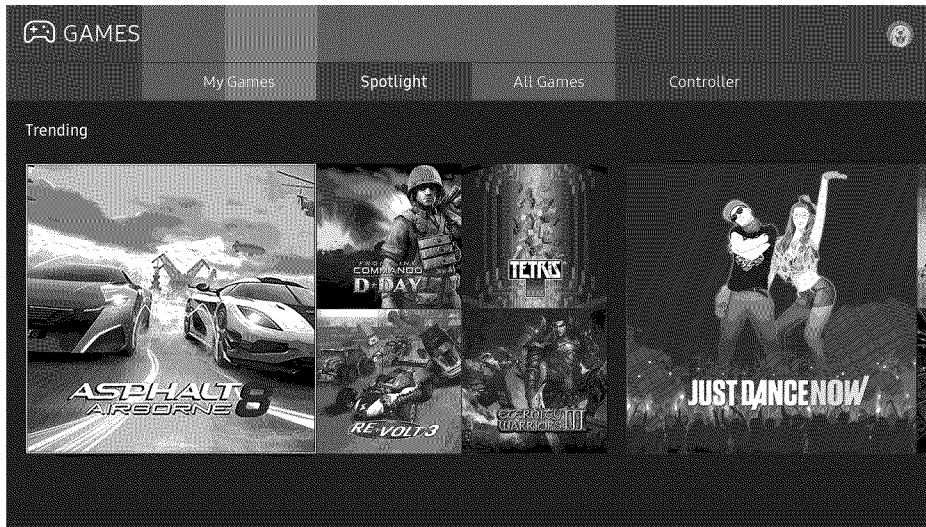

 The image on your TV may differ from the image above depending on your model and geographical area.

You can install or run games. The installed games are stored in My Games.

 This function is not available on certain models in specific geographical areas.

## Installing and running a game

### Installing games

1. Move to the game you want to install, and then press the Select button. The detailed information screen appears.
2. Select Install. When the installation is complete, you can run it immediately.

 You can see the installed games on the **My Games** screen.

 To get the information about the game controllers that are compatible with the downloaded game, select **GAMES > Controller**.

 When the TV's internal memory is insufficient, you can install a game on a USB device.

 You can play a game installed on a USB device only when the USB device is connected to the TV. If the USB device is disconnected during game playing, the game is terminated.

 You cannot play a game installed on a USB device on a PC or another TV.

## Running an installed game

To run a game, select **GAMES > My Games**.

## Managing purchased or installed games

On the **My Games** screen, move the focus to the desired game, and then press and hold the **Select** button. You can also, select **My Games > Options** to manage installed games.

### Adding a game to the Home Screen

1. Select **My Games > Options > Add to Home**.
2. Select a game to add to the Home Screen. The selected game is added to the Home Screen.

### Removing a game

1. Select **My Games > Options > Delete**.
2. Select a game to delete.
3. Select **Delete**. The selected game is deleted.

### Updating a game

1. Select **My Games > Options > Update**.
  2. Select a game to update.
  3. Press the **Select** button. The game is updated.
-  Update can only be selected when there are updates available.

### Locking or Unlocking a game

1. Select **My Games > Options > Lock/Unlock**. Check boxes appear for individual games.
2. Select a game to lock or unlock. To lock a game, click on it to check it. To unlock the game, click on it to remove the check.
3. Select **Done**. The selected games are locked or unlocked.

## Automatically updating games

The installed games can be automatically updated. If you do not want games automatically updated, set **My Games > Options > Auto Update to Off**.

 Automatic update is enabled only when the TV is connected to the Internet.

## Rating games

You can rate each game in the detailed information screen.

 This feature is only available when the game is installed on your TV.

## Using the APPS Service

Download and run various apps from Smart Hub.

 > APPS

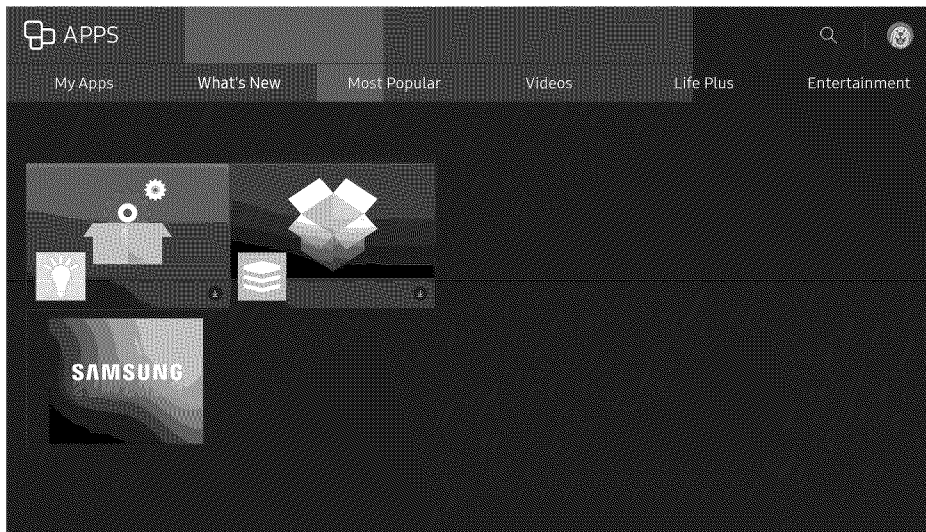

 The image on your TV may differ from the image above depending on your model and geographical area.

You can enjoy a wide range of content including news, sports, weather, and games by installing the corresponding apps on your TV.

 To use this feature, the TV must be connected to the Internet.

 When Smart Hub is launched for the first time, the default apps are automatically installed. The default apps may differ with the geographical area.

# Installing and running an app

## Installing an app

1. Move to the app you want to install, and then press the Select button. The detailed information screen appears.
2. Select **Install**. When the installation is complete, you can run it immediately.

 You can view installed apps on the **My Apps** screen.





 When the TV's internal memory is insufficient, you can install an app on a USB device.

 You can run an app installed on a USB device only when the USB device is connected to the TV. If the USB device is disconnected while an app is running, the app is terminated.

 You cannot run an app installed on a USB device on a PC or another TV.

## Launching an app

You can run a selected app on the **My Apps** screen. The icons below appear within the selected app's icon and indicate the following:

-  : The app is installed on a USB device.
-  : The app has a password.
-  : The app is installed.
-  : The app needs to be updated.
-  : The app supports Smart View.

## Managing purchased or installed apps

On the **My Apps** screen, move the focus to the desired app, and then press and hold the Select button. You can also select **My Apps > Options** to manage installed apps.

## Adding apps to the Home Screen

1. Select **My Apps > Options > Add to Home**.
2. Select an app to add. The selected app is added to the Home Screen.

## Moving apps

1. Select **My Apps > Options > Move**.
2. Select an app to move.
3. Move the app to the desired location.
4. Press the **Select** button.
5. Select **Done**.

 This function is not available on certain models in specific geographical areas.

## Removing an app

1. Select **My Apps > Options > Delete**.
2. Select an app to delete.
3. Select **Delete**. The selected app is deleted.

 Ensure that the related app data is also removed when you remove an app.

## Updating apps

1. Select **My Apps > Options > Update**.
2. Select an app to update.
3. Press the **Select** button. The app is updated.

 This function is only available when **My Apps** contains an app that needs updating.

## Locking and unlocking apps

1. Select **My Apps > Options > Lock/Unlock**. Check boxes appear on the apps.
2. Select an app to lock or unlock. To lock an app, click on it to check it. To unlock an app, click on it to remove the check.
3. Select **Done**. The selected app is locked or unlocked.

## Automatically updating apps

The installed apps can be automatically updated. If you do not want apps automatically updated, set **My Apps > Options > Auto Update** to **Off**.

 Automatic update is enabled only when the TV is connected to the Internet.

## Rating apps

You can rate an app on the detailed information screen using the left or right directional button on the remote.

## Using other app features and functions

🏠 > ⚙️ Settings > Broadcasting > Expert Settings > Channel-bound Apps

A channel bound app provides information about offerings and services available on one channel. You can receive information about TV programs and other relevant services available on one channel while viewing TV by using a channel bound app that is installed on the TV and linked to that specific channel.

- ✎ This function is only available when an app supporting **Channel-bound Apps** is installed on the TV.
- ✎ Among the channels received through the antenna, this function is available only in the channels that support **Channel-bound Apps**.

## Using the e-Manual

Control and read the manual embedded in your TV.

## Launching the e-Manual

🏠 > ⚙️ Settings > Support > Open e-Manual

You can view the embedded e-manual that contains information about your TV's key features.

- ✎ Alternatively, you can download a copy of the e-Manual from Samsung's website.
- ✎ Words in blue (e.g., **Picture Mode**) indicate a menu item.

## Using the buttons in the e-Manual

🔍 (Search)

A-Z (Index)

🕒 (Recently Viewed Topics)

👉 (Try Now): Allows you to access the corresponding menu item and try out the feature right away.

🔗 (Link): Allows you to access the corresponding reference page.

- ✎ Some menu screens cannot be accessed from the e-Manual.

# Using the Web Browser

Surf the Internet on your TV.

## 🏠 > WEB BROWSER

- ✎ When you select 🏠 > WEB BROWSER, you can see recently viewed web sites or featured recommendations. When you select a desired web site, you can get immediate access to it.
- ✎ You can use the WEB BROWSER more easily after connecting a keyboard and mouse.
- ✎ You can scroll web pages with the Directional pad.
- ✎ The web pages may differ from those on a PC.

# Playing pictures/video/music

Play media content stored on your TV, USB devices, smartphones, cameras, PCs, etc.

## 🏠 > 📁 Source

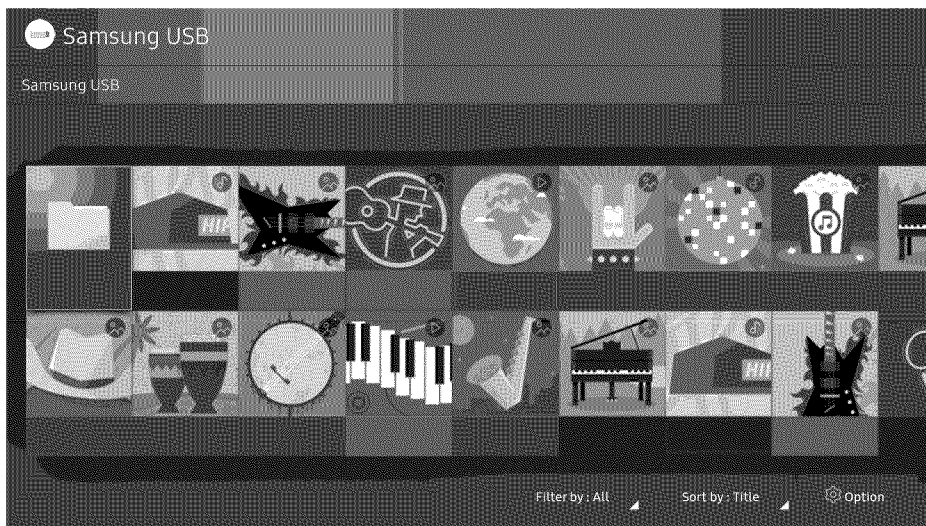



- ✎ The image on your TV may differ from the image above depending on your model and geographical area.





You can play media content saved on storage devices, such as USB devices, mobile devices, and cameras, on the TV. [Try Now](#)

- ✎ You cannot play media content if the content or the storage device is not supported by the TV. For more information, refer to "[Read Before Playing Photo, Video, or Music Files.](#)"
- ✎ To connect the TV to a computer, refer to "[Connecting a Computer.](#)"
- ✎ Backup important files before connecting a USB device. Samsung is not responsible for damaged or lost files.
- ✎ To connect the TV to a mobile device, refer to "[Connecting a Mobile Device.](#)"



## Playing media content

1. Select a device with media content in  >  **Source**. The media content list in the device appears.
2. Select a media content item from the list. The content is played.

-  For more information about buttons, refer to "[Buttons and functions available while playing multimedia content.](#)"
-  The content may not be played depending on the encoding method or file format. Furthermore, several functions may be restricted.
-  Content on devices connected to the TV via your network may not play smoothly due to the network communication problems. If this occurs, use a USB device.
-  When you connect a USB device to a USB port, a pop-up message appears that lets you switch easily to the media content list on the device.

## Functions on the media content list screen

You can use the following functions on the media content list screen of a storage device.

- **Filter By**  
Filters the media content by type of media. (music, photo, video, etc.)
  - **Sort By**  
Sorts the content list.
  - **Options**  
Deletes or plays the selected media content in the media content list.
-  You can delete only the recorded content. To delete content, change the **Filter By** option to **Recorded**.

# Using Voice Interaction

Access and run certain menu options and functions using voice commands.

 Availability depends on the specific model.



 The image on your TV may differ from the image above depending on your model and geographical area.

 When you run **Voice Interaction**, the **Voice Interaction User Guide** appears on the screen. This Guide is different for each language supported by **Voice Interaction**.

## Setting up Voice Interaction

### Turning the TV's verbal response (voice) on/off

 >  **Settings** > **System** > **Expert Settings** > **Voice Interaction** > **Voice Feedback**



Turn **Voice Feedback** on to have the TV respond verbally to your voice commands.

### Selecting the voice's gender

 >  **Settings** > **System** > **Expert Settings** > **Voice Interaction** > **Voice Gender**

You can select the gender of the voice that responds to your voice commands.

## Running Voice Interaction

Press and hold the  button, say a command, and then release the  button. The TV recognizes the voice command.

 If the command is not recognized, try again with correct pronunciation.

# Viewing Broadcast Information at a Glance

See an overview of each channel's program lineup.

## Using the guide

🏠 > Live TV > Guide **TS New**

In the Guide, you can see the daily program schedules for each broadcaster, see program information, choose a program to watch, and set up a schedule viewing or recording.

In the Guide, you can see only the TV programs scheduled after the current time.

- ✎ The **Guide** also appears when you press the CH button while watching TV.
- ✎ To see information about analog channels and use the analog channel functions of the **Guide**, you must finish the service provider settings in initial setup.
- ✎ To view the **Guide**, you must first set the TV's clock (🏠 > ⚙️ Settings > System > Time > Clock).

After moving to a desired program, press and hold the Select button on the remote control. A pop-up window listing the following functions appears.

- **Scheduled viewing**

After selecting **Schedule Viewing**, you can schedule viewing of a broadcast scheduled program.

✎ For more information about watching or **Schedule Viewing**, refer to "[Setting Up a Schedule Viewing](#)."

- **Scheduled recording**

After selecting **Schedule Recording**, you can schedule recording of a broadcast scheduled program.

✎ Recording is not supported in the U.S.A. and Canada.

- **Detailed information**

After selecting **View details**, you can see detailed information about the selected program. The information may differ with the broadcast signal. If information is not provided with the program, nothing appears.

- **Displaying Schedule Manager or Recording & Schedule Manager**

After selecting **Schedule Manager**, you can see the **Schedule Manager** or **Recording & Schedule Manager** screen.

✎ The actual name may differ by specific geographical area.

- **Recording**

After selecting **Record**, you can record the current broadcasting program.

✎ Recording is not supported in the U.S.A. and Canada.

✎ For more information about **Schedule Recording**, refer to "[Recording Programs](#)."

## Changing the broadcast signal

🏠 > Live TV > Channel List

After pressing the right directional button on your remote control, select Antenna to choose Air or Cable.

 You do not need to use this function if your TV is connected to a cable or satellite box.

## Checking digital channel signal info and strength

🏠 > ⚙️ Settings > Support > Self Diagnosis > Signal Information

 If your TV is attached to a separate, over-the-air antenna, you can use the signal strength information to adjust the antenna for increased signal strength and improved HD channel reception.

## Recording Programs

Record a current or upcoming program using a USB device instead of a video recorder.

The  appears next to the programs and channels scheduled for recording.

 This function is not available in the U.S.A. and Canada.

 Read all precautions before using the recording feature. Refer to "[Before Using the Recording and Timeshift Functions](#)" for more information.

 You can record only the programs that have been received through the antenna.

## Recording programs

Using the instant and schedule recording options from the guide screen

- **Instant Recording**

Select a live program from the Guide, press and hold the Select button, and then select Record to start recording.

- **Schedule Recording**

Select a program scheduled to be broadcast, press and hold the Select button, and then select Schedule Recording to set up a schedule recording of the scheduled program.

## Using the instant and schedule recording options on the program info window

- **Instant Recording**

Press the Select button while watching a program to display the program info window. Press and hold the Select button, and then select Record to record the program.

- **Schedule Recording**

Press the Select button while watching a program to display the program info window. Use the left or right directional button to select a scheduled program. Press and hold the Select button, and then select Timeshift to set up a Schedule Recording of the scheduled program.

## Using schedule recording to record on a specified date and time

🏠 > Live TV > Recordings > Scheduled > Schedule Recording

## Managing the schedule recording list

🏠 > Live TV > Recordings > Scheduled > Edit

## Canceling a schedule recording

🏠 > Live TV > Recordings > Scheduled > Remove

## Viewing recorded programs

🏠 > Live TV > Recordings > Scheduled

Select the file containing the recording from the list. The file is played back.

- ✎ Buttons that appear may differ depending on the file being played.
- ✎ For more information about control buttons, refer to "[Buttons and functions available while recording a program or Timeshift.](#)"
- ✎ **Highlight Player** is only available if you have saved highlights of a program that was recorded in **Sports Mode**.

# Setting Up a Schedule Viewing

Configure the TV to show a specific channel or program at a specific time and date.

The  appears next to programs that have been configured for a schedule viewing.

 To set up a schedule viewing, you must first set the TV's clock ( >  Settings > System > Time > Clock).

## Setting up a schedule viewing for a channel

### Using the schedule viewing options from the guide screen

On the Guide screen, select a program you would like to view, press and hold the Select button, and then select Schedule Viewing in the pop-up menu that appears.

### Using the schedule viewing options on the program info window

Press the Select button while watching TV. The Program Info window appears. Select a program that will be broadcast using the left or right directional buttons. Press and hold the Select button, and then select Schedule Viewing to schedule viewing of that program.

### Using schedule viewing to view programs at a specified time on a specified date

(U.S.A and Canada)  > Live TV > Schedule Manager > Schedule Viewing

(Other countries)  > Live TV > Recordings > Scheduled > Schedule Viewing

## Editing a schedule viewing

(U.S.A and Canada)  > Live TV > Schedule Manager > Edit

(Other countries)  > Live TV > Recordings > Scheduled > Edit

 You can set up a maximum total of 30 Schedule Viewing and Schedule Recording entries.

## Canceling a schedule viewing



(U.S.A and Canada)  > Live TV > Schedule Manager > Remove

(Other countries)  > Live TV > Recordings > Scheduled > Remove

# Using Timeshift

Play, pause, or rewind live TV.

You can pause and rewind live TV by using Timeshift. Activating this function disables the Broadcasting function. 

-  This function is not available in the U.S.A. and Canada.
-  To use Timeshift, you must connect a USB device for recording.
-  Read all precautions before using the Timeshift function. For more information, refer to "[Before Using the Recording and Timeshift Functions.](#)"

To activate the Timeshift function while watching TV, press and hold the Select button, and then select  in the Program Info window.

-  For more information about control buttons, refer to "[Buttons and functions available while recording a program or Timeshift.](#)"



# Using the Channel List

Change the channel or check programs on other digital channels.

 > Live TV > Channel List

By using the Channel List, you can change the channel or check programs on other digital channels while watching TV.

The All Channels screen contains the following icons:

-  : A favorite channel
-  : The channel that is being watched

If you press the right directional button when viewing the Channel List screen, you can use the following functions:

- All Channels  
Displays the channels that the TV found during the Auto Program channel search.
- Favorites  
Displays favorites lists 1 to 5.
- Air or Cable  
Allows you to select Air or Cable as the DTV mode. Air is suitable for homes equipped with separate, over-the-air antennas. Cable is suitable for homes that subscribe to a local cable-service or satellite-service provider. You do not need to use this function if your TV is connected to a cable or satellite box.

## Editing channels

Edit the channels stored on your TV.

🏠 > Live TV > Channel List > All Channels > Edit

The All Channels screen contains the following icons:

-  : A favorite channel

## Re-registering and deleting a channel

### Removing registered channels

To remove a channel, select it, and then select Delete. To remove all channels, select Select All > Delete.

### Adding back removed channels



You can add back removed channels from the Edit Channel list only. Removed channels are displayed in gray in the All Channels list. To display the Edit Channel list, select Live TV > Channel List > All Channels > Edit. Then, to add back a removed channel, select it, and then select Restore. To add back all removed channels, select Select All > Restore.

## Editing registered channels

You can access the following options by selecting All Channels > Edit:

- Rename channels

## Using Program Rating Lock

🏠 >  Settings > Broadcasting > Program Rating Lock 

This function is useful for controlling what children watch on TV. Program Rating Lock does not, however, block programs originating from external sources, such as Blu-ray players, DVD players, or USB files.

Every time you access Program Rating Lock, you must enter the security PIN. You must also enter this PIN to watch a blocked program. The default PIN is 0000. To change the PIN, go to 🏠 >  Settings > System > Expert Settings > Change PIN.

 Program Rating Lock may not be supported depending on your input signal.

 For more information about the rating system of different countries, refer to "[Blocking programs based on their TV Rating.](#)"



## Watching blocked / restricted programs

To watch a blocked program, enter the PIN when requested.

When initially showing a restricted program or movie, the screen is blank because the Program Rating Lock blocks it. Enter the PIN to unblock the program when a message appears requesting the code.

## Creating a Personal Favorites List

Designate frequently watched channels as favorite channels.

Favorite channels are highlighted in the Edit Channel and All Channels screens with the  symbol.

## Registering channels as favorites

 > Live TV > Channel List

1. Press the right directional button on your remote control.
2. Select Favorites.
3. Select one of the five favorites lists.
4. Move to Edit Favorites.
5. Select a channel to add in the favorites list.
6. Select . The selected channel is registered in the favorites list.

## Viewing and selecting channels on Favorites lists only

 > Live TV > Channel List

1. Press the right directional button on your remote control.
  2. Select Favorites.
  3. Select the desired list among the five favorites lists on the screen. The channels in the selected favorites list appear.
-  Only favorites lists that contain registered channels will display channels.

## Editing a Favorites List

Edit a favorites channel list.

 > Live TV > Channel List

After pressing the right directional button on your remote control, select Favorites > Favorites 1 - Favorites 5 > Edit. The Edit Favorites screen appears.

## Removing channels from a favorites list

Select channels in a favorites list, and then select the  button.

## Rearranging a favorites list

Select one or more channels, and then select **Change Order**. The **Change Order** highlight appears. Press the up/down directional buttons to indicate the new location for the channels. Press the **Select** button to set the channels into their new location.

## Renaming a favorites list



Select the favorites list you want to rename, and then select **Rename Favorites**. Enter a new name using the on-screen keyboard that appears, and then select **Done**.

## Making Sports Programs More Realistic with Sports Mode

Make sporting events appear and sound more realistic as if you are actually there.

 >  **Settings** > **Picture** > **Special Viewing Mode** > **Sports Mode or Soccer Mode**   

You can use **Sports Mode** to get optimal picture and sound settings for soccer events, making them appear and sound as if you are there. In addition, if a recording device is connected to the TV when you are using **Sports Mode**, you can view highlights extracted from the recorded sporting event automatically or manually.

-  The actual name of this function may differ by specific geographical area.
-  Enabling **Sports Mode** changes **Picture Mode** to **Stadium** and **Sound Mode** to **Stadium**, and disables some **Picture** and **Sound** menus.

## Extracting highlights automatically

 >  **Settings** > **Picture** > **Special Viewing Mode** > **Soccer Mode** > **Auto Highlights**

Auto Highlights is not available:

- When you are switching the input signal
- When **Video Description** is On
- When you are viewing the content saved on a USB storage device

- When the Smart View function is running
- When you are viewing highlights of the current soccer game in the UHD resolution using the Highlight Player function
- While watching an analog program

 This function is not available in the U.S.A. and Canada.

 The performance of **Auto Highlights** depends on the characteristics of the transmitted signal.

 It is advisable to use **Auto Highlights** only while watching a soccer game. If you use this function for other sporting events, it may display irrelevant picture frames.

## Viewing a game recorded in sports mode

You can view a recorded game saved on a USB storage device.

 Recording is not available in the U.S.A. and Canada.

 For more information about the functions, refer to "[Buttons and functions available while using sports mode.](#)"

 This function is not available on certain models in specific geographical areas.

 For more information, refer to "[Viewing recorded programs.](#)"

## TV-Viewing Support Functions

Use the functions that are supported by digital or analog channels.

### Scanning for available channels

 >  Settings > Broadcasting > Auto Program 



 Do not use this function if your TV is connected to a cable or satellite box.

 If the TV has saved channels, **Auto Program** deletes the existing list, and then saves the newly scanned channels.

## Configuring advanced broadcasting settings

 >  Settings > Broadcasting > Expert Settings 

### Selecting the broadcast audio language

 >  Settings > Broadcasting > Expert Settings > Audio Options

Audio Options functions differently for analog and digital channels.

#### Selecting a Language



 >  Settings > Broadcasting > Expert Settings > Audio Options > Preferred Language

This is the language you will hear while watching TV if the language is included in the broadcast signal.

#### Listening to Multi-Track Sound

 >  Settings > Broadcasting > Expert Settings > Audio Options > Multi-Track Sound

### Fine-tuning analog broadcasts

 >  Settings > Broadcasting > Expert Settings > Fine Tune

 This function is only available for analog broadcasts.

# Adjusting the Picture Quality

Change the Picture Mode and adjust Expert Settings.

## Choosing a picture mode

🏠 > ⚙️ Settings > Picture > Picture Mode 



You can select the Picture Mode that provides the best viewing experience.

- **Dynamic**  
Makes the picture brighter and clearer in bright viewing environments.
- **Standard**  
Is the default mode suitable for general viewing environments.
- **Natural**  
Reduces eye strain for a comfortable viewing experience.
- **Movie**  
Is suitable for watching TV or movies in a dark room.

## Configuring advanced picture settings

🏠 > ⚙️ Settings > Picture > Expert Settings 

Configure the screen settings to your taste by using the following functions:

- **Backlight**
- **Brightness**
- **Contrast**
- **Sharpness**
- **Color**
- **Tint (G/R)**
- **Apply Picture Settings**
- **Digital Clean View**
  -  **Auto Visualization** is only available for analog broadcasts.
- **Auto Motion Plus**
  -  When **LED Clear Motion** is set to **On**, the screen appears darker than when it is **Off**.

- **Film Mode**

 This function is only available when the input signal is TV, AV, Component (480i, 1080i), or HDMI (1080i).

- **Smart LED**

 This function is not available on certain models in specific geographical areas.

- **HDMI UHD Color**

 When you set the HDMI connection to **On**, the TV turns off and then on automatically.

 The HDMI connection with **HDMI UHD Color** set to **Off** supports up to UHD 50P/60P 4:2:0 input signals, while the HDMI connection with **HDMI UHD Color** set to **On** supports up to UHD 50P/60P 4:4:4 and 4:2:2 input signals. For more information, refer to "[Supported Resolutions for UHD Input Signals.](#)"

 For the SUHD models, each HDMI connection can be individually optimized for **HDMI UHD Color**. For the UHD models, make sure to connect to the HDMI IN 1 port of the TV.

 When you connect the TV to an external device that supports only the UHD 24 or 30 Hz frequency or any FHD frequency, the HDMI UHD Color function may not be available. In this case, set **HDMI UHD Color** to **Off**.

- **HDMI Black Level**

 This function is only available when the input signal, connected to the TV via an HDMI connector, is set to RGB444.

- **Dynamic Contrast**

- **Color Tone**

 **Cool** and **Standard** are only available when **Picture Mode** is set to **Dynamic**.

 **Color Tone** is only available when the TV is connected to a computer via an HDMI-to-DVI cable.

- **White Balance**

- **Gamma**

- **RGB Only Mode**

- **Color Space**

- **Reset Picture**

# Picture Support Functions

Configure the picture settings for your TV.

## Viewing a picture-in-picture (PIP)

🏠 > ⚙️ Settings > Picture > PIP

While viewing video from an external device such as a Blu-ray player on the main screen, you can watch a TV broadcast in a picture-in-picture (PIP) window.

- ✎ This function is not available in the U.S.A. and Canada.
- ✎ This function is not available on certain models in specific geographical areas.
- ✎ PIP is not available while **Smart Hub** is active.
- ✎ Playing a game or using the karaoke function on the main screen can result in lower PIP picture quality.
- ✎ The PIP function is only available under the following conditions: 1) The main screen's source is a Component or HDMI connection. 2) The input resolution is less than FHD (Full HD).
- ✎ The PIP window supports digital channels only and does not support UHD channels.

## Changing the picture size

🏠 > ⚙️ Settings > Picture > Picture Size Try Now

You can change the size of the picture displayed on the TV screen.

- 16:9 Standard
  - Custom
  - 4:3
- ⚠️ Do not watch your TV in 4:3 mode for extended periods of time. This action can cause the black bars, which appear at the top, bottom, left, and right sides of the screen in 4:3 mode, to "burn in" and appear as temporary or permanent after images on the screen. Damage to the screen caused by screen "burn in" is not covered by your Warranty.
- ✎ Supported picture sizes differ with the input signal. For more information about supported picture sizes, refer to "[Picture sizes and input signals.](#)"

## Fitting the picture to the screen

🏠 > ⚙️ Settings > Picture > Picture Size > Fit to Screen

- ✎ The availability of this function depends on the **Picture Size**.

## Adjusting the picture size and/or position

🏠 > ⚙️ Settings > Picture > Picture Size > Zoom/Position

✎ The availability of this function depends on the **Picture Size**.

## Adjusting the Sound Quality

Change the Sound Mode and adjust Expert Settings.

### Choosing a sound mode

🏠 > ⚙️ Settings > Sound > Sound Mode

You can select a sound mode to optimize your listening experience.

### Configuring advanced sound settings

🏠 > ⚙️ Settings > Sound > Expert Settings

You can personalize the sound quality by adjusting the following settings.

- Balance
- Equalizer
- TV Installation Type
- Wireless Speaker Manager

✎ For more information, refer to "[Listening to the TV with a Samsung audio device.](#)"

- HDMI Audio Format
- Audio Format
- Audio Delay
- Auto Volume

✎ If you want to use the volume control of a connected source device to control the sound, deactivate **Auto Volume**. When you use **Auto Volume** with a source device, the device's volume control may not function properly.

- Sound Feedback
- Reset Sound



# Using the Sound Support Functions

Configure the sound settings for your TV.

## Selecting speakers

🏠 > ⚙️ Settings > Sound > Sound Output 

You can select which speakers the TV uses for audio output.

- ✎ When **Sound Output** is set so that sound comes from external speakers only, the Volume and Mute buttons and some Sound functions are disabled.

## Listening to the TV with a Samsung audio device

### Connecting a Samsung audio device

🏠 > ⚙️ Settings > Sound > Expert Settings > Wireless Speaker Manager > Add TV SoundConnect

When a Samsung audio device is connected to the TV, you can enjoy high-quality, rich sound. For more information about connection and usage, refer to the manual of the Samsung Audio device.

- ✎ This function is not available on certain models in specific geographical areas.
- ✎ This function is only available for Samsung audio devices that support **Add TV SoundConnect**.
- ✎ You can't use Bluetooth devices, **TV SoundConnect**, and the **Surround** feature simultaneously.
- ✎ The sound quality may be affected by the condition of your wireless network.
- ✎ Before using a Bluetooth device, refer to "[Read Before Using Bluetooth Devices.](#)"

### Listening to the TV audio sound with a connection to a Samsung audio device

🏠 > ⚙️ Settings > Sound > Expert Settings > Wireless Speaker Manager > Samsung Audio Devices

You can hear TV sound by selecting a Samsung audio device.

- ✎ To use a Samsung audio device, set **Sound Output** to the corresponding Samsung audio device (product name).

## Listening to the TV through Bluetooth devices

🏠 > ⚙️ Settings > Sound > Expert Settings > Wireless Speaker Manager > Bluetooth Audio Devices

You can connect Bluetooth audio devices to the TV. They must be paired using the TV's Bluetooth function. For more information on pairing, refer to the Bluetooth audio device's operating manual.

- ✎ This function is not available on certain models in specific geographical areas.
- ✎ If the TV fails to find a Bluetooth audio device, place the device closer to the TV, and then select **Refresh**.
- ✎ When you turn on a paired Bluetooth audio device, the TV detects it automatically, and then displays a pop-up window. Use this pop-up window to activate/deactivate the Bluetooth audio device.
- ✎ Before using a Bluetooth audio device, refer to "[Read Before Using Bluetooth Devices](#)."

## Listening to the TV through a Multiroom speaker

- ✎ This function is not available on certain models in specific geographical areas.

### Creating surround effect through Multiroom speaker

🏠 > ⚙️ Settings > Sound > Expert Settings > Wireless Speaker Manager > Multiroom Link Type

When a multiroom speaker is used, an optimal sound can be output by creating surround effect. You can select any of the configurations with and without sound bar.

### Configuring the surround effect settings through Multiroom speaker

🏠 > ⚙️ Settings > Sound > Expert Settings > Wireless Speaker Manager > Multiroom Link Settings

You can hear the TV sound after configuration of the surround effect through Multiroom speaker.

- ✎ The Multiroom Link function is only available when at least one Samsung Multiroom Link compatible speaker is connected to the TV.
- ✎ The Multiroom Link function is deactivated when you activate Smart View (Screen Mirroring).
- ✎ The audio from the secondary device(s) may lag behind the audio and video of the main device that is playing the source content.
- ✎ For more information, refer to the Multiroom Link manual on the Samsung web site. ([www.samsung.com](http://www.samsung.com))

# Setting the Time and Using the Timer

Set the current time and use the timer function.

## Setting the current time

🏠 > ⚙️ Settings > System > Time 

You can set the Clock manually or automatically. Once the Clock is set, you can view the current time on the TV anytime.

 The clock must be reset every time the power is disconnected.

## Setting the clock using digital broadcast info

🏠 > ⚙️ Settings > System > Time > Clock > Clock Mode > Auto

 This function works only when the TV's antenna jack is connected to either an antenna or a cable output and is receiving digital broadcasts.

 Depending on the broadcast signal, the displayed time may differ.

 The accuracy of the time information received may differ with the channel and signal.

## Changing the current time

🏠 > ⚙️ Settings > System > Time > Clock > Time Offset

 **Time Offset** adjusts the time through a network connection. This function is only available if **Clock Mode** is set to **Auto** and the TV is connected to the Internet through a local area network.

 **Time Offset** adjusts the time if the TV fails to receive time information through normal digital broadcast signals.

## Setting the clock manually

🏠 > ⚙️ Settings > System > Time > Clock > Clock Mode > Manual > Clock Set

## Using the timers

### Using the sleep timer

🏠 > ⚙️ Settings > System > Time > Sleep Timer

You can use this function to automatically shut off the TV after a pre-set period of time. You can set the timer in 30 minute increments for up to 3 hours.

### Turning on the TV using the on timer

🏠 > ⚙️ Settings > System > Time > On Timer

You can set On Timer to make the TV turn on automatically at a specific time. On Timer is only available when the Clock has already been set.

The On Timer function lets you select a source for the TV to use when it turns on. If you want to play content saved in a USB device or content from an HDMI or Component source, such as a DVD player, Blue-ray player, or cable/satellite box, connect the device to the TV before you start On Timer setup and turn it on. For On Timer to function, you must keep the device connected to the TV.

Music and Photo options let you specify a USB device folder containing music files in the music field and/or a folder containing photos in the photo field. If you select both a folder that contains music files and a folder that contains photo files, the TV plays the music files and displays the photos at the same time.

- If the folder that you choose has sub-folders, you can select a sub-folder in the same way.
- This function does not work properly if the selected USB device does not contain media files or a folder has not been specified.
- The slideshow will not start if there is only one image file on the USB device.
- Folders with long names cannot be selected.
- Make sure to use different folder names for multiple USB devices.
- Use a USB memory stick or multi-card reader. On Timer may not work with certain battery-powered USB devices, MP3 players, or PMPs because the TV may take too long to recognize the device.

### Turning off the TV using the off timer

🏠 > ⚙️ Settings > System > Time > Off Timer

# Using the Screen Burn Protection and Energy Saving Functions

Protect the screen from screen burn-in and reduce the TV's energy consumption.

## Preventing screen burn

🏠 > ⚙️ Settings > System > Expert Settings > Auto Protection Time

Still images can leave burned-in after-images if left on the screen for a long period of time. To protect the screen, go to Auto Protection Time, and then select a time setting from the list. If a still image is shown on the screen for longer than the time that you selected, the TV automatically activates the Screen Burn Protection function.

## Reducing the energy consumption of the TV

🏠 > ⚙️ Settings > System > Eco Solution **Try Now**

You can adjust the brightness level of the TV and prevent overheating to reduce overall power consumption.

- **Eco Sensor** **Try Now**  
Automatically adjusts the brightness level of the TV, according to the ambient light level, to reduce power consumption. If the Eco Sensor has adjusted the screen's brightness level, you can select **Min. Backlight** to manually adjust the minimum screen brightness. While the Eco Sensor is active when the value changes in **Picture > Backlight**, the Eco Sensor function is deactivated.
- **Energy Saving Mode** **Try Now**  
Allows you to select a brightness setting from the list to reduce the TV's power consumption.
- **Motion Lighting** **Try Now**  
Adjusts the brightness in response to on-screen movements to reduce power consumption.  
 This feature is only available when the **Picture Mode** is set to **Standard**.
- **Auto Power Off** **Try Now**  
Automatically turns off the TV to prevent overheating if there is no operation for the length of time you specify (4, 6, or 8 hours).

# Using Anynet+ (HDMI-CEC)

Control the external devices connected via Anynet+ (HDMI-CEC) with the remote control.

You can use the TV's remote control to control external devices that are connected to the TV by an HDMI cable and that support Anynet+ (HDMI-CEC). Note that you can only set up and operate Anynet+ (HDMI-CEC) with the remote control.

## Connecting an external device through Anynet+ and using their menus

🏠 > ⚙️ Settings > System > Expert Settings > Anynet+ (HDMI-CEC)

1. Set Anynet+ (HDMI-CEC) to On.
2. Connect an HDMI-CEC-compliant device to the TV.
3. Turn on the connected external device. The device is automatically connected to the TV. After connection is finished, you can access the menu of the connected device on your TV screen using your TV remote and control the device.

✎ The connecting process can take up to 2 minutes to complete.

## Read before connecting an Anynet+ (HDMI-CEC) device

- ✎ You can configure the TV's Universal Remote to control third-party cable boxes, Blu-ray players, and home theaters that do not support HDMI-CEC. For more information, refer to "[Controlling External Devices with the Samsung Smart Remote - Using the Universal Remote.](#)"
- ✎ Anynet+ cannot be used to control external devices that do not support HDMI-CEC.
- ✎ Anynet+ (HDMI-CEC)-enabled devices must be connected to the TV with an HDMI cable. Note that some HDMI cables may not support Anynet+ (HDMI-CEC).
- ✎ The TV remote control may not work under certain circumstances. If this occurs, set up the device as an Anynet+ (HDMI-CEC)-enabled device again.
- ✎ Anynet+ (HDMI-CEC) works only with external devices that support HDMI-CEC and only when those devices are either in standby mode or turned on.
- ✎ Anynet+ (HDMI-CEC) can control up to 12 compliant external devices (up to 3 of the same type) except for home theaters. Anynet+ (HDMI-CEC) can control only one home theater system.
- ✎ To listen to 5.1-channel audio from an external device, connect the device to the TV via an HDMI cable and connect a 5.1 home theater system directly to the external device's digital audio output connector.
- ✎ If an external device has been set up for both Anynet+ and a universal remote control, the device can be controlled only with the universal remote control.

# Updating the TV's Software

View your TV's software version and update it if necessary.

🏠 > ⚙️ Settings > Support > Software Update TV Now

## Updating the TV's software to the latest version

- ⚠️ DO NOT turn off the TV's power until the update is complete. The TV will turn off and on automatically after completing the software update. Video and audio settings may be reset to their defaults after a software update.

### Updating through the Internet

🏠 > ⚙️ Settings > Support > Software Update > Update now

- ✎ Updating from the Internet requires an active Internet connection.

### Updating through the USB device

🏠 > ⚙️ Settings > Support > Software Update > Update now

After downloading the update file from the website and storing it on a USB device, connect the USB device to the TV for update.

- ✎ To update using a USB flash drive, download the update package from Samsung.com to your computer. Then, save the update package in the USB device's top-level folder. Otherwise, the TV will not be able to locate the update package.

## Updating the TV automatically

🏠 > ⚙️ Settings > Support > Software Update > Auto Update

If the TV is connected to the Internet, you can have the TV's software update itself automatically while you are watching the TV. When the background update is completed, it is applied the next time the TV is turned on.

- ✎ This function may take a longer time if another network function is running concurrently.
- ✎ This function requires an Internet connection.
- ✎ If you agree to the Smart Hub terms and conditions, **Auto Update** is set to **On** automatically. If you do not want the TV's software to update itself automatically, set **Auto Update** to **Off**.

# Protecting the TV from Hacking and Malicious Code

Protect your TV from hacking attempts and malicious code.

🏠 > ⚙️ Settings > System > Expert Settings > Smart Security

You can use Smart Security to protect the TV from hacking and malicious code when it is connected to the Internet.

## Checking the TV and connected storage for malicious code

🏠 > ⚙️ Settings > System > Expert Settings > Smart Security > Scan

If malicious code is found, the results of the scan will appear on the screen. This result window displays all malicious code found. You can quarantine (isolate) the code. Quarantining prevents it from executing.

1. Select all the malicious code to quarantine.
2. Select Isolate. The selected malicious code is relocated to the Isolated List.

 The Isolated List displays all quarantined malicious codes.

## Scanning for viruses in real time

🏠 > ⚙️ Settings > System > Expert Settings > Smart Security > Real-Time Monitoring

## Viewing scan results

🏠 > ⚙️ Settings > System > Expert Settings > Smart Security > Monitoring Results



# Using Other Functions

[View other functions.](#)

## Running the accessibility functions

 >  Settings > System > Accessibility  

## Enabling voice guides for the visually impaired

 >  Settings > System > Accessibility > Voice Guide  

You can activate voice guides that describe the menu options aloud to aid the visually impaired. To activate this function, set **Voice Guide** to **On**. With **Voice Guide** on, the TV provides voice guides for channel change, volume adjust, information on current and upcoming programs, schedule viewing, other TV functions, various content in the Web Browser, and in **Search**.

 The **Voice Guide** is provided in the language that is specified on the **Language** screen. However, some languages are not supported by **Voice Guide** even though they are listed in the **Language** screen. **English** is always supported.

## Changing the volume, speed, and pitch of the Voice Guide

You can configure the volume, pitch, speed, and level of the **Voice Guide**.

## Enabling audio for the video description function

 >  Settings > System > Accessibility > Video Description

You can activate an audio guide that provides an audio description of video scenes for the visually impaired. This function is only available with broadcasts that provide this service.

## Showing captions

🏠 > ⚙️ Settings > System > Accessibility > Caption > Caption

Set Caption to On to watch programs with the captions displayed.

- ✎ Captions are not displayed by programs that do not support captions.
- ✎ The TV cannot control or modify DVD or Blu-ray subtitles. To control DVD or Blu-ray subtitles, use the sub-title feature of the DVD or Blu-ray player and the player's remote control.

## Selecting the caption language

🏠 > ⚙️ Settings > System > Accessibility > Caption > Caption Mode

- Default / CC1 ~ CC4 / Text1 ~ Text4  
(Analog channels only) Operates in either analog TV channel mode or when a signal is supplied from an external device to the TV. (Depending on the broadcast signal, the analog caption function may or may not work with digital channels.)
- Default / Service1 ~ Service6 / CC1 ~ CC4 / Text1 ~ Text4  
(Digital channels only) Works with digital channels. Service1 – Service6 may not be available in digital caption mode depending on the broadcast.

## Setting the digital caption related options

🏠 > ⚙️ Settings > System > Accessibility > Caption > Digital Caption Options

You can change the font color, background color, and size settings.

- ✎ The foreground and background colors and opacity settings cannot be the same.

## Adjusting the menu transparency

🏠 > ⚙️ Settings > System > Accessibility > Settings Menu Transparency

You can adjust the menu's transparency.

- ✎ Setting High Contrast (🏠 > ⚙️ Settings > System > Accessibility > High Contrast) to On automatically switches the menu display mode to opaque. You cannot manually change the Settings Menu Transparency settings.

## White text on black background (high contrast)

🏠 > ⚙️ Settings > System > Accessibility > High Contrast

You can change major service screens to white text on a black background or change the transparent TV menus to opaque so that text can be more easily read. To activate this function, set High Contrast to On.

## Enlarging the font (for the visually impaired)

🏠 > ⚙️ Settings > System > Accessibility > Enlarge 

You can enlarge the size of the font on the screen. To activate, set Enlarge to On.

## Learning about the remote control (for the visually impaired)

🏠 > ⚙️ Settings > System > Accessibility > Learn Remote Control 

This function helps individuals with a visual impairment to learn the positions of the buttons on the remote control. When this function is activated, you can press a button on the remote control and the TV will tell you its name. To return to the previous screen, press the ⏪ button twice. To exit, press and hold the ⏪ button.

 This function is only available in the U.S.A. and Canada.

## Listening to the TV through Bluetooth devices (for the hearing impaired)

🏠 > ⚙️ Settings > System > Accessibility > Multi-output Audio 

You can turn on both the TV speaker and Bluetooth devices at the same time. When this function is active, you can set the volume of the Bluetooth devices higher than the volume of the TV speaker.

 This function is not available on certain models in specific geographical areas.

 When you connect Bluetooth devices to the TV, the **Multi-output Audio** is activated. For more information about connecting Bluetooth devices to the TV, refer to "[Listening to the TV through Bluetooth devices.](#)"

## Configuring advanced system settings

🏠 > ⚙️ Settings > System > Expert Settings 

### Changing the menu language

🏠 > ⚙️ Settings > System > Expert Settings > Language

## Setting up a password

🏠 > ⚙️ Settings > System > Expert Settings > Change PIN

The PIN input window appears. Enter a PIN. Enter it again to confirm it. The default PIN is 0000.

If you forget your PIN, you can reset it with your remote control. With the TV turned on, press the following buttons on the remote control in the order shown to reset the PIN to 0000: VOL → Volume Up → ⏪ → Volume Down → ⏩ → Volume Up → ⏪.

## Enabling/Disabling the front indicators

🏠 > ⚙️ Settings > System > Expert Settings > Light Effect

- ✎ The color of the TV's indicator lights may differ by the model.
- ✎ This function is not available on certain models in specific geographical areas.

## Registering the TV as a DivX-certified device (watching for pay DivX movies)

🏠 > ⚙️ Settings > System > Expert Settings > DivX® Video On Demand

- ✎ Digital Rights Management (DRM) is a technical security mechanism that protects the content provider's copyright.
- ✎ You can watch recorded movies or free DivX movies without registration.
- ✎ Visit the DivX website (<http://www.divx.com>) and log in to your user account before registering the TV as a DivX-certified device. If you do not have an account, create one.

## Checking Notifications

🏠 > ⚙️ Settings > System > Expert Settings > View Notifications

You can view the list of event messages generated by the TV. View Notifications appears on the screen when events such as an update release for an app or a Samsung Account login/logout occurs.

- ✎ To delete all notifications, select **Delete All**.
- ✎ To check the SMART TV's service notifications in a **WEB BROWSER**, select **Service Notice**.

## Locking/Unlocking the TV Controller or Control Stick

🏠 > ⚙️ Settings > System > Expert Settings > TV Controller Lock or Control Stick Lock

- ✎ The actual name of this function may differ depending on the model.

## Using the TV as a display model (for retail stores)

🏠 > ⚙️ Settings > System > Expert Settings > Usage Mode

You can turn the TV into a display model for retail environments by setting Usage Mode to Retail Mode.

- ✎ For all other uses, select **Home Mode**.
- ✎ With **Retail Mode**, some functions are disabled, and the TV automatically resets itself after a preset amount of time.

## Enabling game mode

🏠 > ⚙️ Settings > Picture > Special Viewing Mode > Game Mode 

- ✎ The game mode is not available for normal TV viewing.
- ✎ The screen may shake somewhat.
- ✎ When **Game Mode** is enabled, **Picture Mode** and **Sound Mode** are switched to **Game** automatically.
- ✎ To use a different external device, first disconnect the game console and disable **Game Mode**.

## Restoring the TV to the factory settings

🏠 > ⚙️ Settings > Support > Self Diagnosis > Reset

You can restore all TV settings (excluding the Internet and network settings) to the factory defaults.

1. Select **Reset**. The security PIN entry window appears.
  2. Enter the security PIN, and then select **Yes**. All settings are then reset. The TV turns off and on again automatically and displays the **Setup** screen.
- ✎ For more information on **Setup**, refer to the user manual that came with the TV.

# Getting Support

Get help directly from Samsung if you have a problem with your TV.

## Getting support through Remote Management

🏠 > ⚙️ Settings > Support > Remote Management TV Only

To let Samsung Electronics diagnose your TV remotely when you need assistance with your TV, set Remote Management to On. You will need to read and agree to the service agreement before using this feature.

 This function requires an Internet connection.

### What is Remote Support?

Samsung Remote Support service offers you one-on-one support with a Samsung Technician who can remotely:

- Diagnose your TV
- Adjust the TV settings for you
- Perform a factory reset your TV
- Install recommended **firmware updates**

### How does Remote Support Work?

You can easily have a Samsung Tech service your TV remotely:

1. Call the Samsung Contact Center and ask for remote support.
2. Open the menu on your TV and go to the Support section.
3. Select Remote Management, then read and agree to the service agreements. When the PIN screen appears, provide the PIN number to the agent.
4. The agent will then access your TV.

### Finding the contact information for service

🏠 > ⚙️ Settings > Support > Contact Samsung TV Only

You can view the address of the Samsung website, the call center phone number, your TV's model number, your TV's software version, the Smart Hub info, and other information you may need to get service support from a Samsung call agent or the Samsung website.

 You can also find information by reading the QR code of the product.

## Requesting service

[Home](#) > [Settings](#) > [Support](#) > [Request Support](#) Try Now

 This function is not available in specific geographical areas.

You can request service when you encounter a problem with the TV. Select the item matching the problem that you encountered, and then select [Request Now](#) or [Schedule Appointment](#) > [Send](#). Your service request will be registered.

 You should agree to the terms and conditions for the service request.

## Diagnosing TV operational issues

You can diagnose issues with your TV and Smart Hub and run reset functions.

[Home](#) > [Settings](#) > [Support](#) > [Self Diagnosis](#) Try Now

You can use the [Picture Test](#) to help diagnose video issues and the [Sound Test](#) to diagnose sound issues. You can also view signal strength information for over-the-air digital signals, test the Smart Hub Internet connection, and run the Smart Hub and TV factory reset functions.

## There Is a Problem with the Picture

When the TV has trouble with the picture, these steps may help resolve the problem.

### Testing the picture

[Home](#) > [Settings](#) > [Support](#) > [Self Diagnosis](#) > [Start Picture Test](#)

Before you review the list of problems and solutions below, use [Start Picture Test](#) to determine if the problem is caused by the TV. [Start Picture Test](#) displays a high definition picture you can examine for flaws or faults.

The problem	Try this!
Flickering and Dimming	If your Samsung Television is flickering or dimming sporadically, you may need to disable some of the energy efficiency features. Disable <a href="#">Energy Saving Mode</a> ( <a href="#">Home</a> > <a href="#">Settings</a> > <a href="#">System</a> > <a href="#">Eco Solution</a> > <a href="#">Energy Saving Mode</a> ), <a href="#">Eco Sensor</a> ( <a href="#">Home</a> > <a href="#">Settings</a> > <a href="#">System</a> > <a href="#">Eco Solution</a> > <a href="#">Eco Sensor</a> ), or <a href="#">Motion Lighting</a> ( <a href="#">Home</a> > <a href="#">Settings</a> > <a href="#">System</a> > <a href="#">Eco Solution</a> > <a href="#">Motion Lighting</a> ).
Component Connections/Screen Color	If the color on your Samsung television screen is not correct or the black and white colors are off, run <a href="#">Start Picture Test</a> ( <a href="#">Home</a> > <a href="#">Settings</a> > <a href="#">Support</a> > <a href="#">Self Diagnosis</a> > <a href="#">Start Picture Test</a> ). If the test results indicate that the problem is not caused by the TV, do the following: <ul style="list-style-type: none"><li>• Confirm that the video input connectors are connected to the correct external device video output connectors.</li><li>• Check the other connections as well. If the TV is connected to an external device via a component cable, confirm that the Pb, Pr, and Y jacks are plugged into their proper connectors.</li></ul>

The problem	Try this!
Screen Brightness	<p>If the colors on your Samsung TV are correct but just a little too dark or bright, try adjusting the following settings first.</p> <ul style="list-style-type: none"> <li>• Select <a href="#">Home</a> &gt; <a href="#">Settings</a> &gt; <a href="#">Picture</a> &gt; <a href="#">Expert Settings</a> and adjust the Backlight, Contrast, Brightness, Sharpness, Color, or Tint (G/R) settings.</li> </ul>
Ghosting, Blurring, or Juddering	<p>If you notice ghosting or blurring on the screen, use the Auto Motion Plus function (<a href="#">Home</a> &gt; <a href="#">Settings</a> &gt; <a href="#">Picture</a> &gt; <a href="#">Expert Settings</a> &gt; <a href="#">Auto Motion Plus</a>) to resolve the issue.</p>
Unwanted Powering Off	<p>If your Samsung TV appears to turn off by itself, try disabling some of the TV's energy efficiency functions. See if Sleep Timer (<a href="#">Home</a> &gt; <a href="#">Settings</a> &gt; <a href="#">System</a> &gt; <a href="#">Time</a> &gt; <a href="#">Sleep Timer</a>) has been enabled. The Sleep Timer automatically turns the TV off after a specified period of time. If the Sleep Timer has not been enabled, see if Auto Power Off (<a href="#">Home</a> &gt; <a href="#">Settings</a> &gt; <a href="#">System</a> &gt; <a href="#">Eco Solution</a> &gt; <a href="#">Auto Power Off</a>) has been enabled and disable it.</p>
Problems Powering On	<p>If you are having problems powering on your Samsung television, there are a number of things to check before calling the service department. Confirm that the TV's power cord is connected correctly at both ends and that the remote control is operating normally. Make sure that the antenna cable or cable TV cable is firmly connected. If you have a cable or satellite box, confirm that it is plugged in and turned on.</p>
Unable to find a Channel	<p>If your TV is not connected to a cable or satellite box, run Auto Program (<a href="#">Home</a> &gt; <a href="#">Settings</a> &gt; <a href="#">Broadcasting</a> &gt; <a href="#">Auto Program</a>).</p>
The TV image does not look as good as it did in the store.	<p>Store displays are all tuned to digital, HD (high definition) channels.</p> <p>If you have an analog cable or satellite box, upgrade to a digital cable or satellite box. Use HDMI or Component cables to deliver HD (high definition) picture quality.</p> <p>Many HD channels are upscaled from SD (Standard Definition) content. Look for a channel that is broadcasting HD content.</p> <ul style="list-style-type: none"> <li>• Cable/Satellite Subscribers: Try HD channels from the channel lineup.</li> <li>• Air/Cable Antenna Connection: Try HD channels after running the Auto Program function.</li> </ul> <p>Adjust the cable or satellite box's video output resolution to 1080i or 720p.</p>
The picture is distorted.	<p>The compression of video content may cause picture distortions, especially in fast moving pictures from sports programs and action movies.</p> <p>If the signal reception is weak or poor, screen distortion may be accompanied but it is not a malfunction.</p> <p>Mobile phones used close to the TV (within 3.2 ft) may cause noise in analog and digital channels.</p>
The color is wrong or missing.	<p>If you're using a Component connection, make sure that the Component cables are connected to the correct jacks. Incorrect or loose connections may cause color problems or a blank screen.</p>



The problem	Try this!
The color is poor or the picture is not bright enough.	Go to the Picture and then adjust the Picture Mode, Brightness, Sharpness, and Color settings. See if Energy Saving Mode (🏠 > ⚙️ Settings > System > Eco Solution > Energy Saving Mode) has been enabled. Try resetting the picture. (🏠 > ⚙️ Settings > Picture > Expert Settings > Reset Picture)
There is a dotted line on the edge of the screen.	Change Picture Size to 16:9 Standard.
The picture is black and white.	If you are using AV, analog equipment, disconnect the adapter from the Component (Blue) input jack on the TV and connect it to the AV In (Yellow) input jack.

- ✎ If the test picture does not appear or there is noise or distortion, the TV may have a problem. Contact Samsung's Call Center for assistance.
- ✎ If the test picture is displayed properly, there may be a problem with an external device. Please check the connections.
- ✎ If the problem persists, check the signal strength or refer to the external device's user manual.

## I Can't Hear the Sound Clearly

When the TV has difficulties with sound, these steps may help resolve the problem.

### Testing the sound

🏠 > ⚙️ Settings > Support > Self Diagnosis > Start Sound Test

If the TV plays the Start Sound Test melody without distortion, there may be a problem with an external device or the broadcast signal's strength.

The problem	Try this!
There is no sound or the sound is too low at maximum volume.	Check the volume control of the device (cable or satellite box, DVD, Blu-ray, etc.) connected to your TV.
The picture is good but there is no sound.	Set 🏠 > ⚙️ Settings > Sound > Sound Output to TV Speaker. If you are using an external device, check the device's audio output option. (For example, you may need to change your cable box's audio option to HDMI if the box connected to your TV is using an HDMI cable.) To listen to computer sound, connect an external speaker to the computer's audio output connector. If your TV has a headphone jack, make sure there is nothing plugged into it. Reboot the connected device by disconnecting and then reconnecting the device's power cable.

The problem	Try this!
The speakers are making an odd sound.	<p>Make sure that the audio cable is connected to the correct audio output connector on the external device.</p> <p>For antenna or cable connections, check the signal information. A low signal level may cause sound distortions.</p> <p>Run Start Sound Test (🏠 &gt; ⚙️ Settings &gt; Support &gt; Self Diagnosis &gt; Start Sound Test).</p>

## There Is a Problem with the Broadcast

When the TV has difficulties receiving broadcasts, these steps may help resolve the problem.

The problem	Try this!
"Weak or No Signal" displayed in TV mode/ cannot find channel.	<p>Select 🏠 &gt; 📺 Source to confirm that the correct input source has been selected.</p> <p>If the TV is not connected to a cable or satellite box, run Auto Program to search for channels (🏠 &gt; ⚙️ Settings &gt; Broadcasting &gt; Auto Program).</p>
The TV is not receiving all channels.	<p>Confirm that the coaxial cable is securely connected to the TV.</p> <p>Run Start Setup (🏠 &gt; ⚙️ Settings &gt; System &gt; Start Setup) or Auto Program (🏠 &gt; ⚙️ Settings &gt; Broadcasting &gt; Auto Program).</p>
There are no captions with digital channels.	<p>Go to Caption (🏠 &gt; ⚙️ Settings &gt; System &gt; Accessibility &gt; Caption) and change the Caption Mode.</p> <p>Some channels may not have caption data.</p>
The picture is distorted.	<p>The compression of the video content may cause picture distortions. This is especially true with fast moving pictures from sports programs and action movies.</p> <p>A weak signal can cause picture distortions. This is not a problem with the TV.</p>
The picture quality is low.	<p>Select high definition (HD) channels or programs.</p>

# My Computer Won't Connect

When the TV has difficulties connecting to a PC, these steps may help resolve the problem.

The problem	Try this!
The "Mode Not Supported" message appears.	Set your PC's output resolution so it matches a resolution supported by the TV.
The video is OK but there is no audio.	If you are using an HDMI connection, check the audio output setting on your PC. If you are using an HDMI-to-DVI cable, a separate audio cable is required. Note that the HDMI-to-DVI connection is only supported by the HDMI (DVI) port and does not transmit audio. To listen to the computer sound, connect external speakers to the audio output connection of the computer.

# The TV Won't Connect to the Internet

When the TV has difficulties connecting to the Internet, these steps may help resolve the problem.

The problem	Try this!
The TV cannot connect to your network or apps (for Internet compatible models only).	Make sure the TV has a network connection (🏠 > ⚙️ Settings > Network > Network Status). Contact your Internet service provider.
The wireless network connection failed.	Confirm your wireless modem/router is on and connected to the Internet.
The wireless network signal is too weak.	Position your wireless router, modem router, or access point in a central location. Avoid putting it in a corner. Use a wireless repeater to get an instant boost in your wireless signal strength. Place the repeater halfway between your wireless router and your TV. The most common wireless technology, 802.11g (wireless-G), operates at a frequency of 2.4 GHz. This frequency is widely used by many cordless phones, microwave ovens, baby monitors, garage doors, and other wireless devices. Reduce interference by not using or turning off wireless devices that use the 2.4 GHz frequency. Instead, use devices that communicate via the 5.0 GHz frequency.
The software update over the Internet has failed.	Check the network connection status (🏠 > ⚙️ Settings > Network > Network Status). If the TV is not connected to a network, connect it to a network. The upgrade stops if you already have the latest software version.

# The Schedule Recording/Timeshift Function Isn't Working

When Timeshift or Schedule recording aren't working, these steps may help resolve the problem.

 This function is not available in the U.S.A. and Canada.

The problem	Try this!
Schedule Recording cannot be used.	Check if there is a USB device connected to the TV. Recording will automatically stop if the signal becomes too weak. The Timeshift function will not work if there isn't enough storage space on the USB device.

# Anynet+ (HDMI-CEC) Isn't Working

When Anynet+ (HDMI-CEC) isn't working, these steps may help resolve the problem.

The problem	Try this!
Anynet+ does not work.	Confirm that the device is an Anynet+ device. The Anynet+ system supports Anynet+ devices only. Check if the power cord of the Anynet+ device is properly connected. Check the cable connections of the Anynet+ device. Go to Anynet+ (HDMI-CEC) (🏠 > ⚙️ Settings > System > Expert Settings > Anynet+ (HDMI-CEC)) and see if Anynet+ (HDMI-CEC) has been set to On. Check whether the TV remote control is in TV mode. Check whether the remote control is Anynet+ compatible. Anynet+ may not function when some other functions are active, including Channel Search, Smart Hub, Initial Setup, etc. If you have disconnected and then reconnected the HDMI cable, scan for devices again or turn your TV off and on.
I want to start Anynet+.	Check if the Anynet+ device is properly connected to the TV, and then select the Anynet+ (HDMI-CEC) (🏠 > ⚙️ Settings > System > Expert Settings > Anynet+ (HDMI-CEC)) menu to see if Anynet+ (HDMI-CEC) is set to On.
I want to exit Anynet+.	Set Anynet+ (HDMI-CEC) (🏠 > ⚙️ Settings > System > Expert Settings > Anynet+ (HDMI-CEC)) to Off.
The message "Connecting to Anynet+ device..." or "Disconnecting from Anynet+ device" appears on the screen.	You cannot use the remote control when the TV is configuring Anynet+ or switching to a viewing mode. Use the remote control after the TV has completed the Anynet+ configuration or has switched to a viewing mode.
The Anynet+ device won't play.	You cannot use the play function when Start Setup is in progress.

The problem	Try this!
The connected device is not displayed.	<p>Check whether the device supports Anynet+.</p> <p>Check whether the HDMI cable is properly connected.</p> <p>Go to Anynet+ (HDMI-CEC) (🏠 &gt; ⚙️ Settings &gt; System &gt; Expert Settings &gt; Anynet+ (HDMI-CEC)) and see if Anynet+ (HDMI-CEC) has been set to On.</p> <p>Scan for Anynet+ devices again.</p> <p>Anynet+ devices must be connected to the TV using an HDMI cable. Make sure the device is connected to your TV with an HDMI cable. Some HDMI cables may not support Anynet+.</p> <p>If the connection is terminated because there has been a power failure or the HDMI cable has been disconnected, please scan for the device again.</p>
The TV audio is not being played through the receiver.	<p>Connect an optical cable to the TV and the receiver.</p> <p>ARC enables the TV to output digital sound via the HDMI (ARC) port.</p> <p>However, ARC is only available when the TV is connected to an audio receiver that supports ARC.</p>

## I Have Trouble Launching/Using Apps

When apps aren't working, these steps may help resolve the problem.

The problem	Try this!
I launched an app, but it's in English. How can I change the language?	<p>Languages supported by the app may be different from the user interface language.</p> <p>The ability to change the language depends on the service provider.</p>
My application is not working.	<p>Check with the service provider.</p> <p>Refer to the Help section on the application service provider's website.</p>





## My File Won't Play

When files aren't playing, this may help resolve the problem.

The problem	Try this!
Some files can't be played.	<p>This problem may occur with high-bitrate files. Most files can be played back, but you might experience problems with high-bitrate files.</p>

# I Want to Reset the TV

Initialize the settings to factory defaults.

Reset	Path	Description
Reset Settings	 >  Settings > Support > Self Diagnosis > Reset	Resets Picture, Sound, Broadcasting, and all other settings, except for the network settings, to the default settings.
Reset Smart Hub	 >  Settings > Support > Self Diagnosis > Reset Smart Hub	Resets all Smart Hub settings to their factory defaults and deletes all information related to Samsung accounts, linked service accounts, Smart Hub service agreements, and Smart Hub applications.

## Other Issues

Use these procedures to resolve other issues that may occur.

The problem	Try this!
The TV is hot.	Watching TV for an extended period of time causes the panel to generate heat. The heat from the panel is dissipated through internal vents running along the top of the TV. The bottom, however, may feel hot to the touch after extended use. Children watching TV need constant adult supervision to prevent them from touching the TV. This heat, however, is not a defect and does not affect the TV's functionality.
The picture won't display in full screen.	<p>HD channels will have black bars on either side of the screen when displaying upscaled SD (4:3) content.</p> <p>Black bars will appear at the top and bottom of the screen when you watch movies that have aspect ratios different from your TV.</p> <p>Adjust the picture size options on your external device or set the TV to full screen.</p>
The "Mode Not Supported" message appears.	The output resolution of the attached device is not supported by the TV. Check the TV's supported resolutions and adjust the external device's output resolution accordingly.
The Captions item in the TV is grayed out.	When an external device is connected with an HDMI or Component cable, the Caption is unavailable. Adjust the caption setting on the external device.
The TV smells of plastic.	This smell is normal and will dissipate over time.
The Signal Information under Self Diagnosis isn't activated.	<p>Verify that the current channel is a digital channel.</p> <p>Signal Information is only available for digital channels.</p>
The TV is tilted to the side.	Remove the base stand from the TV and reassemble it.
The stand is wobbly or crooked.	Make sure the indicator arrows on the stand and stand holder are properly aligned.

The problem	Try this!
The remote control and/or voice control does not work.	The TV ships with protective stickers covering some of the sensors. Make sure all of the stickers have been removed.
The Broadcasting has been deactivated.	<p>Broadcasting is only available when the <b>Source</b> is set to TV.</p> <p>The Broadcasting cannot be accessed while you watch TV using a cable or satellite box.</p> <p>The Broadcasting cannot be accessed while a recording is in progress or the Timeshift function is running.</p>
The settings are lost after 5 minutes or every time the TV is turned off.	<p>If the <b>Usage Mode</b> is set to <b>Retail Mode</b>, the TV's audio and video settings are automatically reset every 5 minutes.</p> <p>Change the Usage Mode (🏠 &gt; ⚙️ Settings &gt; System &gt; Expert Settings &gt; Usage Mode) to Home Mode.</p>
There is an intermittent loss of audio or video.	<p>Check the cable connections and reconnect them.</p> <p>Loss of audio or video can be caused by using overly rigid or thick cables. Make sure the cables are flexible enough for long term use. If you are mounting the TV to a wall, we recommend using cables with 90-degree connectors.</p>
There are small particles on the TV's bezel.	This is part of the product's design and is not a defect.
The PIP is not available.	<p>PIP is available only when an external device is connected with an HDMI or Component cable. Note that the function is unavailable when the Smart Hub is active or the <b>Sports Mode</b> is On.</p> <p> This function is not available in the U.S.A. and Canada.</p>
A POP (TV's internal banner ad) appears on the screen.	Change the Usage Mode (🏠 > ⚙️ Settings > System > Expert Settings > Usage Mode) to Home Mode.
The TV is making a popping noise.	The expansion and contraction of the TV's outer casing may cause a popping noise. This does not indicate a product malfunction. The TV is safe to use.
The TV is making a humming noise.	<p>Your TV utilizes high-speed switching circuits and high levels of electrical current. Depending on the TV's brightness level, the TV may seem slightly noisier than a conventional TV.</p> <p>Your TV has undergone strict quality control procedures that meet our demanding performance and reliability requirements.</p> <p>Some noise coming from the TV is considered normal and is not an acceptable cause for an exchange or refund.</p>

# Before Using the Recording and Timeshift Functions

Read these instructions before using Recording and Timeshift.

## Before using the recording and schedule recording functions

-  Recording is not supported in the U.S.A. and Canada.
- To set up a Schedule Recording, you must first set the TV's clock. Set the Clock (Home > Settings > System > Time > Clock).
- You can set up a maximum total of 30 Schedule Viewing and Schedule Recording entries.
- Recordings are DRM-protected and therefore cannot be played back on a computer or on a different TV. In addition, these files cannot be played back on your TV if its video circuit has been replaced.
- A USB hard drive with a speed of 5,400 rpm or above is recommended. However, RAID-type USB hard drives are not supported.
- USB memory sticks are not supported.
- The total recording capacity may differ with the amount of available hard drive space and the recording quality level.
- Schedule Recording requires at least 100 MB of free space on the USB storage device. Recording will stop if the available storage space falls below 50MB while recording is in progress.
- If the available storage space falls below 500 MB while both the Schedule Recording and Timeshift functions are in progress, only the recording will stop.
- The maximum recording time is 720 minutes.
- Videos are played according to the TV settings.
- If the input signal is changed while recording is in progress, the screen will go blank until the change is made. In this case, recording will resume, but ● will not be available.
- When using the Record or Schedule Recording function, the actual recording may start a second or two later than the specified time.
- If the Schedule Recording function is operating while a recording is being made on an HDMI-CEC external device, the priority is given to the Schedule Recording.
- Connecting a recording device to the TV automatically deletes abnormally saved recorded files.
- If the Off Timer or Auto Power Off has been set, the TV will override these settings, continue to record, and turn off after the recording has ended.



## Before using the timeshift function

 Timeshift is not supported in the U.S.A. and Canada.

- A USB hard drive with a speed of 5,400 rpm or above is recommended. However, RAID-type USB hard drives are not supported.
- USB memory sticks or flash drives are not supported.
- The total recording capacity may differ with the amount of available hard drive space and the recording quality level.
- If the available storage space falls below 500 MB while both the Schedule Recording and Timeshift functions are in progress, only the recording will stop.
- The maximum amount of time available for the Timeshift function is 90 minutes.
- The Timeshift function is not available for locked channels.
- Time-shifted videos are played according to the TV settings.
- The Timeshift function may be terminated automatically once it reaches its maximum capacity.
- The Timeshift function requires at least 1.5 GB of free space available on the USB storage device.

# Supported Resolutions for UHD Input Signals

Check the supported resolution for UHD input signals.

- Resolution: 3840 x 2160p, 4096 x 2160p

 An HDMI connection with **HDMI UHD Color** set to **Off** supports up to UHD 50P/60P 4:2:0 input signals, while an HDMI connection with **HDMI UHD Color** set to **On** supports up to UHD 50P/60P 4:4:4 and 4:2:2 input signals.

## If HDMI UHD Color is set to Off

Frame rate (fps)	Color Depth / Chroma Sampling	RGB 4:4:4	YCbCr 4:4:4	YCbCr 4:2:2	YCbCr 4:2:0
50 / 60	8 bit	-	-	-	0

## If HDMI UHD Color is set to On

Frame rate (fps)	Color Depth / Chroma Sampling	RGB 4:4:4	YCbCr 4:4:4	YCbCr 4:2:2	YCbCr 4:2:0
50 / 60	8 bit	0	0	0	0
	10 bit	-	-	0	0
	12 bit	-	-	0	0

 For the SUHD models, each HDMI connection can be individually optimized for **HDMI UHD Color**. For the UHD models, make sure to connect to the HDMI IN 1 port of the TV.

# Read Before Using Voice Interaction

Read this information before using Voice Interaction.

## Precautions for voice interaction

- Voice Interaction is not available in all languages, dialects, or regions. Its performance differs with the language chosen, voice volume, and ambient noise levels in the surrounding area.
- Voice Text Input requires that you agree to any third-party app's voice privacy policy.
- You must agree to the following privacy notices before using Interactive Voice Interaction:
  - Voice Interaction Privacy Notice, Nuance Privacy Notice

## Requirements for using voice interaction

- The voice interaction rate differs with the volume/tone, pronunciation, and ambient sound environment (TV sound and ambient noise).
- The optimal volume for voice commands is between 75 dB and 80 dB.

# Read Before Using Apps

Read this information before using Apps.

- Due to the product characteristics featured on Samsung Smart Hub, as well as limitations in available content, certain features, applications, and services may not be available on all devices or in all territories. Some Smart Hub features may also require additional peripheral devices or membership fees. Visit <http://www.samsung.com> for more information on specific device information and content availability. Services and content availability are subject to change without prior notice.
- Samsung Electronics takes no legal responsibility whatsoever for any interruption of app services caused by the service provider for any reason.
- Application services may be provided in English only and available content may differ with the geographical area.
- For more information about applications, visit the applicable service provider's website.
- An unstable Internet connection may cause delays or interruptions. In addition, applications may terminate automatically depending on the network environment. If this occurs, check your Internet connection and try again.
- Application services and updates may become unavailable.
- Application content is subject to change by the service provider without prior notice.
- Specific services may differ with the version of the application installed on the TV.
- An application's functionality may change in future versions of the application. If this occurs, run the application's tutorial or visit the service provider's website.
- Depending on the service provider's policies, certain applications may not support multitasking.

# Read Before Using the Internet

Read this information before using the WEB BROWSER.

- The WEB BROWSER is not compatible with Java applications.
- You can download the supported types of files, such as videos, mp3 files, and images, but you cannot download files that are not supported by the TV. If you attempt to download an unsupported file, you will receive an error message instead.
- The web browser may not be able to access certain websites.
- The TV does not support playback of flash videos.
- E-commerce for online purchases is not supported.
- With websites that have scrollable windows, scrolling a window can result in corrupted characters.
- ActiveX is not supported.
- Certain options are not accessible in Link Browsing mode. (Switch to Pointer Browsing to activate those options.)
- Only a limited number of fonts are supported. Certain symbols and characters may not be displayed properly.
- The response to remote commands and the resulting on-screen display may be delayed while a web page is loading.
- Loading a web page may be delayed or suspended completely with certain operating systems.
- The copy and paste operations are not supported.
- When composing an email or a simple message, certain functions such as the font size and color selection may not be available.
- There is a limit to the number of bookmarks and the size of the log file that can be saved.
- The number of windows that can be opened concurrently differs with the search conditions and the TV model.
- The web browsing speed will differ with the network environment.
- Embedded videos in a web page cannot be played at the same time while the PIP (picture-in-picture) function is operating.
- If the Clock (🏠 > ⚙️ Settings > System > Time > Clock) has not been set, the browsing history will not be saved.
- The browsing history is saved from latest to oldest, with the oldest entries being overwritten first.

- Depending on the types of video/audio codecs supported, it might not be possible to play certain video and audio files while playing HTML5 Video/Audio.
- Video sources from PC-optimized streaming service providers may not play properly on our proprietary WEB BROWSER.

## Read Before Playing Photo, Video, or Music Files

Read this information before playing media content.

### Limitations on use of photo, video, and music files

- The TV supports MSC (Mass Storage Class) USB devices only. MSC is a class designation for mass storage devices. Types of MSC devices include external hard drives, flash card readers, and digital cameras. (USB hubs are not supported.) These kinds of devices must be connected directly to the USB port. The TV may not be able to recognize a USB device or read the files on the device if it is connected with a USB extension cable. Do not disconnect USB devices while they are transferring files.
- When connecting an external hard drive, use the USB (HDD) port. We recommend that you use an external hard drive with its own power adapter.
- Certain digital cameras and audio devices may not be compatible with the TV.
- If there are multiple USB devices connected to the TV, the TV might not be able to recognize some or all the devices. USB devices that use high-power input should be connect to the USB [5V, 1A] port.
- The TV supports the FAT, exFAT, and NTFS file systems.
- After sorting files in the Folder view mode, the TV can display up to 1,000 files per folder. If the USB device contains more than 8,000 files and folders, however, some files and folders might not be accessible.
- The PTP (Picture Transfer Protocol) connection mode is available only for digital cameras. If you connect a smartphone or tablet to the TV using PTP mode, the TV will not recognize it.
- Certain files, depending on how they are encoded, may not play on the TV.
- Certain files are not supported on all models.

## Supported external subtitles

Name	Format
MPEG-4 Timed text	.ttxt
SAMI	.smi
SubRip	.srt
SubViewer	.sub
Micro DVD	.sub or .txt
SubStation Alpha	.ssa
Advanced SubStation Alpha	.ass
Powerdivx	.psb
SMPTE-TT Text	.xml

## Supported internal subtitles

Name	Container
Xsub	AVI
SubStation Alpha	MKV
Advanced SubStation Alpha	MKV
SubRip	MKV
VobSub	MKV
MPEG-4 Timed text	MP4
TTML in smooth streaming	MP4
SMPTE-TT Text	MP4
SMPTE-TT PNG	MP4

## Supported image formats and resolutions

File extension	Format	Resolution
*.jpg *.jpeg	JPEG	15360 x 8640
*.png	PNG	4096 x 4096
*.bmp	BMP	4096 x 4096
*.mpo	MPO	15360 x 8640

## Supported music formats and codecs

File extension	Format	Codec	Note
*.mp3	MPEG	MPEG1 Audio Layer 3	
*.m4a *.mpa *.aac	MPEG4	AAC	
*.flac	FLAC	FLAC	Supports up to 2 channels
*.ogg	OGG	Vorbis	Supports up to 2 channels
*.wma	WMA	WMA	Supports WMA 10 Pro up to 5.1 channels. WMA lossless audio is not supported. Supports up to the M2 profile.
*.wav	wav	wav	
*.mid *.midi	midi	midi	Supports type 0 and type 1. Seek is not supported. Supports USB device only.
*.ape	ape	ape	
*.aif *.aiff	AIFF	AIFF	
*.m4a	ALAC	ALAC	



## Supported video codecs

File format	Container	Video codecs	Resolution	Frame rate (fps)	Bitrate (Mbps)	Audio codecs			
*.avi *.mkv *.asf *.wmv *.mp4 *.mov *.3gp *.vro *.mpg *.mpeg *.ts *.tp *.trp *.mov *.flv *.vob *.svi *.m2ts *.mts *.divx	AVI MKV ASF MP4 3GP MOV FLV VRO VOB PS TS SVAF	H.264 BP/MP/HP	4096 x 2160	4096 x 2160: 30	60	Dolby Digital LPCM ADPCM(IMA, MS) AAC HE-AAC WMA Dolby Digital Plus MPEG(MP3) DTS(Core, LBR) G.711(A-Law, $\mu$ -Law)			
		HEVC (H.265 - Main, Main10, Main4:2:2 10)		3840 x 2160: 60					
		Motion JPEG	3840 x 2160	30	80				
		MVC	1920x1080	60	20				
		DivX 3.11 / 4 / 5 / 6							
		MPEG4 SP/ASP							
		Window Media Video v9 (VC1)							
		MPEG2							
		MPEG1							
		Microsoft MPEG-4 v1, v2, v3					30		
		Window Media Video v7 (WMV1), v8 (WMV2)							
		H.263 Sorrenson							
		VP6							
		*.webm					WebM	VP8	1920 x 1080
VP9	4096 x 2160					4096 x 2160: 60		40	
*.rmvb	RMVB	RV8/9/10 (RV30/40)				1920x1080	60	20	RealAudio 6

## Other restrictions

- Codecs may not function properly if there is a problem with the content.
- Video content does not play or does not play correctly if there is an error in the content or container.
- Sound or video may not work if they have standard bit rates/frame rates above the TV's compatibility ratings.
- If the Index Table is has an error, the Seek (Jump) function will not work.
- When playing video over a network connection, the video may not play smoothly because of data transmission speeds.
- Some USB/digital camera devices may not be compatible with the TV.
- HEVC codec is only available in MKV / MP4 / TS containers.

## Video decoders

- H.264 FHD is supported up to Level 4.1. (does not support FMO/ASO/RS)
- H.264 UHD is supported up to Level 5.1.
- HEVC FHD is supported up to Level 4.1, and HEVC UHD is supported up to Level 5.1.
- VC1 AP L4 is not supported.
- All video codecs excluding WMV v7, v8, MSMPEG4 v3, MVC, and VP6:  
Below 1280x720: 60 frame max  
Above 1280x720: 30 frame max
- GMC 2 or above is not supported.
- Supports SVAF Top/Bottom, Side by Side, and Left/Right view sequence type (2ES) only.
- Supports BD MVC specs only.

## Audio decoders

- Supports WMA 10 Pro up to 5.1 channels. Supports up to the M2 profile. WMA lossless audio is not supported.
- QCELP and AMR NB/WB are not supported.
- Vorbis is supported for up to 5.1 channels.
- Dolby Digital Plus is supported for up to 5.1 channels.
- The DTS LBR codec is only available for MKV / MP4 /TS containers.
- The supported sample rates are 8, 11.025, 12, 16, 22.05, 24, 32, 44.1, and 48 KHz, and differ with the codec.

# Read After Installing the TV

Read this information after installing the TV.

## Picture sizes and input signals

The Picture Size setting is applied to the current source. The applied Picture Size will remain in effect whenever you select that source unless you change it.

Input signal	Picture size
Component	16:9 Standard, Custom, 4:3
Digital channel (720p)	16:9 Standard, Custom, 4:3
Digital channel (1080i, 1080p)	16:9 Standard, Custom, 4:3
Digital channel (3840 x 2160p @ 24/30 Hz)	16:9 Standard, Custom
Digital channel (3840 x 2160p @ 50/60 Hz)	16:9 Standard, Custom
Digital channel (4096 x 2160p)	16:9 Standard, Custom
HDMI (720p)	16:9 Standard, Custom, 4:3
HDMI (1080i, 1080p)	16:9 Standard, Custom, 4:3
HDMI (3840 x 2160p)	16:9 Standard, Custom
HDMI (4096 x 2160p)	16:9 Standard, Custom
USB (720p)	16:9 Standard, Custom, 4:3
USB (1080i/p @ 60 Hz)	16:9 Standard, Custom, 4:3
USB (3840 x 2160p @ 24/30 Hz)	16:9 Standard, Custom
USB (3840 x 2160p @ 60 Hz) USB (4096 x 2160p @ 24/30/60 Hz)	16:9 Standard, Custom

## Installing an anti-theft lock

An anti-theft lock is a physical device that can be used to protect the TV against theft. Look for the lock slot on the back of the TV. The slot has a  icon next to it. To use the lock, wrap the lock cable around an object that is too heavy to carry and then thread it through the TV's lock slot. The lock is sold separately. The method of using an anti-theft lock may differ for each TV model. Refer to the lock's user manual for more information.

 This function is not available on certain models in specific geographical areas.

## Read before setting up a wireless Internet connection

### Precautions for wireless Internet

- This TV supports the IEEE 802.11 a /b /g /n /ac communication protocols. Samsung recommends using IEEE 802.11n. Video files stored on a device connected to the TV via a Home Network may not play back smoothly.

 IEEE 802.11 ac communication protocol is not available on certain models.

- To use wireless Internet, the TV must be connected to a wireless router or modem. If the wireless router supports DHCP, the TV can use a DHCP or static IP address to connect to the wireless network.
- Select a channel that is not currently in use for the wireless router. If the channel set for the wireless router is currently being used by another device, the result is usually interference and/or a communications failure.
- Most wireless networks have an optional security system. To enable a wireless network's security system, you need to create a password using characters and numbers. This password is then needed to connect to a security-enabled AP.

### Wireless security protocols

The TV only supports the following wireless network security protocols. The TV cannot connect to non-certified wireless routers.

- Authentication Modes: WEP, WPAPSK, WPA2PSK
- Encryption Types: WEP, TKIP, AES

In compliance with the newest Wi-Fi certification specifications, Samsung TVs do not support WEP or TKIP security encryption in networks running in the 802.11n mode. If the wireless router supports WPS (Wi-Fi Protected Setup), you can connect the TV to your network using PBC (Push Button Configuration) or a PIN (Personal Identification Number). WPS automatically configures the SSID and WPA key settings.

# Read Before Connecting a Computer (Supported Resolutions)

Check the supported resolution for PC input signals.

When you connect your TV to a computer, set the computer's video card to one of the standard resolutions listed in the tables below or on the next page. The TV will automatically adjust to the resolution you choose. Note that the optimal and recommended resolution is 3840 x 2160 at 60 Hz. Choosing a resolution not included in the tables can result in a blank screen or just the power indicator turning on. Refer to the user manual of your graphics card for compatible resolutions.

## IBM

Resolution (Dots x lines)	Display format	Horizontal frequency (KHz)	Vertical frequency (Hz)	Clock frequency (MHz)	Polarity (horizontal / vertical)
720 x 400	70 Hz	31.469	70.087	28.322	- / +

## MAC

Resolution (Dots x lines)	Display format	Horizontal frequency (KHz)	Vertical frequency (Hz)	Clock frequency (MHz)	Polarity (horizontal / vertical)
640 x 480	67 Hz	35.000	66.667	30.240	- / -
832 x 624	75 Hz	49.726	74.551	57.284	- / -
1152 x 870	75 Hz	68.681	75.062	100.000	- / -

# VESA DMT

Resolution (Dots x lines)	Display format	Horizontal frequency (KHz)	Vertical frequency (Hz)	Clock frequency (MHz)	Polarity (horizontal / vertical)
640 x 480	60 Hz	31.469	59.940	25.175	- / -
640 x 480	72 Hz	37.861	72.809	31.500	- / -
640 x 480	75 Hz	37.500	75.000	31.500	- / -
800 x 600	60 Hz	37.879	60.317	40.000	+ / +
800 x 600	72 Hz	48.077	72.188	50.000	+ / +
800 x 600	75 Hz	46.875	75.000	49.500	+ / +
1024 x 768	60 Hz	48.363	60.004	65.000	- / -
1024 x 768	70 Hz	56.476	70.069	75.000	- / -
1024 x 768	75 Hz	60.023	75.029	78.750	+ / +
1152 x 864	75 Hz	67.500	75.000	108.000	+ / +
1280 x 720	60 Hz	45.000	60.000	74.250	+ / +
1280 x 800	60 Hz	49.702	59.810	83.500	- / +
1280 x 1024	60 Hz	63.981	60.020	108.000	+ / +
1280 x 1024	75 Hz	79.976	75.025	135.000	+ / +
1366 x 768	60 Hz	47.712	59.790	85.500	+ / +
1440 x 900	60 Hz	55.935	59.887	106.500	- / +
1600 x 900RB	60 Hz	60.000	60.000	108.000	+ / +
1680 x 1050	60 Hz	65.290	59.954	146.250	- / +
1920 x 1080	60 Hz	67.500	60.000	148.500	+ / +

# Supported Resolutions for Video Signals

Check the supported resolution for video signals.

## CEA-861

Resolution (Dots x lines)	Display format	Horizontal frequency (KHz)	Vertical frequency (Hz)	Clock frequency (MHz)	Polarity (horizontal / vertical)
720 (1440) x 576i	50 Hz	15.625	50.000	27.000	- / -
720 (1440) x 480i	60 Hz	15.734	59.940	27.000	- / -
720 x 576	50 Hz	31.250	50.000	27.000	- / -
720 x 480	60 Hz	31.469	59.940	27.000	- / -
1280 x 720	50 Hz	37.500	50.000	74.250	+ / +
1280 x 720	60 Hz	45.000	60.000	74.250	+ / +
1920 x 1080i	50 Hz	28.125	50.000	74.250	+ / +
1920 x 1080i	60 Hz	33.750	60.000	74.250	+ / +
1920 x 1080	24 Hz	27.000	24.000	74.250	+ / +
1920 x 1080	25 Hz	28.125	25.000	74.250	+ / +
1920 x 1080	30 Hz	33.750	30.000	74.250	+ / +
1920 x 1080	50 Hz	56.250	50.000	148.500	+ / +
1920 x 1080	60 Hz	67.500	60.000	148.500	+ / +
3840 x 2160	24 Hz	54.000	24.000	297.000	+ / +
3840 x 2160	25 Hz	56.250	25.000	297.000	+ / +
3840 x 2160	30 Hz	67.500	30.000	297.000	+ / +
3840 x 2160	50 Hz	112.500	50.000	594.000	+ / +
3840 x 2160	60 Hz	135.000	60.000	594.000	+ / +
4096 x 2160	24 Hz	54.000	24.000	297.000	+ / +
4096 x 2160	25 Hz	56.250	25.000	297.000	+ / +
4096 x 2160	30 Hz	67.500	30.000	297.000	+ / +
4096 x 2160	50 Hz	112.500	50.000	594.000	+ / +
4096 x 2160	60 Hz	135.000	60.000	594.000	+ / +

# Read Before Using Bluetooth Devices

Read this information before using a Bluetooth device.

 This function is not available on certain models in specific geographical areas.

## Restrictions on using Bluetooth

- The Samsung Bluetooth Speaker is only available for devices supporting TV SoundConnect.
- You can't use Bluetooth devices, TV SoundConnect, and the Surround feature simultaneously.
- Compatibility issues may occur, depending on the Bluetooth device. (A Mobile exclusive headphone may not be available, depending on the environment.)
- Lip-sync errors may occur.
- The TV and Bluetooth device may disconnect, depending on the distance between them.
- A Bluetooth device may hum or malfunction:
  - When a part of your body is in contact with the receiving/transmitting system of the Bluetooth device or the TV.
  - When the device is subject to electrical variation from obstructions caused by a wall, corner, or office partitioning.
  - When the device is exposed to electrical interference from same frequency-band devices including medical equipment, microwave ovens, and wireless LANs.
- If the problem persists, try connecting the device using the digital optical port or the HDMI (ARC) port.



# Blocking programs based on their TV Rating

Read this information before viewing a blocking program.

To block content, select a rating category to lock. All programs at that level and higher are blocked and require the PIN to watch. To unblock a category, select the lock icon. To unblock all the categories in a row, select the lock under ALL.

## Categories on the left:

- TV-Y: Young children
- TV-Y7: Children 7 and over
- TV-G: General audience
- TV-PG: Parental guidance
- TV-14: Viewers 14 and over
- TV-MA: Mature audience

## Categories on the top:

- ALL: Lock all TV ratings.
- FV: Fantasy violence
- V: Violence
- S: Sexual situations
- L: Adult Language
- D: Sexually Suggestive Dialog

## Blocking movies base on their Movie Rating (MPAA)

This rating system applies to all materials with supplied ratings in the U.S.A.

From the MPAA:

“The Motion Picture Association of America (MPAA) has implemented a rating system that provides parents or guardians with advanced information on which films are appropriate for children.”

Select a lock beside one of the rating categories to block that category and all higher categories. To unblock a category, select the lock icon.

- G: General audience (no restrictions).
- PG: Parental guidance suggested.
- PG-13: Parents strongly cautioned.
- R: Restricted. Children under 17 should be accompanied by an adult.
- NC-17: No children under age 17.
- X: Adults only.
- NR: Not rated.

## Blocking programs based on their Canadian English Rating

This rating system applies to all rated material viewed on English-Canadian TV channels.

Select a lock beside one of the rating categories to block that category and all higher categories. To unblock a category, select the lock icon.

- C: Programming intended for children under age 8
- C8+: Programming generally considered acceptable for children 8 years and over to watch on their own
- G: General programming, suitable for all audiences
- PG: Parental Guidance
- 14+: Programming containing themes or content that may not be suitable for viewers under the age of 14
- 18+: Adult programming

## Blocking programs based on their Canadian French Rating

This rating system applies to all rated material viewed on French-Canadian TV channels.

Select a lock beside one of the rating categories to block that category and all higher categories. To unblock a category, select the lock icon.

- G: General
- 8 ans+: Programming acceptable for children 8 years and over to watch on their own
- 13 ans+: Programming that may not be suitable for children under the age of 13
- 16 ans+: Programming not suitable for children under the age of 16
- 18 ans+: Programming restricted to adults

## Blocking Programs based on their Downloadable U.S. Rating

This rating system only applies to material originating from US DTV channels.

Parental restriction information is automatically downloaded while you watch DTV channels. This download may take several seconds. If the information is unavailable from the broadcasting station, the Downloadable U.S. Rating menu is deactivated.

Parental restriction levels differ with the broadcasting station. The default menu name and the Downloadable U.S. Rating name changes depending on the downloaded information.

Even when the on-screen display is set to another language, the Downloadable U.S. Rating menu appears only in English.

Select a lock beside one of the rating categories to block that category and all higher categories. To unblock a category, select the lock icon.

# Buttons and Functions







Review available media playback, control, and record buttons and descriptions of how they are used.

 The available buttons and functions may differ with the content you are viewing or playing.



## Buttons and functions available while playing multimedia content

Press the Select button while playing any video, photo or recorded content. The following buttons appear.

 The provided buttons or functions may differ with the media content type.

- **Pause / Play or Start**  
Pauses or plays the multimedia content. You can use the following functions when the video is paused.
  - **Slow Rewind or Slow Forward:** Allows you to play the video slowly (1/8, 1/4, 1/2) backward or forward by selecting the  or  button. To increase the rewind or forward speed in slow mode up to 3 times, select the button repeatedly. To return to normal speed, select the  button or press the  button.
- **Previous / Next**  
Displays the previous or the next multimedia content file.
- **Rewind / Fast Forward**  
Rewinds or fast forwards the multimedia content. To increase the rewind or fast forward speed up to 3 times faster than normal, select the button repeatedly. To return to normal speed, select the  button or press the  button.
- **Repeat**  
Plays the current multimedia content repeatedly or all multimedia content files in the same folder repeatedly.
- **Shuffle**  
Plays music files in random order.
- **Picture Off**  
Plays multimedia content with the screen off.
- **Rotate left / Rotate right**  
Rotates a photo left or right.

- **Zoom**  
Zooms a photo in by up to a factor of 4.
- **Screen Fit**  
Fits a photo to the screen.
- **Background Music**  
During a slideshow, plays or pauses the background music.
- **Options**  
 The available options may differ with the model and content.

Function	Description
Slideshow Speed	Sets the slideshow speed.
Slideshow Effect	Applies transition effects to the slide show.
Background Music	Plays background music while the TV displays photos.  The music files must be saved in the same USB device as the photo files.  To pause the background music, select <b>Background Music</b> on the playback screen.
Information	Displays detailed information about the current multimedia content.
Subtitles	Controls video subtitles. <b>Subtitles:</b> Turns the subtitles on or off. <b>Language:</b> Sets the caption language. <b>Sync:</b> Adjusts the synchronization when the video and the subtitles are not synchronized. <b>Reset Sync:</b> Resets the subtitle synchronization adjustment to 0. <b>Size:</b> Changes the font size of the subtitles. <b>Encoding:</b> Displays a list of encoding languages. Allows you to change the encoding language when subtitles are displayed incorrectly. <b>Edge Type:</b> Adjusts a position of texts and subtitles edge. <b>Edge Color:</b> Changes a color of subtitles edge.
Rotate	Rotates the video.
Audio Language	This function is only available if the video supports multi-track sound.

## Buttons and functions available while using sports mode

If you press the Select button, the following buttons appear.

- **Zoom**

Pauses the current screen and zooms in any part of the screen by using the Directional pad.

 This function is not available when you browse the multimedia content saved on a USB storage device or PIP is active.

- **Record**

 This function is only available if the TV supports the recording function.

- **Timeshift**



You can pause and rewind live TV.

 For more information about Timeshift, refer to "[Using Timeshift](#)."

 This function is only available if the TV supports the recording function.

- **Manual Highlight**

Saves a video from 10 seconds before you press the button to 10 seconds after.

 You can set the TV to automatically save highlights without user intervention. Select  >  **Settings** > **Picture** > **Special Viewing Mode** > **Sports Mode**, and then set **Auto Highlights** to **On**. For more information about **Auto Highlights**, refer to "[Extracting highlights automatically](#)."

 This function is only available while recording a program.

- **Highlights Player**

Displays the Highlights Player screen and plays the highlights saved in the recorded file automatically or manually. Highlights Player is not available when:

- You are switching the input signal
- **Video Description** is on

 This function is only available while recording a program.

- **Dual Play**

Allows you to watch a current program in a PIP window while watching a recorded program. To exit PIP mode, select again. Dual Play is not available when:

- You are switching the input signal
- **Video Description** is on
- You are viewing a soccer game in the UHD resolution

 This function is only available while recording a program.

 This button is only available while you are watching a timeshift video.

- REC Time

 This function is only available if the TV supports the recording function.

- Stop Recording

 This function is only available if the TV supports the recording function.

## Buttons and functions available while recording a program or Timeshift

 This function is not available in the U.S.A. and Canada.

 The available buttons and functions may differ with the functions.

If you press the Select button, the following buttons appear.

- REC Time

- Record

Starts instant recording of the current program.

- Timeshift

You can pause and rewind live TV.

- Stop Recording, Stop Timeshift / Go to Live TV

## Using the buttons on the remote control while recording a program or Timeshift

 This function is not available in the U.S.A. and Canada.

- Pause / Play

You can use the following function when the video is paused. (Note that with the video paused, the TV does not play audio.)

- **Slow Motion:** Press the  button while recording is in pause mode to play the video back at half speed.

- Rewind / Fast forward

 This function is not available while you are watching a program that is currently being broadcast.

# License

Check the license information and trademarks applied in your TV.



DivX Certified® to play DivX® video up to HD 1080p, including premium content.

DivX®, DivX Certified® and associated logos are trademarks of DivX, LLC and are used under license.

This DivX Certified® device has passed rigorous testing to ensure it plays DivX® video.

To play purchased DivX movies, first register your device at [vod.divx.com](http://vod.divx.com). Find your registration code in the DivX VOD section of your device setup menu.

Covered by one or more of the following U.S. patents:

7,295,673; 7,460,668; 7,515,710; 8,656,183; 8,731,369; RE45,052.



For DTS patents, see <http://patents.dts.com>. Manufactured under license from DTS, Inc. DTS, the Symbol, DTS in combination with the Symbol, DTS Premium Sound|5.1, DTS Digital Surround, DTS Express, and DTS Neo2:5 are registered trademarks or trademarks of DTS, Inc. in the United States and/or other countries.

© DTS, Inc. All Rights Reserved.



Manufactured under license from Dolby Laboratories.

Dolby and the double-D symbol are trademarks of Dolby Laboratories.



The terms HDMI and HDMI High-Definition Multimedia Interface, and the HDMI Logo are trademarks or registered trademarks of HDMI Licensing LLC in the United States and other countries.

## Open Source License Notice

Open Source used in this product can be found on the following webpage. (<http://opensource.samsung.com>) Open Source License Notice is written only English.



 This license may not be supported depending on your country or model.