



# Washer

## User manual

WF45K6500A\*/WF45K6200A\*



**SAMSUNG**

# Contents

---

<b>Safety information</b>	<b>4</b>
What you need to know about the safety instructions	4
Important safety symbols	4
Important safety precautions	5
Critical installation warnings	6
Installation cautions	7
Critical usage warnings	8
Usage cautions	10
Critical cleaning warnings	13
<b>Installation</b>	<b>14</b>
What's included	14
Installation requirements	15
Step-by-step installation	20
<b>Before you start</b>	<b>28</b>
Initial settings	28
Laundry guidelines	28
Detergent drawer guidelines	30
<b>Operations</b>	<b>33</b>
Feature panel	33
Simple steps to start	35
Cycle overview	36
Samsung Smart Home (applicable models only)	39
Special features	46
<b>Maintenance</b>	<b>49</b>
Self Clean+	49
Smart Care	50
Emergency drain	51
Cleaning	52
Recovery from freezing	56
Care against an extended time of disuse	56
Cleaning the exterior	57

---

Cleaning the interior	57
<b>Troubleshooting</b>	<b>58</b>
Checkpoints	58
Samsung Smart Home	62
Information codes	63
<b>Specifications</b>	<b>65</b>
Fabric care chart	65
Protecting the environment	66
Declaration of conformity	66
Specification sheet	67
Cycle chart	68

# Safety information

---

Congratulations on your new Samsung washer. This manual contains important information on the installation, use and care of your appliance. Please take some time to read this manual to take full advantage of your washer's many benefits and features.

## What you need to know about the safety instructions

---

Please read this manual thoroughly to ensure that you know how to safely and efficiently operate the extensive features and functions of your new appliance. Please store the manual in a safe location close to the appliance for future reference. Use this appliance only for its intended purpose as described in this instruction manual.

Warnings and Important Safety Instructions in this manual do not cover all possible conditions and situations that may occur. It is your responsibility to use common sense, caution, and care when installing, maintaining and operating your washer.

Because the following operating instructions cover various models, the characteristics of your washer may differ slightly from those described in this manual and not all warning signs may be applicable. If you have any questions or concerns, contact your nearest service center or find help and information online at [www.samsung.com](http://www.samsung.com).

## Important safety symbols

---

What the icons and signs in this user manual mean:

 **WARNING**

Hazards or unsafe practices that may result in severe personal injury, death and/or property damage.

 **CAUTION**

Hazards or unsafe practices that may result in personal injury and/or property damage.

 **NOTE**

Indicates that a risk of personal injury or material damage exists.

**These warning signs are here to prevent injury to yourself and others.**

**Please follow them explicitly.**

**After reading this manual, store it in a safe place for future reference.**

Read all instructions before using the appliance.

As with any equipment that uses electricity and moving parts, potential hazards exist.

To safely operate this appliance, familiarize yourself with its operation and exercise care when using it.

# SAVE THESE INSTRUCTIONS

---

## Important safety precautions

---

### **WARNING**

To reduce the risk of fire, electric shock, or injury to persons when using your appliance, follow basic precautions, including the following:

1. Read all instructions before using the appliance.
2. Do not wash or dry articles that have been previously cleaned in, washed in, soaked in, or spotted with gasoline, dry-cleaning solvents, other flammable or explosive substances as they give off vapors that could ignite or explode.
3. Do not allow children to play on or in the appliance. Close supervision of children is necessary when the appliance is used near children.
4. Before the appliance is removed from service or discarded, remove the door to the washing or drying compartment.
5. Do not reach into the appliance if the drum is moving.
6. Do not install or store this appliance where it will be exposed to the weather.
7. Do not tamper with controls.
8. Do not repair or replace any part of the appliance or attempt any servicing unless specifically recommended in the user-maintenance instructions or in published user repair instructions that you understand and have the skills to carry out.
9. Do not add gasoline, dry-cleaning solvents, or other flammable or explosive substances to the wash water. These substances give off vapors that could ignite or explode.
10. Under certain conditions, hydrogen gas may be produced in a hot water system that has not been used for 2 weeks or more. **HYDROGEN GAS IS EXPLOSIVE.** If the hot water system has not been used for such a period, before using a washer or combination washer-dryer, turn on all hot water faucets and let the water flow from each for several minutes. This will release any accumulated hydrogen gas. As the gas is flammable, do not smoke or use an open flame during this time.

# SAVE THESE INSTRUCTIONS

# Safety information

## Critical installation warnings

### State of California Proposition 65 Warnings (US only)

This product contains chemicals known to the State of California to cause cancer and birth defects or other reproductive harm.

The installation of this appliance must be performed by a qualified technician or service company.

- Failure to do so may result in electric shock, fire, an explosion, problems with the product, or injury.

The appliance is heavy, therefore take care when lifting it.

Plug the power cord into a wall socket that meets local electrical specifications. Use the socket for this appliance only, and do not use an extension cord.

- Sharing a wall socket with other appliances, using a power strip, or extending the power cord may result in electric shock or fire.
- Ensure that the voltage, frequency, and current supplied to the washer matches those listed in the product specifications. Failure to do so may result in electric shock or fire. Plug the power plug into the wall socket firmly.

Remove all foreign substances such as dust or water from the power plug terminals and contact points using a dry cloth on a regular basis.

- Unplug the power plug and clean it with a dry cloth.
- Failure to do so may result in electric shock or fire.

Plug the power plug into the wall socket so that the cord is running towards the floor.

- If you plug the power plug into the socket in the opposite direction, the electric wires within the cable may be damaged and this may result in electric shock or fire.

Keep all packaging materials out of the reach of children as these may be dangerous.

- If a child places a plastic bag over his or her head, he or she can suffocate.

If the appliance, power plug, or power cord is damaged, contact your nearest Samsung service center for service.

This appliance must be properly grounded.

Do not ground the appliance to a gas pipe, plastic water pipe, or telephone line.

- This may result in electric shock, fire, an explosion, or problems with the product.

## SAVE THESE INSTRUCTIONS

- Never plug the power cord into a socket that is not grounded correctly. Make sure that the socket is in accord with local and national regulations.

Do not install this appliance near a heater or any flammable material.

Do not install this appliance in a humid, oily or dusty location, or in a location exposed to direct sunlight or water (rain drops).

Do not install this appliance in a location exposed to low temperatures.

- Frost may cause the tubes to burst.

Do not install this appliance in a location where gas may leak.

- This may result in electric shock or fire.

Do not use an electric transformer to power the washer.

- This may result in electric shock or fire.

Do not use a damaged power plug, damaged power cord, or loose wall socket.

- This may result in electric shock or fire.

Do not pull or bend the power cord excessively.

Do not twist or tie the power cord.

Do not hook the power cord over a metal object, place a heavy object on the power cord, insert the power cord between objects, or push the power cord into the space behind the appliance.

- This may result in electric shock or fire.

Do not pull the power cord when unplugging the power plug.

- Unplug the power plug by pulling the plug.
- Failure to do so may result in electric shock or fire.

This appliance should be positioned so that the power plug, the water supply taps, and the drain pipes are accessible.

## Installation cautions

### CAUTION

This appliance should be positioned in such a way that the power plug is easily accessible.

- Failure to do so may result in electric shock or fire due to electric leakage.

# SAVE THESE INSTRUCTIONS

# Safety information

---

Install your appliance on a solid, level floor that can support its weight.

- Failure to do so may result in abnormal vibrations, movement, noise, or problems with the product.

## Critical usage warnings

---

### **WARNING**

If the appliance is flooded, turn off the water and power supplies immediately and contact your nearest Samsung service center.

- Do not touch the power plug with wet hands.
- Failure to do so may result in electric shock.

If the appliance generates a strange noise, a burning smell, or smoke, unplug the power plug immediately and contact your nearest Samsung service center.

- Failure to do so may result in electric shock or fire.

In the event of a gas leak (such as propane gas, LP gas, etc.), ventilate the room immediately without touching the power plug. Do not touch the appliance or power cord.

- Do not use a ventilating fan. Do not turn on a light.
- A spark may result in an explosion or fire.

Do not let children play in or on the washer. In addition, when disposing of the appliance, remove the washer door lever.

- Children can suffocate to death if trapped inside the product.

Make sure to remove the packaging (sponge, styrofoam) attached to the bottom of the washer before using it.

Do not wash items contaminated with gasoline, kerosene, benzene, paint thinner, alcohol or other inflammable or explosive substances in the washer.

- This may result in electric shock, fire, or an explosion.

Do not open the washer door by force while it is operating (high-temperature washing/drying/spinning).

- Water flowing out of the washer may result in burns or cause the floor to be slippery. This may result in injury.
- Opening the door by force may result in damage to the product or injury.

Do not insert your hand under the washer while an operation is in progress.

- This may result in injury.

## SAVE THESE INSTRUCTIONS



Do not touch the power plug with wet hands.

- This may result in electric shock.

Do not turn the appliance off by unplugging the power plug while an operation is in progress.

- Plugging the power plug into the wall socket again may cause a spark and result in electric shock or fire.

Do not let children or the infirm use this washer without proper supervision. Do not let children climb in or onto the appliance.

- This may result in electric shock, burns, or injury.

Do not insert your hand or a metal object under the washer while it is operating.

- This may result in injury.

Do not unplug the appliance by pulling the power cord. Always grip the plug firmly and pull it straight out of the outlet.

- Damage to the power cord may cause a short-circuit, fire, and/or electric shock.

Do not attempt to repair, disassemble, or modify the appliance yourself.

- Do not use a fuse (such as copper, steel wire, etc.) other than a standard fuse.
- If the appliance needs to be repaired or reinstalled, contact your nearest Samsung service center.
- Failure to do so may result in electric shock, fire, problems with the product, or injury.

If the water supply hose comes loose from the faucet and floods the appliance, unplug the power plug.

- Failure to do so may result in electric shock or fire.

Unplug the power plug when the appliance is not being used for long periods of time or during a thunder or lightning storm.

- Failure to do so may result in electric shock or fire.

If any foreign substance enters the appliance, unplug the power plug and contact your nearest Samsung service center.

- This may result in electric shock or fire.

## SAVE THESE INSTRUCTIONS

# Safety information

---

Do not let children (or pets) play in or on your washer. The washer door does not open easily from the inside and children may be seriously injured if trapped inside.

## Usage cautions

---

### CAUTION

If the washer is contaminated by a foreign substance such as detergent, dirt, food waste, etc., unplug the power plug and clean the washer using a damp, soft cloth.

- Failure to do so may result in discoloration, deformation, damage, or rust.

The front glass may be broken by a strong impact. Take care when using the washer.

- If the glass is broken, it may result in injury.

After a water supply failure or when reconnecting the water supply hose, open the faucet slowly.

Open the faucet slowly after a long period of non-use.

- The air pressure in the water supply hose or the water pipe may damage a product part or result in a water leak.

If a draining error occurs during an operation, check if there is a draining problem.

- If the washer is used when it is flooded because of a draining problem, it may result in electric shock or fire.

Insert the laundry into the washer completely so that the laundry does not get caught in the door.

- If laundry gets caught in the door, it may result in damage to the laundry or the washer, or result in a water leak.

Turn the water supply off when the washer is not being used.

- Ensure that the water supply hose connectors are properly tightened.

Ensure that the rubber seal and front door glass are not contaminated by a foreign substance (e.g. waste, thread, hair, etc.).

- If a foreign substance is caught in the door or the door is not completely closed, it may cause a water leak.

## SAVE THESE INSTRUCTIONS

Open the faucet and check if the water supply hose connectors are firmly tightened and that there are no water leaks before using the product.

- If the connectors on the water supply hoses connector are loose, it may result in a water leak.

The product you have purchased is designed for domestic use only.

Using the product for business purposes qualifies as product misuse. If the product is used for business purposes, the product will not be covered by the standard warranty provided by Samsung and no responsibility can be attributed to Samsung for malfunctions or damages resulting from such misuse.

Do not stand on the appliance or place objects (such as laundry, lighted candles, lighted cigarettes, dishes, chemicals, metal objects, etc.) on the appliance.

- This may result in electric shock, fire, problems with the product, or injury.

Do not spray volatile material such as insecticide onto the surface of the appliance.

- As well as being harmful to humans, this may result in electric shock, fire, or problems with the product.

Do not place objects that generate electromagnetic fields near the washer.

- This may result in injury due to a malfunction.

Water drained during a high-temperature wash or drying cycle is hot. Do not touch the water.

- This may result in burns or injury.

Do not wash, spin, or dry water-proof seats, mats, or clothing (\*) unless your appliance has a special cycle for washing these items.

(\*): Woollen bedding, rain covers, fishing vests, ski pants, sleeping bags, diaper covers, sweat suits, and bicycle, motor cycle and car covers, etc.

- Do not wash thick or hard mats even if the washer mark is on the care label. This may result in injury or damage to the washer, walls, floor, or clothing due to abnormal vibrations.
- Do not wash throw rugs or doormats with rubber backing. The rubber backing may come off and stick to inside the drum, and this may result in a malfunction such as a drainage error.

Do not operate the washer when the detergent drawer is removed.

- This may result in electric shock or injury due to a water leak.

## SAVE THESE INSTRUCTIONS

# Safety information

---

Do not touch the insides of the drum during or just after drying as it is hot.

- This may result in burns.

Do not insert your hand into the detergent drawer.

- This may result in injury as your hand may be caught by the detergent input device.
- Do not use the liquid detergent container (on applicable models only) for powdered detergent. Remove the container and put powdered detergent directly into the Main wash compartment.

Do not place any objects (such as shoes, food waste, animals) other than laundry into the washer.

- This may result in damage to the washer, or injury and death in the case of pets due to abnormal vibrations.

Do not press the buttons using sharp objects such as pins, knives, fingernails, etc.

- This may result in electric shock or injury.

Do not wash laundry contaminated by oils, creams, or lotions usually found in skincare shops or massage clinics.

- This may cause the rubber seal to become deformed and result in a water leak.

Do not leave metal objects such as safety pins or hair pins in the drum for long periods of time. Do not leave bleach in the drum for long periods of time.

- Doing either may cause the drum to rust.
- If rust starts appearing on the surface of the drum, apply a (neutral) cleansing agent to the surface and use a sponge to clean it. Never use a metal brush.

Do not use dry cleaning detergent directly and do not wash, rinse, or spin laundry contaminated by dry cleaning detergent.

- This may result in spontaneous combustion or ignition due to the heat from the oxidation of the oil.

Do not use water from water cooling/heating devices.

- This may result in problems with the washer.

Do not use natural hand-washing soap in the washer.

- If it hardens and accumulates inside the washer, it may result in problems with the product, discoloration, rust, or bad odours.

## SAVE THESE INSTRUCTIONS

Place socks and brassieres in a washing net and wash them with the other laundry.

Do not wash large laundry items such as bedding in the washing net.

- Failure to do so may result in injury due to abnormal vibrations.

Do not use hardened detergent.

- If it accumulates inside the washer, it may result in a water leak.

Make sure that the pockets of all the clothing items to be washed are empty.

- Hard, sharp objects such as coins, safety pins, nails, screws, or stones can cause extensive damage to the appliance.

Do not wash clothing with large buckles, buttons, or other heavy metal objects in the washer.

Sort the laundry by color on the basis of its colorfastness and select the recommended cycle, water temperature, and additional functions.

- Failure to do this may result in discoloration or fabric damage.

Take care that children's fingers are not caught in the door when you close it.

- Failure to do so may result in injury.

## Critical cleaning warnings

### **WARNING**

Do not clean the appliance by spraying water directly onto it.

Do not use a strong acidic cleaning agent.

Do not use benzene, thinner, or alcohol to clean the appliance.

- This may result in discoloration, deformation, damage, electric shock, or fire.

Before cleaning the washer or performing maintenance, unplug the appliance from the wall socket.

- Failure to do so may result in electric shock or fire.

# SAVE THESE INSTRUCTIONS

# Installation

Follow these instructions carefully to ensure proper installation of the washer and to prevent accidents when doing laundry.

## What's included

Make sure all the parts are included in the product package. If you have a problem with the washer or the parts, contact a local Samsung customer center or your retailer.

Installation

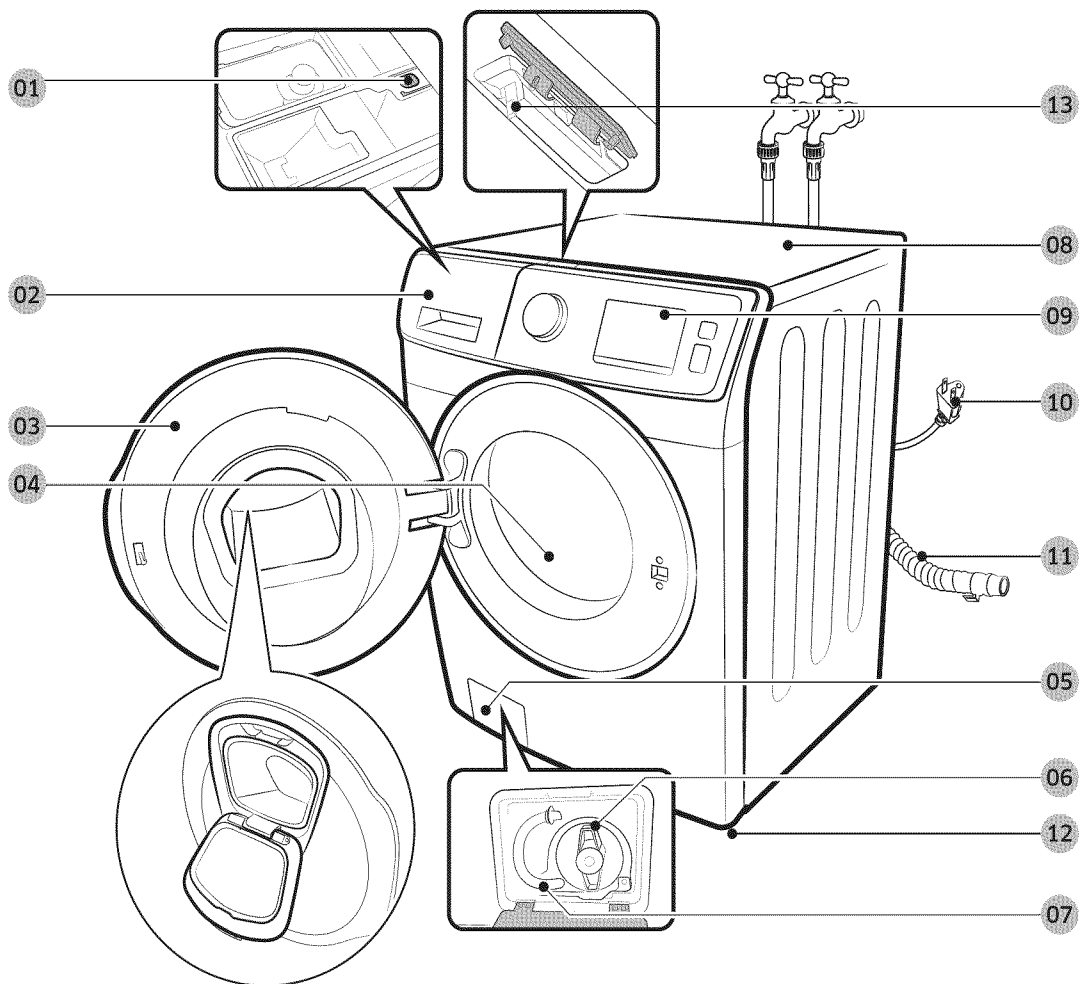

**01** Release lever

**02** Detergent drawer

**03** Door

**04** Drum

**05** Filter cover

**06** Pump filter

**07** Emergency drain tube

**08** Worktop

**09** Control panel

**10** Power plug

**11** Drain hose

**12** Levelling feet

**13** Smart Home Adapter port

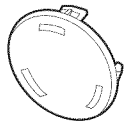

Bolt caps

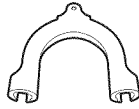

Hose guide

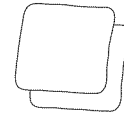

Anti-slip pads (sold separately)

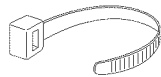

Tie straps

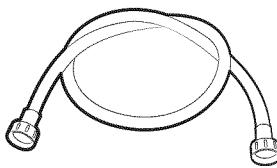

Water hoses (sold separately)

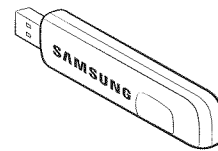

Smart Home Adapter (sold separately)

#### NOTE

- Bolt caps: The provided number (3 to 6) of bolt caps depends on the model.
- The appearance of the machine and provided accessories may differ with the model.
- To purchase an accessory or lost part, contact a local Samsung service center, Samsung Customer Care, or your retailer.
- The Smart Home Adapter is available for purchase only on the Samsung website ([www.samsung.com](http://www.samsung.com)).

#### CAUTION

- Do not reuse old water hoses, which may leak or burst, causing flooding and/or property damage.
- Make sure rubber washers are inserted in each coupling of the water hose.

## Installation requirements

### Electrical supply and grounding

- AC 120 V / 60 Hz fuse or circuit breaker is required.
- Use an individual branch circuit.  
Connect only the washer to the circuit.

To ensure proper grounding, the washer comes with a power cord featuring a three-prong grounding plug for use in a properly installed and grounded outlet.

Check with a qualified electrician or service person if you are not sure about the grounding.

Do not modify the provided plug. If it does not fit the outlet, call a qualified electrician to install a proper outlet.

#### WARNING

- Do NOT use an extension cord.

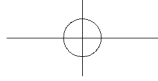

# Installation

- Use only the power cord that comes with the washer.
- Do NOT connect the ground wire to plastic plumbing, gas lines, or hot water pipes.
- Improperly connected grounding conductors may cause electric shock.
- To prevent unnecessary risk of fire, electrical shock, or personal injury, all wiring and grounding must be done in accordance with local codes, or in the absence of local codes, in accordance with the National Electrical Code, ANSI/NFPA No. 70-Latest Revision (for the U.S.) or the Canadian Electrical Code CSA C22.1 - Latest Revisions and local codes and ordinances. It is your responsibility to provide adequate electrical service for your washer.

## Water supply

Proper water pressure for this washer is between 20-116 psi (137-800 kPa). Water pressure less than 20 psi (137 kPa) may cause the water valve not to close completely. Or, it may take longer to fill the drum, causing the washer to turn off. Faucets must be within 4 feet (122 cm) from the rear of the washer so that the provided inlet hoses reach the washer.

To reduce the risk of leaks:

- Make sure faucets are easily accessible.
- Turn off the taps when the washer is not in use.
- Check for any leaks at the water inlet hose fittings on a regular basis.

### CAUTION

Before using the washer for the first time, check all connections at the water valve and taps for any leaks.

## Drain

Samsung recommends a standpipe 18 in (46 cm) high. The drain hose must be connected through the hose clip to the standpipe, and the standpipe must fully cover the drain hose.

## Flooring

For best performance, the washer must be installed on a solid floor. Wood floors may need to be reinforced to minimize vibration and/or unbalanced loads. Carpeting and soft tile surfaces do not provide good resistance to vibrations and may cause the washer to move slightly during the spin cycle.

### CAUTION

Do NOT install the washer on a platform or a poorly supported structure.

## Water temperature

Do not install the washer in areas where water may freeze as the washer always retains some water in its water valves, pumps, and/or hoses. Frozen water left in the connection parts may cause damage to belts, the pump, and other components of the washer.

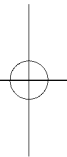
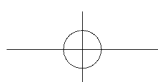



### Alcove or closet installation

Minimum clearance for stable operation:

Sides	1 in. (25 mm)
Top	17 in. (432 mm)
Rear	5.9 in. (150 mm)
Front	2 in. (51 mm)

If both the washer and a dryer are installed in the same location, the front of the alcove or closet must have at least a 72 in<sup>2</sup> (465 cm<sup>2</sup>) unobstructed air opening. Your washer alone does not require a specific air opening.

### Undercounter installation

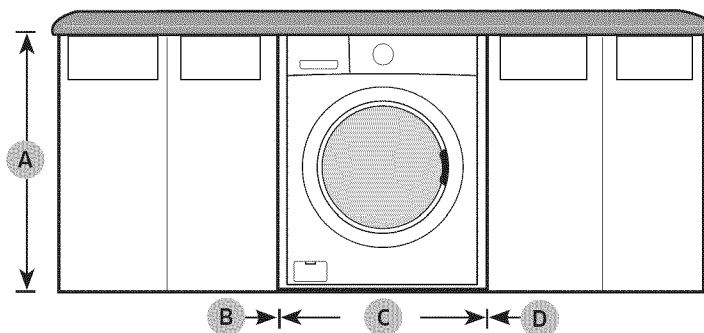

A	39.6 in. (1006 mm)	C	27 in. (686 mm)
B	1 in. (25 mm)	D	1 in. (25 mm)

### Installation on a pedestal

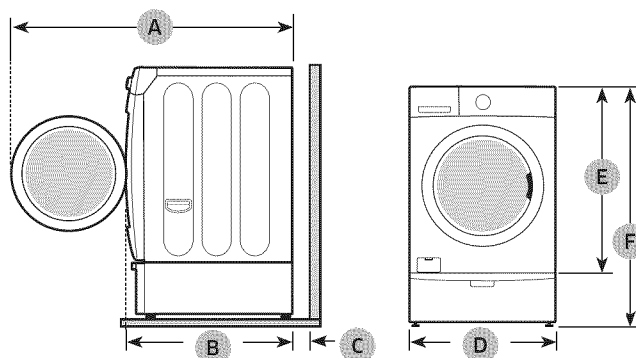

A	54.6 in. (1386 mm)	D	27 in. (686 mm)
B	34 in. (864 mm)	E	38.7 in. (984 mm)
C	5.9 in. (150 mm)	F	53.4 in. (1356 mm)

# Installation

## Side by side installation

Installation

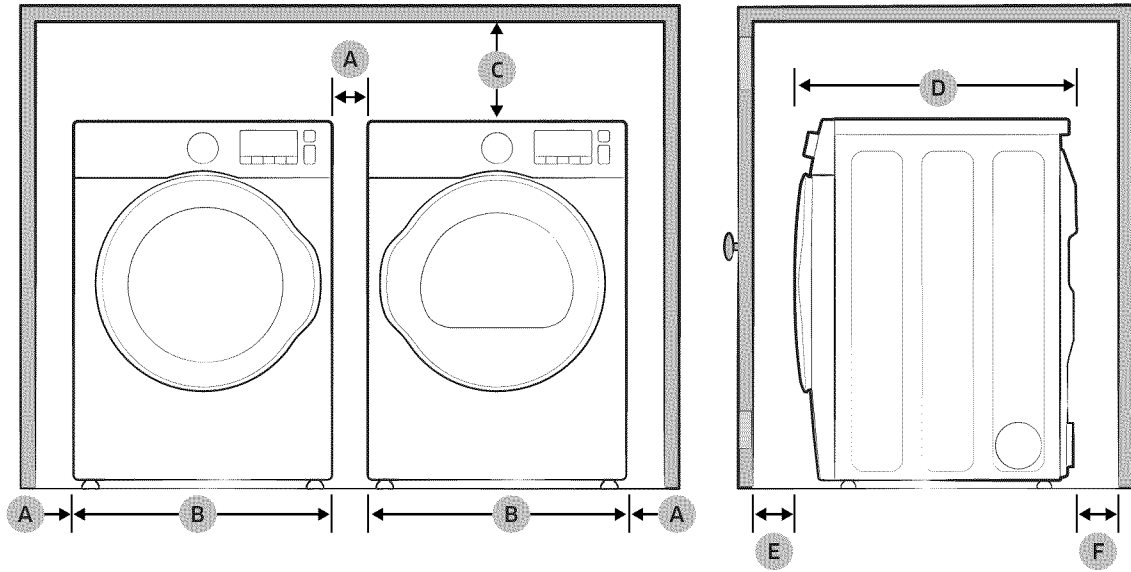

A*	1 in. (25 mm)	D	34 in. (864 mm)
B	27 in. (686 mm)	E	2 in. (50 mm)
C	17 in. (432 mm)	F	5.9 in. (150 mm)

\*This clearance is not applicable to standalone washers.

Stacked installation (Model: SKK-7A)

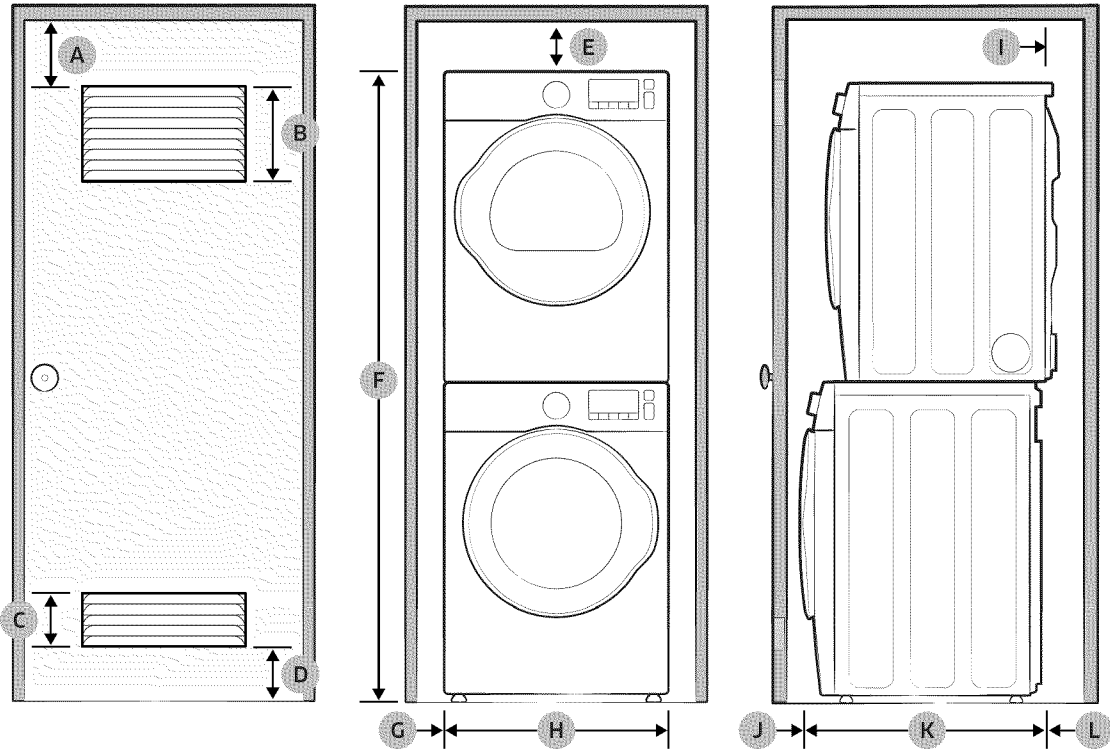

Installation

A	3 in. (76 mm)	G	1 in. (25 mm)
B	48 in <sup>2</sup> . (3100 mm <sup>2</sup> )	H	27 in. (686 mm)
C	24 in <sup>2</sup> . (1550 mm <sup>2</sup> )	I	5 in. (127 mm)
D	3 in. (76 mm)	J	3 in. (76 mm)
E	6 in. (152 mm)	K	34 in. (864 mm)
F	78.5 in. (1994 mm)	L	8 in. (203 mm)

**⚠ WARNING**

- Samsung's washers and dryers can be stacked to maximize usable space.
- The dryer legs need to be removed to stack the washer and dryer. You can purchase an optional stacking kit from your Samsung retailer.

# Installation

## Step-by-step installation

### STEP 1 Select a location

Location requirements:

- A solid, level surface without carpeting or flooring that may obstruct ventilation
- No direct sunlight
- Adequate room for ventilation and wiring
- Ambient temperature always higher than the freezing point (32 °F/0 °C)
- Away from heat sources

### STEP 2 Remove the shipping bolts

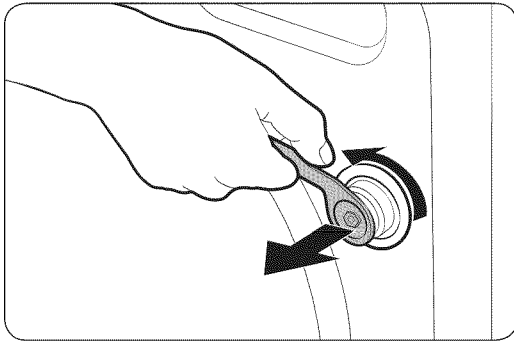

Unpack the product package and remove all shipping bolts.

1. Loosen all shipping bolts on the rear of the machine using the spanner.

**NOTE**

An adjustable wrench or 10 mm open-end wrench is required for removing the shipping bolts.

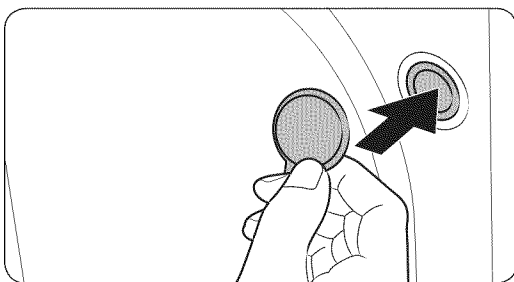

2. Fill the holes with the supplied plastic bolt caps.  
Keep the shipping bolts for future use.

**WARNING**

Packaging materials can be dangerous to children. Dispose all packaging material (plastic bags, polystyrene, etc.) out of children's reach.

### STEP 3 Adjust the levelling feet

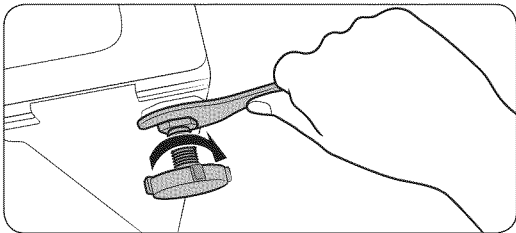
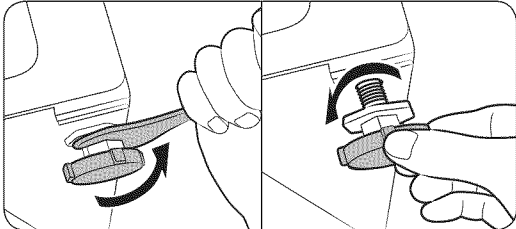

1. Gently slide the washer into position. Excessive force may damage the levelling feet.
2. Level the washer by manually adjusting the levelling feet.
3. When levelling is complete, tighten the nuts using the spanner.

#### NOTE

An adjustable wrench or 17 mm open-end wrench is required to loosen or tighten the leveling feet.

### STEP 4 Connect the water hose

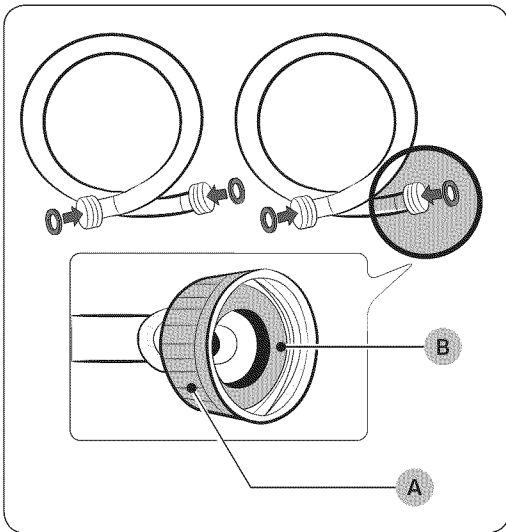

#### CAUTION

- Make sure you use a new water hose, and there are **rubber gaskets (B)** inside the **couplings (A)** at either end of the water hose. A water hose without the gasket may leak.
- If there is a water leak, stop using the washer and contact a local Samsung service center. A water leak may cause electric shock.
- Do not stretch the water hose by force. If the hose is too short, replace the hose with a longer, high-pressure hose.
- To prevent leaks, make sure both water hoses are not bent or kinked. A water leak may cause electric shock.

# Installation

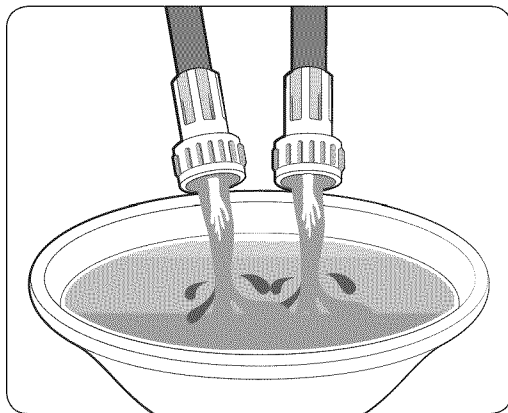
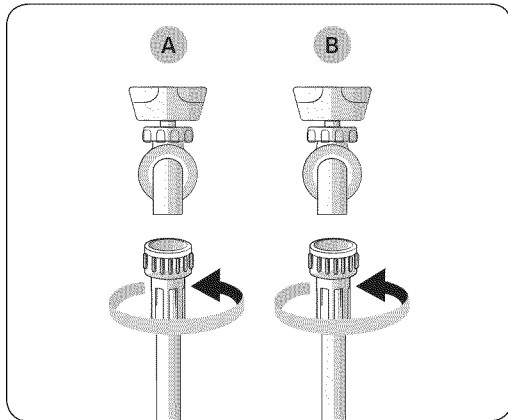

To connect the water hoses to the faucets:

1. Connect one end of each water hose to the **Hot (B)** or **Cold (A)** tap.
2. Turn the fittings by hand until they are tight, and then tighten them by just an additional two-thirds of a turn with a spanner. Do not overtighten the fittings. You can damage them.
3. When done, pull the water hoses up and down to check if they are properly connected.
4. Put the other ends of the hoses into a bucket and open the taps for 10-15 seconds to remove impurities. When done, close the taps.

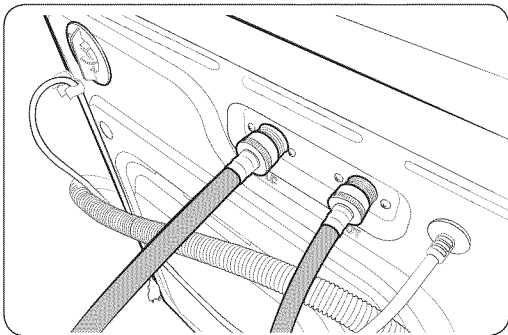
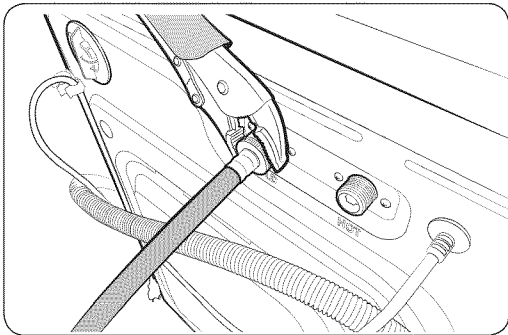
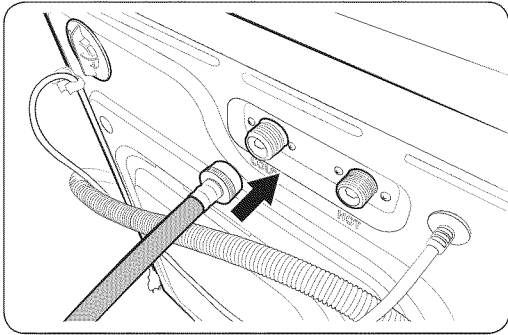

5. Connect the other ends of the water hoses to the corresponding inlets on the rear of the machine as specified. Make sure the hot water hose is connected to the hot inlet, and the cold water hose to the cold inlet.
6. Repeat step 2 above on the other fittings. Make sure both water hoses are connected properly. See the '4C' information code for troubleshooting.
7. Open both faucets, and check if there is a leak.

 **NOTE**

If you do not want to use the hot water hose, insert the inlet cap into the hot water inlet. In this case, you must select Tap Cold for the water temperature. All other water indicators turn off.

 **CAUTION**

To prevent water hoses from being bent or kinked, make sure there is at least a 6 inch (150 mm) space between the washer and the rear wall.

# Installation

## STEP 5 Position the drain hose

The drain hose can be positioned in three ways:

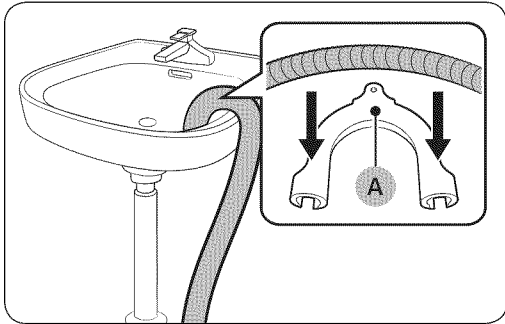

### Over the edge of a wash basin

The drain hose must be placed at a height of between 24 in. (60 cm) and 35 in. (90 cm) from the floor. To keep the spout of the drain hose bent, use the supplied plastic **hose guide (A)**. Secure the guide to the wall using a hook to ensure stable drainage.

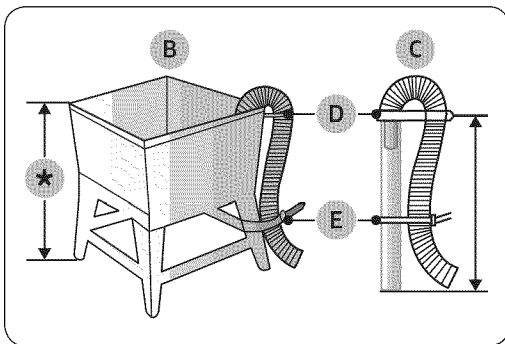

### In a standpipe or laundry tub

The **laundry tub (B)** or **standpipe (C)** must be no shorter than 18 in. (46 cm) and no higher or longer than 96 inches (245 cm). Make sure the drain hose and the standpipe are not airtight.

### NOTE

D: Hose retainer / E: Tie straps

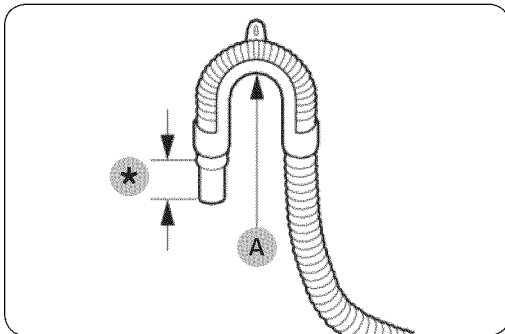

### CAUTION

- Connect the **hose guide (A)** within 6 in. (15 cm)\* of the end of the drain hose. If the drain hose is extended beyond the end of the hose guide, mold or microorganisms could spread inside the washer.
- The drain hose can be installed up to 96 in. (245 cm) high, but the draining capability can be reduced at the maximum height. Water remaining in the drain system may cause an odour.
- If the drain hose is installed less than 18 in. (46 cm) high, water can be drained during the process due to a siphon phenomenon. If this happens, a '4C' information code appears on the display.



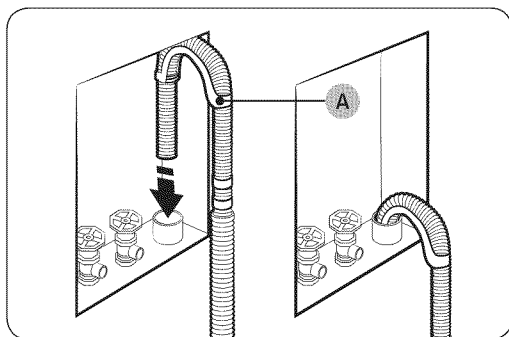

### Wall standpipe drain system

The drain hose must be placed into a wall standpipe drain system. To keep the end of the drain hose bent, use the supplied hose guide (A). Secure the guide to the wall using a hook to ensure stable drainage.

### STEP 6 Power on

Plug the power cord into an AC 120 V / 60 Hz approved electrical outlet protected by a fuse or circuit breaker. Then, press **Power** to turn on the washer.

### STEP 7 STEP 7 Wi-Fi connection using the Smart Home Adapter

You can control the washing machine remotely using the Smart Home Adapter (sold separately), your home network, an Android or iOS smart phone, and the Samsung Smart Home app. To purchase the Smart Home Adapter, visit [www.samsung.com](http://www.samsung.com) and go to the WF45K6200/WF45K6500 product page or search for Smart Home Adapter.

For more information about connecting the washer to your home Wi-Fi network with the Smart Home Adapter, see the Samsung Smart Home section of this manual.

#### CAUTION

- There are two types of Samsung Smart Home Adapters, one that is used with Samsung Smart TVs and one that is used with Samsung home appliances.
- For your washer, you must purchase the Adapter that is restricted to HD39\*1230\*W models (home appliances). Use of any other adapter can cause system failure.

To install the Samsung Smart Home Adapter, follow these steps:

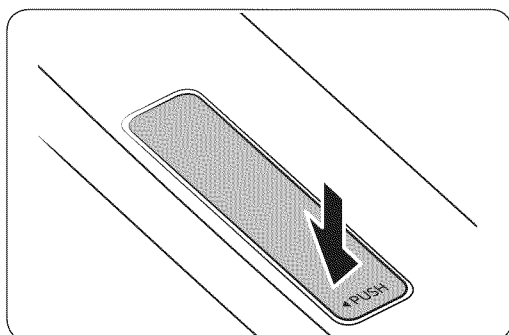

1. To unlock the adapter cover, press the cover to the left of the word PUSH as shown in the illustration.

# Installation

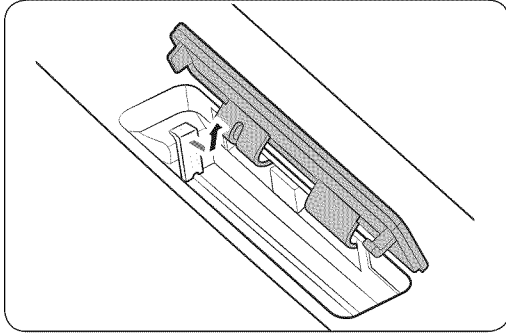

2. Open the adapter cover to reveal the protective cap of the adapter. Gently pull the cap to the right and lift up to remove.

**⚠ CAUTION**

To prevent accidents, keep the protective cap out of children's reach and away from pets.

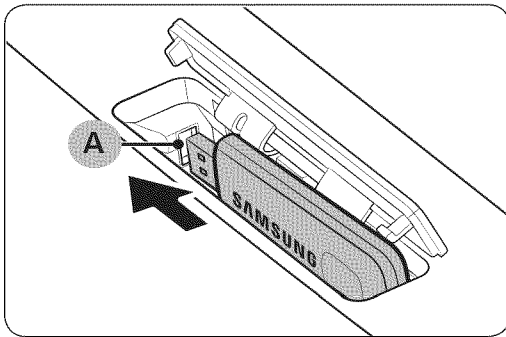

3. Insert the SmartHome Adapter into the **Adapter port (A)** in the correct direction. Make sure the Samsung logo faces forward.

**⚠ CAUTION**

Do not insert other USB devices such as USB memory sticks or USB power cables into the port. Incorrect use of the port may damage the Samsung Smart Adapter, causing system failure.

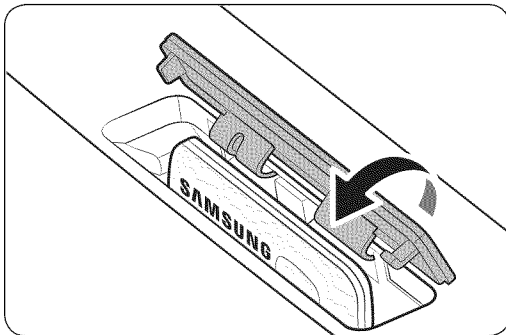

4. Insert the upper area of the adapter cover first, and then press to lock a shown.

**⚠ CAUTION**

To prevent device damage or system failure, keep moisture away from the adapter cover. If the adapter cover gets wet or stained, use a soft cloth or sponge to wipe up the moisture or wipe away the stain, and then dry well.

### Network connection (applicable models only)

You can use the optional SmartHome Adapter (sold separately) to control and monitor your washing machine through the Samsung Smart Home app. For more information about Samsung Smart Home, see the Samsung Smart Home section in this manual.

#### NOTE

- Recommended encryption systems include WPA/TKIP and WPA2/AES. Any newer or non-standard Wi-Fi authentication protocols are not supported.
- Wireless networks may be affected by the surrounding wireless communication environment.
- If your Internet service provider has registered the MAC address of your PC or modem for identification, your Samsung Smart washing machine may fail to connect to the Internet. If this happens, contact your Internet service provider for technical assistance.
- The firewall settings of your network system may prevent your Samsung Smart washing machine from accessing the Internet. Contact your Internet service provider for technical assistance. If this symptom continues, contact a local Samsung service center or retailer.
- To configure the wireless access point (AP) settings, see the user manual of the AP.
- Samsung Smart washing machines featuring the Samsung SmartHome Adapter support both Wi-Fi 2.4 GHz with IEEE 802.11 b/g/n and Soft-AP protocols. (IEEE 802.11 n is recommended.)
- Unauthorized Wi-Fi wireless routers may fail to connect to applicable Samsung Smart washing machines.
- If the washer is installed in a basement or communication with your network is poor, you need to install a Wi-Fi signal booster/repeater or a more powerful router.

# Before you start

## Initial settings

### Run Calibration (recommended)

Calibration ensures accurate weight detection by the washer. Make sure the drum is empty before running Calibration.

1. Press **Power** to turn on the washer.
2. Press and hold **Temp.** and **Delay End** simultaneously for 3 seconds.
3. Press **Start/Pause** to start Calibration.
  - The door is locked during the operation.
  - The drum keeps rotating clockwise and anticlockwise for several minutes.
4. When complete, the washer turns off automatically.

## Laundry guidelines

### STEP 1 Sort

Sort the laundry according to these criteria:

- Care Label: Sort the laundry into cottons, mixed fibres, synthetics, silks, wools, and rayon.
- Color: Separate whites from colors.
- Size: Mixing different sized items together in the drum improves the washing performance.
- Sensitivity: Wash delicate items separately for pure, new woollen items, curtains, and silk items. Check the labels on the items.

#### NOTE

Make sure to check the care label on all clothing, and sort clothing accordingly before starting the wash.

### STEP 2 Empty pockets

Empty all the pockets of your laundry items

- Metal objects such as coins, pins, and buckles on clothing may damage other laundry items as well as the drum.

### Turn clothing with buttons and embroideries inside out

- If pants or jacket zippers are open while washing, the drum may be damaged. Zippers should be closed and fixed with a string.
- Clothing with long strings may become entangled with other clothes. Make sure to tie the strings before starting the wash.

### STEP 3 Use a laundry net

- Brassieres (water washable) must be placed in a laundry net. Metal parts of the brassieres may break through and tear other laundry items.
- Small, light clothing such as socks, gloves, stockings, and handkerchiefs may become caught around the door. Place them inside a fine laundry net.
- Do not wash the laundry net by itself without other laundry. This may cause abnormal vibrations that could move the washer and result in injury.

#### **STEP 4 Prewash (if necessary)**

Select the Prewash option for the selected cycle if the laundry is heavily soiled. Do not use the Prewash option if you will be adding detergent manually to the drum.

#### **STEP 5 Determine the load capacity**

Do not overload the washer. Overloading may cause the washer to wash improperly.

#### **NOTE**

When washing bedding or bedding covers, the wash time may be lengthened or the spin efficiency may be reduced. For bedding or bedding covers, the recommended maximum spin cycle speed is 800 rpm, and the load capacity is 2.0 kg or less.

#### **CAUTION**

If the laundry is unbalanced and the “Ub” information code is displayed, redistribute the load. Unbalanced laundry may reduce the spinning performance.

#### **STEP 6 Add the correct detergent type**

The type of detergent depends on the type of fabric (cotton, synthetic, delicate items, wool), color, wash temperature, and degree of soiling. Always use “low suds” HE laundry detergent which is designed for automatic washers.

#### **NOTE**

- Follow the detergent manufacturer’s recommendations based on the weight of the laundry, the degree of soiling, and the hardness of the water in your local area. If you are not sure about the water hardness, contact a local water authority.

- Do not use detergent that tends to be hardened or solidified. This detergent may remain after the rinse cycle, blocking the drain outlet.

#### **CAUTION**

When washing wool using the WOOL, use only a neutral liquid detergent. If used with WOOL, powder detergent may remain on the laundry and discolor the laundry.

Use HE detergent only



Your washer is designed to use high efficiency (HE) detergents.

- For the best cleaning results, use a high efficiency detergent such as Tide HE, Wisk HE, Cheer HE or Gain HE\*. High efficiency detergents contain suds suppressors that reduce or eliminate suds. When fewer suds are produced, the load tumbles more efficiently and cleaning is maximized. (\* Brand names are trademarks of their respective manufacturers.)

#### **WARNING**

Regular detergent is not recommended. Use HE detergents only.

Before you start

# Before you start

## Detergent drawer guidelines

The washer provides a four-compartment dispenser: the front-left compartment for the main wash, the rear-left for pre-wash, the front-right for fabric softeners, and the rear-right for the liquid chlorine bleach.

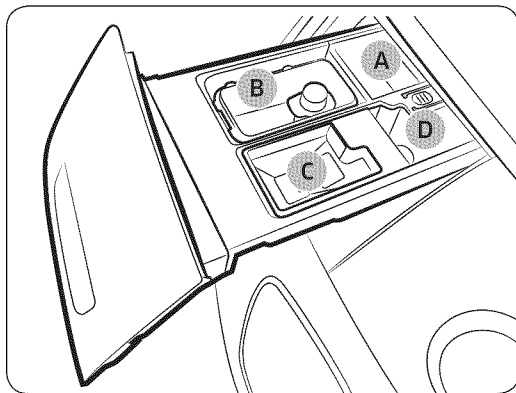

1. **Prewash compartment(A):** Add prewash detergent or starch.
2. **Main-wash compartment(B):** Add main-wash detergent, water softener, soaking detergent, color-safe, non-chlorine bleach, and/or stain removers.
3. **Softener compartment(C):** Add fabric softener. Do not exceed the **max line**.
4. **Bleach compartment(D):** Add liquid chlorine bleach. Do not exceed the **max line**.

### ⚠ CAUTION

- Do not open the detergent drawer while the washer is operating.
- Do not use the following types of detergent:
  - Tablet or capsule types
  - Ball or net types
- To prevent the compartment from clogging, concentrated or highly-enriched agents (fabric softener or detergent) must be diluted with water before being added.

## To add washing agents to the detergent drawer

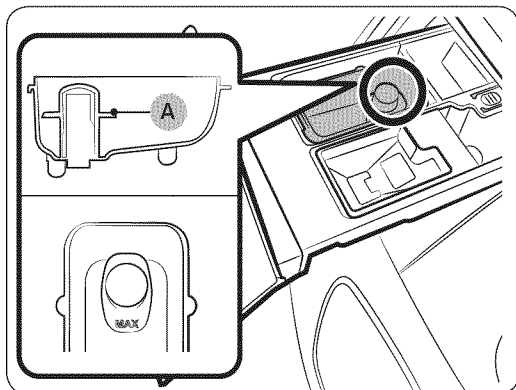

### Adding liquid detergent

1. Slide open the detergent drawer.
2. Add the liquid laundry detergent to the liquid detergent container in the mainwash compartment. Make sure that the detergent does not exceed the marked max line (A).

### 📄 NOTE

- Do not add powdered laundry detergent or other powdered laundry agents to the liquid laundry container.
- To use powdered detergent, see page 29.

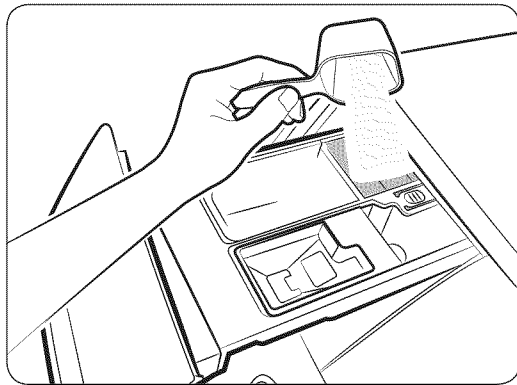
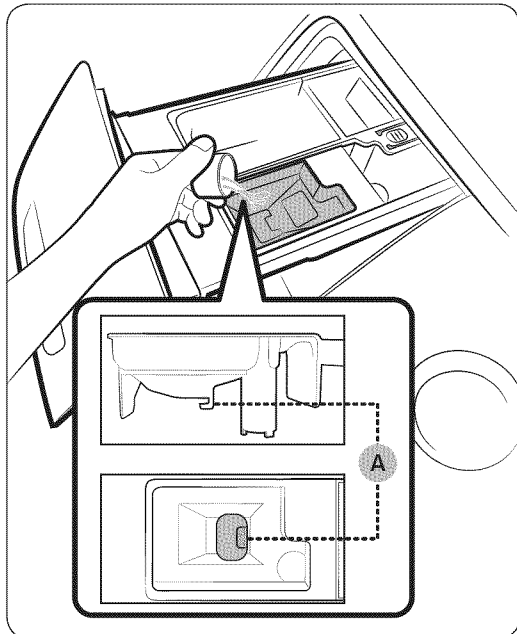

3. Add fabric softener to the **softener compartment**. Do not exceed the **max line (A)**.

**⚠ CAUTION**

- Powdered fabric softener is not recommended. Use liquid fabric softener only.
- Concentrated fabric softener must be diluted with water before being added.
- Do not add main-wash detergent to the **softener compartment**.

4. If you want to prewash, add prewash detergent to the prewash compartment as instructed or recommended by the manufacturer.

**📖 NOTE**

If you use a high efficiency (HE) detergent, apply 1/3 of the recommended amount to the prewash compartment and 2/3 of the recommended amount to the main-wash compartment.

5. Close the detergent drawer.

# Before you start

## To use powdered detergent

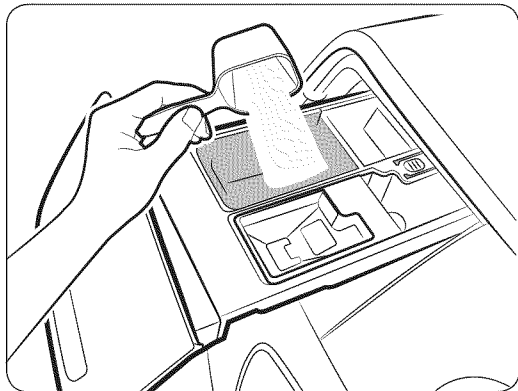

First, remove the provided liquid detergent container from the main-wash compartment. Then, add powdered detergent to the main-wash compartment according to the detergent manufacturer's instructions.

### ⚠ CAUTION

Do not add powdered detergent to the liquid detergent container.

## To use the bleach compartment

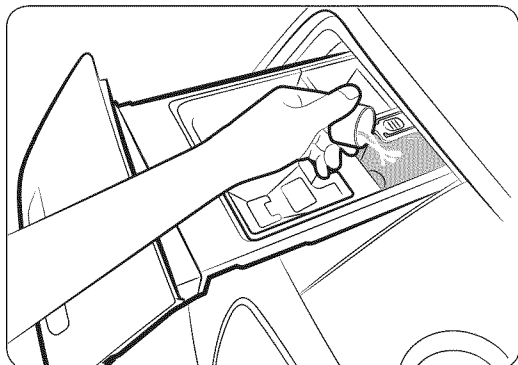

Add only liquid chlorine bleach to the **bleach compartment**. Do not exceed the **max line**.

### ⚠ CAUTION

Do not add undiluted liquid chlorine bleach directly to the load or to the drum. It is a powerful chemical and can cause fabric damage, such as weakening of the fibers or color loss if not use properly.

## To use oxigen boosters or color-safe bleach

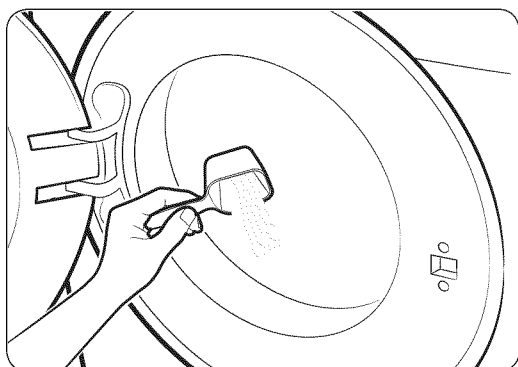

Oxygen boosters or color-safe bleach can increase washing performance. Make sure to add the oxygen booster or color-safe bleach after putting the laundry into the drum.

### 📖 NOTE

To use both powder detergent and powder oxygen booster or powder color-safe bleach, it is more effective to put them together into the drum before loading the laundry.



# Operations

## ⚠ WARNING

To reduce the risk of fire, electric shock, or injury to persons, read the IMPORTANT SAFETY INSTRUCTIONS before operating this appliance.

## Feature panel

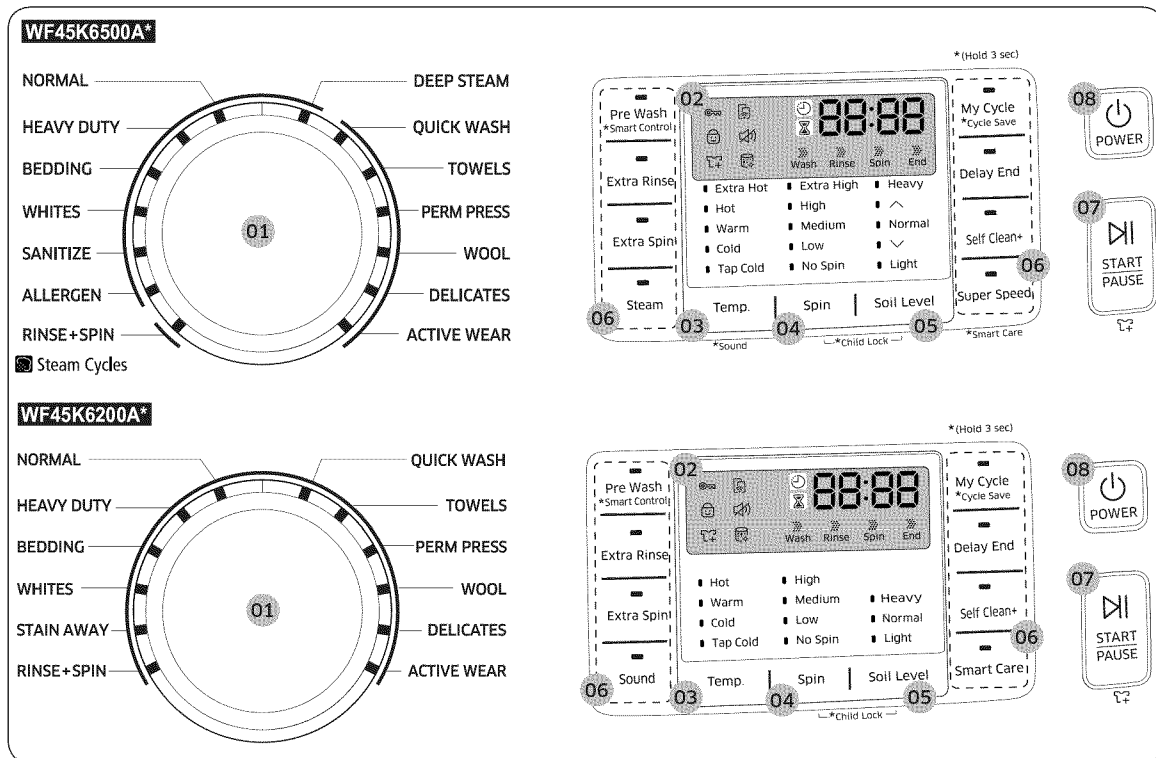

<b>01 Cycle Selector</b>	Turn the dial to select a cycle.
<b>02 Display</b>	The display shows current cycle information and estimated time remaining, or an information code when a problem occurs.
<b>03 Temp.</b>	Press to change the water temperature for the current cycle. <ul style="list-style-type: none"> <li>• <b>Extra Hot:</b> Heavily soiled, colorfast items. Only available with NORMAL, HEAVY DUTY, and SANITIZE. (only for WF45K6500A* model)</li> <li>• <b>Hot:</b> Whites and heavily soiled, colorfast items.</li> <li>• <b>Warm:</b> Colorfast items.</li> <li>• <b>Cold:</b> Brightly colored, very lightly soiled items. The washer supplies additional hot water or uses the heater to warm up the water if it is below 60 °F (16 °C)</li> <li>• <b>Tap Cold:</b> Uses only cold water without using the heater. No warm water is supplied.</li> </ul>

Operations

# Operations

<p><b>04 Spin</b></p>	<p>Press to change the spinning speed for the current cycle.</p> <ul style="list-style-type: none"> <li>• <b>Extra High:</b> Extends the spinning process to effectively remove moisture from the load. (only for WF45K6500A* model)</li> </ul> <p><b>NOTE</b> Extra High uses a stronger spinning process to remove moisture, so it is not suitable for wrinkle-free or no-iron fabrics, or overloads.</p> <ul style="list-style-type: none"> <li>• <b>High:</b> Underwear, t-shirts, jeans and sturdy cottons.</li> <li>• <b>Medium:</b> Jeans, wrinkle-free or wash-and-wear items and synthetics.</li> <li>• <b>Low:</b> Delicate items that requires a lower spinning speed.</li> <li>• <b>No Spin:</b> The drum does not spin after the final drain process.</li> <li>• <b>Rinse Hold (No lamp turns on):</b> The final rinse process is suspended so that the laundry remains in the water. To unload the laundry, run a drain or spin process.</li> </ul> <p><b>NOTE</b> <b>Spin Only:</b> This cycle runs a spin cycle only. Press and hold <b>Spin</b> for 3 seconds. With the cycle time on the display, press <b>Spin</b> repeatedly until a desired spinning speed is selected. Then, press <b>Start/Pause</b> to start the cycle. This cycle is available only when no specific cycle is selected</p>
<p><b>05 Soil Level</b></p>	<p>Press the button to select the soil level/washing time.</p> <ul style="list-style-type: none"> <li>• <b>Heavy:</b> For heavily soiled loads.</li> <li>• ▲ (only for WF45K6500A* model)</li> <li>• <b>Normal:</b> For moderately soiled loads. This setting is best for most loads.</li> <li>• ▼ (only for WF45K6500A* model)</li> <li>• <b>Light:</b> For lightly soiled loads.</li> </ul>
<p><b>06 Options</b></p>	<p>Press the buttons to select different cycle options.</p>
<p><b>07 Start/ Pause</b></p>	<p>Press to start or stop operation.</p>
<p><b>08 Power</b></p>	<p>Press to turn on/off the washer.</p>

## Simple steps to start

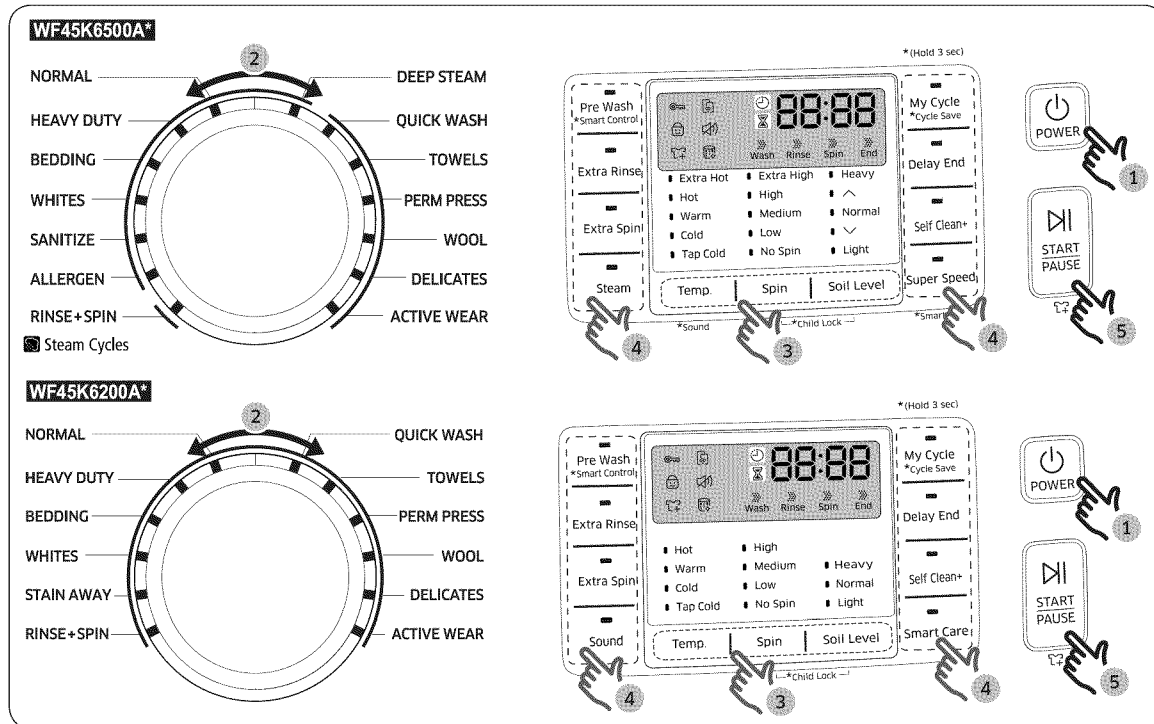

1. Press **Power** to turn on the washer.
2. Turn the **Cycle Selector** to select a cycle.
3. Change the cycle settings (**Temp.**, **Spin**, and **Soil Level**) as necessary.
4. Select desired options as necessary.
5. Press **Start/Pause**.

### To change the cycle during operation

1. Press **Start/Pause** to stop operation.
2. Select a different cycle.
3. Press **Start/Pause** again to start the new cycle.

### **⚠ WARNING**

Do not place anything on top of your washer while it is running.

# Operations

## Cycle overview

### Standard cycles

Cycle	Description
NORMAL	<ul style="list-style-type: none"> <li>For most fabrics including cottons, linens, and normally soiled items.</li> </ul>
HEAVY DUTY	<ul style="list-style-type: none"> <li>For sturdy, colorfast fabrics and heavily soiled items.</li> </ul>
BEDDING	<ul style="list-style-type: none"> <li>For bulky items such as comforters, blankets, and sheets.</li> <li>For best results, wash only 1 type of bedding.</li> <li>For bulky items, use liquid detergent and do not roll the items when you place them in the drum because they might get stuck.</li> </ul>
WHITES	<ul style="list-style-type: none"> <li>For white items with or without bleach.</li> </ul>
SANITIZE	<ul style="list-style-type: none"> <li>For heavily soiled, colorfast items. This cycle heats the water to 150 °F to eliminate bacteria. (only for WF45K6500A* model)</li> </ul> <p> <b>NOTE</b> If you press <b>Start/Pause</b> during the heating portion of Sanitize cycle, your washer door will remain locked for your safety.</p>
ALLERGEN	<ul style="list-style-type: none"> <li>This cycle removes dust mites, pet dander, and other allergy causing substances from fabric. (only for WF45K6500A* model)</li> </ul>
STAIN AWAY	<ul style="list-style-type: none"> <li>For stained clothes. This cycle provides outstanding stain removal performance. For Best stain removal performance, use hot temperature option in this cycle.(only for WF45K6200A* model)</li> </ul>
RINSE+SPIN	<ul style="list-style-type: none"> <li>Use for loads that need rinsing only or to add rinse-aided fabric softener to a load.</li> </ul>
DEEP STEAM	<ul style="list-style-type: none"> <li>For heavily soiled, colorfast items. This cycle uses steam and a high water temperature to effectively remove stains. (only for WF45K6500A* model)</li> </ul>
QUICK WASH	<ul style="list-style-type: none"> <li>For lightly soiled items needed quickly.</li> </ul>
TOWELS	<ul style="list-style-type: none"> <li>For bath towels, washcloths, and mats.</li> </ul>
PERM PRESS	<ul style="list-style-type: none"> <li>For wash-and-wear, synthetic fabrics, and lightly to normally soiled items.</li> </ul>

Cycle	Description
<b>WOOL</b>	<ul style="list-style-type: none"> <li>For machine-washable wool. Loads should be under 8 pounds. For best results, we recommend a load of 4.4 pounds or less.</li> <li>The Wool cycle washes laundry by moving the wash drum horizontally to maintain the characteristics of the wool fibers and to prevent damage to the cloth. It then stops for a period of time to allow the laundry to soak in the water after which it re-starts.</li> <li>We recommend you use a neutral detergent to prevent damage to the cloth and to improve the washing results.</li> </ul>
<b>DELICATES</b>	<ul style="list-style-type: none"> <li>For sheer fabrics, bras, lingerie (silk), and other handwash-only fabrics.</li> <li>For best performance, use liquid detergent.</li> </ul>
<b>ACTIVE WEAR</b>	<ul style="list-style-type: none"> <li>Use this cycle to wash exercise wear such as sports jerseys, training pants, shirts/tops and other performance clothing. This cycle provides effective soil removal with gentle action for special fabric care.</li> </ul>

### Options

Option	Description
<b>Pre Wash</b>	<ul style="list-style-type: none"> <li>This option adds a preliminary washing process before the main wash cycle.               <ol style="list-style-type: none"> <li>Add detergent to the pre-wash section of the detergent compartment.</li> <li>Turn the Pre Wash option on. The washer fills with cold water and detergent, tumbles, then drains and advances to the selected wash cycle.</li> </ol> </li> </ul> <p><b>NOTE</b> This option is not available with some cycles.</p>
<b>Extra Rinse</b>	<ul style="list-style-type: none"> <li>Adds an additional rinse at the end of the cycle to remove laundry additives more thoroughly.</li> </ul>
<b>Extra Spin</b>	<ul style="list-style-type: none"> <li>Adds additional spin time to remove more water from loads.</li> </ul>

# Operations

Option	Description
Steam	<ul style="list-style-type: none"> <li>Press this button to use the Steam function. Steam is available with the NORMAL, HEAVY DUTY, BEDDING, WHITES, SANITIZE, DEEP STEAM and ALLERGEN. For heavily soiled, colorfast items, the Steam function improves stain treatment and uses less water. (only for WF45K6500A* model)</li> </ul>
Sound	<ul style="list-style-type: none"> <li>When you activate Sound off function, the “” lamp illuminates.</li> </ul>
My Cycle	<ul style="list-style-type: none"> <li>Create your own washing cycle with preferred settings and use the cycle with a single button push.</li> </ul>
Delay End	<ul style="list-style-type: none"> <li>Set the washer to finish your wash automatically at a later time. Choose a delay of between 1 to 24 hours (in 1 hour increments).</li> </ul>
Self Clean+	<ul style="list-style-type: none"> <li>Cleans the drum by removing dirt and bacteria from the drum.</li> <li>Perform once every 40 washes with no detergent or bleach added.</li> <li>Make sure the drum is empty.</li> <li>Do not add any drum cleaning agents.</li> </ul>
Super Speed	<ul style="list-style-type: none"> <li>Press this button if you need to shorten the washing time, applicable for NORMAL, DEEP STEAM, HEAVY DUTY, BEDDING or ALLERGEN. The shortened time may differ depending on the selected cycle/load/options. (only for WF45K6500A* model)</li> </ul>
Smart care	<ul style="list-style-type: none"> <li>This function enables you to check the status of the washing machine using a smartphone.</li> </ul>
Smart Control	<ul style="list-style-type: none"> <li>After you have inserted the Smart Home Adapter and connected the washer to your home network using the Samsung Smart Home app, you can control the washer remotely. To begin, press and hold <b>Smart Control</b> for 3 seconds. The Smart Control indicator blinks and the door locks. The washer enters the waiting for remote commands mode. For more information, visit the Samsung Smart Home website.</li> </ul>

---

## Samsung Smart Home (applicable models only)

---

### Installation

Visit the Google Play Store, Galaxy Apps, or Apple App Store and search for “Samsung Smart Home”. Download and install the Samsung Smart Home app provided by Samsung Electronics to your smart device.

#### NOTE

- The Samsung Smart Home app is designed for Android 4.0 (ICS) or higher, or iOS 7.0 or higher, and is optimized for Samsung smartphones (Galaxy S and Galaxy Note series). On other smartphone models, some functions may operate differently.
- For improved performance, the Samsung Smart Home app is subject to change without notice.

### Samsung account

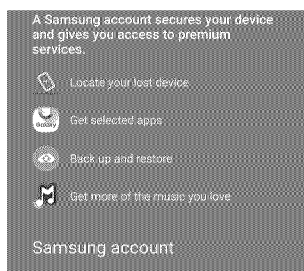

Android

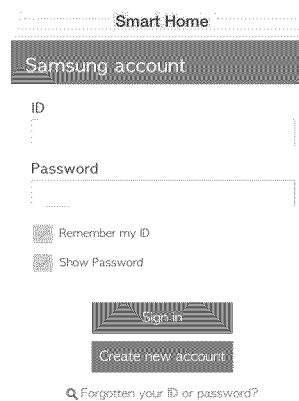

iOS

You are required to register your Samsung account to use the app. If you don't have a Samsung account, follow the app's onscreen instructions to create a free Samsung account.

### Getting started

1. Turn on your Washer.
2. Insert the SmartHome Adapter into the cSmart Home Adapter port of your washing machine.
3. Run the Samsung Smart Home app and log in with your Samsung account. iPhone users are required to provide the login information each time they access the app.

# Operations

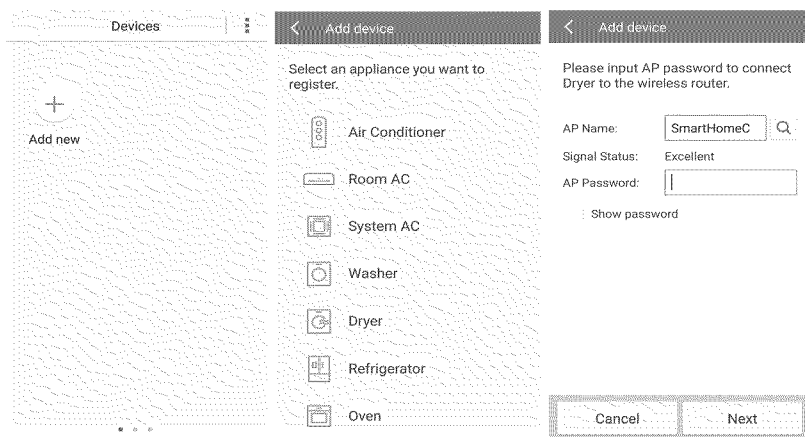

4. Access **Device** > the plus (+) icon, and then tap Washing Machine.
5. Follow the onscreen instructions to provide the necessary information about the router, and then tap **Next**.

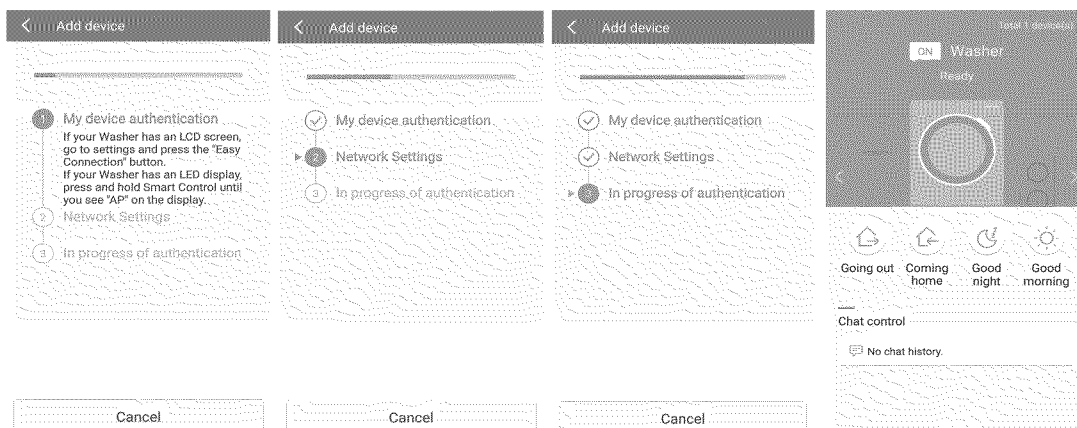

6. Press and hold **Smart Control** on the washer for more than 5 seconds until the “**AP**” message appears on the display. Your washing machine is registered with the app.
7. Once your Washer is registered properly, the App will show this message. Please complete the setup by restarting your washer. You may then remotely control your washer by turning on Smart Control.
  - ✗ The remote control function is only available with Washer.
8. When the device registration is complete, the washing machine icon will appear in the Samsung Smart Home app.
9. When “oAP” message disappears on the display, restart your washing machine.
10. Press and hold Smart Control on the washer for more than 3 seconds, and then the Smart Control indicator  Lights up on your washing machine.



---

 **NOTE**

- Some options or settings of the washing machine may not be available for remote control.
- The App view may differ for each mobile device.
- If you operate the button in the Set view after connecting to Smart Home, it will disconnect from Smart Home.
- For safety reasons, Smart Control will be disabled if the Child Lock is activated. To use Smart Control, make sure you deactivate the Child Lock first.
- If you stop the operation of the washing machine through the Smart Home App, the door of the washing machine stays locked for safety reasons. To open the door, press Start/Pause on the control panel.



This product is a smart washing machine that supports the Samsung Smart Home service.

For more information, visit [www.samsung.com](http://www.samsung.com).

The EZ setup(network setting) takes time depending on your network condition

# Operations

## Key features

You can register Samsung Smart Home appliances on the Samsung Smart Home server for remote access.

Menu overview

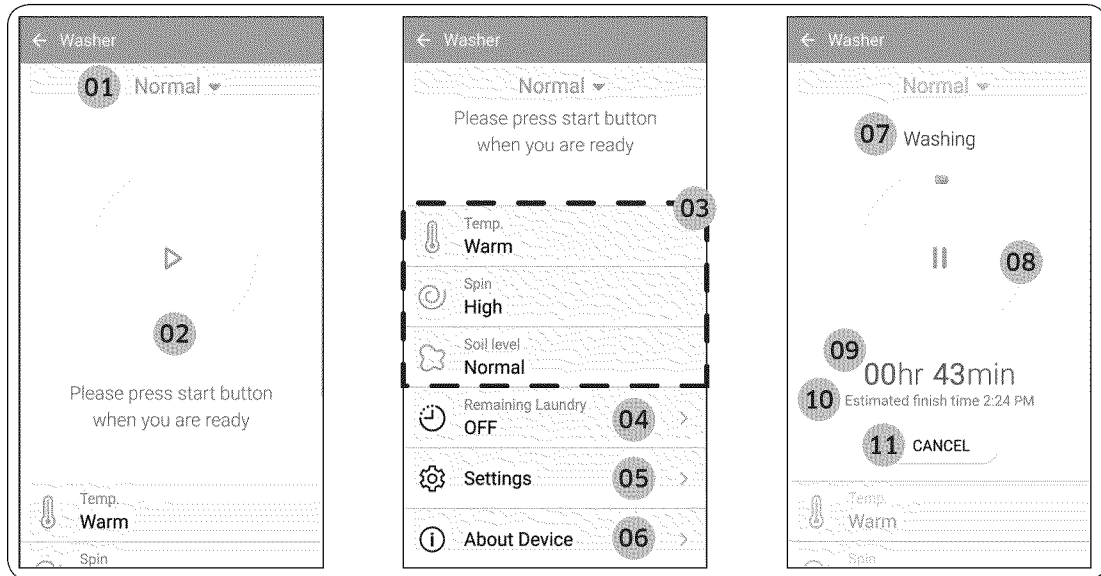

For improved performance, the content and design of the app is subject to change without notice.

<b>01 Current cycle</b>	Tap to select a desired cycle.
<b>02 Start/Pause</b>	With Smart Control enabled on the washing machine, you can start an operation or pause an operation remotely.
<b>03 Options</b>	You can set or adjust options remotely. Option default values and available setting values differ depending on the selected cycle.
<b>04 Remaining Laundry (applicable models only)</b>	If the washing machine has laundry remaining in the drum after a cycle has finished, this function can notify you that laundry remains in the drum. To use, tap the Remaining Laundry icon to turn the function on, and then specify a notification interval. The function stays active for up to 12 hours. If you open the washer door, the function is terminated and the machine turns off.
<b>05 Settings</b>	The Settings menu differs by model and is not available for all models.

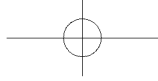

<b>06 About Device</b>	<ul style="list-style-type: none"> <li>Version: Displays the current version of the Washing Machine app.</li> <li>Self check (applicable models only): The washing machine runs a self-diagnosis and displays an information code if it finds an issue to check</li> </ul>
<b>07 Current Process</b>	The current process - Washing, Rinsing, etc. - is displayed.
<b>08 Progress</b>	The progress of the selected cycle is displayed in 1% increments.
<b>09 Remaining Time</b>	The time remaining for the selected cycle is displayed.
<b>10 Estimated Finish Time</b>	The estimated finish time is displayed
<b>11 Cancel</b>	Tap to cancel the current cycle and return to the cycle selection screen.

When the cycle is complete:

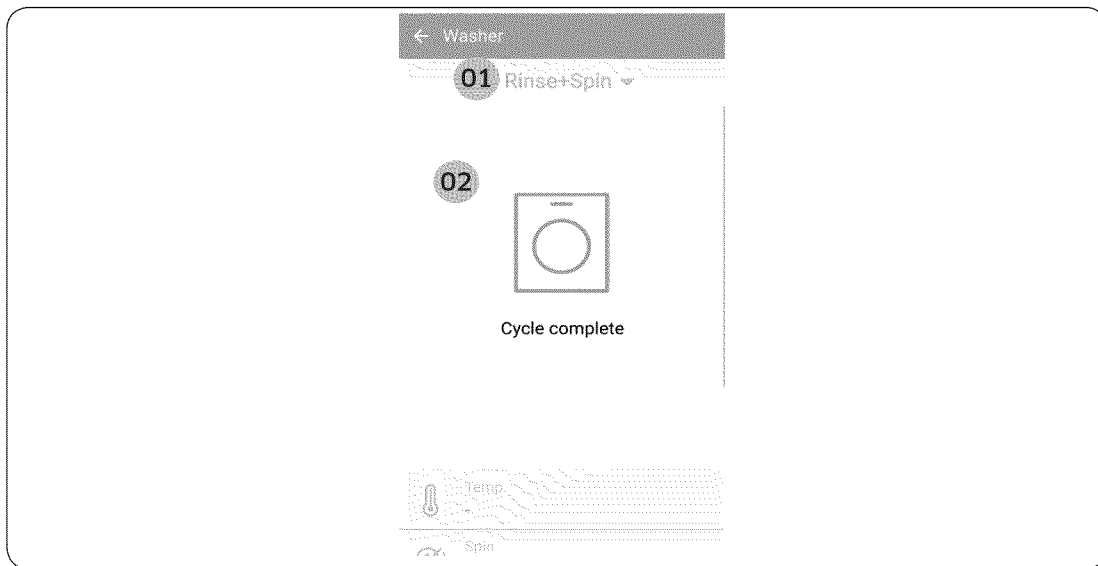

<b>01 Finished Cycle</b>	Displays the cycle that has completed.
<b>02 Completion Message</b>	When the cycle is complete, the Washer app displays a completion message.

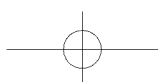
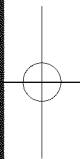
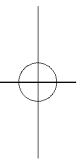

# Operations

## Add wash alarm function

If you have forgotten some clothes or you want to add special softener, the add wash alarm reminds you to add any laundry or softener after your wash has already started.

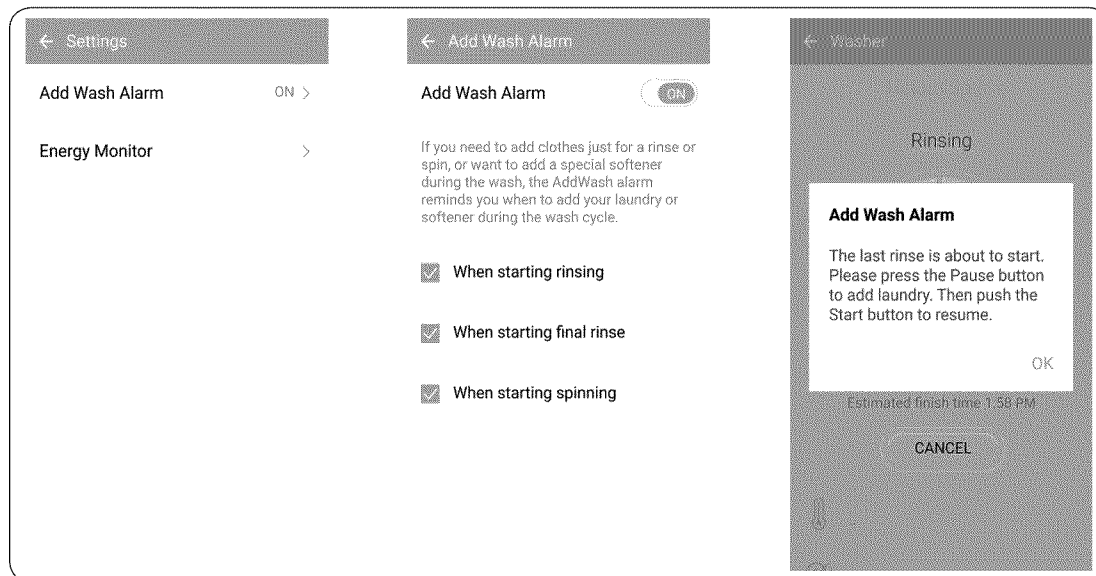

During the wash, the function sounds an alarm 3 times:

- 2-3 minutes before the first rinsin
- 2-4 minutes before the last rinsing
- 1-2 minutes before the spinning

## Delay End

You can set the washer to finish your wash automatically at a later time by choosing a delay of between 1 to 24 hours (in 1 hour increments). The hour displayed indicates the time the wash will finish.

1. Select a cycle. Then, change the cycle settings if necessary.
2. Press **Delay End** repeatedly until a desired end time is set.
3. Press **Start/Pause**.  
The  indicator turns on with the clock running.
4. To cancel **Delay End**, restart the washer by pressing **Power**.

### Real-life case

You want to finish a two-hour cycle 3 hours from now. To do this, you add the Delay End option to the current cycle with a 3-hour setting, and then press **Start/Pause** at 2:00 p.m. The washer starts operating at 3:00 p.m. and ends at 5:00 p.m. Provided below is the time line for this example.

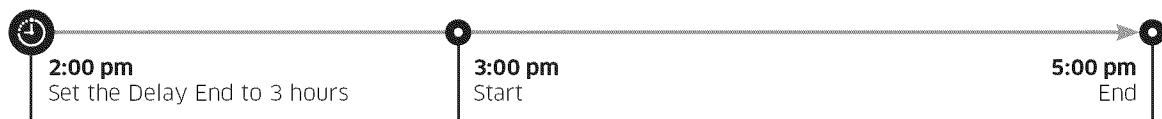

## Steam (only for WF45K6500A\* model)

With the Steam cycle, the washer senses the weight of the load and controls the steam effect according to the load size. This improves washing performance. Available Steam cycles are: NORMAL, HEAVY DUTY, BEDDING, WHITES, SANITIZE, ALLERGEN, and DEEP STEAM.

1. Turn the **Cycle Selector** to select a Steam cycle.
2. Press **Steam**.
3. Add detergent and fabric softener as instructed.
4. Press **Start/Pause** to start the cycle.

### NOTE

- Steam may not be visible or present during the cycle. This is normal.
- Unlike other Steam cycles, you don't need to press Steam for DEEP STEAM as the Steam function turns on automatically.

# Operations

## Special features

### Add Wash

When the Add Wash indicator  turns on, you can stop the washer and put additional laundry into the drum. The Add Door opens by more than 100° for easy access.

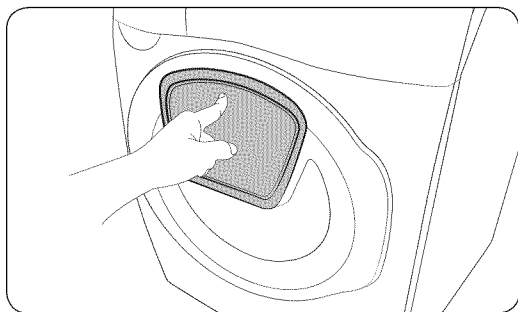

1. Press **Start/Pause** to stop operation.
2. Press the upper area of the Add Door to unlock.

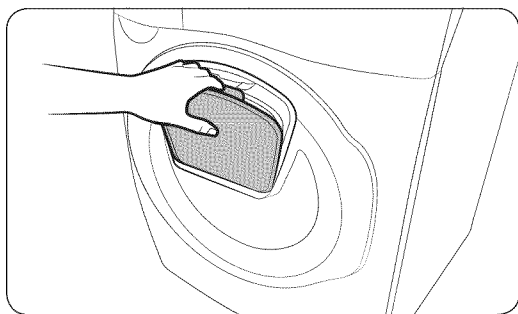

3. Open the Add Door and insert additional laundry into the drum.
4. Lift the Add Door back into place, and then push it gently until you hear a click. The Add Door is locked.
5. Press **Start/Pause** to resume operation.

### NOTE

- The water inside the drum does not leak if the Add Door is closed properly. Water drops may form around the window, but they do not leak from inside the drum.
- After washing is complete, open the Add Door and leave open for some time to dry the drum.

### CAUTION

- Do not open the Add Door if suds have formed inside the drum.
- Do not open or touch the Add Door while the machine is operating. The Add Door may be opened unintentionally.
- Do not add an excessive amount of laundry through the Add Door. Performance may be degraded.
- Do not use the lower area of the Add Door as a handle. Your fingers may be caught.
- Make sure that no laundry is caught in the Add Door.
- Keep your pets out of the washer, especially the Add Door.
- Do not open the Add Door while the drying or Steam or Sanitize functions are running. Hot steam may leak out of the window.

- Do not press or push the Add Door when closing the washer door. The Add Door may open.

## Child Lock

To prevent accidents by children or infants, Child Lock locks all buttons except for the **Power** button.

### To activate the Child Lock

- Press and hold both **Soil Level** and **Spin** for 3 seconds. Then, press **Start/Pause** to activate. The door locks and the Child Lock indicator turns on.

### To deactivate the Child Lock temporarily

- You can deactivate the Child Lock temporarily for 1 minute. To do this, Press and hold both **Soil Level** and **Spin** for 3 seconds. The door is unlocked for 1 minute and the Child Lock indicator blinks.

### NOTE

- If you open the door 1 minute or more after deactivating Child Lock, an alarm sounds for up to 2 minutes.
- If you close the door within 2 minutes, door locks and Child Lock is reactivated. After 2 minutes, the door does not lock with no alarm sound.
- To add laundry after activating Child Lock, first deactivate Child Lock or restart the washer.

### To cancel the Child Lock

- Press and hold both **Soil Level** and **Spin** for 6 seconds. The door unlocks and the Child Lock the Child Lock indicator turns off.

## My Cycle

Create your own washing cycle with preferred settings and use the with the push of the push of a single button.

### To create your own cycle

1. Turn the **Cycle Selector** to select a cycle.
2. Change the cycle settings (**Temp.**, **Spin**, and **Soil Level**) as necessary.
3. To add an option, press the corresponding buttons.
4. Press and hold **My Cycle** for 3 seconds to save your settings. Applicable indicators blink for 3 seconds.

Once you save the cycle, you can use it by pressing My Cycle.

### NOTE

If you press **My Cycle** and then release it within 3 seconds, the previously saved cycle and options appear.

# Operations

---

## Sound (only for WF45K6500A\* model)

Mute or unmute the sound (button beeps, indicator beeps and chimes, etc.)

- To mute or unmute the sound, press and hold the **Temp.** button for 3 seconds. When the sound is muted, the  indicator turns on.

## ATC (Auto Temperature Control)

ATC enables the washer to control water temperatures in each washing cycle using the washer's internal thermistor. It is designed to maintain certain washing temperatures for best results.

### NOTE

- If you select NORMAL or HEAVY DUTY, you may notice the washer supplying cold water. This is normal because the machine is designed to reduce power consumption.
- In these cycles, the Hot temperature is similar to bath-water temperatures, and the Warm temperature to comfortable swimming pool temperatures.
- To wash clothes at a specific temperature, you must choose a different cycle first.



# Maintenance

---

Keep the washer clean to prevent its performance from deteriorating and to preserve its life cycle.

## Self Clean+

---

Perform this cycle regularly to clean the drum and to remove bacteria from it.

1. Make sure the drum is empty.
2. Press **Power** to turn on the washer.
3. Press **Self Clean+**.
4. Press **Start/Pause**.

### NOTE

- The water temperature for Self Clean+ is set to EXTRA HOT, which cannot be changed. (only for WF45K6500A\* model)
- The water temperature for Self Clean+ is set to HOT, which cannot be changed. (only for WF45K6200A\* model)

### CAUTION

Do not use any cleaning agents. Do not add detergent or bleach. Chemical residue in the drum degrades the cleaning performance.

### Self Clean+ reminder

- The **Self Clean+** reminder appears on the main screen once every 40 washes. It is advisable to perform the **Self Clean+** regularly.
- If you do not run the cycle within 1 hour when the Self Clean+ reminder appears, the reminder turns off automatically.
- When you first see this reminder, you can ignore the reminder for 6 consecutive washes. From the 7<sup>th</sup> wash, the reminder no longer appears. However, it appears again on the second 40<sup>th</sup> wash.

# Maintenance

## Smart Care

The Smart Care function helps you diagnose and troubleshoot your washer if it has a problem. To enable this function, you must first download the Samsung Smart Washer app from the Play Store or the Apple Store, and install it on a mobile device that has a camera. The Smart Washer Smart Care function has been optimized for:

Galaxy and iPhone series devices. (It is not supported by some models.)

As the washer operates, it runs its self-diagnosis function in the background. If it senses a problem, it displays an information code on the display which you can scan using the app's Smart Care function. The Smart Care function will then display detailed information about the code.

1. To enable the **Smart Care** function.
  - Press and hold **Super Speed** on the washer for 3 seconds to enter the Smart Care mode. (only for WF45K6500A\* model)
  - Press **Smart Care** button to enter the Smart Care mode. (only for WF45K6200A\* model)
2. Run the Samsung Smart Washer app on your mobile device, and then tap **Smart Care**.
3. Hold the mobile device so that the mobile device and the washer's display panel face each other. The app will recognize the information code automatically.
4. When the information code is recognized correctly, the app provides detailed information about the symptom and recommends further action.

### **NOTE**

- The function name, Smart Care, may differ depending on your language.
- If the washer display is reflecting light, the app may fail to recognize the information code.
- If the app fails to recognize the information code a number of times consecutively, enter the information code manually into the app screen.

## Emergency drain

In case of a power failure, drain the water inside the drum before taking out the laundry.

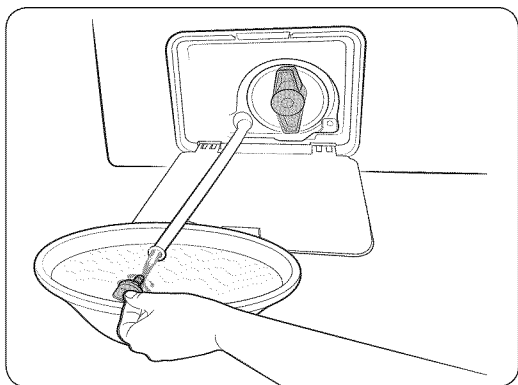
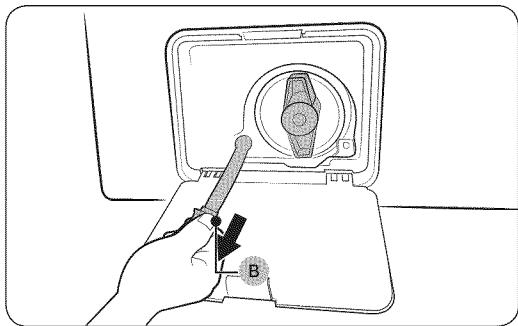
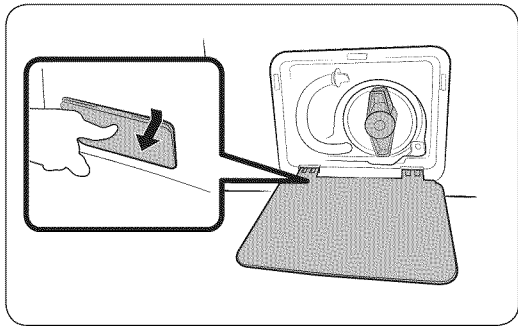

1. Power off the washer, and then unplug it from the electrical outlet.
2. Gently press the top area of the filter cover to open.

3. Put an empty, spacious container around the cover, and stretch the emergency drain tube to the container while holding the **tube cap (A)**.

4. Open the tube cap and let water in the **Emergency drain tube (B)** flow into the container.
5. When done, close the tube cap, and reassemble the tube. Then, close the filter cover.

### **NOTE**

Use a spacious container because the water in the drum may be more than expected.

# Maintenance

## Cleaning

### Surface of the washer

Use a soft cloth with a nonabrasive household detergent. Do not spray water onto the washer.

### Mesh filter

Clean the mesh filter of the water hose once or twice a year.

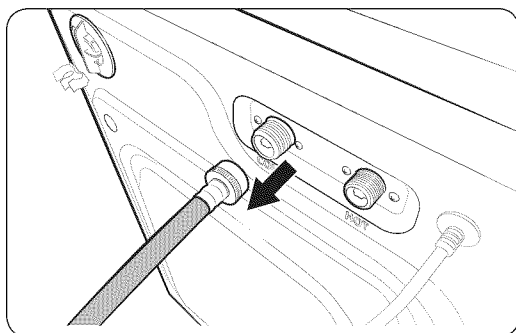

1. Turn off the washer, and then unplug the power cord.
2. Close the faucet.
3. Loosen and disconnect the water hose from the back of the washer. Cover the hose with a cloth to prevent water from gushing out.

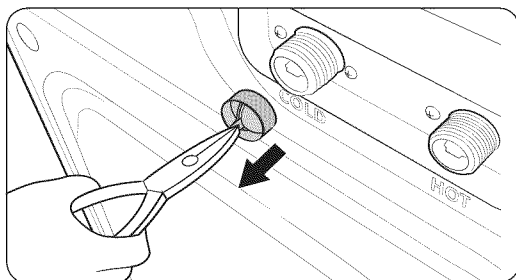

4. Use pliers to pull out the mesh filter from the inlet valve.
5. Submerge the mesh filter deeply in water so that the threaded connector is also submerged.
6. Dry the mesh filter completely in a shaded area.
7. Reinsert the mesh filter into the inlet valve, and reconnect the water hose to the inlet valve.
8. Open the faucet.

### NOTE

If the mesh filter is clogged, the “4C” information code appears on the the washer’s display screen.

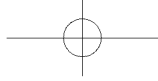

## Pump filter

It is advisable to clean the pump filter 5 or 6 times a year to prevent it from clogging. A clogged pump filter may reduce the bubble effect.

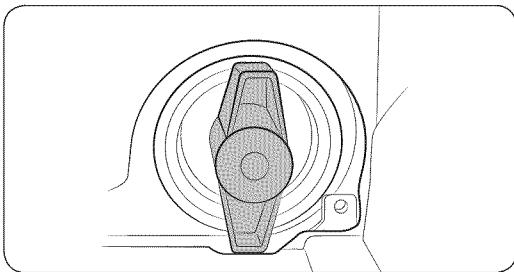
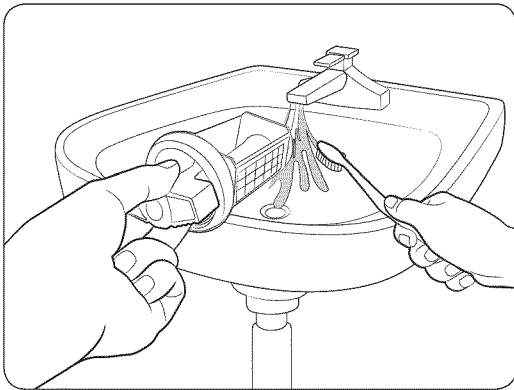
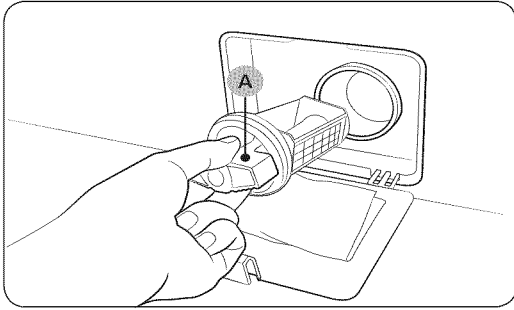

1. Turn off the washer, and then unplug the power cord.
2. Drain the remaining water inside the drum. See the “Emergency drain” section on page 49.
3. Gently press the top area of the filter cover to open.
4. Turn the **pump filter knob (A)** to the left, and drain off the remaining water.
5. Clean the pump filter using a soft brush. Make sure the drain pump propeller inside the filter is unclogged.
6. Reinsert the pump filter, and then turn the filter knob to the right.
7. Close the filter cover.

### NOTE

- Some pump filters feature a safety knob that is designed to prevent accidents by children. To open the safety knob of the pump filter, push in and turn it counterclockwise. The spring mechanism of the safety knob helps open the filter.
- To close the safety knob of the pump filter, turn it clockwise. The spring makes a rattling sound, which is normal.

### NOTE

If the pump filter is clogged, the “5C” information code appears on the washer’s display screen.

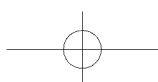
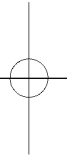

# Maintenance

## ⚠ CAUTION

- Make sure the filter knob is closed properly after cleaning the filter. Otherwise, this may cause a leak.
- Make sure the filter is inserted properly after cleaning it. Otherwise, this may cause an operational failure or a leak.

## Detergent drawer

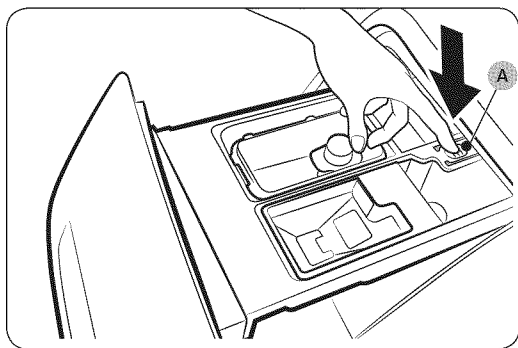

1. While holding down the **release lever (A)** inside the drawer, slide open the drawer, and then remove the drawer from the washer.
2. Remove the Liquid detergent container from the drawer.

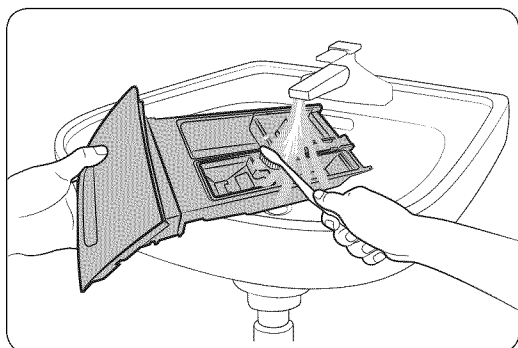

3. Clean the drawer components in flowing water using a soft brush.

## 📖 NOTE

Other parts of the drawer can also be removed. They can fall out if you hold the drawer upside down.

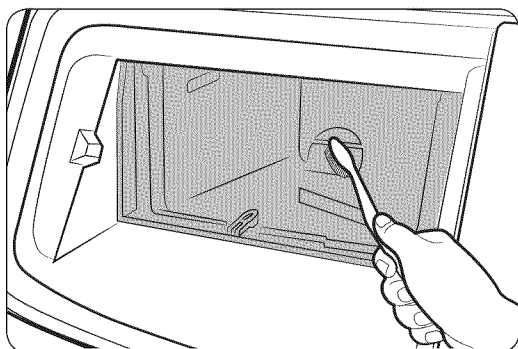

4. Clean the drawer recess using a soft brush.
5. Reinsert the liquid detergent container into the Detergent Drawer.
6. Slide the drawer into the drawer recess, and then push it inward until it is fully closed.

## 📖 NOTE

To remove remaining detergent, perform a **RINSE+SPIN** cycle with the drum empty.

## Add Door

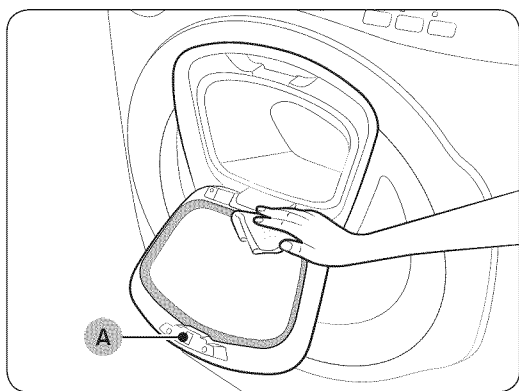

1. Open the Add Door.
2. Use a wet cloth to clean the Add Door.
  - Do not use cleaning agents. Discoloration may occur.
  - Use caution when cleaning the rubber packing and the locking mechanism.
  - Dust off the glass of the window and entrance area regularly.
3. Wipe up, and then close the Add Door. The Add Door is closed when you hear a click.

### CAUTION

- Do not apply excessive force to the Add Door. It may break.
- Do not leave the Add Door open while the machine is operating.
- Do not put heavy objects on the Add Door at any time.
- To prevent physical injury, do not touch the Add Door while the drum is rotating.
- Do not add laundry while the machine is in the drying process. The laundry may not dry well.
- Do not open the Add Door while the machine is operating. This may cause physical injury.
- Do not use the feature panel while the Add Door is open. This may cause physical injury or system failure.
- Insert only laundry through the Add Door.
- Do not insert bulky items into the drum through the Add Door.
- Do not pull out the rubber packing of the Add Door when cleaning. You can damage the Add Door.

# Maintenance

## Door diaphragm

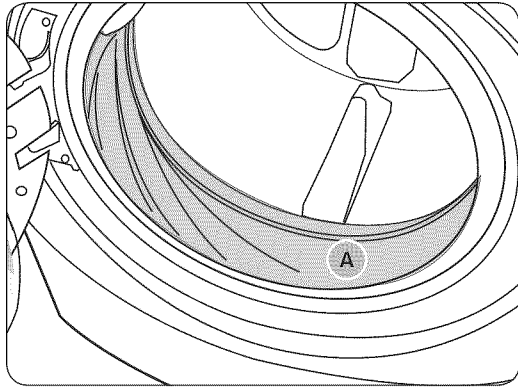

1. Open the door and empty the drum.
2. Turn over the **diaphragm (A)**.
3. Combine 3/4 cups of liquid chlorine bleach and 1 gallon of warm tap water.
4. Wearing rubber gloves, use a soft, clean cloth dipped in the water and chlorine solution to clean the diaphragm.
5. Let stand 5 minutes, and then wipe up and dry well.
6. Put the diaphragm back to position.

### CAUTION

Use bleach carefully and be sure to follow the bleach manufacturer's use and care instructions.

## Recovery from freezing

The washer may freeze when the temperature in its location drops below 0 °C.

1. Turn off the washer, and then unplug the power cord.
2. Pour warm water over the faucet to loosen the water hose.
3. Disconnect the water hose, and soak it in warm water.
4. Pour warm water into the drum and leave it for about 10 minutes.
5. Reconnect the water hose to the faucet.

### NOTE

If the washer still doesn't operate normally, repeat the steps above until it operates normally.

## Care against an extended time of disuse

Avoid leaving the washer unused for an extended time. If you intend to leave the washer unused for a long period of time, follow the directions below:

1. Press the Power button, and then turn the **Cycle Selector** to **RINSE+SPIN**.
2. Empty the drum, close the door, and then press **Start/Pause**.
3. When the cycle is complete, close the faucets and disconnect the water hoses.
4. Turn off the washer, and then unplug the power cord.
5. Open the door to let air circulate through the drum.



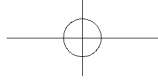

---

## Cleaning the exterior

---

1. Turn off the water faucets after finishing the day's washing.  
This will shut off the water supply to your washer and prevent the unlikely possibility of damage from escaping water. Leave the door open to allow the inside of your washer to dry out.
2. Use a soft cloth to wipe up all detergent, bleach, or other spills as they occur.  
Clean the following as recommended below:
  - Control Panel – Clean with a soft, damp cloth. Do not use abrasive powders or cleaning pads. Do not spray.
  - cleaners directly on the panel.
  - Cabinet – Clean with soap and water.

## Cleaning the interior

---

Clean the interior of your washer periodically to remove any dirt, soil, odor, mold, mildew, or bacterial residue that may remain in your washer as a result of washing clothes.

 **CAUTION**

Failure to follow these instructions may result in unpleasant conditions, including odors and/or permanent stains on your washer or laundry.

 **NOTE**

Hard water deposits may be removed, if needed. Use a cleaner labeled "Washer safe".

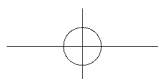
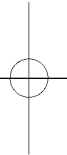
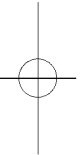

# Troubleshooting

## Checkpoints

If you encounter a problem with the washer, first check the table below and try the suggestions.

Problem	Action
Does not start.	<ul style="list-style-type: none"> <li>• Make sure the washer is plugged in.</li> <li>• Make sure the door is properly closed.</li> <li>• Make sure the faucets are open.</li> <li>• Make sure to press or tap <b>Start/Pause</b> to start the washer.</li> <li>• Make sure <b>Child Lock</b> is not activated.</li> <li>• Before the washer starts to fill, it will make a series of clicking noises to check the door lock and does a quick drain.</li> <li>• Check the fuse or reset the circuit breaker.</li> </ul>
Water supply is insufficient, or no water is supplied.	<ul style="list-style-type: none"> <li>• Fully open the faucet.</li> <li>• Make sure the door is properly closed.</li> <li>• Make sure the water supply hose is not frozen.</li> <li>• Make sure the water supply hose is not kinked or clogged.</li> <li>• Make sure there is sufficient water pressure.</li> </ul>
After a cycle, detergent remains in the detergent drawer.	<ul style="list-style-type: none"> <li>• Make sure the washer is running with sufficient water pressure.</li> <li>• If you are using powdered detergent, do not use more than recommended.</li> <li>• If you are using liquid detergent, do not over fill the liquid detergent compartment.</li> <li>• Remove the liquid detergent and softener containers, and then clean the detergent drawer.</li> </ul>
Excessive vibrations or makes noise.	<ul style="list-style-type: none"> <li>• Make sure the washer is installed on a level, solid floor that is not slippery. If the floor is not level, use the levelling feet to adjust the height of the washer.</li> <li>• Make sure the shipping bolts are removed.</li> <li>• Make sure the washer is not contacting any other object.</li> <li>• Make sure the laundry load is balanced.</li> <li>• The motor can cause noise during normal operation.</li> <li>• Overalls or metal-decorated clothes can cause noise while being washed. This is normal.</li> <li>• Metal objects such as coins can cause noise. After washing, remove these objects from the drum or filter case.</li> </ul>

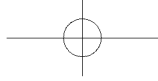

Problem	Action
<p><b>Does not drain and/or spin.</b></p>	<ul style="list-style-type: none"> <li>• Make sure the drain hose is neither kinked nor obstructed all the way to the drain system. If there is a drain restriction, call for service.</li> <li>• Make sure the debris filter is not clogged.</li> <li>• Close the door and press or tap <b>Start/Pause</b>. For your safety, the washer will not tumble or spin unless the door is closed.</li> <li>• Make sure the drain hose is not frozen or clogged.</li> <li>• Make sure the drain hose is connected to a drain system that is not clogged.</li> <li>• If the washer is not supplied with sufficient power, the washer temporarily will not drain or spin. As soon as the washer regains sufficient power, it will operate normally.</li> </ul>
<p><b>The door does not open.</b></p>	<ul style="list-style-type: none"> <li>• Press or tap <b>Start/Pause</b> to stop the washer.</li> <li>• It may take a few moments for the door lock mechanism to disengage.</li> <li>• The door will not open until 3 minutes after the washer has stopped or the power has been turned off.</li> <li>• Make sure all the water in the drum is drained.</li> <li>• The door may not open if water remains in the drum. Drain the drum and open the door manually.</li> <li>• Make sure the door lock light is off. The door lock light turns off after the washer has drained.</li> </ul>
<p><b>Excessive suds.</b></p>	<ul style="list-style-type: none"> <li>• Make sure you use the recommended types of detergent.</li> <li>• Use high efficiency (HE) detergent to prevent oversudsing.</li> <li>• Reduce the detergent amount for soft water, small loads, or lightly soiled loads.</li> <li>• Non-HE detergent is not recommended.</li> </ul>
<p><b>Cannot add additional detergent.</b></p>	<ul style="list-style-type: none"> <li>• Make sure the remaining amount of detergent and fabric softener is not over the limit.</li> </ul>

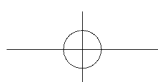
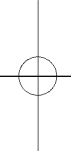

# Troubleshooting

Problem	Action
<p>The washer stops.</p>	<ul style="list-style-type: none"> <li>• Plug the power cord into a live electrical outlet.</li> <li>• Check the fuse or reset the circuit breaker.</li> <li>• Close the door and press the <b>Start/Pause</b> button to start the washer. For your safety, the washer will not tumble or spin unless the door is closed.</li> <li>• Before the washer starts to fill, it will make a series of clicking noises to check the door lock and does a quick drain.</li> <li>• There may be a pause or soak period in the cycle. Wait and the washer may start.</li> <li>• Make sure the mesh filter of the water supply hose at the faucets is not clogged. Periodically clean the mesh filter.</li> <li>• If the washer is not supplied with sufficient power, the washer temporarily will not drain or spin. As soon as the washer regains sufficient power, it will operate normally.</li> </ul>
<p>The washer fills with the wrong water temperature.</p>	<ul style="list-style-type: none"> <li>• Fully open both taps.</li> <li>• Make sure the temperature selection is correct.</li> <li>• Make sure the hoses are connected to the correct taps. Flush the water lines.</li> <li>• Make sure your water heater is set to supply hot water with a minimum temperature of 120 °F (49 °C) at the tap. Also, check the water heater capacity and recovery rate.</li> <li>• Disconnect the hoses and clean the mesh filter. The mesh filter may be clogged.</li> <li>• While the washer fills, the water temperature may change as the automatic temperature control feature checks the incoming water temperature. This is normal.</li> <li>• While the washer fills, you may notice just hot and/or just cold water going through the dispenser when cold or warm temperatures are selected. This is a normal function of the automatic temperature control feature as the washer determines the water temperature.</li> </ul>
<p>The load is wet at the end of a cycle.</p>	<ul style="list-style-type: none"> <li>• Use the High or Extra High spin speed.</li> <li>• Use high efficiency (HE) detergent to reduce oversudsing.</li> <li>• The load is too small. Small loads (one or two items) may become unbalanced and not spin completely.</li> <li>• Make sure the drain hose is not kinked or clogged.</li> </ul>

Problem	Action
Leaks water.	<ul style="list-style-type: none"> <li>• Make sure the door is properly closed.</li> <li>• Make sure all hose connections are tight.</li> <li>• Make sure the end of the drain hose is correctly inserted and secured to the drain system.</li> <li>• Avoid overloading.</li> <li>• Use high efficiency (HE) detergent to prevent oversudsing.</li> </ul>
Has odours.	<ul style="list-style-type: none"> <li>• Excessive suds collect in recesses and can cause foul odours.</li> <li>• Run cleansing cycles to sanitize periodically.</li> <li>• Clean the door seal (diaphragm).</li> <li>• Dry the washer interior after a cycle has finished.</li> </ul>
No bubbles are seen (BubbleShot models only).	<ul style="list-style-type: none"> <li>• Overloading may screen bubbles.</li> <li>• Severely contaminated laundry may not generate bubbles.</li> </ul>
Can I open the Add Door at any time?	<ul style="list-style-type: none"> <li>• The Add Door can be opened only when the  indicator appears. Note that it does not open in the following cases: <ul style="list-style-type: none"> <li>- When the steam or drying process is running and the internal temperature becomes high</li> <li>- If you set the Child Lock on for safety reasons</li> <li>- When a drum wash or drum drying cycle is running that does not permit additional laundry</li> </ul> </li> </ul>

If a problem persists, contact a local Samsung service center.

# Troubleshooting

## Samsung Smart Home

Problem	Action
I could not find "Samsung Smart Home" in the app market.	<ul style="list-style-type: none"> <li>The Samsung Smart Home app is available for smartphones that run Android 4.0 (ICS) or higher, or iOS 7.0 or higher.</li> </ul>
The Samsung Smart Home app fails to operate.	<ul style="list-style-type: none"> <li>The Samsung Smart Home app for available in applicable models only.</li> <li>The old Samsung Smart Washing machine app cannot connect with Samsung Smart Home models.</li> </ul>
The Samsung Smart Home app is installed but is not connected to my washing machine.	<ul style="list-style-type: none"> <li>You must log into your Samsung account to use the app.</li> <li>Make sure that your router is operating normally.</li> <li>Make sure that the SmartHome Adapter is inserted properly.</li> <li>If the Wi-Fi Indicator (Wi-Fi) on the washing machine's display is off, this indicates that no network connection has been established. Use the Samsung Smart Home app to connect and register the washing machine with your home network access point (AP).</li> </ul>
Could not log into the app.	<ul style="list-style-type: none"> <li>You must log into your Samsung account to use the app.</li> <li>If you don't have a Samsung account, follow the app's onscreen instructions to create one.</li> </ul>
An error message appears when I try to register my washing machine.	<ul style="list-style-type: none"> <li>The connection may fail due to the distance from your access point (AP) or electrical interference from the surrounding environment. Wait a moment and try again.</li> </ul>
The Samsung Smart Home app is successfully connected to my washing machine but does not run.	<ul style="list-style-type: none"> <li>Exit and restart the Samsung Smart Home app or unplug your router and then reconnect it.</li> <li>Remove the SmartHome Adapter, and reconnect it properly. Then, try again.</li> </ul>

## Information codes

If the washer fails to operate, you may see an information code on the screen. Check the table below and try the suggestions.

Code	Action
1C	<b>Check the water level sensor.</b> <ul style="list-style-type: none"><li>• Power off and then power the washer on after 2-3 minutes, and then try again.</li><li>• Depending on the model, the drain system drains water automatically. The <b>POWER</b> and <b>START/PAUSE</b> buttons may be disabled during this process.</li></ul>
DC	<b>The door is open.</b> <ul style="list-style-type: none"><li>• Close the door, and then press <b>START/PAUSE</b> to resume operation.</li></ul>
DC1	<b>Check the door switch.</b> <ul style="list-style-type: none"><li>• Power off and then power the washer on after 2-3 minutes, and then try again.</li></ul>
LC	<b>Check for water leaks.</b> <ul style="list-style-type: none"><li>• Power the washer off, and then check the drain system for any leaks. Once the leak issue is resolved, power the washer on after 2-3 minutes.</li><li>• Depending on the model, the drain system drains water automatically. The <b>POWER</b> and <b>START/PAUSE</b> buttons may be disabled during this process.</li></ul>
4C	<b>Check the water supply line.</b> <ul style="list-style-type: none"><li>• Check the connection to the water line (including water taps).</li><li>• Power off and then power the washer on after 2-3 minutes, and then try again.</li><li>• Depending on the model, the drain system drains water automatically. The <b>POWER</b> and <b>START/PAUSE</b> buttons may be disabled during this process.</li></ul>
4C2	<b>Laundry needs protection because the water being supplied is too hot.</b> <ul style="list-style-type: none"><li>• Make sure the cold and hot water taps are properly connected.</li><li>• Power off and then power the washer on after 2-3 minutes, and then try again.</li></ul>

# Troubleshooting

Code	Action
5C	<p><b>Check the drain system.</b></p> <ul style="list-style-type: none"> <li>• Make sure the drain filter is not clogged.</li> <li>• If the drain filter is clogged, clean the filter filter, and then restart the washer.</li> </ul>
HC	<p><b>Check the washing heater.</b></p> <ul style="list-style-type: none"> <li>• Power off the washer, and then contact a Samsung customer service center.</li> </ul>
UB	<p><b>Check the spinning process.</b></p> <ul style="list-style-type: none"> <li>• The load may not be balanced inside the drum. Check the drum and make sure the load is balanced.</li> <li>• Press <b>START/PAUSE</b> to resume operation, or power off and then power the washer on after 2-3 minutes, and then try again.</li> </ul>
8C, 8C1, 8C2	<p><b>Check the MEMS sensor.</b></p> <ul style="list-style-type: none"> <li>• Power off and then power the washer on after 2-3 minutes, and then try again.</li> </ul>
OC	<p><b>Water may overflow.</b></p> <ul style="list-style-type: none"> <li>• Close the water tap, and then call for service.</li> </ul>
3C	<p><b>Check the motor.</b></p> <ul style="list-style-type: none"> <li>• Power off and then power the washer on after 2-3 minutes, and then try again.</li> </ul>
AC6	<p><b>Check the PBA communication status.</b></p> <ul style="list-style-type: none"> <li>• Power off and then power the washer on after 2-3 minutes, and then try again.</li> </ul>
DDC	<p><b>The Add Door is open.</b></p> <ul style="list-style-type: none"> <li>• Close the Add Door, and then press <b>START/PAUSE</b> to resume operation.</li> </ul>
DC3	<p><b>Check the Add Door.</b></p> <ul style="list-style-type: none"> <li>• Power off and then power the washer on after 2-3 minutes, and then try again.</li> </ul>
9C1/9C2	<p><b>The electronic control needs to be checked.</b></p> <ul style="list-style-type: none"> <li>• Check if power is supplied properly.</li> <li>• If the information code remains, contact a Samsung service center.</li> </ul>
SF	<p><b>System failed.</b></p> <ul style="list-style-type: none"> <li>• Power off the washer, and then contact a Samsung service center.</li> </ul>

If any information code keeps appearing on the screen, contact a local Samsung service center.



# Specifications

## Fabric care chart

The following symbols provide garment care direction. The clothing care labels include symbols for drying, bleaching, drying and ironing, or dry cleaning when necessary. The use of symbols ensures consistency among garment manufacturers of domestic and imported items. Follow care label directions to optimize garment life and reduce laundering problems.

### Wash cycle

	Normal
	Permanent press/Wrinkle resistant/Wrinkle control
	Gentle/Delicates
	Hand wash

### Water temperature

	Hot
	Warm
	Cold

### NOTE

The temperature range for Hot is 106 - 126 °F (41 - 52 °C), 84 - 106 °F (29 - 41 °C) for Warm, and 61 - 84 °F (16 - 29 °C) for Cold. Wash water temperature must be a minimum of 61 °F (16 °C) for detergent activation and effective cleaning.

### Bleach

	Any bleach (when needed)
	Only non-chlorine (color-safe) bleach (when needed)
	Tumble dry

### Normal

	Permanent press/Wrinkle resistant/Wrinkle control
	Gentle/Delicates

### Special instructions



	Line dry/Hang to dry
	Drip dry
	Dry flat

### Heat setting





	High
	Medium
	Low
	Any heat
	No heat / Air



# Specifications

## Iron dry or steam temperatures





	High
	Medium
	Low

## Warning symbols for laundering

	Do not wash
	Do not wring
	Do not bleach
	Do not tumble dry

	No steam (added to iron)
	Do not iron

## Dry-clean

	Dry-clean
	Do not dry-clean
	Line dry / Hang to dry
	Drip dry
	Dry flat

## Protecting the environment

- This appliance is manufactured from recyclable materials. If you decide to dispose of it, please observe local waste disposal regulations. Cut off the power cord so that the appliance cannot be connected to a power source. Remove the lid so that animals and small children cannot get trapped inside the appliance.
- Do not exceed the detergent quantities recommended in the detergent manufacturers' instructions.
- Use stain removal products and bleaches before the wash cycle only when necessary.
- Save water and electricity by only washing full loads (the exact amount depends upon the program used).

## Declaration of conformity

This appliance complies with UL2157.

## Specification sheet

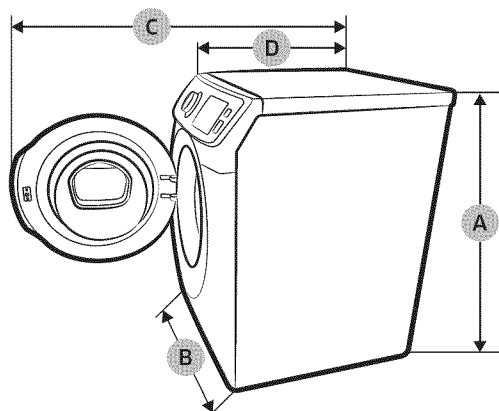

Type		Front loading washer		
Model		WF45K6200A*	WF45K6500	
Dimensions (inches (mm))	A. Height-overall		38.7 (984)	
	B. Width		27 (686)	
	C. Depth with door open		54.6 (1386)	
	D. Depth		34 (864)	
Water pressure (psi (kPa))		20 - 116 (137 - 800)		
NET weight (lb (kg))		225 (102)	227 (103)	
Spin revolution		1300 rpm		
Heater rating		-	900 W	
Power consumption	Washing	120 V	200 W	200 W
	Washing and heating	120 V	-	1150 W
	Spin	120 V	550 W	550 W
	Drain	120 V	80 W	80 W

# Specifications

## Cycle chart

Use this chart to set the best cycle and options for you laundry.

### NOTE

Setting	Temp.	Spin	Soil Level
●: factory setting	EH: Extra Hot	EH: Extra High	H: Heavy
◐: can be selected	H: Hot	H: High	▲
	W: Warm	M: Medium	N: Normal
	C: Cold	L: Low	▼
	TC: Tap Cold	NS: No Spin	L: Light

### WF45K6500A\*

Cycle	Temp.					Spin					Soil Level				
	EH	H	W	C	TC	EH	H	M	L	NS	H	▲	N	▼	L
NORMAL	◐	◐	●	◐	◐	◐	●	◐	◐	◐	◐	◐	◐	◐	◐
HEAVY DUTY	◐	●	◐	◐	◐	●	◐	◐	◐	◐	●	◐	◐	◐	◐
BEDDING			●	◐	◐			◐	●	◐	◐	◐	◐	◐	◐
WHITES		◐	●	◐	◐	◐	●	◐	◐	◐	◐	◐	◐	◐	◐
SANITIZE	●					◐	●	◐	◐	◐	◐	◐	◐	◐	◐
ALLERGEN		●				◐	●	◐	◐	◐	◐	◐	◐	◐	◐
RINSE + SPIN						◐	●	◐	◐	◐					
ACTIVE WEAR			●	◐	◐				●	◐	◐	◐	◐	◐	◐
DELICATES			◐	◐	●				●	◐	◐	◐	◐	◐	◐
WOOL			●	◐	◐				●	◐			◐	◐	◐
PERM PRESS			●	◐	◐		◐	◐	●	◐	◐	◐	◐	◐	◐
TOWELS				◐	●	◐	●	◐	◐	◐	◐	◐	◐	◐	◐
QUICK WASH		◐	●	◐	◐	◐	●	◐	◐	◐	◐	◐	◐	◐	●
DEEP STEAM		●				◐	●	◐	◐	◐	●				
SELF CLEAN+	●					●									

Cycle	Options						
	Pre Wash	Extra Rinse	Extra Spin	Steam	Super Speed	Delay End	My cycle
NORMAL	◐	◐	◐	◐	◐	◐	◐
HEAVY DUTY	●	◐	◐	◐	◐	◐	◐
BEDDING	◐	◐	◐	◐	◐	◐	◐
WHITES	◐	◐	◐	◐		◐	◐
SANITIZE	◐	◐	◐	◐		◐	◐
ALLERGEN	◐	◐	◐	◐	◐	◐	◐
RINSE + SPIN		◐	◐			◐	◐
ACTIVE WEAR	◐	◐	◐			◐	◐
DELICATES		◐				◐	◐
WOOL						◐	◐
PERM PRESS	◐	◐	◐			◐	◐
TOWELS	◐	◐	◐			◐	◐
QUICK WASH		◐				◐	◐
DEEP STEAM	◐	◐	◐	●	◐	◐	◐
SELF CLEAN+						◐	

Use this chart to set the best cycle and options for you laundry.

**NOTE**

Setting	Temp.	Spin	Soil Level
●: factory setting	H: Hot	H: High	H : Heavy
●: can be selected	W: Warm	M: Medium	N: Normal
	C: Cold	L: Low	L: Light
	TC: Tap Cold	NS: No Spin	

**WF45K6200A\***

Cycle	Temp.				Spin				Soil Level		
	H	W	C	TC	H	M	L	NS	H	N	L
NORMAL	●	●	●	●	●	●	●	●	●	●	●
HEAVY DUTY	●	●	●	●	●	●	●	●	●	●	●
BEDDING		●	●	●		●	●	●	●	●	●
WHITES	●	●	●	●	●	●	●	●	●	●	●
STAIN AWAY	●	●	●	●	●	●	●	●	●	●	●
RINSE + SPIN					●	●	●	●			
ACTIVE WEAR		●	●	●			●	●	●	●	●
DELICATES		●	●	●			●	●	●	●	●
WOOL		●	●	●			●	●		●	●
PERM PRESS		●	●	●	●	●	●	●	●	●	●
TOWELS			●	●	●	●	●	●	●	●	●
QUICK WASH	●	●	●	●	●	●	●	●	●	●	●
SELF CLEAN+	●				●						

Cycle	Options				
	Pre Wash	Extra Rinse	Extra Spin	Delay End	My cycle
NORMAL	●	●	●	●	●
HEAVY DUTY	●	●	●	●	●
BEDDING	●	●	●	●	●
WHITES	●	●	●	●	●
STAIN AWAY	●	●		●	●
RINSE + SPIN		●	●	●	●
ACTIVE WEAR	●	●	●	●	●
DELICATES		●		●	●
WOOL				●	●
PERM PRESS	●	●	●	●	●
TOWELS	●	●	●	●	●
QUICK WASH		●		●	●
SELF CLEAN+				●	

Specifications

# Warranty (U.S.A)

---

## SAMSUNG WASHER

---

### LIMITED WARRANTY TO ORIGINAL PURCHASER

This SAMSUNG brand product, as supplied and distributed by SAMSUNG ELECTRONICS AMERICA, INC. (SAMSUNG) and delivered new, in the original carton to the original consumer purchaser, is warranted by SAMSUNG against manufacturing defects in materials and workmanship for a limited warranty period of:

One (1) year part and labor, Three (3) years stainless tub part (Part Only), Ten (10) years washing DD motor part (Part Only)

This limited warranty begins on the original date of purchase, and is valid only on products purchased and used in the United States. To receive warranty service, the purchaser must contact SAMSUNG for problem determination and service procedures. Warranty service can only be performed by a SAMSUNG authorized service center. The original dated bill of sale must be presented upon request as proof of purchase to SAMSUNG or SAMSUNG's authorized service center. SAMSUNG will provide in-home service during the warranty period at no charge, subject to availability within the contiguous United States. In-home service is not available in all areas.

To receive in-home service, product must be unobstructed and accessible to the service agent. If service is not available, SAMSUNG may elect to provide transportation of the product to and from an authorized service center.

---

SAMSUNG will repair, replace, or refund this product at our option and at no charge as stipulated herein, with new or reconditioned parts or products if found to be defective during the limited warranty period specified above. All replaced parts and products become the property of SAMSUNG and must be returned to SAMSUNG. Replacement parts and products assume the remaining original warranty, or ninety (90) days, whichever is longer. This limited warranty covers manufacturing defects in materials and workmanship encountered in normal, noncommercial use of this product and shall not apply to the following: damage that occurs in shipment; delivery and installation; applications and uses for which this product was not intended; altered product or serial numbers; cosmetic damage or exterior finish; accidents, abuse, neglect, fire, water, lightning, or other acts of nature or God; use of products, equipment, systems, utilities, services, parts, supplies, accessories, applications, installations, repairs, external wiring or connectors not supplied or authorized by SAMSUNG that damage this product or result in service problems; incorrect electrical line voltage, fluctuations and surges; customer adjustments and failure to follow operating instructions, maintenance and environmental instructions that are covered and prescribed in the instruction book; product removal and reinstallation; problems caused by pest infestations. This limited warranty does not cover problems resulting from incorrect electric current, voltage or supply, light bulbs, house fuses, house wiring, cost of a service call for instructions, or fixing installation errors. SAMSUNG does not warrant uninterrupted or error-free operation of the product.

EXCEPT AS SET FORTH HEREIN, THERE ARE NO WARRANTIES ON THIS PRODUCT EITHER EXPRESS OR IMPLIED, AND SAMSUNG DISCLAIMS ALL WARRANTIES INCLUDING, BUT NOT LIMITED TO, ANY IMPLIED WARRANTIES OF MERCHANTABILITY, INFRINGEMENT OR FITNESS FOR A PARTICULAR PURPOSE.

# Warranty (U.S.A)

---

NO WARRANTY OR GUARANTEE GIVEN BY ANY PERSON, FIRM, OR CORPORATION WITH RESPECT TO THIS PRODUCT SHALL BE BINDING ON SAMSUNG. SAMSUNG SHALL NOT BE LIABLE FOR LOSS OF REVENUE OR PROFITS, FAILURE TO REALIZE SAVINGS OR OTHER BENEFITS, OR ANY OTHER SPECIAL, INCIDENTAL OR CONSEQUENTIAL DAMAGES CAUSED BY THE USE, MISUSE, OR INABILITY TO USE THIS PRODUCT, REGARDLESS OF THE LEGAL THEORY ON WHICH THE CLAIM IS BASED, AND EVEN IF SAMSUNG HAS BEEN ADVISED OF THE POSSIBILITY OF SUCH DAMAGES.

NOR SHALL RECOVERY OF ANY KIND AGAINST SAMSUNG BE GREATER IN AMOUNT THAN THE PURCHASE PRICE OF THE PRODUCT SOLD BY SAMSUNG AND CAUSING THE ALLEGED DAMAGE. WITHOUT LIMITING THE FOREGOING, PURCHASER ASSUMES ALL RISK AND LIABILITY FOR LOSS, DAMAGE, OR INJURY TO PURCHASER AND PURCHASER'S PROPERTY AND TO OTHERS AND THEIR PROPERTY ARISING OUT OF THE USE, MISUSE, OR INABILITY TO USE THIS PRODUCT. THIS LIMITED WARRANTY SHALL NOT EXTEND TO ANYONE OTHER THAN THE ORIGINAL PURCHASER OF THIS PRODUCT, IS NONTRANSFERABLE AND STATES YOUR EXCLUSIVE REMEDY.

Some states do not allow limitations on how long an implied warranty lasts, or the exclusion or limitation of incidental or consequential damages, so the above limitations or exclusions may not apply to you. This warranty gives you specific rights, and you may also have other rights, which vary from state to state.

To obtain warranty service, please contact SAMSUNG at:

**Samsung Electronics America, Inc.**

**85 Challenger Road**

**Ridgefield Park, NJ 07660**

**1-800-SAMSUNG (726-7864)**

**[www.samsung.com/us/support](http://www.samsung.com/us/support)**

Visits by a Service Engineer to explain functions, maintenance or installation is not covered by warranty.

Please contact the Samsung call center for help with any of these issues.



# Warranty (CANADA)

---

## SAMSUNG WASHER

---

### LIMITED WARRANTY TO ORIGINAL PURCHASER

This SAMSUNG brand product, as supplied and distributed by SAMSUNG ELECTRONICS CANADA, INC. (SAMSUNG) and delivered new, in the original carton to the original consumer purchaser, is warranted by SAMSUNG against manufacturing defects in materials and workmanship for a limited warranty period of:

One (1) year part and labor, Ten (10) years washing DD motor (Part only)

This limited warranty begins on the original date of purchase, and is valid only on products purchased and used in the Canada. To receive warranty service, the purchaser must contact SAMSUNG for problem determination and service procedures. Warranty service can only be performed by a SAMSUNG authorized service center. The original dated bill of sale must be presented upon request as proof of purchase to SAMSUNG or SAMSUNG's authorized service center. SAMSUNG will provide in-home service during the warranty period at no charge, subject to availability within the Canada. In-home service is not available in all areas.

To receive in-home service, product must be unobstructed and accessible to the service agent. If service is not available, SAMSUNG may elect to provide transportation of the product to and from an authorized service center.

## Warranty (CANADA)

---

SAMSUNG will repair, replace, or refund this product at our option and at no charge as stipulated herein, with new or reconditioned parts or products if found to be defective during the limited warranty period specified above. All replaced parts and products become the property of SAMSUNG and must be returned to SAMSUNG. Replacement parts and products assume the remaining original warranty, or ninety (90) days, whichever is longer. This limited warranty covers manufacturing defects in materials and workmanship encountered in normal, noncommercial use of this product and shall not apply to the following: damage that occurs in shipment; delivery and installation; applications and uses for which this product was not intended; altered product or serial numbers; cosmetic damage or exterior finish; accidents, abuse, neglect, fire, water, lightning, or other acts of nature or God; use of products, equipment, systems, utilities, services, parts, supplies, accessories, applications, installations, repairs, external wiring or connectors not supplied or authorized by SAMSUNG that damage this product or result in service problems; incorrect electrical line voltage, fluctuations and surges; customer adjustments and failure to follow operating instructions, maintenance and environmental instructions that are covered and prescribed in the instruction book; product removal and reinstallation; problems caused by pest infestations. This limited warranty does not cover problems resulting from incorrect electric current, voltage or supply, light bulbs, house fuses, house wiring, cost of a service call for instructions, or fixing installation errors. SAMSUNG does not warranty uninterrupted or error-free operation of the product.

EXCEPT AS SET FORTH HEREIN, THERE ARE NO WARRANTIES ON THIS PRODUCT EITHER EXPRESS OR IMPLIED, AND SAMSUNG DISCLAIMS ALL WARRANTIES INCLUDING, BUT NOT LIMITED TO, ANY IMPLIED WARRANTIES OF MERCHANTABILITY, INFRINGEMENT OR FITNESS FOR A PARTICULAR PURPOSE.

---

NO WARRANTY OR GUARANTEE GIVEN BY ANY PERSON, FIRM, OR CORPORATION WITH RESPECT TO THIS PRODUCT SHALL BE BINDING ON SAMSUNG. SAMSUNG SHALL NOT BE LIABLE FOR LOSS OF REVENUE OR PROFITS, FAILURE TO REALIZE SAVINGS OR OTHER BENEFITS, OR ANY OTHER SPECIAL, INCIDENTAL OR CONSEQUENTIAL DAMAGES CAUSED BY THE USE, MISUSE, OR INABILITY TO USE THIS PRODUCT, REGARDLESS OF THE LEGAL THEORY ON WHICH THE CLAIM IS BASED, AND EVEN IF SAMSUNG HAS BEEN ADVISED OF THE POSSIBILITY OF SUCH DAMAGES.

NOR SHALL RECOVERY OF ANY KIND AGAINST SAMSUNG BE GREATER IN AMOUNT THAN THE PURCHASE PRICE OF THE PRODUCT SOLD BY SAMSUNG AND CAUSING THE ALLEGED DAMAGE. WITHOUT LIMITING THE FOREGOING, PURCHASER ASSUMES ALL RISK AND LIABILITY FOR LOSS, DAMAGE, OR INJURY TO PURCHASER AND PURCHASER'S PROPERTY AND TO OTHERS AND THEIR PROPERTY ARISING OUT OF THE USE, MISUSE, OR INABILITY TO USE THIS PRODUCT. THIS LIMITED WARRANTY SHALL NOT EXTEND TO ANYONE OTHER THAN THE ORIGINAL PURCHASER OF THIS PRODUCT, IS NONTRANSFERABLE AND STATES YOUR EXCLUSIVE REMEDY.

Some provinces do not allow limitations on how long an implied warranty lasts, or the exclusion or limitation of incidental or consequential damages, so the above limitations or exclusions may not apply to you.

This warranty gives you specific rights, and you may also have other rights, which vary from province to province.

To obtain warranty service, please contact SAMSUNG at:

**Samsung Electronics Canada Inc.**

**2050 Derry Road West,**

**Mississauga, Ontario L5N 0B9 Canada.**

**1-800-SAMSUNG (726-7864)**

**[www.samsung.com/ca/support](http://www.samsung.com/ca/support) (English)**

**[www.samsung.com/ca\\_fr/support](http://www.samsung.com/ca_fr/support) (French)**

**FAX : 1-866-436-4617**

Visits by a Service Engineer to explain functions, maintenance or installation is not covered by warranty.

Please contact the Samsung call center for help with any of these issues.

# SAMSUNG

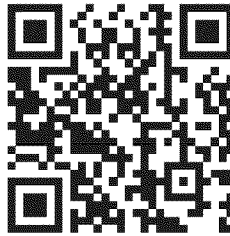

Scan the QR code\* or visit  
[www.samsung.com/spsn](http://www.samsung.com/spsn)  
to view our helpful  
How-to Videos and Live Shows

\*Requires reader to be installed on your smartphone

Scan this with your smartphone

## QUESTIONS OR COMMENTS?

COUNTRY	CALL	OR VISIT US ONLINE AT
U.S.A	1-800-SAMSUNG (726-7864)	<a href="http://www.samsung.com/us/support">www.samsung.com/us/support</a>
CANADA	1-800-SAMSUNG (726-7864)	<a href="http://www.samsung.com/ca/support">www.samsung.com/ca/support</a> (English) <a href="http://www.samsung.com/ca_fr/support">www.samsung.com/ca_fr/support</a> (French)



DC68-03665A-01