

**SAMSUNG**

**HW-J7500R**

**HW-J7501R**

**Wireless Subwoofer  
(PS-WJ7500R / PS-WJ7501R)**

**User manual**

**Curved Soundbar**

**Imagine the possibilities**

Thank you for purchasing this Samsung product.  
To receive more complete service, please register your product at  
[www.samsung.com/register](http://www.samsung.com/register)

# FEATURES

## Streaming Music Services

The Curved Soundbar makes diving into all your favorite music easier than ever before, thanks to its Wi-Fi capabilities. Simply access the Samsung Multiroom App to experience the best of the internet's subscription streaming music services.

## Surround Sound Expansion

The Surround Sound Expansion feature adds depth and spaciousness to your listening experience.

## TV SoundConnect

Listen to TV audio through the Soundbar by connecting your TV and the Soundbar via Bluetooth with TV SoundConnect. Easy connectivity and the absence of trailing wires between the Soundbar and TV allows you to showcase the slim and sleek design of both systems, while maintaining a clean look in your living environment. Easily control the Soundbar and TV from a single TV remote.

## Music Source Sharing (= Multiroom Play)

Controlling and sharing one music source across multiple audio devices in various locations is made easy with Multiroom Link. The mobile app remotely controls volume and music on your system across different devices, including your TV, Soundbar, Home Entertainment System and Blu-ray Disc Player. Enjoy the audio you want, where you want.

## HDMI

HDMI transmits digital video and audio signals simultaneously, and provides a clearer picture. The unit also comes with the ARC function which lets you listen to sound from your TV through the Soundbar via an HDMI cable. This function is only available if you connect the unit to an ARC compliant TV.

## Bluetooth Function

You can connect a Bluetooth device to the Soundbar and enjoy music with high quality stereo sound, all without wires!

## LICENSES



Manufactured under license from Dolby Laboratories. Dolby and the double-D symbol are trademarks of Dolby Laboratories.



For DTS patents, see <http://patents.dts.com>. Manufactured under license from DTS Licensing Limited. DTS, the Symbol, & DTS and the Symbol together are registered trademarks, and DTS 2.0 Channel is a trademark of DTS, Inc. © DTS, Inc. All Rights Reserved.

## HDMI

The terms HDMI and HDMI High-Definition Multimedia Interface, and the HDMI Logo are trademarks or registered trademarks of HDMI Licensing LLC in the United States and other countries.





# SAFETY INFORMATION







- The following also applies to the Wireless Subwoofer (PS-WJ7500R, PS-WJ7501R).

## SAFETY WARNINGS

TO REDUCE THE RISK OF ELECTRIC SHOCK, DO NOT REMOVE THE COVER (OR BACK).  
NO USER-SERVICEABLE PARTS ARE INSIDE. REFER SERVICING TO QUALIFIED SERVICE PERSONNEL.

|   |   |   |   |   |
|---|---|---|---|---|
|  | <b>CAUTION</b><br><b>RISK OF ELECTRIC SHOCK.</b><br><b>DO NOT OPEN.</b> |  |  | The lightning flash and arrowhead within the triangle indicates that there is dangerous voltage inside the product. |
|   |   |   |  | The exclamation point within the triangle indicates that there are important instructions accompanying the product. |

|   |   |
|---|---|
|  | Class II product : This symbol indicates that a safety connection to electrical earth (ground) is not required.                           |
|  | AC voltage : Rated voltage marked with this symbol is AC voltage  |
|  | DC voltage : Rated voltage marked with this symbol is DC voltage.   |
|  | Caution. Consult Instructions for use : This symbol instructs the user to consult the user manual for further safety related information. |

### WARNING

- To reduce the risk of fire or electric shock, do not expose this apparatus to rain or moisture.
- To prevent injury, this apparatus must be securely attached to the floor/wall in accordance with the installation instructions.
- This product contains chemicals known to the State of California to cause cancer and birth defects or other reproductive harm.

### CAUTION

- Do not expose this apparatus to dripping or splashing. Do not put objects filled with liquids, such as vases on the apparatus.
- To turn this apparatus off completely, you must pull the power plug out of the wall socket. Consequently, the power plug must be easily and readily accessible at all times.

This product satisfies FCC regulations when shielded cables and connectors are used to connect the unit to other equipment. To prevent electromagnetic interference with electric appliances, such as radios and televisions, use shielded cables and connectors for connections.

### FCC NOTE (for U.S.A):

This equipment has been tested and found to comply with the limits for a Class B digital device, pursuant to Part 15 of the FCC Rules. These limits are designed to provide reasonable protection against harmful interference in a residential installation.

This equipment generates, uses and can radiate radio frequency energy and, if not installed and used in accordance with the instructions, may cause harmful interference to radio communications. However, there is no guarantee that interference will not occur in a particular installation.

If this equipment does cause harmful interference to radio or television reception, which can be determined by turning the equipment off and on, the user is encouraged to try to correct the interference by one or more of the following measures:

- Reorienting or relocating the receiving antenna.
- Increasing the separation between the equipment and receiver.
- Connecting the equipment to an outlet that is on a different circuit than the radio or TV.
- Consulting the dealer or an experienced radio/TV technician for help.

Caution : FCC regulations state that any unauthorized changes or modifications to this equipment may void the user's authority to operate it.

### Important Safety Instructions

Read these operating instructions carefully before using the unit. Follow all the safety instructions listed below. Keep these operating instructions handy for future reference.

- 1) Read these instructions.
- 2) Keep these Instructions.
- 3) Heed all warnings.
- 4) Follow all instructions.
- 5) Do not use this apparatus near water.
- 6) Clean only with a dry cloth.
- 7) Do not block any ventilation openings. Install in accordance with the manufacturer's instructions.
- 8) Do not install near any heat sources such as radiators, heat registers, stoves, or other apparatus (including amplifiers) that produce heat.
- 9) Do not defeat the safety purpose of the polarized or grounding-type plug. A polarized plug has two blades with one wider than the other. A grounding type plug has two blades and a third grounding prong. The wide blade or the third prong are provided for your safety. If the provided plug does not fit into your outlet, consult an electrician for replacement of the obsolete outlet.
- 10) Protect the power cord from being walked on or pinched particularly at plugs, convenience receptacles, and the point where they exit from the apparatus.
- 11) Only use attachments/accessories specified by the manufacturer.
- 12) Use only with the cart, stand, tripod, bracket, or table specified by the manufacturer, or sold with the apparatus. When a cart is used, use caution when moving the cart/apparatus combination to avoid injury from tip-over.
- 13) Unplug this apparatus during lightning storms or when unused for long periods of time.
- 14) Refer all servicing to qualified service personnel. Servicing is required when the apparatus has been damaged in any way, such as when the power-supply cord or plug is damaged, liquid has been spilled or objects have fallen into the apparatus, the apparatus has been exposed to rain or moisture, does not operate normally, or has been dropped.



## PRECAUTIONS

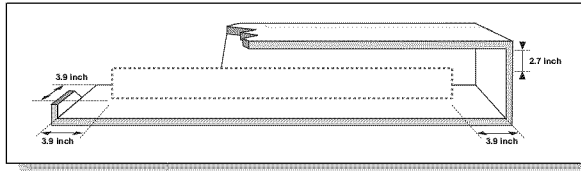

Ensure that the AC power supply in your house complies with the power requirements listed on the identification sticker located on the back of your product. Install your product horizontally, on a suitable base (furniture), with enough space around it for ventilation (3~4 inches). Make sure the ventilation slots are not covered. Do not place the unit on amplifiers or other equipment which may become hot. This unit is designed for continuous use. To fully turn off the unit, disconnect the AC plug from the wall outlet. Unplug the unit if you intend to leave it unused for a long period of time.

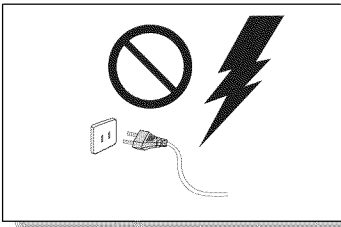

During thunderstorms, disconnect the AC plug from the wall outlet. Voltage peaks due to lightning could damage the unit.

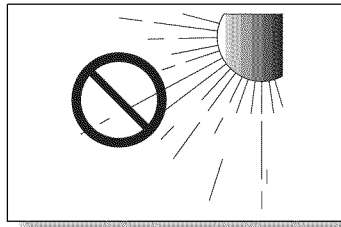

Do not expose the unit to direct sunlight or other heat sources. This could lead to overheating and cause the unit to malfunction.

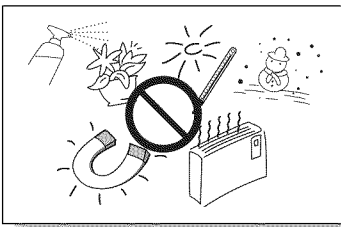

Protect the product from moisture (i.e. vases), and excess heat (e.g. a fireplace) or equipment creating strong magnetic or electric fields. Unplug the power cable from the AC wall socket if the unit malfunctions. Your product is not intended for industrial use. It is for personal use only. Condensation may occur if your product has been stored in cold temperatures. If transporting the unit during the winter, wait approximately 2 hours until the unit has reached room temperature before using.

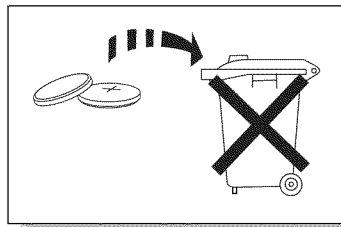

The battery used with this product contains chemicals that are harmful to the environment. Do not dispose of the battery in the general household trash. Do not expose the battery to excess heat, direct sunlight, or fire. Do not short circuit, disassemble, or overheat the battery. Danger of explosion if the battery is replaced incorrectly. Replace only with the same or equivalent type.



**WARNING: DO NOT INGEST BATTERY. CHEMICAL BURN HAZARD.** The remote control supplied with this product contains a coin/button cell battery. If the coin/button cell battery is swallowed, it can cause severe internal burns in just 2 hours and can lead to death. Keep new and used batteries away from children. If the battery compartment does not close securely, stop using the remote and make sure to keep it away from children. If you think the battery might have been swallowed or placed inside any part of the body, seek immediate medical attention.

# CONTENTS

## **2 GETTING STARTED**

- 2 Features
- 3 Safety Information
- 7 What's Included

## **8 DESCRIPTIONS**

- 8 Top / Front Panel
- 9 Rear / Bottom Panel
- 10 Remote Control

## **12 INSTALLATION**

- 12 **Installing the Soundbar**
  - 12 Installing the Wall Mount
  - 16 Attaching the Soundbar to your TV's Stand
  - 18 Installing the Soundbar as a Free-Standing Unit
- 18 **Assembling the Clamp-Wire**

## **19 CONNECTIONS**

- 19 **Connecting the Subwoofer**
- 21 **Connecting to a TV**
  - 21 Connecting to a TV Using an HDMI (Digital) Cable
  - 21 Connecting to a TV Using a Digital Optical Cable
  - 22 TV SoundConnect
- 23 **Connecting to External Devices**
  - 23 HDMI Cable
  - 24 Optical or Analog Audio Cable

## **25 FUNCTIONS**

- 25 Input Mode
- 26 Bluetooth
- 28 Using the Multiroom App
- 29 Using the Network Standby On Function
- 30 Software Update

## **32 TROUBLESHOOTING**

- 32 Troubleshooting

## **33 APPENDIX**

- 33 Specifications



Figures and illustrations in this User Manual are provided for reference only and may differ from actual product appearance.

# WHAT'S INCLUDED

## BEFORE READING THE USER'S MANUAL

Note the following terms before reading the user manual.

### ► Icons used in this manual

| Icon  | Term           | Definition   |
|---|----------------|--|
|  | <b>Caution</b> | Indicates a situation where a function does not operate or settings may be canceled. |
|  | <b>Note</b>    | Indicates tips or instructions on the page that help you operate a function.         |

Check for the supplied accessories shown below.

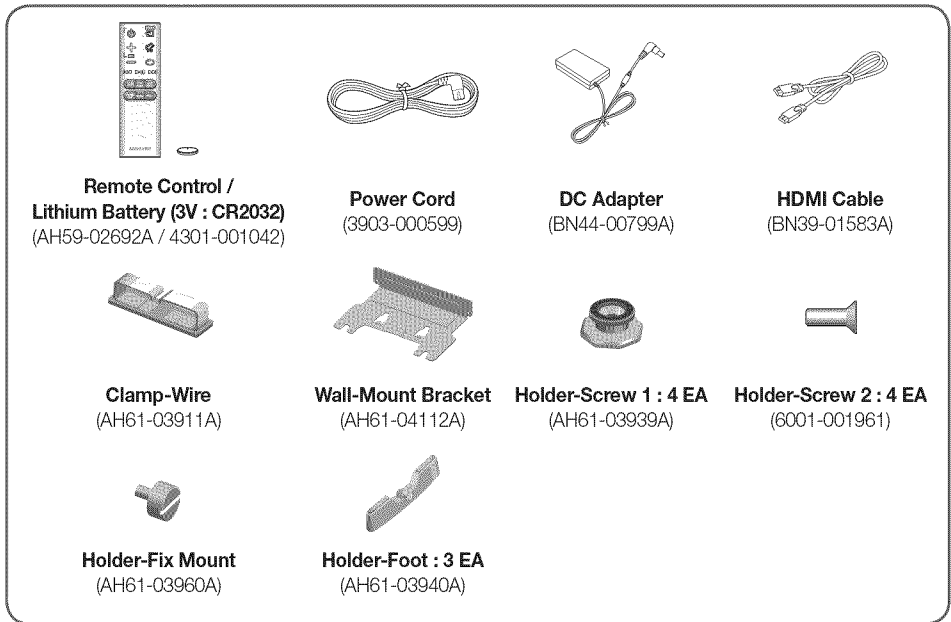

- The appearance of the accessories may differ slightly from the illustrations above.

# TOP / FRONT PANEL

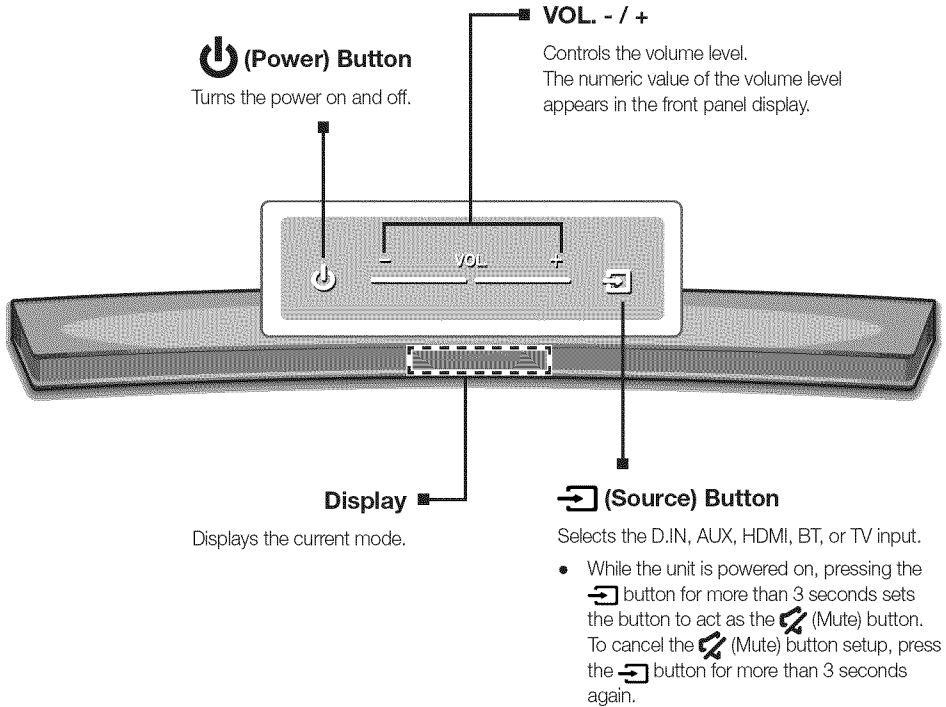

- To clean this apparatus, unplug the power cord from the wall outlet and wipe the product using a soft, dry cloth. Due to aluminum being a positive electrostatic material, static discharge may occur.



- When you plug in the AC cord, the power button will begin working in 4 to 6 seconds.
- When you turn on this unit, there will be a 4 to 5 second delay before it produces sound.
- If you want to enjoy sound only from the Soundbar, you must turn off the TV's speakers in the Audio Setup menu of your TV. Refer to the owner's manual supplied with your TV.



# REAR / BOTTOM PANEL

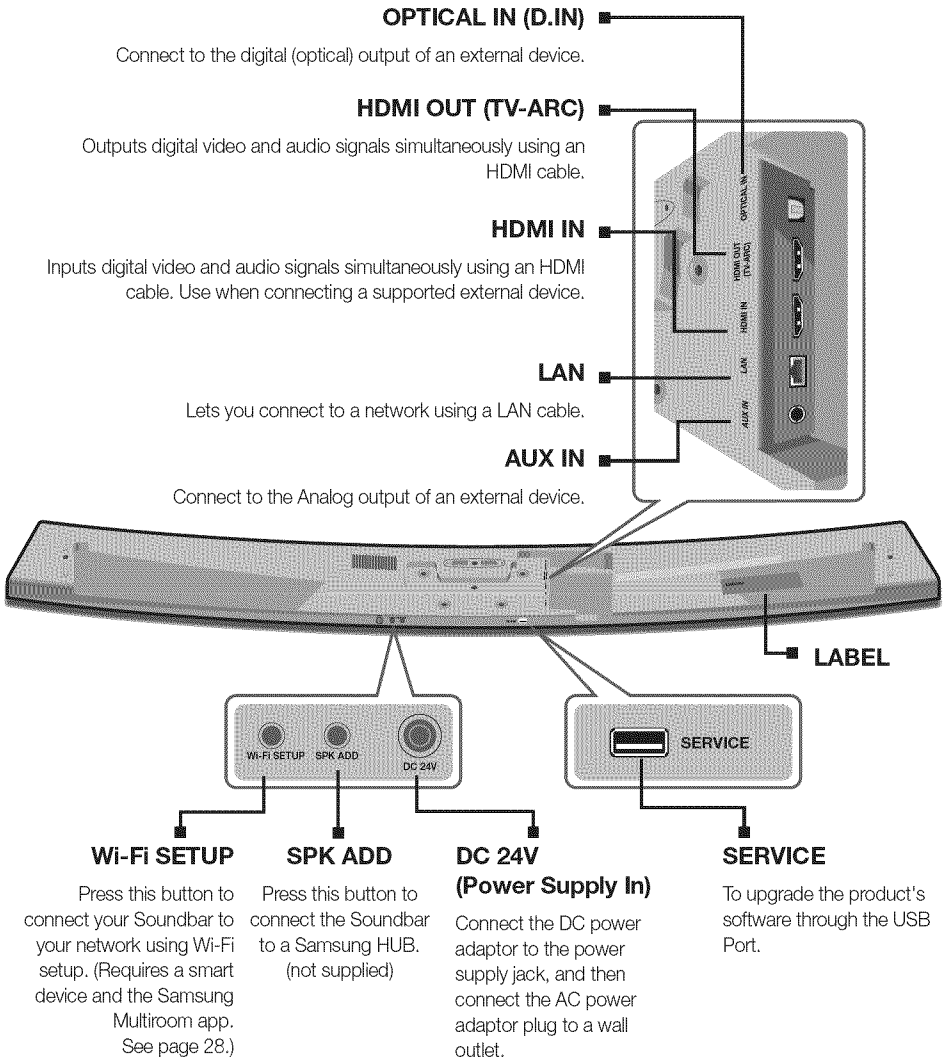

- When disconnecting the power cable of the AC power adaptor from a wall outlet, pull the plug. Do not pull the cable.
- Do not connect this unit or other components to an AC outlet until all connections between components are complete.
- Make sure to rest the AC/DC Adapter flat on a table or the floor. If you place the AC/DC Adapter so that it is hanging with the AC cord input facing upwards, water or other foreign substances could enter the Adapter and cause the Adapter to malfunction.

# REMOTE CONTROL

**SOURCE**  
Press to select a source connected to the Soundbar.

**Mute**  
You can turn the volume down to 0 with the push of a button. Press again to restore the sound to the previous volume level.

**Repeat**  
The Repeat function is available only when playing back music from Songs on phone or DMS of Samsung Multiroom app.  
**OFF - REPEAT** : Cancels Repeat Playback.  
**TRACK - REPEAT** : Plays a track repeatedly.  
**ALL - REPEAT** : Plays all tracks repeatedly.

**Skip Forward**  
If there is more than one file on the device you are playing, and you press the **▶▶** button, the next file is selected.

**SOUND CONTROL**  
Press to select **TREBLE**, **BASS**, or **AUDIO SYNC**. Then, use the **◀◀**, **▶▶** buttons to adjust the **TREBLE** or **BASS** volume from -3 to +3.  
Press and hold the **SOUND CONTROL** button for about 5 seconds to adjust the sound for each frequency band. 150Hz, 300Hz, 600Hz, 1.2KHz, 2.5KHz, 5KHz, and 10KHz are selectable and each can be adjusted to a setting between -6 and +6.  
If the Soundbar is connected to a digital TV and the video appears out of sync with the audio, press the **SOUND CONTROL** button to sync the audio with the video. Use the **◀◀**, **▶▶** buttons to set the audio delay between 0 ms and 300 ms. In TV mode, and BT mode, the Audio Sync function may not be available.

**Anynet+**  
Press the **Anynet+** button to turn the Anynet+ function on or off. (Default : Auto Power Link OFF, **ON - ANYNET+** / **OFF - POWER LINK** or **OFF - ANYNET+** / **ON - POWER LINK**). The Anynet+ function lets you control the Soundbar with the remote from an Anynet+ compatible Samsung TV. The Soundbar must be connected to the TV via an HDMI cable.  
\* Auto Power Link  
Synchronizes the Soundbar to a connected Optical source via the Optical jack so it turns on automatically when you turn on your TV. (See page 22)  
Auto Power Link function is only available in the **D.IN** mode.  
You can also activate **Wi-Fi SETUP** function by pressing and holding **Anynet+** button on the remote for over 7 seconds.



- Soundbar is a Samsung proprietary name.
- Operate the TV using the TV's remote control.

**Power**  
Turns the Soundbar on and off.

**Volume**  
Adjusts the volume level of the unit.

**Play / Pause**  
Press the ►|| button to pause a file temporarily.  
Press the ►|| button again to play the selected file.

**Skip Back**  
If there is more than one file on the device you are playing, and you press the ◀◀ button, the previous file is selected.

**SOUND EFFECT**  
You can select the sound modes - **STANDARD (Original Sound)**, **MUSIC**, **CLEAR VOICE**, **SPORTS**, **MOVIE**, and **NIGHT MODE** - depending on the content you want to listen to.  
Select the **STANDARD** mode if you want to enjoy the original sound.

**((●)) SOUND**  
Surr.Sound adds depth and spaciousness to the sound. Pressing the **((●)) SOUND** button repeatedly cycles through the Surr.Sound settings :  
**ON - SURROUND SOUND, OFF - SURROUND SOUND**

**STREAMING MUSIC**  
Press **STREAMING MUSIC** button to listen to an Internet radio station. Each time you press this button, the Soundbar switches to the next default station, cycling through the 3 default stations.  
To use the **STREAMING MUSIC** function, the Soundbar must be connected to the Internet. (See page 29)

**DRC (Dynamic Range Control) \***  
Lets you apply dynamic range control to Dolby Digital.  
Press and hold the **STREAMING MUSIC** button to toggle the DRC (Dynamic Range Control) function **ON** and **OFF**.

**WOOFER**  
Press the **WOOFER** button. Then, use the ◀◀, ▶▶ buttons to adjust the Subwoofer volume from -12, -6 to +6.  
You can also activate **SPK ADD** function of the soundbar by pressing and holding **WOOFER** button of the remote for over 5 seconds.

## INSTALLING THE BATTERY IN THE REMOTE CONTROL

1. Use a suitable coin to turn the remote control's battery cover counterclockwise to remove it as shown in the figure above.
2. Insert a 3V lithium battery. Keep the positive (+) pole facing up when inserting the battery. Put the battery cover on and align the '+' marks side by side as shown in the figure above.
3. Use a suitable coin to turn the remote control battery cover clockwise as far as it will go to fit in place.

# INSTALLING THE SOUNDBAR

## INSTALLING THE WALL MOUNT

### ► Installation Precautions

- Install on a vertical wall only.
- For the installation, avoid a location with high temperature or humidity, or a wall that cannot sustain the weight of the set.
- Check the strength of the wall. If the wall is not strong enough to support the unit, reinforce the wall or install the unit on a different wall that can support the unit's weight.
- Purchase and use the fixing screws or anchors appropriate for the kind of wall you have (plaster board, iron board, wood, etc.). If possible, fix the support screws into wall studs.
- Purchase wall mounting screws according to the type and thickness of the wall you will mount the Soundbar on.
  - Diameter : M5
  - Length: 1 3/8 inches or longer recommended.
- Connect cables from the unit to external devices before you install it on the wall.
- Make sure the unit is turned off and unplugged before you install it. Otherwise, it may cause an electric shock.

Check for the supplied accessories shown below.



**Holder-Screw 1 : 4 EA**



**Holder-Screw 2 : 4 EA**

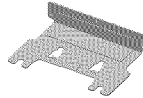

**Wall-Mount Bracket**



**Holder-Fix Mount**

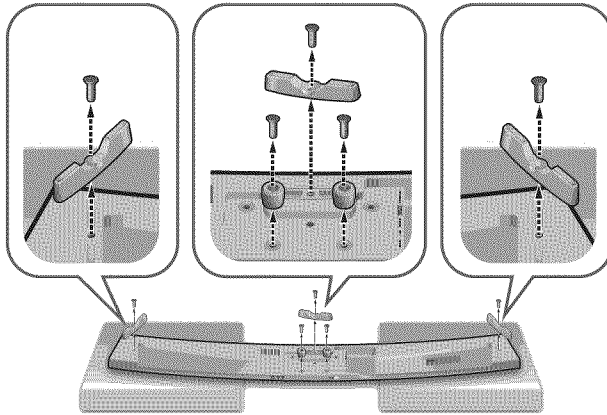

To mount the Soundbar onto the wall, follow these steps:

1. Place the Soundbar as shown in the illustration, ensuring that none of the buttons touch the surface it is lying on. You can use the Soundbar's packaging to support its two ends.
2. If the **Holder-Foot** (3 EA) and **Holder-Support** (2 EA) are attached, remove them.



**Holder-Foot**



**Holder-Support**

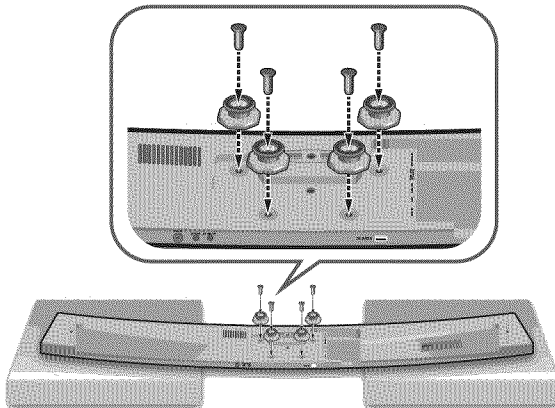

3. Fix **Holder-Screw 1** (4 EA) and **Holder-Screw 2** (for main unit fixing) (4 EA) into the holes of the Soundbar tightly as shown in the illustration.

## INSTALLATION

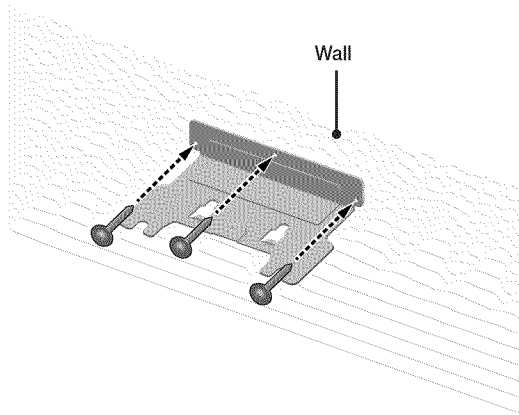

4. Insert the **Wall-Mount Screws** into the 3 holes one by one to fix the **Wall-Mount Bracket** on the wall.



- Recommended screw : M5

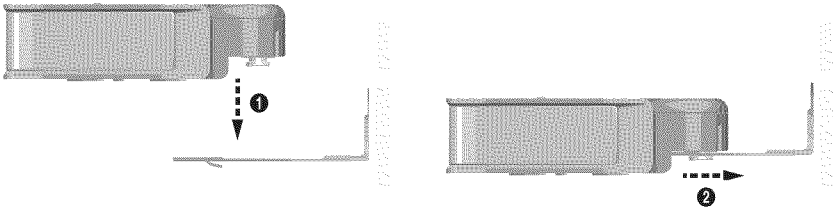

5. Mount the Soundbar on the **Wall-Mount Bracket** in order of the following illustration (1 → 2).

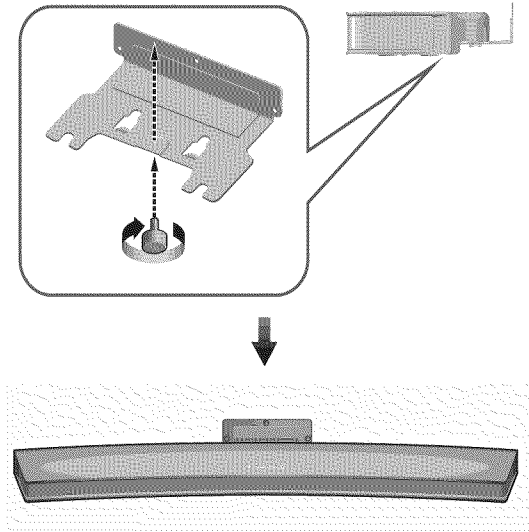

6. Fix the **Holder-Fix Mount** (for wall-mount fixing) to join the **Wall-Mount Bracket** with the Soundbar.



- **Wall-Mount Screws** are not provided.
- Since different types of wall-mount screws are required depending on your wall, you should check your wall before installation and purchase the appropriate wall-mount screws to use.

## ATTACHING THE SOUNDBAR TO YOUR TV'S STAND

You can attach the Soundbar to your TV's stand if you have a Samsung TV that has a stand that is compatible with this Soundbar.



- Please visit the home page of Samsung Electronics ([www.Samsung.com](http://www.Samsung.com)) to see a detailed list of the compatible models.
- You cannot mount this Soundbar on an incompatible TV or attach it to the stand of an incompatible TV.

Check for the supplied accessories shown below.



Holder-Foot : 3EA

Holder-Screw 2 : 3EA

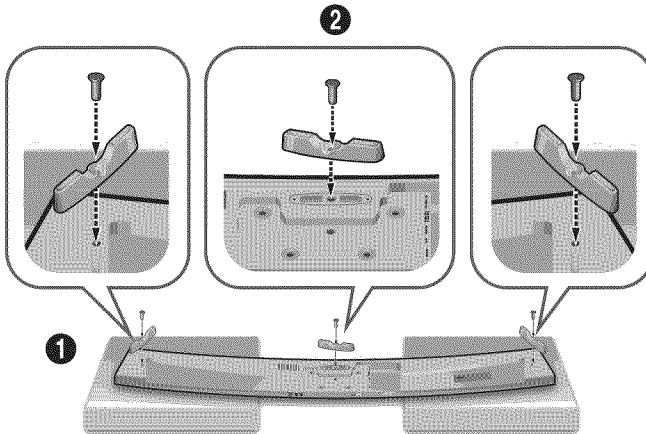

1. Place the Soundbar as shown in the illustration, ensuring that none of the buttons touch the surface it is lying on. You can use the Soundbar's packaging to support its two ends.
2. Attach the **Holder-Foot** (3 pieces) to the Soundbar using 3 **Holder-Screws 2** as shown in the illustration. Tighten the screws firmly.



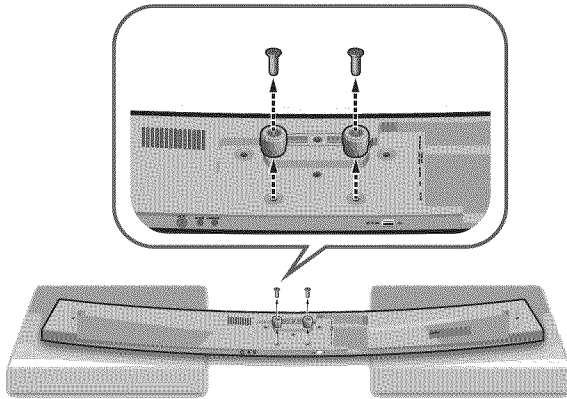

3. Remove **Holder-Support** (2 pieces) from the Soundbar as shown in the illustration.

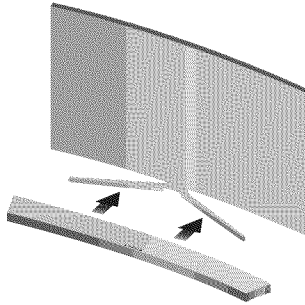

4. Align the Soundbar's center with the center of the base of the TV, and then carefully push it onto the stand as far as it will go, as shown in the illustration. Be careful not to unbalance the TV.

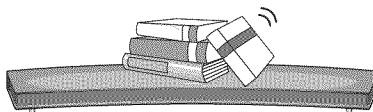

- Do not place heavy items on the main unit. Do not step on the main unit.

## INSTALLING THE SOUNDBAR AS A FREE-STANDING UNIT

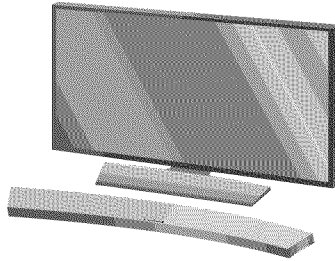

1. Center the Soundbar on the flat area in front of the TV.

## ASSEMBLING THE CLAMP-WIRE

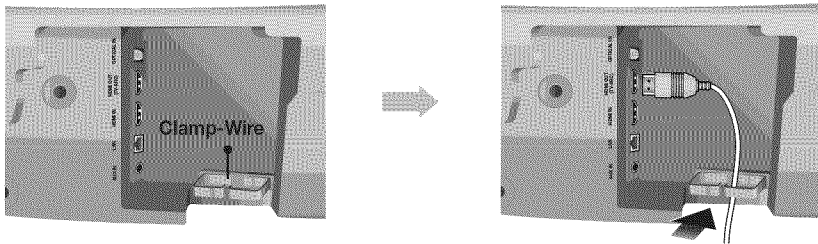

Attach the clamp-wire to the unit as shown, and then run the cables through the clamp-wire to keep them neat.



- Do not connect the power cord of this product or your TV to a wall outlet until all connections between components are complete.
- Before moving or installing this product, be sure to turn off the power and disconnect the power cord.

## CONNECTING THE SUBWOOFER

### CONNECTING TO THE SUBWOOFER AUTOMATICALLY

The Subwoofer's linking ID is preset at the factory and the main unit and subwoofer should link (connect wirelessly) automatically when the main unit and subwoofer are turned on.

- When the subwoofer is completely connected, the blue LED Link Indicator on the subwoofer stops blinking and glows continuously.

### CONNECTING TO THE SUBWOOFER MANUALLY

If the blue LED light does not stop blinking when the main unit and subwoofer are turned on, please set the ID by following the steps below.



- Important: Before you begin, put the battery into the remote. See page 11 for instructions.

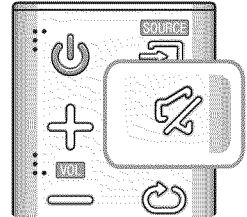
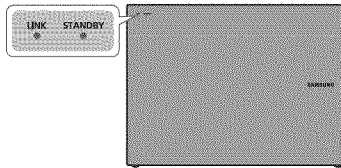
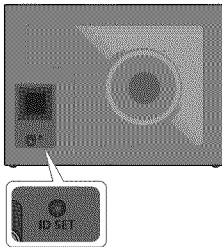

1. Plug the power cords of the main unit and subwoofer into an AC wall outlet.
2. Press the **ID SET** button on the back of the subwoofer with a small, pointed object for 5 seconds.
  - The STANDBY indicator turns off and the LINK indicator (Blue LED) blinks quickly.
3. While the main unit is powered off (in STANDBY mode), press and hold the  (Mute) on the remote control for 5 seconds.
4. The **ID SET** message appears on the Soundbar's display.
5. To finalize the link, turn the main unit's power on while the subwoofer's Blue LED blinks.
  - The main unit and the subwoofer should now be linked (connected).
  - The LINK indicator (Blue LED) on the subwoofer should be glowing continuously and not blinking.
  - If the LINK indicator is not solid blue, the linking process has failed. Turn off the main unit and start again from Step 2.
  - You can enjoy better sound from the wireless subwoofer by selecting a Sound Effect. (See page 11)

## CONNECTIONS

---



- Before moving or installing the product, be sure to turn off the power and disconnect the power cord.
- If the main unit is powered off, the wireless subwoofer will be in standby mode and the STANDBY LED on the front will come on after the LINK indicator (Blue LED) blinks for 30 seconds.
- If you use a device that uses the same frequency (2.4GHz) as the Soundbar near the Soundbar, interference may cause some sound interruption.
- The maximum transmission distance of the wireless signal between the main unit and subwoofer is about 32.8 ft, but may vary depending on your operating environment. If a steel-concrete or metallic wall is between the main unit and the wireless subwoofer, the system may not operate at all, because the wireless signal cannot penetrate metal.
- If the main unit doesn't make a wireless connection, follow steps 1-5 on the previous page to re-set the connection between the main unit and wireless subwoofer.



- The wireless receiving antenna is built into the wireless subwoofer. Keep the unit away from water and moisture.
  - For optimal listening performance, make sure that the area around the wireless subwoofer location is clear of any obstructions.
-

# CONNECTING TO A TV



- Important: Before you begin, put the battery into the remote. See page 11 for instructions.

## CONNECTING TO A TV USING AN HDMI (DIGITAL) CABLE

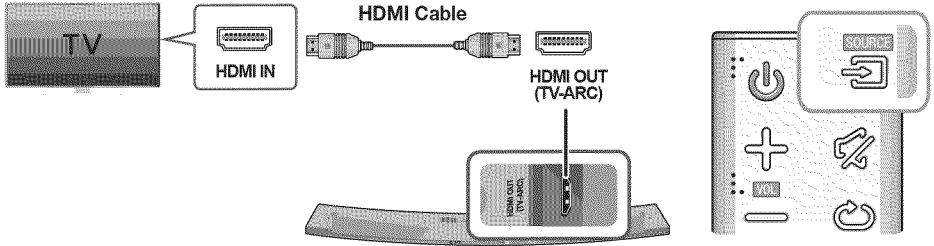



1. Connect an HDMI cable from the **HDMI OUT (TV-ARC)** jack on the back of the product to the HDMI IN jack on your TV.
2. Press the  button on the top panel of the Soundbar or the **SOURCE** button on the remote control to select the **D.IN** mode.

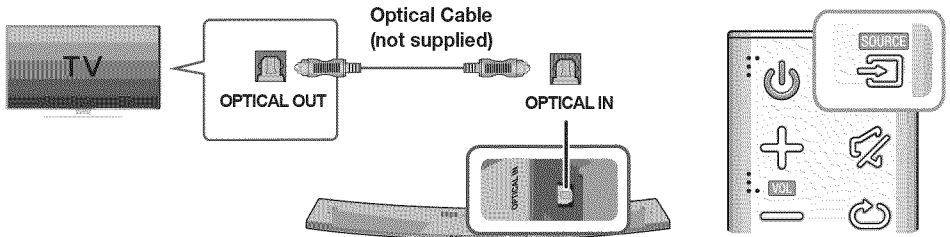

- HDMI is an interface that enables the digital transmission of video and audio data with just a single connector.
- If the TV provides an ARC port, connect the HDMI cable to the HDMI IN (ARC) port.
- We recommend you use a coreless HDMI cable if possible. If you use a cored HDMI cable, use one whose diameter is less than 0.55 inches.
- Anynet+ must be turned on.
- This function is not available if the HDMI cable does not support ARC.

## CONNECTING TO A TV USING A DIGITAL OPTICAL CABLE



1. Connect the **OPTICAL IN (Audio)** jack on the Soundbar to the OPTICAL OUT jack of the TV with a digital optical cable.
2. Press the  button on the top panel of the Soundbar or the **SOURCE** button on the remote control to select the **D.IN** mode.

► **Auto Power Link**

If you have connected the main unit to a TV with a digital optical cable, you can set the Auto Power function ON to have the Soundbar turn on automatically when you turn the TV on.

| AUTO POWER LINK | Display                                |
|-----------------|--|
| ON              | <b>OFF - ANYNET+ / ON - POWER LINK</b> |
| OFF             | <b>ON - ANYNET+ / OFF - POWER LINK</b> |

1. Connect the Soundbar and a TV with a digital optical cable (not supplied).
2. Press the  button on the main unit's top panel or the **SOURCE** button on the remote control to select the **D.IN** mode.
3. Press the **Anynet+** button on the remote control to toggle the Auto Power Link function on and off.



- Depending on the connected device, Auto Power Link may not function.

**TV SOUNDCONNECT**

You can enjoy TV sound through your Soundbar when it is connected to a Samsung TV that supports the TV SoundConnect function.

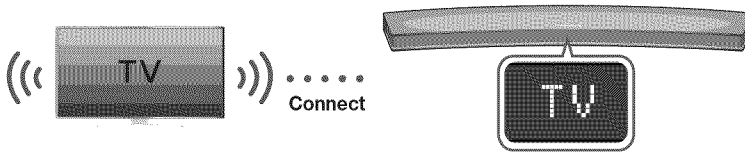

1. Turn on the TV and Soundbar.
2. Press the  button on the main unit's top panel or the **SOURCE** button on the remote control to select the **TV** mode.
3. On the TV, a message asking whether to enable the TV SoundConnect function appears.
4. Select **<Yes>** using the TV's remote control to finish connecting the TV and Soundbar.



- Switching the Soundbar's mode from TV to another mode automatically terminates TV SoundConnect.
- To connect the Soundbar to another TV, the existing connection must be terminated.
- To terminate the existing connection, press and hold the **▶||** button on the remote for 5 seconds or switch to another mode. To connect to the other TV, follow Steps 1 through 4 above.



- The TV SoundConnect (SoundShare) function is supported by some Samsung TVs released from 2012 on. Check whether your TV supports the TV SoundConnect (SoundShare) function before you begin. (For further information, refer to the TV's user manual.)
- If your Samsung TV was released before 2014, check the SoundShare setting menu.
- If the distance between the TV and Soundbar exceeds 32.8 ft, the connection may not be stable or the audio may stutter. If this occurs, relocate the TV or Soundbar so that they are within operational range, and then re-establish the TV SoundConnect connection.
- TV SoundConnect Operational Ranges:
  - Recommended pairing range: within 78.7 inches (within 2m).
  - Recommended operational range: within 32.8 ft. (10m).
- The Play/Pause, Next, and Prev buttons on the Soundbar or Soundbar's remote do not control the TV.

# CONNECTING TO EXTERNAL DEVICES

## HDMI CABLE

HDMI is the standard digital interface for connecting to TVs, projectors, DVD players, Blu-ray players, set top boxes, and more.

HDMI prevents any degradation to the signal due to conversion to analog and maintains the video and audio quality of the original digital source.

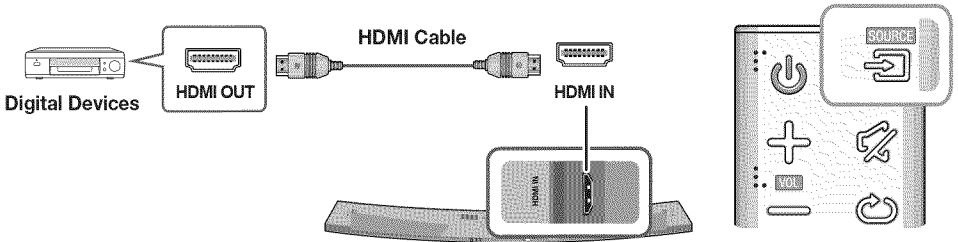

1. Connect an HDMI cable from the **HDMI IN** jack on the back of the product to the HDMI OUT jack on your digital device.
2. Press the  button on the top panel of the Soundbar or the **SOURCE** button on the remote control to select the **HDMI** mode.

## OPTICAL OR ANALOG AUDIO CABLE

This unit comes equipped with one digital optical in jack and one analog audio (AUX) in jack, giving you two ways to connect it to external devices.

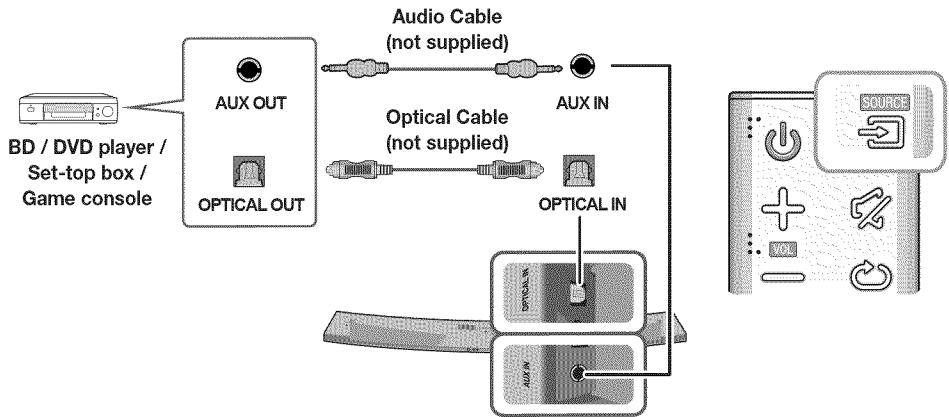

### ► AUX Cable

1. Connect **AUX IN** (Audio) on the main unit to the AUDIO OUT jack of the Source Device using an audio cable.
2. Press the  button on the top panel of the Soundbar or the **SOURCE** button on the remote control to select the **AUX** mode.

### ► Optical Cable

1. Connect **OPTICAL IN** (Audio) on the main unit to the OPTICAL OUT jack of the Source Device using a digital optical cable.
2. Press the  button on the top panel of the Soundbar or the **SOURCE** button on the remote control to select the **D.IN** mode.



# INPUT MODE

Press the  button on the main unit's top panel or the **SOURCE** button on the remote control to select the mode you want.

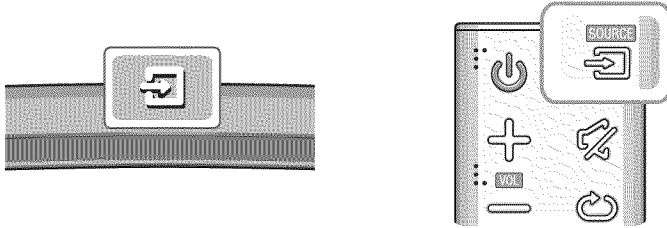

| Input mode                                    | Display     |
|---|-------------|
| Optical Digital input<br>ARC (HDMI OUT) input | <b>D.IN</b> |
| AUX input                                     | <b>AUX</b>  |
| HDMI input                                    | <b>HDMI</b> |
| BLUETOOTH mode                                | <b>BT</b>   |
| TV SoundConnect                               | <b>TV</b>   |

## AUTO POWER DOWN FUNCTION

The unit turns off automatically in the following situations.

- D.IN / HDMI / BT / TV / ARC Mode
  - If there is no audio signal for 15 minutes.
- AUX Mode
  - If the AUX cable is disconnected for 15 minutes.
  - If there is no KEY input for 8 hours when the AUX cable is connected.

To turn the Auto Power Down function ON or OFF, press and hold the  button for 5 seconds.  
**ON - AUTO POWER DOWN / OFF - AUTO POWER DOWN** appears on the display.

# BLUETOOTH

You can connect a Bluetooth device to the Soundbar and enjoy music with high quality stereo sound, all without wires!

## TO CONNECT THE SOUNDBAR TO A BLUETOOTH DEVICE

Check if the Bluetooth device supports the Bluetooth compliant stereo headset function.

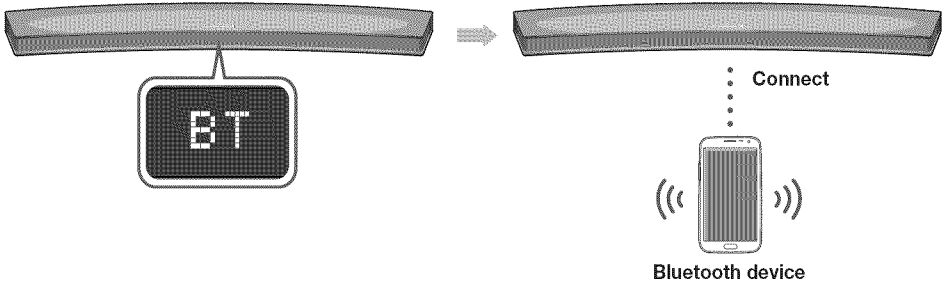

1. Press the  button on the main unit's top panel or the **SOURCE** button on the remote control to select the **BT** mode.
  - You will see **BT READY** on the front display of the Soundbar.
2. Select the Bluetooth menu on the Bluetooth device you want to connect. (Refer to the Bluetooth device's user manual.)
3. Select "[Samsung] HW-Jxxxx" from the list.
  - When the Soundbar is connected to the Bluetooth device, it will display **[Bluetooth device name] → BT** on the front display.
  - The device name can only be displayed in English. An underline " \_ " will be displayed if the name is not in English.
  - If the Bluetooth device has failed to pair with the Soundbar, delete the previous "[Samsung] HW-Jxxxx" found by the Bluetooth device and have it search for the Soundbar again.
4. Play music on the connected device.
  - You can listen to the music playing on the connected Bluetooth device over the Soundbar.
  - In **BT** mode, the Play / Pause / Next / Prev functions are not available. However, these functions are available on Bluetooth devices supporting AVRCP.



- If asked for a PIN code when connecting a Bluetooth device, enter <0000>.
- Only one Bluetooth device can be paired at a time.
- The Bluetooth connection will be terminated when you turn the Soundbar off.
- The Soundbar may not perform Bluetooth search or connection correctly under the following circumstances:
  - If there is a strong electrical field around the Soundbar.
  - If several Bluetooth devices are simultaneously paired with the Soundbar.
  - If the Bluetooth device is turned off, not in place, or malfunctions.
- Note that such devices as microwave ovens, wireless LAN adaptors, fluorescent lights, and gas stoves use the same frequency range as the Bluetooth device, which can cause electric interference.

- The Soundbar supports SBC data (44.1kHz, 48kHz).
- Connect only to a Bluetooth device that supports the A2DP (AV) function.
- You cannot connect the Soundbar to a Bluetooth device that supports only the HF (Hands Free) function.
- Once you have paired the Soundbar to a Bluetooth device, selecting "[Samsung] HW-Jxxxx" from the device's scanned devices list will automatically change the Soundbar to **BT** mode.
  - Available only if the Soundbar is listed among the Bluetooth device's paired devices. (The Bluetooth device and the Soundbar must have been previously paired at least once.)
- Soundbar will appear in the Bluetooth device's searched devices list only when the Soundbar is displaying **BT READY**.
- In the TV SoundConnect mode, the Soundbar cannot be paired to another Bluetooth device.

## TO DISCONNECT THE BLUETOOTH DEVICE FROM A SOUNDBAR

You can disconnect a Bluetooth device from the Soundbar. For instructions, see the Bluetooth device's user manual.

- The Soundbar will be disconnected.
- When the Soundbar is disconnected from the Bluetooth device, the Soundbar will display **BT DISCONNECTED** on the front display.

## TO DISCONNECT THE SOUNDBAR FROM A BLUETOOTH DEVICE

Press the **SOURCE** button on the remote control or the  button on the product's top panel to switch from **BT** to another mode or turn off the Soundbar.

- The connected Bluetooth device will wait a certain amount of time for a response from the Soundbar before terminating the connection. (Disconnection time may differ, depending on the Bluetooth device)



- In Bluetooth connection mode, the Bluetooth connection will be lost if the distance between the Soundbar and the Bluetooth device exceeds 32.8 ft.
- The Soundbar automatically turns off after 15 minutes in the Ready state.

### ► More About Bluetooth

Bluetooth is a technology that enables Bluetooth-compliant devices to interconnect easily with each other using a short wireless connection.

- A Bluetooth device may cause noise or malfunction, depending on usage, if:
  - A part of your body is in contact with the receiving/transmitting system of the Bluetooth device or the Soundbar.
  - It is subject to electrical variation from obstructions caused by a wall, corner, or office partition.
  - It is exposed to electrical interference from same frequency-band devices including medical equipment, microwave ovens, and wireless LANs.
- Pair the Soundbar with the Bluetooth device while they are close together.
- The further the distance between the Soundbar and Bluetooth device, the worse the quality is. If the distance exceeds the Bluetooth operational range, the connection is lost.
- In poor reception areas, the Bluetooth connection may not work properly.
- The Bluetooth connection only works when it is close to the unit. The connection will be automatically cut off if the Bluetooth device is out of range. Even within range, the sound quality may be degraded by obstacles such as walls or doors.
- This wireless device may cause electric interference during its operation.

# USING THE MULTIROOM APP

The Samsung Multiroom app lets you connect the Soundbar to a smart device, your network, and the Internet. Once the Soundbar is connected to a smart device that has the Multiroom App installed, you can also connect the Soundbar and multiple Samsung Multiroom devices together wirelessly and play audio through them.

## BEFORE YOU BEGIN

### ► Communication Basics

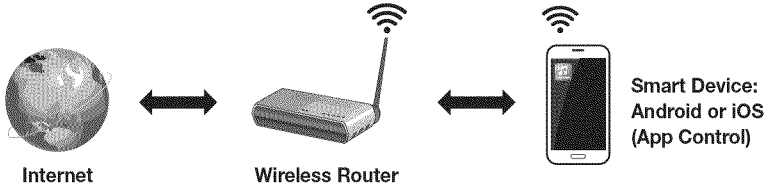

#### Requirements:

1. A Wireless Router and a Smart Device.
2. The wireless router must be connected to the Internet.
3. The smart device must be connected to the router via a Wi-Fi connection.

## INSTALLING THE SAMSUNG MULTIROOM APP

To use the Soundbar with the Samsung Multiroom App, you must download and then install the Samsung Multiroom App on your smart device. You can download the app from Google Play or the App Store. With the Samsung Multiroom App installed, you can play music on your Soundbar that is stored on your smart device, located on other connected devices, provided by other content providers, or streamed from Internet radio stations.

### ► Android or iOS

Download the Samsung Multiroom app from Google Play or the App Store of your smart device.

\* Market search : Samsung Multiroom



or



## ► Launching the Samsung Multiroom App

To launch the Samsung Multiroom app, tap the Multiroom app icon on your smart device.

## CONNECTING THE SOUNDBAR TO YOUR NETWORK

On your smart device, select the Samsung Multiroom app. Follow the directions on your smart device's screen.



- Use Cat 7 (\*STP Type) cable for the connection.  
\* Shielded Twist Pair

## USING THE NETWORK STANDBY ON FUNCTION

The Network Standby On function becomes available if a wireless connection has been properly established between a smart device and the Soundbar. This function turns on the Soundbar automatically when a smart device attempts to connect to the Soundbar via Bluetooth or Wi-Fi. If you turn the Soundbar on via a Bluetooth connection, its input mode is set to BT automatically. To turn the Soundbar on via Wi-Fi, you must have the Samsung Multiroom App installed on your smart device.

1. Connect the smart device to your Soundbar.
2. Turn the Network Standby On function on by pressing the ►►| button on the Soundbar remote for more than 5 seconds. You can turn the function off by pressing the ►►| button again for more than 5 seconds.



- Network Standby On is available only if the Soundbar is listed among the smart device's paired devices. (The Smart device and the Soundbar must have been previously paired at least once.)
- Soundbar will appear in the smart device's searched devices list only when the Soundbar is displaying [BT READY] or [WiFi READY].
- In the TV SoundConnect mode, the Soundbar cannot be paired to another smart device.
- If the Network Standby On function did not work:
  - The Network Standby On is set to Off. Set it to ON.
- The Wi-Fi connection to the Soundbar will be terminated if the Soundbar's power cord is disconnected or the power is cut off. If the power is cut off, turn on the Soundbar and reconnect it.

# SOFTWARE UPDATE

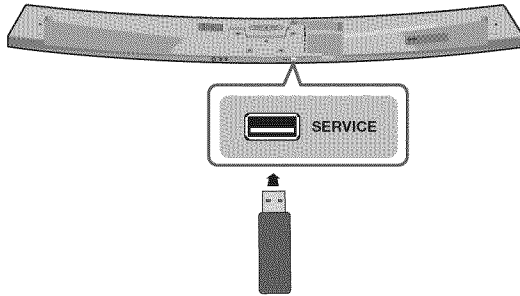

## UPDATING WITH USB

Samsung may offer updates for the Soundbar's system firmware in the future.

If an update is offered, you can update the firmware by connecting a USB device with the firmware update stored on it to the USB port on your Soundbar.

Note that if there are multiple update files, you must load them onto the USB device singly and use them to update the firmware one file at a time.

Please visit [samsung.com](http://samsung.com) or contact the Samsung call center to receive more information about downloading update files.

### ► Updating Procedure

1. While the Soundbar is turned off, connect the USB storage device that contains the updating firmware to the Soundbar's USB port.
2. Disconnect the power cord, reconnect it, and then turn on the Soundbar.
3. Turn on the Soundbar. **UPDATE** appears on the display and updating begins within 3 minutes.
  - When the update is complete, the Soundbar turns off and on automatically.

### ► If UPDATE was not displayed

1. Turn off the Soundbar, connect the USB storage device that contains update files to the Soundbar's USB port.
2. Disconnect the power cord, reconnect it, and then turn on the Soundbar.



- Insert a USB device containing the firmware update into the USB port on the main unit.
- Updating firmware may not work properly if audio files supported by the Soundbar are stored in the USB storage device.
- Do not disconnect the power or remove the USB device while updates are being applied. The main unit will turn off automatically after completing the firmware update.

- After the update, all settings are reset to their factory default settings. We recommend you write down your settings so that you can easily reset them after the update. Note that updating firmware resets the subwoofer connection too.  
If the connection to the subwoofer is not re-established automatically after the update, refer to page 19. If the firmware fails to update, we recommend formatting the USB device in FAT16 and trying again.
- Do not format the USB device in the NTFS format. The Soundbar does not support the NTFS file system.
- Depending on the manufacturer, some USB devices may not be supported.

---

## AUTO UPDATE

If the Soundbar is connected to the Internet, it will automatically check for the latest firmware and update when new firmware becomes available, even if it is turned off.



- The Soundbar is configured to run Auto Update by default.
  - To use the Auto Update function, the Soundbar must be connected to the Internet.
  - The Wi-Fi connection to the Soundbar will be terminated if its power cord is disconnected or the power is cut off. If the power is cut off, turn on the Soundbar and reconnect it.
-

# TROUBLESHOOTING

Refer to the table below if this product does not function properly. If the problem you are experiencing is not listed below or if the instructions below do not help, turn off the product, disconnect the power cord, and contact Samsung Electronics at 1-800-SAMSUNG (1-800-726-7864).

## The unit will not turn on.

- |  |   |
|--|---|
| • Is the power cord plugged into the outlet? | → Connect the power plug to the outlet. |
|--|---|

## A function does not work when the button is pressed.

- |   |   |
|---|---|
| • Is there static electricity in the air? | → Disconnect the power plug and connect it again. |
|---|---|

## Sound is not produced.

- |                                 |  |
|---------------------------------|--|
| • Is the Mute function on?      | → Press the  (Mute) button to cancel the Mute function. |
| • Is the volume set to minimum? | → Adjust the volume.   |

## The remote control does not work.

- |   |                               |
|---|-------------------------------|
| • Are the batteries drained?  | → Replace with new batteries. |
| • Is the distance between the remote control and main unit too far? | → Move closer to the unit.    |

## The TV SoundConnect (TV pairing) failed.

- |   |   |
|---|---|
| • Does your TV support TV SoundConnect?   | → TV SoundConnect is supported by some Samsung TVs released from 2012 on. Check your TV to see if it supports TV SoundConnect.  |
| • Is your TV firmware the latest version? | → Update your TV with the latest firmware.  |
| • Does an error occur when connecting?    | → Contact the Samsung Call Center.<br>→ Reset TV SoundConnect and connect again.<br>To reset the TV SoundConnect connection, press and hold the  button for 5 seconds. |

## The red LED on the subwoofer blinks and the subwoofer is not producing sound.

- |  |   |
|--|---|
| • Your subwoofer may not be connected to the main unit of the product. | → Try to connect your subwoofer again.<br>(See Page 19) |
|--|---|

## The subwoofer drones and vibrates noticeably.

- |  |  |
|--|--|
| • Try to adjust the vibration of your subwoofer. | → Press the <b>WOOFER</b> button on your remote control to adjust the subwoofer's volume level (between -12, -6 ~ +6). |
|--|--|



# SPECIFICATIONS

|                   |                                    |  |                                      |
|-------------------|------------------------------------|--|--------------------------------------|
| <b>Model name</b> |                                    | HW-J7500R / HW-J7501R                      |                                      |
| <b>GENERAL</b>    | <b>Weight</b>                      | <b>Main Unit</b>                           | 8.8 lbs                              |
|                   |                                    | <b>Subwoofer (PS-WJ7500R / PS-WJ7501R)</b> | 15.0 lbs                             |
|                   | <b>Dimensions (W x H x D)</b>      | <b>Main Unit</b>                           | 48.4 x 1.9 x 6.7 inches              |
|                   |                                    | <b>Subwoofer (PS-WJ7500R / PS-WJ7501R)</b> | 17.8 x 13.2 x 6.1 inches             |
|                   | <b>Operating Temperature Range</b> |  | +41°F to +95°F                       |
|                   | <b>Operating Humidity Range</b>    |  | 10 % to 75 %                         |
| <b>AMPLIFIER</b>  | <b>Rated Output Power</b>          | <b>Main Unit</b>                           | 20W x 8, 8 ohm, THD $\leq$ 10%, 1KHz |
|                   |                                    | <b>Subwoofer (PS-WJ7500R / PS-WJ7501R)</b> | 160W, 3 ohm, THD $\leq$ 10%, 100Hz   |

- \* Design, specifications and App screen are subject to change without prior notice.
- \* Distortion, and usable sensitivity are based on measurements using AES (Audio Engineering Society) guidelines.
- \* Nominal specification
  - Samsung Electronics Co., Ltd reserves the right to change the specifications without notice.
  - Weight and dimensions are approximate.
  - For more information about the power supply and power consumption, refer to the label attached to the product.
  - Dispose unwanted electronics through an approved recycler. To find the nearest recycling location, go to our website: [www.samsung.com/recyclingdirect](http://www.samsung.com/recyclingdirect) or call (877) 278 - 0799.

## ※ Open Source License Notice

- To send inquiries and requests regarding open sources, contact Samsung via Email ([oss.request@samsung.com](mailto:oss.request@samsung.com)).

## ※ Spotify License

- The Spotify Software is subject to third party licenses found here : [www.spotify.com/connect/third-party-licenses](http://www.spotify.com/connect/third-party-licenses).
- For more information about Spotify Connect, please visit [www.spotify.com/connect](http://www.spotify.com/connect)

## ※ Important Note About Service

- An administration fee may be charged if either:
  - a. An engineer is called out to your home at your request and there is no defect in the product.
  - b. You bring the unit to a repair center and there is no defect in the product.
- You will be advised of the amount of the administration fee before any work is done or a home visit is made.
- If you have a problem with this product, we strongly recommend you read the appropriate section of this manual, review the Troubleshooting section on page 32, visit the Support page for your product at [www.samsung.com](http://www.samsung.com), or call Samsung Product Support (1-800-726-7864) to find an answer before you contact a service center for a repair.

# WARRANTY

## LIMITED WARRANTY TO ORIGINAL PURCHASER

This SAMSUNG brand product, as supplied and distributed by Samsung Electronics America, Inc. (SAMSUNG) and delivered new, in the original carton to the original consumer purchaser, is warranted by SAMSUNG against manufacturing defects in materials and workmanship for a limited warranty period of:

**One (1) Year Parts and Labor\***  
**(\*90 Days Parts and Labor for Commercial Use)**

This limited warranty begins on the original date of purchase, and is valid only on products purchased and used in the United States. To receive warranty service, the purchaser must contact SAMSUNG for problem determination and service procedures. Warranty service can only be performed by a SAMSUNG authorized service center. The original dated bill of sale must be presented upon request as proof of purchase to SAMSUNG or SAMSUNG's authorized service center. Transportation of the product to and from the service center is the responsibility of the purchaser.

SAMSUNG will repair or replace this product, at our option and at no charge as stipulated herein, with new or reconditioned parts or products if found to be defective during the limited warranty period specified above. All replaced parts and products become the property of SAMSUNG and must be returned to SAMSUNG. Replacement parts and products assume the remaining original warranty, or ninety (90) days, whichever is longer.

SAMSUNG's obligations with respect to software products distributed by SAMSUNG under the SAMSUNG brand name are set forth in the applicable end user license agreement. Non-SAMSUNG hardware and software products, if provided, are on an "AS IS" basis. Non-SAMSUNG manufacturers, suppliers, publishers, and service providers may provide their own warranties.

This limited warranty covers manufacturing defects in materials and workmanship encountered in normal, and except to the extent otherwise expressly provided for in this statement, noncommercial use of this product, and shall not apply to the following, including, but not limited to: damage which occurs in shipment; delivery and installation; applications and uses for which this product was not intended; altered product or serial numbers; cosmetic damage or exterior finish; accidents, abuse, neglect, fire, water, lightning or other acts of nature; use of products, equipment, systems, utilities, services, parts, supplies, accessories, applications, installations, repairs, external wiring or connectors not supplied and authorized by SAMSUNG, or which damage this product or result in service problems; incorrect electrical line voltage, fluctuations and surges; customer adjustments and failure to follow operating instructions, cleaning, maintenance and environmental instructions that are covered and prescribed in the instruction book; product removal or reinstallation; reception problems and distortion related to noise, echo, interference or other signal transmission and delivery problems. SAMSUNG does not warrant uninterrupted or error-free operation of the product.

THERE ARE NO EXPRESS WARRANTIES OTHER THAN THOSE LISTED AND DESCRIBED ABOVE, AND NO WARRANTIES WHETHER EXPRESS OR IMPLIED, INCLUDING, BUT NOT LIMITED TO, ANY IMPLIED WARRANTIES OF MERCHANTABILITY OR FITNESS FOR A PARTICULAR PURPOSE, SHALL APPLY AFTER THE EXPRESS WARRANTY PERIODS STATED ABOVE, AND NO OTHER EXPRESS WARRANTY OR GUARANTEE GIVEN BY ANY PERSON, FIRM OR CORPORATION WITH RESPECT TO THIS PRODUCT SHALL BE BINDING ON SAMSUNG. SAMSUNG SHALL NOT BE LIABLE FOR LOSS OF REVENUE OR PROFITS, FAILURE TO REALIZE SAVINGS OR OTHER BENEFITS, OR ANY OTHER SPECIAL, INCIDENTAL OR CONSEQUENTIAL DAMAGES CAUSED BY THE USE, MISUSE OR INABILITY TO USE THIS PRODUCT, REGARDLESS OF THE LEGAL THEORY ON WHICH THE CLAIM IS BASED, AND EVEN IF SAMSUNG HAS BEEN ADVISED OF THE POSSIBILITY OF SUCH DAMAGES. NOR SHALL RECOVERY OF ANY KIND AGAINST SAMSUNG BE GREATER IN AMOUNT THAN THE PURCHASE PRICE OF THE PRODUCT SOLD BY SAMSUNG AND CAUSING THE ALLEGED DAMAGE. WITHOUT LIMITING THE FOREGOING, PURCHASER ASSUMES ALL RISK AND LIABILITY FOR LOSS, DAMAGE OR INJURY TO PURCHASER AND PURCHASER'S PROPERTY AND TO OTHERS AND THEIR PROPERTY ARISING OUT OF THE USE, MISUSE OR INABILITY TO USE THIS PRODUCT SOLD BY SAMSUNG NOT CAUSED DIRECTLY BY THE NEGLIGENCE OF SAMSUNG. THIS LIMITED WARRANTY SHALL NOT EXTEND TO ANYONE OTHER THAN THE ORIGINAL PURCHASER OF THIS PRODUCT, IS NONTRANSFERABLE AND STATES YOUR EXCLUSIVE REMEDY.

The benefits of this Limited Warranty extend only to the original purchaser of Samsung products from an authorized Samsung reseller. THIS LIMITED WARRANTY SHALL NOT APPLY TO ANY SAMSUNG PRODUCTS PURCHASED FROM UNAUTHORIZED RESELLERS OR RETAILERS, EXCEPT IN STATES WHERE SUCH RESTRICTION MAY BE PROHIBITED. For a list of Samsung authorized retailers, please go to: [http://www.samsung.com/us/peaceofmind/authorized\\_resellers.html](http://www.samsung.com/us/peaceofmind/authorized_resellers.html)

Some states do not allow limitations on how long an implied warranty lasts, or the exclusion or limitation of incidental or consequential damages, so the above limitations or exclusions may not apply to you. This warranty gives you specific legal rights, and you may also have other rights which vary from state to state.

To obtain warranty hardware service, please contact SAMSUNG customer care center.

# SAMSUNG

The party responsible for product compliance:

Samsung Electronics Co., LTD.

America QA lab of Samsung

19 Chapin Rd. Building D,

Pine Brook New Jersey 07058

## QUESTIONS OR COMMENTS?

| COUNTRY | CALL                              | OR VISIT US ONLINE AT  | WRITE  |
|---------|-----------------------------------|--|--|
| U.S.A   | 1-800-SAMSUNG<br>(1-800-726-7864) | <a href="http://www.samsung.com/us/support">www.samsung.com/us/support</a> | Samsung Electronics America, Inc.<br>85 Challenger Road<br>Ridgefield Park, NJ 07660 |