

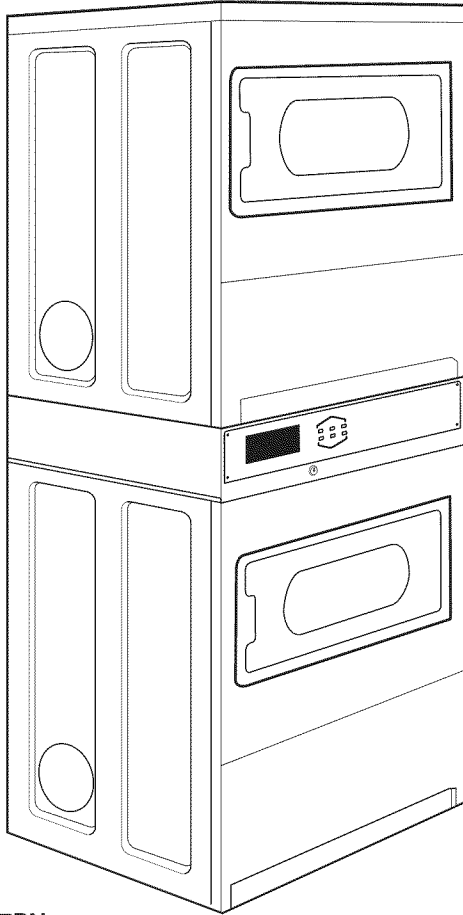

# INSTALLATION INSTRUCTIONS

COMMERCIAL DRYER  
GAS



MLG27PN  
MLG27PD

## TABLE OF CONTENTS

	Page
Dryer Safety .....	3
Dryer Disposal .....	6
Tools & Parts .....	7
Dimensions/Clearances .....	8
Installation Requirements .....	9
Venting Requirements .....	12
Gas Supply Requirements .....	14
Installing Leveling Legs .....	15
Leveling .....	16
Complete Installation .....	17
Reversing Door Swing (optional) .....	18
Maintenance Instructions .....	19
If You Need Assistance .....	19
Technical Specifications – Gas Dryer .....	20
Electronic Control Setup Instructions .....	21
Warranty .....	26

## Your safety and the safety of others are very important.

We have provided many important safety messages in this manual and on your appliance. Always read and obey all safety messages.



This is the safety alert symbol.

This symbol alerts you to potential hazards that can kill or hurt you and others.

All safety messages will follow the safety alert symbol and either the word “DANGER” or “WARNING.”

These words mean:

**! DANGER**

You can be killed or seriously injured if you don't immediately follow instructions.

**! WARNING**

You can be killed or seriously injured if you don't follow instructions.

All safety messages will tell you what the potential hazard is, tell you how to reduce the chance of injury, and tell you what can happen if the instructions are not followed.



## **WARNING - “Risk of Fire”**

- Clothes dryer installation must be performed by a qualified installer.
- Install the clothes dryer according to the manufacturer's instructions and local codes.
- Do not install a clothes dryer with flexible plastic venting materials or flexible metal (foil type) duct. If flexible metal duct is installed, it must be of a specific type identified by the appliance manufacturer as suitable for use with clothes dryers. Flexible venting materials are known to collapse, be easily crushed, and trap lint. These conditions will obstruct clothes dryer airflow and increase the risk of fire.
- To reduce the risk of severe injury or death, follow all installation instructions.
- Save these instructions.

- It is recommended that the owner post, in a prominent location, instructions for the customer's use in the event the customer smells gas. This information should be obtained from your gas supplier.
- Post the following warning in a prominent location.



## **CAUTION – RISK OF FIRE/FLAMMABLE MATERIALS**

This is an additional safety alert symbol that alerts you to the risk of fire.

### FOR YOUR SAFETY

1. DO NOT USE OR STORE PETROL OR OTHER FLAMMABLE MATERIALS IN THIS APPLIANCE OR NEAR THIS APPLIANCE.
2. DO NOT SPRAY AEROSOLS IN THE VICINITY OF THIS APPLIANCE WHILE IT IS IN OPERATION.
3. DO NOT MODIFY THIS APPLIANCE.

## DRYER SAFETY

---

**WARNING:** For your safety, the information in this manual must be followed to minimize the risk of fire or explosion, or to prevent property damage, personal injury, or death.

- Do not store or use petrol or other flammable vapors and liquids in the vicinity of this or any other appliance.
- **WHAT TO DO IF YOU SMELL GAS:**
  - Do not try to light any appliance.
  - Do not touch any electrical switch; do not use any phone in your building.
  - Clear the room, building, or area of all occupants.
  - Immediately call your gas supplier from a neighbor's phone. Follow the gas supplier's instructions.
  - If you cannot reach your gas supplier, call the fire department.
- Installation and service must be performed by a qualified installer, service agency, or the gas supplier.

**WARNING:** Gas leaks cannot always be detected by smell.

For more information, contact your gas supplier.

If a gas leak is detected, follow the "What to do if you smell gas" instructions.

## IMPORTANT SAFETY INSTRUCTIONS

**WARNING:** To reduce the risk of fire, electric shock, or injury to persons when using the dryer, follow basic precautions, including the following:

- Read all instructions before using the dryer.
- This dryer is intended only for drying clothes and textiles that have been washed in water. Do not use for any other purpose.
- **WARNING:** If you smell gas, do not use the dryer or any electrical equipment nearby. Warn other people to clear the area. Contact the dryer owner immediately.
- Do not place items exposed to cooking oils in your dryer. Items contaminated with cooking oils may contribute to a chemical reaction that could cause a load to catch fire.
- If it is unavoidable that fabrics that contain vegetable or cooking oil or that have been contaminated by hair care products be placed in a tumble dryer, they should first be washed in hot water with extra detergent – this will reduce, but not eliminate the hazard.
- Do not dry articles that have been previously cleaned in, washed in, soaked in, or spotted with petrol, dry-cleaning solvents, other flammable, or explosive substances as they give off vapors that could ignite or explode.
- Items that have been soiled with substances such as acetone, alcohol, petrol, kerosene, spot removers, turpentine, waxes, and wax removers should be washed in hot water with extra detergent before being dried in the dryer.
- Do not dry unwashed items in the dryer.
- Do not use this dryer if industrial chemicals have been used for cleaning. The possible presence of residual quantities of aggressive or decomposed chemicals in the load may produce damage to the dryer and harmful fumes.
- Do not allow children to play on or in the dryer. Close supervision of children is necessary when the dryer is used near children.
- This dryer is not intended for use by persons (including children) with reduced physical, sensory, or mental capabilities, or lack of experience or knowledge, unless they have been given supervision or instruction concerning use of the dryer by a person responsible for their safety.
- Before the dryer is removed from service or discarded, remove the door to the dryer compartment.
- Do not reach into the dryer if the drum is moving.
- Opening the dryer door will stop the function of the dryer.
- When loading or re-loading the dryer, avoid touching hot metal parts of the drum (burn risk).
- If drum rotation is blocked due to trapped textiles, disconnect the dryer from the electrical supply before gently removing the blockage.
- If the dryer is not heating, or appears to be defective or damaged, do not use it. Contact the owner.
- Do not install or store the dryer where it will be exposed to the weather.
- Do not tamper with controls.
- Clean dryer lint screen before or after each load.
- Do not use this dryer without the lint screen in place.
- Do not repair or replace any part of the dryer or attempt any servicing unless specifically recommended in this Use and Care Guide or in published user-repair instructions that you understand and have the skills to carry out.
- Do not use fabric softeners or products to eliminate static unless recommended by the manufacturer of the fabric softener or product.
- Do not use heat to dry articles containing foam rubber or similarly textured rubber-like materials.
- The final part of a tumble dryer cycle occurs without heat (cool-down cycle) to ensure that the articles are left at a temperature that ensures that the items will not be damaged.
- **WARNING:** Never stop a tumble dryer before the end of the drying cycle unless all items are quickly removed and spread out so that the heat is dissipated. (Avoids risk of spontaneous combustion).
- In case of electrical supply failure, remove the load quickly and spread it out to avoid risk of spontaneous combustion.
- Keep area around the exhaust opening and adjacent surrounding areas free from the accumulation of lint, dust, and dirt.
- The fresh air ventilation openings into the room and into the dryer must not be blocked or sealed.
- Emergency stop control: After installation, access to mains plug or disconnection from mains supply via a double-pole switch must be ensured at all times in order to ensure immediate deactivation of the dryer in case of emergency.
- The interior of the dryer and dryer exhaust vent should be cleaned periodically by qualified service personnel.
- See “Electrical Requirements” section for earthing instructions.
- The dryer shall be disconnected from its power source during service and when replacing parts. If the removal of the plug is foreseen, it shall be clearly indicated that it be possible for the operator to confirm the removal of the plug from any point of access.  
If this is not possible due to the construction of the appliance or its installation, a disconnection with a locking system in the isolated position shall be provided.

**SAVE THESE INSTRUCTIONS**

# DRYER DISPOSAL

---



This appliance is marked according to the European directive 2012/19/EU on Waste Electrical and Electronic Equipment (WEEE).

By ensuring this product is disposed of correctly, you will help avoid potential negative consequences for the environment and human health, which could otherwise be caused by inappropriate waste handling of this product.

The symbol on the product, or on the documents accompanying the product, indicates that this appliance may not be treated as household waste. Instead it shall be handed over to the applicable collection point for the recycling of electrical and electronic equipment.

Disposal must be carried out in accordance with local environmental regulations for waste disposal.

For more detailed information about treatment, recovery and recycling of this product, please contact your local city office, your household waste disposal service or the shop where you purchased the product.

## MODEL NOMENCLATURE:

**MLG** – Maytag Dryer – Gas

**PN** – Electronic Control – Non-Pay

**## (e.g. 27)** – Model Type Number **PD** – Electronic Control – Coin Drop Enabled

**IMPORTANT:** When discarding or storing your old clothes dryer, remove the door.

# TOOLS & PARTS

## Tools Needed:



203 mm (8")  
or 254 mm (10")  
Pipe wrench



203 mm (8") or 254 mm (10")  
Adjustable wrench  
that opens to 25 mm (1")



Flat-blade screwdriver



Phillips screwdriver



Torx T20<sup>†</sup> Security  
screwdriver or bit



25 mm (1") Hex-head  
socket wrench



8 mm (5/16") Socket wrench

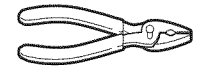

Pliers  
(that open to 39 mm [1<sup>9</sup>/<sub>16</sub>"])

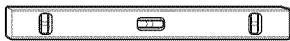

Level



Utility knife



6 mm (1/4") Nut driver

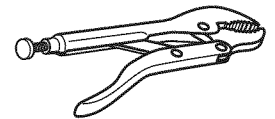

Locking pliers

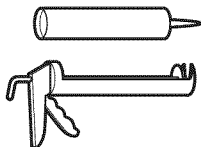

Caulk gun and caulk  
(for installing new exhaust vent)



Vent clamps



Pipe-joint compound  
suitable for gas type

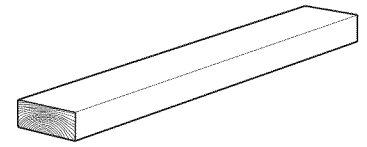

686 mm (27") Wood block

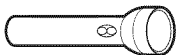

Flashlight (optional)



13 mm (1/2") and 14 mm  
(9/16") Open-end wrenches

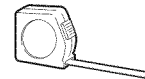

Ruler or measuring tape

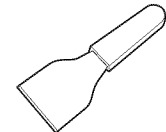

Putty knife

## Parts Supplied:

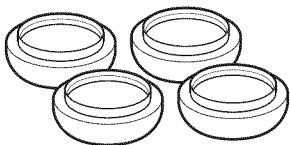

Foot boots (4)

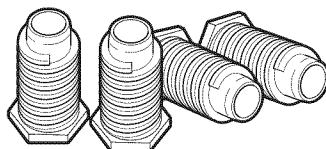

Leveling legs (4)

**NOTE:** The circuit diagram for this dryer is located inside the lower front panel, within the Tech Sheets.

# DIMENSIONS/CLEARANCES

## Dimensions

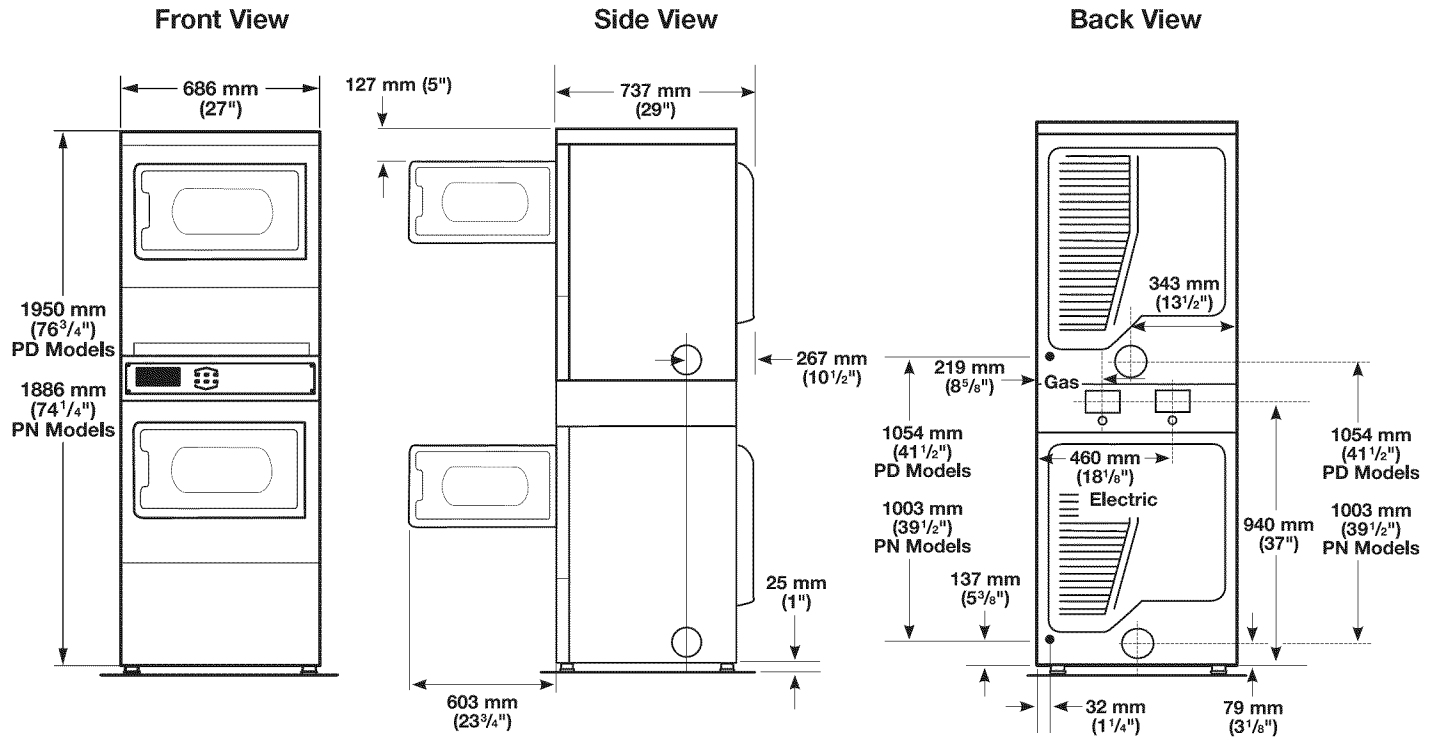

## Minimum Clearances

Front View, Recessed Opening

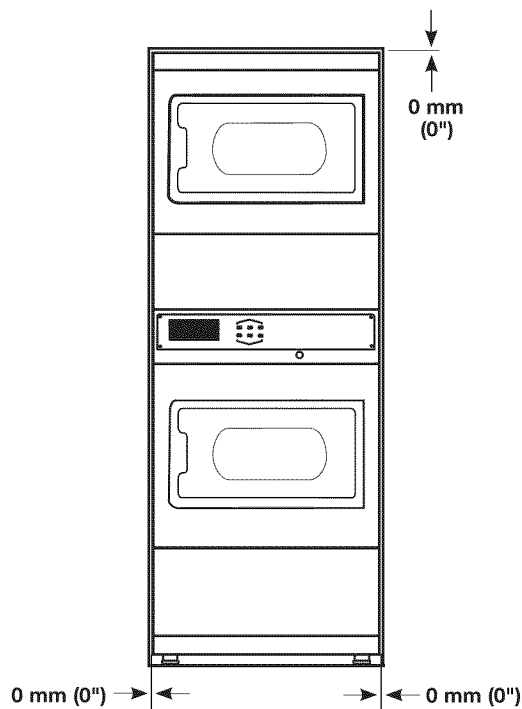

Side View, Recessed In Closet

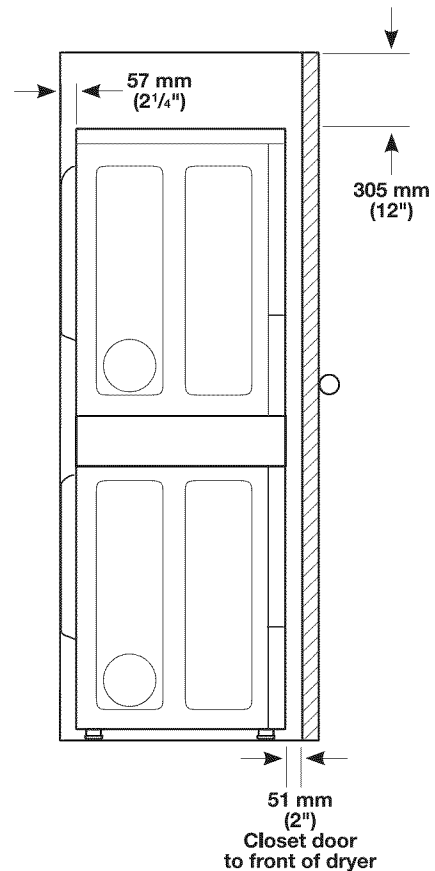



# INSTALLATION REQUIREMENTS

## Location

**⚠ WARNING**



**Explosion Hazard**

**Keep flammable materials and vapors, such as petrol, away from dryer.**

**Do not install in a garage.**

**Failure to do so can result in death, explosion, or fire.**

Your dryer can be installed in a basement, laundry room, or recessed area.

Companion appliance location requirements should also be considered.

**IMPORTANT:** Do not install or store the dryer where it will be exposed to the weather. Proper installation is your responsibility.

### You will need:

- A level floor with a maximum slope of 25 mm (1") under entire dryer. Installing the dryer on soft floor surfaces, such as carpets or surfaces with foam backing, is not recommended.
- A sturdy and solid floor to support the dryer with a total weight (load) of 204 kg (450 lbs).

### Installation clearances

- The location must be large enough to allow the dryer door to be fully opened.
- Additional spacing should be considered for ease of installation and servicing. The door opens more than 180°.
- Additional clearances might be required for wall, door, and floor moldings.
- Additional spacing of 25 mm (1") on all sides of the dryer is recommended to reduce noise transfer.
- Companion appliance spacing should also be considered.

### When installing a gas dryer:

**IMPORTANT:** Observe all governing codes and ordinances.

- Check code requirements: Some codes limit or do not permit installation of clothes dryers in garages, closets, or sleeping quarters. Contact your local building inspector.

**NOTE:** For installation in Australia and New Zealand, install dryer in accordance with AS/NZS 5601.1 and local governance codes.

- Make sure that lower edges of the cabinet, plus the back and bottom sides of the dryer, are free of obstructions to permit adequate clearance of air openings for combustion air. See "Recessed Area and Closet Installation Instructions" below for minimum spacing requirements.
- Do not install on carpet.

### Recessed Area and Closet Installation Instructions

This dryer may be installed in a recessed area or closet. The dryer must not be installed behind a lockable door, a sliding door, or a door with a hinge on the opposite side to that of the dryer in such a way that a full opening of the dryer door is restricted. For recessed area and closet installations, minimum clearances can be found on the warning label on the rear of the dryer or in "Dimensions/Clearances."

The installation spacing is in millimeters and is the minimum allowable. Additional spacing should be considered for ease of installation, servicing, and compliance with local codes and ordinances.

If closet door is installed, the minimum unobstructed air opening in the top and bottom is required. Louvered doors with equivalent air openings are acceptable.

The dryer must be exhausted outdoors.

No other fuel-burning appliance may be installed in the same closet as the dryer.

**NOTE:** For installation in Australia and New Zealand, refer to AS/NZS 5601.1 for ventilation requirements.

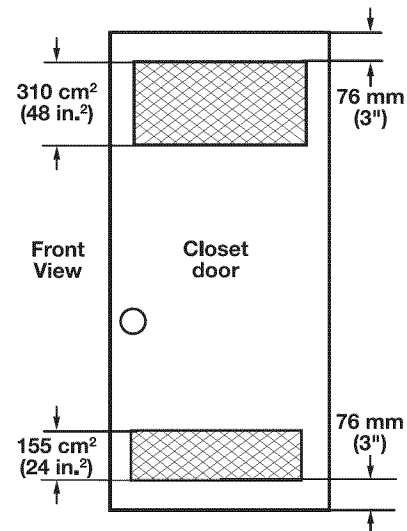

**NOTE:** This dryer is not intended to be placed on top of a washer.

# INSTALLATION REQUIREMENTS

## Electrical Requirements

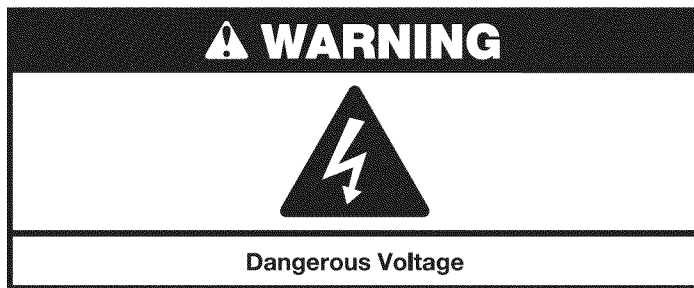

**IMPORTANT:** Observe all governing codes and ordinances.

You will need an earthed electrical outlet located within 610 mm (2 feet) of either side of the dryer.

This dryer is supplied/fitted with an electrical supply cord and plug. It should be connected to electrical supply socket at the voltage shown on the rating plate. The minimum supply fuse capacity should be 12A. The dryer must be positioned so that the plug is clearly visible and accessible. This plug also provides the function of an emergency stop control for the user. If the fitted plug is not used, the electrical connection must be carried out by a competent electrician in accordance with local or national codes.

If the supply cord is damaged, it must be replaced with a specially terminated cord by an authorized service agent or a similarly competent person in order to avoid a hazard.

Do not use an adapter.

Do not use an extension cord.

**NOTE:** In accordance with the European EMC Directive (2004/108/EC), the maximum electricity supply system impedance to which the gas dryer should be connected is declared to be  $0.012 \text{ Ohm} + j0.007 \text{ Ohm}$ .

**NOTE:** Electrical safety standards: The manufacturer has chosen compliance with IEC/EN.60335 standards as the most appropriate for this product.



**Electric Shock Hazard**

**This is a 3-wire appliance which must be earthed.**

**Do not earth to a gas pipe.**

**Do not change the power supply cord plug. If it does not fit the outlet, have a proper outlet installed by a qualified electrician.**

**Do not use an extension cord with this dryer.**

**Failure to follow these instructions could result in death, fire, or serious injury.**

If codes permit and an additional earth bond wire is used, it is recommended that a qualified electrician determine that the earth bond path is adequate.

## EARTHING INSTRUCTIONS

- For an earthed cord-connected dryer:  
This dryer must be earthed. In the event of a malfunction or breakdown, earthing will reduce the risk of electric shock by providing a path of least resistance for electric current. This dryer is equipped with a cord having an equipment-earthing conductor and a earthing plug. The plug must be plugged into an appropriate outlet that is properly installed and earthed in accordance with all local codes and ordinances.

**WARNING:** Improper connection of the equipment-earthing conductor can result in a risk of electric shock. Check with a qualified electrician or service representative or personnel if you are in doubt as to whether the dryer is properly earthed. Do not modify the plug provided with the dryer: if it will not fit the outlet, have a proper outlet installed by a qualified electrician.

## SAVE THESE INSTRUCTIONS

### Using the universal cord included with this dryer:

The gas dryer is equipped with a universal cord with interchangeable plugs.

1. To use the universal cord, select the plug end that fits your electrical outlet, and plug it into the adapter on the supply cord.
2. Secure the plug end in place on the cord by aligning the 2 cover halves over the cord adapter and clipping them together.

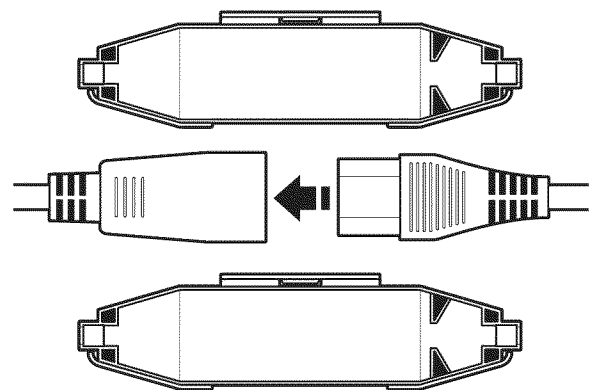

## Gas Supply Requirements

### **⚠ WARNING**



#### **Explosion Hazard**

**Connect this dryer to a regulated gas supply. Supply pressure must be in accordance with the Technical Specifications (see last page).**

**Install a shut-off valve.**

**Securely tighten all gas connections.**

**If connected to LP, have a qualified person make sure gas pressure is correct.**

**Failure to do so can result in death, explosion, or fire.**

**IMPORTANT:** Observe all governing codes and ordinances.

### **Gas Supply**

Before installation, check that the local gas distribution conditions, nature of gas and pressure, and the adjustment of the appliance are compatible. Burner information will be found on the model/serial rating plate in the door recess of the dryer. If this information does not agree with the type of gas available, see your dealer.

#### **Natural Gas:**

This dryer is factory adjusted for use with NATURAL GAS (G20), and no further adjustment should be required at installation.

#### **L.P. Gas:**

This dryer is also certified for use with L.P. (propane or butane) gases with appropriate conversion. No attempt shall be made to convert the appliance from the gas specified on the model/serial rating plate for use with a different gas without consulting the serving gas supplier.

Conversion must be done by a competent service technician. Gas conversion kit (European Country), part number W10233219, is available for purchase from your dealer. Gas conversion kit (Australia), part number W10315369, is available for purchase from your dealer. Full instructions are supplied with the kit.

#### **Natural Gas (France/Belgium):**

This dryer is also certified for France/Belgium for use with G20/G25 gases (20 mbar/25 mbar) with appropriate conversion. No attempt should be made to convert this appliance from the gas specified on the gas rating label for use with a different gas without consulting the serving gas supplier. Gas conversion must be done by a qualified gas service technician. Conversion kit, part number (W10181947) is available for purchase from your dealer. Full instructions are supplied with the kit.

#### **Supply line requirements:**

Provide a rigid gas supply line to the dryer location. It should be minimum 12.5 mm (1/2") ID. When acceptable to the gas supplier and local codes, 10 mm (3/8") ID rigid supply line may be used for lengths under 6.1 m (20'). Pipe-joint compounds resistant to the action of L.P. gas must be used.

**NOTE:** For installation in Australia and New Zealand, refer to AS/NZS 5601 for pipe sizing details.

Gas connection to the dryer itself should be made by means of a flexible gas hose suitable for the appliance and gas category in accordance with national installation regulations. If in doubt, contact the gas supplier. It should be minimum 10 mm (3/8") ID.

A means of restraint should be used between the dryer and the wall to avoid straining of the rigid gas supply when the dryer is moved. An appropriate length of chain and a wall hook is recommended.

The dryer gas inlet connection is a 3/8" NPT thread.

An adapter is supplied for conversion to standard ISO.228-1 thread (3/8" BSP).

Check for leaks by using an approved noncorrosive leak-detection solution. Bubbles will show a leak. Correct any leak found. A pressure measurement tapping is provided on the gas valve within the dryer, accessible after removal of the lower front panel.

The dryer must be disconnected from the gas supply piping system during any pressure testing of that system.

# VENTING REQUIREMENTS

## ⚠ WARNING



### Fire Hazard

Use a heavy metal vent.

Do not use a plastic vent.

Do not use a metal foil vent.

Failure to follow these instructions can result in death or fire.

**WARNING:** To reduce the risk of fire, this dryer MUST BE EXHAUSTED OUTDOORS.

**IMPORTANT:** Observe all governing codes and ordinances.

- Following these venting requirements will minimise ducting air noise.
- Exhaust air must not be discharged into a flue for exhausting fumes from appliances burning gas or other fuels, including open fires (i.e. available airflow into the room should match airflow out from the room).
- Dryer exhaust must not be connected into any gas vent, chimney, wall, ceiling, attic, crawlspace, or a concealed space of a building. Only rigid or flexible metal vent shall be used for exhausting.
- Do not use an exhaust hood with a magnetic latch.

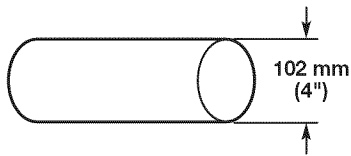

102 mm (4") heavy, metal exhaust vent

- Only a 102 mm (4") heavy, metal exhaust vent and clamps may be used.
- Do not use plastic or metal foil vent.

### Rigid metal vent:

- Recommended for best drying performance and to avoid crushing and kinking.

### Flexible metal vent: (Acceptable only if accessible to clean)

- Must be fully extended and supported in final dryer location.
- Remove excess to avoid sagging and kinking that may result in reduced airflow and poor performance.
- Do not install in enclosed walls, ceilings, or floors.
- The total length should not exceed 2.4 m (7¾ ft.).
- An exhaust hood should cap the vent to keep rodents and insects from entering the building.

**NOTE:** If using an existing vent system, clean lint from entire length of the system and make sure exhaust hood is not plugged with lint. Replace plastic or metal foil vents with rigid metal or flexible metal vents. Review "Vent System Chart" and if necessary, modify existing vent system to achieve best drying performance.

### Elbows:

- 45° elbows provide better airflow than 90° elbows.

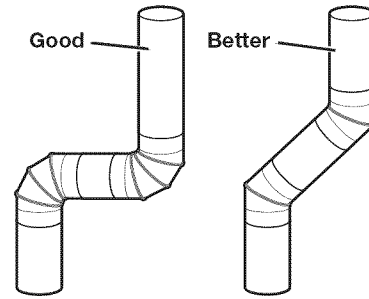

- Plan installation to use the fewest number of elbows and turns.
- Allow as much room as possible when using elbows or making turns. Bend vent gradually to avoid kinking.
- Vent outlet is located at the center of the bottom dryer back.
- The vent can be routed up, down, left, right, behind the dryer, or straight out the back of the dryer.

### Clamps:

- Use clamps to seal all joints.
- Exhaust vent must not be connected or secured with screws or other fastening devices that extend into interior of duct and catch lint. Do not use duct tape.



### Improper venting can cause moisture and lint to collect indoors, which may result in:

- Moisture damage to woodwork, furniture, paint, wallpaper, carpets, etc.
- Housecleaning problems and health problems.

# VENTING REQUIREMENTS

## Vent Hoods

### 102 mm (4") Diameter Exhaust Hoods

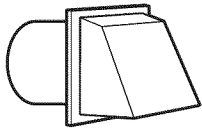

Box hood

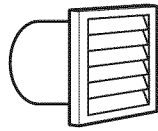

Louvered hood

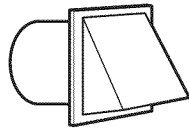

Angled hood

Exhaust hood must be at least 305 mm (12") from the ground or any object that may be in the path of the exhaust (such as flowers, rocks, bushes, or snow).

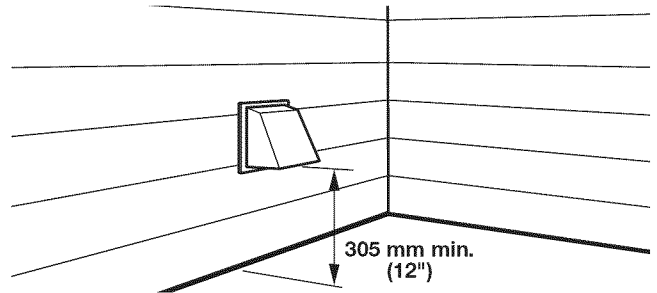

## Vent System Length

### Maximum Vent Length/Vent Connection

Maximum length of vent system depends upon the type of vent used, number of elbows, and type of exhaust hood.

Vent System Chart (Rigid Metal Vent)

No. of 90° Turns	Box and Louvered Hood	Angled Hood
0	39.6 m (130 ft.)	39.3 m (129 ft.)
1	38.1 m (125 ft.)	36.3 m (119 ft.)
2	35.1 m (115 ft.)	33.2 m (109 ft.)
3	32.3 m (106 ft.)	30.5 m (100 ft.)
4	29.9 m (98 ft.)	28.0 m (92 ft.)

For vent systems not covered by the "Vent Specification Chart," see your parts distributor.

Provision must be made for enough air for combustion and ventilation. (Check governing codes and ordinances.) See "Recessed Area and Closet Installation Instructions" in the "Location" section.

A 102 mm (4") outlet hood is preferred. However, a 64 mm (2½") outlet exhaust hood may be used. A 64 mm (2½") outlet creates greater back pressure than other hood types. For permanent installation, a stationary vent system is required.

### Connect Vent

1. If connecting to existing vent, make sure the vent is clean.
2. Using a 102 mm (4") clamp, connect vent to exhaust outlet in dryer.

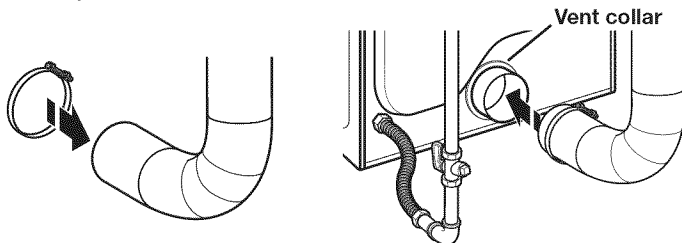

**NOTE:** Do not remove vent collar.

3. Tighten hose clamp with Phillips screwdriver.

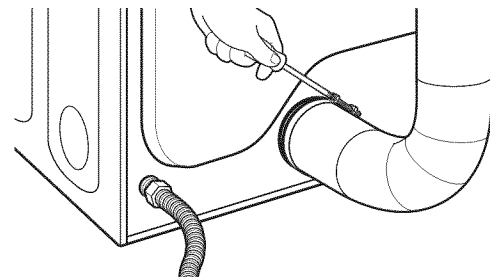

4. Make sure the vent is secured to exhaust hood with a 102 mm (4") clamp.

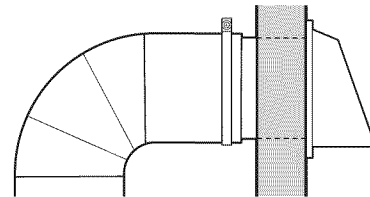

5. Move dryer into final position. Do not crush or kink vent. Make sure dryer is level.

# VENTING REQUIREMENTS

## If an Exhaust Hood Cannot be Used

The outside end of main vent should have a sweep elbow directed downward.

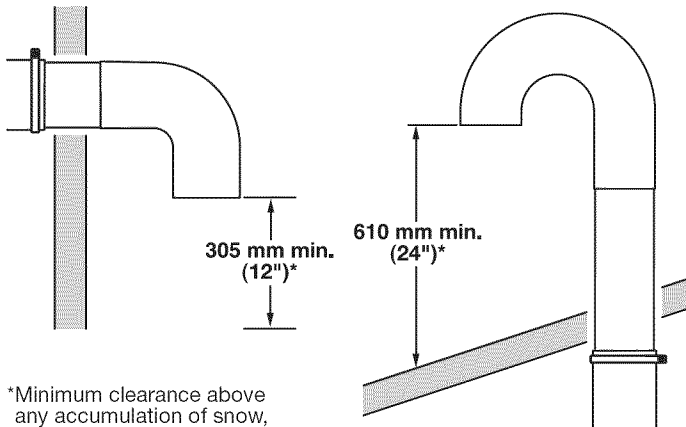

\*Minimum clearance above any accumulation of snow, ice, or debris such as leaves

If main vent travels vertically through the roof, rather than through wall, install a 180° sweep elbow on end of vent at least 610 mm (2 ft.) above surface of roof.

The opening in wall or roof shall have a diameter 13 mm (1/2") larger than vent diameter. Vent should be centered in opening. Do not install screening over end of vent for best performance.

## Multiple Dryer Venting

A main vent can be used for venting a group of dryers. The main vent should be sized to remove 5663 l/min. (200 CFM) of air per dryer. Large-capacity lint screens of proper design may be used in main vent if checked and cleaned frequently. The room where the dryers are located should have make-up air equal to or greater than CFM of all the dryers in the room.

Back-draft Damper Kit, Part No. 3391910, is available from your distributor and should be installed in the vent of each dryer to keep exhausted air from returning into dryers and to keep exhaust in balance within main vent. Unobstructed return air openings are required.

Each vent should enter the main vent at an angle pointing in the direction of the airflow. Vents entering from the opposite side should be staggered to reduce the exhausted air from interfering with the other vents.

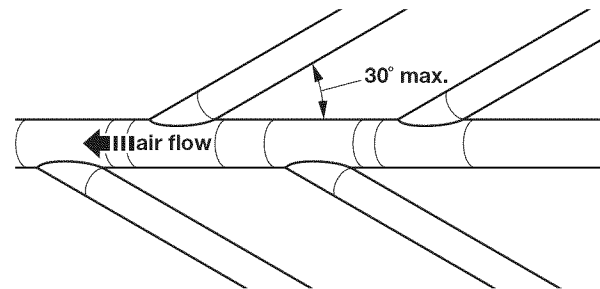

The maximum angle of each vent entering the main vent should be no more than 30°.

Keep air openings free of dry cleaning fluid fumes. Fumes create acids which, when drawn through the dryer heating units, can damage dryers and items being dried.

A clean-out cover should be located on the main vent for periodic cleaning of the vent system.

# GAS SUPPLY REQUIREMENTS

## Make Gas Connection

### **⚠ WARNING**

#### **Excessive Weight Hazard**

**Use two or more people to move and install dryer.  
Failure to do so can result in back or other injury.**

1. Remove red cap from gas pipe.
2. Connect gas supply to dryer. If the flexible gas hose has 10 mm (3/8") BSP thread, use the supplied conversion thread adapter. Use pipe-joint compound resistant to the action of L.P. gas for gas connections.

If necessary for service, open the toe panel. Use a putty knife to press on the 2 toe panel locks located at the top of the toe panel. Pull downward on the toe panel to open. Toe panel is hinged at the bottom.

3. Open the shut-off valve in the gas supply line.
4. Test all connections by brushing on an approved noncorrosive leak-detection solution. Bubbles will show a leak. Correct any leaks found.

# INSTALLING LEVELING LEGS

## **⚠ WARNING**

### **Excessive Weight Hazard**

**Use two or more people to move and install dryer.**

**Failure to do so can result in back or other injury.**

### 1. Prepare dryer for leveling legs

**NOTE:** Slide dryer onto cardboard or hardboard before moving to avoid damaging floor covering.

Using two or more people, move dryer to desired installation location.

Take tape off front corners of dryer. Open dryer and remove the literature and parts packages. Wipe drum interior with damp cloth to remove any dust.

Take two cardboard corners from the dryer carton and place them on the floor in back of the dryer. Firmly grasp body of the dryer and gently lay it on its back on the cardboard corners.

### 2. Screw in leveling legs

Examine leveling legs and find diamond marking. Screw legs into leg holes by hand. Use an adjustable wrench or 25 mm (1") hex-head socket wrench to finish turning legs until diamond marking is no longer visible. Then fit a covered foot boot over each leg foot.

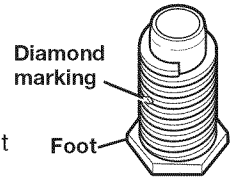

To protect the floor, use a large piece of cardboard from the dryer carton. Stand dryer up on the cardboard. Slide the dryer until it is close to its final location. Leave enough room for electrical connection and to connect the exhaust vent.

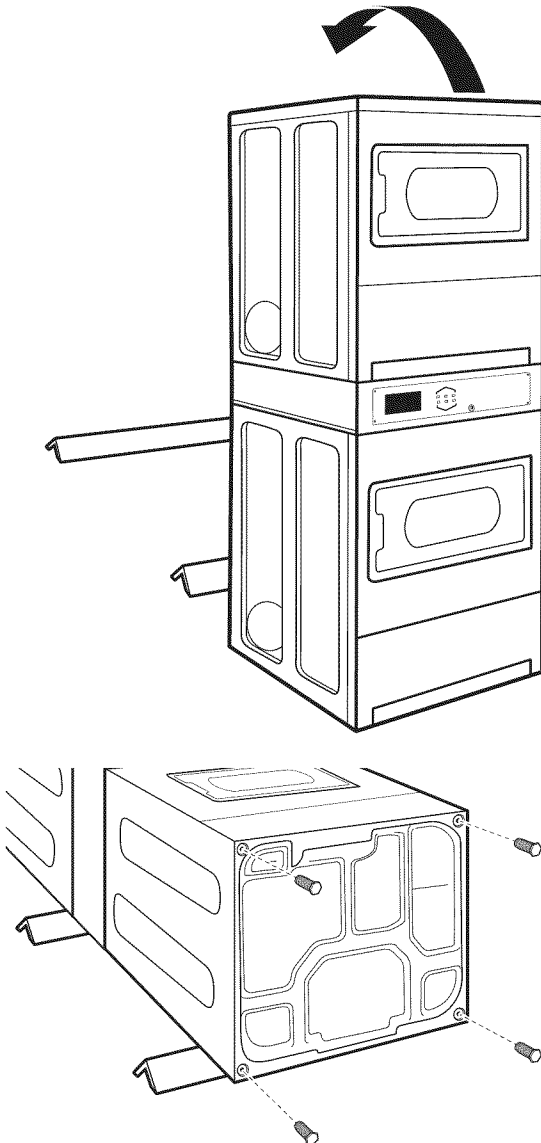

# LEVELING

Leveling your dryer properly reduces excess noise and vibration.

## **⚠ WARNING**

### **Excessive Weight Hazard**

**Use two or more people to move and install dryer.  
Failure to do so can result in back or other injury.**

1. Remove cardboard from beneath dryer. Place a level on top edges of dryer, checking each side and front. If not level, tip dryer and adjust feet up or down as shown in Steps 3 and 4, repeating as necessary.

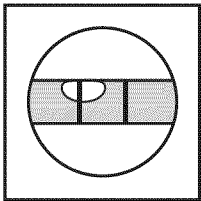
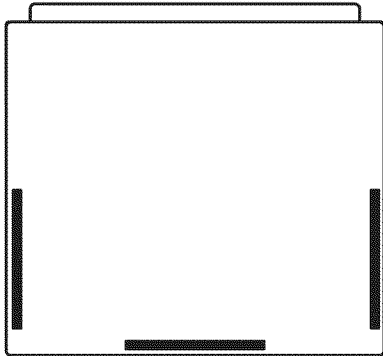

Not Level

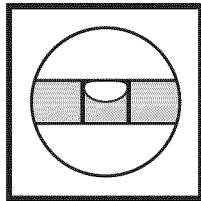

LEVEL

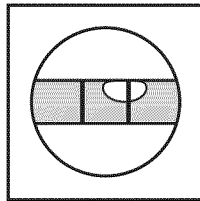

Not Level

2. Grip dryer from top and rock back and forth, making sure all four feet are firmly on floor. Repeat, rocking dryer from side to side. If dryer rocks, go to Step 3 and adjust leveling feet. If all four feet are in firm contact with floor, go to Step 4.

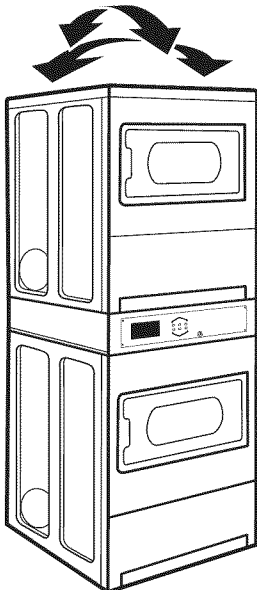

3. If dryer is not level, use a 14 mm or 9/16" open-end or adjustable wrench to turn jam nuts clockwise (as viewed from above) on feet until they are about 13 mm (1/2") from the dryer cabinet. Then turn the leveling foot counterclockwise to lower the dryer or clockwise to raise the dryer. Recheck levelness of dryer and that all four feet are firmly in contact with the floor. Repeat as needed.

**HELPFUL TIP:** You may want to prop up front of dryer about 102 mm (4") with a wood block or similar object that will support weight of dryer.

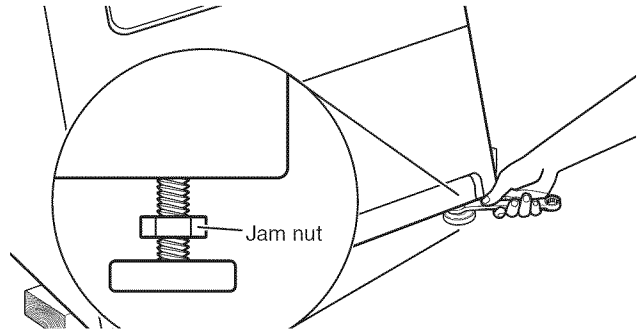

4. When dryer is level and all four feet are firmly in contact with the floor, use a 14 mm or 9/16" open-end or adjustable wrench to turn jam nuts counterclockwise (as viewed from above) on leveling feet tightly against dryer cabinet.

**HELPFUL TIP:** You may want to prop dryer with wooden block.



## COMPLETE INSTALLATION

1. Check the electrical requirements. Be sure that you have the correct electrical supply and the recommended earthing method. See “Electrical Requirements.”
2. Check that all parts are now installed. If there is an extra part, go back through the steps.
3. Check that you have all of your tools.
4. Dispose of/recycle all packaging materials.

**⚠ WARNING**



**Electric Shock Hazard**

**This dryer must be earthed.**

**Securely tighten all electrical connections.**

**Failure to do so can result in death, fire, or electric shock.**

6. Check dryer operation. Using a full heat cycle, let the dryer run for at least five minutes. Dryer will stop when time is used up.

**NOTE:** Dryer door must be closed for dryer to operate. When door is open, dryer stops, but timer continues to run. To restart dryer, close door and press cycle button.

7. If the burner does not ignite and you can feel no heat inside the dryer, shut off dryer for five minutes. Check that all supply valve controls are in “ON” position and that the electrical cord is plugged in. Repeat five-minute test.

5. Connect power.

# REVERSING DOOR SWING (OPTIONAL)

You can change your door swing from a right-side opening to left-side opening, if desired.

## Remove the Door Assembly

1. Place a towel or soft cloth on top of work space to avoid scratching of the surface.
2. Open dryer door. Remove button screws from cabinet side of hinges. Loosen (do not remove) top screws from cabinet side of hinges.

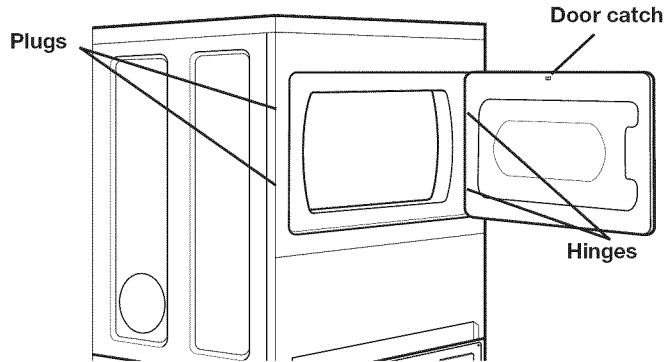

3. Lift door until top screws in cabinet are in large part of hinge slot. Pull forward off screws. Set door (handle side up) on top of towel. Remove top screws from cabinet.
4. Remove screws attaching hinges to door.
5. Remove screws at top, bottom, and side of door (5 screws).

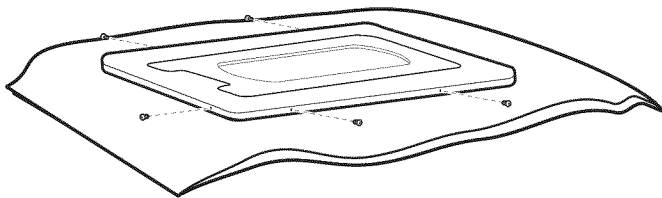

6. Holding door over towel, grasp sides of outer door and gently lift to separate it from inner door. Do not use a putty knife to pry apart. Do not pull on door seal or plastic door catch.

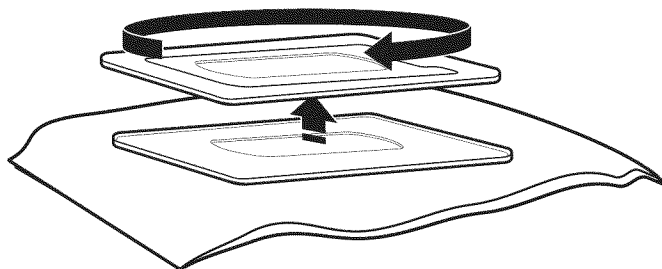

7. Be certain to keep cardboard spacer centered between doors. Reattach outer door panel to inner door panel so handle is on the side where hinges were just removed.

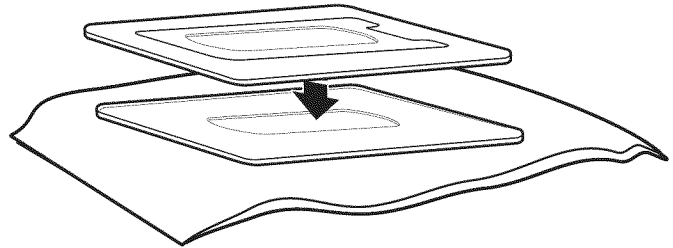

8. Reattach screws at top, bottom, and side of door (5 screws).

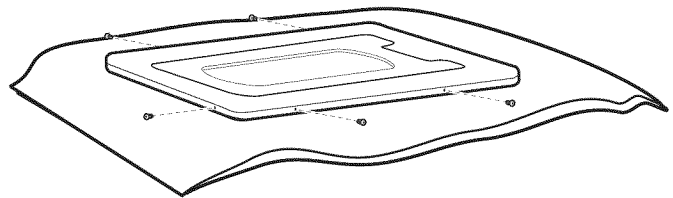

9. Attach door hinges to dryer door so that larger hole is at the bottom of the hinge and the hinge pin is toward the door front.

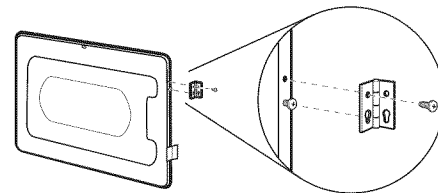

10. Remove the 4 screws that attach 2 plugs on the left side. Attach plugs to right side using the same 4 screws.

11. Insert screws into bottom holes on left side of cabinet. Tighten screws halfway. Position door so large end of door hinge slot is over screws. Slide door up so screws are in bottom of slots. Tighten screws. Insert and tighten top screws in hinges.

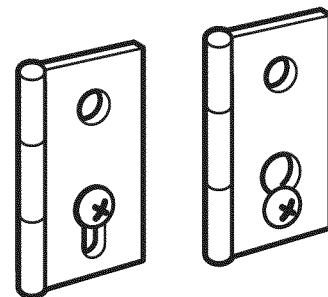

12. Close door and check that door strike aligns with door catch. If needed, slide door catch left or right within slot to adjust alignment.

# MAINTENANCE INSTRUCTIONS

---

- Clean lint screen before and after each cycle.
- Removing accumulated lint:
  - From inside the dryer cabinet:  
Lint should be removed every 2 years or more often, depending on dryer usage. Cleaning should be done by a qualified person.
  - From the exhaust vent:  
Lint should be removed every 2 years, or more often, depending on dryer usage.
- Keep area around dryer clear and free from combustible materials, gasoline, and other flammable vapors and liquids.
- Keep dryer area clear and free from items that would obstruct the flow of combustion and ventilation air.

## **If dryer does not operate, check the following:**

- Electrical supply is connected.
- Circuit breaker is not tripped or house fuse is not blown.
- Door is closed. Listen closely to hear the door switch activate.
- Cycle selection button has been pushed firmly and display shows cycle time.
- Check that gas supply shut-off valves are set in open position.

---

## IF YOU NEED ASSISTANCE

If you need help, contact the dealer from whom you purchased the appliance, or a Maytag designated service company. When calling, please know the purchase date and the complete model and serial number of your appliance. This information will help us to better respond to your request.

# TECHNICAL SPECIFICATIONS – GAS DRYER

220-240V~50Hz 1ph 3A max. IPX4 Clothes capacity: 9.0 kg max. Sound pressure level, Lpa: 58 dBA (uncertainty, Kpa: +/-10 dBA) Total mass: 68 kg max.

**Factory set for NATURAL GAS: Injector size: 2.2 mm Heat input gross: 5.9 kW**

European Country:	CH, CZ, CY, ES, GB, GR, HR, IE, IT, PT, SI, SK, TR	CY, CZ, DK, EE, FI, GR, HU, IT, NO, RO, SE, SK, TR
European Gas Category:	II <sub>2</sub> H <sub>3</sub> +	II <sub>2</sub> H <sub>3</sub> B/P
Gas Flow Rate:	0.562703 m <sup>3</sup> /hr	0.562703 m <sup>3</sup> /hr
Supply Pressure (G20)	20 mbar	20 mbar
Factory Adjusted Pressure:	7.4 mbar	7.4 mbar

**With LP Gas Conversion Kit: Injector size: 1.25 mm Heat input gross: 6.4 kW**

European Country:	CH, CZ, CY, ES, GB, GR, HR, IE, IT, PT, SI, SK, TR	CY, CZ, DK, EE, FI, GR, HU, IT, NO, RO, SE, SK, TR
European Gas Category:	II <sub>2</sub> H <sub>3</sub> +	II <sub>2</sub> H <sub>3</sub> B/P
Butane Supply Pressure (G30):	28-30 mbar	30 mbar
Adjusted Pressure:	N/A	N/A
Propane Supply Pressure (G31):	37 mbar	30 mbar
Adjusted Pressure:	N/A	N/A

**With France/Belgium NATURAL GAS conversion kit: Injector size 1.65 mm Heat input gross: 5.9 kW**

European Country:	FR, BE
European Gas Category:	I <sub>2</sub> E+
Supply Pressure (G20):	20 mbar
Supply Pressure (G25):	25 mbar
Adjusted Pressure:	N/A

**Factory set for Australia/New Zealand NATURAL GAS: Injector size: 2.2 mm Heat input gross: 5.9 kW**

Country:	AS, NZS
Supply Pressure (G20):	minimum 1.13 kPa
Adjusted Pressure (Test Point Pressure):	0.74 kPa
Nominal Hourly Gas Consumption:	21.1 MJ/h

**With Australia LP Gas Conversion Kit: Injector Size: 1.40 mm Heat input gross: 6.54 kW**

Country:	AS, NZS
Propane Supply Pressure:	2.75 kPa
Adjusted Pressure:	2.75 kPa
Nominal Hourly Gas Consumption:	23 MJ/h

**Factory set for NATURAL GAS: Injector size: 2.2 mm Heat input gross: 5.0 kW**

Country:	NL
European Gas Category:	II <sub>2</sub> L <sub>3</sub> B/P
Gas Flow Rate:	0.562703 m <sup>3</sup> /hr
Supply Pressure (G25):	25 mbar
Factory Adjusted Pressure (G25):	7.4 mbar
Supply Pressure (G30/G31):	30 mbar
Factory Adjusted Pressure (G30/G31):	Not Applicable

**NOTE:** Conversion kit: From Natural Gas to LP Gas - Europe: Whirlpool Part No. W10233219.  
 Conversion kit: From Natural Gas to LP Gas - Australia: Whirlpool Part No. W10315369.  
 Conversion kit: From Natural Gas to Natural Gas - France/Belgium: Whirlpool Part No. W10181947.  
 Manufacturer: Whirlpool Corporation, Benton Harbor, Michigan 49022, U.S.A.  
 Manufacturing Site: Whirlpool Corporation, 1300 Marion-Agosta Rd., Marion, OH, 43302, U.S.A.  
 EU Representatives: Maytag UK Ltd., 2 St. Annes Blvd., Redhill, RH1 1AX, UK  
 & Bauknecht Hausgeräte GmbH, D-73614 Schorndorf, Germany

# ELECTRONIC CONTROL SETUP INSTRUCTIONS

## IMPORTANT

### Electrostatic Discharge (ESD) Sensitive Electronics

ESD problems are present everywhere. ESD may damage or weaken the electronic control assembly. The new control assembly may appear to work well after repair is finished, but failure may occur at a later date due to ESD stress.

- Use an anti-static wrist strap. Connect wrist strap to green earth connection point or unpainted metal in the appliance.

-OR-

Touch your finger repeatedly to a green earth connection point or unpainted metal in the appliance.

- Before removing the part from its package, touch the anti-static bag to a green ground connection point or unpainted metal in the appliance.
- Avoid touching electronic parts or terminal contacts; handle electronic control assembly by edges only.
- When repackaging failed electronic control assembly in anti-static bag, observe above instructions.

## General User Information

**“OUT OF ORDER” SHOWING IN DISPLAY** – This condition indicates the dryer is inoperative. Diagnostic or failure code will follow the scrolling message.

**“0 MINUTES” SHOWING IN DISPLAY** – This indicates the cycle is complete and the dryer cannot be operated. Coins dropped or debit inputs during this condition will be stored in escrow but cannot be used until normal operation is restored by opening and closing the door. If a door switch has failed, it must be replaced before normal operation can be restored.

**COLD START (Initial first use)** – Dryer is programmed at the factory as follows:

45 minutes dry time for PN models; 5 minutes per coin for PD models.

\$1.50 dry price (fixed cycle with top off – PD Models)

\$0.00 dry price (fixed cycle – PN Models)

**WARM START (after power failure)** – A few seconds after power is restored, if a cycle was in progress at the time of the power failure, “RESELECT CYCLE” will flash in the display. This indicates a fabric setting button needs to be pressed to restart dryer.

**PRICING** – After the door is opened and then closed following the completion of a cycle, the display indicates the cycle price (unless set for free operation). As coins are dropped or debit inputs arrive, the display will change to lead the user through the initiation of a cycle.

**There are four (4) types of dryer pricing:**

### Fixed “Vend” Pricing

A dryer set up for “Fixed Cycle” operation can only accept additional time accumulated by increments equal to the length of a complete dry cycle. A maximum of 99 minutes may be purchased; no additional credit is given with 99 minutes in the display.

### Accumulator Pricing

If the price is set to one coin 1, then accumulator pricing is in effect. Cycle time can be purchased one coin at a time (PD models) up to the maximum time of 99 minutes.

### Fixed Cycle With Top Off Pricing

A dryer set to offer “Top Off” capability will allow time to be added to an existing dry cycle in increments equal to the number of minutes of dry time per coin (coin 1), up to 99 minutes, regardless of the cost required to start the dryer. No credit is given for coins or debit inputs entered when the control is displaying 99 minutes.

**PN Models set up as PR:** In Enhanced Debit Mode, the top off price can be set independently (see VALUE OF COIN 2), and the top off time is calculated according to the following equation:

$$\frac{\text{top off price}}{\text{full cycle price}} = \frac{\text{top off time}}{\text{full cycle length}}$$

Hundredth increment offset is not applied to top off purchases.

**PN Models** – The factory has preset the cycle price to zero. When this happens, “SELECT CYCLE” will appear rather than a cycle price. Any cycle started as a free cycle will automatically terminate when the door is opened.

**DEBIT CARD READY** – This dryer has a control that is debit card ready, but the dryer is not.

## Display

After the dryer has been installed and plugged in, the display will show “0 minutes.”

### PD Models

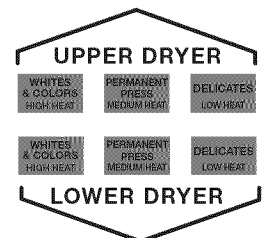

Once the dryer has been plugged in and the dryer door opened and closed, the display will show the vent price. PN models are factory preset for free cycles; the display will flash “SELECT CYCLE.”

### PN Models

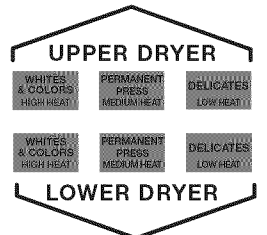
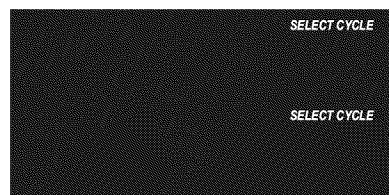

## Control Set-up Procedures

**IMPORTANT:** Read all instructions before operating.

The fabric setting buttons along with the digital display are used to set up the dryer controls. The display can contain 4 numbers and/or letters and a decimal point. These are used to indicate the set-up codes and related code values available for use in programming the dryer.

### How to Use the Buttons to Program the Controls

1. The WHITES AND COLORS button is used to adjust the values associated with set-up codes. Pressing the button will change the value by increments. Rapid adjustment is possible by holding down the button.
2. The PERM. PRESS button will advance the display through the set-up codes. Pressing the button will advance the display to the next available set-up code. Holding down the PERM. PRESS button will automatically advance through the set-up codes at a rate faster than 1 per second.
3. The DELICATES button is used to select or deselect options.

# ELECTRONIC CONTROL SETUP INSTRUCTIONS

## Start Operating Set-up

- PD Models: Insert service door key, turn, and lift to remove service door.
- PN Models: Remove the AA1 jumper from the control board (see procedure below) or use the Service Access Code below. Once the debit card reader is installed (according to the reader manufacturer's instructions), the set-up mode can be entered by inserting a manual set-up card (supplied by the reader manufacturer) into the card slot. If manual set-up card is not available, manual set-up mode cannot be entered. However, diagnostic mode can be entered by removing connector AA1 on the circuit board.

**IMPORTANT:** The console must not be opened unless power is first removed from the dryer. To access connector AA1:

- Unplug dryer or disconnect power.
- Open console, disconnect plug on AA1, close console.
- Plug in dryer or reconnect power.

- PN Models Equipped with Programming Switch: Insert access panel key and turn counterclockwise.
- PN Models with Gen. 2 Debit Card Reader: Once a Gen. 2 debit card reader is installed (according to the reader manufacturer's instructions), the set-up mode can only be entered by inserting a manual set-up card (supplied by the reader manufacturer) into the card slot.

If manual set-up card is not available, only diagnostic mode can be entered.

- Alternate method of entering Set-up Mode by entering **Service Access Code:** This code can be entered to access set-up mode without removing the console on dryers just removed from the carton, or not yet programmed. The Service Access Code only functions on dryers set up for 0 vend price without any Special Pricing setup, and the Coin/Debit Option must be set to "J\_d". If the dryer is not in failure mode, the door must be opened to proceed. Using only the three bottom buttons (numbered 1, 2, and 3 from left to right):

1. Press 2 for longer than 2 seconds but less than 10 seconds.
2. Press 1 and 3 simultaneously for 2 seconds. Display shows S 3.
3. Press 1 and 2 simultaneously. Display shows S 4.
4. Press 2 and 3 simultaneously. Display shows S 5.
5. Press 2.
6. Wait at least 2 seconds, but not more than 15 seconds; then press in succession: 3, 2, 1, 3.

The dryer is now in the set-up mode.

**NOTE:** This dryer is preset at the factory and does not require any programming. However, if you want to change the settings, follow the "Set-Up Codes" guide below. PD models require a payment system or OPL kit to be installed prior to operation.

- PD units are pre-set at the factory for fixed cycle price with top off.
- PN units are pre-set for fixed cycle operation so they can be run without payment.

## Set-Up Codes

- The PERM. PRESS button will advance you from code to code.
- The WHITE AND COLORS button will change the code value.
- The DELICATES button will select or deselect options.

**PN MODELS:** The set-up codes are the same as for the PD models except where noted.

The set-up code is indicated by the one or two left-hand characters. The set-up code value is indicated by the two or three right-hand characters.

**NOTE:** The first line of each code indicates the factory default.

Code	Explanation
<b>REGULAR CYCLE PRICE</b>	
6 06	Represents the number of quarters (coin 1) needed to start the dryer; may adjust from 0-39. (See b.xx set up for VALUE OF COIN 1.) Advance from 0-39 by pressing the WHITES AND COLORS button. Factory default of 6 x coin 1.
6 00	<b>PN MODELS ONLY:</b> Factory default of 6 00, or 0 coins. <ul style="list-style-type: none"> <li>• Press the PERM. PRESS button once to advance to next code.</li> </ul>
<b>REGULAR DRY TIME</b>	
7 05	<b>PD MODELS:</b> Represents the number of minutes per coin (coin 1). Factory default of 5 minutes per coin. Example: 6 coins x 5 minutes = 30 minutes. By pressing the WHITES AND COLORS button, value adjusts from 1-99 minutes.
7 45	<b>PN MODELS:</b> Represents the cycle length for free cycles. Example: "7 45" = 45 minutes. <ul style="list-style-type: none"> <li>• Press the PERM. PRESS button once to advance to next code.</li> </ul>
<b>TYPE OF DRYER PRICING</b>	
8 00	Fixed Cycle with Top Off. For detailed description, see "General User Information."
8 FC	<b>PN MODELS ONLY:</b> Factory default of FC. Fixed Cycle. For detailed description, see "General User Information." Use the DELICATES button to change this selection. <ul style="list-style-type: none"> <li>• Press the PERM. PRESS button once to advance to next code.</li> </ul>
<b>CYCLE COUNTER OPTION</b>	
9 00	This option is either NOT SELECTED "OFF" or SELECTED "ON."
9 00	Not Selected "OFF."
9 0C	Selected "ON" and not able to be deselected. <ul style="list-style-type: none"> <li>• Press the DELICATES button 3 consecutive times to select "ON." Once selected "ON," it cannot be deselected.</li> <li>• Press the PERM. PRESS button once to advance to next code.</li> </ul>

**If cycle counter (9 0C) is selected, the following is true:**

1 00	Cycles in HUNDREDS	1 <u>02</u> = 200
2 00	Cycles in ONES	2 <u>25</u> = 25

TOTAL CYCLES = 225

This is "VIEW ONLY" and cannot be cleared.

- Press the PERM. PRESS button once to advance to next code.

# ELECTRONIC CONTROL SETUP INSTRUCTIONS

Code	Explanation
1. 00	<b>MONEY COUNTER OPTION</b> This option is either NOT SELECTED "OFF" or SELECTED "ON."
1. 00	Not Selected "OFF."
1. 0C	Selected "ON." <ul style="list-style-type: none"> <li>• Press the DELICATES button 3 consecutive times to select "ON" and 3 consecutive times to deselect (Not Selected "OFF"). Counter resets by going from "OFF" to "ON."</li> </ul>
1. C0	Selected "ON" and not able to be deselected. <ul style="list-style-type: none"> <li>• To select "ON" and not able to be deselected, first select "ON"; then within 2 seconds, press the DELICATES button twice, the WHITES AND COLORS button once, and exit set-up mode.</li> <li>• Press the PERM. PRESS button once to advance to next code.</li> </ul>

Code	Explanation
2. 00	<b>SPECIAL PRICING OPTIONS</b> This option is either NOT SELECTED "OFF" or SELECTED "ON."
2. 00	Not Selected "OFF."
2. SP	Selected "ON." <ul style="list-style-type: none"> <li>• Press the DELICATES button once to change this selection.</li> </ul>

**If SPECIAL PRICING OPTION is selected, there is access to codes "3.XX" through "9.XX."**

- Press the PERM. PRESS button once to advance to next code.

**If money counter (1.0C or 1.C0) is selected, the following is true:**

3 00	Currency amount in HUNDREDS	3 <u>01</u> = 100.00
4 00	Currency amount in ONES	4 <u>68</u> = 68.00
5 00	Currency amount in HUNDREDTHS	5 <u>75</u> = 00.75
		TOTAL = 168.75

## OPTIONS 3.XX – 9.XX TO USE IF SPECIAL PRICING IS SELECTED

Code	Explanation
3. 06	<b>SPECIAL CYCLE PRICE</b>
3. 06	Represents the number of coins (coin 1) to start the dryer; may adjust from 0–39. (See b.xx set up for VALUE OF COIN 1.) <ul style="list-style-type: none"> <li>• Advance from 0–39 by pressing the WHITES AND COLORS button. Factory default of 6 x coin 1.</li> </ul>
3. 00	<b>PN MODELS ONLY:</b> Factory default of 0 coins. <ul style="list-style-type: none"> <li>• Press the PERM. PRESS button once to advance to next code.</li> </ul>
4. 05	<b>SPECIAL DRY TIME</b>
4. 05	<b>PD MODELS:</b> Represents the number of minutes per coin (coin 1). <ul style="list-style-type: none"> <li>• Factory default of 5 minutes per coin. Example: 6 coins x 5 minutes = 30 minutes.</li> <li>• By pressing the WHITES AND COLORS button, the value can be adjusted from 1–99 minutes.</li> </ul>
4. 45	<b>PN MODELS:</b> Represents the cycle length for free cycles. Example: "4 45" = 45 minutes. <ul style="list-style-type: none"> <li>• Press the PERM. PRESS button once to advance to next code.</li> </ul>
5. 00	<b>TIME-OF-DAY CLOCK, MINUTES</b>
5. 00	This is the TIME-OF-DAY CLOCK, minute setting; select 0–59 minutes by pressing the WHITES AND COLORS button. <ul style="list-style-type: none"> <li>• Press the PERM. PRESS button once to advance to next code.</li> </ul>
6. 00	<b>TIME-OF-DAY CLOCK, HOURS</b> <b>NOTE:</b> Uses military time or 24 hr. clock.
6. 00	This is the TIME-OF-DAY CLOCK, hour setting; select 0–23 hours by pressing the WHITES AND COLORS button. <ul style="list-style-type: none"> <li>• Press the PERM. PRESS button once to advance to next code.</li> </ul>

# ELECTRONIC CONTROL SETUP INSTRUCTIONS

## OPTIONS 3.XX – 9.XX TO USE IF SPECIAL PRICING IS SELECTED (CONT.)

Code	Explanation																								
7. 00	<b>SPECIAL PRICE START HOUR</b> <b>NOTE:</b> Uses military time or 24 hr. clock.																								
7. 00	This is the start hour, 0–23 hours. <ul style="list-style-type: none"> <li>• Select START HOUR by pressing the WHITES AND COLORS button.</li> <li>• Press the PERM. PRESS button once to advance to next code.</li> </ul>																								
8. 00	<b>SPECIAL PRICE STOP HOUR</b> <b>NOTE:</b> Uses military time or 24 hr. clock.																								
8. 00	This is the stop hour, 0–23 hours. <ul style="list-style-type: none"> <li>• Select STOP HOUR by pressing the WHITES AND COLORS button.</li> <li>• Press the PERM. PRESS button once to advance to next code.</li> </ul>																								
9. 10	<b>SPECIAL PRICE DAY</b>																								
9. 10	This represents the day of the week and whether special pricing is selected for that day. A number followed by “0” indicates no selection that particular day (9. 10). A number followed by an “S” indicates selected for that day (9. 1S). Days of the week (1–7) are selected by pressing the WHITES AND COLORS button. Press the DELICATES button once to select special pricing for each day chosen.																								
When exiting set-up code “9.,” the display must show the current day of week:																									
	<table border="1"> <thead> <tr> <th>DISPLAY</th> <th>DAY OF WEEK</th> <th>CODE (selected)</th> </tr> </thead> <tbody> <tr> <td>10</td> <td>Day 1 = Sunday</td> <td>1S</td> </tr> <tr> <td>20</td> <td>Day 2 = Monday</td> <td>2S</td> </tr> <tr> <td>30</td> <td>Day 3 = Tuesday</td> <td>3S</td> </tr> <tr> <td>40</td> <td>Day 4 = Wednesday</td> <td>4S</td> </tr> <tr> <td>50</td> <td>Day 5 = Thursday</td> <td>5S</td> </tr> <tr> <td>60</td> <td>Day 6 = Friday</td> <td>6S</td> </tr> <tr> <td>70</td> <td>Day 7 = Saturday</td> <td>7S</td> </tr> </tbody> </table> <ul style="list-style-type: none"> <li>• Press the PERM. PRESS button once to advance to next code.</li> </ul>	DISPLAY	DAY OF WEEK	CODE (selected)	10	Day 1 = Sunday	1S	20	Day 2 = Monday	2S	30	Day 3 = Tuesday	3S	40	Day 4 = Wednesday	4S	50	Day 5 = Thursday	5S	60	Day 6 = Friday	6S	70	Day 7 = Saturday	7S
DISPLAY	DAY OF WEEK	CODE (selected)																							
10	Day 1 = Sunday	1S																							
20	Day 2 = Monday	2S																							
30	Day 3 = Tuesday	3S																							
40	Day 4 = Wednesday	4S																							
50	Day 5 = Thursday	5S																							
60	Day 6 = Friday	6S																							
70	Day 7 = Saturday	7S																							
A. 00	<b>VAULT VIEWING OPTION</b> This option is either NOT SELECTED “OFF” or SELECTED “ON.”																								
A. 00	Not Selected “OFF.”																								
A. SC	Selected “ON.” <ul style="list-style-type: none"> <li>• Press the DELICATES button once to change this selection. When selected, the money and/or cycle counts will be viewable (if counter option(s) is selected) when the coin box is removed.</li> <li>• Press the PERM. PRESS button once to advance to next code.</li> </ul>																								

Code	Explanation
b. 05	<b>VALUE OF COIN 1</b>
b. 05	This represents the value of coin 1 in the quantity of 5% increments of the larger coin value. $5 \times 5\% = 25\%$ . <ul style="list-style-type: none"> <li>• By pressing the WHITES AND COLORS button, there is an option of 1–199 for the quantity of 5% increments. With coin slide activation, this represents the total vend price.</li> <li>• Press the PERM. PRESS button once to advance to next code.</li> </ul>
C. 20	<b>VALUE OF COIN 2</b>
C. 20	This represents the value of coin 2 in the quantity of 5% increments of the larger coin value. $20 \times 5\% = 100\%$ . By pressing the WHITES AND COLORS button, there is the option of 1–199 for the quantity of 5% increments. C. 05 <b>PN MODELS:</b> This represents the value of coin 2 in the quantity of 5% increments of the larger coin value. Factory default = $5 \times 5\%$ of the larger coin value. <b>PN MODELS USING ENHANCED DEBIT:</b> This represents the value of top off in quantity of 5% increments of the larger coin value. Factory default = $5 \times 5\%$ of the larger coin value. <ul style="list-style-type: none"> <li>• Press the PERM. PRESS button once to advance to next code.</li> </ul>
d. 00	<b>COIN SLIDE OPTION</b> This option is either NOT SELECTED “OFF” or SELECTED “ON.” Replacement of metercase will be needed for coin slide mounting.
d. 00	Not Selected “OFF.”
d. CS	Selected “ON.” <b>NOTE:</b> This option needs to be set to “00” unless the metercase has been changed to accept a coin slide device. <ul style="list-style-type: none"> <li>• Press the DELICATES button 3 consecutive times for this selection. When coin slide mode is selected, set “b.” equal to value of slide in coins. Set “6 xx” (REGULAR CYCLE PRICE) and “3.xx” (SPECIAL CYCLE PRICE) to number of slide operations. 6 01 and 3. 01 = 1 slide push.</li> </ul> <b>NOTE:</b> If the installer sets up “CS” on a coin drop model, it will not register coins. <ul style="list-style-type: none"> <li>• Press the PERM. PRESS button once to advance to next code.</li> </ul>
E. 00	<b>ADD COINS OPTION</b> This option is either NOT SELECTED “OFF” or SELECTED “ON.” This option causes the customer display to show the number of coins (coin 1) to enter, rather than the amount.
E. 00	Not Selected “OFF.”
E. AC	Selected “ON.” <ul style="list-style-type: none"> <li>• Press the DELICATES button 3 consecutive times to change this selection.</li> </ul> <b>PN MODELS:</b> This option is not selectable. <ul style="list-style-type: none"> <li>• Press the PERM. PRESS button once to advance to next code.</li> </ul>



# ELECTRONIC CONTROL SETUP INSTRUCTIONS

Code	Explanation
J. Cd	<b>PAYMENT MODE (COIN/DEBIT OPTION)</b>
J. Cd	Both coin and debit selected. (NOT AVAILABLE)
J. C_	Coins selected, debit disabled. Press the DELICATES button 3 consecutive times to change this selection.
J._d	<b>PN models:</b> Factory default to J._d. Debit Card selected, coins disabled. Press the DELICATES button 3 consecutive times to change this selection.
J. Ed	Enhanced Debit is self-selected when a Generation 2 card reader is installed in the dryer. The Ed option cannot be manually selected or deselected. (NOT AVAILABLE) <ul style="list-style-type: none"> <li>• Press the PERM. PRESS button once to advance to next code.</li> </ul>
L. 00	<b>PRICE SUPPRESSION OPTION</b> This option is either NOT SELECTED "OFF" OR SELECTED "ON." This option causes the customer display to show "ADD" or "AVAILABLE" rather than the amount of money to add. (Used mainly in debit installations.)
L. 00	Not Selected "OFF."
L. PS	Selected "ON." <ul style="list-style-type: none"> <li>• Press the DELICATES button once to change this selection.</li> <li>• Press the PERM. PRESS button once to advance to next code.</li> </ul>
n. CE	<b>CLEAR ESCROW OPTION</b> This option is either NOT SELECTED "OFF" OR SELECTED "ON." When selected, money held in escrow for 30 minutes without further escrow or cycle activity will be cleared.
n. 00	Not Selected "OFF."
n. CE	Selected "ON." <ul style="list-style-type: none"> <li>• Press the DELICATES button once to change this selection.</li> <li>• Press the PERM. PRESS button once to advance to next code.</li> </ul>

Code	Explanation
U. 00	<b>COIN INCREMENT OFFSET</b>
U. 00	This represents the hundredth increment price offset used in Generation 2 (Enhanced Debit) PN models. Choose from 0–4 hundredths by pressing the WHITES AND COLORS button. (NOT AVAILABLE) <ul style="list-style-type: none"> <li>• Press the PERM. PRESS button once to advance to next code.</li> </ul>

END of SET-UP PROCEDURES.

## EXIT FROM SET-UP MODE

- PD MODELS: Reinstall access door.
- PN Models where AA1 plug was removed:
  1. Unplug dryer or disconnect power.
  2. Open console, reinsert jumper into AA1, and close console.
  3. Plug in dryer or reconnect power.
- PN WITH PROGRAMMING SWITCH: Turn key clockwise and remove.
- If Service Access Code was used to enter set-up mode: From Set-up Code 8, press button #1 for 4 seconds, wait 2 minutes without touching any buttons (without diagnostic modes running), or power down the dryer; then reapply power.

# MAYTAG® COMMERCIAL WASHER, DRYER, STACKED DRYER/DRYER, COMMERCIAL STACK LAUNDRY, AND MULTI-LOAD COIN OPERATED COMMERCIAL WASHERS AND DRYERS WARRANTY

---

## LIMITED WARRANTY (PARTS ONLY – LABOR NOT INCLUDED)

For the first five years from the original date of purchase, when this commercial appliance is installed, maintained, and operated according to the instructions attached to or furnished with the product, Maytag brand of Whirlpool Corporation (hereafter “Maytag”) will pay for factory specified replacement parts to correct defects in materials or workmanship that existed when this commercial appliance was purchased. This limited warranty does not include labor.

YOUR SOLE AND EXCLUSIVE REMEDY UNDER THIS LIMITED WARRANTY SHALL BE PRODUCT REPAIR AS PROVIDED HEREIN. Maytag recommends that you use an “in network” service provider to diagnose and repair your Commercial Laundry product. Maytag will not be responsible under this warranty to provide additional replacement parts as a result of incorrect diagnosis or repair by an “out of network” service company. This limited warranty is valid in the United States or Canada and applies only when the commercial appliance is used in the country in which it was purchased. This limited warranty is effective from the date of the original consumer purchase. Proof of original purchase date is required to obtain service under this limited warranty.

---

## ITEMS EXCLUDED FROM WARRANTY

### This limited warranty does not cover:

1. All other costs including labor, transportation, shipping, or custom duties for covered parts.
2. Factory specified replacement parts if this commercial appliance is used for other than normal, commercial use or when it is used in a manner that is inconsistent to published user or operator instructions and/or installation instructions.
3. Service calls to correct the installation of your commercial appliance, to instruct you on how to use your commercial appliance, to replace or repair house fuses, or to correct external wiring or plumbing.
4. Damage resulting from improper handling of product during delivery, theft, accident, alteration, misuse, abuse, fire, flood, acts of God, improper installation, installation not in accordance with local electrical or plumbing codes, or use of products not approved by Maytag.
5. Pick up and delivery. This commercial appliance is designed to be repaired on location.
6. Repairs to parts or systems resulting from unauthorized modifications made to the commercial appliance.
7. The removal and reinstallation of your commercial appliance if it is installed in an inaccessible location or is not installed in accordance with published installation instructions.
8. Damage resulting from exposure to chemicals.
9. Changes to the building, room, or location needed in order to make the commercial appliance operate correctly.
10. Factory specified replacement parts on commercial appliances with original model/serial numbers that have been removed, altered, or cannot be easily determined.
11. Discoloration, rust, or oxidation of stainless steel surfaces.
12. Factory specified replacement parts as a result of incorrect diagnosis or repair by an “out of network” service company.

**The cost of repair or replacement under these excluded circumstances shall be borne by the customer.**

---

## DISCLAIMER OF IMPLIED WARRANTIES

IMPLIED WARRANTIES, INCLUDING ANY IMPLIED WARRANTY OF MERCHANTABILITY OR IMPLIED WARRANTY OF FITNESS FOR A PARTICULAR PURPOSE, ARE LIMITED TO ONE YEAR OR THE SHORTEST PERIOD ALLOWED BY LAW. Some states and provinces do not allow limitations on the duration of implied warranties of merchantability or fitness, so this limitation may not apply to you. This warranty gives you specific legal rights, and you also may have other rights that vary from state to state or province to province.

---

## DISCLAIMER OF REPRESENTATIONS OUTSIDE OF WARRANTY

Maytag makes no representations about the quality, durability, or need for service or repair of this commercial appliance other than the representations contained in this Warranty. If you want a longer or more comprehensive warranty than the limited warranty that comes with this commercial appliance, you should ask Maytag or your retailer about buying an extended warranty.

---

## LIMITATION OF REMEDIES; EXCLUSION OF INCIDENTAL AND CONSEQUENTIAL DAMAGES

YOUR SOLE AND EXCLUSIVE REMEDY UNDER THIS LIMITED WARRANTY SHALL BE PRODUCT REPAIR AS PROVIDED HEREIN. MAYTAG SHALL NOT BE LIABLE FOR INCIDENTAL OR CONSEQUENTIAL DAMAGES. Some states and provinces do not allow the exclusion or limitation of incidental or consequential damages, so these limitations and exclusions may not apply to you. This warranty gives you specific legal rights, and you also may have other rights that vary from state to state or province to province.

---

If you need service, please contact your authorized Maytag Commercial Laundry® distributor. To locate your authorized Maytag Commercial Laundry® distributor, call 1-800-662-3587, or for web inquiries, visit [www.MaytagCommercialLaundry.com](http://www.MaytagCommercialLaundry.com).

02/14

For written correspondence:  
Maytag Commercial Laundry® Service Department  
2000 N M 63  
Benton Harbor, Michigan 49022-2632 USA

®/TM © 2015 Maytag. All rights reserved.  
®/TM © 2015 Maytag. Tous droits réservés.  
®/TM © 2015 Maytag. Todos los derechos reservados.  
®/TM © 2015 Maytag. Tutti i diritti riservati.