

FRIGIDAIRE

All about the

Use & Care

of your Wall Oven

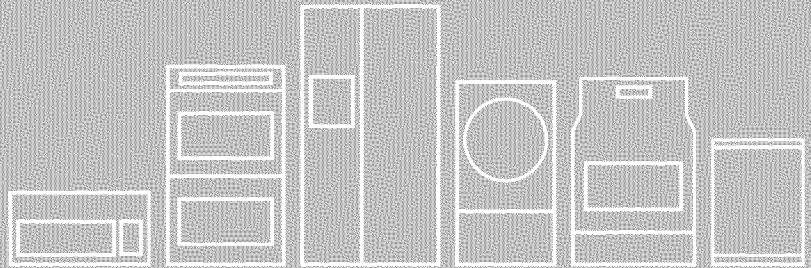

TABLE OF CONTENTS

Product Record and Registration	2	Care and Cleaning	31
Important Safety Instructions	3	before you call	34
Before Setting Oven Controls	7	Warranty	36
Oven Controls	8		

PRODUCT RECORD AND REGISTRATION

Need Help?	2
Product Registration	2
Product Record and Registration	2
Important Safety Instructions	3
Before Setting Oven Controls	7
Oven Controls	8
Setting the Clock	9
Temperature Display (Fahrenheit/Celsius)	10
Setting Preheat	11
Setting Bake	12
Setting Broil	13
Setting Convection Bake	15
Setting Convection Convert	16
Setting Convection Broil	17
Setting Convection Roast	18
Setting Bake Time	19
Setting Warm	20
Cooking with Meat Probe	22
Setting Slow Cook (some models)	25
Restoring Factory Default Setting	26
Setting the Sabbath Feature	27
Steam Clean	28
Self-Cleaning Operation	29
Care and Cleaning	31
Removing and Replacing the Oven Door	32
Replacing the oven light	33
before you call	34
Solutions to Common Problems	35
Warranty	36

Need Help?

Visit the Frigidaire web site at www.frigidaire.com

Before you call for service, there are a few things you can do to help us serve you better.

Read this Use & Care Manual

This manual contains instructions to help you use and maintain your oven properly.

If You Received a Damaged Oven...

Immediately contact the dealer (or builder) that sold you the oven.

Save Time and Money

Check the section title "Solutions to Common Problems" on page 35. This section helps step you through some common problems that might occur.

If you do need service, help is only a phone call away. Call Frigidaire customer services at **1-800-944-9044**.

Product Registration

Registering your product with Frigidaire enhances our ability to serve you. You can register online at <http://www.frigidaire.com> or by dropping your product registration card in the mail.

Record model and serial numbers here

Purchase Date: _____

Frigidaire model number: _____

Frigidaire serial number: _____

Serial Plate Location

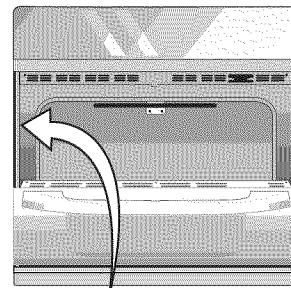

Questions?

For toll-free telephone support in the U.S. and Canada call **1-800-944-9044**

For online support and Internet production information visit <http://www.frigidaire.com>.

Thank you for choosing Frigidaire.

This Use & Care manual is part of our commitment to customer satisfaction and product quality throughout the service life of your new appliance. We view your purchase as the beginning of a relationship. To ensure our ability to continue serving you, please use this page to record important product information.

IMPORTANT SAFETY INSTRUCTIONS

CAUTIONS AND WARNINGS

Read all instructions before using this appliance.

This manual contains important safety symbols and instructions. Please pay attention to these symbols and follow all instructions given.

Do not attempt to install or operate your appliance until you have read the safety precautions in this manual. Safety items throughout this manual are labeled with a WARNING or CAUTION statement based on the risk type.

DEFINITIONS

 This is the safety alert symbol. It is used to alert you to potential personal injury hazards. Obey all safety messages that follow this symbol to avoid possible injury or death.

WARNING

Indicates a potentially hazardous situation which, if not avoided, may result in death or serious injury.

CAUTION

Indicates a potentially hazardous situation which, if not avoided, may result in minor or moderate injury.

IMPORTANT

Indicates installation, operation, maintenance, or valuable information that is not hazard related.

NOTE

Indicates a short, informal reference—something written down to assist the memory or for future reference.

WARNING

Storage In or On Appliance—Flammable materials should not be stored in an oven or near surface units. This includes paper, plastic, and cloth items, such as cookbooks, plastic ware, and towels, as well as flammable liquids. Do not store explosives, such as aerosol cans, on or near the wall oven.

WARNING

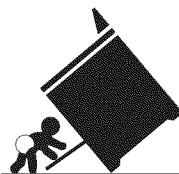

Tip Over Hazard

- **A child or adult can tip the oven and be killed.**
- **Install the anti-tip device to oven and/or structure per installation instructions.**
- **Ensure the anti-tip device is re-engaged when the oven is moved.**
- **Do not operate the oven without the anti-tip device in place and engaged.**
- **Failure to follow these instructions can result in death or serious burns to children and adults.**

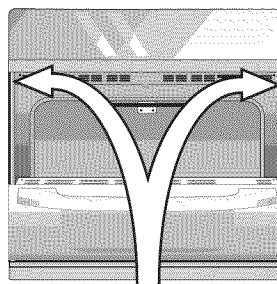

Refer to the installation instructions supplied with your appliance for proper installation.

Anti-tip mounting holes

Check for proper installation with a visual check that the anti-tip screws are present. Test the installation with light downward pressure on the open oven door. The oven should not tip forward.

IMPORTANT SAFETY INSTRUCTIONS

WARNING

- Do Not Leave Children Alone - Children should not be left alone or unattended in the area where appliance is in use. They should never be allowed to sit or stand on any part of the appliance, including the storage drawer, lower broiler drawer, warmer drawer, or lower double oven.
- Stepping, leaning, or sitting on the door or drawers of a oven can result in serious injuries and also cause damage to the appliance. Do not allow children to climb or play around the oven. The weights of a child on an open over door may cause the oven to tip, resulting in serious burns or other injury.
- Never cover any slots, holes, or passages in the oven bottom or cover an entire oven rack with materials, such as aluminum foil. Aluminum foil linings may trap heat, causing a fire hazard.

IMPORTANT

Important Safety Notice - The California Safe Drinking Water and Toxic Enforcement Act requires the governor of California to publish a list of substances known to cause cancer, birth defects, or other reproductive harms, and requires businesses to warn customers of potential exposures to such substances.

Cold temperatures can damage the electronic control. When using this appliance for the first time, or when the appliance has not been used for an extended period of time, be sure the appliance has been in temperatures above 32°F (0°C) for at least 3 hours before turning on the power to the appliance.

Do not attempt to operate the oven during a power failure. If the power fails, always turn off the oven. If the oven is not turned off and the power resumes, the oven will begin to operate again. Once the power resumes, reset the clock and oven function.

CAUTION

- When heating fat or grease, watch it closely. Grease may catch fire if it becomes too hot.
- Do not use water or flour on grease fires. Smother fire or flame or use dry chemical or foam-type extinguisher. Cover the fire with a pan lid or use baking soda.
- Use dry potholders. Moist or damp potholders on hot surfaces may result in burns from steam. Do not let potholders touch hot cooking areas. Do not use towels or other bulky cloths.
- Do Not Heat Unopened Food Containers - Build-up of pressure may cause container to burst and result in injury.
- Wear Proper Apparel - Loose-fitting or hanging garments should never be worn while using the appliance.
- DO NOT TOUCH HEATING ELEMENTS OR INTERIOR SURFACES OF OVEN - Heating elements may be hot even though they are dark in color. Interior surfaces of an oven become hot enough to cause burns. During and after use, do not touch, or let clothing or other flammable materials contact heating elements or interior surfaces of oven until they have had sufficient time to cool. Other surfaces of the appliance may become hot enough to cause burns - among these surfaces are (identification of surfaces - for example, oven vent openings and surfaces near these openings, oven doors, and windows of oven doors).

IMPORTANT SAFETY INSTRUCTIONS

IMPORTANT

Read and follow the below instructions and precautions for unpacking, installing, and servicing your appliance:

- Remove all tape and packaging before using the oven. Destroy the carton and plastic bags after unpacking the oven. Never allow children to play with packaging material.
- Proper Installation—Be sure your appliance is properly installed and grounded by a qualified technician in accordance with the National Electrical Code ANSI/NFPA No. 70 latest edition and local electrical code requirements. In Canada, install in accordance with CSA Standard C22.1, Canadian Electrical code, Part 1, and local electrical code requirements. Install only per installation instructions provided in the literature package for this oven.
- User Servicing—Do not repair or replace any part of the appliance unless specifically recommended in the manuals. All other servicing should be done only by a qualified technician. This reduces the risk of personal injury and damage to the oven.
- Ask your dealer to recommend a qualified technician and an authorized repair service. Know how to disconnect the power to the oven at the circuit breaker or fuse box in case of an emergency.
- Never modify or alter the construction of an oven by removing the leveling legs, panels, wire covers, anti-tip brackets/screws, or any other part of the oven.
- Remove the oven door from any unused oven if it is to be stored or discarded.
- Be sure to have an appropriate foam-type fire extinguisher available, visible, and easily accessible located near the appliance.

IMPORTANT INSTRUCTIONS FOR USING YOUR OVEN

- Never use your appliance for warming or heating the room.
- Use care when opening oven door, lower oven door, or warmer drawer (some models). Stand to the side of the oven when opening the door of a hot oven. Let hot air or steam escape before you remove or replace food in the oven.
- Keep oven vent ducts unobstructed. Touching surfaces in this area when the oven is on may cause severe burns. Do not place plastic or heat-sensitive items on or near the oven vent. These items can melt or ignite.
- Placement of Oven Racks - Always place oven racks in desired location while oven is cool. If rack must be moved while oven is hot, do not let potholder contact hot heating element in oven. Use potholders and grasp the rack with both hands to reposition. Do not let potholders contact the hot heating elements in the oven. Remove all cookware and utensils before moving the rack.
- Do not use a broiler pan without its insert. Broiler pans and inserts allow dripping fat to drain away from the high heat of the broiler. Do not cover the broiler insert with aluminum foil; exposed fat and grease could ignite.
- Protective Liners - Do not use aluminum foil to line surface unit drip bowls or oven bottoms, except as suggested in the manual. Improper installation of these liners may result in a risk of electric shock, or fire.
- Do not cook food on the oven bottom. Always cook in proper cookware and always use the oven racks.

IMPORTANT SAFETY INSTRUCTIONS

IMPORTANT INSTRUCTIONS FOR CLEANING YOUR OVEN

CAUTION

Before manually cleaning any part of the oven, be sure all controls are turned off and the oven is cool. Cleaning a hot oven can cause burns.

- Clean the oven regularly to keep all parts free of grease that could catch fire. Do not allow grease to accumulate.
- Always follow the manufacturer's recommended directions for use of kitchen cleaners and aerosols. Be aware that excess residue from cleaners and aerosols may ignite causing damage and injury.
- Clean ventilating hoods frequently. Grease should not be allowed to accumulate on the hood or filter. Follow the manufacturer's instructions for cleaning hoods.

SELF-CLEANING OVENS

- Clean only the parts listed in this manual. Before using self-clean, remove the broiler pan, any food, utensils, and cookware from the oven. Remove oven racks unless otherwise instructed.
- Do not use oven cleaners. No commercial oven cleaner or oven liner protective coating of any kind should be used in or around any part of the oven.
- Do not clean the oven door gasket. The door gasket is essential for a good seal. Care should be taken not to rub, damage, or move the gasket.
- Some birds are extremely sensitive to the fumes given off during the self-clean cycle of any oven. Move birds to another well-ventilated room.

GROUNDING INSTRUCTIONS

WARNING

Avoid fire hazard or electrical shock. Failure to follow this warning may cause serious injury, fire, or death.

This appliance must be supplied with the proper voltage and frequency, and connected to an individual, properly grounded branch circuit, protected by a circuit breaker or fuse.

It is the responsibility and obligation of the consumer to contact a qualified installer to assure that the electrical installation is adequate and is in conformance with all local codes and ordinances.

See the installation instructions packaged with this appliance for complete installation and grounding instructions.

BEFORE SETTING OVEN CONTROLS

Oven vent location

The oven vent is located under the control panel. When the oven is on, warm air passes through this vent. This venting is necessary for proper air circulation in the oven and good baking results. Do not block oven vent.

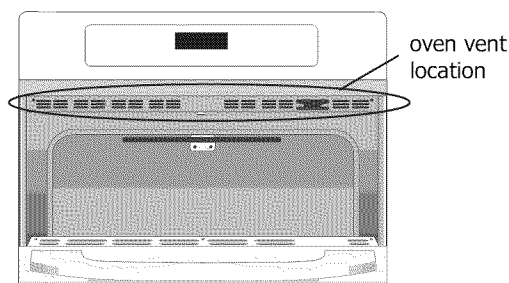

Figure 1: Do not block oven vent location

CAUTION

Always use pot holders or oven mitts when using the oven. When cooking, the oven interior and exterior, oven racks, and cooktop will become very hot which can cause burns.

WARNING

Protective Liners — Do not use aluminum foil to line the oven bottom. Only use aluminum foil as recommended in this manual. Improper installation of these liners may result in risk of electric shock or fire.

Removing, replacing, and arranging flat or offset oven racks

To arrange - Always arrange the oven racks when the oven is cool (prior to operating the oven).

To remove - Pull the oven rack straight forward until it reaches the stop position. Lift up front of oven rack slightly and slide out.

To replace - Place the oven rack on the rack guides on both sides of oven walls. Tilt the front of oven rack upward slightly and slide the oven rack back into place. Be sure oven racks are level before using.

Important: It is recommended to remove all non-porcelain oven racks from the oven during self-clean cycles. Racks left in oven cavity during self clean may discolor and no longer slide easily.

Type of oven racks

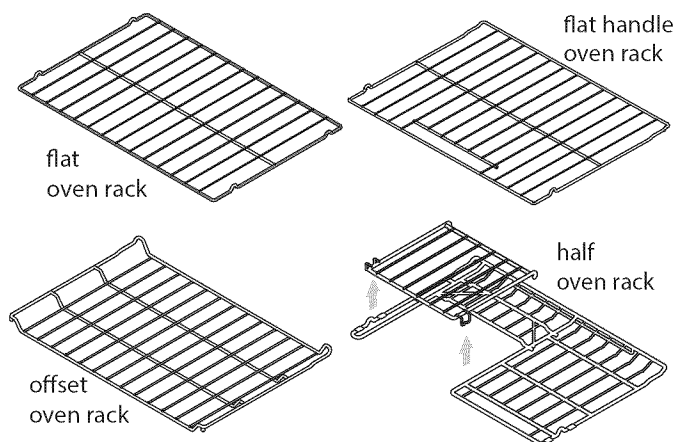

Figure 2: Oven rack types

Oven Rack Descriptions

- Flat oven racks (or the flat handle oven rack) may be used for most cooking needs and may be placed in most oven rack positions.
- The offset oven rack (some models) provides additional stepdown positions from the standard flat rack design. The offset design positions the base of the rack about 1/2 of a rack position lower than the flat rack and may be used in most oven rack positions.
- The half rack (some models) design comes with a removable section that allows for taller cooking utensils.

Air circulation in the oven

For best air circulation when baking, allow a space of 2 inches (5 cm) around the cookware for proper air circulation. Be sure pans and cookware do not touch each other, the oven door, sides, or back of the oven cavity.

Hot air must be able to circulate around cookware for even heat to reach the food.

OVEN CONTROLS

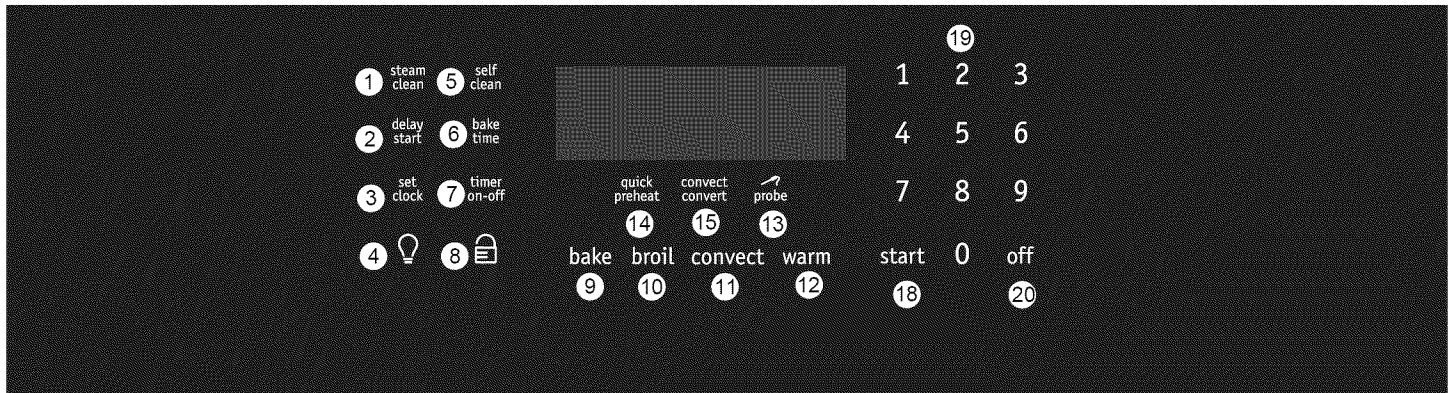

Gallery Model (above) Professional Model (below)

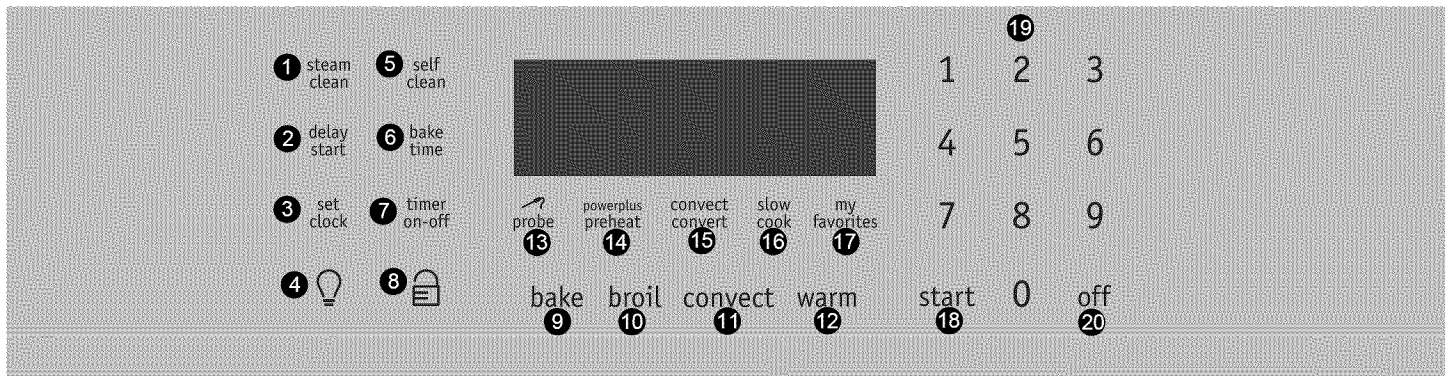

Oven Controls Features

To get the best use of your oven, take some time to become familiar with the various features and functions of your oven model. Detailed instructions on using each oven feature and function of the controls can be found in this section of the owner's manual.

1. **Steam Clean** — Use for steam clean function.
2. **Delay Start** — Use to program a delayed time bake or delayed self-cleaning cycle start time.
3. **Set Clock** — Use along with the numeric keypad to set the time of day.
4. **Oven Light** — Use to turn the oven light on and off.
5. **Self Clean** — Use to select self-clean function.
6. **Bake Time** — Use to enter the length of baking time.
7. **Timer on-off** — Use to set or cancel the timer. Timer does not start or stop the cooking process.
8. **Oven Lockout** — Use to lock the oven door and the control panel.
9. **Bake** — Use to select the bake cooking feature.
10. **Broil** — Use to select broil cooking feature.
11. **Convect** — Use to select between convection bake, convection roast, and convection broil (some models).
12. **Warm** — Use to keep food and dishes warm until served.
13. **Probe** — Use to monitor internal temperature of food for required doneness.
14. **Quick Preheat (Gallery Mode)/Powerplus Preheat (Professional Model)** — Use to raise oven to preheat temperature.
15. **Convect Convert** — Use to convert regular recipe temperature to convection recipe temperature.
16. **Slow Cook** (some models) — Use for cooking foods requiring long cooking times with lower temperatures.
17. **My Favorites** (some models) — Use to program and save favorite recipes settings.
18. **Start** — Use for starting all cooking features.
19. **Numeric Keypad** — Use to enter temperatures and times.
20. **Off** — Use to turn off any oven function entered except time of day and minute timer.

OVEN CONTROLS

Table 1: Minimum and maximum control settings

Feature	Mode	Minimum Temp. /Time	Maximum Temp. /Time
Preheat		170°F (77°C)	550°F (288°C)
Bake		170°F (77°C)	550°F (288°C)
Broil		400°F (205°C)	550°F (288°C)
Convection Bake		170°F (77°C)	550°F (288°C)
Convection Roast		170°F (77°C)	550°F (288°C)
Convection Broil		400°F (205°C)	550°F (288°C)
Slow Cook		Lo 225°F (108°C)	Hi 275°F (135°C)
Meat Probe		Lo 140°F (60°C)	Hi 210°F (99°C)
Timer	12 Hr. Mode 24 Hr. Mode	0:01 Min. 0:01 Min	11:59 Hr./Min. 11:59 Hr./Min.
Clock Time	12 Hr. Mode 24 Hr. Mode	1:00 Hr./Min. 0:00 Min	12:59 Hr./Min. 23:59 Hr./Min.
Delay Start	12 Hr. Mode 24 Hr. Mode	1:00 Hr./Min. 0:00 Min	12:59 Hr./Min. 23:59 Hr./Min
Bake Time	12 Hr. Mode 24 Hr. Mode	0:01 Min 0:01 Min	5:59 Hr./Min. 5:59 Hr./Min.
Self Clean Time		2 hours	4 hours

Setting the Clock

The set clock control is used to set the clock. The clock may be set for 12 or 24 hours display operation. The clock is preset at the factory for 12 hour display. When the oven is first plugged in, or when the power supply to the oven has been interrupted, the timer in the display will flash.

To set the clock (example below for 1:30):

1. Press **set clock**. **CLO** will appear in the display.
2. Press **1 3 0** on the keypad to set the time of day to 1:30. **CLO** will stay in the display.
3. Press **start**. **CLO** will disappear and the clock will start.

Setting 12 or 24 Hour Time of Day Display

1. Press and hold **set clock** for 6 seconds. **CLO** will appear in the display.
2. Continue holding the key until **12Hr dAY** or **24Hr dAY** appears in the display and the control beeps once.
3. Press **self clean** to switch between the 12 and 24 hour time of day display. The display will show either **12Hr dAY** or **24Hr dAY**.
4. Press **start** to accept the change or press **off** to reject the change.
5. Reset the correct time as described in this section. If the 24 hour time of day mode was chosen, the clock will display time from 0:00 through 23:59 hours.

OVEN CONTROLS

Setting Continuous Bake or 6 Hour Energy Saving

The **timer on-off** and **self clean** keys control the continuous bake or 6 hour energy saving features. The oven control has a factory preset 6 Hour Energy Saving feature that shuts off the oven if the oven control is left on for more than 6 hours. The oven can be programmed to override this feature for Continuous Baking.

To set the control for continuous bake or 6 hour energy saving:

1. Press and hold **timer on-off** for 6 seconds. After 6 seconds **6Hr OFF** or **StAY On** will appear in the display and the control will beep once.
2. Press **self clean** to switch between the 6 hour energy saving and continuous bake features.
3. Press **start** to accept the change (display will return to time of day) or press **off** to reject the change.

6Hr OFF indicates the control is set for the 6 hour energy saving mode. **StAY On** indicates the control is set for the continuous bake feature.

Temperature Display (Fahrenheit/Celsius)

The **broil** and **self clean** keys control the Fahrenheit (°F) or Celsius (°C) temperature display modes. The oven control can be programmed to display temperatures in °F or °C. The oven is preset at the factory to display in °F.

To change display from °F to °C or °C to °F

1. To tell if the display is set for °F or °C, press **broil** and hold for 6 seconds. **550°** will appear, **broil** will flash in the display, and a beep will sound. If **F** appears, the display is set to show temperatures in °F. If **C** appears, the display is set to show temperatures in °C.
2. Press **self clean** to switch between °F or °C display modes. The display will show either **F** or **C**.
3. Press **start** to accept the change or press **off** to reject the change.

Setting Control for Silent Operation

Delay start and **self clean** keys control the silent control operation feature. The silent control operation feature allows the oven control to be operated without sounds or beeps whenever necessary. If desired the control can be programmed for silent operation and later returned to operating with all the normal sounds and beeps.

To change control from normal sound operation to silent control operation:

1. To set oven for normal or silent operation, press and hold **delay start**. **-- --** will appear and **DELAY** will flash in the display. After 6 seconds **bEEP On** or **bEEP OFF** will appear in the display.
2. Press **self clean** to switch between normal sound operation and silent operation mode. The display will show either **bEEP On** or **bEEP OFF**. If **bEEP On** appears, the control will operate with normal sounds and beeps. If **bEEP OFF** appears, the control is in the silent operation mode.
3. Press **start** to accept the change or press **off** to reject the change.

NOTE

The control will always beep at the end of a minute timer and will beep when a set temperature has been reached, even if the control is set to silent operation.

Setting the Timer

The **timer on-off** key controls the minute timer and serves as an extra timer and can be used during any of the other oven control functions.

To set the minute timer:

1. Press **timer on-off**. **-- --** will appear and **timer** will flash in the display. Press the number keys to set the desired time.
2. Press **start**. The time will begin to count down and **Timer** will stay in the display. When the time expires, **End** and **Timer** will show in the display. The clock will beep three times every 30 seconds until **timer on-off** is pressed.
3. To cancel the minute timer before the set time expires, press **timer on-off**.



NOTE

If **start** is not pressed, the timer will return to the time of day after 25 seconds. The timer does not start or stop the cooking process.

Setting Oven Lockout Feature

The  key controls the oven lockout. When active, this feature automatically locks the oven door, preventing the oven from being turned on. It does not affect the clock, timer, or the interior oven lights.

To activate the oven lockout feature:

1. Press and hold  for 3 seconds.
2. After 3 seconds, **door Loc** will appear, a tone will sound, and the word **DOOR** and the  icon will flash.
3. Once locked, **DOOR** and the lock icon will stop flashing and remain visible with the Loc.

To reactivate normal oven operation:

1. Press and hold  for 3 seconds.
2. After 3 seconds, **door Loc** will appear, a tone will sound, and the word **DOOR** and the lock icon will flash in the display until the oven door has completely unlocked.
3. The oven is now fully operational.

Oven Light

The oven is equipped with two oven lights. The oven lights will turn on automatically when the oven door is opened.

The oven light may be turned on when the door is closed by using the oven light key on the control panel. The light will stay off until the door unlocks.

NOTE

The oven light will not operate during the self clean function.

To toggle the oven lights on and off:

1. Press .
2. The interior oven lights are covered with a glass shield. The glass shield must be in place whenever the oven is in use. To change the interior oven lights, see "Replacing the oven light" on page 33.

Setting Preheat

The **powerplus preheat/quick preheat** feature is used when a recipe calls for preheating the oven. When the preheat stage ends, a tone will sound indicating when to place the food in the oven. Preheat can be programmed for temperatures between 170°F to 550°F and is not necessary when roasting or cooking casseroles.

For batter and dough-based goods such as cakes, pastries, and breads, use the regular bake or convection function for best results.

To set the preheat temperature for 350°F:

1. Arrange the interior oven racks.
2. Press **powerplus preheat/quick preheat. 350** will appear in the display. Press **start**.
3. **350** and **PREHEAT** will be displayed while the oven is preheating.
4. Press **off** when baking is complete or to cancel the preheat feature.

To change preheat temperature while oven is preheating (ex: changing from 350°F to 425°F):

1. Press **powerplus preheat/quick preheat. 350** will appear in the display.
2. Enter the new preheat temperature. Press **4 2 5**.
3. Press **start. 425** will show in the display.
4. When baking is complete, press **off**.

NOTE

- A beep will sound once the oven temperature reaches **425°F**.
- Once the oven reaches the set temperature, the control beeps and the word **PREHEAT** turns off. The bake feature will display the set oven temperature and will continue cooking at the set bake temperature.
- When preheated, place food in the oven. During preheat, the convection fan is active during the first rise in temperature to allow oven to reach its target temperature faster. The bake, broil, and convection elements will also cycle for a better heat distribution.

OVEN CONTROLS

Setting Bake

Bake controls normal baking. If a rapid preheating is preferred, refer to “Setting Preheat” on page 11. The oven can be programmed to bake at any temperature from 170°F to 550°F.

To set the bake temperature to 375°F:

CAUTION

Always use pot holders or oven mitts when using the oven. When cooking the oven interior, oven racks, and cooktop will become very hot which can cause burns.

CAUTION

Do not bake foods directly on the oven bottom. To avoid damaging the oven interior and surfaces, always bake foods in the oven using bakeware positioned on an oven rack.

1. Arrange interior oven racks.
2. Press **bake**. **350** will appear in the display.
3. Press **3 7 5**.
4. Press **start**. The actual temperature will be displayed. A beep will sound once the oven temperature reaches 375°F, and the display will show **375°**.
5. When preheated, place food in oven.

NOTE

Pressing **Off** at any time will stop the feature.

To change the bake temperature (example: changing from 375°F to 425°F):

1. After the oven has already been set to bake at 375°F and the oven temperature needs to be changed to 425°F, press **bake** and **375** will appear in the display.
2. Press **4 2 5**.
3. Press **start**.

Baking Tips

For best bake results:

- Fully preheat the oven before baking items like cookies, cakes, biscuits, and breads.
- When using any single rack, position the rack so that the food is in the center of the oven.
- For best results when baking cakes using two oven racks, place racks in positions 2 and 4 (Figure 3).
- When baking using two oven racks, position cookware as shown in Figure 4. Allow at least 2 inches (5 cm) of space between cookware for proper air circulation.
- Dark or dull bakeware absorbs more heat than shiny bakeware. It may be necessary to reduce oven temperature and cook time to prevent overbrowning of some foods. Dark bakeware is recommended for pies. Shiny bakeware is recommended for cakes, cookies, and muffins.
- For batter and dough-based baked goods such as cakes, pastries, and breads, use the convection function for best results.
- Do not open the oven door too often. Opening the door will reduce the temperature in the oven.
- Glass bakeware is a slow heat conductor. May require reducing oven temperature.

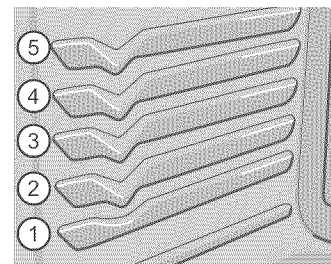

Figure 3: Oven rack positions

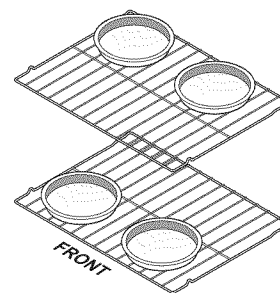

Figure 4: Oven rack positions

Setting Broil

This mode is best for meats, fish, and poultry up to 1" thick. Broiling cooks tender cuts of meat by direct heat. The **broil** key controls the broil feature. An optional searing grill, broiler pan, and insert may be purchased at frigidaire.com. The broil pan and broil pan insert used together allow grease to drain away from the high heat of the oven broiler. The oven can be programmed to broil at any temperature from 400°F to 550°F with a default temperature of 550°F.

To set a broil of 500°F:

CAUTION

Always use pot holders or oven mitts when using the oven. When cooking, the oven interior, oven racks, and cooktop will become very hot which can cause burns.

WARNING

Should an oven fire occur, keep oven door closed and turn off the oven. If the fire continues, throw baking soda on the fire or use a fire extinguisher. Do not put water or flour on the fire. Flour may be explosive and water can cause a grease fire to spread and cause personal injury.

1. Place the broiler pan insert on the broiler pan and place the food on the broiler pan insert. Do not use the broiler pan without the insert. The exposed grease could ignite.
2. Arrange the interior oven rack and place the broiler pan on the rack. Center the broiler pan directly under the broiler element. Preheat for 5 minutes before broiling.
3. Press **broil**. **550** will appear in the display.
4. Press **5 0 0**. If a lower broil temperature is desired (minimum broil temperature setting is 400°F), press the desired temperature before continuing to Step 5.
5. Press **start**. The oven will begin to broil. **500°** will appear in the display. Close the oven door.
6. Broil on one side until food is browned; turn and cook on the second side. Season and serve. Always pull the rack out to the stop position before turning or removing food.
7. To stop broiling, press **off**.

Broiling tips:

- For optimum browning, preheat the broil element for 5 minutes. Broil one side until the food is browned; turn and cook on the second side. Season and serve.
- If using a searing grill (available by mail order), preheat oven 5 to 10 minutes before grilling.

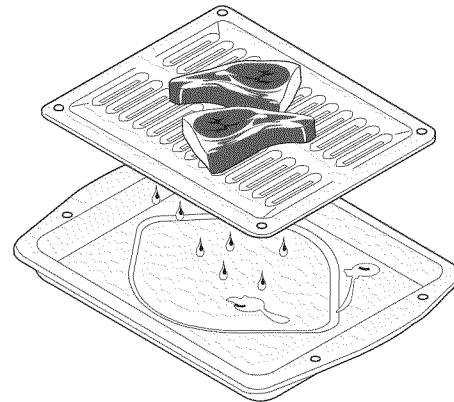

Figure 5: Broil Pan & Insert

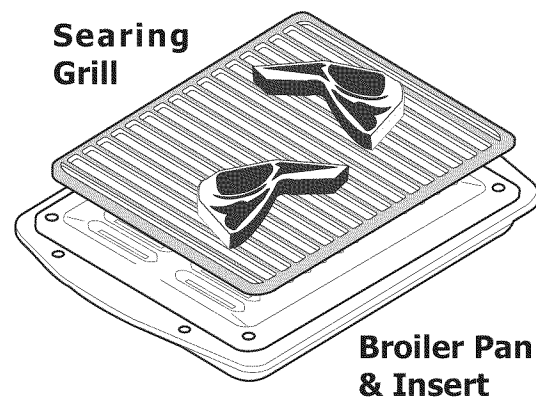

Figure 6: Broiler Pan & Insert with Searing Grill

OVEN CONTROLS

Table 2: Broiling recommendations^{a, b, c}

Food item	Rack Position	Temperature	Cook time		Internal Temp	Doneness
			1st side	2nd side		
Steak 1" thick	3rd or 4th	550°F	6:00	4:00	135°F (57°C)	Rare
Steak 1" thick	3rd or 4th	550°F	7:00	5:00	145°F (63°C)	Medium
Pork Chops 3/4" thick	3rd or 4th	550°F	8:00	6:00	170°F (77°C)	Well
Chicken - Bone In	3rd	450°F	20:00	10:00	170°F (77°C)	Well
Chicken - Boneless	3rd or 4th	450°F	8:00	6:00	170°F (77°C)	Well
Fish	3rd	500°F	13:00	-	170°F (77°C)	Well
Shrimp	3rd	550°F	5:00	-	170°F (77°C)	Well
Hamburger 1" thick	3rd or 4th	550°F	9:00	7:00	145°F (63°C)	Medium

- Use the off-set or half-rack (if available) only in the top position.
- Broiling is direct heat cooking and will produce some smoke. If smoke is excessive, place food further away from the element. Always watch food carefully to prevent burning.
- The U.S. Department of Agriculture states, "Rare fresh beef is popular, but you should know that cooking it to only 140°F (60°C) means some food poisoning organisms may survive." (Source: Safe Food Book, Your Kitchen Guide, USDA Rev. June 1985.) The lowest temperature recommended by the USDA is 145°F (63°C) for medium rare fresh beef. For beef medium 160°F, well done 170°F.

Convection Cooking

Convection cooking uses the three elements and a fan to circulate the heat evenly and continuously within the oven (Figure 7).

Benefits of convection cooking:

- Multiple rack baking.
- Some foods cook faster, saving time and energy.
- No special pans or bakeware needed.
- Food cooks more evenly.

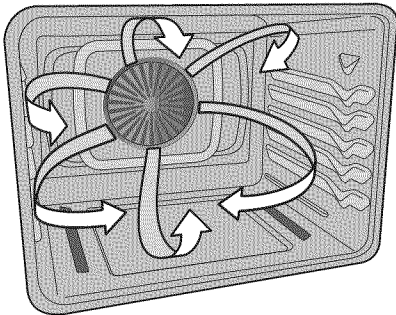

Figure 7: Air circulation in convection function

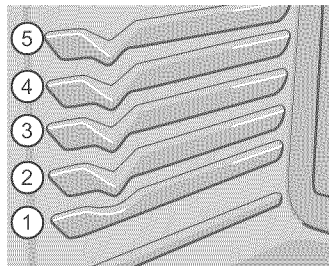

Figure 8: Oven rack positions

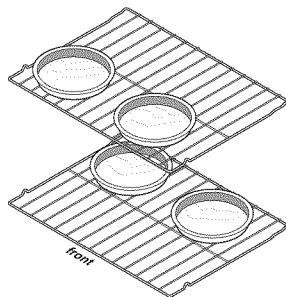

Figure 9: Pan spacing

Setting Convection Bake

This mode of cooking enables you to obtain the best results when baking with multiple pans and racks. The oven can be programmed for convection baking at any temperature between 170°F to 550°F with a default temperature of 350°F.

To set the oven for convection bake and temperature to 375°F:

⚠ CAUTION

Always use pot holders or oven mitts when using the oven. When cooking the oven interior, oven racks, and cooktop will become very hot which can cause burns.

⚠ CAUTION

Do not bake foods directly on the oven bottom. To avoid damaging the oven interior and surfaces, always bake foods in the oven using bakeware positioned on an oven rack.

1. Arrange interior oven racks.
2. Press **convect**. **Convect** and **bake** will flash and **350** will appear in the display. If a convection bake of 350°F is needed, press **start**.
3. Press **3 7 5**. **Convect** and **bake** will keep flashing, and **375°** will appear in the display.
4. Press **start**. The actual oven temperature and the fan icon will be displayed. A beep will sound once the oven temperature reaches 375°F, and the display will show **375°, CONVECT, BAKE**, and the fan icon.
5. Place food in oven.

ℹ NOTE

The convection fan will start as soon as the oven is set for convection bake. The display will show an icon of rotating fan within a square, indicating the convection fan is operating. The bake, broil, and convection elements will also cycle for a better heat distribution.

Pressing **off** will stop the feature at any time.

OVEN CONTROLS

Setting Convection Convert

Convection convert automatically converts a standard baking recipe for convection baking. When set properly, this feature is designed to display the actual converted (reduced) temperature in the display. Convection convert may only be used with a convection bake cooking mode. It can be used with a delay start and bake time. For delay start instructions, see page 19. For bake time instructions, see page 19. If convection conversion is used with the bake time and delay start features, **CF** (check food) will be displayed when 75% of the bake time complete. At this time the oven control will sound three long beeps at regular intervals until baking time is finished. The control will display **End** and continue to beep at regular intervals until **off** is pressed.

To set the oven for convection bake with a standard baking recipe temperature of 400°F:

CAUTION

Always use pot holders or oven mitts when using the oven. When cooking the oven interior, oven racks, and cooktop will become very hot which can cause burns.

WARNING

Should an oven fire occur, close the oven door and turn the oven off. If the fire continues, throw baking soda on the fire or use a fire extinguisher. Do not put water or flour on fire. Flour may be explosive, and water can cause a grease fire to spread and cause personal injury.

1. Arrange interior oven racks.
2. Press **convect**. **Convect** and **bake** will flash and **350** will appear in the display.
3. Press **4 0 0**. **Convect** and **bake** will keep flashing and **400°** will appear in the display.
4. Press **start**.
5. Set **bake time** or **delay start** if needed. For delay start instructions, see page 19. For bake time instructions, see page 19.
6. Press **convect convert**, and the oven will start heating. The temperature displayed will be 25°F lower than what it used to be. The actual oven temperature and the fan icon will be displayed. A beep will sound once the oven temperature reaches 375°F, and the display will show **375°**, **CONVECT**, **BAKE**, and the fan icon.

7. Place food in the oven.

NOTE

When using a bake time under 20 minutes, the convection convert will not beep and display the **CF** message. Pressing **off** will stop the feature at any time. Bake, broil, and convection elements will cycle for better heat distribution and faster and more even cooking.

Convection bake/convert tips:

- Fully preheat the oven before baking items like cookies, cakes, biscuits, and breads.
- When using any single rack, position the rack so that the food is in the center of the oven.
- For best results when baking cakes using two oven racks, place racks in positions 2 and 4 (Figure 8).
- When baking using two oven racks, position cookware as shown in Figure 9. Allow at least 2 inches (5 cm) of space between cookware for proper air circulation.
- Dark or dull bakeware absorbs more heat than shiny bakeware. It may be necessary to reduce oven temperature and cook time to prevent overbrowning of some foods. Dark bakeware is recommended for pies. Shiny bakeware is recommended for cakes, cookies, and muffins.
- When using convection, use bakeware with low sides. This allows the air to circulate around the food evenly.
- Because most food items will cook faster and more evenly with the convection feature, it is advisable to reduce recipe's recommended temperature by 25° for best results. Follow the recipe's instructions using the minimum recommended cook time.
- When using convection bake, cook time reductions may vary depending on the amount and type of food being cooked.
- For batter and dough-based baked goods such as cakes, pastries, and breads, use the convection bake function for best results. Place the pans as shown in Figure 9
- Do not open the oven door often. Opening the door will reduce the temperature in the oven and may increase bake time.
- Glass bakeware may require reduced temperatures.

Setting Convection Broil

Use this mode for thicker cuts of meat, fish, and poultry. The convection broiling gently browns the exterior and seals in the juices. Convection broiling uses the broil element and a fan to circulate the oven's heat evenly and continuously within the oven. The oven can be programmed for convection and normal broiling at any temperature between 400°F to 550°F with a default temperature of 550°F (Table 2).

To set a convection broil temperature of 500°F:

CAUTION

Always use pot holders or oven mitts when using the oven. When cooking the oven interior, oven racks, and cooktop will become very hot which can cause burns.

WARNING

Should an oven fire occur, close the oven door and turn the oven off. If the fire continues, throw baking soda on the fire or use a fire extinguisher. Do not put water or flour on fire. Flour may be explosive, and water can cause a grease fire to spread and cause personal injury.

1. Arrange oven racks first. Press **convect**; **350** will be displayed, and **convect** and **bake** will flash.
2. Press **convect** two more times; **550** will be displayed and **convect** and **broil** will flash.
3. Press **5 0 0**.
4. Press **start**.
5. **500, CONVECT, BROIL**, and the fan icon will be displayed.
6. After 5 minutes of preheat, place food in the oven.

NOTE

The preheat tone will not sound for this feature.

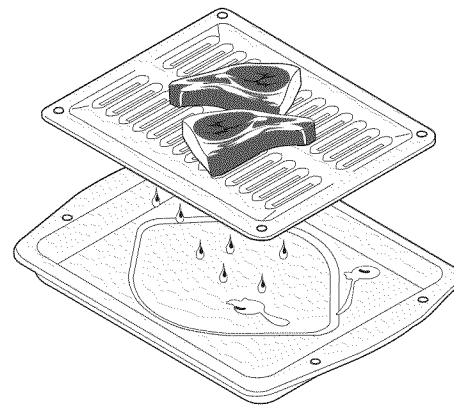

Figure 10: Broil Pan & Insert

Convection broiling tips:

- For optimum browning, preheat the broil element for 5 minutes.
- Always pull the rack out to the stop position before turning or removing food.
- Always use a broiler pan and its grid when broiling (available by mail order). It keeps grease away from the high heat of the broil element.
- Do not use the broil pan without the insert. Do not cover the broil pan insert with foil. The exposed grease could catch fire. If using a searing grill (available by mail order), preheat the grill for 5 to 10 minutes before placing your meat. Broil one side until the food is browned; turn and cook on the second side. Season and serve.
- Always broil or convection broil with the oven door closed.
- Broil one side until the food is browned; turn and cook on the second side. Season and serve.
- Since convection broil cooks food quickly, reduce the cook time by 25% from the recommended cook time of your recipe (check the food at this time). If necessary, increase cook time until the desired doneness is obtained.

OVEN CONTROLS

Setting Convection Roast

This mode is best for cooking tender cuts of beef, lamb, pork, and poultry. Use this mode when cooking speed is desired. Convection roasting gently browns the exterior and seals in the juices. Convection roasting uses the bake element, convection element, broil element, and fan to circulate the heat evenly and continuously within the oven. The oven can be programmed for convection roasting at any temperature between 170°F to 550°F with a default temperature of 350°F.

To set a convection roast temperature of 375°F:

CAUTION

Always use pot holders or oven mitts when using the oven. When cooking the oven interior, oven racks, and cooktop will become very hot which can cause burns.

WARNING

Should an oven fire occur, close oven door and turn off the oven. If the fire continues, throw baking soda on the fire or use a fire extinguisher. Do not put water or flour on the fire. Flour may be explosive, and water can cause a grease fire to spread and cause personal injury.

1. Arrange oven racks and place food in the oven.
2. Press **convect**; **350** will be displayed; **Convect** and **bake** will flash.
3. Press **convect** again. **350** will be displayed, and **convect** and **roast** will flash.
4. Enter the desired roasting temperature using the number keys, i.e.: **3 7 5**.
5. Press **start**; The actual oven temperature will be displayed. **Convect**, **roast**, and the fan icon will be displayed. The bake, broil, and convection elements will also cycle for a better heat distribution.

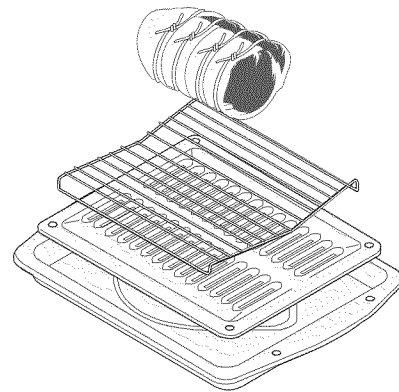

Figure 11: Broil pan, insert, and roasting rack

Convection roasting tips:

- Use a broiler pan and grid, as well as a roasting rack (available by mail order). The broiler pan will catch grease drippings, and the grid will help prevent spatters. The roasting rack will hold the meat.
- It's not recommended to roast chicken on a roasting rack. Use a deep pan instead.
- Place an oven rack on rack position 1 (offset rack).
- No preheat is needed in convection roast.
- Make sure the roasting rack is securely seated on the grid in the broiler pan. Do not use the broiler pan without the grid or cover the grid with aluminum foil.
- Pull the rack out to the stop position before removing food. Position food (fat side up) on the roasting rack.
- Arrange oven racks so the food is in the center of the oven.
- Since convection roast cooks faster, you can reduce cook times by 25% from the recommended time of your recipe (check the food at this time). Then if needed, increase cook time until the desired doneness is obtained.
- Do not cover foods when dry roasting - covering will prevent the meat from browning properly.
- Be sure to carefully follow your recipe's temperature and time recommendations.
- Do not use the broiler pan without the grid or cover the grid with aluminum foil.

OVEN CONTROLS

Setting Bake Time

Use bake time when setting the oven to cook for a specific length of time and shut off automatically when the time is complete. When cooking time ends, the oven will shut off and will beep. This feature can be used with bake, convection bake, convection roast, and slow cook modes.

To program the oven to begin baking immediately and to shut off automatically (example: Bake at 350°F for 30 minutes):

CAUTION

Always use pot holders or oven mitts when using the oven. When cooking the oven interior, oven racks, and cooktop will become very hot which can cause burns.

CAUTION

Do not bake foods directly on the oven bottom. To avoid damaging the oven interior and surfaces, always bake foods in the oven using bakeware positioned on an oven rack.

1. Be sure the clock is set for the correct time of day.
2. Arrange interior oven rack(s) and place the food in then oven.
3. Press **bake**. **350** will appear in the display.
4. Press **start**. The actual oven temperature will appear in the display.
5. Press **bake time**. **-- --** will appear in the display.
6. Enter the desired baking time by pressing **3 0**.
7. Press **start**. Once the timed bake feature has started, the current time of day will appear in the display.

Press **off** when baking has finished or at any time to cancel the bake time feature. A bake time of **0** minute can also be entered to cancel the bake time feature and keep the oven in its current cooking mode.

When the timed bake finishes:

1. **End** and the time of day will show in display. The oven will shut off automatically.
2. The control will beep three times. The control will continue to beep three times every 30 seconds until **off** is pressed.

NOTE

Baking time can be set for any amount of time between 1 minute to 5 hrs and 59 minutes. The time remaining can be shown in the timer section of the display by pressing **bake time** at any moment of the cooking. Once bake time has started baking, a beep will sound when the oven temperature reaches the set temperature.

Setting Delay Start

Bake, **convect**, **bake time**, and **delay start** keys control the delayed start feature. The automatic timer of delayed start will turn the oven on and off at the time you select in advance.

To program the oven for a delayed start time with the bake function. (example: baking at 375°F for 30 minutes, starting at 5:30):

CAUTION

Food Poisoning Hazard. Do not let food sit for more than one hour before or after cooking. Doing so can result in food poisoning or sickness. Foods that can easily spoil such as milk, eggs, fish, meat, or poultry should be chilled in the refrigerator first. Even when chilled, they should not stand in the oven for more than 1 hour before cooking begins and should be removed promptly when finished cooking.

1. Be sure that the clock is set with the correct time of day. Arrange interior oven rack and place the food in the oven.
2. Press **bake**. **350** will appear in the display. Enter the desired temperature, i.e.: press **3 7 5**.
3. Press **start**. The actual oven temperature will appear in the display.
4. Press **bake time** and enter **3 0** using numeric keys.
5. Press **start**.
6. Press **delay start**.
7. Enter the desired start time; pressing **5 3 0**.
8. Press **start**. When a delayed baking function starts, the set oven temperature will appear. **Delay**, **bake**, and the current time of day will appear in the display. When the desired start time is reached, the actual oven temperature appears in display and **delay** disappears. Oven starts to bake at the previously selected temperature

OVEN CONTROLS

Setting Warm

Warm is best for keeping oven baked foods warm for serving after cooking has finished. The **warm** key turns on the warm feature, will maintain an oven temperature of 170°F (77°C), and will keep oven baked foods warm for serving up to 3 hours after cooking.

After 3 hours, the warm feature will shut the oven off. The warm feature may be used without any other cooking operations or can be set to turn on automatically after a bake time or delay start.

To set warm:

CAUTION

Food Poisoning Hazard. Do not let food sit for more than one hour before or after cooking. Doing so can result in food poisoning or sickness. Foods that can easily spoil such as milk, eggs, fish, meat, or poultry should be chilled in the refrigerator first. Even when chilled, they should not stand in the oven for more than 1 hour before cooking begins and should be removed promptly when finished cooking.

CAUTION

Always use pot holders or oven mitts when using the oven. When cooking the oven interior, oven racks, and cooktop will become very hot which can cause burns.

1. Arrange interior oven racks and place food in oven.
2. Press **warm**. "HLd" will appear in the display.
3. Press **start**. If **start** is not touched within 25 seconds the request to turn on the warm feature will be canceled.
4. To turn off the warm feature at any time, press **off**.

To set warm to turn on automatically:

1. Arrange interior oven racks and place food in oven. Set the oven properly for bake time or delay start. For delay start instructions, see page 19. For bake time instructions, see page 19.
2. Press **warm**. If no key is touched within 25 seconds, the request to turn on the warm feature will be cancelled.

3. Press **start**. HLd will disappear and the temperature will be displayed. The warm mode is set to turn on automatically after timed bake has finished.
4. To turn the warm feature off at any time, press **off**.

Warm tips:

- Always start with hot food. Do not use the warm feature to heat cold food.
- Food in heat-safe glass and glass ceramic containers may need higher temperature settings compared to food in regular containers.
- Avoid repeated openings of the oven, it will allow hot air to escape and the food to cool.
- Aluminum foil may be used to cover food to increase moisture content.

Setting My Favorites Recipe (some models)

The **my favorites** key allows the user to save a recipe to be recalled at any time. The recipe may be for any baking temperature between 170°F (77°C) and 550°F (288°C). Once saved, the user needs only to select the **my favorites** key, and the baking function will start automatically with the pre-programmed recipe. The oven can recall a cooking sequences from its internal memory, which is easily accessible from a one touch key. This function can be used with bake, convection bake, convection roast, and preheat.

To save a favorite (example: 450°F bake for 30 minutes):

1. Press **bake**. The default temperature will appear in the display.
2. Enter temperature needed, i.e.: **4 5 0**. Press **start**.
3. Press **bake time**.
4. Enter time needed, i.e.: **3 0**. Press **start**.
5. Press and hold for 3 seconds **my favorites** key. The ♥ icon will be shown to confirm your setting has been saved.
6. The bake recipe will start. If you do not need it at this time, press **off**.

To recall a favorite:

1. Press **my favorites**.
2. Press **start**.

NOTE

Recalling a my favorites recipe can only be done when the oven is not in operation.

To overwrite a favorite:

To overwrite my favorites, simply start a new cooking sequence and save it as shown in example above. The new my favorites settings will overwrite the old ones.

To delete a favorite:

Press **my favorites** for 3 seconds to delete while the oven is not in operation and no cooking mode has been set. The heart icon will turn off, indicating that the recipe has been deleted.

OVEN CONTROLS

Cooking with Meat Probe

CAUTION

Do not use kitchen utensils to pull on the probe cable or handles. Always insert and remove the probe using the provided handles, as shown in Figure 12, and always use a pot holder to protect hands from possible burns.

Use the probe feature for best results when cooking foods such as roasts, hams or poultry. For meats like poultry and roasts, using a probe to check internal temperature is the safest method to ensure properly cooked food. The probe feature, when set correctly, will signal an alert when the internal food temperature reaches the desired set target temperature. When active, the probe displays the internal food temperature which is visible in the display during the cooking process. This eliminates any guesswork or the need to open the oven door to check the thermometer.

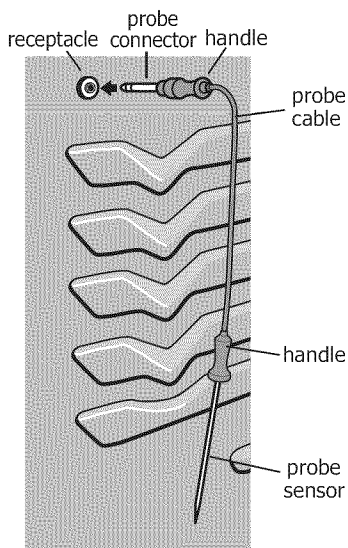

Figure 12: Using the probe

NOTE

On some models, the meat probe receptacle may be located in the top of the oven cavity, toward the front.

IMPORTANT

- Do not store the probe inside the oven. Use only the original probe provided. Connecting any other probe or device could result in damage to the oven control, electronics, and the receptacle.
- Before starting self clean, double check that the probe is removed from the oven interior. Defrost frozen foods completely before inserting the probe.

Proper placement of probe in food.

- Insert the probe so that the probe tip rests inside the center of the thickest part of meat or food (Figure 13). For best results, do not allow the probe temperature sensor to contact bone, fat, gristle, or the cookware.

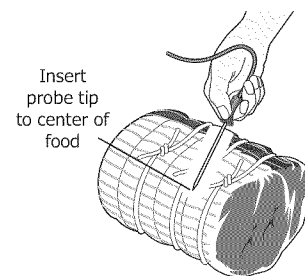

Figure 13: Probe in thickest area of food

- For bone-in ham or lamb, insert the probe into the center of lowest large muscle or joint.
- For meat loaf or casseroles, insert the probe into center of food.
- When cooking fish, insert meat probe just above the gill.
- For whole poultry or turkey, fully insert the probe sensor into the thickest part of inner thigh, just below the leg (Figure 14).

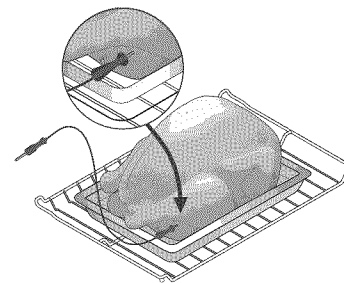

Figure 14: Probe in thickest part of thigh

OVEN CONTROLS

To set probe:

CAUTION

Always use pot holders or oven mitts when using the oven. When cooking, the oven interior and exterior, as well as the oven racks, will become very hot which can cause burns.

CAUTION

Handle the meat probe carefully when inserting and removing from food or probe receptacle. Do not use kitchen utensils, such as tongs, to pull on meat probe cable when inserting or removing from food or receptacle. Use the provided handle, as shown in Figure 12. To avoid possibility of burns after cooking, carefully unplug meat probe using a pot holder to protect hands.

1. Insert the probe into the food. Place prepared food on the desired oven rack position and slide into the oven.
2. Plug the connector end of the probe all the way into the probe receptacle while the oven is still cool. The receptacle is located on the upper left front oven cavity wall (Figure 12).
3. When the probe is set, an acceptance tone will sound, the probe icon will illuminate, and the actual probe temperature appears in the display (Figure 15). Close the oven door



Figure 15: Probe set showing probe temperature

4. Press **probe** key once. Enter the desired target food temperature using the numeric keys, and set temperature for food type. The minimum setting is 140°F (60°C); the maximum is 210°F (99°C). Default is 170°F (77°C).
5. Press **start** to accept the target temperature.
6. Set for **quick preheat, bake, convection bake, convection roast, or convection convert**, and if necessary adjust the oven temperature accordingly.
7. The control will provide three beeps when the internal target temperature is reached. The oven will automatically change to a warm setting (**HLD**), and the actual probe temperature will alternate in the display. Warm

will maintain the oven temperature at 170°F (77°C) for 3 hours unless otherwise cancelled.

To stop cooking at any time, press **off**.

To set how the oven will operate once the probe reaches the target temperature:

The oven is preset to automatically stop cooking and start the warm feature when probe sensor reaches the target temperature. This may be set to continue cooking if desired. Setting the options once the probe reaches the target temperature must be done when the oven is inactive. The probe is not required to be connected to the probe receptacle when setting this option.

To set the oven to continue cooking after reaching the target temperature:

1. Press **probe** key and hold for 6 seconds.
2. Press **self clean** key and toggle until **Continu** appears, as shown in Figure 16, then press **start** to accept.

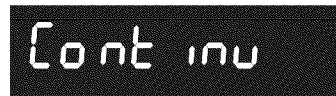

Figure 16: Probe set to continue cooking

To set the oven to automatically stop cooking and start warm once reaching target temperature:

1. Press **probe** key and hold for 6 seconds.
2. Press the **self clean** key and toggle until **CANCEL** appears, as shown in Figure 17, then press **start** to accept



Figure 17: Probe set to cancel cooking

Probe too hot message:

When the message **Prob... Too... Hot...** flashes in the display, the probe temperature has exceeded 250°F (121°C). If the probe is not removed, this message may continue until the sensor reaches 300°F (149°C) or higher, and oven will automatically turn off. Be sure the probe sensor is fully covered by the food.

OVEN CONTROLS

NOTE

During cooking the internal food temperature will display by default. To see the target temperature press the **probe** key once. After 6 seconds the display will revert to the internal food temperature. To assure accuracy, do not remove the probe from the food or receptacle until the desired internal temperature is reached.

If the probe is removed from the receptacle only, the probe feature will cancel but the oven will continue to cook. If the probe is removed from the food only, the probe feature will remain active and may eventually generate a probe too hot message.

To change the target temperature while cooking, press the **probe** key once. Use the numeric keys to change the temperature. Press the **start** key to accept any change.

Table 3: USDA recommended minimum internal cooking temperatures

Food Type	Internal Temp.
Ground meat and meat mixtures	
Beef, Pork, Veal, Lamb	160°F (71°C)
Turkey, Chicken	165°F (74°C)
Fresh beef, veal, lamb	
Medium rare +	145°F (63°C)
Medium	160°F (71°C)
Well Done	170°F (77°C)
Poultry	
Chicken and Turkey, whole	165°F (74°C)
Poultry Breasts, Roasts	165°F (74°C)
Poultry Thighs, Wings	165°F (74°C)
Duck and Goose	165°F (74°C)
Stuffing (cooked alone or in bird)	165°F (74°C)
Fresh Pork	160°F (71°C)
Ham	
Fresh (raw)	160°F (71°C)
Pre-cooked (to reheat)	140°F (60°C)
Eggs and egg dishes	
Eggs	Cook until yolk and white are firm
Eggs dishes	160°F (71°C)
Leftovers and Casseroles	165°F (74°C)

The U.S. Department of Agriculture states, "Rare fresh beef is popular, but you should know that cooking it to only 140°F (60°C) means some food poisoning organisms may survive." (Source: *Safe Food Book, Your Kitchen Guide*, USDA Rev. June 1985.)

Visit the USDA Food Safety and Inspection website at www.fsis.usda.gov

OVEN CONTROLS

Setting Slow Cook (some models)

Slow cook may be used to cook foods more slowly, at lower oven temperatures and provide cooking results much the same way as a slow cooker or crock-pot. Slow cook is ideal for roasting beef (ribs and brisket), pork, and poultry. It may be set with cook time, and cook time/end time. Slow cooking meats may result in the exterior of meats becoming dark but not burnt. This is normal. Slow cook uses the hidden bake element to maintain a low temperature in the oven. Slow cook has two settings: Lo 225°F (108°C) and Hi 275°F (135°C). Both settings can be used with the following options:

- Bake time
- Bake time with delay start

To set slow cook:

WARNING

Food Poisoning Hazard. Do not let food sit for more than one hour before or after cooking. Doing so can result in food poisoning or sickness. Foods that can easily spoil such as milk, eggs, fish, meat, or poultry should be chilled in the refrigerator first. Even when chilled, they should not stand in the oven for more than 1 hour before cooking begins and should be removed promptly when finished cooking. Eating spoiled food can result in sickness from food poisoning.

CAUTION

Always use potholders or oven mitts when removing food or adjusting the oven racks. Wait until the oven is completely cooled if possible. When cooking, the oven interior and oven racks will become hot enough to cause burns.

1. Position oven racks and cookware in oven. Close the oven door.
2. Press **slow cook (some models)**. **HI** will appear in the oven display indicating the default setting is for high heat. If a low setting is needed, press **slow cook** again to select the **LO** setting and release.
3. Press **start**.
4. To stop cooking at any time, press **off**.

5. Slow cook can be changed between Hi and Lo settings by pressing **slow cook** to toggle between the two settings. Press **start** to activate the new setting.

Slow cook tips:

- Slow cooking meats may result in the outside of the meat turning dark; this is normal.
- Completely thaw all frozen foods before cooking
- When using a single oven rack, place in oven rack so food is centered in oven.
- Position multiple racks to accommodate size of cooking utensils when cooking multiple food items.
- Add any cream or cheese sauces during the last hour of cooking.
- Do not frequently open the oven door or leave the oven door open when checking food items. The more heat that is lost, the longer the food will need to cook.
- Cover foods to keep them moist or use a loose or vented cover to allow foods to turn crisp or brown.
- Roasts may be left uncovered so browning can occur. Cook times will vary depending on the weight, fat content, bone, and the shape of the roast.
- Preheating the oven is not necessary.

OVEN CONTROLS

Restoring Factory Default Setting

Your appliance is programmed with default control settings. Over time, users may make changes to these settings. The following options have settings that can be modified and may have been changed since the appliance was new:

- 12 or 24 hour display mode
- Continuous bake or 12 hour energy savings mode
- Silent or audible control
- Oven temperature display (°F or °C)
- Oven temperature adjustments (offsets)
- Stored recipes
- Cancel/continue cooking with meat probe option.

NOTE

If you choose to restore factory default settings, all of the above user preferences will be restored to their original settings (factory default). The oven temperature offset will reset, and any stored recipes will be cleared.

To restore oven control to factory default settings:

1. When the oven is in idle and no cooking function is in operation, press and hold the **7** key until the acceptance tone sounds (about 6 seconds)
2. Press **start**. The control is now reset to default settings.

Adjusting Oven Temperature

The temperature in the oven is pre-set at the factory. When first using the oven, be sure to follow recipe times and temperatures. If you think the oven is cooking too hot or too cool for the temperature you select, you can adjust the actual oven temperature to be more or less than what is displayed. Before adjusting, test a recipe by using a temperature setting higher or lower than the recommended temperature. The baking results should help you to decide how much of an adjustment is needed.

To adjust the oven temperature higher:

1. Press **bake** for 6 seconds. **UPO 0** will appear in the display.
2. To increase the temperature, use the number keys to enter the desired change. For example, for 30°F, press **3 0**. The temperature may be increased as much as 35°F (19°C).

3. Press **start** to accept the temperature change and the display will return to the time of day. Press **off** to reject the change if necessary.

To adjust the oven temperature lower:

1. Press **bake** for 6 seconds. **UPO 0** will appear in the display.
2. To decrease the temperature, use the number keys to enter the desired change (Example -30°F) **3 0**. Then, press **self clean**. The temperature may be decreased as much as 35°F (19°C).
3. Press **start** to accept the temperature change and the display will return to the time of day. Press **off** to reject the change if necessary.

NOTE

The oven temperature adjustments made with this feature will not change the self clean cycle temperature or the broil temperature.

The oven temperature adjustments are permanent and will stay in the unit memory unless you manually change it again or if all the controls are reset. Even a power outage will not reset these changes. Follow the same procedure again if you wish to change it to a different setting or use the "Restoring Factory Default Setting" instructions on this page to restore settings to their defaults.

Setting the Sabbath Feature

(For use on the Jewish Sabbath and Holidays)

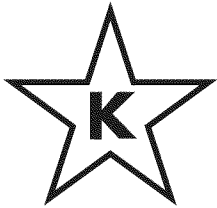

The **bake time** and **start** keys are used to set the Sabbath feature.

For further assistance, guidelines for proper usage, and a complete list of models with the Sabbath feature, please visit the web at <http://www.star-k.org>.

The Sabbath feature may only be used with the bake function. Once the oven is properly set using bake with the Sabbath feature active, the oven will remain on until cancelled. The Sabbath feature overrides the factory preset 12 hour energy saving feature. If the oven light is needed during the Sabbath, press **Oven light** before activating the Sabbath feature. Once the oven light is turned on and the Sabbath feature is active, the oven light will remain on until the Sabbath feature is turned off. If the oven light needs to be off, be sure to turn the oven light off before activating the Sabbath feature.

→ IMPORTANT

It is advised to not activate any cooking function other than bake while the Sabbath feature is active.

To program the oven to begin baking immediately and activate the Sabbath feature (example: baking at 350°F):

⚠ WARNING

Food Poisoning Hazard. Do not let food sit for more than one hour before or after cooking. Doing so can result in food poisoning or sickness. Foods that can easily spoil such as milk, eggs, fish, meat, or poultry should be chilled in the refrigerator first. Even when chilled, they should not stand in the oven for more than 1 hour before cooking begins and should be removed promptly when finished cooking. Eating spoiled food can result in sickness from food poisoning.

1. Be sure that the clock is set with the correct time of day.
2. Place the food in the oven. Press **bake**. **350°** appears in the display. Press **start**. The actual oven temperature appears in the display.
3. If you desire to set the oven control for a bake time or delayed bake time, do so at this time. If not, skip this

step and continue to Step 5. For delay start instructions, see page 19. For bake time instructions, see page 19. Remember the oven will turn off after using bake time or delay start and may only be used once during the Sabbath/Jewish holidays. The maximum bake time is 5 hours and 59 minutes.

4. The oven will turn on and begin heating.
5. Press and hold both the **bake time** and **delay start** keys for at least 3 seconds. **SAb** will appear in the display. Once **SAb** appears in the display, the oven control will no longer beep or display any further changes, and the oven is properly set for the Sabbath feature.
6. The oven may be turned off at any time by first pressing **off** (this will turn the oven off only).
7. To turn off the Sabbath feature, press and hold both the **bake time** and **delay start** keys for at least 3 seconds. **SAb** will disappear from the display.

📌 NOTE

- You may change the oven temperature once baking has started by pressing **bake** and the numeric keys for the new temperature. For example, to change from 350°F to 425°F, press **4 2 5**. Then, press **start** twice.
- Only the following controls will function after setting the Sabbath feature: numeric keypad, bake, start, and off. All other features will not function once the Sabbath feature is properly activated.
- The display will not show temperature changes or sound any audible tones when the oven is set with the Sabbath feature

Power failure while using Sabbath feature:

Should you experience a power failure or interruption, the oven will shut off. When power is returned, **SF** (Sabbath Failure) will be displayed, and the oven will not turn back on automatically. If your food was nearly fully cooked, you may allow the trapped heat in the oven to finish the cooking process. Otherwise, you should remove the food when the power failure occurs because you may only start the oven once during the Sabbath/Jewish holidays.

After the Sabbath observance turn off the Sabbath feature. Press and hold both the **bake time** and **delay start** keys for at least 3 seconds. **SAb** will disappear from the display, and the oven may be used with all normal functions.

OVEN CONTROLS

Steam Clean

The steam clean feature offers a chemical-free and time-saving method to assist in the routine cleaning of your oven. Steam clean may be used before manually cleaning the oven to help loosen soils on the oven bottom.

CAUTION

Do not add ammonia, oven cleaners, or any other household cleaners or chemicals to the water used in the steam clean cycle.

Before manually cleaning any part of the oven, be sure all controls are turned off and the oven is cool. The oven may be hot and can cause burns.

To set a steam clean cycle:

1. Oven should be at room temperature. If the oven temperature is above the room temperature, steam clean will not start. Be sure the oven is cool. Remove all racks and oven accessories.
2. Scrape or wipe loose debris from the oven bottom.
3. Pour 8 oz (235 ml) distilled or filtered water onto the oven bottom (Figure 18). Close the oven door.

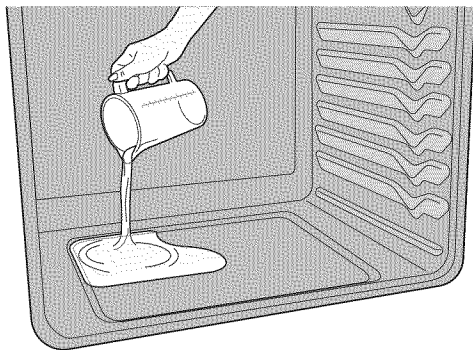

Figure 18: Add 8 ounces of distilled water

4. Press **steam clean**. **StCn** will show in the display (Figure 19).



Figure 19: Steam clean selected

5. Press **start**.

6. Steam clean is a 20 minute cycle. Time remaining is shown in the display.
7. An alert will sound at the end of the cycle, and the **End** message will show in the display. Press **off** to return to the clock.
8. When the steam clean cycle is complete, stand to the side of the oven out of the way of escaping vapor when opening the oven door. The cycle includes a cool-down period, so you may immediately use a soft cloth or sponge to remove any remaining water.
9. Wipe oven cavity and bottom. Do not clean oven door gasket (Figure 20).

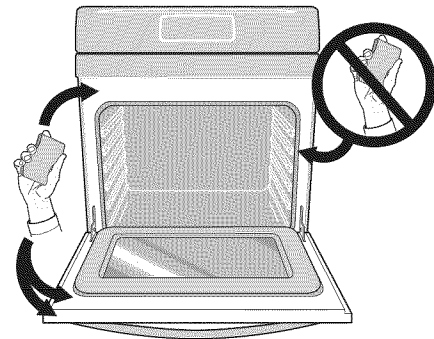

Figure 20: Clean around the oven door gasket

For best results, clean oven immediately after the cycle is complete. Steam clean works best for soils on the oven bottom. Removal of especially stubborn or baked-on soils may require a manual cleaning. See instructions in the "Cleaning Your Wall Oven" on page 31.

Some condensation or water vapor may appear close to the oven vent. This is normal. The oven gasket may become damp; do not wipe dry. Open door to broil position and allow to air dry.

Local water sources often contain minerals (hard water) and will leave deposits on the oven cavity. If this occurs, wipe cavity with vinegar or lemon juice. Use distilled or filtered water.

If the door is opened during the steam clean cycle, a beep will sound and **d-0** will show in the display. Close the oven door. Keep oven door closed during steam clean cycle.

Steam clean cannot be programmed with a delay start. If steam clean results are not satisfactory, run a self clean. See "Self-Cleaning Operation" on page 29.

Self-Cleaning Operation

CAUTION

- Do not line the oven walls, racks, bottom, or any other part of the oven with aluminum foil. Doing so will block heat distribution, produce poor baking results, and cause permanent damage to the oven interior (aluminum foil will melt to the interior surface of the oven).
- The health of some birds is extremely sensitive to the fumes given off during the self-cleaning cycle of any oven. Move birds to another well-ventilated room.
- During the self-cleaning cycle, the outside of the oven can become very hot to the touch. Do not leave small children unattended near the appliance.
- Do not force the oven door open. This can damage the automatic door locking system.
- Use caution when opening the door after the self-cleaning cycle is completed. The oven may still be very hot. Stand to the side of the oven door when opening the door to allow hot air or steam to escape.

A self-cleaning oven cleans itself with high temperatures (well above normal cooking temperatures) which eliminate soils completely or reduces them to a fine powdered ash you can wipe away with a damp cloth

What to expect during self-cleaning

While in self-clean mode, the oven heats to temperatures much higher than those used in normal cooking. Sounds of metal expansion and contraction are normal.

Odors are normal as the food soil is being removed. Smoke may appear through the oven vent.

If heavy spills are not wiped up before cleaning, they may flame and cause more smoke and odor than usual. This is normal and safe and should not cause alarm. If available, use an exhaust fan during the self-cleaning cycle.

IMPORTANT

Adhere to the following cleaning precautions:

- Do not use oven cleaners or protective coatings in or around any part of the oven interior. Do not clean the oven door gasket. Take care not to rub, damage, or remove the gasket or use any cleaning substances on the oven door gasket (Figure 21). Doing so could cause damage and reduce the efficiency of the oven's performance.
- Clean any soil from the oven frame, door liner outside the oven door gasket, and the small area at the front center of the oven bottom with soap and water (Figure 21). These areas heat sufficiently to burn soil on.
- Remove any excessive spills from the oven cavity before starting the self-cleaning cycle. To clean, use hot, soapy water and a cloth. Large spills can cause heavy smoke or fire when subjected to high temperatures. Do not allow food spills with a high sugar or acid content (such as milk, tomatoes, sauerkraut, fruit juices, or pie filling) to remain on the surface as they may leave a dull spot even after cleaning.
- Do not use aluminum foil or liners in the oven. These items are not made to withstand the very high temperatures of a self-clean cycle and will melt.
- Remove all oven racks and accessories. If oven racks are not removed before a self-clean, they will lose their special coating and will no longer slide in and out of the oven cavity effortlessly.
- Oven racks accidentally left in the oven during self clean may be wiped down after cooling with a high-temperature cooking oil to lubricate them.

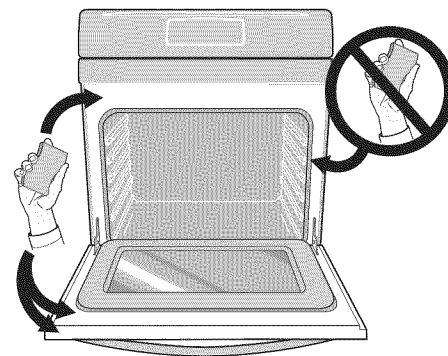

Figure 21: Clean around the oven door gasket



OVEN CONTROLS

Setting Self-Clean Cycle Duration

The **self clean** key controls the self-cleaning feature. If you are planning to use the oven directly after a self-clean cycle remember to allow time for the oven to cool down and the oven door to unlock. This normally takes about one hour. A 3 hour self-clean cycle will actually take about 4 hours to complete.

It is recommended to use a 2 hour self-clean cycle for light soils, a 3 hour cycle for average soils, and a 4 hour cycle for heavy soils.

To set the controls for a 3 hour self-cleaning cycle to start immediately and shut off automatically:

1. Be sure the clock is set with the correct time of day and the oven door is closed.
2. Press **self clean**. **CLn** and **3:00 HR** will show in the display. The control will automatically clean for a 3 hour period (default self-cleaning cycle time). If a 2 or 4 hour clean time is desired, press **self clean** multiple times to toggle between 2, 3, or 4 hours.
3. Press **start**. **door Loc** will appear, a beep will sound, and the word **DOOR** and the  icon will flash; **CLn** will remain on in the display.
4. As soon as the control is set, the motor driven oven door lock will begin to close automatically. Once the door is locked, the **DOOR** indicator light and  icon will stop flashing and remain on, and the oven icon will appear in the display. Allow about 15 seconds for the oven door to lock completely.

When the self-clean cycle is completed:

1. **HOT** will appear in the display. The time of day, the word **DOOR**, and the  icon will remain in the display.
2. Once the oven has cooled for approximately 1 hour, **door OPn** will appear, and the word **DOOR** and the lock icon will flash until the door unlocks. The door can be opened, and the display will show the time of day.



To stop or Interrupt a self-cleaning cycle:

If it becomes necessary to stop or interrupt a self-cleaning cycle due to excessive smoke or fire in the oven:

1. Press **off**.
2. The oven door can only be opened after the oven has cooled down for about 1 HOUR. **door OPn** will appear, and the word **DOOR** and the  icon will flash until the door is unlocked. The oven door can then be opened, and the timer will revert back to the time of day.

The **self clean** and **delay start** keys control the delayed self-clean operation. The automatic timer will turn the oven on and off at the time you select in advance.

To set the control for the self-cleaning cycle to start at a delayed time and shut off automatically (example: 3 hour self-clean cycle to start at 4:30):

1. Be sure the clock is set with the correct time of day and the oven door is closed.
2. Press **self clean**. **CLn** and **3:00 HR** will show in the display. The control will automatically clean for a 3 hour period. If a 2 or 4 hour clean time is desired, press **self clean** multiple times to toggle between 2, 3, or 4 hours.
3. Press **start**. **door Loc** will appear, a beep will sound, and the word **DOOR** and the  lock icon will flash. The letters **CLn** will remain on in the display.
4. As soon as the control is set, the motor driven oven door lock will begin to close automatically. Once the door has been locked, the word **DOOR** and the  lock icon indicator light will quit flashing and remain on.
5. Press **delay start**. Enter the desired start time using the number keys **4 3 0**.
6. Press **start**. **DELAY**, **DOOR**, and the  icons will remain on.
7. The control will start the self-cleaning at the set start time for the period of time previously selected. At that time, the icon **DELAY** will go out; **CLn** and oven icon will appear in the display.

When the self-clean cycle is completed:

1. **HOT** will appear in the display. The time of day, the word **DOOR**, and the lock icon will remain in the display.
2. When oven cools approximately 1 HOUR, **door OPn** will appear, and the word **DOOR** and the  icon will flash until the door is unlocked. The oven door can then be opened, and the timer will revert back to the time of day.

Cleaning Your Wall Oven

Before cleaning any part of the oven, be sure all controls are turned off and the oven is cool. Remove spills and any heavy soiling as soon as possible. Regular cleaning will reduce the difficulty and time of major cleaning later.

Surface Type	Recommendation
Aluminum and Vinyl	Use hot, soapy water and a cloth. Dry with a clean cloth.
Painted and plastic control knobs Painted body parts Painted decorative trims	Using a soft cloth and clean with mild dish detergent and water or a 50/50 solution of vinegar and water. Follow by rinsing the area with clean water; dry and polish with a soft cloth. Glass cleaners may be used if sprayed on a soft cloth first. Do not spray liquids directly on the oven control and display area. Do not use large amounts of water on the control panel - excess water on the control area may cause damage to the appliance. Do not use other liquid cleaners, abrasive cleaners, scouring pads, or paper towels - they will damage the finish. To remove control knobs, turn to the OFF position; grasp firmly and pull straight off the shaft. To replace knobs after cleaning, line up the flat sides of both the knob and the shaft; then push the knob into place.
Stainless Steel	Your oven finish may be made with stainless steel (some models). Clean the stainless with warm soapy water using a clean sponge or cloth. Rinse with clean water and dry with a soft clean cloth. Do not use any store bought cleaners like stainless steel cleaners or any other types of cleaners containing any abrasive, chlorides, chlorine or ammonia. It is recommended to use mild dish soap and water or a 50/50 solution of water and vinegar.
Porcelain enamel broiler pan and insert (available by mail order) Door liner and body parts	Gentle scouring with a soapy scouring pad will remove most spots. Rinse with a 1:1 solution of clear water and ammonia. If necessary, cover difficult spots with an ammonia-soaked paper towel for 30 to 40 minutes. Rinse with clean water and a damp cloth, and then scrub with a soap-filled scouring pad. Rinse and wipe dry with a clean cloth. Remove all cleaners or the porcelain may become damaged during future heating.
Oven racks	Oven racks must be removed from oven cavity. Clean by using a mild, abrasive cleaner following manufacturer's instructions. Rinse with clean water and dry.
Oven door	Use soap and water to thoroughly clean the top, sides, and front of the oven door. Rinse well. You may use a glass cleaner on the outside glass of the door. Do not immerse the door in water. Do not spray or allow water or the glass cleaner to enter the door vents. Do not use oven cleaners, cleaning powders, or any harsh abrasive cleaning materials on the outside of the oven door. Do not clean the oven door gasket. On self-clean models, the oven door gasket is made of a woven material which is essential for a good seal. Care should be taken not to rub, damage, or remove this gasket.

CARE AND CLEANING

Removing and Replacing the Oven Door

CAUTION

The door is heavy. For safe, temporary storage, lay the door flat with the inside of the door facing down.

To remove oven door:

1. Open oven door completely, horizontal with floor (Figure 22).
2. Pull the door hinge locks on both left and right door hinges down from the oven frame completely towards the oven door (Figure 23). A tool such as a small flat-blade screwdriver may be required.
3. Firmly grasp both sides of oven door along the door sides. Do not use the oven door handle (Figure 24).
4. Close the door to approximately 10 degrees from the door frame (Figure 24).
5. Lift the oven door hinge arms over the roller pins located on each side of the oven frame (Figure 25).

To replace oven door:

1. Firmly grasp both sides of oven door along the door sides. Do not use the oven door handle (Figure 24).
2. Holding the oven door at the same angle as the removal position, seat the hook of the hinge arm over the roller pins located on each side of the oven door frame (Figure 24 and Figure 25). The hook of the hinge arms must be fully seated onto the roller pins.
3. Fully open the oven door, horizontal with floor (Figure 22).
4. Push the door hinge locks up towards and into the oven frame on both left and right oven door hinges to the locked position (Figure 23).
5. Close the oven door.

IMPORTANT

Special door care instructions - Most oven doors contain glass that can break. Do not close the oven door until all the oven racks are fully in place. Do not hit the glass with pots, pans, or any other object. Scratching, hitting, jarring, or stressing the glass may weaken its structure causing an increased risk of breakage at a later time.

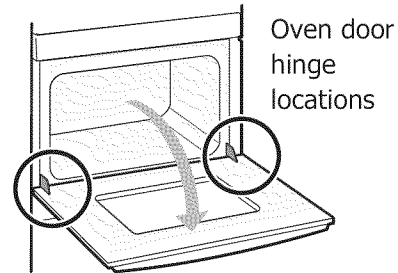

Figure 22: Door hinge location

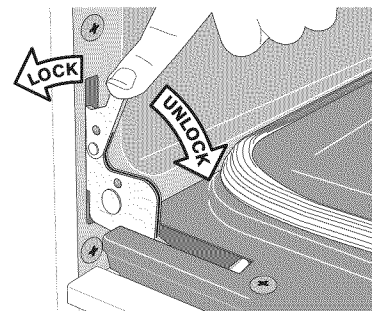

Figure 23: Door hinge locks

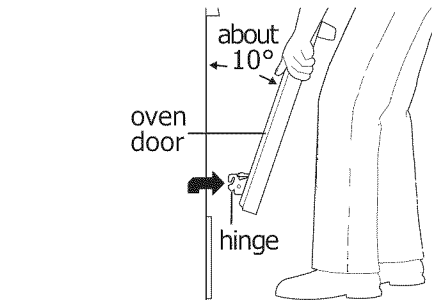

Figure 24: Holding door for removal

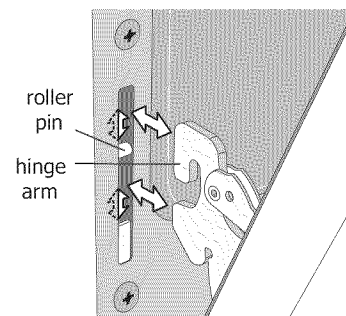

Figure 25: Replacement and location of hinge arm and roller pin

Replacing the oven light

⚠ CAUTION

Be sure the oven is unplugged and all parts are cool before replacing oven light.

The interior oven lights are located at the rear of the oven cavity and are covered with a glass shield. The glass shield must be in place whenever the oven is in use (Figure 26).

Replacing the oven interior light bulb:

1. Turn electrical power off at the main source or unplug the appliance.
2. Remove interior oven light shield by turning a quarter turn.
3. Replace bulb with a new T-4 type Halogen 25 watt appliance bulb.

↳ NOTE

Do not allow your fingers to touch the new bulb when replacing. This will shorten the life of the bulb. Use a paper towel or cotton glove while handling the new bulb when installing.

4. Replace glass oven light shield.
5. Turn power back on again at the main source (or plug the appliance back in).
6. Be sure to reset the time of day on the clock.

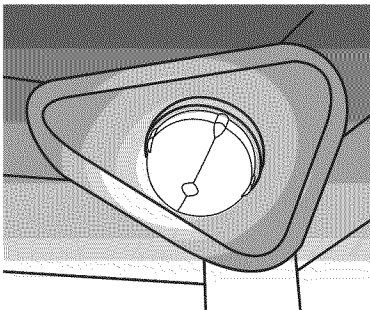

Figure 26: Wall oven Halogen light

BEFORE YOU CALL

Oven Baking

For best cooking results, heat the oven before baking cookies, breads, cakes, pies, pastries, et cetera. There is no need to preheat the oven for roasting meat or baking casseroles. The cooking times and temperatures needed to bake a product may vary slightly from your previously owned appliance.

Baking Problems and Solutions

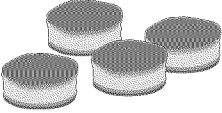
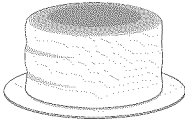
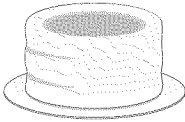
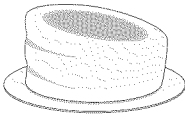
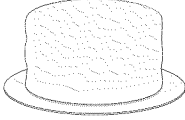
Baking Problems	Causes	Corrections
<p>Cookies and biscuits burn on the bottom.</p> 	<ul style="list-style-type: none">• Cookies and biscuits put into oven before preheating time is completed.• Oven rack is overcrowded.• Dark pans absorb heat too fast.	<ul style="list-style-type: none">• Allow oven to preheat to desired temperature before placing food in oven.• Choose pan sizes that will permit 2" to 4" of air space (5.1 cm or 10.2 cm) on all sides when placed in the oven.• Use a medium weight baking sheet.
<p>Cakes too dark on top or bottom</p> 	<ul style="list-style-type: none">• Cakes put in oven before preheating time is completed.• Rack position too high or too low, and oven too hot.	<ul style="list-style-type: none">• Allow oven to preheat to the selected temperature before placing food in the oven.• Use proper rack position for baking needs.• Set oven temperature 25°F (13°C) lower than recommended.
<p>Cakes not done in center</p> 	<ul style="list-style-type: none">• Oven too hot.• Incorrect pan size.• Pan not centered in oven.• Glass cookware slow heat conductor.	<ul style="list-style-type: none">• Set oven temperature 25°F (13°C) lower than recommended.• Use pan size suggested in recipe.• Use proper rack position and place pan so there is 5.1 cm to 10.2 cm (2" to 4") of space on all sides of pan.• Reduce temperature and increase cook time or use shiny bakeware.
<p>Cakes not level.</p> 	<ul style="list-style-type: none">• Oven not level.• Pan too close to oven wall or rack overcrowded.• Pan warped.• Oven light left on during baking.	<ul style="list-style-type: none">• Place a marked glass measuring cup filled with water on the center of the oven rack. If the water level is uneven, refer to the installation instructions for leveling the oven.• Be sure to allow 5.1 cm to 10.2 cm (2" to 4") of clearance on all sides of each pan in the oven.• Do not use pans that are dented or warped.• Do not leave oven light on while baking.
<p>Foods not done when cooking time is over.</p> 	<ul style="list-style-type: none">• Oven too cool.• Oven overcrowded.• Oven door opened too frequently.	<ul style="list-style-type: none">• Set oven temperature 25°F (13°C) higher than suggested and bake for the recommended time.• Be sure to remove all pans from the oven except the ones to be used for baking. Open oven door only after shortest recommended baking time.• Make sure to allow 2" to 4" of clearance between all pans and racks, allowing for even air flow.

Solutions to Common Problems

Before you call for service, review the following list. It may save you time and expense. Possible solutions are provided with the problem listed:

Problem	Solution
Poor baking results.	Many factors effect baking results. Use proper oven rack position. Center food in oven and space pans to allow air to circulate. Preheat oven to the set temp before placing food in oven. Try adjusting the recipe's recommended temperature or baking time. See "Adjusting Oven Temperature" on page 26 if oven is too hot or cold.
Appliance does not operate.	The time of day is not set. The oven clock must first be set in order to operate the oven. Be sure oven controls are set properly. Review instructions for the desired cooking function in this manual. Service wiring is not complete.
Oven light does not work.	Ensure oven light is secure in the socket. See "Replacing the oven light" on page 33.
Flames inside oven or smoking from oven vent.	Excessive spills in oven. Grease or food spilled onto oven bottom or oven cavity. Wipe up excessive spills before starting oven. If flames or excessive smoke are present when using broil, see "Setting Broil" on page 13.
Self clean does not work.	Oven control not set properly. See "Self-Cleaning Operation" on page 29.
Oven racks discolored or do not slide easily.	Oven racks left in oven cavity during self clean. Remove oven racks from oven cavity before starting a self-clean cycle. Clean by using a mild abrasive cleaner following manufacturer's instructions. Rinse with clean water, dry, and replace in oven.
Oven smokes excessively when broiling.	Incorrect setting. Follow the "Setting Broil" instructions on page 13. Meat too close to the broil element. Reposition broil rack to provide proper clearance between the meat and broil element. Remove excess fat from meat. Cut remaining fatty edges to prevent curling, but do not cut into lean. Grease build up on oven surfaces. Regular cleaning is necessary when broiling frequently. Grease or food splatters will cause excessive smoking.
Oven control panel beeps and displays any F or E code error.	Oven control has detected a fault or error condition. Press the off key to clear the error code. Try bake or broil function. If the F or E code error repeats, turn off the power to appliance, wait 5 minutes, and then repower appliance. Set clock with correct time of day. Try bake or broil function again. If fault recurs, press the off key to clear.
Soil not completely removed after self clean.	Self clean was interrupted. Review instructions on "Self-Cleaning Operation" on page 29. Excessive spills on oven bottom. Clean before starting self clean. Failure to clean soil from the oven frame, the door liner outside the oven door gasket, and the small area at the front center of the oven bottom. These areas are not in the self-cleaning area, but get hot enough to burn on residue. Clean these areas before starting the self-cleaning cycle. Burned-on residue can be cleaned with a stiff nylon brush and water or a nylon scrubber. Be careful not to damage the oven gasket.
Convection fan does not rotate.	Oven door is open. Convection fan will turn off if oven door is opened when convection is active. Close oven door.
Fan noise occurring after the oven is turned off.	Some models are equipped with a cooling fan that runs during the cooking process to cool internal electronic components. It is normal for this fan to continue to run for an extended period of time, even when the oven is off.

Your appliance is covered by a one year limited warranty. For one year from your original date of purchase, Electrolux will pay all costs for repairing or replacing any parts of this appliance that prove to be defective in materials or workmanship when such appliance is installed, used and maintained in accordance with the provided instructions.

Exclusions

This warranty does not cover the following:

1. Products with original serial numbers that have been removed, altered or cannot be readily determined.
2. Product that has been transferred from its original owner to another party or removed outside the USA or Canada.
3. Rust on the interior or exterior of the unit.
4. Products purchased "as-is" are not covered by this warranty.
5. Food loss due to any refrigerator or freezer failures.
6. Products used in a commercial setting.
7. Service calls which do not involve malfunction or defects in materials or workmanship, or for appliances not in ordinary household use or used other than in accordance with the provided instructions.
8. Service calls to correct the installation of your appliance or to instruct you how to use your appliance.
9. Expenses for making the appliance accessible for servicing, such as removal of trim, cupboards, shelves, etc., which are not a part of the appliance when it is shipped from the factory.
10. Service calls to repair or replace appliance light bulbs, air filters, water filters, other consumables, or knobs, handles, or other cosmetic parts.
11. Surcharges including, but not limited to, any after hour, weekend, or holiday service calls, tolls, ferry trip charges, or mileage expense for service calls to remote areas, including the state of Alaska.
12. Damages to the finish of appliance or home incurred during installation, including but not limited to floors, cabinets, walls, etc.
13. Damages caused by: services performed by unauthorized service companies; use of parts other than genuine Electrolux parts or parts obtained from persons other than authorized service companies; or external causes such as abuse, misuse, inadequate power supply, accidents, fires, or acts of God.

DISCLAIMER OF IMPLIED WARRANTIES; LIMITATION OF REMEDIES

CUSTOMER'S SOLE AND EXCLUSIVE REMEDY UNDER THIS LIMITED WARRANTY SHALL BE PRODUCT REPAIR OR REPLACEMENT AS PROVIDED HEREIN. CLAIMS BASED ON IMPLIED WARRANTIES, INCLUDING WARRANTIES OF MERCHANTABILITY OR FITNESS FOR A PARTICULAR PURPOSE, ARE LIMITED TO ONE YEAR OR THE SHORTEST PERIOD ALLOWED BY LAW, BUT NOT LESS THAN ONE YEAR. ELECTROLUX SHALL NOT BE LIABLE FOR CONSEQUENTIAL OR INCIDENTAL DAMAGES SUCH AS PROPERTY DAMAGE AND INCIDENTAL EXPENSES RESULTING FROM ANY BREACH OF THIS WRITTEN LIMITED WARRANTY OR ANY IMPLIED WARRANTY. SOME STATES AND PROVINCES DO NOT ALLOW THE EXCLUSION OR LIMITATION OF INCIDENTAL OR CONSEQUENTIAL DAMAGES, OR LIMITATIONS ON THE DURATION OF IMPLIED WARRANTIES, SO THESE LIMITATIONS OR EXCLUSIONS MAY NOT APPLY TO YOU. THIS WRITTEN WARRANTY GIVES YOU SPECIFIC LEGAL RIGHTS. YOU MAY ALSO HAVE OTHER RIGHTS THAT VARY FROM STATE TO STATE.

If You Need Service

Keep your receipt, delivery slip, or some other appropriate payment record to establish the warranty period should service be required. If service is performed, it is in your best interest to obtain and keep all receipts. Service under this warranty must be obtained by contacting Electrolux at the addresses or phone numbers below.

This warranty only applies in the USA and Canada. In the USA, your appliance is warranted by Electrolux Major Appliances North America, a division of Electrolux Home Products, Inc. In Canada, your appliance is warranted by Electrolux Canada Corp. Electrolux authorizes no person to change or add to any obligations under this warranty. Obligations for service and parts under this warranty must be performed by Electrolux or an authorized service company. Product features or specifications as described or illustrated are subject to change without notice.

USA
1.800.944.9044
Electrolux Home Products, Inc.
10200 David Taylor Drive
Charlotte, NC 28262



Canada
1.800.265.8352
Electrolux Canada Corp.
5855 Terry Fox Way
Mississauga, Ontario, Canada
L5V 3E4