

Use & Care Guide
Manual de Uso y Cuidado
Manuel d'utilisation et d'entretien
English / Español / Français

Model / Modelo / Modèle: 790.4027*

Kenmore®

Wall Oven

Horno de pared four encastré

* = color number, número de color, numéro de couleur

P/N A00327301 Rev. B

Sears Brands Management Corporation
Hoffman Estates, IL 60179 U.S.A.
www.kenmore.com

Sears Canada Inc.
Toronto (Ontario) Canada M5B 2C3
www.sears.ca



Table of Contents

Before Setting Oven Controls.....	7	Care and Cleaning	13
Oven Controls.....	8	Before You Call	16
		Solutions to Common Problems	17

Please carefully read and save these instructions

This Use and Care Manual contains general operating instructions for your appliance and feature information for several models. Your product may not have all the described features. The graphics shown are representative. The graphics on your appliance may not look exactly like those shown. Common sense and caution must be practiced when installing, operating and maintaining any appliance.

Kenmore Limited Warranty

When installed, operated and maintained according to all instructions supplied with the product, if this appliance fails due to a defect in material and workmanship within one year from the date of purchase, call 1-844-553-6667 to arrange for free repair.

This warranty applies for only 90 days from the date of purchase if this appliance is ever used for other than private family purposes.

This warranty covers only defects in material and workmanship. Sears will NOT pay for:

1. Cracks in a ceramic glass cooktop that are not a result of thermal shock.
2. Stains and scratches on a ceramic glass cooktop resulting from failure to maintain it properly according to all instructions supplied with the product.
3. Consumable items that can wear out from normal use, including but not limited to filters, belts, light bulbs, and bags.
4. A service technician to instruct the user in correct product installation, operation or maintenance.
5. A service technician to clean or maintain this product.
6. Damage to or failure of this product if it is not installed, operated or maintained according to all instructions supplied with the product.
7. Damage to or failure of this product resulting from accident, abuse, misuse or use for other than its intended purpose.
8. Damage to or failure of this product caused by the use of detergents, cleaners, chemicals or utensils other than those recommended in all instructions supplied with the product.
9. Damage to or failure of parts or systems resulting from unauthorized modifications made to this product.

Disclaimer of implied warranties; limitation of remedies

Customer's sole and exclusive remedy under this limited warranty shall be product repair as provided herein. Implied warranties, including warranties of merchantability or fitness for a particular purpose, are limited to one year or the shortest period allowed by law. Sears shall not be liable for incidental or consequential damages. Some states and provinces do not allow the exclusion or limitation of incidental or consequential damages, or limitation on the duration of implied warranties of merchantability or fitness, so these exclusions or limitations may not apply to you.

This warranty applies only while this appliance is used in the United States and Canada.*

This warranty gives you specific legal rights, and you may also have other rights which vary from state to state and province to province.

* In Canada, in-home repair service is not available in all Canadian geographical areas, nor will this warranty cover user or servicer travel and transportation expenses if this product is located in a remote area (as defined by Sears Canada Inc.) where an authorized servicer is not available.

**Sears Brands Management Corporation, Hoffman Estates, IL 60179 U.S.A.
Sears Canada Inc., Toronto, Ontario, Canada M5B 2C3**

IMPORTANT SAFETY INSTRUCTIONS

Read all instructions before using this appliance.

This manual contains important safety symbols and instructions. Pay attention to these symbols and follow all instructions given.

Do not attempt to install or operate your appliance until you have read the safety precautions in this manual. Safety items throughout this manual are labeled with a WARNING or CAUTION statement based on the hazard type.

DEFINITIONS

⚠ This is the safety alert symbol. It is used to alert you to potential personal injury hazards. Obey all safety messages that follow this symbol to avoid possible injury or death.

⚠ WARNING - Indicates a potentially hazardous situation which, if not avoided, may result in death or serious injury.

⚠ CAUTION - Indicates a potentially hazardous situation which, if not avoided, may result in minor or moderate injury.

Important: Indicates installation, operation, maintenance, or valuable information that is not hazard related.

⚠ WARNING Storage in or on appliance— Flammable materials should not be stored in an oven or near surface units. This includes paper, plastic, and cloth items, such as cookbooks, plastic ware, and towels, as well as flammable liquids. Do not store explosives, such as aerosol cans, on or near the oven.

⚠ WARNING Do not leave children alone - Children should not be left alone or unattended in the area where appliance is in use. They should never be allowed to sit or stand on any part of the appliance.

⚠ WARNING Tip Over Hazard

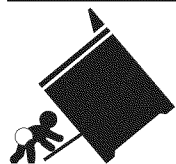

- A child or adult can tip the oven and be killed.
- Install the anti-tip device to oven and/or structure per installation instructions.

- Ensure the anti-tip device is re-engaged when the oven is moved.
- Do not operate the oven without the anti-tip device in place and engaged.
- Failure to follow these instructions can result in death or serious burns to children and adults.

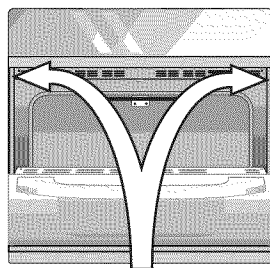

Anti-tip mounting holes

Refer to the installation instructions supplied with your appliance for proper installation.

Check for proper installation with a visual check that the anti-tip screws are present.

Test the installation with light downward pressure on the open oven door. The oven should not tip forward.

⚠ WARNING Stepping, leaning, or sitting on the door or drawers of an oven can result in serious injuries and also cause damage to the appliance.

⚠ WARNING Do not allow children to climb or play around the oven. The weight of a child on an open oven door may cause the oven to tip, resulting in serious burns or other injury.

⚠ WARNING Never cover any slots, holes, or passages in the oven bottom or cover an entire oven rack with materials, such as aluminum foil. Aluminum foil linings may trap heat, causing a fire hazard.

IMPORTANT SAFETY INSTRUCTIONS

Read all instructions before using this appliance.

⚠ CAUTION Wear proper apparel. Loose-fitting or hanging garments should never be worn while using this appliance. Do not let clothing or other flammable materials come into contact with hot surfaces.

⚠ CAUTION Do not heat unopened food containers. Build-up of pressure may cause container to burst and result in injury.

⚠ CAUTION When heating fat or grease, watch it closely. Grease may catch fire if it becomes too hot.

⚠ CAUTION Do not use water or flour on grease fires. Smother fire or flame or use dry chemical or foam-type extinguisher. Cover the fire with a pan lid or use baking soda.

⚠ CAUTION Use dry potholders. Moist or damp potholders on hot surfaces may result in burns from steam. Do not let potholders touch hot cooking areas. Do not use towels or other bulky cloths.

⚠ CAUTION Do not touch heating elements or interior surfaces of oven. Heating elements may be hot and can cause burns even though they are dark in color and appear to have cooled. Other surfaces of the appliance may become hot enough to cause burns such as oven vent openings, oven doors, and windows of oven doors.

⚠ CAUTION Read and follow the below instructions and precautions for unpacking, installing, and servicing your appliance:

- Remove all tape and packaging before using the oven. Destroy the carton and plastic bags after unpacking the oven. Never allow children to play with packaging material.
- Remove the oven door from any unused oven if it is to be stored or discarded.
- Be sure to have an appropriate foam-type fire extinguisher available, visible, and easily located near the appliance.
- Proper installation—Be sure your appliance is properly installed and grounded by a qualified technician in accordance with the National Electrical Code ANSI/NFPA No. 70 latest edition and local electrical code requirements. In Canada, install in accordance with CSA Standard C22.1, Canadian Electrical code, Part 1, and local electrical code requirements. Install only per installation instructions provided in the literature package for this oven.
- User servicing—Do not repair or replace any part of the appliance unless specifically recommended in the manuals. All other servicing should be done only by a qualified technician. This reduces the risk of personal injury and damage to the oven.
- Ask your dealer to recommend a qualified technician and an authorized repair service. Know how to disconnect the power to the oven at the circuit breaker or fuse box in case of an emergency.
- Never modify or alter the construction of an oven by removing the leveling legs, panels, wire covers, anti-tip brackets/screws, or any other part of the oven.
- Do not attempt to operate the oven during a power failure. If the power fails, always turn off the oven. If the oven is not turned off and the power resumes, the oven will begin to operate again. Once the power resumes, reset the clock and oven function.
- Cold temperatures can damage the electronic control. When using this appliance for the first time, or when the appliance has not been used for an extended period of time, be sure the appliance has been in temperatures above 32°F (0°C) for at least 3 hours before turning on the power to the appliance.

Save these instructions for future reference.

IMPORTANT SAFETY INSTRUCTIONS

Read all instructions before using this appliance.

IMPORTANT INSTRUCTIONS FOR USING YOUR OVEN

- Never use your appliance for warming or heating the room.
- Use care when opening oven door, lower oven door, or warmer drawer (some models). Stand to the side of the oven when opening the door of a hot oven. Let hot air or steam escape before you remove or replace food in the oven.
- Keep oven vent ducts unobstructed. Touching surfaces in this area when the oven is on may cause severe burns. Do not place plastic or heat-sensitive items on or near the oven vent. These items can melt or ignite.
- Placement of oven racks - Always place oven racks in desired location while oven is cool. If rack must be moved while oven is hot, do not let potholder contact hot heating element in oven. Use potholders and grasp the rack with both hands to reposition. Remove all bakeware and utensils before moving the rack.
- Do not use a broiler pan without its insert. Broiler pans and inserts allow dripping fat to drain away from the high heat of the broiler. Do not cover the broiler insert with aluminum foil; exposed fat and grease could ignite.
- Protective liners - Do not use aluminum foil to line surface unit drip bowls or oven bottoms, except as suggested in the manual. Improper installation of these liners may result in a risk of electric shock, or fire.
- Do not cook food on the oven bottom. Always cook in proper bakeware and always use the oven racks.

IMPORTANT INSTRUCTIONS FOR CLEANING YOUR OVEN

⚠ CAUTION Before manually cleaning any part of the oven, be sure all controls are turned off and the oven is cool. Cleaning a hot oven can cause burns.

Clean the oven regularly to keep all parts free of grease that could catch fire. Do not allow grease to accumulate.

Always follow the manufacturer's recommended directions for use of kitchen cleaners and aerosols. Be aware that excess residue from cleaners and aerosols may ignite causing damage and injury.

SELF-CLEANING OVENS (some models)

- Clean only the parts listed in this manual. Before using self-clean, remove the broiler pan, any food, utensils, and bakeware from the oven. Remove oven racks unless otherwise instructed.
- Do not use oven cleaners. No commercial oven cleaner or oven liner protective coating of any kind should be used in or around any part of the oven.
- Do not clean door gasket. The door gasket is essential for a good seal. Care should be taken not to rub, damage, or move the gasket.
- Some birds are extremely sensitive to the fumes given off during the self-clean cycle of any oven. Move birds to another well-ventilated room.

Important Safety Notice - The California Safe Drinking Water and Toxic Enforcement Act requires the governor of California to publish a list of substances known to cause cancer, birth defects, or other reproductive harms, and it requires businesses to warn customers of potential exposures to such substances.

IMPORTANT SAFETY INSTRUCTIONS

Read all instructions before using this appliance.

Grounding Instructions

⚠ WARNING Avoid fire hazard or electrical shock. Failure to follow this warning may cause serious injury, fire, or death.

This appliance must be supplied with the proper voltage and frequency, and connected to an individual, properly grounded branch circuit, protected by a circuit breaker or fuse.

It is the responsibility and obligation of the consumer to contact a qualified installer to assure that the electrical installation is adequate and is in conformance with all local codes and ordinances.

See the installation instructions packaged with this appliance for complete installation and grounding instructions.

Product Registration and Customer Information

Serial Plate Location

The serial plate is on the side of the oven frame.

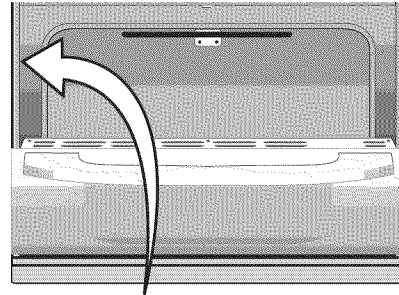

Record the date of purchase, model and serial number of your product in the corresponding space below.

Model Number: _____

Serial Number: _____

Date of Purchase: _____

Save your sales receipt for future reference.

Before Setting Oven Controls

Oven Vent Location

The oven vent is located above the control panel (Figure 1). When the oven is on, warm air passes through this vent. This venting is necessary for proper air circulation in the oven and good baking results. Do not block oven vent. Steam or moisture may appear near the oven vent. This is normal.

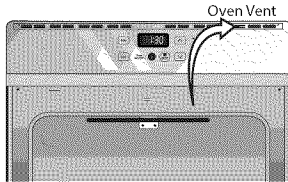

Figure 1: Oven vent location

⚠ WARNING Protective liners — Do not use aluminum foil to line the oven bottom. Only use aluminum foil as recommended in this manual. Improper installation of these liners may result in risk of electric shock, or fire

Oven Racks

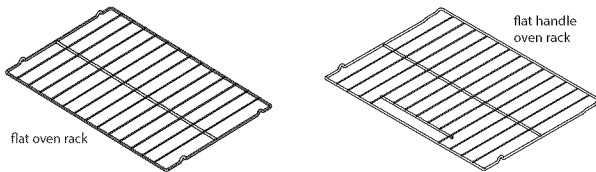

Figure 2: Rack Types

- The flat handle (or flat rack) may be used for most cooking needs.
- To maximize the oven cooking space place the oven rack in the lowest rack position for roasting large cuts of meat.

Arranging, Removing, and Replacing Racks

⚠ CAUTION Always use pot holders or oven mitts when using the oven. When cooking, the oven interior and exterior, and oven racks will become very hot which can cause burns.

To arrange - always arrange the oven racks when the oven is cool.

To remove - pull the rack forward until it stops. Lift up front of rack and slide out.

To replace - fit oven rack onto the rack guides on both sides of oven walls. Tilt the front of oven rack upward and slide the rack back into place. Be sure oven racks are level before using.

Important:

- Do not line the oven walls, racks, bottom, or any other parts of the range with aluminum foil. Doing so will alter heat distribution, produce poor baking results, and may cause permanent damage to the oven interior.

Oven Controls

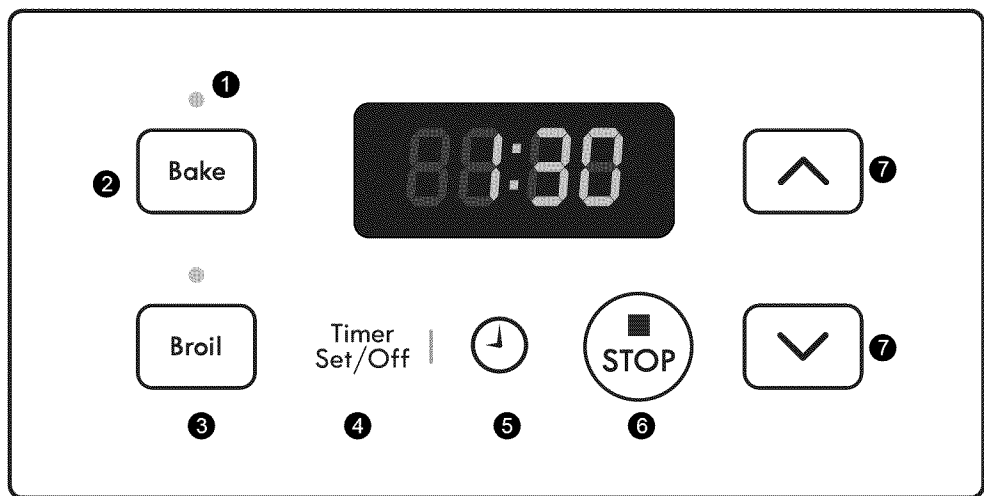

Oven Control Features

For satisfactory use of the oven, become familiar with the various pad features and functions of the oven as described throughout this section.

Oven control keypad:

1. **Function Indicator lights** - These indicator lights glow when Bake or Broil are active.
2. **Bake** - Use to select the bake feature (page 10).
3. **Broil** - Use to select the variable broil feature (page 11).
4. **Timer Set/Off** - Use to set or cancel the minute timer. The minute timer does not start or stop cooking (page 9).
5. **Clock** - Use to set the time of day.
6. **STOP** - Press STOP to end cooking or to clear any feature previously entered except the time of day and minute timer.
7. **Up/Down arrow keys** - Use with the feature or function pads to set oven temperature or adjusting the clock and minute timer.

Table 1: Maximum and Minimum Settings

Feature*	Min. Temp/Time	Max. Temp/Time
Bake	170°F (77°C)	500°F (260°C)
Broil	LO 400°F (205°C)	HI 500°F (260°C)
Timer	1 Min.	11:59 Hr./Min.
Clock Time	1:00 Hr./Min.	12:59 Hr./Min.

* The features listed show the minimum and maximum time or temperature settings allowable

Setting the Clock

When the appliance is first plugged in or when the power supply to the appliance has been interrupted, the display will flash 12:00.

Important: You must set the clock for the time of day before using the appliance.

To set clock:



1. Press once (do not hold key down).
2. Within 5 seconds, press and hold or until the correct time of day appears in the display and release key pad.
3. The clock should display the correct time of day.

Important: The clock cannot be changed when the oven is cooking.

Changing the Temperature Display Mode (F or C)

The electronic oven control is set to display Fahrenheit (F) when shipped from the factory. The display may be changed to show either Fahrenheit or Celsius (C) oven temperatures.

To change temperature display mode:

1. Press and hold **Broil** for 6-8 seconds until F or C appears in the display. At this time the display will show the current temperature display mode whether set for F or C.
2. Press either  or  to toggle between F or C.
3. To accept the change, wait until the oven control provides the acceptance beep.
4. The display will return to the time of day with the temperature display mode changed the next time the oven is set for Bake or Broil.

Important:

If at any time during the process of changing the temperature display mode you decide not to change the mode, press  once before the acceptance beep. The temperature display mode cannot be changed when Bake or Broil is active.

Oven Light

The interior oven light (some models) will automatically turn on when the oven door is opened. Press the rocker switch marked **OVEN LIGHT** on the left side of the control panel to turn the oven light on and off whenever the oven door is closed.

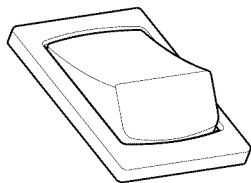

Figure 3: Oven light switch

When baking leave oven light off.



The interior oven lights are located in the upper rear corners of the oven interior. See "Replacing the Oven Lights" on page 14 for more information.

Setting the Timer



The timer allows you to track cooking times without interfering with the cooking process. The timer may be set from 1 minute up to 11 hours and 59 minutes.

Important: The Timer will not start or stop the cooking process. It serves as an extra timer in the kitchen that will beep when the set time has run out. The minute timer can be used alone or when Bake or Broil is active. If another feature is active when the timer is running, the minute timer will show in the display.

To set the timer:

1. Press **Timer Set/Off**.
2. Press  to increase the time in one minute increments. Press and hold  to increase the time in 10 minute increments. The timer can be set for any amount of time from 1 minute to 11 hours and 59 minutes.
Note: If  is pressed first, the timer will advance to 11 hours and 59 minutes.
3. When the set time has run out, the timer will sound a 3 second tone. **0:00** will show in the display until **Timer Set/Off** is pressed.

To change the time remaining on the Timer:

While the timer is active, press and hold  or  to increase or decrease the time remaining.

To cancel the timer press **Timer Set/Off** once.

Oven Controls

Setting Bake

The oven may be programmed to bake at any temperature from 170°F to 500°F (77°C to 260°C). The factory preset bake temperature is 350°F (176°C). During bake the light will indicate bake is cycling to maintain the set temperature.

For the best results when baking:

- Fully preheat the oven before baking items like cookies, biscuits, and breads.
- Leave oven light off when baking.
- When using any single rack for baking, position pans as shown below using rack position 2.

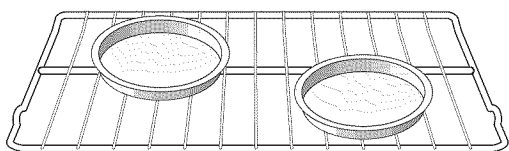







Figure 4: Single rack baking pan positions

- When baking cakes using two oven racks, place racks in positions 2 and 4 and position cake pans as shown (See Figure 5).
- Use positions 2 and 4 when baking cookies on multiple pans.
- Dark or dull pans absorb more heat than shiny bakeware resulting in dark or overbrowning of foods. It may be necessary to reduce the oven temperature or cook time to prevent overbrowning of some foods. Dark pans are recommended for pies. Shiny pans are recommended for cakes, cookies, and muffins.
- Allow at least 2 inches (5 cm) of space between cookware for proper air circulation and be sure pans and cookware do not touch each other, the oven door, sides or back of the oven cavity. Hot air must be able to circulate around the cookware in the oven for even heat to reach around the food.
- Do not open oven door often. Opening the door will reduce the temperature in the oven and may increase cook time.

⚠ WARNING Food Poisoning Hazard. Do not let food sit more than 1 hour before or after cooking. Doing so can result in food poisoning or sickness.

To set Bake:

1. Arrange racks when the oven is cool.
2. Press **Bake**. — — — appears in display.
3. Within 5 seconds, press  or . The display will show 350°F (176°C).
4. By pressing and holding  or , the temperature can be adjusted in 5°F (1°C) increments.
5. As soon as  or  is released, the oven will begin preheating to the selected temperature. The control will beep when the oven reaches the set baking temperature.

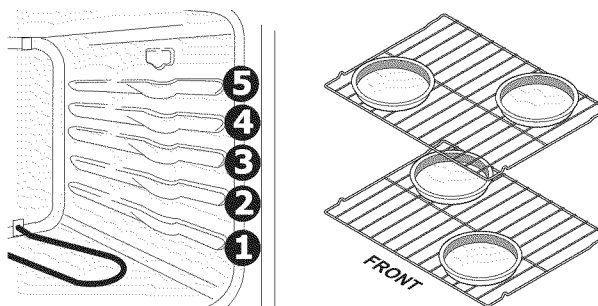





Figure 5: Rack positions (L) and cookware placement (R)

To change oven temperature after Bake has started:

1. Press **Bake** once. Visually check the bake temperature and that it needs to be changed.
2. Press  or  to increase or decrease the set temperature to the desired new oven temperature.

When Bake is active the oven begins to preheat. When the oven reaches the set temperature the control emits a tone to signal the oven is ready. The oven will cycle on and off while it heats to keep the set temperature.

To cancel Bake at any time, press .

⚠ CAUTION Always use oven mitts when using the oven. When cooking, oven racks become very hot and can cause burns.

Setting Broil

Use the broil function to cook meats that require direct exposure to radiant heat for optimum browning results. The Broil function is factory preset to broil at 500°F (260°C).



⚠ WARNING Should an oven fire occur, close the oven door and turn the oven off. If the fire continues, use a Class B/C fire extinguisher. Do not put water or flour on the fire. Flour may be explosive.

⚠ CAUTION Always use pot holders or oven mitts when using the oven. When cooking, the oven interior, exterior, and oven racks will become very hot which can cause burns.

Broiling Tips:

- Always broil with door closed. Be sure to pull the rack out to the stop position before turning or removing food.
- Always use the broiler pan with the insert when broiling. It allows the dripping grease to drain away from the high heat of the broil element. Do not use the pan without the insert. Do not cover the insert with aluminum foil. The exposed grease could catch fire.
- The suggested broil settings (See Table 2) are recommendations only. Adjust times or rack positions to suit for doneness. If the food you are broiling is not listed in the table, follow the instructions provided in your cookbook.

To set Broil:

1. Arrange the oven racks when cool.
2. Press **Broil**. The display will show — —.
3. Press  or  until the desired broil setting level appears in the display: nor for normal, hi for high, and lo for low setting. For optimum browning results, preheat oven for 2 minutes before adding food.
4. Place the insert on the broil pan, then place the food on the broil pan insert (See Figure 6).
5. Broil on one side until food is browned. Turn and broil food on the other side. Keep oven door closed when broiling.
6. When finished broiling or to cancel broil at any time, press .

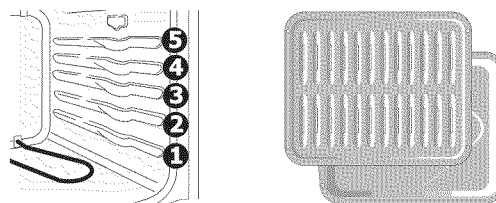

Figure 6: Rack positions (L) and broiler pan (R)

Important: If a broiler pan and insert are not supplied with this appliance, they may be purchased from Sears. Call 1-844-553-6667 and order broiler pan kit 5304442087.

Table 2: Suggested Broil Settings for Electric Ovens

Food Item	Rack position*	Temp	Cook time in minutes		Internal Temp	Doneness
			1st side	2nd side		
Steak 1" thick	4th	Hi	5	4	140°F (60°C)*	Rare*
Steak 1" thick	4th	Hi	6	4	160°F (71°C)	Medium
Steak 1" thick	4th	Hi	7	5	170°F (77°C)	Medium-well
Pork chops 3/4" thick	4th	Hi	8	6	170°F (77°C)	Well
Chicken - Bone In	3rd	Lo	20	10	170°F (77°C)	Well
Chicken Boneless	4th	Lo	8	6	170°F (77°C)	Well
Fish	4th	Hi	as directed as directed			Well
Shrimp	4th	Hi				Well
Hamburger 1" thick	4th	Hi	4	4	140°F (60°C)	Rare**
Hamburger 1" thick	4th	Hi	9	7	160°F (71°C)	Medium
Hamburger 1" thick	4th	Hi	10	8	170°F (77°C)	Well

The U.S. Department of Agriculture states, "Rare fresh beef is popular, but you should know that cooking it to only 140°F (60°C) means some food poisoning organisms may survive." (Source: Safe Food Book, Your Kitchen Guide, USDA Rev. June 1985.) The lowest temperature recommended by the USDA is 145°F (63°C) for medium rare fresh beef. For well done 170°F (77°C). All cook times shown are after 2 minutes of preheating.

Broiling is direct heat cooking and will produce some smoke. If smoke is excessive, place food further away from the element. Always watch food carefully to prevent burning.

Oven Controls



Adjusting the Oven Temperature

Your appliance has been factory calibrated and tested to ensure an accurate baking temperature. For the first few uses, follow your recipe times and temperature recommendations carefully. If you think the oven is cooking too hot or too cool for your recipe times, you may adjust the control so the oven cooks hotter or cooler than the temperature displayed.

Important note:

- Do not use oven thermometers (such as those found in grocery stores) to check the temperature settings inside the oven. These oven thermometers may vary as much as 20°F to 40°F (11°C to 23°C) from actual temperatures.
- If at any time during the process of adjusting the oven temperature feature you decide not to make the change, press  once before the acceptance beep tone.
- The oven temperature adjustment feature cannot be modified if Bake or Broil is active.

To adjust oven temperature:

1. Press and hold **Bake**, and release after the display shows the factory temperature setting of **00**. The last adjusted value will appear in the display instead.
2. You may increase oven temperature in 5°F (1°C) increments with each press of . You may decrease oven temperature in 5°F (1°C) increments with each press of . The total adjustment range is ±35°F (±18°C).
3. To accept the change, wait until the oven control provides the acceptance beep.
4. The oven temperature adjustment has been accepted by the oven control and the display will return to the time of day.

Cleaning the Oven

Important: To help remove excessive spills from the oven bottom, the lower element may be tilted up. Remove lowest oven rack before attempting to raise the element. Handle the element only when the oven is completely cool. Do not raise the element more than 4 or 5 inches (See Figure 7).

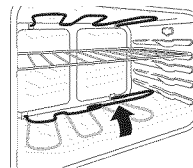

Figure 7: Exposed bake elements

- Remove the broiler pan and insert, all utensils and any aluminum foil when cleaning.
- Do not line the oven walls, racks, bottom or any other parts of the range with aluminum foil. Doing so will alter heat distribution, produce poor baking results, and may cause permanent damage to the oven interior.
- Clean any soil from the oven frame, the door liner outside the oven door gasket and the small area at the front center of the oven bottom. These areas heat sufficiently to burn soil on. Clean with soap and water. These areas are shown in white (See Figure 8).

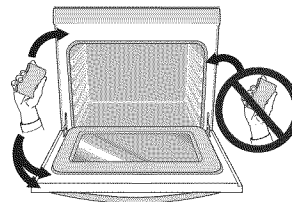

Figure 8: Hand clean oven door frame; avoid rubbing gasket.

- Do not clean the oven door gasket (See Figure 8). The woven material of the oven door gasket is essential for a good seal. Care should be taken not to rub, damage or remove the gasket.
- Do not allow food spills with a high sugar or acid content (such as milk, tomatoes, sauerkraut, fruit juices or pie filling) to remain on the surface as they may leave a dull spot even after cleaning.
- Remove any excessive spills. Spills on the oven bottom should be wiped up and removed. Use hot, soapy water and a cloth.

Care and Cleaning

Cleaning Various Parts of Your Oven

Before cleaning any part of the oven, ensure all controls are turned off and the oven is cool. Remove spills and any heavy soiling as soon as possible. Regular cleaning will reduce the difficulty and time of major cleaning later.

Surface Type	Recommendation
Aluminum, plastic, or vinyl trim Painted body parts Painted decorative trims Plastic	Use hot, soapy water and dry with a clean cloth. Use a soft cloth and clean with mild dish detergent and water or a 50/50 solution of vinegar and water. Follow by rinsing the area with clean water; dry and polish with a soft cloth. Glass cleaners may be used if sprayed on a soft cloth first. Do not spray liquids directly on the oven control and display area. Do not use large amounts of water on the control panel. Excess water on the control may damage the appliance. Do not use other liquid cleaners, abrasive cleaners, scouring pads, or paper towels. They will damage the finish.
Control panel Control keypad membrane Decorative trim (some models)	Use a soft cloth and clean with mild dish detergent and water or a 50/50 solution of vinegar and water. Follow by rinsing the area with clean water; dry and polish with a soft cloth. Glass cleaners may be used if sprayed on a soft cloth first. Do not spray liquids directly on the oven control and display area. Do not use large amounts of water on the control panel. Excess water on the control area may cause damage to the appliance. Do not use other liquid cleaners, abrasive cleaners, scouring pads, or paper towels. They will damage the finish.
Stainless Steel (some models)	Only use cleaners and polishes specifically manufactured for cleaning stainless steel. Always rub in direction of metal grain to avoid damaging. Do not use cleaners with high concentrations of chlorine. Do not use harsh scrubbing cleaners. Polish with a lint-free cloth. Wipe excess cleaner/polish off from the metal surface as bluish stains may occur during future oven heating that cannot be removed. Clean heavier soils with hot, soapy water and a cloth or sponge. Use clean water to rinse; use a cloth to dry.
Porcelain enamel broiler pan and Insert (available by mail order) Door liner and body parts	Gentle scouring with a soapy scouring pad will remove most spots. Rinse with a 1:1 solution of clear water and ammonia. If necessary, cover difficult spots with an ammonia-soaked paper towel for 30 to 40 minutes. Rinse with clean water and a damp cloth, and then scrub with a soap-filled scouring pad. Rinse and wipe dry with a clean cloth. Remove all cleaners or the porcelain may become damaged during future heating.
Oven interior	Remove oven racks from the oven cavity before cleaning the oven interior. Use a mild, abrasive cleaner following manufacturer's instructions. Rinse with clean water and dry.
Oven door	Use soap and water to thoroughly clean the top, sides, and front of the oven door. Rinse well. You may use a glass cleaner on the outside door glass. Do not immerse the door in water. Do not spray or allow water or the glass cleaner to enter the door vents. Do not use oven cleaners, cleaning powders, or any harsh abrasive cleaning materials on the outside of the oven door. The oven gasket is essential for a good seal. It is located on the inner frame of the door and visible when the door is opened. Do not clean the oven door gasket. On self clean models, the oven door gasket is made of a woven material. Care should be taken not to rub, damage, or remove this gasket.

Care and Cleaning

General Cleaning

Before manually cleaning any part of the oven, be sure all controls are turned off and the oven is cool. Ammonia must be rinsed before operating the oven. Provide adequate ventilation. Wear rubber gloves when cleaning the appliance manually. Remove spillovers and heavy soiling as soon as possible.

Aluminum Foil, Aluminum Utensils, and Oven Liners

Never cover any slots, holes, or passages in the oven bottom or cover an entire oven rack with materials such as aluminum foil. Doing so blocks air flow through the oven and may cause carbon monoxide poisoning. Aluminum foil linings may trap heat, causing a fire hazard.

Protective Liners—Do not use aluminum foil or any other oven liners or materials to line the oven bottom. The high heat of the oven can melt these materials to the oven cavity and ruin the oven. These types of materials can also reduce the effectiveness of the air circulation in the oven and produce poor baking results.

- **Aluminum foil** - Only use aluminum foil as recommended in this manual. Improper installation of these liners may result in risk of electric shock or fire.
- **Oven racks** - Do not use aluminum foil to cover the oven racks. Using a liner in the oven restricts the heat and air flow needed to obtain the best possible cooking results for any oven.

Adhere to the following precautions when using spray oven cleaners:

- Do not spray cleaner on the electrical controls or switches because it could cause a short circuit and result in sparking or fire.
- Do not spray any cleaner on the oven door trim or gasket, handles, or any exterior surfaces of the oven, plastic or painted surfaces. The cleaner can damage these surfaces.

Cleaning Exposed Bake Ovens

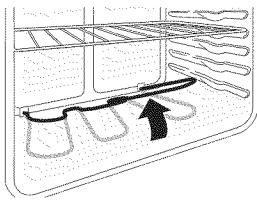

Figure 9: Exposed bake element in oven cavity

The bake element is located in the bottom of the oven cavity (Figure 9). If the lower bake element is visible it may be tilted up to allow easier access to the oven bottom for cleaning. Be careful not to raise the element more than 4 or 5 inches from the resting position. Remove the bottom oven rack before raising the element.

Broiler Pan Cleaning Tips

To prevent grease from baking on, remove the broiler pan from the oven as soon as cooking is completed. Use hot pads because the broiler pan is extremely hot. Pour off grease. Soak the pan in hot, soapy water. Clean the broiler pan as soon as possible after each use. If necessary, use soap-filled steel wool pads. Heavy scouring may scratch the grid.

Replacing the Oven Lights

The interior oven lights are located at the rear of the oven cavity and covered with a glass shield. The glass shield must be in place whenever the oven is in use (See Figure 10).

Be sure the oven is unplugged or power is turned off and all parts are cool before replacing oven light. Wear a leather-faced glove for protection against possible broken glass. Do not allow your fingers to touch the new bulb when replacing. This will shorten the life of the bulb. Use a paper towel or cotton glove while handling the new bulb when installing.

1. Turn electrical power off at the main source or unplug the appliance
2. Remove interior oven light shield by turning a quarter turn counter-clockwise.
3. Replace bulb with a new T-4 type Halogen 25 watt appliance bulb.
4. Replace glass oven light shield by rotating clockwise.
5. Turn power back on again at the main source (or plug the appliance back in).
6. Be sure to reset the time of day on the clock.

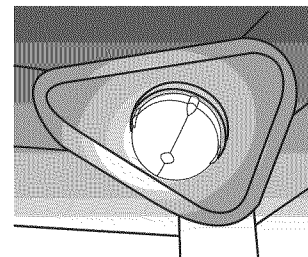

Figure 10: Halogen light

Removing and Replacing the Oven Door

The door is heavy. For safe, temporary storage, lay the door flat with the inside of the door facing down.

To prevent possible burns, do not attempt to remove the oven door until the oven has completely cooled.

To remove the oven door:

1. Open oven door completely, horizontal with floor (Figure 11).
2. Pull down the door hinge locks located on each hinge support toward front of the oven until the lock stops. (Figure 12).
3. Grasp the door by the sides, and close the door until the door frame makes contact with unlocked hinges. (Figure 13)
4. Pull the bottom of the door toward you while rotating the top of the door toward the appliance to completely disengage the hinge arm from the roller pins. (Figure 14).

To replace the oven door:

1. Firmly grasp both sides of oven door along the door sides. Do not use the oven door handle (Figure 13).
2. Hold the oven door at the same angle as the removal position. Carefully seat the hinge arms over the roller pins until you feel the hinge levers are secure.
3. Fully open the oven door, horizontal with floor (Figure 11).
4. Push the door hinge locks up toward and into the oven frame on both left and right oven door hinges to the locked position (Figure 13).
5. Close the oven door.

IMPORTANT!

Special Door Care Instructions - Most oven doors contain glass that can break.

Read the following recommendations:

- Do not close the oven door until all the oven racks are fully in place.
- Do not hit the glass with pots, pans, or any other object.
- Scratching, hitting, jarring, or stressing the glass may weaken its structure causing an increased risk of breakage at a later time.

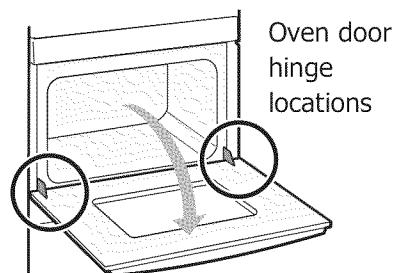

Figure 11: Location of hinges

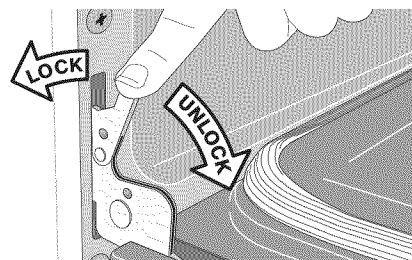

Figure 12: Hinge locks

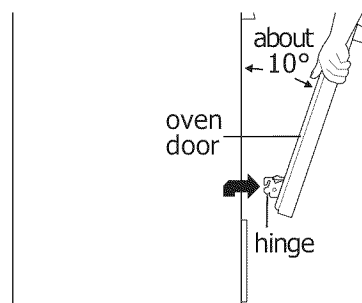

Figure 13: Lifting door from hinge hooks.

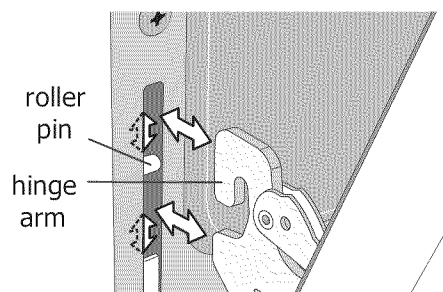

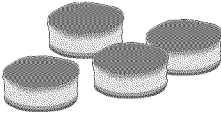
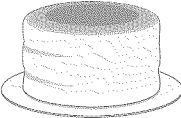
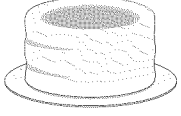

Figure 14: Remove (and replace) door

BEFORE YOU CALL

For best cooking results, heat the oven before baking cookies, breads, cakes, pies, or pastries, etc. There is no need to preheat the oven for roasting meat or baking casseroles.

The cooking times and temperatures needed to bake a product may vary slightly from your previously owned appliance.

Baking Problems and Solutions

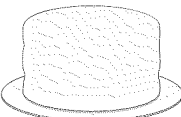
Baking Problems	Causes	Corrections
<p>Cookies and biscuits burn on the bottom.</p> 	<ul style="list-style-type: none"> • Cookies and biscuits put into oven before the preheating time is completed. • Oven rack is overcrowded or rack position too low. • Dark pans absorb heat too fast. 	<ul style="list-style-type: none"> • Allow oven to preheat to desired temperature before placing food in oven. • Choose pan sizes that will permit 2" to 4" of air space (5.1 cm to 10.2 cm) on all sides when placed in the oven. • Use a medium weight baking sheet.
<p>Cakes too dark on top or bottom</p> 	<ul style="list-style-type: none"> • Cakes put in oven before preheating time is completed. • Rack position too high or too low. • Oven too hot. 	<ul style="list-style-type: none"> • Allow oven to preheat to the selected temperature before placing food in the oven. • Use proper rack position for baking needs. • Set oven temperature 25°F (13°C) lower than recommended.
<p>Cakes not done in center</p> 	<ul style="list-style-type: none"> • Oven too hot. • Incorrect pan size. • Pan not centered in oven. 	<ul style="list-style-type: none"> • Set oven temperature 25°F (13°C) lower than recommended. • Use pan size suggested in recipe. • Use proper rack position and place pan so there is 2" to 4" (5.1 cm to 10.2 cm) of space on all sides of pan.
<p>Cakes not level.</p> 	<ul style="list-style-type: none"> • Oven not level. • Pan too close to oven wall or rack overcrowded. • Pan warped. • Oven light left on while baking. 	<ul style="list-style-type: none"> • Place a marked glass measuring cup filled with water on the center of the oven rack. If the water level is uneven, refer to the installation instructions for leveling the oven. • Be sure to allow 2" to 4" (5.1 cm to 10.2 cm) of clearance on all sides of each pan in the oven. • Do not use dented or warped pans. • Leave oven light off while baking.
<p>Foods not done when cooking time is over.</p> 	<ul style="list-style-type: none"> • Oven too cool. • Oven overcrowded. • Oven door opened too frequently. 	<ul style="list-style-type: none"> • Set oven temperature 25°F (13°C) higher than suggested and bake for the recommended time. • Be sure to remove all pans from the oven except the ones to be used for baking. • Open the oven door only after shortest recommended baking time.

Solutions to Common Problems

Before you call for service, review the following list. It may save you time and expense. Possible solutions are provided with the problem listed:

Problem	Solution
Oven control panel beeps and displays error codes	<ul style="list-style-type: none"> Oven control has detected a fault or error condition. Press STOP to clear the error code. Try bake or broil function. If the F or E code error repeats, turn off power to appliance, wait 5 minutes and then repower appliance. Set clock with correct time of day. Try bake or broil function again. If fault recurs, press STOP to clear.
Poor baking results	<ul style="list-style-type: none"> Many factors affect baking results. Use proper oven rack position. Center food in the oven and space pans to allow air to circulate. Preheat oven to the set temperature before placing food in the oven. If you feel the oven is too hot or cool, see "Adjusting the Oven Temperature" on page 12.
Appliance is not level.	<ul style="list-style-type: none"> Kitchen cabinet alignment may make range appear not level. Be sure cabinets are square and have sufficient room for appliance clearance.
Cannot move appliance easily.	<ul style="list-style-type: none"> Cabinets not square or are built in too tight to allow clearance for appliance. Contact builder or installer to make appliance accessible.
Appliance does not operate.	<ul style="list-style-type: none"> Make sure power cord is plugged properly into outlet. If electricity to home is working, check fuse box or breaker. Call your local electric company for service outage information. Service wiring is not complete. Call 1-844-553-6667 for assistance (See back cover).
Flames inside oven or smoking from oven vent.	<ul style="list-style-type: none"> Excessive spills in oven. Grease or food spilled onto oven bottom or oven cavity. Wipe up excessive spills before starting oven. If flames or excessive smoke are present see "Setting Broil" on page 11.
Self Clean does not work	<ul style="list-style-type: none"> Oven control not set properly. Make sure the oven door is closed. Make sure you have removed the oven racks. See "Cleaning the Oven" on page 12
Oven does not operate.	<ul style="list-style-type: none"> The time of day is not set. The oven clock must first be set in order to operate the oven. See "Setting the Clock" on page 8. Be sure oven controls are set properly. See "Oven Control Features" beginning on page 8 and review instructions for the desired cooking function in this manual.
Soil not completely removed after Self Clean	<ul style="list-style-type: none"> Excessive spills on oven bottom. Clean before starting Self Clean. Failure to clean soil from the oven frame, the door liner outside the gasket, and the small area at the front center of the oven bottom. These areas are not in the self cleaning area, but get hot enough to burn on residue. Clean these areas before starting the self cleaning cycle. Burned-on residue can be cleaned with a stiff nylon brush and water or a nylon scrubber. Be careful not to damage the oven gasket.
Oven smokes excessively when broiling	<ul style="list-style-type: none"> Incorrect setting. See "Setting Broil" on page 11. Meat too close to the broil element. Reposition broil rack to provide proper clearance between the meat and broil element. Remove excess fat from meat. Cut remaining fatty edges to prevent curling, but do not cut into lean. Grease build up on oven surfaces. Regular cleaning is necessary when broiling frequently. Grease or food splatters will cause excessive smoking.
Oven racks discolored or do not slide easily	<ul style="list-style-type: none"> Oven racks left in oven cavity during Self Clean. Always remove oven racks from oven cavity before starting a self clean cycle. Clean by using a mild abrasive cleaner following manufacturer's instructions. Rinse with clean water, dry and replace in oven.
Oven light does not work.	<ul style="list-style-type: none"> Be sure the oven light is secure in the socket. See "Replacing the Oven Lights" on page 14.

Master Protection Agreements

Congratulations on making a smart purchase. Your new Kenmore® product is designed and manufactured for years of dependable operation. But like all products, it may require preventive maintenance or repair from time to time. That's when having a Master Protection Agreement can save you money and aggravation.

The Master Protection Agreement also helps extend the life of your new product. Here's what the Agreement* includes:

- ☑ **Parts and labor** needed to help keep products operating properly **under normal use**, not just defects. Our coverage goes **well beyond the product warranty**. No deductibles, no functional failure excluded from coverage – **real protection**.
- ☑ **Expert service** by a force of more than **10,000 authorized Sears service technicians**, which means someone you can trust will be working on your product.
- ☑ **Unlimited service calls and nationwide service**, as often as you want us, whenever you want us.
- ☑ **"No-lemon" guarantee** – replacement of your covered product if four or more product failures occur within twelve months.
- ☑ **Product replacement** if your covered product can't be fixed.
- ☑ **Annual Preventive Maintenance Check** at your request – no extra charge.
- ☑ **Fast help by phone** – we call it **Rapid Resolution** – phone support from a Sears representative on all products. Think of us as a "talking owner's manual".
- ☑ **Power surge protection** against electrical damage due to power fluctuations.
- ☑ **\$250 Food Loss Protection** annually for any food spoilage that is the result of mechanical failure of any covered refrigerator or freezer.
- ☑ **Rental reimbursement** if repair of your covered product takes longer than promised.
- ☑ **25% discount** off the regular price of any non-covered repair service and related installed parts.

Once you purchase the Agreement, a simple phone call is all that it takes for you to schedule service. You can call anytime day or night, or schedule a service appointment online.

The Master Protection Agreement is a risk free purchase. If you cancel for any reason during the product warranty period, we will provide a full refund. Or, a prorated refund anytime after the product warranty period expires. Purchase your Master Protection Agreement today!

Some limitations and exclusions apply. For prices and additional information in the U.S.A. call 1-800-827-6655.

*** Coverage in Canada varies on some items. For full details call Sears Canada at 1-800-361-6665.**

Sears Installation Service

For Sears professional installation of home appliances, garage door openers, water heaters, and other major home items, in the U.S.A. or Canada call 1-800-4-MY-HOME®.

Acuerdos maestros de protección

Enhorabuena por haber hecho una compra inteligente. Su nuevo producto Kenmore® está diseñado y fabricado para brindarle años de funcionamiento fiable. Pero, como cualquier producto, puede necesitar mantenimiento preventivo o reparaciones periódicas. Es por eso que tener un Acuerdo maestro de protección podría ahorrarle dinero y molestias.

El Acuerdo maestro de protección también sirve para prolongar la durabilidad de su nuevo producto. El acuerdo* incluye lo siguiente:

- ☑ **Piezas y mano de obra** necesarias para contribuir a mantener el funcionamiento adecuado de los productos **utilizados en condiciones normales de uso**, no sólo en caso de defectos de los productos. Nuestra cobertura va **mucho más allá que la garantía del producto**. No se aplican deducibles ni exclusiones por fallas del funcionamiento: es decir, **verdadera protección**.
- ☑ **Servicio técnico por expertos** (más de **10000 técnicos autorizados de Sears**), lo cual significa que quien repare o realice el mantenimiento de su producto será un profesional de confianza.
- ☑ **Servicio técnico a escala nacional y número ilimitado de llamadas de solicitud de servicio técnico**: se puede poner en contacto con nosotros cuantas veces lo desee y cuando lo desee.
- ☑ **Garantía "sin sorpresas"**: se reemplaza el producto cubierto por el acuerdo si ocurren cuatro o más fallas del producto en un periodo de 12 meses.
- ☑ **Reemplazo del producto**: en caso de que no se pueda reparar el producto cubierto por el acuerdo.
- ☑ **Revisión anual preventiva de mantenimiento del producto**: puede solicitarla en cualquier momento, sin costo alguno.
- ☑ **Rápida asistencia telefónica**, la cual denominamos **Solución rápida**: es decir, asistencia telefónica a través de cualquiera de nuestros representantes de Sears, sobre cualquiera de nuestros productos. Piense en nosotros como en un "manual parlante del usuario".
- ☑ **Protección contra fallas eléctricas**, contra daños debidos a fluctuaciones de la corriente eléctrica.
- ☑ **\$250 al año para cubrir cualquier posible deterioro de alimentos** que haya tenido que desechar debido a una falla mecánica de cualquiera de nuestros refrigeradores o congeladores cubiertos por este acuerdo.
- ☑ **Devolución de gastos de alquiler de electrodomésticos** si la reparación de su producto asegurado toma más que el tiempo prometido.
- ☑ **25% de descuento** aplicable tanto a los costos del servicio de reparación, como de las piezas instaladas relacionadas que no hayan quedado cubiertos por este acuerdo.

Una vez que haya realizado el pago de este acuerdo, bastará una simple llamada telefónica para concertar una visita de servicio. Puede llamar a cualquier hora del día o de la noche, o bien concertar una visita de servicio por Internet.

La adquisición del Acuerdo maestro de protección es una inversión exenta de riesgos. Si por cualquier motivo decide cancelar dicho acuerdo durante el periodo de garantía del producto, le haremos un reintegro total del valor. O bien un importe proporcional si cancela el acuerdo en cualquier otro momento posterior al vencimiento del periodo de garantía del producto. ¡Adquiera hoy mismo su Acuerdo maestro de protección!

Algunas limitaciones y exclusiones podrían aplicarse. Para solicitar precios e información adicional, llame al 1-800-827-6655 (en los EE.UU.).

*** La cobertura en Canadá varía en el caso de algunos artículos. Para obtener detalles completos al respecto, llame al 1-800-361-6665 de Sears de Canadá.**

Servicio de instalación de Sears

Para solicitar la instalación por profesionales de Sears de electrodomésticos, abridores de puertas de garaje, calentadores de agua y otros artículos de uso prioritario en el hogar, llame al 1-800-4-MY-HOME en los EE.UU. o Canadá.

Kenmore®

For Sears Home Services in-home repair
of all Kenmore major appliances.

For the replacement parts, accessories and
Use & Care Guides that you need to do-it-yourself.

For professional installation of major home appliances
and items like air conditioners and water heaters.

1-844-553-6667

www.kenmore.com

In Canada 1-800-469-4663

www.sears.ca

Call anytime for the location of your nearest
Sears Parts & Repair Service Center

1-800-488-1222 (U.S.A.)

1-800-469-4663 (Canada)

To purchase a protection agreement on a serviceable product :

1-800-827-6655 (U.S.A.)

1-800-361-6665 (Canada)

Para pedir servicio de reparación
a domicilio, y ordenar piezas:

1-888-SU-HOGAR®

(1-888-784-6427)

www.kenmore.com

Au Canada pour service en français:

1-800-LE-FOYER^{MC}

(1-800-533-6937)

www.sears.ca

