

**SAMSUNG**

HW-J470

HW-JM47

**Wireless Subwoofer (PS-WJ470)  
Wireless Receiver Module (SWA-7000S)**

User manual

Wireless Audio - Soundbar

Imagine the possibilities

Thank you for purchasing this Samsung product.  
To receive more complete service, please register your product at  
[www.samsung.com/register](http://www.samsung.com/register)

# FEATURES

## TV SoundConnect

TV SoundConnect lets you listen to audio from your TV on your Soundbar via a Bluetooth connection and lets you control the sound.

## HDMI

HDMI transmits video and audio signals simultaneously, and provides a clearer picture.

The unit is also equipped with the ARC function which lets you listen to sound from your TV through the Soundbar via an HDMI cable. This function is only available if you connect the unit to an ARC compliant TV.

## Wireless Subwoofer/SWA-7000S Wireless Module

Samsung's wireless module does away with cables running between the main unit and the subwoofer/SWA-7000S. Instead, the subwoofer/SWA-7000S connects to a compact wireless module that communicates with the main unit.

## Multi-function Remote Control

You can use the supplied remote control to control various operations with the simple press of a button.

## USB Host Support

You can connect and play music files from external USB storage devices such as MP3 players, USB flash memory, etc. using the Soundbar's USB HOST function.

## Bluetooth Function

You can connect a Bluetooth device to the Soundbar and enjoy music with high quality stereo sound, all without wires!

## Using the Samsung Audio Remote App

To control the product with your Smart Device via the Samsung Audio Remote app, download the Samsung Audio Remote App by accessing the app through Google Play store.

# LICENSES



Manufactured under license from Dolby Laboratories. Dolby and the double-D symbol are trademarks of Dolby Laboratories.



For DTS patents, see <http://patents.dts.com>. Manufactured under license from DTS Licensing Limited. DTS, the Symbol, & DTS and the Symbol together are registered trademarks, and DTS 2.0 Channel is a trademark of DTS, Inc. © DTS, Inc. All Rights Reserved.

## HDMI

The terms HDMI and HDMI High-Definition Multimedia Interface, and the HDMI Logo are trademarks or registered trademarks of HDMI Licensing LLC in the United States and other countries.





# SAFETY INFORMATION



- The following also applies to the Wireless Subwoofer (PS-WJ470) and Wireless Receiver Module (SWA-7000S).

## SAFETY WARNINGS

TO REDUCE THE RISK OF ELECTRIC SHOCK, DO NOT REMOVE THE COVER (OR BACK).  
NO USER-SERVICEABLE PARTS ARE INSIDE. REFER SERVICING TO QUALIFIED SERVICE PERSONNEL.

	<b>CAUTION</b> RISK OF ELECTRIC SHOCK, DO NOT OPEN.		 The lighting flash and arrowhead within the triangle indicates that there is dangerous voltage inside the product.
			 The explanation point within the triangle indicates that there are important instructions accompanying the product.

### WARNING

- To reduce the risk of fire or electric shock, do not expose this appliance to rain or moisture.
- To prevent injury, this apparatus must be securely attached to the floor/wall in accordance with the installation instructions.
- This product contains chemicals known to the State of California to cause cancer and reproductive toxicity.

### CAUTION

- Do not expose this apparatus to dripping or splashing. Do not put objects filled with liquids, such as vases on the apparatus.
- To turn this apparatus off completely, you must pull the power plug out of the wall socket. Consequently, the power plug must be easily and readily accessible at all times.

This product satisfies FCC regulations when shielded cables and connectors are used to connect the unit to other equipment. To prevent electromagnetic interference with electric appliances, such as radios and televisions, use shielded cables and connectors for connections.

### FCC NOTE (for U.S.A):

This equipment has been tested and found to comply with the limits for a Class B digital device, pursuant to Part 15 of the FCC Rules. These limits are designed to provide reasonable protection against harmful interference in a residential installation.

This equipment generates, uses and can radiate radio frequency energy and, if not installed and used in accordance with the instructions, may cause harmful interference to radio communications. However, there is no guarantee that interference will not occur in a particular installation.

If this equipment does cause harmful interference to radio or television reception, which can be determined by turning the equipment off and on, the user is encouraged to try to correct the interference by one or more of the following measures:

- Reorienting or relocating the receiving antenna.
- Increasing the separation between the equipment and receiver.
- Connecting the equipment to an outlet that is on a different circuit than the radio or TV.
- Consulting the dealer or an experienced radio/TV technician for help.

Caution : FCC regulations state that any unauthorized changes or modifications to this equipment may void the user's authority to operate it.

## Important Safety Instructions

Read these operating instructions carefully before using the unit. Follow all the safety instructions listed below. Keep these operating instructions handy for future reference.

- 1) Read these instructions.
- 2) Keep these instructions.
- 3) Heed all warnings.
- 4) Follow all instructions.
- 5) Do not use this apparatus near water.
- 6) Clean only with dry cloth.
- 7) Do not block any ventilation openings. Install in accordance with the manufacturer's instructions.
- 8) Do not install near any heat sources such as radiators, heat registers, stoves, or other apparatus (including amplifiers) that produce heat.
- 9) Do not defeat the safety purpose of the polarized or grounding-type plug. A polarized plug has two blades with one wider than the other. A grounding type plug has two blades and a third grounding prong. The wide blade or the third prong are provided for your safety. If the provided plug does not fit into your outlet, consult an electrician for replacement of the obsolete outlet.
- 10) Protect the power cord from being walked on or pinched particularly at plugs, convenience receptacles, and the point where they exit from the apparatus.
- 11) Only use attachment/accessories specified by the manufacturer.
- 12) Use only with the cart, stand, tripod, bracket, or table specified by the manufacturer, or sold with the apparatus. When a cart is used, use caution when moving the cart/apparatus combination to avoid injury from tip-over.
- 13) Unplug this apparatus during lightning storms or when unused for long periods of time.
- 14) Refer all servicing to qualified service personnel. Servicing is required when the apparatus has been damaged in any way, such as when the power-supply cord or plug is damaged, liquid has been spilled or objects have fallen into the apparatus, the apparatus has been exposed to rain or moisture, does not operate normally, or has been dropped.



## PRECAUTIONS

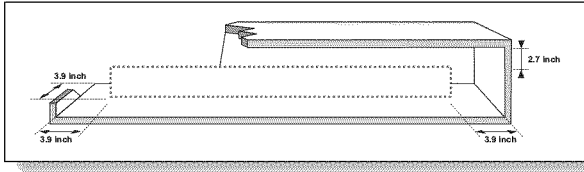

Ensure that the AC power supply in your house complies with the power requirements listed on the identification sticker located on the back of your product. Install your product horizontally, on a suitable base (furniture), with enough space around it for ventilation (3~4 inches). Make sure the ventilation slots are not covered. Do not place the unit on amplifiers or other equipment which may become hot. This unit is designed for continuous use. To fully turn off the unit, disconnect the AC plug from the wall outlet. Unplug the unit if you intend to leave it unused for a long period of time.

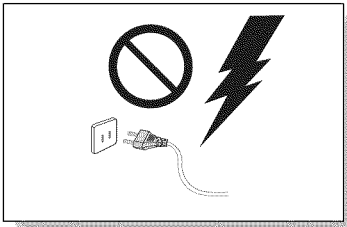

During thunderstorms, disconnect the AC plug from the wall outlet. Voltage peaks due to lightning could damage the unit.

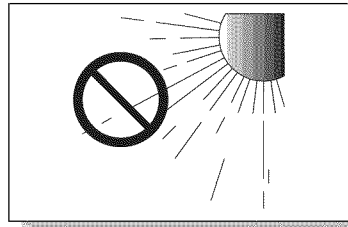

Do not expose the unit to direct sunlight or other heat sources. This could lead to overheating and cause the unit to malfunction.

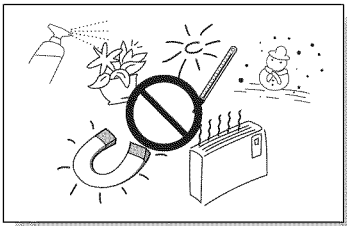

Protect the product from moisture (i.e. vases), and excess heat (e.g. a fireplace) or equipment creating strong magnetic or electric fields. Unplug the power cable from the AC wall socket if the unit malfunctions. Your product is not intended for industrial use. It is for personal use only. Condensation may occur if your product has been stored in cold temperatures. If transporting the unit during the winter, wait approximately 2 hours until the unit has reached room temperature before using.

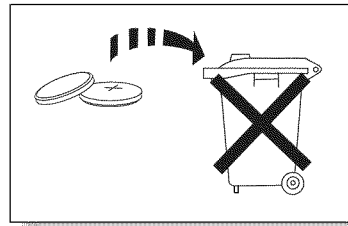

The battery used with this product contains chemicals that are harmful to the environment. Do not dispose of the battery in the general household trash. Do not expose the battery to excess heat, direct sunlight, or fire. Do not short circuit, disassemble, or overheat the battery. Danger of explosion if the battery is replaced incorrectly. Replace only with the same or equivalent type.



**WARNING: DO NOT INGEST BATTERY. CHEMICAL BURN HAZARD.** The remote control supplied with this product contains a coin/button cell battery. If the coin/button cell battery is swallowed, it can cause severe internal burns in just 2 hours and can lead to death. Keep new and used batteries away from children. If the battery compartment does not close securely, stop using the remote and make sure to keep it away from children. If you think the battery might have been swallowed or placed inside any part of the body, seek immediate medical attention.

# CONTENTS

## 2 GETTING STARTED

- 2 Features
- 3 Safety Information
- 6 What's Included

## 7 DESCRIPTIONS

- 7 Top / Front Panel
- 8 Rear Panel
- 9 Remote Control

## 11 INSTALLATION

- 11 Installing the Wall Mount
- 11 Installation Precautions
- 12 Installing the Bracket without Referring to the Wall-Mount Installation Guide
- 13 Detaching the Soundbar from the Wall Mounts

## 14 CONNECTIONS

- 14 Connecting the Subwoofer and SWA-7000S to the Main Unit
- 15 Connecting the Surround Speakers
- 16 Connecting an External Device using an HDMI cable
- 17 Connecting an External Device using Audio (analog) cable or Optical (digital) cable

## 18 FUNCTIONS

- 18 Input mode
- 18 ARC (HDMI OUT)
- 19 Bluetooth
- 21 Using the Samsung Audio Remote App
- 22 TV SoundConnect
- 23 USB
- 24 Software Update

## 25 TROUBLESHOOTING

- 25 Troubleshooting

## 26 APPENDIX

- 26 Specifications



Figures and illustrations in this User Manual are provided for reference only and may differ from actual product appearance.

# WHAT'S INCLUDED

## BEFORE READING THE USER'S MANUAL

Note the following terms before reading the user's manual.









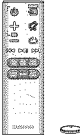

### ► Icons used in this manual

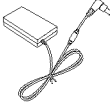
Icon	Term	Definition
	<b>Caution</b>	Indicates a situation where a function does not operate or settings may be canceled.
	<b>Note</b>	Indicates tips or instructions on the page that help you operate a function.

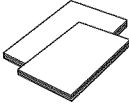
### ► Safety Instructions and Troubleshooting

- 1) Be sure to familiarize yourself with the Safety Instructions before using this product. (See page 3)
- 2) If a problem occurs, check Troubleshooting. (See page 25)



Check for the supplied accessories shown below.

			
<b>Remote Control / Lithium Battery (3V : CR2032)</b> (AH59-02692H / 4301-001042)	<b>Power Cord : 3EA</b> (3903-000598)	<b>DC Adapter</b> (BN44-00799A)	<b>Optical Cable</b> (AH39-00779A)
			
<b>USB Cable</b> (AH39-01270A)	<b>User Manual / Quick Guide</b> (AH68-02853A) / (AH68-02689N)	<b>(Wall Mount L: 1EA) (Wall Mount R: 1EA)</b>	
			
<b>Holder-Screw 1: 2EA</b> (AH61-03342A)	<b>Holder-Screw 2: 2EA</b> (6001-001961)	<b>Bracket-Wall Mount</b> (L : AH61-03833A / R : AH61-03834A)	
			
		<b>Wall Mount Guide</b> (AH63-03710A)	

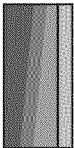
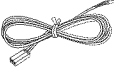

- The appearance of the accessories may differ slightly from the illustrations above.
- Use the dedicated USB cable to connect external USB devices to the unit.

### ► Speaker Components

			
<b>Surround Speaker : 2EA</b>	<b>Subwoofer</b>	<b>Speaker Cable : 2EA</b>	<b>Wireless Receiver Module (SWA-7000S)</b>

## TOP / FRONT PANEL

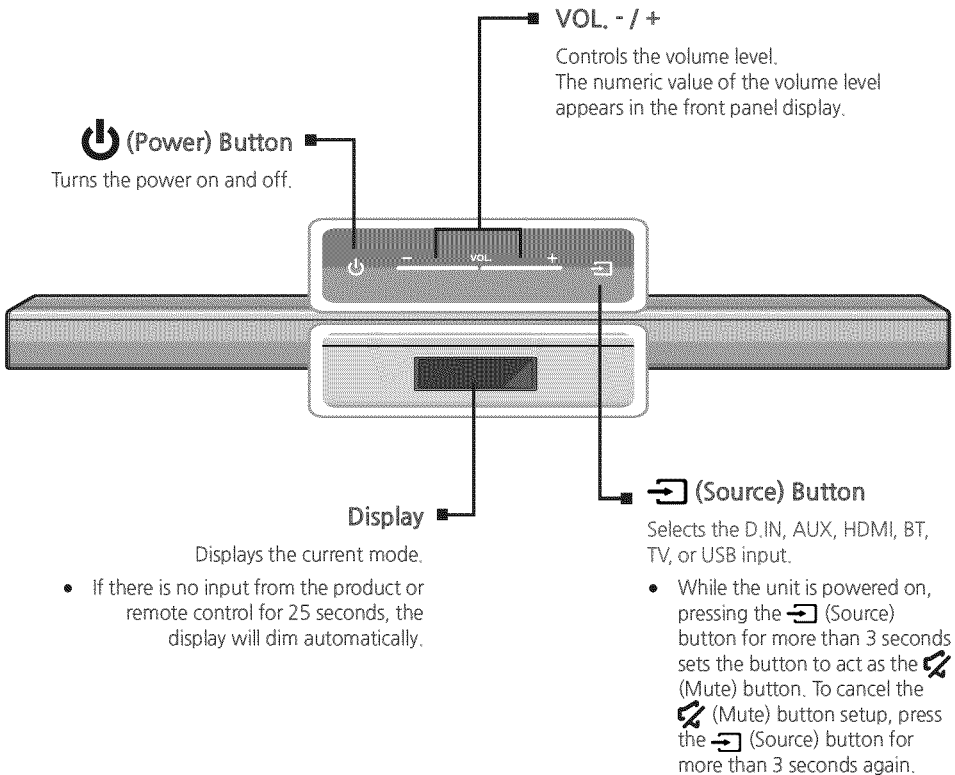

- When you turn on this unit, there will be a 4 to 5 second delay before it produces sound.
- If you want to enjoy sound only from the Soundbar, you must turn off the TV's speakers in the Audio Setup menu of your TV. Refer to the owner's manual supplied with your TV.

## REAR PANEL

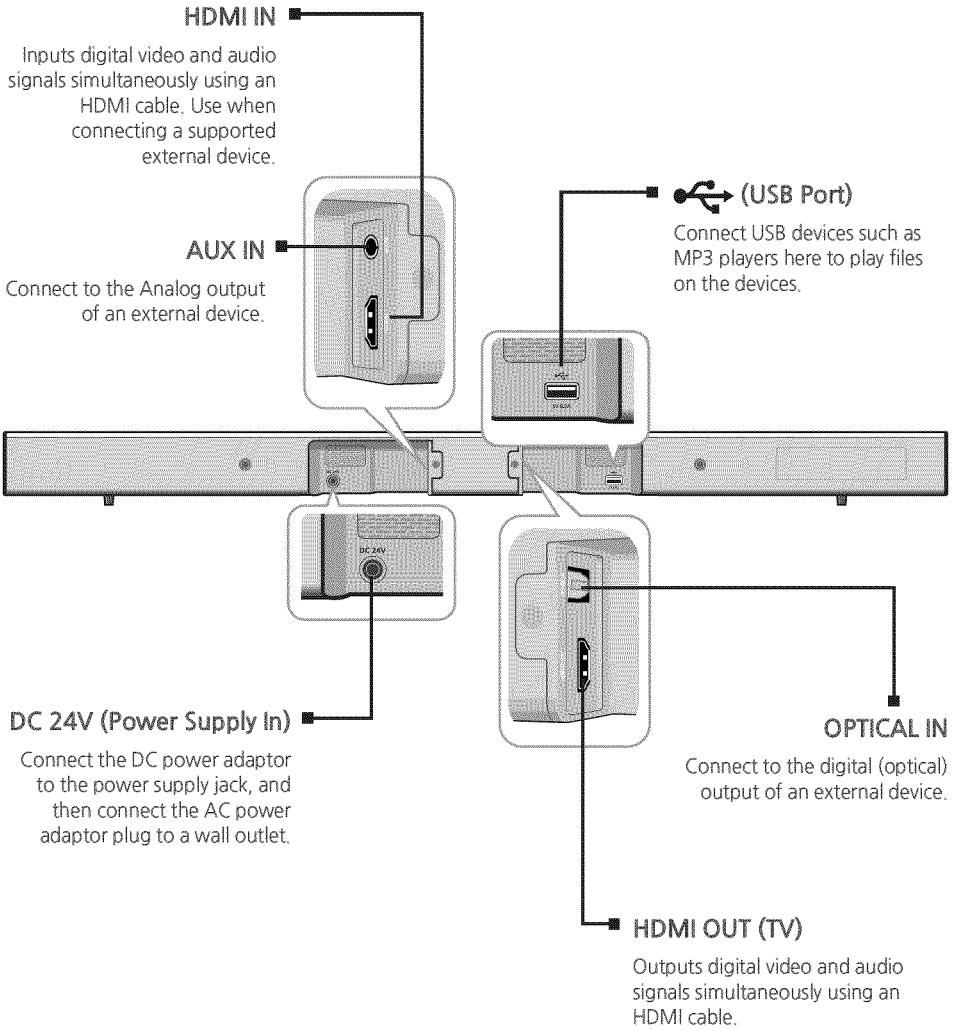

- !**
- When disconnecting the power cable of the AC power adaptor from the wall outlet, pull the plug. Do not pull the cable.
  - Do not connect this unit or other components to an AC outlet until all connections between components are complete.



# REMOTE CONTROL

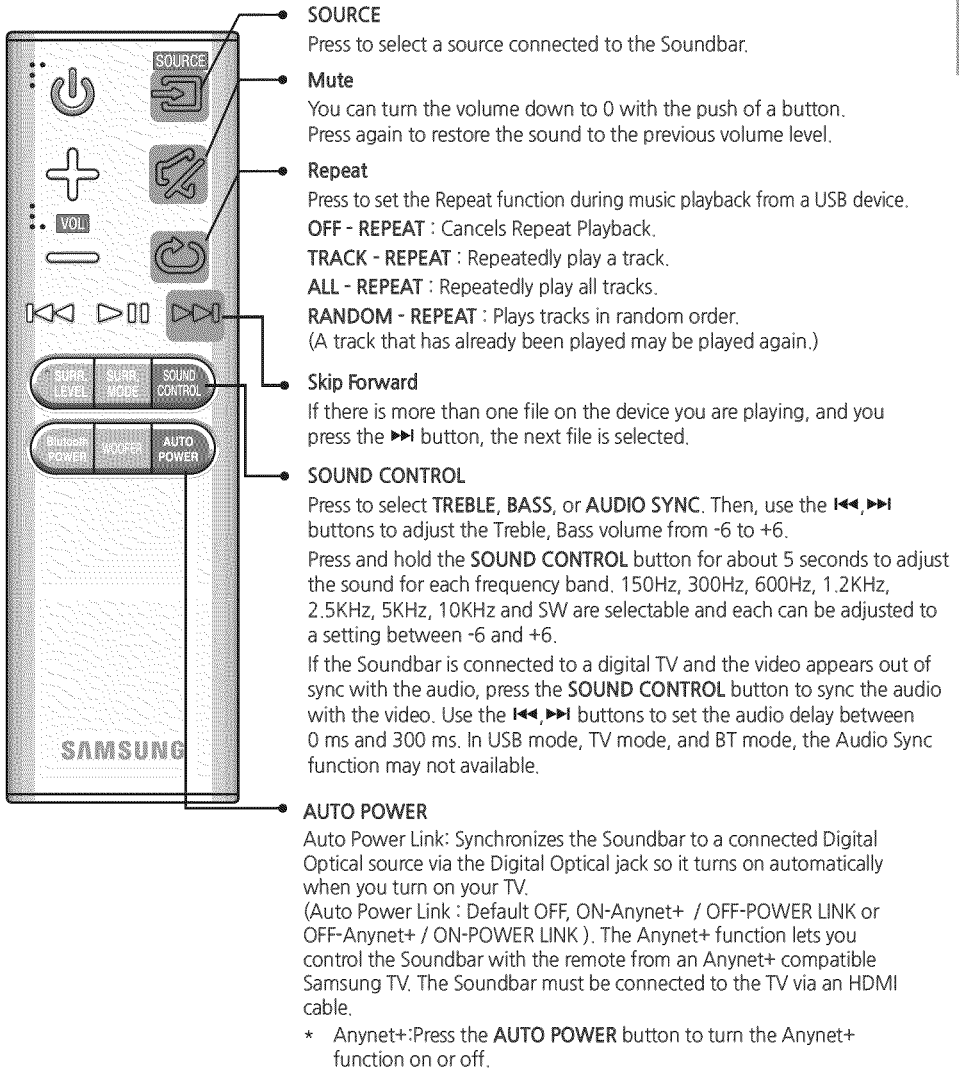

- Soundbar is a Samsung proprietary name.
- Operate the TV using the TV's remote control.

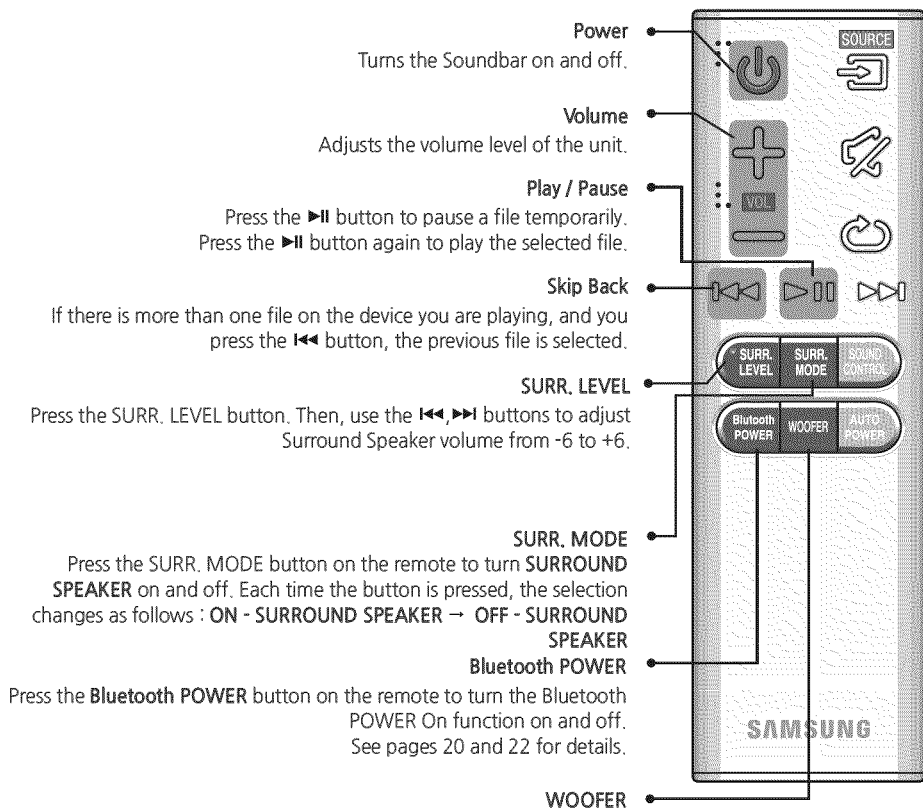

You can control the woofer volume.

Press the Woofer button, and then press the ◀◀, ▶▶ buttons to increase or decrease the subwoofer volume. You can select SW (-12, -6, -5, -4, -3, -2, -1, 0, +1, +2, +3, +4, +5, +6).

## INSTALLING THE BATTERY IN THE REMOTE CONTROL

1. Use a suitable coin to turn the remote control's battery cover counterclockwise to remove it as shown in the figure above.
2. Insert a 3V lithium battery. Keep the positive (+) pole facing up when inserting the battery. Put the battery cover on and align the '●' marks side by side as shown in the figure above.
3. Use a suitable coin to turn the remote control battery cover clockwise as far as it will go to fix it in place.

# INSTALLING THE WALL MOUNT

You can use the wall mount bracket to mount this unit on a wall.

## INSTALLATION PRECAUTIONS

- Install on a vertical wall only.
- For the installation, avoid a location with high temperature or humidity, or a wall that cannot sustain the weight of the set.
- Check the strength of the wall. If the wall is not strong enough to support the unit, reinforce the wall or install the unit on a different wall that can support the unit's weight.
- Purchase and use the fixing screws or anchors appropriate for the kind of wall you have (plaster board, iron board, wood, etc.). If possible, fix the support screws into wall studs.
- Purchase wall mounting screws according to the type and thickness of the wall you will mount the Soundbar on.
  - Diameter : M5
  - Length: 1 3/8 inches or longer recommended.
- Connect cables from the unit to external devices before you install it on the wall.
- Make sure the unit is turned off and unplugged before you install it. Otherwise, it may cause an electric shock.

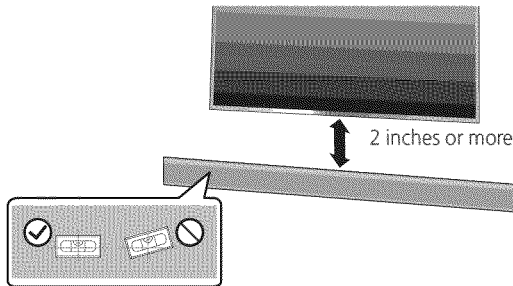

1. Place the installation guide against the wall surface.
  - The installation guide must be level.
  - If the TV is mounted on the wall, install the Soundbar at least 2 inches (5 cm) below the TV.

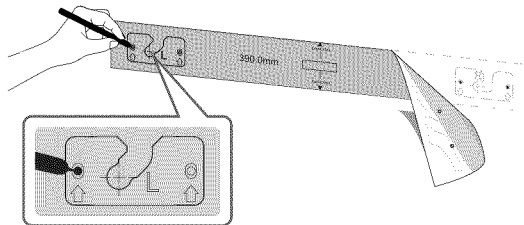

2. Mark the location where the screws will go through on the wall, and then remove the installation guide. Next, drill holes for the screws using an appropriately sized drill bit.

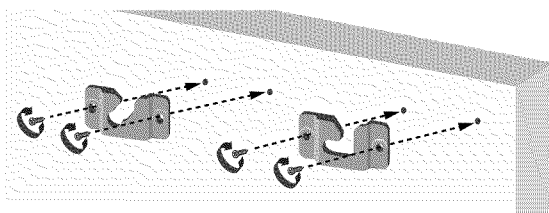

3. Fasten the wall mounts and screws to the marked locations.
  - The left and right mounts are different shapes. Make sure to position them correctly.

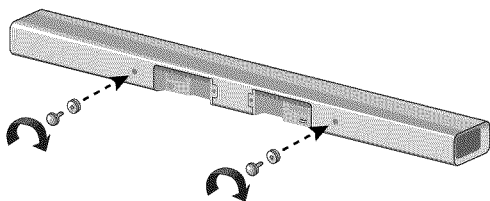

Wall Mounting the Sound Bar

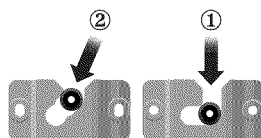

4. Secure the two holder screws to the screw holes on the back of the Soundbar's main body, one on the left and one on the right.
5. Set the holder screws on the back of the Soundbar into the grooves of the wall mounts. For safe installation, make sure to push the holder screws all the way to the bottom of the grooves.

## INSTALLING THE BRACKET WITHOUT REFERRING TO THE WALL-MOUNT INSTALLATION GUIDE

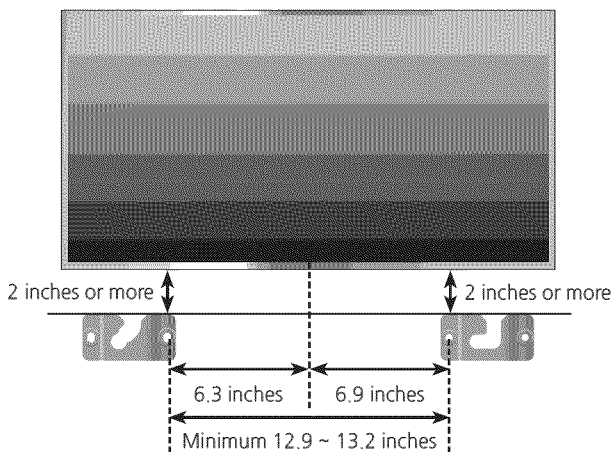

1. Place **Wall Mount L** on the desired wall surface parallel to the floor as shown on the previous page. Mark the location of the screw holes on the wall. Drill holes for the screws at the places you have marked.
2. Match the screw holes on Wall Mount L to the screw holes on the wall, and then screw one screw through the hole in its right end. Tighten the screw until it is firmly fixed to the wall.
3. Place **Wall Mount R** on the desired wall surface parallel to the floor and aligned with **Wall Mount L** as shown on the previous page. Mark the location of the screw holes on the wall. Drill holes for the screws at the places you have marked.
4. Match the screw holes on Wall Mount R to the screw holes on the wall, and then screw one screw through the hole in its right end. Tighten the screw until it is firmly fixed to the wall.
  - If you are mounting the Wall Mounts beneath the TV, make sure to position the mounts 2 or more inches below the TV and to align the mounts with the center of the TV as shown on the previous page.
5. Insert screws through the remaining holes, and then tighten.

## DETACHING THE SOUNDBAR FROM THE WALL MOUNTS

1. Pull the Soundbar upwards as shown in the figure to separate it from the wall mounts.

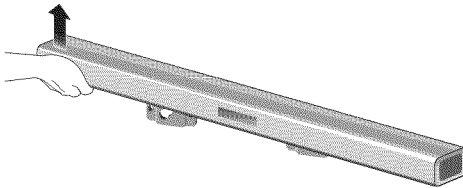

Detaching the Soundbar from the Wall Mounts

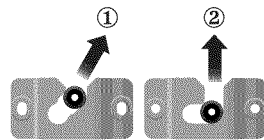

- Do not hang onto the installed unit and avoid striking or dropping the unit.
- Secure the unit firmly to the wall so that it does not fall off. If the unit falls off, it may cause an injury or damage the product.
- When the unit is installed on a wall, please make sure that children do not pull any of the connecting cables, as it may cause it to fall.
- For the optimal performance of a wall mount installation, install the speaker system at least 2 inches (5 cm) below the TV, if the TV is mounted on the wall.
- For your safety, if you do not mount the unit on the wall, install it on a secure, flat surface where it is unlikely to fall.



- Do not connect the power cord of this product or your TV to a wall outlet until all connections between components are complete.
- Before moving or installing this product, be sure to turn off the power and disconnect the power cord.

## CONNECTING THE SUBWOOFER AND SWA-7000S TO THE MAIN UNIT

### CONNECTING THE SUBWOOFER AND SWA-7000S AUTOMATICALLY

The linking IDs of the SWA-7000S wireless module and the subwoofer are preset at the factory. The subwoofer and the SWA-7000S should link (connect wirelessly) to the main unit automatically when you turn on the main unit, the subwoofer, and the SWA-7000S.

- When the subwoofer and SWA-7000S are completely connected, the blue LED Link indicators on the subwoofer and the SWA-7000S stop blinking.

### CONNECTING SUBWOOFER AND SWA-7000S MANUALLY

If the blue LED lights do not stop blinking when the main unit, subwoofer, and SWA-7000S are turned on, please reset the linking ID by following the procedure below.

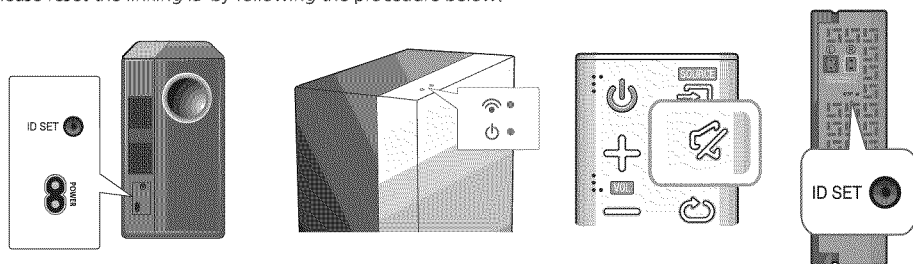

1. Plug the power cords of the main unit, subwoofer, and SWA-7000S into an AC wall outlet.
2. Press the **ID SET** button on the back of the subwoofer and the SWA-7000S with a small, pointed object for 5 seconds.
  - The **STANDBY** indicator turns off and the **LINK** indicator (Blue LED) blinks quickly.
3. While the main unit is powered off (in **STANDBY** mode), press and hold the **MUTE** on the remote control for 5 seconds.
4. The **ID SET** message appears on the Soundbar's display.
5. To finalize the link, turn the main unit's power on while the blue LEDs on the subwoofer and the SWA-7000S are blinking.
  - The main unit, subwoofer, and SWA-7000S should now be linked (connected).
  - The Link indicators (Blue LEDs) on the subwoofer and SWA-7000S should be glowing continuously. They should not be blinking.
  - If the Link Indicators are not solid blue, the linking process has failed. Turn off the main unit and start again from Step 2.



- Before moving or installing the product, be sure to turn off the power and disconnect the power cord.
- If the main unit is powered off, the wireless subwoofer will be in standby mode and the STANDBY LED on the upper side will come on after the Link indicator (Blue LED) blinks for 30 seconds.
- If you use a device that uses the same frequency (2.4GHz/5GHz) as the Soundbar near the Soundbar, interference may cause some sound interruption.
- The maximum transmission distance of the wireless signal between the main unit and the subwoofer and the main unit and the SWA-7000S is about 32.8 ft, but may vary depending on your operating environment. If a steel-concrete or metallic wall is between the main unit and the wireless subwoofer or the main unit and the SWA-7000S, the system may not operate at all, because the wireless signal cannot penetrate metal.
- If the main unit doesn't make a wireless connection, follow steps 1-5 on the previous page to re-set the connection between the main unit, the wireless subwoofer, and the SWA-7000S.



- A wireless receiving antenna is built into the wireless subwoofer and the SWA-7000S. Keep the both units away from water and moisture.
- For optimal listening performance, make sure that the areas around the wireless subwoofer and SWA-7000S are clear of any obstructions.

## CONNECTING THE SURROUND SPEAKERS

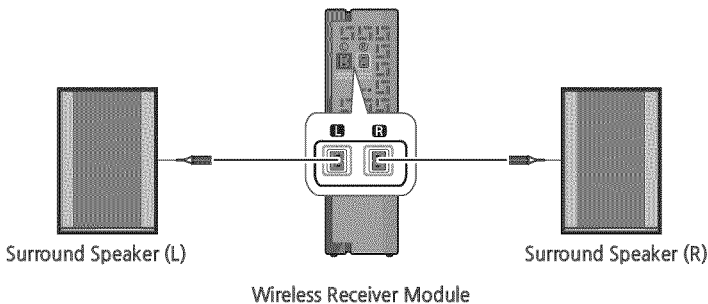

- Place these speakers to the side of your listening position. If there isn't enough room, place these speakers so they face each other. Position them about 2 to 3 feet above your ear, facing slightly downward.



- Surround speakers must be connected to the wireless receiver module.
- Each speaker has a colored label on its back or underside. Each cable has a single colored band near its end. Match the band on each cable to the speaker label by color, and then connect the cable to the speaker.

## CONNECTING AN EXTERNAL DEVICE USING AN HDMI CABLE

HDMI is the standard digital interface for connecting to TVs, projectors, DVD players, Blu-ray players, set top boxes, and more.

HDMI prevents any degradation to the signal due to conversion to analog and maintains the video and audio quality of the original digital source.

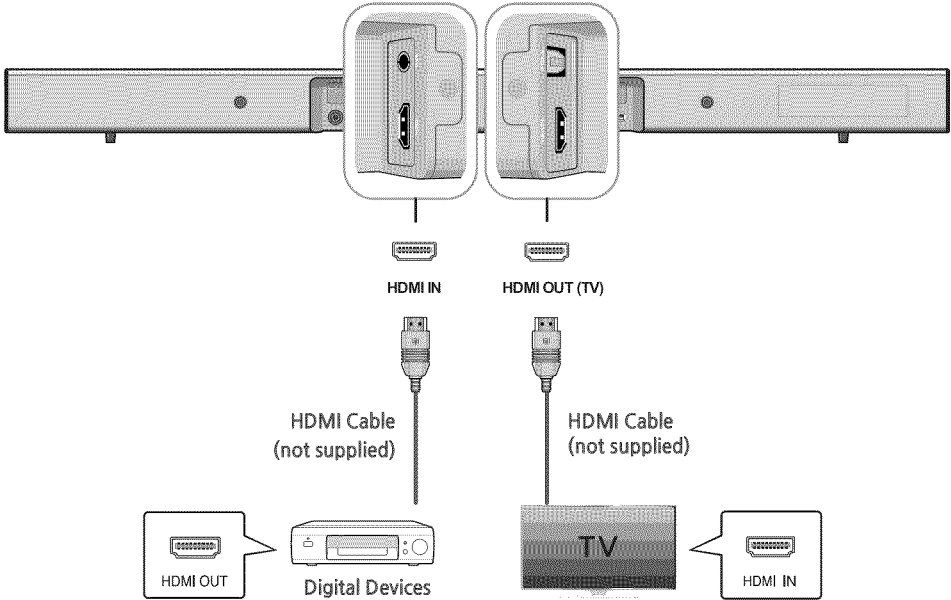

### HDMI IN

Connect an HDMI cable (not supplied) from the **HDMI IN** jack on the back of the product to the **HDMI OUT** jack on your digital device.

and

### HDMI OUT (TV)

Connect an HDMI cable (not supplied) from the **HDMI OUT (TV)** jack on the back of the product to the **HDMI IN** jack on your TV.

### HDMI OUT (ARC)

The ARC function allows digital audio to output via the **HDMI OUT (ARC)** port.

It can be enabled only when the Soundbar is connected to a TV that supports the ARC function



- HDMI is an interface that enables the digital transmission of video and audio data with just a single connector.



- Anynet+ must be turned on.
- This function is not available if the HDMI cable does not support ARC.



## CONNECTING AN EXTERNAL DEVICE USING AUDIO (ANALOG) CABLE OR OPTICAL (DIGITAL) CABLE

This unit comes equipped with one digital optical in jack and one analog audio in jack (Aux In), giving you two ways to connect it to a TV.

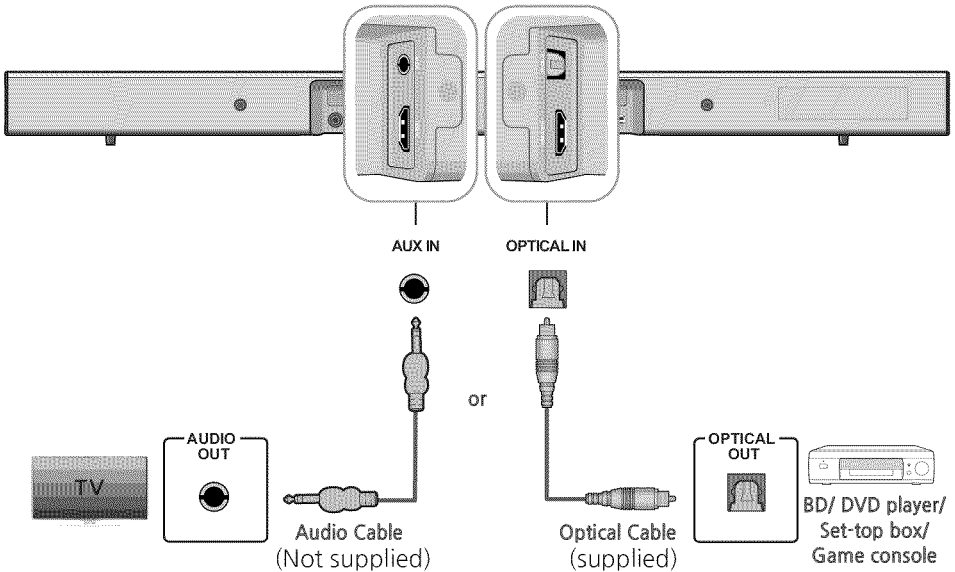

### AUX IN

Connect **AUX IN** (Audio) on the main unit to the **AUDIO OUT** jack of the TV or Source Device. To use, change the function to **AUX**.

or

### OPTICAL IN



Connect **OPTICAL IN** (Audio) on the main unit to the **OPTICAL OUT** jack of the TV or Source Device. To use, change the function to **D.IN**.



- Do not connect the power cord of this product or your TV to the wall outlet until all connections between components are complete.
- Before moving or installing this product, be sure to turn off the power and disconnect the power cord.

# FUNCTIONS

## INPUT MODE

Press the  button on the main unit's top panel or the  (SOURCE) button on the remote control to select the mode you want.

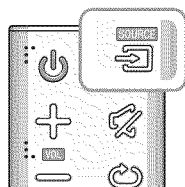
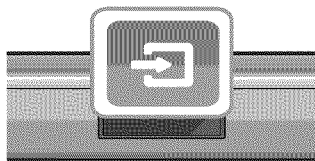

Input mode	Display
Optical Digital input	<b>D.IN</b>
AUX input	<b>AUX</b>
HDMI input	<b>HDMI</b>
BLUETOOTH mode	<b>BT</b>
TV SoundConnect	<b>TV</b>
USB mode	<b>USB</b>

The unit turns off automatically in the following situations.

- D.IN/HDMI/BT/TV/USB Mode
  - If there is no audio signal for 25 minutes.
- AUX Mode
  - If the AUX cable is disconnected for 25 minutes.
  - In Auto Power Down ON mode, if there is no KEY input for 8 hours when the AUX cable is connected.
  - To turn the Auto Power Down function ON or OFF, press and hold the  button for 5 seconds. OFF/ON-AUTO POWER DOWN appears on the display.

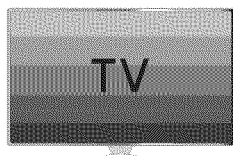

## ARC (HDMI OUT)

ARC (Audio Return Channel) transmits the digital audio signal to the HDMI OUT (ARC) port.



HDMI Cable  
(Not supplied)



1. Connect a TV supporting ARC to the Soundbar with an HDMI cable.
2. Turn on the TV, turn on the Soundbar, and then turn on the Soundbar's Anynet+ function.
3. Press the  button on the main unit's top panel or the  (SOURCE) button on the remote control to select the **D.IN** mode.



- If the HDMI cable does not support the ARC function, ARC will not work.
- To turn off the ARC function, turn Anynet+ off.



## BLUETOOTH

You can connect a Bluetooth device to the Soundbar and enjoy music with high quality stereo sound, all without wires!

### ► To connect the Soundbar to a Bluetooth device

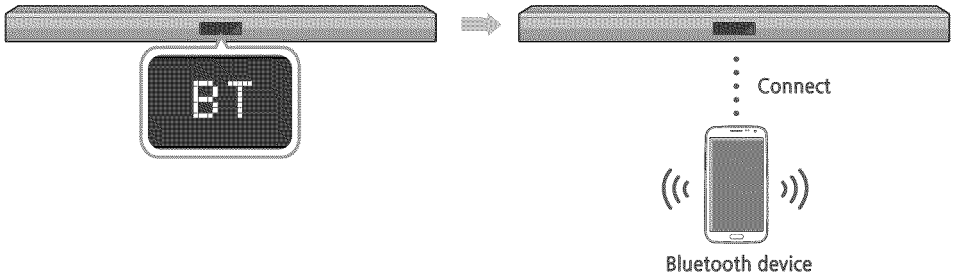
Check if the Bluetooth device supports the Bluetooth compliant stereo headset function.



- Press the  button on the main unit's top panel or the  (SOURCE) button on the remote control to select the **BT** mode.
  - You will see **BT READY** on the front display of the Soundbar.
- Select the Bluetooth menu on the Bluetooth device you want to connect. (Refer to the Bluetooth device's user manual.)
- Select the Stereo headset menu on the Bluetooth device.
  - You will see a list of scanned devices.
- Select "[Samsung] Soundbar J-Series" from the list.
  - When the Soundbar is connected to the Bluetooth device, it will display **Bluetooth device name** → **BT** on the front display.
  - The device name can only be displayed in English. An underline " \_ " will be displayed if the name is not in English.
  - If the Bluetooth device has failed to pair with the Soundbar, delete the previous "[Samsung] Soundbar J-Series" found by the Bluetooth device and have it search for the Soundbar again.
- Play music on the connected device.
  - You can listen to the music playing on the connected Bluetooth device over the Soundbar. In BT mode, the Play/Pause/Next/Prev functions are not available. However, these functions are available in Bluetooth devices supporting AVRCP.



- If asked for PIN code when connecting a Bluetooth device, enter <0000>.
- Only one Bluetooth device can be paired at a time.
- The Bluetooth connection will be terminated when you turn the Soundbar off.
- The Soundbar may not perform Bluetooth search or connection correctly under the following circumstances:
  - If there is a strong electrical field around the Soundbar.
  - If several Bluetooth devices are simultaneously paired with the Soundbar.
  - If the Bluetooth device is turned off, not in place, or malfunctions.
- Note that such devices as microwave ovens, wireless LAN adaptors, fluorescent lights, and gas stoves use the same frequency range as the Bluetooth device, which can cause electric interference.
- The Soundbar supports SBC data (44.1kHz, 48kHz).
- Connect only to a Bluetooth device that supports the A2DP (AV) function.
- You cannot connect the Soundbar to a Bluetooth device that supports only the HF (Hands Free) function.
- Once the HW-J470 has been paired with a device, if the Soundbar is in D.IN, AUX, HDMI or USB mode and you select "[Samsung] Soundbar J-Series" from your Bluetooth device's list, the HW-J470 will automatically change to **BT** mode.

### ► Bluetooth POWER on (Bluetooth POWER)

When the Bluetooth Power On function is on and the Soundbar is turned off, if a previously paired Bluetooth device tries to pair with the Soundbar, the Soundbar turns on automatically.

1. To turn Bluetooth Power ON, press the **Bluetooth POWER** button on the remote while the Soundbar is turned on.
2. ON-Bluetooth POWER appears on the Soundbar's display.





- Available only if the Soundbar is listed among the Bluetooth device's paired devices. (The Bluetooth device and the Soundbar must have been previously paired at least once.)
- Soundbar will appear in the Bluetooth device's searched devices list only when the Soundbar is displaying [BT READY].
- In the TV SoundConnect mode, the Soundbar cannot be paired to another Bluetooth device.

### ► To disconnect the Bluetooth device from the Soundbar

You can disconnect the Bluetooth device from the Soundbar. For instructions, see the Bluetooth device's user manual.

- The Soundbar will be disconnected.
- When the Soundbar is disconnected from the Bluetooth device, the Soundbar will display **BT DISCONNECTED** on the front display.

### ► To disconnect the Soundbar from the Bluetooth device

Press the  (SOURCE) button on the remote control or the  button on the product's top panel to switch from **BT** to another mode or turn off the Soundbar.

- The connected Bluetooth device will wait a certain amount of time for a response from the Soundbar before terminating the connection. (Disconnection time may differ, depending on the Bluetooth device)



- In Bluetooth connection mode, the Bluetooth connection will be lost if the distance between the Soundbar and the Bluetooth device exceeds 16.25 ft. (5m).
- The Soundbar automatically turns off after 25 minutes in the Ready state.

## More About Bluetooth

Bluetooth is a technology that enables Bluetooth-compliant devices to interconnect easily with each other using a short wireless connection.

- A Bluetooth device may cause noise or malfunction, depending on usage, if:
  - A part of your body is in contact with the receiving/transmitting system of the Bluetooth device or the Soundbar.
  - It is subject to electrical variation from obstructions caused by a wall, corner, or office partition.
  - It is exposed to electrical interference from same frequency-band devices including medical equipment, microwave ovens, and wireless LANs.
- Pair the Soundbar with the Bluetooth device while they are close together.
- The further the distance between the Soundbar and Bluetooth device, the worse the quality is. If the distance exceeds the Bluetooth operational range, the connection is lost.
- In poor reception areas, the Bluetooth connection may not work properly.
- The Bluetooth connection only works when it is close to the unit. The connection will be automatically cut off if the Bluetooth device is out of range. Even within range, the sound quality may be degraded by obstacles such as walls or doors.
- This wireless device may cause electric interference during its operation.

## USING THE SAMSUNG AUDIO REMOTE APP

### Installing the Samsung Audio Remote App

To control the HW-J470 with your smart device via the Samsung Audio Remote app, download the Samsung Audio Remote App from the Google Play store.



### Launching the Samsung Audio Remote App

Launch the Samsung Audio Remote app by touching the app's icon on your smart device, and then following the instructions in the app.

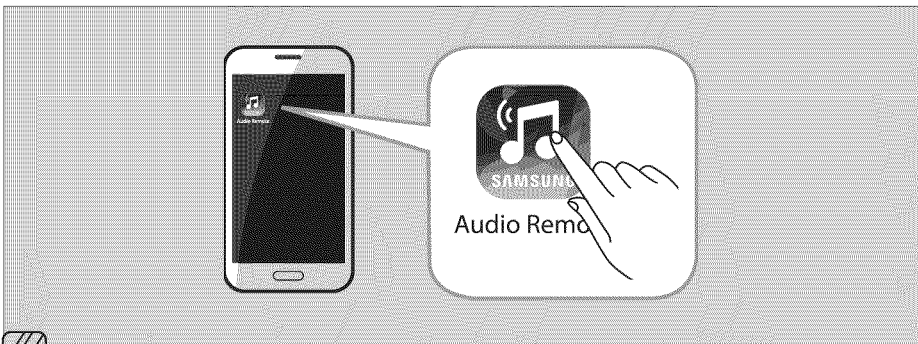



- The Samsung Audio Remote app is supported only on smart devices running Android OS 3.0 or higher.

## TV SOUNDCONNECT

You can enjoy TV sound through your Soundbar when it is connected to a Samsung TV that supports the TV SoundConnect function.

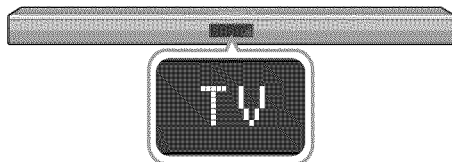
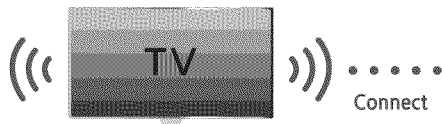
### ► Connecting a TV to the Soundbar



1. Turn on the TV and Soundbar.
  - Open the menu of the TV.
  - Move to Speaker Settings on the "Sound" tab.
  - Set the "Add New Device" to "On".
2. Press the  button on the main unit's top panel or the  (SOURCE) button on the remote control to select the TV mode.
3. On the TV, a message asking whether to enable the TV SoundConnect function appears. "[Samsung] Soundbar" is also displayed on the TV screen.
4. Select <Yes> using the TV remote to finish connecting the TV and Soundbar.

- If the distance between the TV and Soundbar exceeds 16.25 ft. (5m), the connection may not be stable or the audio may stutter. If this occurs, relocate the TV or Soundbar so that they are within operational range, and then re-establish the TV SoundConnect connection.



- Switching the Soundbar's mode from TV to another mode automatically terminates TV SoundConnect.
- To connect the Soundbar to another TV, the existing connection must be terminated.
- To terminate the existing connection, press and hold the  button on the remote for 5 seconds. To connect to the other TV, follow Steps 1 through 4 above.



- TV SoundConnect Operational Ranges:
  - Recommended pairing range: within 20 inches (within 50cm)
  - Recommended operational range: within 16.25 ft. (5m)
- The **Play/Pause**, **Next**, **Prev** buttons are not operable in TV SoundConnect mode.



- The TV SoundConnect (SoundShare) function is supported by some Samsung TVs released from 2012 on. Check whether your TV supports the TV SoundConnect (SoundShare) function before you begin. (For further information, refer to the TV's user manual.)
- If your Samsung TV was released before 2014, check the SoundShare setting menu.

### ► Using the Bluetooth POWER On function

The Bluetooth POWER On function is available after you have successfully connected the Soundbar to a Bluetooth compatible TV using TV SoundConnect. When the Bluetooth POWER On function is ON, turning the connected TV on or off will turn the Soundbar's power on and off as well.

1. Connect the TV to your Soundbar using the TV SoundConnect function.
2. Press the **Bluetooth POWER** button on the Soundbar remote. "ON/OFF-BLUETOOTH POWER" appears on the Soundbar's display.
  - ON-BLUETOOTH POWER : The Soundbar turns on and off when you turn the TV on or off.
  - OFF-BLUETOOTH POWER : The Soundbar only turns off when you turn the TV off.





- This function is supported by some Samsung TVs released from 2013 on.

# USB

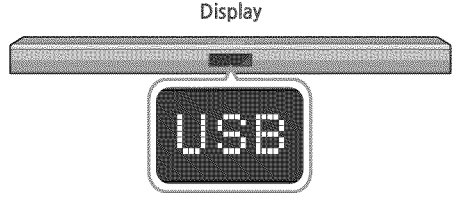
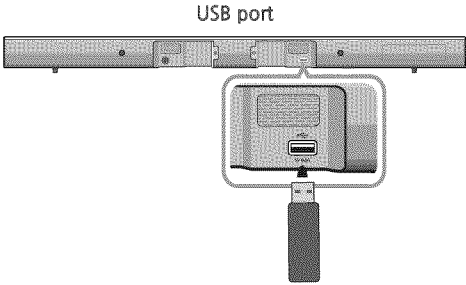
You can play music files located on USB storage devices through the Soundbar.



1. Connect the USB device to the USB port on the back of the product.
2. Press the (  ) button on the main unit's top panel or the  (SOURCE) button on the remote control to select the **USB** mode.
3. **USB** appears on the display screen.
  - The Soundbar connection to the USB device is complete.
  - The Soundbar automatically turns off (Auto Power Off) if no USB device has been connected for more than 25 minutes.

- Do not connect multiple storage devices to the product via a multi-card reader. It may not operate properly.
- Digital camera PTP protocols are not supported.
- Do not remove the USB device while it is transferring files.
- DRM-protected music files (MP3, WMA) from commercial web sites cannot be played.
- External HDDs are not supported.
- Mobile phone devices are not supported.
- File Format Type Compatibility list:

## ► Before you connect a USB device

Be aware of the following:

- If the file name of a file or folder on a USB device exceeds 10 characters, it is not displayed on the Soundbar's display.
- This product may not be compatible with certain types of USB storage media.
- The Soundbar supports the FAT16 and FAT32 file systems.
  - The NTFS file system is not supported.
- Connect USB devices directly to the USB port of the product. Otherwise, you may encounter a USB compatibility problem.

Format	Codec	Sampling Rate	Bitrate
*.mp3	MPEG 1 Layer2	16KHz ~ 48KHz	80kbps~320kbps
	MPEG 1 Layer3		
	MPEG 2 Layer3		
	MPEG 2.5 Layer3		
*.wma	Wave_Format_MSAudio1	16KHz ~ 48KHz	56kbps~128kbps
	Wave_Format_MSAudio2		
*.aac	AAC	16KHz ~ 96KHz	48kbps~320kbps
	AAC-LC		128kbps~192kbps
	HE-AAC	24KHz ~ 96KHz	48kbps~64kbps
*.wav	-	16KHz ~ 48KHz	up to 3000kbps
*.ogg	OGG 1.1.0	48KHz	50kbps~500kbps
*.flac	FLAC 1.1.0,	16KHz ~ 96KHz	up to 3000kbps
	FLAC 1.2.1		

## SOFTWARE UPDATE

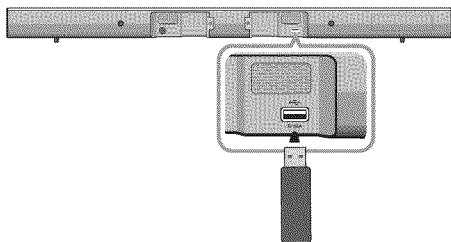

Samsung may offer updates for the Soundbar's system firmware in the future.

If an update is offered, you can update the firmware by connecting a USB device with the firmware update stored on it to the USB port on your Soundbar.

Note that if there are multiple update files, you must load them onto the USB device singly and use them to update the firmware one file at a time.

Please visit [samsung.com](http://samsung.com) or contact the Samsung call center to receive more information about downloading updates files.



- The HW-J470 has a DUAL BOOT function. If the firmware fails to update, you can update the firmware again



- Insert a USB device containing the firmware update into the USB port on the main unit.
- Updating firmware may not work properly if audio files supported by the Soundbar are stored in the USB storage device.
- Do not disconnect the power or remove the USB device while updates are being applied. The main unit will turn off automatically after completing the firmware update.
- After the update, all settings are reset to their factory default settings. We recommend you write down your settings so that you can easily reset them after the update.

Note that updating firmware resets subwoofer connection too. If connection to the subwoofer is not established automatically after resetting, refer to page 14.



If the firmware fails to update, we recommend formatting the USB device in FAT16 and trying again.

- Once the software update is complete, turn off the product and then press and hold the (▶||) button on the remote control for more than 5 seconds. "INIT" appears on the display and the unit is powered off. The upgrade is complete.
- Do not format the USB device in the NTFS format. The Soundbar does not support the NTFS file system.
- Depending on the manufacturer, some USB devices may not be supported.



# TROUBLESHOOTING

Refer to the table below when this product does not function properly. If the problem you are experiencing is not listed below or if the instructions below do not help, turn off the product, disconnect the power cord, and contact Samsung Electronics at 1-800-SAMSUNG (1-800-726-7864).

<b>The unit will not turn on.</b>	
• Is the power cord plugged into the outlet?	→ Connect the power plug to the outlet.
<b>A function does not work when the button is pressed.</b>	
• Is there static electricity in the air?	→ Disconnect the power plug and connect it again.
<b>Sound is not produced.</b>	
• Is the Mute function on?	→ Press the  (Mute) button to cancel the Mute function. → Adjust the Volume.
• Is the volume set to minimum?	
<b>The remote control does not work.</b>	
• Are the batteries drained?	→ Replace with new batteries.
• Is the distance between the remote control and main unit too far?	→ Move closer to the unit.
<b>The TV SoundConnect (TV pairing) failed.</b>	
• Does your TV support TV SoundConnect?	→ TV SoundConnect is supported by some Samsung TVs released from 2012 on. Check your TV to see if it supports TV SoundConnect.
• Is your TV firmware the latest version?	→ Update your TV with the latest firmware.
• Does an error occur when connecting?	→ Contact the Samsung Call Center.
• Reset the TV mode and connect again.	→ Press and hold the  button for 5 seconds to reset the TV SoundConnect connection.
<b>The red LED on the subwoofer blinks and the subwoofer is not producing sound.</b>	
• Your subwoofer may not be connected to the main body of the product.	→ Try to connect your subwoofer again. (See Page 14)
<b>The subwoofer drones and vibrates noticeably.</b>	
• Try to adjust the vibration of your subwoofer.	→ Press the <b>WOOFER</b> button on your remote control to adjust the subwoofer's volume level (between SW-12 and SW+6. See page 10.)

# SPECIFICATIONS

Model name		HW-J470 / HW-JM47	
GENERAL	USB		5V / 0.5A
	Weight	Main Unit	3.56 lbs
		Subwoofer (PS-WJ470)	10.12 lbs
		Surround Speaker	0.68 lbs
		Rear (Surround) AMP (SWA-7000S)	1.63 lbs
	Dimensions (W x H x D)	Main Unit	37.7 x 2.3 x 2.6 inches
		Subwoofer (PS-WJ470)	7.1 x 14.2 x 11.8 inches
		Surround Speaker	3.7 x 4.6 x 2.9 inches
		Rear (Surround) AMP (SWA-7000S)	2.0 x 7.9 x 5.2 inches
Operating Temperature Range		+41°F to +95°F	
Operating Humidity Range		10 % to 75 %	
AMPLIFIER	Rated Output Power	Main Unit	80W/CH x 2, 3ohm, THD=10%, 1KHz
		Subwoofer (PS-WJ470)	140W, 3ohm, THD=10%, 100Hz
		Rear (SWA-7000S)	80W/CH x 2, 3ohm, THD=10%, 1KHz
	S/N Ratio (Analog Input)		65 dB
	Separation (1kHz)		65 dB

- \* S/N ratio, distortion, separation, and usable sensitivity are based on measurements using AES (Audio Engineering Society) guidelines.
- \* Nominal specification
  - Samsung Electronics Co., Ltd reserves the right to change the specifications without notice.
  - Weight and dimensions are approximate.
  - For more information about the power supply and power consumption, refer to the label attached to the product.
  - Dispose unwanted electronics through an approved recycler.  
To find the nearest recycling location, go to our website: [www.samsung.com/recyclingdirect](http://www.samsung.com/recyclingdirect) or call, (877) 278 - 0799
- ※ **Open Source License Notice**
  - To send inquiries and requests regarding open sources, contact Samsung via Email ([oss.request@samsung.com](mailto:oss.request@samsung.com)).
- ※ **Important Note About Service**
  - An administration fee may be charged if either:
    - a. An engineer is called out to your home at your request and there is no defect in the product.
    - b. You bring the unit to a repair center and there is no defect in the product.
  - You will be advised of the amount of the administration fee before any work is done or a home visit is made.
  - If you have a problem with this product, we strongly recommend you read the appropriate section of this manual, review the Troubleshooting section on page 25, visit the Support page for your product at [www.samsung.com](http://www.samsung.com), or call Samsung Product Support (1-800-726-7864) to find an answer before you contact a service center for a repair.

# WARRANTY

## LIMITED WARRANTY TO ORIGINAL PURCHASER

This SAMSUNG brand product, as supplied and distributed by Samsung Electronics America, Inc. (SAMSUNG) and delivered new, in the original carton to the original consumer purchaser, is warranted by SAMSUNG against manufacturing defects in materials and workmanship for a limited warranty period of:

**One (1) Year Parts and Labor\***  
**(\*90 Days Parts and Labor for Commercial Use)**

This limited warranty begins on the original date of purchase, and is valid only on products purchased and used in the United States. To receive warranty service, the purchaser must contact SAMSUNG for problem determination and service procedures. Warranty service can only be performed by a SAMSUNG authorized service center. The original dated bill of sale must be presented upon request as proof of purchase to SAMSUNG or SAMSUNG's authorized service center. Transportation of the product to and from the service center is the responsibility of the purchaser.

SAMSUNG will repair or replace this product, at our option and at no charge as stipulated herein, with new or reconditioned parts or products if found to be defective during the limited warranty period specified above. All replaced parts and products become the property of SAMSUNG and must be returned to SAMSUNG. Replacement parts and products assume the remaining original warranty, or ninety (90) days, whichever is longer.

SAMSUNG's obligations with respect to software products distributed by SAMSUNG under the SAMSUNG brand name are set forth in the applicable end user license agreement. Non-SAMSUNG hardware and software products, if provided, are on an "AS IS" basis. Non-SAMSUNG manufacturers, suppliers, publishers, and service providers may provide their own warranties.

This limited warranty covers manufacturing defects in materials and workmanship encountered in normal, and except to the extent otherwise expressly provided for in this statement, noncommercial use of this product, and shall not apply to the following, including, but not limited to: damage which occurs in shipment; delivery and installation; applications and uses for which this product was not intended; altered product or serial numbers; cosmetic damage or exterior finish; accidents, abuse, neglect, fire, water, lightning or other acts of nature; use of products, equipment, systems, utilities, services, parts, supplies, accessories, applications, installations, repairs, external wiring or connectors not supplied and authorized by SAMSUNG, or which damage this product or result in service problems; incorrect electrical line voltage, fluctuations and surges; customer adjustments and failure to follow operating instructions, cleaning, maintenance and environmental instructions that are covered and prescribed in the instruction book; product removal or reinstallation; reception problems and distortion related to noise, echo, interference or other signal transmission and delivery problems. SAMSUNG does not warrant uninterrupted or error-free operation of the product.

THERE ARE NO EXPRESS WARRANTIES OTHER THAN THOSE LISTED AND DESCRIBED ABOVE, AND NO WARRANTIES WHETHER EXPRESS OR IMPLIED, INCLUDING, BUT NOT LIMITED TO, ANY IMPLIED WARRANTIES OF MERCHANTABILITY OR FITNESS FOR A PARTICULAR PURPOSE, SHALL APPLY AFTER THE EXPRESS WARRANTY PERIODS STATED ABOVE, AND NO OTHER EXPRESS WARRANTY OR GUARANTY GIVEN BY ANY PERSON, FIRM OR CORPORATION WITH RESPECT TO THIS PRODUCT SHALL BE BINDING ON SAMSUNG. SAMSUNG SHALL NOT BE LIABLE FOR LOSS OF REVENUE OR PROFITS, FAILURE TO REALIZE SAVINGS OR OTHER BENEFITS, OR ANY OTHER SPECIAL, INCIDENTAL OR CONSEQUENTIAL DAMAGES CAUSED BY THE USE, MISUSE OR INABILITY TO USE THIS PRODUCT, REGARDLESS OF THE LEGAL THEORY ON WHICH THE CLAIM IS BASED, AND EVEN IF SAMSUNG HAS BEEN ADVISED OF THE POSSIBILITY OF SUCH DAMAGES. NOR SHALL RECOVERY OF ANY KIND AGAINST SAMSUNG BE GREATER IN AMOUNT THAN THE PURCHASE PRICE OF THE PRODUCT SOLD BY SAMSUNG AND CAUSING THE ALLEGED DAMAGE. WITHOUT LIMITING THE FOREGOING, PURCHASER ASSUMES ALL RISK AND LIABILITY FOR LOSS, DAMAGE OR INJURY TO PURCHASER AND PURCHASER'S PROPERTY AND TO OTHERS AND THEIR PROPERTY ARISING OUT OF THE USE, MISUSE OR INABILITY TO USE THIS PRODUCT SOLD BY SAMSUNG NOT CAUSED DIRECTLY BY THE NEGLIGENCE OF SAMSUNG. THIS LIMITED WARRANTY SHALL NOT EXTEND TO ANYONE OTHER THAN THE ORIGINAL PURCHASER OF THIS PRODUCT, IS NONTRANSFERABLE AND STATES YOUR EXCLUSIVE REMEDY.

The benefits of this Limited Warranty extend only to the original purchaser of Samsung products from an authorized Samsung reseller. THIS LIMITED WARRANTY SHALL NOT APPLY TO ANY SAMSUNG PRODUCTS PURCHASED FROM UNAUTHORIZED RESELLERS OR RETAILERS, EXCEPT IN STATES WHERE SUCH RESTRICTION MAY BE PROHIBITED. For a list of Samsung authorized retailers, please go to: [http://www.samsung.com/us/peaceofmind/authorized\\_resellers.html](http://www.samsung.com/us/peaceofmind/authorized_resellers.html)

Some states do not allow limitations on how long an implied warranty lasts, or the exclusion or limitation of incidental or consequential damages, so the above limitations or exclusions may not apply to you. This warranty gives you specific legal rights, and you may also have other rights which vary from state to state.

To obtain warranty hardware service, please contact SAMSUNG customer care center.



## QUESTIONS OR COMMENTS?

COUNTRY	CALL	OR VISIT US ONLINE AT	WRITE
U.S.A	1-800-SAMSUNG (1-800-726-7864)	<a href="http://www.samsung.com/us/support">www.samsung.com/us/ support</a>	Samsung Electronics America, Inc. 85 Challenger Road Ridgefield Park, NJ 07660

