

# CROSLEY

All about the

# Use & Care

of your Freezer

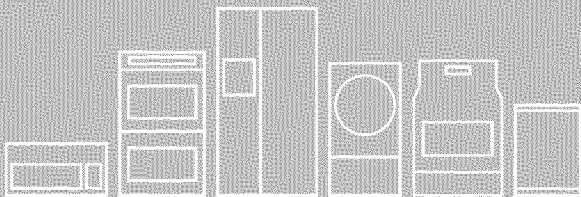

## TABLE OF CONTENTS

Product Registration.....	2	Optional Features.....	7
Energy-Saving Tips.....	2	Care and Cleaning.....	9
Important Safety Instructions.....	2	Power/Freezer Failure.....	11
First Steps.....	4	Before You Call.....	11
Setting the Temperature Control.....	6	Major Appliance Warranty.....	15

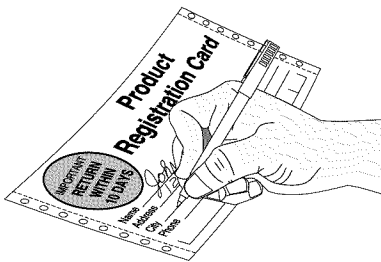

**Read and Save These Instructions**

This Owner's Guide provides specific operating instructions for your model. Use your freezer only as instructed in this guide. These instructions are not meant to cover every possible condition and situation that may occur. Common sense and caution must be practiced when installing, operating, and maintaining any appliance.

**Record Your Model and Serial Numbers**

Record the model and serial numbers in the space provided below.

**Model Number:** \_\_\_\_\_

**Serial Number:** \_\_\_\_\_

**Purchase Date:** \_\_\_\_\_

**Register Your Product**

The self-addressed **PRODUCT REGISTRATION CARD** (shown above) should be filled in completely, signed and returned to Electrolux Home Products.

This Use and Care Guide provides operating instructions for your model. Use your freezer only as instructed in this Use and Care Guide.

- The appliance should be located in the coolest area of the room, away from heat-producing appliances or heating ducts, and out of direct sunlight.

- Let hot foods cool to room temperature before placing in the unit. Overloading the appliance forces the compressor to run longer. Foods that freeze too slowly may lose quality or spoil.
- Be sure to wrap foods properly and wipe containers dry before placing them in the unit. This cuts down on frost build-up inside the unit.
- Shelves and baskets should not be lined with aluminum foil, wax paper, or paper toweling. Liners interfere with cold air circulation, making the appliance less efficient.
- Organize and label food to reduce door openings and extended searches. Remove as many items as needed at one time, and close door as soon as possible.

**IMPORTANT SAFETY INSTRUCTIONS**



**WARNING**

Please read all instructions before using this unit.

**Definitions**

 This is the safety alert symbol. It is used to alert you to potential personal injury hazards. Obey all safety messages that follow this symbol to avoid possible injury or death.



**DANGER**

DANGER indicates an imminently hazardous situation which, if not avoided, will result in death or serious injury.



**WARNING**

WARNING indicates a potentially hazardous situation which, if not avoided, could result in death or serious injury.

# IMPORTANT SAFETY INSTRUCTIONS



## CAUTION

CAUTION indicates a potentially hazardous situation which, if not avoided, may result in minor or moderate injury.



## IMPORTANT

IMPORTANT indicates installation, operation or maintenance information which is important but not hazard-related.



## WARNING

### For your safety

- Do not store or use gasoline or other flammable vapors and liquids in the vicinity of this unit or any other appliance. Read product labels for flammability and other warnings.
- Do not operate the unit in the presence of explosive fumes.
- Remove and discard any spacers used to secure the shelves during shipping. Small objects are a choke hazard to children.
- Remove all staples from the carton. Staples can cause severe cuts, and also destroy finishes if they come in contact with other appliances or furniture.



## WARNING

### Proper Disposal of your Appliance

#### Risk of child entrapment

Child entrapment and suffocation are not problems of the past. Junked or abandoned appliances are still dangerous – even if they will sit for “just a few days”. If you are getting rid of your old unit, please follow the instructions below to help prevent accidents.

We strongly encourage responsible appliance recycling/disposal methods. Check with your utility company or visit [www.recyclemyoldfridge.com](http://www.recyclemyoldfridge.com) for more information on recycling your old appliance.

#### Before you throw away your old appliance:

- Remove door/lid.
- Leave shelves in place so children may not easily climb inside.
- Have the refrigerant removed by a qualified technician.

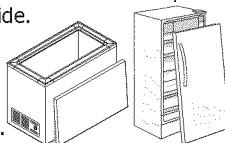

## WARNING

### Child Safety

- Destroy carton, plastic bags, and any exterior wrapping material immediately after the freezer is unpacked. Children should never use these items for play. Cartons covered with rugs, bedspreads, plastic sheets or stretch wrap may become airtight chambers and can quickly cause suffocation.
- An empty, discarded appliance is a very dangerous attraction to children.
- Remove the door(s) of any appliance that is not in use, even if it is being discarded.



## WARNING

Avoid fire hazard or electric shock. Do not use an extension cord or an adapter plug. Do not remove any prong from power cord.

Grounding type wall receptacle

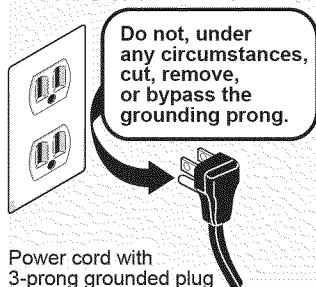

Power cord with 3-prong grounded plug

## WARNING

### Electrical Information

These guidelines must be followed to ensure that safety mechanisms in the design of this appliance will operate properly.

- Refer to the serial plate for correct electrical rating. The power cord of the appliance is equipped with a three-prong grounding plug for your protection against electrical shock hazards. It must be plugged directly into a properly grounded three-prong receptacle, protected with a 15-amp time delay fuse or circuit breaker. The receptacle must be installed in accordance with the local codes and ordinances. Consult a qualified electrician. Receptacles protected by Ground Fault Circuit Interrupters (GFCI) are NOT RECOMMENDED. Do NOT use an extension cord or adapter plug.
- If the power cord is damaged, it should be replaced by an authorized service technician to prevent any risk.
- Never unplug the appliance by pulling on the power cord. Always grip the plug firmly, and pull straight out from the receptacle to prevent damaging the power cord.
- Unplug the appliance before cleaning and before replacing a light bulb to avoid electrical shock.
- If voltage varies by 10% or more, appliance performance may be affected. Operating the unit with insufficient power can damage the motor. Such damage is not covered under the warranty. If you suspect your household voltage is high or low, consult your power company for testing.
- To prevent the appliance from being turned off accidentally, do not plug unit into an outlet controlled by a wall switch or pull cord.
- Do not pinch, knot, or bend power cord in any manner.

## WARNING

### Other Precautions

- To defrost the unit, always unplug unit first.
- Never unplug the appliance by pulling on the power cord. Always grip the plug firmly and pull straight out from the receptacle.
- Turning the control to OFF turns off the compressor, but does not disconnect power to other electrical components.

This Use & Care Guide provides general operating instructions for your model. Use the freezer only as instructed in this Use & Care Guide. **Before starting the freezer, follow these important first steps.**

### Location

Choose a place that is near a grounded electrical outlet.

For the most efficient operation, the unit should be located where surrounding temperatures will not exceed 110°F (43°C). Temperatures of 32°F (0°C) and below will NOT affect appliance operation. Additional compressor heaters are not recommended.

Allow space around the unit for good air circulation. Leave a 3" (75 mm) space on all sides of the unit for adequate circulation.

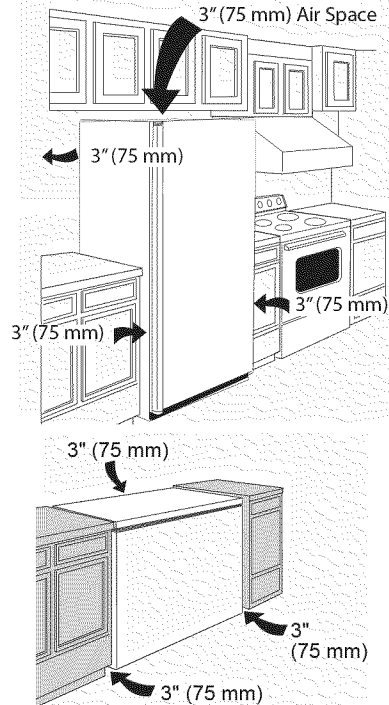

## NOTE

The exterior walls of the appliance may become quite warm as the compressor works to transfer heat from the inside. Temperatures as much as 30°F warmer than room temperature can be expected. For this reason it is particularly important in hotter climates to allow enough space for air circulation around your unit.

## Leveling

The appliance must have all bottom corners resting firmly on a solid floor. The floor must be strong enough to support a fully loaded unit.

### NOTE

It is **VERY IMPORTANT** for your appliance to be level in order to function properly. If the unit is not leveled during installation, the door/lid may be misaligned and not close or seal properly, causing cooling, frost or moisture problems.

### To level Upright Units:

After discarding crating screws, use a carpenter's level to level the appliance from front to back. Adjust the plastic leveling feet in front, ½ bubble higher, so that the door closes easily when left halfway open.

### To level Chest Units:

If needed, add metal or wood shims between feet pads and floor.

## Cleaning (prior to use)

Wash any removable parts of the unit interior and exterior with mild detergent and warm water. Wipe dry. **DO NOT USE HARSH CLEANERS ON THESE SURFACES.**

Do not use razor blades or other sharp instruments which can scratch the appliance surface when removing adhesive labels. Any glue left from the tape can be removed with a mixture of warm water and mild detergent or the residue can be touched with the sticky side of tape already removed. **DO NOT REMOVE THE SERIAL PLATE.**



### CAUTION

To allow door to close and seal properly, **DO NOT** let food packages extend past the front of shelves.

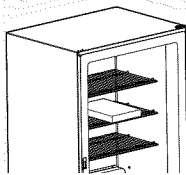

## Repositioning the Mid-Level Basket (some models):

1. To remove the support-hanging basket, press upward on underside of front of support to release from shelf rod.
2. Rotate front under the shelf, and then slide support-hanging basket forward to remove from back shelf rod.
3. To remove shelf grommet, slide away from wall, then pull from rod.

4. Repeat steps 1-3 for other side.
5. With the wire shelf installed, press the 2 shelf grommets down onto the rod that is anchored into the appliance wall (located in the back only). Be sure to keep the larger end of the shelf grommets away from the wall.

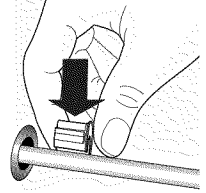

6. Push the shelf grommets onto the shelf rod until firmly seated.
7. Slide the shelf grommets into the wall grommets already in the unit wall until they are flush.

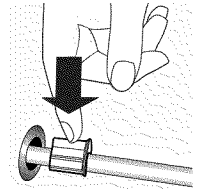

8. Guide the support-hanging basket underneath the shelf, inserting the slotted end of the support onto the rear shelf rod.
9. Rotate the support-hanging basket up to bring the front end over the front shelf rod. Slide forward to locate front of support-hanging basket over front of shelf rod. Push down on support until it snaps into place.

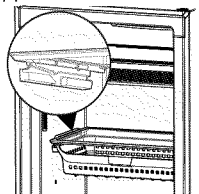
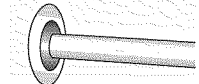

## To install the handle clips to the basket:

1. Place the basket on a firm, flat surface.
2. With the narrow side of the handle clip on the inside of the basket, snap the handle clip to the recessed area in the basket.

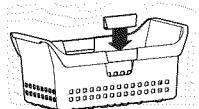
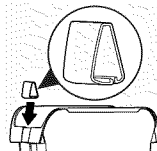

3. Once the inside surface snaps in place, continue the process by rolling the handle clip slightly outward and pressing down firmly to snap onto the outside

## FIRST STEPS

surface. If installed incorrectly, the handle clip will not lay flat.

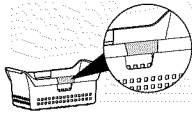

## Door Removal

If door must be removed, unplug the unit.

1. Gently lay the unit on its back, on a rug or blanket.
2. Remove 2 base screws and base panel.
3. Unplug connector, if required, by holding the cabinet connector in place, and pulling door connector out. If equipped, pull Harness Retainer from Cabinet.
4. Remove 4 bottom hinge screws.
5. Remove plastic top hinge cover.
6. Remove 2 screws from top hinge.
7. Remove top hinge from cabinet.
8. Remove door and bottom hinge from cabinet.
9. To replace door, reverse the above order and securely tighten all screws to prevent hinge slippage. Ensure the door harness is routed as shown and that the restraint clip is snapped into the cabinet.

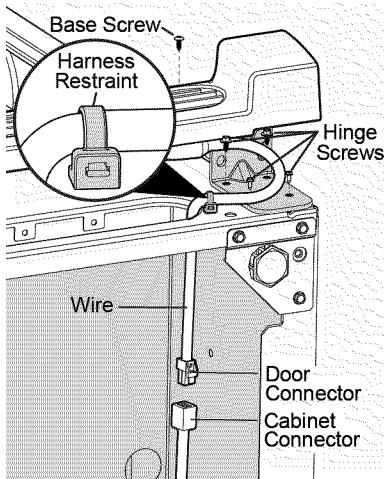

## SETTING THE TEMPERATURE CONTROL

### Cool Down Period

- For safe food storage, allow 4 hours for appliance to cool down completely. The freezer will run continuously for the first several hours. Foods that are already frozen may be placed in freezer after the first few hours of operation. Unfrozen foods should **NOT** be loaded into freezer until freezer has operated for 4 hours.
- When loading freezer, freeze only 3 pounds of fresh food per cubic foot of freezer space at one time. Distribute packages to be frozen evenly throughout the freezer. It is not necessary to turn control knob to a colder setting while freezing food.

### Electromechanical Temperature Control (chest and some upright models)

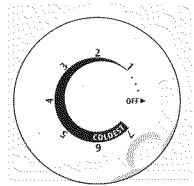

The electromechanical temperature control is located inside the freezer on upright models, and on the left exterior wall on chest models. The temperature is factory preset to provide satisfactory food storage temperatures. However, the temperature control is adjustable to provide a range of temperatures for your personal satisfaction. To adjust the temperature setting, turn the temperature control knob clockwise or counterclockwise. Allow several hours for the temperature to stabilize between adjustments.

### Electronic Temperature Control (some upright frost-free models)

The electronic temperature control is located outside the freezer on upright models. The temperature is factory preset to provide satisfactory food storage temperatures. To adjust the temperature setting, press the plus "+" button for a warmer temperature and the minus "-" button for a colder temperature on the control panel. Allow several hours for the temperature to stabilize between adjustments.

## SETTING THE TEMPERATURE CONTROL

## OPTIONAL FEATURES

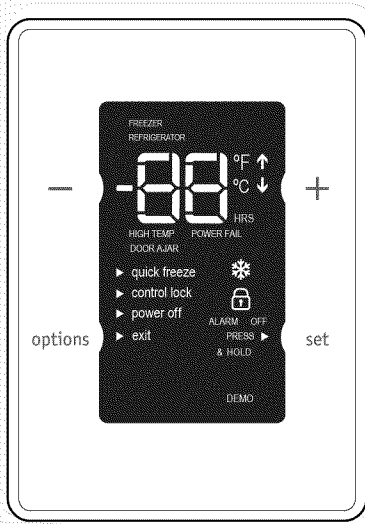

If the alarm sounds, be sure the freezer is properly leveled, and the door/lid closes freely and seals properly. If you suspect a technical malfunction, call an authorized servicer immediately.

### Electronic Temp Alarm

This feature is designed to provide a warning if the inside temperatures reach an unsafe level. The Temp Alarm feature operates on household electricity. It will not function if the household electricity is interrupted. To silence the alarm, press the set button next to the "alarm off" indicator on the display or any key on the control panel.

### Security Lock with Pop-out Key

This feature fastens the door snugly, ensuring stored food is secure. To lock or unlock the freezer, push the key into the lock and turn. The key pops out of the lock after it has been turned.

### Slide-Out Basket (some upright models)

The Slide-Out Basket, located at the bottom of the freezer, provides separate storage space for items that are difficult to store on freezer shelves. To remove the basket, pull out and lift up.

### Interior Light

The light comes on automatically when the door is opened. To replace the light bulb, turn the temperature control to OFF and unplug the electrical cord. Replace the old bulb with a bulb of the same wattage.

### Quick Freeze

Quick freeze can be enabled by entering into the options menu on the control panel and by pressing the "set" button once the indicator is highlighted next to "quick freeze". The unit will be in quick freeze mode for 72 hours and will show a snowflake indicator on the control panel to indicate that it is in quick freeze mode. To exit quick freeze mode, enter into the options menu on the control panel and press the "set" button once the indicator is highlighted next to "quick freeze", after which the snowflake indicator will be removed from the control panel. Or quick freeze will end automatically after 72 hours.

### Control Lock

Control lock can be enabled by entering into the options menu on the control panel and by pressing the "set" button once the indicator is highlighted next to "control lock". A control lock

## OPTIONAL FEATURES

### NOTE

Your freezer may have some, or all of the features listed below. Become familiar with these features, and their use and care.

### Electromechanical Temp Alarm (audible only or audible with warning light)

This feature is designed to provide a warning of a possible malfunction. If the temperature of the food rises to a level unsafe for longterm storage, the buzzer will sound. The red light, if equipped, will also glow. The Temp Alarm feature operates on household electricity. If the power fails, the alarm will not function. An ON/OFF switch allows you to deactivate the Temp Alarm when not wanted. The freezer is shipped with the Temp Alarm in the OFF position (if equipped). After freezer has run approximately 4 hours, the red light, if equipped, will go off. Then you may activate the Temp Alarm without the alarm sounding.

Press the ON switch to activate the Temp Alarm feature. To deactivate, press the OFF switch.

## OPTIONAL FEATURES

icon will be displayed on the control panel to indicate that the control panel has been locked. To unlock, press and hold the set button for 3 seconds, after which the lock indicator will be removed from the control panel and the control panel has been unlocked.

### Temperature Conversion

Press and hold both temperature buttons to toggle between °F and °C.

### Power Off

To shut cooling off to the unit and to turn off the interior lights of the unit, enter into the options menu on the control panel and press and hold the "set" button for 3 seconds once the indicator is highlighted next to "power off". "Power off" will be displayed on the control panel to indicate that the unit is in the powered off mode. To turn power back on to the unit, press and hold the "set" key for 3 seconds. Then the power off indicator will be removed from the control panel, the unit will resume cooling, and the set point of the unit will be displayed on the control panel.

### Power Fail

If your unit has lost power, the control panel will display "power fail" and the number of hours that your unit has been without power up to a maximum of 48 hrs. The alarm will sound until the condition is acknowledged by pressing the set button or any other button on the control panel.

### Door Ajar

If your door has been left open for more than 5 minutes, the control panel will display "door ajar" and will sound an alarm until the door has been closed or any button is pressed on the control panel. If a button on the control panel has been pressed but the door has not been closed, "door ajar" will continue to be displayed on the control panel until the door has been closed.

### Sabbath Mode

The Sabbath mode is a feature that disables portions of the appliance and its controls in accordance with observance of the weekly Sabbath and religious holidays within the Orthodox Jewish community.

To turn Sabbath mode on, press and hold the "Options" button and "+" button for 5 seconds, after which "Sb" will be displayed on the control panel indicating that the unit is in Sabbath mode. To exit Sabbath mode, press and hold the "Options" button and "+" button for 5 seconds, after which the display will return to displaying the set point of the unit.

In the Sabbath mode, the High Temp alarm

is active for health reasons. If a high temperature alarm is activated during this time, for example due to a door left ajar, the alarm will sound for about 10 minutes. The alarm will then silence on its own and a "high temp" icon will be displayed on the control panel. The high temp icon will continue to display even if the door is closed until Sabbath mode is exited and the icon reset.



For further assistance, guidelines of proper usage and a complete list of models with the Sabbath feature, please visit the web at <http://www.star-k.org>.

### NOTE

While in Sabbath mode, neither the lights nor the control panel will work until Sabbath mode has been deactivated.

The freezer stays in Sabbath mode after a power failure recovery. It must be deactivated with the buttons on the control panel.

### Adjustable Shelf (some upright models)

This shelf can be moved to one or two positions. Move to the right and lift left to move to the desired location.

### Slide-Aside Basket (some chest models)

This basket helps organize odd-shaped items. To reach other packages in the freezer, slide the basket aside or lift out.

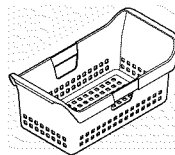

### Fast Freezing Shelves (manual defrost upright models)

These shelves contain cooling coils to freeze foods quickly and allow cold air to constantly circulate throughout the freezer. Do not use sharp metal objects such as ice picks or scrapers to clean the shelves. This could damage the shelves and reduce their cooling ability. These shelves are not adjustable.

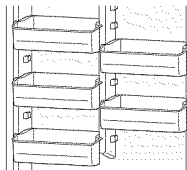

### Adjustable Door Bins (some upright models)

Adjustable door bins are located inside on the freezer door and provide flexible storage space.

The number of bins provided varies by model.



## Mid-Level Basket

This basket keeps things organized and slides out for easy access.

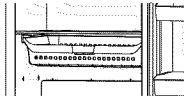

## Chest Divider (some chest models)

Use these clever dividers to custom-arrange a variety of different-sized storage bins in the bottom of your chest freezer. Use the peel-n-stick labels found in your literature packet to help remind you which items are stored where. If you have an item that isn't already covered by one of the pre-printed labels then use one of the blank labels and a permanent marking pen to make your own custom label. Labels can be peeled off when no longer needed and replaced by new and different ones.

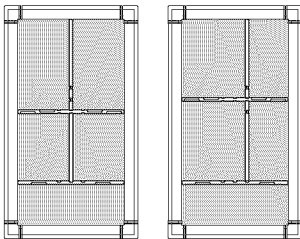

Examples of Chest Divider Configurations



## CAUTION

Damp objects stick to cold metal surfaces. Do not touch interior metal surfaces with wet or damp hands.

Some upright freezers are frost-free and defrost automatically, but should be cleaned occasionally.

## Between Defrosting

To avoid frequent defrosting, occasionally use a plastic scraper to remove frost. Scrape with a pulling motion. Never use a metal instrument to remove frost.



## CAUTION

Freezer must be unplugged (to avoid electrical hazard) from power source when defrosting unit.

## Defrosting

It is important to defrost and clean freezer when  $\frac{1}{4}$  to  $\frac{1}{2}$  inch of frost has accumulated. Frost may tend to accumulate faster on upper part of the freezer due to warm, moist air entering the freezer when the door is opened. Remove food and leave the door open when defrosting the freezer.

- On upright models with a defrost drain** (Figure 1), remove drain plug on the inside floor of the freezer by pulling straight out. To access external drain tube on models with a base panel, first remove the two screws from the base panel. Locate the drain tube near the left center under the freezer. Place a shallow pan under the drain tube. Defrost water will drain out. Check pan occasionally so water does not overflow. Replace the drain plug when defrosting and cleaning are completed. If the drain is left open, warm air may enter the freezer.

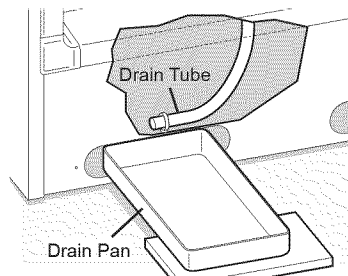

Figure 1

## CARE AND CLEANING

- **On chest models with a defrost drain,** place a shallow pan beneath the drain outlet (Figure 2). A 1/2" garden hose adaptor can be used to drain the freezer directly into a floor drain (Figure 3). If your model is not equipped with an adaptor, one can be purchased at most hardware stores. Pull out the drain plug inside the freezer, and pull off the outside defrost drain plug (Figure 4). Defrost water will drain out. Check pan occasionally so water does not overflow.

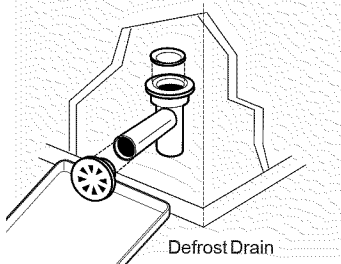

Figure 2

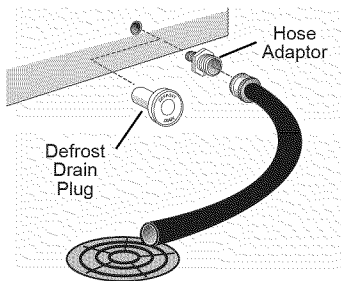

Figure 3

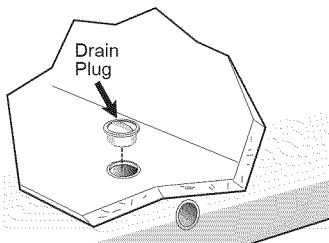

Figure 4

Replace the drain plugs when defrosting is completed.

- **On models without a defrost drain,** place towels or newspapers on the freezer bottom to catch the frost. The frost will loosen and fall. Remove towels and/or newspapers.

- If the frost is soft, remove it by using a plastic scraper. If the frost is glazed and hard, fill deep pans with hot water and place them on the freezer bottom. Close the freezer door. Frost should soften in about 15 minutes. Repeat this procedure if necessary.

### Cleaning the Inside

After defrosting, wash inside surfaces of the unit with a solution of 2 tbsp. (25 g) of baking soda in 1 qt. (1 l) warm water. Rinse and dry. Wring excess water out of the sponge or cloth when cleaning in the area of the controls, or any electrical parts.

Wash the removable parts with the baking soda solution mentioned above, or mild detergent and warm water. Rinse and dry. **Never** use metallic scouring pads, brushes, abrasive cleaners, or alkaline solutions on any surface. Do not wash removable parts in a dishwasher.

### Cleaning the Outside

Wash the cabinet with warm water and mild liquid detergent. Rinse well and wipe dry with a clean soft cloth.

Do not use razor blades or other sharp instruments, which can scratch the freezer surface when removing adhesive labels. Any glue left from the tape can be removed with a mixture of warm water and mild detergent, or touch the residue with the sticky side of the tape already removed. **DO NOT REMOVE THE SERIAL PLATE.**

### ! WARNING

If leaving the door open while on vacation, make certain that children cannot get into the unit and become entrapped.

### ! WARNING

Do not open the door unnecessarily if appliance is off for several hours.

### Vacation and Moving Tips

**Short Vacations:** Leave the unit operating during vacations of less than 3 weeks.

**Long Vacations:** If the appliance will not be used for several months, remove all food and unplug the power cord. Clean and dry the interior thoroughly. Leave the door open slightly, blocking it open if necessary, to prevent odor and mold growth.

**Moving:** Disconnect the power cord plug from the wall outlet. Remove food, defrost, and then clean the unit. Secure all loose items such as base panel, baskets, and shelves by taping them securely in place to prevent damage. In the moving vehicle, secure the appliance in an upright position, and secure to prevent movement. Also protect outside of the unit with a blanket, or similar item.

## POWER/FREEZER FAILURE

**If a power failure occurs,** frozen foods will stay frozen for at least 24 hours if the freezer is kept closed. If the power failure continues, pack seven or eight pounds of dry ice into the freezer every 24 hours. Look in the Yellow Pages under "Dry Ice," "Dairies," or "Ice Cream Manufacturers" for local dry ice suppliers.

Always wear gloves and use caution when handling dry ice.

**If the freezer has stopped operating,**

see "Freezer does not run" in the Before you Call section of this manual. If you cannot solve the problem, call an authorized servicer immediately.

**If the freezer remains off for several hours,** follow the directions above for the use of dry ice during a power failure. If necessary, take the food to a local locker plant until the freezer is ready to operate. Look in the Yellow Pages under "Frozen Food Locker Plants."

## BEFORE YOU CALL

Before calling for service, review this list. It may save you time and expense. This list includes common occurrences that are not the result of defective workmanship or materials in this appliance.

PROBLEM	CAUSE	CORRECTION
<b>APPLIANCE OPERATION</b>		
<b>Appliance does not run.</b>	<ul style="list-style-type: none"><li>• Appliance is plugged into a circuit that has a ground fault interrupt.</li><li>• Temperature Control is in the OFF position or POWER OFF position.</li><li>• Appliance may not be plugged in or plug is loose.</li><li>• House fuse blown or tripped circuit breaker.</li><li>• Power outage</li></ul>	<ul style="list-style-type: none"><li>• Use another circuit. If you are unsure about the outlet, have it checked by a certified technician.</li><li>• See <b>Setting the Temperature Control</b> section.</li><li>• Ensure plug is tightly pushed into outlet.</li><li>• Check/replace fuse with a 15-amp time-delay fuse. Reset circuit breaker.</li><li>• Check house lights. Call local electric company.</li></ul>

## BEFORE YOU CALL

PROBLEM	CAUSE	CORRECTION
<b>Appliance runs too much or too long.</b>	<ul style="list-style-type: none"> <li>Room or outside weather is hot.</li> <li>Appliance has recently been disconnected for a period of time.</li> <li>Large amounts of warm or hot food have been stored recently.</li> <li>Door/lid is opened too frequently or too long.</li> <li>Door/lid may be slightly open.</li> <li>Temperature control is set too low.</li> <li>Gasket is dirty, worn, cracked, or poorly fitted.</li> </ul>	<ul style="list-style-type: none"> <li>It's normal for the appliance to work longer under these conditions.</li> <li>It takes 4 hours for the appliance to cool down completely.</li> <li>Warm food will cause the appliance to run more until the desired temperature is reached.</li> <li>Warm air entering the appliance causes it to run more. Open door/lid less often.</li> <li>See DOOR PROBLEMS.</li> <li>Turn control knob to a warmer setting. Allow several hours for the temperature to stabilize.</li> <li>Clean or change gasket. Leaks in door/lid seal will cause the appliance to run longer in order to maintain desired temperatures.</li> </ul>
<b>FREEZER TEMPERATURES</b>		
<b>Interior temperature is too cold.</b>	<ul style="list-style-type: none"> <li>Temperature control is set too low.</li> <li>The freezer is in quick freeze mode.</li> </ul>	<ul style="list-style-type: none"> <li>Turn the control to a warmer setting. Allow several hours for temperature to stabilize.</li> <li>Exit quick freeze mode by entering into the options menu on the control panel and pressing the "set" button once the indicator is highlighted next to "quick freeze".</li> </ul>
<b>Interior temperature is too warm.</b>	<ul style="list-style-type: none"> <li>Temperature control is set too warm.</li> <li>Door/lid is opened too frequently or too long.</li> <li>Door/lid may not be seating properly.</li> <li>Large amounts of warm or hot food has been stored recently.</li> <li>The appliance has recently been disconnected for a period of time.</li> </ul>	<ul style="list-style-type: none"> <li>Turn the control to a colder setting. Allow several hours for temperature to stabilize.</li> <li>Warm air entering the appliance causes it to run more. Open door/lid less often.</li> <li>See DOOR/LID PROBLEMS.</li> <li>Warm food will cause the appliance to run more until the desired temperature is reached.</li> <li>The appliance requires 4 hours to cool down completely.</li> </ul>
<b>External temperature is too warm.</b>	<ul style="list-style-type: none"> <li>The external walls can be as much as 30°F warmer than room temperature.</li> </ul>	<ul style="list-style-type: none"> <li>This is normal while the compressor works to transfer heat from inside the cabinet.</li> </ul>
<b>SOUND AND NOISE</b>		
<b>Louder sound levels when appliance is on.</b>	<ul style="list-style-type: none"> <li>Modern freezers have increased storage capacity and more stable temperatures. They require a high efficiency compressor.</li> </ul>	<ul style="list-style-type: none"> <li>This is normal. When the surrounding noise is low, you might hear the compressor running while it cools the interior.</li> </ul>
<b>Longer sound levels when compressor comes on.</b>	<ul style="list-style-type: none"> <li>The appliance operates at higher pressures during the start of the ON cycle.</li> </ul>	<ul style="list-style-type: none"> <li>This is normal. Sound will level off or disappear as the appliance continues to run.</li> </ul>
<b>Popping or cracking sound when compressor comes on.</b>	<ul style="list-style-type: none"> <li>Metal parts undergo expansion and contraction, as in hot water pipes.</li> </ul>	<ul style="list-style-type: none"> <li>This is normal. Sound will level off or disappear as the appliance continues to run.</li> </ul>
<b>Bubbling or gurgling sound, like water boiling.</b>	<ul style="list-style-type: none"> <li>Refrigerant (used to cool appliance) is circulating throughout the system.</li> </ul>	<ul style="list-style-type: none"> <li>This is normal.</li> </ul>

## BEFORE YOU CALL

PROBLEM	CAUSE	CORRECTION
<b>Vibrating or rattling noise.</b>	<ul style="list-style-type: none"> <li>The appliance is not level. It rocks on the floor when it is moved slightly.</li> <li>Floor is uneven or weak. The appliance rocks on floor when it is moved slightly.</li> <li>The appliance is touching the wall.</li> </ul>	<ul style="list-style-type: none"> <li>Level the unit. Refer to "Leveling" in the <b>FIRST STEPS</b> section.</li> <li>Ensure floor can adequately support the appliance. Level the appliance by putting wood or metal shims under part of the appliance.</li> <li>Re-level the appliance or move the appliance slightly. Refer to "Leveling" in the <b>FIRST STEPS</b> section.</li> </ul>
<b>The alarm is sounding from the control panel</b>	<ul style="list-style-type: none"> <li>Look on the control panel to determine which indicator light is on (High Temp, Power Fail, or Door Ajar)</li> </ul>	<ul style="list-style-type: none"> <li>Press the "set" button to acknowledge the alarm or close the door if the door ajar indicator is shown.</li> </ul>
<b>Pressing the "-" or "+" buttons on the control panel does not change the set points.</b>	<ul style="list-style-type: none"> <li>Verify the control panel is not locked or in Sabbath Mode.</li> </ul>	<ul style="list-style-type: none"> <li>To unlock, press and hold the "set" button for 3 seconds; to exit Sabbath Mode, press and hold "set" and "Options" for 5 seconds.</li> </ul>
<b>WATER/MOISTURE/FROST INSIDE APPLIANCE</b>		
<b>Moisture forms on inside appliance walls.</b>	<ul style="list-style-type: none"> <li>Weather is hot and humid.</li> <li>Door/lid may not be seating properly.</li> <li>Door/lid is opened too often or too long.</li> </ul>	<ul style="list-style-type: none"> <li>The rate of frost buildup and internal sweating increases. This is normal.</li> <li>See "DOOR/LID PROBLEMS".</li> <li>Open door/lid less often.</li> </ul>
<b>WATER/MOISTURE/FROST OUTSIDE APPLIANCE</b>		
<b>Moisture forms on outside of appliance.</b>	<ul style="list-style-type: none"> <li>Door may not be seating properly, causing cold air from inside freezer to meet warm air from outside.</li> </ul>	<ul style="list-style-type: none"> <li>See "DOOR/LID PROBLEMS".</li> </ul>
<b>ODOR IN APPLIANCE</b>		
<b>Odor in appliance.</b>	<ul style="list-style-type: none"> <li>Interior needs to be cleaned.</li> <li>Foods with strong odors are in the appliance.</li> </ul>	<ul style="list-style-type: none"> <li>Clean interior with sponge, warm water, and baking soda.</li> <li>Cover the food tightly.</li> </ul>
<b>DOOR/LID PROBLEMS</b>		
<b>Door will not close.</b>	<ul style="list-style-type: none"> <li>Appliance is not level. It rocks on the floor when it is moved slightly.</li> <li>Floor is uneven or weak. Appliance rocks on floor when it is moved slightly.</li> </ul>	<ul style="list-style-type: none"> <li>This condition can force the cabinet out of square and misalign the door. Refer to "Leveling" in the <b>FIRST STEPS</b> section.</li> <li>Level the floor by using wood or metal shims under the appliance or brace floor supporting the appliance.</li> </ul>
<b>LIGHT BULB IS NOT ON</b>		
<b>Power Available Light is not on</b>	<ul style="list-style-type: none"> <li>Light bulb is burned out.</li> <li>No electric current is reaching the freezer.</li> <li>The interior lights will be shut off if the door/lid has been left open for an extended period of time.</li> </ul>	<ul style="list-style-type: none"> <li>Follow directions under "Interior Light" in the <b>OPTIONAL FEATURES</b> section.</li> <li>See "Appliance does not run" in APPLIANCE OPERATION.</li> <li>Close the door/lid.</li> </ul>

# MAJOR APPLIANCE WARRANTY

Your appliance is covered by a one year limited warranty. For one year from your original date of purchase, Crosley will pay all costs for repairing or replacing any parts of this appliance that prove to be defective in materials or workmanship when such appliance is installed, used and maintained in accordance with the provided instructions.

\*In addition to warranty shown above, ask your dealer about Crosley Extended Limited Warranty that comes to you at no extra charge for the 2nd through 10th years.

## Exclusions

### This warranty does not cover the following:

1. Products with original serial numbers that have been removed, altered or cannot be readily determined.
2. Product that has been transferred from its original owner to another party or removed outside the USA or Canada.
3. Rust on the interior or exterior of the unit.
4. Products purchased "as-is" are not covered by this warranty.
5. Food loss due to any refrigerator or freezer failures.
6. Products used in a commercial setting.
7. Service calls which do not involve malfunction or defects in materials or workmanship, or for appliances not in ordinary household use or used other than in accordance with the provided instructions.
8. Service calls to correct the installation of your appliance or to instruct you how to use your appliance.
9. Expenses for making the appliance accessible for servicing, such as removal of trim, cupboards, shelves, etc., which are not a part of the appliance when it is shipped from the factory.
10. Service calls to repair or replace appliance light bulbs, air filters, water filters, other consumables, or knobs, handles, or other cosmetic parts.
11. Surcharges including, but not limited to, any after hour, weekend, or holiday service calls, tolls, ferry trip charges, or mileage expense for service calls to remote areas, including the state of Alaska.
12. Damages to the finish of appliance or home incurred during installation, including but not limited to floors, cabinets, walls, etc.
13. Damages caused by: services performed by unauthorized service companies; use of parts other than genuine Crosley parts or parts obtained from persons other than authorized service companies; or external causes such as abuse, misuse, inadequate power supply, accidents, fires, or acts of God.

## DISCLAIMER OF IMPLIED WARRANTIES; LIMITATION OF REMEDIES

CUSTOMER'S SOLE AND EXCLUSIVE REMEDY UNDER THIS LIMITED WARRANTY SHALL BE PRODUCT REPAIR OR REPLACEMENT AS PROVIDED HEREIN. CLAIMS BASED ON IMPLIED WARRANTIES, INCLUDING WARRANTIES OF MERCHANTABILITY OR FITNESS FOR A PARTICULAR PURPOSE, ARE LIMITED TO ONE YEAR OR THE SHORTEST PERIOD ALLOWED BY LAW, BUT NOT LESS THAN ONE YEAR. CROSLLEY SHALL NOT BE LIABLE FOR CONSEQUENTIAL OR INCIDENTAL DAMAGES SUCH AS PROPERTY DAMAGE AND INCIDENTAL EXPENSES RESULTING FROM ANY BREACH OF THIS WRITTEN LIMITED WARRANTY OR ANY IMPLIED WARRANTY. SOME STATES AND PROVINCES DO NOT ALLOW THE EXCLUSION OR LIMITATION OF INCIDENTAL OR CONSEQUENTIAL DAMAGES, OR LIMITATIONS ON THE DURATION OF IMPLIED WARRANTIES, SO THESE LIMITATIONS OR EXCLUSIONS MAY NOT APPLY TO YOU. THIS WRITTEN WARRANTY GIVES YOU SPECIFIC LEGAL RIGHTS. YOU MAY ALSO HAVE OTHER RIGHTS THAT VARY FROM STATE TO STATE.

## If You Need Service

Keep your receipt, delivery slip, or some other appropriate payment record to establish the warranty period should service be required. If service is performed, it is in your best interest to obtain and keep all receipts. Service under this warranty must be obtained by contacting Crosley at the addresses or phone numbers below.

This warranty only applies in the USA and Canada. In the USA, your appliance is warranted by Crosley Corporation. Crosley authorizes no person to change or add to any obligations under this warranty. Obligations for service and parts under this warranty must be performed by Crosley or an authorized service company. Product features or specifications as described or illustrated are subject to change without notice.

**FOR WARRANTY INFORMATION CONTACT:**  
USA 800.944.9044  
Canada 800.265.8352

**FOR PRODUCT INFORMATION CONTACT:**  
336-761-1212  
Crosley Corporation  
111 Cloverleaf Dr. Suite 200  
Winston-Salem, NC 27103  
www.crosley.com

