

# INSTALLATION & OPERATING INSTRUCTIONS for GMP & GMPE POWER VENTED MULTI-POSITION GAS FURNACE

(CATEGORY I)

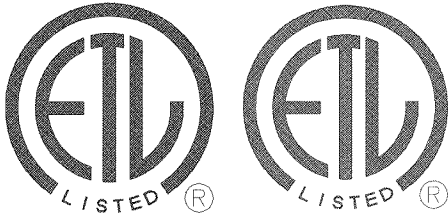

## WARNING

IF THIS FURNACE IS INSTALLED IN AN ENCLOSED AREA, SUCH AS A GARAGE OR UTILITY ROOM, WITH ANY OTHER **CARBON MONOXIDE** PRODUCING DEVICE (i.e., AUTOMOBILE, SPACE HEATER, ETC.) INSURE THAT THE ENCLOSED AREA IS PROPERLY VENTILATED.

## WARNING

**CARBON MONOXIDE** (REFERRED TO AS CO) CAN CAUSE PERSONAL INJURY OR DEATH

## WARNING

THIS FURNACE IS DESIGN CERTIFIED FOR INSTALLATION IN BUILDINGS CONSTRUCTED ON SITE ONLY.

Goodman Manufacturing Company, LP  
2550 North Loop West, Suite 400  
Houston, Texas 77092  
[www.goodmanmfg.com](http://www.goodmanmfg.com)

# REPLACEMENT PARTS

Replacement parts for this appliance is available through your contractor or local distributor. For the location of your nearest distributor consult the white business pages, the yellow page section of the local telephone book or contact;

SERVICE PARTS DEPARTMENT  
GOODMAN MANUFACTURING CO., LP  
1501 SEAMIST  
HOUSTON, TEXAS 77008  
(713) 861 - 2500

The major parts groups are as follows;

## **BLOWER ASSEMBLY**

Motor  
Blower housing  
Blower wheel  
Misc. sheetmetal items  
Capacitor

## **HEAT EXCHANGER**

Heat exchanger sections  
Innerfront  
Secondary coil

## **ELECTRICAL CONTROLS**

Control board  
Auxiliary / main limit switch  
Roll-out switch  
Transformer  
Door interlock switch

Air pressure switch  
Induced draft blower

## **BURNER ASSEMBLY**

Burners  
Manifold  
Orifices  
Gas valve  
Ignitor  
Flame sensor

## **MISCELLANEOUS**

Wrapper  
Access doors  
Chimney  
Gaskets and seals  
Wiring assemblies

To effectively process the parts requirement, the distributor / contractor will need the entire model number and serial number found on the series and rating plate located inside the blower compartment.

## INDEX

WARNINGS & GENERAL INFORMATION .....	4, 5
CLEARANCES, LOCATION .....	5, 6
VENTING.....	6
GAS PIPING TABLE.....	7, 8
CIRCULATING & RETURN AIR .....	8 - 10
ELECTRICAL SUPPLY, CONTROL VOLTAGE .....	10, 11
RATING THE FURNACE.....	11, 12
TIMING THE GAS METER.....	13
SAFETY CONTROLS.....	14, 15
CIRCULATING AIR FILTERS.....	15
SERVICE INSTRUCTIONS .....	16
SEQUENCE OF OPERATION .....	17
REMOVING AN EXISTING APPLIANCE .....	18
INSPECTING AND CLEANING THE HEAT EXCHANGER.....	18, 19
COMBUSTION AIR .....	19, 20
ILLUSTRATIONS .....	21 - 23
BLOWER DELAY, HUMIDIFIER & EAC CONTROL .....	24
WIRING DIAGRAMS.....	25, 26
LIGHTING INSTRUCTIONS.....	27
VENT TABLES .....	28 - 45

**THIS FURNACE CONTAINS ELECTRONIC COMPONENTS, WHICH REQUIRE A DEFINITE GROUND. PROVISIONS ARE MADE FOR CONNECTION OF THE GROUND. IF THIS PRODUCT IS NOT PERMANENTLY AND POSITIVELY GROUNDED NUMEROUS SERVICE CALLS MAY RESULT. A DEDICATED GROUND FROM THE MAIN POWER SUPPLY OR AN EARTH GROUND MUST BE PROVIDED.**

### **WARNING**

WHILE **CARBON MONOXIDE** DETECTORS DO PROVIDE ADDITIONAL PROTECTION, CURRENT LIMITATIONS TO THEIR EFFECTIVENESS REQUIRES THAT YOU OTHERWISE CONTINUE TO FOLLOW APPROPRIATE INSTRUCTIONS LOCATED IN THE "INSTALLATION & OPERATING INSTRUCTIONS" AND "USERS INFORMATION" MANUALS RELATING TO PROTECTING PERSONS FROM THE RISKS OF **CARBON MONOXIDE**. REVIEW EACH CO DETECTOR MANUFACTURERS' EXPLANATION OF THEIR UNIT'S CAPABILITIES AND FOLLOW THOSE INSTALLATION AND OPERATING MANUAL WHEN INSTALLING AND OPERATING THESE UNITS.

### **WARNING**

THE CIRCULATING AIR DUCTS MUST BE COMPLETELY AND POSITIVELY SEALED TO PREVENT COMBUSTION PRODUCTS, INCLUDING **CARBON MONOXIDE**, FROM ENTERING THE AIR STREAM.

### **WARNING**

TO ENSURE PROPER INSTALLATION AND OPERATION OF THIS PRODUCT, COMPLETELY READ AND UNDERSTAND THESE INSTRUCTIONS PRIOR TO ATTEMPTING TO ASSEMBLE, INSTALL, MAINTAIN, OR REPAIR.  
IF THESE INSTRUCTIONS ARE NOT FOLLOWED PRECISELY THERE IS A POTENTIAL OF **CARBON MONOXIDE** POISONING, WHICH CAN RESULT IN SERIOUS ILLNESS OR DEATH.

### **WARNING**

THIS FURNACE WAS EQUIPPED AT THE FACTORY FOR USE WITH NATURAL GAS ONLY. LIQUID PETROLEUM (LP) CONVERSION, IF REQUIRED, MUST BE PERFORMED BY A QUALIFIED TECHNICIAN FAMILIAR WITH PERFORMING THIS TYPE OF CONVERSION. IF LP CONVERSION IS REQUIRED, ALL INSTRUCTIONS INCLUDED WITH THE FACTORY AUTHORIZED KIT MUST BE FOLLOWED. THE ONLY KIT THAT MUST BE USED FOR THIS CONVERSION IS THE FACTORY AUTHORIZED **LPM-01** (GMPH SERIES) OR **LPM-03** (GMPE SERIES). FAILURE TO FOLLOW THOSE INSTRUCTIONS EXPLICITLY MAY CAUSE FIRE, EXPLOSION, PERSONAL INJURY OR PROPERTY DAMAGE.

### **WARNING**

IF PROHIBITED BY LOCAL CODE DO NOT INSTALL A LIQUID PETROLEUM GAS BURNING APPLIANCE IN A PIT, BASEMENT OR SIMILAR LOCATION WHERE LP, A HEAVIER THAN AIR GAS, CAN COLLECT IN LOW AREAS AND MAY NOT DISPERSE NATURALLY. APPLIANCES SO FUELED SHALL NOT BE INSTALLED IN AN ABOVE GRADE UNDER FLOOR SPACE OR BASEMENT UNLESS SUCH LOCATION IS PROVIDED WITH APPROVED MEANS FOR REMOVAL OF UNBURNED GAS.

### **GENERAL INFORMATION**

The GMP and GMPE series of gas furnaces may be installed in the upflow, horizontal or downflow configuration. Unless otherwise noted, the instructions contained within are valid for all of these configurations.

These Installation and Operating Instructions are intended for use by fully qualified installation technicians. Some localities require the installer/servicer to be licensed. If in doubt, check with local authorities.

**INSTALLATION:** In the USA this furnace must be installed according to the latest edition of the ANSI Z223.1 booklet entitled "National Fuel Gas Code" (NFPA 54), and the requirements or codes of the local utility or other authority having jurisdiction. In Canada this furnace must be installed according to the current CAN/CGA-B149.1 & 2 Gas Installation Codes, local plumbing or waste water codes and other applicable codes.

Additional helpful publications available from the NFPA are, NFPA 90A - Installation of Air Conditioning and Ventilating System, and NFPA 90B - Warm Air Heating and Air Conditioning System. These publications are available from:

National Fire Protection Association, Inc.  
 Batterymarch Park  
 Quincy, MA 02269

ANNUAL inspection of the furnace and its vent system is strongly recommended. It is the installer's responsibility to inform the user of this importance.

These series of furnaces meet the California NO<sub>x</sub> emission standards and California seasonal efficiency standards.

<b>LOCATION</b>
-----------------

**DO NOT** install this furnace in a mobile home. This furnace is designed only for installation in buildings constructed on site and connected to ductwork. When installed in a utility room or closet, the door opening must be wide enough to allow the largest part of the furnace to enter, or to permit the replacement of another appliance, such as a water heater.

**DO NOT** install outdoors. This furnace is designed to be installed indoors only. This furnace should be installed in such a manner so that it is protected from water. If any components should become submerged, replace those parts before returning the furnace to operation.

**DO NOT** use as a construction heater.

**DO NOT** install in a room used or designed to be used as a bedroom, bathroom or storage closet, or in any enclosed space with access only through such a room or space.

**MINIMUM CLEARANCES TO COMBUSTIBLE SURFACES**  
 Unobstructed front clearance of 24" **for servicing** is recommended.

VENT		SIDES	FRONT	BACK	TOP (PLENUM)
B1-VENT	SINGLE				
1"	6"	1"	3"	0"	1"

Top clearance for horizontal configuration - 1".

Line contact to framing is permitted when installed in the horizontal configuration. Line contact is defined as the portion of the cabinet that is formed by the intersection of the top and side.

ACCESSIBILITY CLEARANCE, WHERE GREATER, SHOULD TAKE PRECEDENCE OVER MINIMUM FIRE PROTECTION CLEARANCE.

A gas fired furnace for installation in a residential garage must be installed so that the ignition source and burners are located not less than eighteen inches (18") above the floor and is protected or located to prevent physical damage by vehicles.

A gas furnace must not be installed directly on carpeting, tile, or other combustible materials other than wood flooring.

### WARNING

COMBUSTIBLE MATERIAL MUST NOT BE PLACED ON OR AGAINST THE FURNACE JACKET. THE AREA AROUND THE FURNACE MUST BE KEPT CLEAR AND FREE OF ALL COMBUSTIBLE MATERIAL INCLUDING GASOLINE AND OTHER FLAMMABLE VAPORS AND LIQUIDS. THE FURNACE AREA MUST NOT BE USED AS A BROOM CLOSET OR FOR ANY OTHER STORAGE PURPOSE.

### VENTING

See the illustrations and vent tables at the end of this manual for venting procedures.

The venting must be in accordance with the GAMA venting tables. The minimum vertical vent length allowed is five feet (5').

ANNUAL inspection of the furnace and its vent system is strongly recommended. Visually check the vent for corrosion or separation at the joints and seams. It is the contractor's responsibility to inform the user of this importance.

All venting shall be in accordance with Part 7, Venting of Equipment, of the National Fuel Gas Code, ANSI Z223.1, or applicable local building and/or air conditioning codes.

PROPER INSTALLATION OF THE VENTING SYSTEM IS CRITICAL FOR SAFE OPERATION OF THIS APPLIANCE. CAREFULLY READ AND UNDERSTAND THE INSTRUCTIONS IN THIS SECTION.

### CAUTION

The products of combustion shall be discharged to the outdoors and are intended to be vented vertically.

This appliance is intended to be connected to "B" type vent material. Single wall pipe is to be used as a vent connector only.

This appliance **SHALL NOT** be connected to a vent servicing a solid fuel fireplace.

This appliance **SHALL NOT** be connected to a flue serving a factory built fireplace.

This appliance **SHALL NOT** be connected to an unlined masonry chimney.

THE USE OF NON-METALLIC VENT MATERIAL IS PROHIBITED.

This appliance **CAN NOT BE HORIZONTALLY VENTED** unless using an optional power venter such as the SVB-80 (-5), if permitted by local code.

CONSULT LOCAL CODES FOR SPECIAL ADDITIONAL REQUIREMENTS.

## GAS PIPING & GAS PIPE CAPACITY TABLE

Check the rating plate to make certain that the unit is equipped to burn the type of gas supplied. Care should be taken after the installation of this appliance that the gas control valve is not subjected to high gas supply line pressure.

In making connections, avoid strains as they may cause noise and damage the controls. Always use a back-up wrench when tightening the gas supply pipe to the gas control valve.

The furnace and its individual shut-off must be disconnected from the gas supply piping system during any pressure testing of that system at test pressures in excess of 1/2 psig (3.5kPa).

The furnace must be isolated from the gas supply piping system by closing its individual manual shut-off valve during any pressure testing of the gas supply piping system at pressures equal to or less than 1/2 psig (3.5 kPa).

Check for leaks in the gas supply using soap bubbles or other approved methods.

### WARNING

NEVER USE AN OPEN FLAME TO CHECK FOR GAS LEAKS. THIS PRACTICE MAY CAUSE A FIRE, EXPLOSION, BODILY HARM INCLUDING DEATH OR PROPERTY DAMAGE.

Pipe joint compound must be resistant to the affects of LP gas.

A union and listed manual shutoff must be installed exterior to the furnace cabinet so the control assembly may be easily removed.

A 1/8" NPT plug on the supply pipe at the manual valve for the purpose of making pressure measurement must also be installed. The valve should be readily accessible for turning on or off. A capped sediment trap, sometimes referred to as a drip leg, should be installed in the gas supply pipe as close to the furnace as possible. This trap must incorporate a change of direction of the gas flow.

Refer to local codes or the below mentioned publications for proper location of the manual shutoff and sediment trap lengths.

All gas piping must conform to local codes, or in the absence of local codes, to the National Fuel Gas Code ANSI Z223.1 and / or CAN/CGA B149 Installation Codes.

The gas pipe must be sized to eliminate undue pressure drop. See pipe capacity table or consult your local utility.

NOTE: Copper tubing must not be used for natural gas installations where more than 3 grains of hydrogen sulfide per 100 standard cubic feet of gas is present.

For installations in the Commonwealth of Massachusetts see Fuel Gas and Plumbing Code 248 CMR: Appendix C.

Capacity of gas pipe of different diameters and length in ft<sup>3</sup>/hr. with a pressure drop of 0.3" W.C. and a specific gravity of 0.60 (natural gas).

PIPE

LENGTH OF PIPE IN FEET

SIZE\*

	10	20	30	40	50	60	70	80
1/2	132	92	73	63	56	50	46	43
3/4	278	190	152	130	115	105	96	90
1	520	350	285	245	215	195	180	170
1 1/4	1050	730	590	500	440	400	370	350
1 1/2	1600	1100	890	760	670	610	560	530

\* Nominal size of Iron Pipe in inches.

After the length of pipe has been determined, select the pipe size that will provide the minimum cubic feet per hour of gas flow for the required input of the appliance. In the case where more than one appliance utilizes the same supply pipe be sure to consider the sum of all appliances. The cubic feet required for the appliances should be determined using the following formula;

Cubic feet per hour of gas required = Gas input of appliance (Btu/hr) / heating value of gas(Btu/hr)

The gas input of the appliance is marked on the specification plate. The heating value of the gas may be determined by contacting the gas utility or gas supplier.

**CAUTION**

If the local utility permits the use of a listed flexible gas connector, *ALWAYS USE A NEW FLEXIBLE CONNECTOR. DO NOT USE A FLEXIBLE GAS CONNECTOR WHICH HAS SERVICED ANOTHER APPLIANCE. AFTER A PERIOD OF TIME THESE LINES MAY BECOME BRITTLE AND WITH THE DISCONNECTION AND RECONNECTION CAN DEVELOP LEAKS.*

**CIRCULATING AIR SUPPLY AND RETURN AIR**

**WARNING**

**NEVER LAY THIS FURNACE ON IT'S FRONT OR REAR**

The circulating air supply may be taken from; 1) outside the building, 2) return ducts from several rooms, 3) central return, 4) any combination of the above.

When a cooling coil is not installed it is recommended that the supply duct have an access panel so the heat exchanger can be viewed. This panel shall be of sufficient size to permit the entrance of a light or probe to assist in the observation of the heat exchanger integrity or sampling the air stream. It should be sealed to prevent air leakage during normal operation.

Return air from one dwelling unit shall not be discharged into another dwelling unit.

**CAUTION**

**DO NOT** take return air from bathrooms, kitchens, furnace rooms, garages, utility or laundry rooms or cold areas. If outside air is utilized it should not be taken from within 10 feet of an appliance vent outlet, a vent opening or a plumbing drainage system or the discharge from an exhaust system unless the outlet is three (3) feet above the outside air inlet. **DO NOT** take return air from areas where it can pick-up objectionable odors, fumes, or flammable vapors.



Note: When a combination of outdoor and indoor air is used the system should be designed and adjusted so that the temperature reaching the appliance will not drop below 50° F during heating operation. When this type of system is used the volume of air must not be reduced.

Plenum chambers and air ducts must be installed in accordance with the Standard for the Installation of Air Conditioning and Ventilating Systems, NFPA # 90A, or the Standard for the Installation of Warm Air Heating and Air Conditioning Systems, NFPA # 90B.

If installed in parallel with a cooling unit, the damper or other means used to control the flow of air must be adequate to prevent chilled air from entering the furnace. If manually operated, must be equipped with means to prevent operation of the other unit unless the damper is in the full heat or cool position.

**NOTE: UPON INITIAL START-UP SOME SMOKE OR AN ODOR MAY BE PRESENT. THIS IS NORMAL AND SHOULD DISAPPEAR IN A SHORT AMOUNT OF TIME. IT IS RECOMMENDED THAT THE DOORS AND WINDOWS BE OPENED UPON INITIAL START-UP TO VENT THE BUILDING OF THIS NON TOXIC, NON STAINING SMOKE.**

### **CAUTION**

One of the most common causes of problems, including premature heat exchanger failure, in forced air heating systems is insufficient return air.

The return air duct system to the furnace should be approximately equal to or greater than the area of the warm air discharge. Embosses are provided on the sides of the furnace to act as guidelines for this purpose.

Consult local codes for specific requirements.

The blower speed should be adjusted to maintain the temperature rise range shown on the rating plate.

The total static pressure should not exceed 0.50" W.C.

### **WARNING**

NEVER ALLOW THE PRODUCTS OF COMBUSTION, INCLUDING **CARBON MONOXIDE**, TO ENTER THE RETURN DUCTWORK OR CIRCULATING AIR SUPPLY. ALL CIRCULATING AIR DUCTS MUST BE ADEQUATELY SECURED TO THE FURNACE AND COMPLETELY SEALED AIRTIGHT USING APPROVED CONNECTIONS. THE VENT AND COMBUSTION AIR SUPPLY PIPES MUST BE PROPERLY INSTALLED AND SUPPORTED TO PREVENT LEAKAGE AS NOTED ELSEWHERE IN THESE INSTRUCTIONS. WHEN A FURNACE IS MOUNTED ON A PLATFORM IT MUST BE SEALED AIRTIGHT BETWEEN THE FURNACE AND RETURN DUCTWORK. THE FLOOR OR PLATFORM MUST PROVIDE SOUND PHYSICAL SUPPORT FOR THE FURNACE WITHOUT CRACKING, GAPS, SAGGING ETC. AROUND THE BASE AS TO PROVIDE A SEAL BETWEEN THE SUPPORT AND THE BASE. THE BASE OR PLATFORM MUST BE SEALED AIRTIGHT TO THE FLOOR.

FAILURE TO PREVENT PRODUCTS OF COMBUSTION FROM ENTERING THE RETURN AIR SUPPLY MAY CAUSE SEVERE ILLNESS INCLUDING **CARBON MONOXIDE** POISONING OR DEATH.

Install the return air to terminate through the base under the furnace. For installations where return air ducts cannot be run under the floor, the return air supply may be taken from the side(s). The solid bottom supplied on the furnace must remain in place.

When installed in the downflow position, on combustible material, a special sub-base must be installed for a heating only application. If a cooling coil is installed under the furnace the sub-base is not necessary.

WHERE THE MAXIMUM REQUIRED AIR FLOW IS 1800 CFM OR GREATER THE BOTTOM OR BOTH SIDES MUST BE UTILIZED FOR RETURN AIR SUPPLY. NEVER USE THE REAR OF THE FURNACE FOR THE RETURN AIR CONNECTION.

### **WARNING**

A SOLID METAL BASEPLATE IS SUPPLIED ON THIS FURNACE. THIS BASEPLATE MUST BE IN PLACE WHEN THE FURNACE IS INSTALLED WITH SIDE(S) RETURN AIR DUCTS. FAILURE TO DO SO MAY PERMIT COMBUSTION PRODUCTS, INCLUDING **CARBON MONOXIDE**, TO ENTER THE LIVING SPACE. THIS MAY CREATE POTENTIALLY HAZARDOUS CONDITIONS SUCH AS **CARBON MONOXIDE** POISONING OR DEATH. THE FULL SIZE RETURN AIR DUCT OPENINGS MUST BE UTILIZED. EMBOSESSES ARE PROVIDED FOR THIS PURPOSE.

### **ELECTRICAL SUPPLY CONNECTIONS**

The electrical requirements are listed on the series and rating plate on the furnace. A separate supply line with a current overload device and a manual switch, where required, must be installed. Type "T" wire or equivalent with a minimum rating of 95°F (35°C) temperature rise must be run directly from the main power supply to the junction box in the furnace. Use wire which employs copper conductors only.

Installation of the electrical supply should be according to local codes. In the absence of local codes refer to the National Electrical Code ANSI/NFPA No. 70 (latest edition), which can be obtained from the National Fire Protection Association, Batterymarch Park, Quincy, MA 02269. In Canada refer to the latest edition of the Canadian Electrical Code C22.1 Part I.

### **WARNING**

THE GAS SUPPLY PIPE MUST NEVER USED FOR GROUNDING PURPOSES.

### **CONTROL VOLTAGE CONNECTIONS**

#### THERMOSTAT INSTALLATION

Install the thermostat according to the instructions accompanying the thermostat. Run the thermostat wires into the control compartment in the furnace. Connect the thermostat wiring as shown on the wiring diagram. The thermostat wiring should be a minimum of 18 gauge. Adhere to recommended color code to facilitate future troubleshooting.

The thermostat should be located near the return air grille or opening. It should be approximately 5 feet from the floor level.

Never locate the thermostat where it will be influenced by heat generated from hot water pipes, lamps, televisions, direct sunlight, supply air registers, etc. Interconnecting wiring must be secured and protected from damage or disconnection. The use of solderless connectors or equivalent is recommended.

The low voltage control wiring exiting the furnace is labeled "thermostat wiring."

#### SETTING THE HEAT ANTICIPATOR

The following method should be used in measuring the amp draw of the control circuit to assure proper adjustment of the thermostat heat anticipator

**RATING THE FURNACE**

The furnace is supplied with orifices sized for natural gas at altitudes up to 2,000 feet using a heating value of approximately 1,000 Btu/hr, and should not normally require change. If for use at altitudes in excess of 2,000 feet refer to the instructions included in the factory authorized high altitude kit (**HA-02**). Should this appliance be converted to LP, refer to the instructions included in the factory authorized LP conversion kit LPM-01 (LPM-03 for GMPE).

It is important to check and adjust the input rate of the furnace to prevent an overfiring situation. Overfiring can cause premature heat exchanger failure. The input is controlled by the supply pressure, orifice size, manifold pressure and heating (calorific) value of the gas.

The supply pressure must be measured with this and all other gas burning appliances in operation. The supply pressure must be adjusted to the pressure range stated on the series and rating plate. Applications for altitudes in excess of 2,000 feet usually require an orifice change. The orifices must be selected using the table below. The furnace derate is 4% for each 1,000 feet above sea level. This table is based upon a heating value of approximately 1,000 Btu/ft<sup>3</sup>

ALTITUDE	NAT. GAS ORIFICE SIZE
0 - 2,000	#42 (#43 on -050)
3,000	#43 (# 44 on -050)
4,000	#44 (#45 on -050)
5,000	#45 (#46 on -050)
6,000	#45 (#47 on -050)
7,000	#45 (#48 on -050)

The input to the furnace must be checked AFTER reorificing.

For altitudes above 7,000 feet refer to appropriate section of the National Fuel Gas Code, ANSI Z223.1. To calculate the input of the furnace for installations in altitudes over 2,000 feet, use the following formula:

$$\text{CORRECTED INPUT} = \text{SERIES \& RATING PLATE INPUT} - (\text{ALTITUDE} \times .04) \times (\text{SERIES \& RATING PLATE INPUT} / 1000)$$

## EXAMPLE:

*Corrected input for a 100,000 Btu/hr. appliance installed at an altitude of 6,000 ft. utilizing natural gas with a heating value of 1,000 Btu/ft<sup>3</sup> is determined by-*

$$\text{Corrected Input} = 100,000 - (6,000 \times .04) \times (100,000 / 1,000)$$

$$\text{Corrected Input} = 100,000 - (240 \times 100)$$

$$\text{Corrected Input} = 100,000 - 24,000$$

$$\text{Corrected Input} = 76,000$$

*Using the orifices sized as shown in the table for 6,000 feet (#45), a meter time of 48.0 seconds is measured. The actual firing rate of the furnace is*

$$\text{Input} = 1,000 \text{ (heating value of the gas)} \times 3600 \text{ (constant)} / 48.0 \quad (\text{meter time for } 1 \text{ ft}^3 \text{ of gas})$$

$$\text{Input} = 3,600,000 / 48.0$$

$$\text{Input} = 76,000 \text{ Btu/h}$$

In Canada, the series and rating plate input for the furnace apply to installations up to 2,000 feet (610m) above sea level. Kit **HA-02** for natural and LP gases is required to convert furnaces from elevations of 2,000 to 4,500 feet (610m to 1,370m). Canadian certification applies to the installations of up to 4,500 feet above sea level. Installations above 4,500 feet are subject to acceptance by the local authorities having jurisdiction.

## WARNING

BEFORE ATTEMPTING ANY SERVICE OR ADJUSTMENTS - INSURE THAT THE GAS AND ELECTRICAL SUPPLIES ARE OFF.

## TIMING THE GAS METER

Use the following method to determine the firing rate of the furnace. The supply pressure tap should be located on the field installed piping or gas shut-off valve, or on the combination gas valve at the location marked "INLET PRESSURE TAP". The manifold pressure tap is located on the combination gas valve in the furnace and labeled "OUTLET PRESSURE TAP".

- Install a manometer graduated in tenths of an inch of water column on the supply pressure tap on the gas supply pipe.
- Remove plug at the "Manifold" pressure tap on the gas valve and install a second manometer.
- Determine the size of gas meter used.
- Shut off all other gas fired appliances except for the pilots.
- Place furnace in operation.
- Check the supply pressure regulator until the pressure shown on series and rating plate is obtained. Adjust if necessary.
- After 15 minutes of operation, time the meter with a stop watch for 2 revolutions & divide by 2.
- Use the appropriate column to determine the furnace input.
- If necessary, adjust the manifold pressure at the gas valve by removing the regulator cap and turning the adjustment screw clockwise to raise the pressure and counterclockwise to reduce the pressure. The manifold pressure must be between 3.2" W.C. and 3.8" W.C. (3.5" nominal) for natural gas and 9.5" W.C. to 10.5" W.C. for LP (a field conversion is necessary for LP). The

inability to maintain the proper pressure range will require reorificing. After reorificing, repeat the above steps to insure that the furnace input is adjusted properly.

- Turn off gas and electrical supply, remove manometers and replace any plugs that were removed. Use a pipe joint compound that is suitable for use with LP gas.
- Restore any other appliances affected to their normal operating mode.

**METER TIME IN MINUTES AND SECONDS FOR NORMAL INPUT RATING OF FURNACES  
EQUIPPED FOR USE WITH NAT. GAS AT 0 - 2,000 FEET ALTITUDE.**

INPUT Btu/hr	METER SIZE FT <sup>3</sup>	HEAT VALUE 900		HEAT VALUE 1,000		HEAT VALUE 1040		HEAT VALUE 1,100	
		MIN.	SEC.	MIN.	SEC.	MIN.	SEC.	MIN.	SEC.
45,000	1	1	12	1	20	1	23	1	28
	10	12	00	13	20	13	50	14	40
75,000	1	0	43	0	48	0	50	0	53
	10	7	12	8	00	8	19	8	48
100,000	1	0	32	0	36	0	37	0	40
	10	5	24	6	00	6	14	6	36
125,000	1	0	26	0	29	0	30	0	32
	10	4	19	4	48	5	00	5	17
150,000	1	0	22	0	24	0	25	0	26
	10	3	16	4	00	4	10	4	24

**MAIN BURNER ADJUSTMENT**

The main burners should not need adjustment in most instances. However, burner air shutters are provided should adjustment be necessary. After the furnace has been in operation for at least five (5) minutes loosen the air shutter locking screws and close the shutter until yellow tipped flames appear. Now slowly open the shutter until the yellow disappears. Retighten the locking screw.

**SAFETY CONTROL FUNCTIONS AND CHECK-OUT PROCEDURE**

**GENERAL**

In most cases the safety controls are wired in series with the “W” leg. It is imperative that these switches remain in the circuit. Never jumper, relocate or bypass any control. The safety controls must be checked for proper operation at the time of start-up of the furnace.

**WARNING**

SHOULD ANY SAFETY CONTROL BE ALTERED, JUMPERED OR BYPASSED, A HAZARDOUS CONDITION SUCH AS FIRE OR THE POSSIBILITY OF **CARBON MONOXIDE** ENTERING THE BUILDING MAY OCCUR.

**MAIN LIMIT SWITCH**

The main limit switch is a 1/2” disc designed to shut off the burner gas should the supply air temperature exceed the maximum design temperature. This switch is not adjustable. To check the operation, block the return air flow through the unit temporarily. The limit switch should function and shut the burner gas off within a few minutes. Remove the blockage and allow the switch to cool sufficiently before reestablishing burner flames.

**VENT PRESSURE SWITCH**

This furnace uses a vent pressure switch that prevents the furnace from operating should any portion of the vent system become restricted or a venter failure occur. To check this switch, place the furnace in operation and remove the hose from the switch. The gas burners will extinguish. Replacing the hose will allow the furnace to operate normally.

### **FLAME ROLL-OUT SWITCH**

This furnace is equipped with a flame roll-out switch(s). This manually resettable switch is a 1/2" disc type and is non-adjustable. This switch is designed to shut down the burner gas if there are flames outside the heat exchanger. Should this switch function, contact a qualified service person to determine the cause of function before resetting. To reset this switch press the button on top of the switch after the furnace has cooled. To test the operation of the switch with the furnace in operation, place an open flame on the disc portion of the switch. The switch should function to shut down the burner gas. **Wait until the furnace has cooled sufficiently before resetting the switch.**

### **FLAME SENSOR**

The ignition is provided by an electronic ignition system. The burner flames will become extinguished if the flame sensor fails to detect the presence of the burner flame. To test, disconnect the flame sensor wire before placing the furnace in operation. The electronic ignition device should attempt to light the burners. However, the burners should shut off after a few seconds of operation. Disconnect the electrical supply to the furnace, reinstall the disconnected sensor wire and reset the power supply to restore the furnace to its normal operation.

### **BLOWER DOOR INTERLOCK SWITCH**

The purpose of the switch is to disconnect electrical power to the furnace should the blower door become dislodged, removed, or not properly reinstalled. **ALLOWING THE FURNACE TO OPERATE WITHOUT THE BLOWER DOOR BEING SECURELY IN PLACE CAN CAUSE COMBUSTION PRODUCTS TO BECOME CIRCULATED THROUGHOUT THE LIVING AREA WHICH CAN CAUSE SERIOUS ILLNESS OR CARBON MONOXIDE POISONING.** To test the operation of this switch, place the furnace in operation and remove the blower access door. The burner flames will extinguish and the venter and circulating air blowers should both stop. To restore the unit to normal operation, shut off the electrical power to the unit, replace the blower access door and restore the electrical power.

### **INTEGRATED FAN / IGNITION CONTROL**

This furnace is equipped with a combination ignition module and fan control. The ignition source is an electronic device. This device ignites the burners upon a call for heat. It also controls the venter blower and the various speed selections and timings of the circulating air blower. This control is located in the circulating air blower compartment. Upon a demand for heat the venter is energized. After a short purge, the electronic ignition device is energized. The burners are ignited and after a short delay, the burner flame is proven. The circulating air blower is energized approximately thirty (30) seconds after the burners are ignited. The circulating air blower is de-energized by a field selectable fan off timer. **THIS CONTROL IS NOT FIELD SERVICABLE.**

## CIRCULATING AIR FILTERS

One of the most common cause of a problem in a forced air heating system is a blocked or dirty filter. Circulating air filters must be inspected monthly for dirt accumulation and replaced if necessary. Failure to maintain clean filters can cause premature heat exchanger failure.

A new home may require more frequent replacement until all construction dust and dirt is removed. Circulating air filters are to be installed in the return air duct external to the furnace cabinet.

### CAUTION

Before performing any service on this furnace, including checking or replacing circulating air filters - disconnect the main power supply.

**DO NOT** operate the furnace without circulating air filters in place.

### MINIMUM FILTER SIZES

FURNACE INPUT	FILTER SIZE	TYPE
45M	188 IN <sup>2</sup>	PERMANENT
75M	287 IN <sup>2</sup>	PERMANENT
100M	303 IN <sup>2</sup>	PERMANENT
125M	347 IN <sup>2</sup>	PERMANENT
150M	625 IN <sup>2</sup>	PERMANENT
45M	375 IN <sup>2</sup>	DISPOSABLE
75M	555 IN <sup>2</sup>	DISPOSABLE
100M	606 IN <sup>2</sup>	DISPOSABLE
125M	694 IN <sup>2</sup>	DISPOSABLE
150M	1250 IN <sup>2</sup>	DISPOSABLE

PERMANENT NOMINAL 600 C.F.M.

DISPOSABLE NOMINAL 300 C.F.M.

## TEMPERATURE RISE

The temperature difference between the supply air and the return air of the furnace is known as the temperature rise. This furnace is designed to operate within the temperature rise range displayed on the furnace series and rating plate. To ensure satisfactory performance, the temperature rise of the furnace must be measured and if necessary adjusted. Use the following procedure to measure and adjust the temperature rise:

- Before starting the furnace visually inspect all joints and seams in the supply and return air ducts for leaks. Repair them if necessary.
- Adjust the room thermostat to obtain constant operation.
- Allow the furnace to operate for at least fifteen (15) minutes.
- With an accurate thermometer measure the temperature at the return air. If a combination indoor / outdoor system is used, the temperature must be measured downstream of the connection.
- Measure the outlet air temperature at a point approximately twelve to eighteen (12 -18) inches from the furnace in the supply air duct work. It may be necessary to measure the outlet air at several places to obtain an accurate average. **NOTE: IF AN AIR CONDITIONING COIL IS INSTALLED, TAKE CARE SO AS NOT TO DAMAGE THAT COIL.**
- Adjust the temperature by changing circulating air blower speed tap. Increasing the motor speed lowers the temperature rise while lowering the motor speed increases the temperature rise.

## MOTOR LUBRICATION AND MAINTENANCE

The circulating air blower is equipped with bearings that are permanently lubricated by the motor manufacturer and require no lubrication. At the time of the monthly filter inspection clean the exterior of the circulating air motor, especially around the perimeter air holes to prevent the possibility of overheating due to an accumulation of dust or dirt on the windings and motor casing. As suggested elsewhere in these instructions, the air filters must be kept clean. Dirty filters will restrict the air flow over the motor windings and possibly cause an overheating condition.

- The venter motor bearings are prelubricated by the motor manufacturer & require no attention.

## SERVICE INSTRUCTIONS

**DO** keep the circulating air filters clean. The heating system will operate more efficiently and economically.

**DO** arrange drapes & furniture so that the supply air registers & return air grilles are unobstructed.

**DO** close doors and windows. This will reduce the heat load on the system.

**DO** avoid excessive use of bathroom and kitchen exhaust fans.

**DO NOT** allow heat generated by televisions, lamps, direct sunlight, etc. to influence the thermostat operation.

**DO NOT** allow combustible materials to accumulate within (3) feet of the furnace.

**DO NOT** use the furnace room as a storage area.

**DO NOT** store gasoline or other flammable liquids or vapors in the vicinity of the furnace.

## SEQUENCE OF OPERATION

This appliance is controlled by the room thermostat. Within this section the term lockout is referenced. This lockout is a “soft” lockout, which will re-set after one hour. It is the obligation of the installer to educate the user on the proper use of the thermostat and the sequence of operation in both the heating and cooling modes. It is also important that any repair or service be performed by a QUALIFIED service person, not by the user.

Wrap the “R” leg around a clip-on amp meter 10 times.

Energize the furnace in the heat mode. Record the reading.

Divide this reading by 10. Set the heat anticipator on the thermostat to match this reading.

**EXAMPLE:**

If the reading on the amp meter is “4”, divide this by 10.

The anticipator setting will be .4 amps.

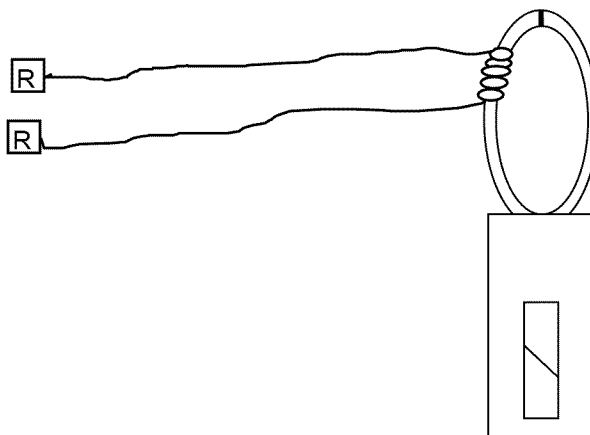



## HEATING MODE

- The furnace control checks for an open main limit (this limit is normally closed). If the main limit is open, the furnace will remain inoperable until the limit is closed. During an open limit the circulating air blower and vent blower will be energized. The status light will blink four (4) times.
- The room thermostat reacts to a demand for heat.
- The control will then check to insure that the vent pressure switch is open. If, at this point, the vent pressure switch is closed the control will blink two (2) times and will remain inoperable until this situation is corrected.
- The venter blower is energized.
- The vent pressure (vacuum) switch will close when it detects a pressure in excess of its setting. If the pressure switch fails to close the status light will flash three (3) times. The sequence cannot continue until the pressure switch closes.
- After a pre-purge period, the electronic ignition device will be energized.
- After a slight delay, the gas valve will open if the flame roll-out switches are closed.
- The burners will ignite and the flame sensor will detect the presence of flame. The igniter will then deenergize. If the sensor does not detect the burner flame, the gas valve will close and the ignition cycle will be repeated for a total of three attempts. If, after the third attempt, the presence of flame is not detected, the furnace will go into a lockout condition for one (1) hour. It will then repeat the ignition cycle. This one (1) hour lockout and retry will occur indefinitely.
- Thirty (30) seconds after the main valve is energized the circulating air blower will be activated.
- The furnace will remain in operation until the demand for heat is satisfied.
- Once the demand is satisfied the venter will shut off, and the circulating air blower will shut off after field adjustable time is attained.
- The furnace will remain dormant until the next demand for heat.

## COOLING MODE

The control checks for an open limit. If an open limit is detected the furnace will remain inoperable until the condition is corrected. During an open limit condition the circulating air blower will be energized. The status light will blink four (4) times.

- A demand for cooling is initiated.
- The condenser contactor will close.
- After a short delay, the circulating air blower will start on the cooling speed.
- After the room thermostat is satisfied the condenser contractor will open.
- The circulating air blower will remain in operation for approximately sixty (60) seconds.

## REMOVING AN EXISTING APPLIANCE

When replacing an existing appliance, the resulting installation must comply with all local codes, or in the absence of local codes, to the National Fuel Gas Code ANSI Z223.1 and/or CAN/CGA B149 Installation Codes as well as these installation instructions.

If the installation of this furnace requires that an existing appliance be removed from a venting system that still serves another gas fired appliance it may require that the existing vent be resized. The following steps shall be performed with each appliance connected to the venting system placed in operation while any other appliance connected to the venting system are not in operation;

- a) Seal any unused openings in the venting system;
- b) Inspect the venting system for proper size and horizontal pitch, as required in the National Fuel Gas Code, ANSI Z223.1 or the CAN/CGA B149 Installation Codes and these instructions. Determine that there is no blockage or restriction, leakage, corrosion and other deficiencies which could cause an unsafe condition;
- c) In so far as practical close all building doors and windows and all doors between the space in which the appliance(s) connected to the venting system are located and other spaces in the building. Turn on clothes dryers and any other appliance not connected to the venting system. Turn on any exhaust fans such as range hoods and bathroom exhausts, so they shall operate at their maximum speed. **DO NOT** operate a summer exhaust fan. Close fireplace dampers;
- d) Follow lighting instructions. Place the appliance being inspected in operation. Adjust the thermostat so the appliance shall operate continuously;
- e) Test for draft hood equipped appliance spillage at the relief opening after five (5) minutes of burner operation. Use the flame of a match or candle;
- f) After it has been determined that each appliance connected to the venting system properly vents when tested as outlined above, return all doors, windows, exhaust fans, fireplace dampers and any other gas-burning appliance back to their previous condition of use;
- g) If improper venting is observed during any of the above tests, the venting system must be corrected.

If resizing of the existing vent is required this shall be sized according to Appendix G of the National Fuel Gas Code, ANSI Z223.1 or CAN/CGA B149 Installation Codes.

## INSPECTING & CLEANING THE HEAT EXCHANGER

### CAUTION

Label all wires prior to disconnection when servicing controls. Wiring errors can cause dangerous and improper operation. Verify proper operation after servicing.

It is the obligation of the installer to advise the user to have the furnace inspected and cleaned annually. To clean the heat exchanger perform the following:

- Adjust the room thermostat to its lowest setting.
- Turn off the gas and electric supply to the furnace.
- Remove the control access door.
- Open the gas supply union.
- Disconnect the gas supply line attached to the gas valve.
- Remove the wires connected to the gas valve.
- Remove the burner box assembly. Care must be exercised to avoid damage to any components.
- Inshot burners should not require cleaning. However, if they exhibit signs of corrosion they can be cleaned by brushing with a stiff wire brush.
- Remove the vent from the furnace venter blower.
- Remove the venter blower and collector box.

- With a stiff wire brush on a flexible handle remove any loose scale from the heat exchanger at both the flue and burner openings.
- With a vacuum remove any loose scale dislodged and any additional debris found in the heat exchanger.
- Visually inspect the heat exchanger cells for any failures using a bright light. **If any failures are discovered it is important to disable the furnace and notify the user to ensure that it remains inoperable until repairs are implemented.**
- Reassemble the furnace in the reverse order. Note: No additional screws or wires are supplied with this product. All components must be reassembled to avoid an unsafe condition.
- Reconnect gas supply and check for leaks using a soap solution. If a flexible gas line is used examine it for cracks or weakness. Replace if necessary.
- Restore electrical power.
- Follow the lighting instructions to place the furnace into operation.

### SOURCE OF COMBUSTION AIR

The recommended source of combustion air is the outdoor air supply. However, the use of indoor air in most applications is acceptable except as follows;

1. If the furnace is installed in a confined space it is recommended that the necessary combustion/ventilation air originate via the attic, crawl space, or direct opening to the outside.
2. If indoor combustion is used, there must be no exposure to the substances.
3. The following installations may require OUTDOOR AIR for combustion, due to chemical exposures;

- Commercial buildings
- Buildings with indoor pools
- Furnaces installed in laundry rooms
- Furnaces installed in hobby or craft rooms
- Furnaces installed near chemical storage areas

Exposures to the following substances in the combustion air supply may also require OUTDOOR AIR for combustion;

- |  |  |
|--|--|
| • Permanent wave solutions               | • Cleaning solvents (such as perchloroethylene)  |
| • Chlorinated waxes and cleaners         | • Printing inks, paint removers, varnishes, etc. |
| • Chlorine based swimming pool chemicals | • Hydrochloric acid                              |
| • De-icing salts or chemicals            | • Cements and glues                              |
| • Carbon tetrachloride                   | • Antistatic fabric softeners for clothes dryer  |
| • Halogen type refrigerants              |  |
| • Masonry acid washing materials         |  |
| • Softeners for clothes dryer            |  |

AIR FROM ATTIC AND CRAWL SPACE

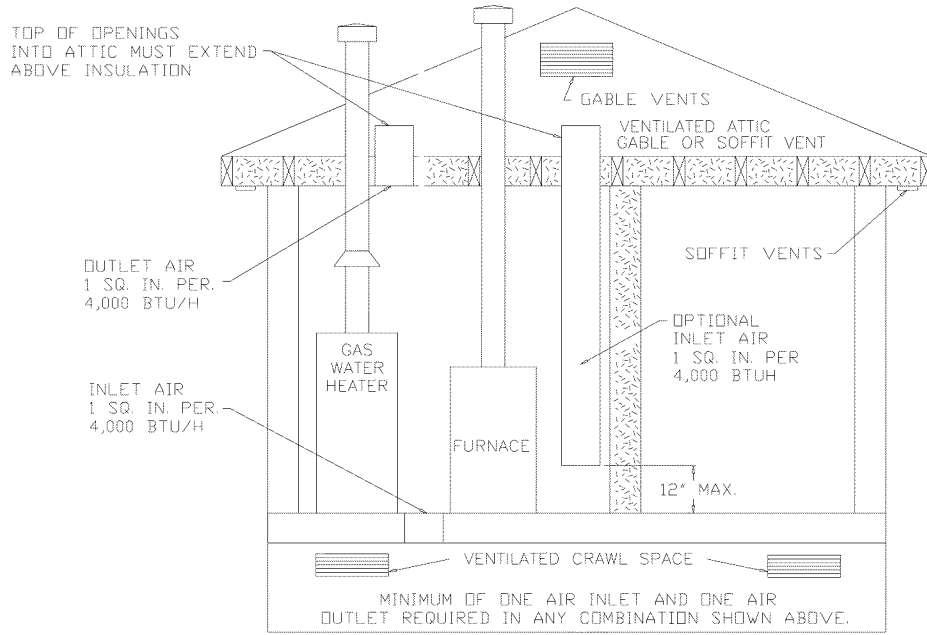

FIGURE 1

AIR FROM HEATED SPACE

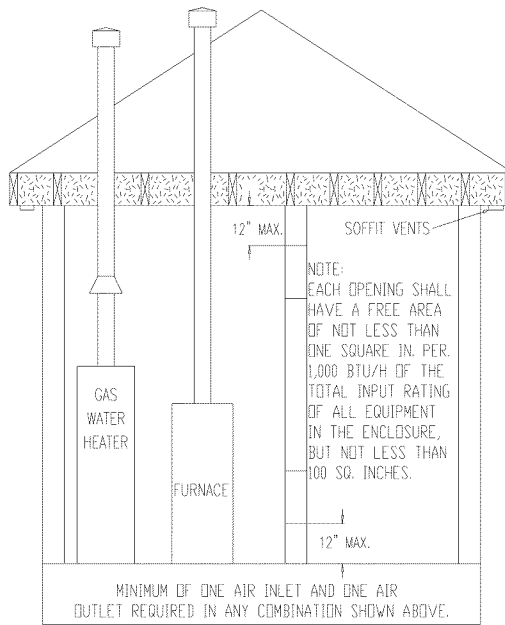

FIGURE 2

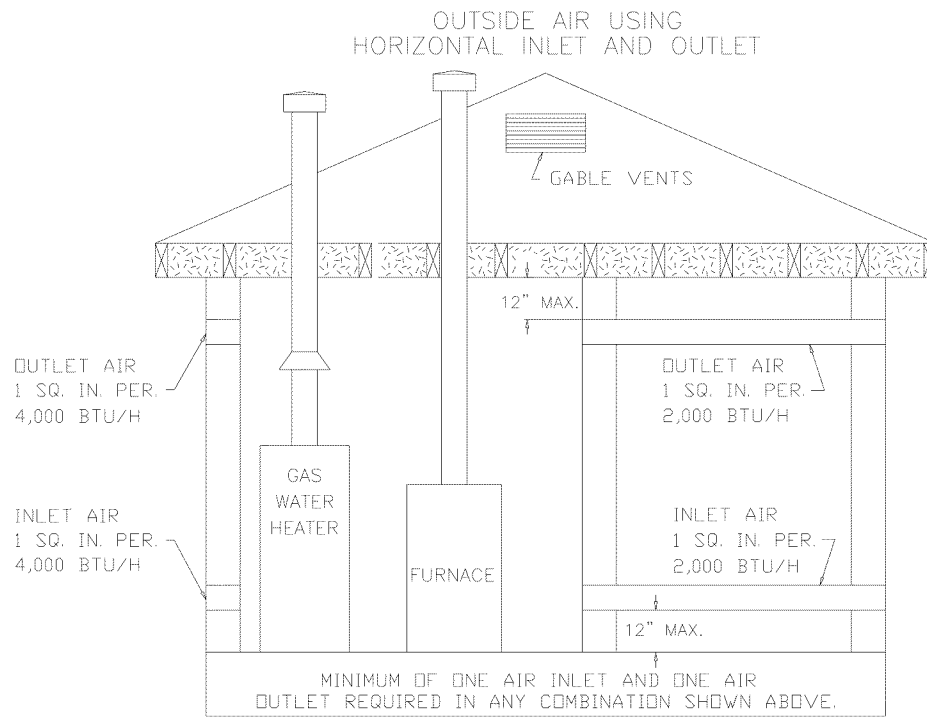
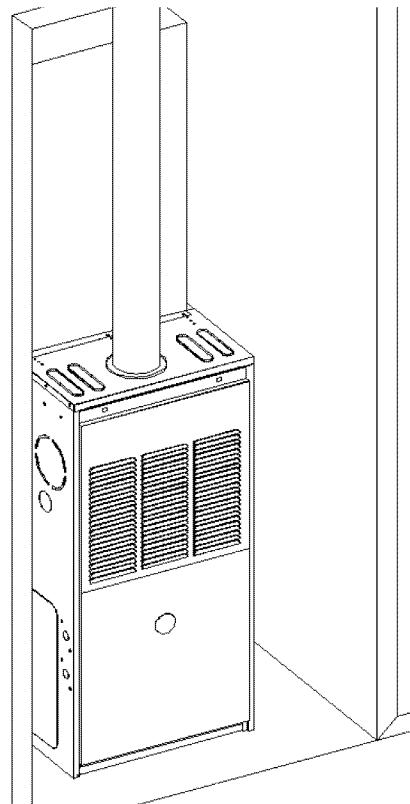

FIGURE 3  
**CLEARANCES FROM COMBUSTIBLE SURFACES**

VENT PIPE CLEARANCE TO  
COMBUSTIBLES 6" USING  
SINGLE WALL CONNECTOR  
OR 1" USING B-1 VENT

AIR FOR COMBUSTION OR  
VENTILATION MAY NOT BE  
TAKEN FROM BATHROOMS,  
BEDROOMS OR OTHER  
AREAS WHERE A DOOR MAY  
ISOLATE THAT ROOM.

RETURN AIR DUCTS MUST  
BE COMPLETELY SEALED TO  
THE FURNACE AND  
TERMINATE OUTSIDE THE  
ENCLOSURE.



ADEQUATE COMBUSTION /  
COMBUSTION AIR MUST BE  
SUPPLIED TO THE CLOSET.

CLEARANCES TO COMBUSTIBLES  
FRONT 3" (24" RECOMMENDED FOR  
SERVICE)  
LEFT & RIGHT SIDE 1"  
TOP OF PLENUM 1"  
REAR 0"  
FURNACE MUST BE COMPLETELY  
SEALED TO FLOOR OR BASE.  
COMBUSTION / VENTILATION AIR SUPPLY  
PIPES MUST TERMINATE 12" FROM TOP  
OF CLOSET AND 12" FROM FLOOR OF  
CLOSET.  
DO NOT REMOVE SOLID BASE PLATE  
FOR BOTTOM RETURN.

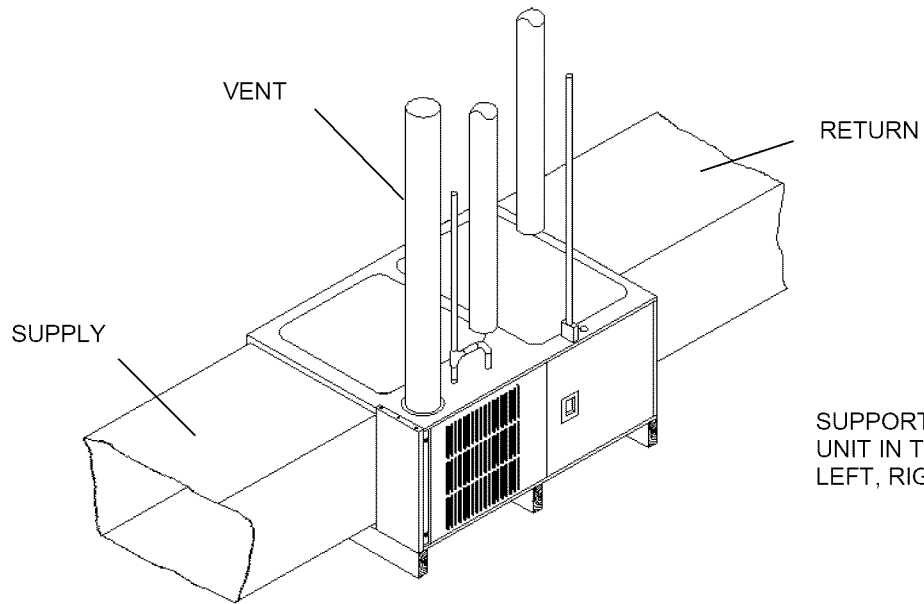

SUPPORT OR SUSPEND  
UNIT IN THREE PLACES:  
LEFT, RIGHT, AND CENTER.

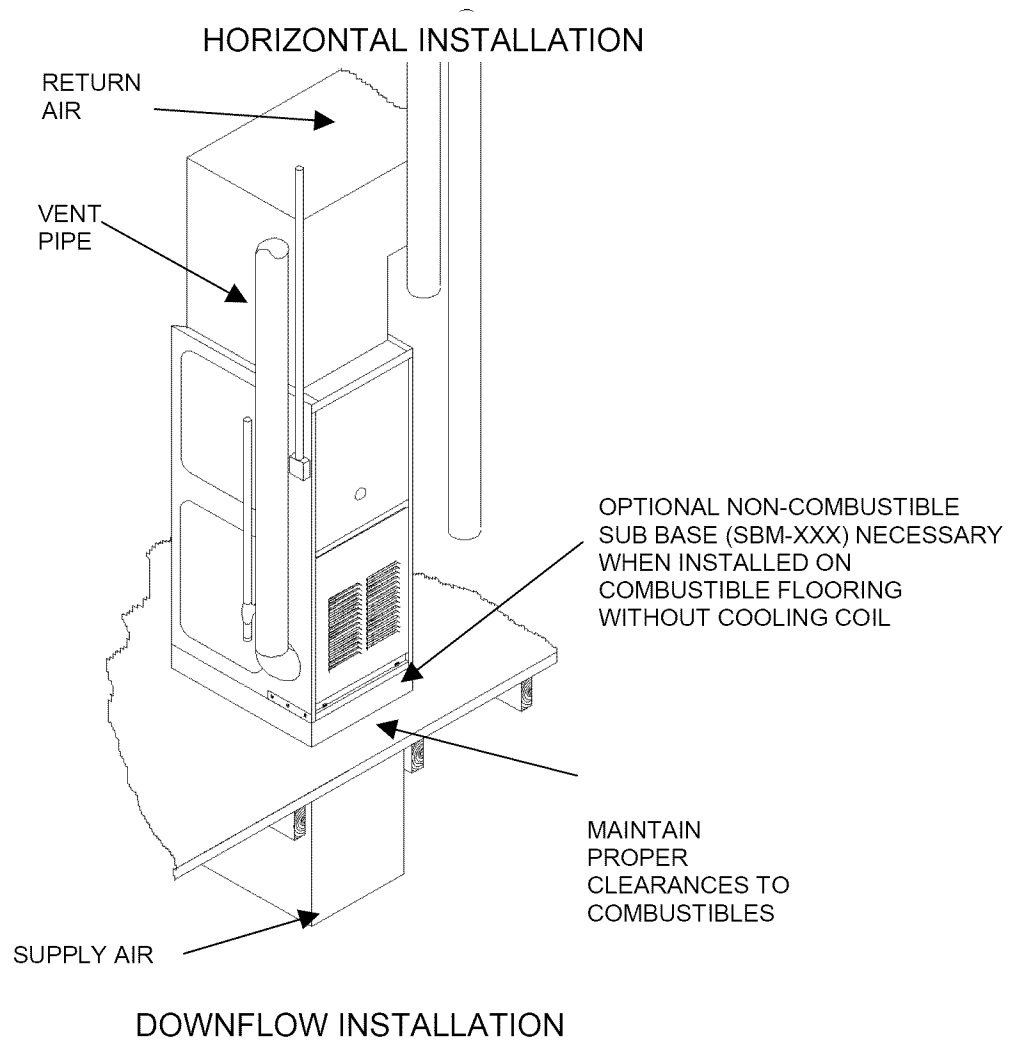

## ROTATION OF VENT BLOWER

THE VENTER ASSEMBLY MAY BE ROTATED TO FIT THE VENTING REQUIREMENTS. REMOVE THE FOUR PERIMETER SCREWS, ROTATE THE VENTER TO THE DESIRED POSITION AND REINSERT AND TIGHTEN THE SCREWS. THE ORIFICE PLATE MUST BE ROTATED ALONG WITH THE VENTER ASSEMBLY FOR PROPER COMBUSTION AND IGNITION. A LOCATOR PIN IS PROVIDED FOR THIS PURPOSE. **DO NOT** USE SELF PIERCING SCREWS TO SECURE THE VENT TO THE PLASTIC CHIMNEY. USE A DRAFT HOOD CONNECTOR OR THE SELF DRILLING SCREWS SUPPLIED WITH THE FURNACE.



LOCATING PIN

VENTER SHOWN ROTATED IN THE LEFT VENTING POSITION. NOTE THE POSITION OF THE LOCATING PIN



LOCATING PIN

VENTER SHOWN IN THE (AS RECEIVED) VERTICAL VENT POSITION. NOTE THE POSITION OF THE LOCATING PIN.  
NOTE POSITION OF LOCATING PIN.

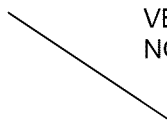

LOCATING PIN

VENTER SHOWN IN THE RIGHT SIDE VENT POSITION.  
NOTE POSITION OF LOCATING PIN.

## BLOWER OFF DELAY

In the heating mode, the time period between the extinguishing of the burners and the circulating blower turning off, is known as the “Blower Off Delay.” This time is factory preset at 150 seconds. The 150 second delay can be changed to 120 or 90 seconds by changing the position of a jumper on the Ignition Control.

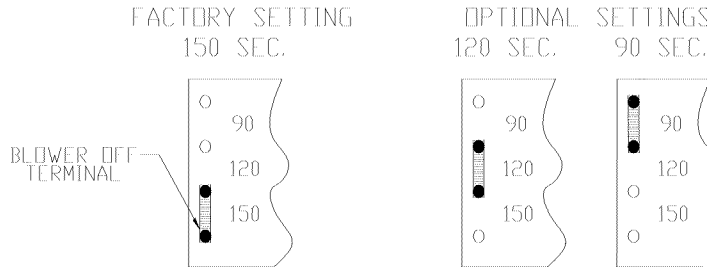

## HUMIDIFIER CONTROL

The screw terminal on the ignition control called “HUM” is designed to give a 24 VAC signal to a humidistat in the heating mode. **DO NOT USE ON HUMIDIFIERS WHICH USE 115 VAC.**

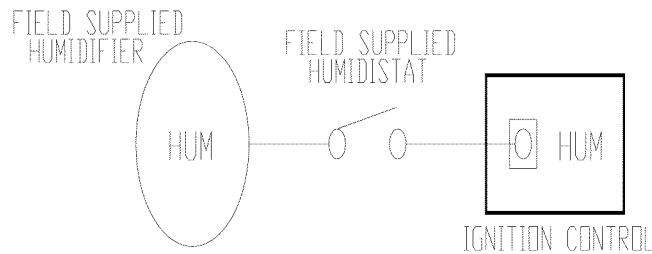

## ELECTRONIC AIR CLEANER CONTROL

The red-capped terminal on the ignition control marked “EAC” is to supply 115 VAC to an Electronic Air Cleaner. This terminal is powered in both the heating and air conditioning modes when the circulating blower is operating.



GMP ONLY

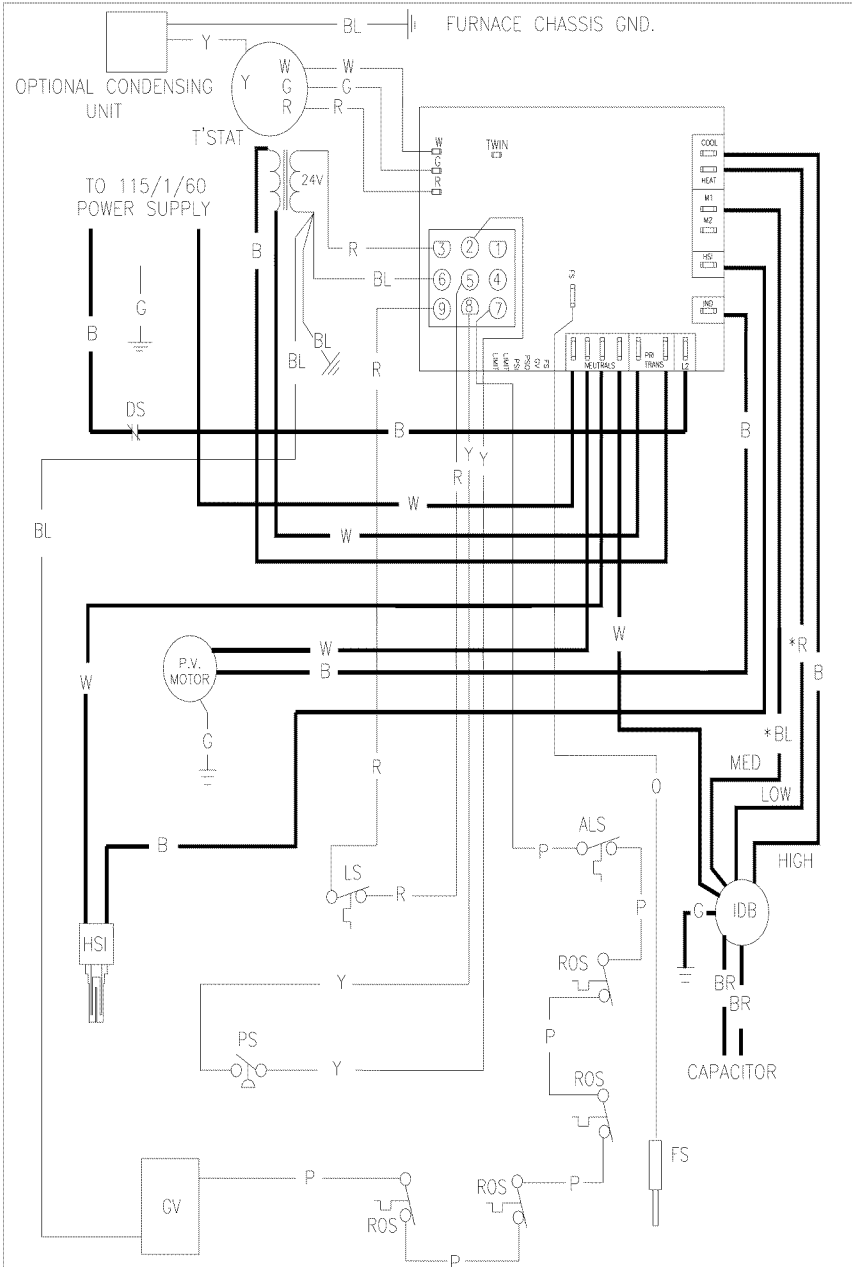

NOTE:  
THE LEADS FROM THE MOTOR  
MAY BE CHANGED TO THE  
REQUIRED SPEED.

\* MED HI - YELLOW  
MED LOW - ORANGE

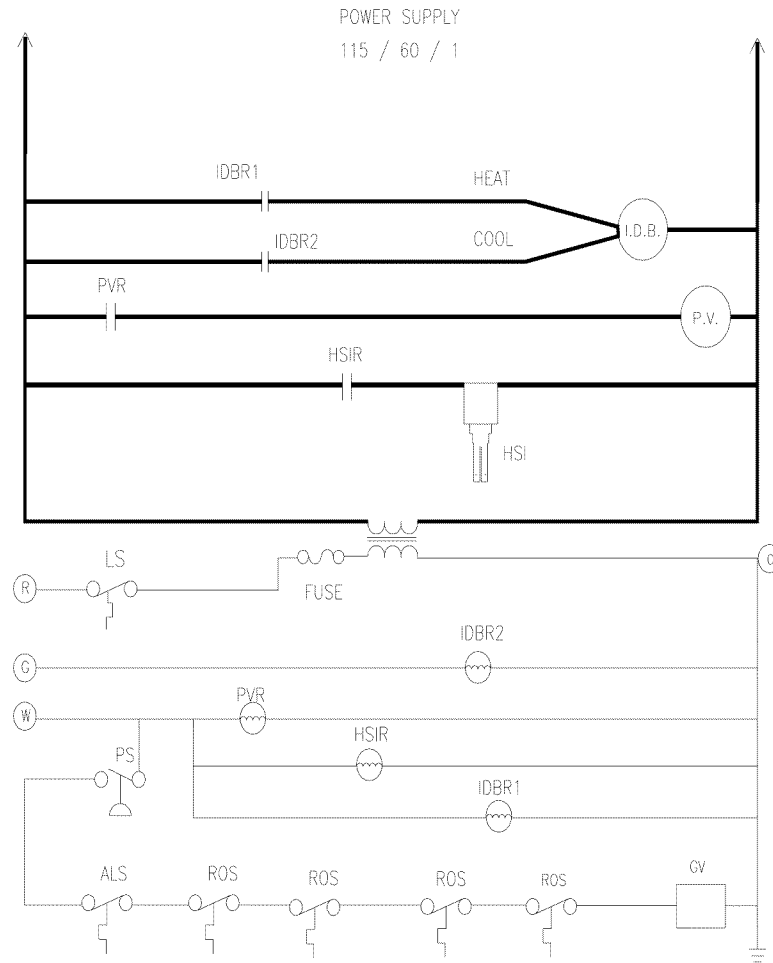

- ALS - AUXILIARY LIMIT SWITCH
- DS - DOOR SWITCH
- FS - FLAME SENSOR
- GV - GAS VALVE
- HSI - HOT SURFACE IGNITOR
- HSIR - HOT SURFACE IGNITOR RELAY
- IDB - INDOOR BLOWER
- IDBR - INDOOR BLOWER RELAY
- LS - LIMIT SWITCH
- PS - PRESSURE SWITCH
- PV - POWER VENTOR
- PVR - POWER VENT RELAY
- ROS - ROLLOUT SWITCH

WIRING CODE  
FACTORY WIRING  
HIGH VOLTAGE **—**  
LOW VOLTAGE **—**

WIRE	COLOR	CODE
B	BLACK	(1)
BL	BLUE	(4)
BR	BROWN	(7)
G	GREEN	(8)
O	ORANGE	(6)
PK	PINK	(9)
P	PURPLE	(5)
W	WHITE	(0)
Y	YELLOW	(3)
R	RED	(2)

NOTES:

1. REPLACEMENT WIRE MUST BE THE SAME SIZE AND TYPE OF INSULATION AS ORIGINAL (105°C)
2. WARNING CABINET MUST BE PERMANENTLY GROUNDED AND CONFORM TO N.E.C. & LOCAL CODES.

GMPE ONLY

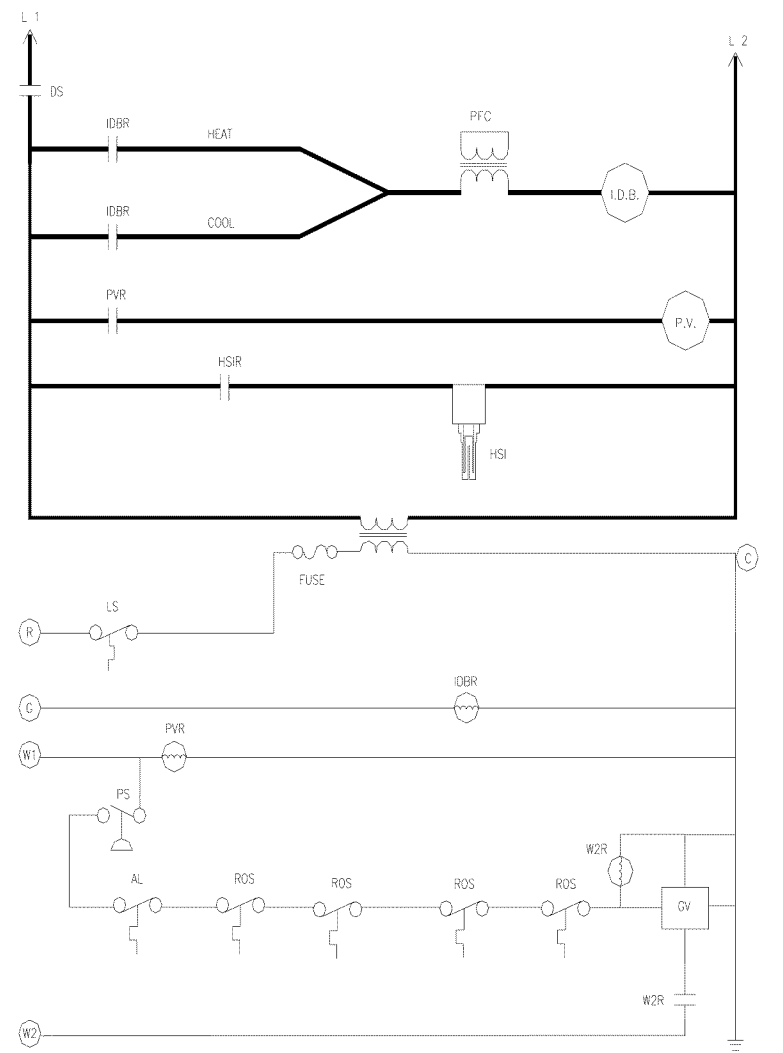
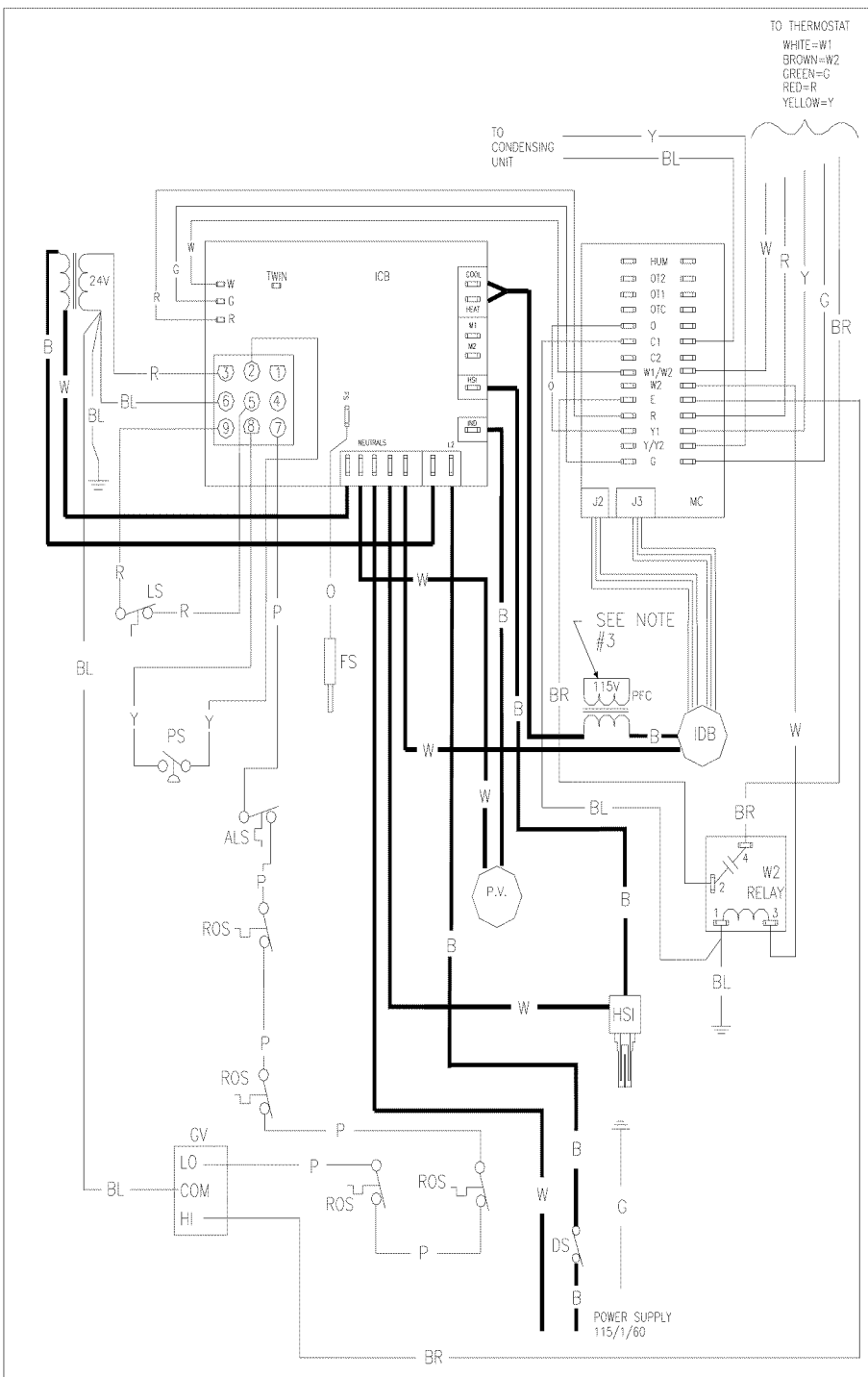

PFC - POWER-FACTOR CHOKE TRANSFORMER  
 ALS - AUXILIARY LIMIT SWITCH  
 DS - DOOR SWITCH  
 CR - COOL RELAY  
 HR - HEAT RELAY  
 FS - FLAME SENSOR  
 GV - GAS VALVE  
 HSI - HOT SURFACE IGNITOR  
 ICB - INTEGRATED CIRCUIT BOARD  
 IDB - INDOOR BLOWER  
 IDBR - INDOOR BLOWER RELAY  
 LS - LIMIT SWITCH  
 PS - PRESSURE SWITCH  
 PV - POWER VENTILATOR  
 PVR - POWER VENT RELAY  
 ROS - ROLLOUT SWITCH  
 MC - MOTOR CONTROLLER  
 TR - TRANSFORMER  
 HSR - HOT SURFACE IGNITOR RELAY  
 W2R - W2 RELAY

WIRING CODE

FACTORY WIRING  
 HIGH VOLTAGE **————**  
 LOW VOLTAGE **-----**

FIELD WIRING  
 HIGH VOLTAGE **————**  
 LOW VOLTAGE **-----**

WIRE COLOR CODE

B	BLACK	PK	PINK
BL	BLUE	P	PURPLE
BR	BROWN	W	WHITE
G	GREEN	Y	YELLOW
O	ORANGE	R	RED

- NOTES:
1. REPLACEMENT WIRE MUST BE THE SAME SIZE AND TYPE OF INSULATION AS ORIGINAL (105°C)
  2. WARNING CABINET MUST BE PERMANENTLY GROUNDED AND CONFORM TO N.E.C. & LOCAL CODES.
  3. PFC USED ON GMPE100 & 125 MODELS ONLY.

# LIGHTING INSTRUCTIONS

These instructions are also on the furnace

## FOR YOUR SAFETY READ BEFORE OPERATING



### WARNING



If you do not follow these instructions exactly, a fire or explosion may result causing property damage, personal injury or loss of life.

A. This appliance does not have a pilot. It is equipped with an ignition device which automatically lights the burners. Do not try to light the burners by hand.

B. BEFORE OPERATING smell around the appliance area for gas. Be sure to smell next to the floor because some gas is heavier than air and will settle on the floor.

#### WHAT TO DO IF YOU SMELL GAS

- Do not try to light any appliance.
- Do not touch any electric switch; do not use any telephone in your building.
- Immediately call your supplier from a neighbor's phone. Follow the gas suppliers instructions.

- If you cannot reach your gas supplier, call the fire department.

C. Use only your hand to move the gas control switch or knob. Never use tools. If the gas control switch or knob will not operate, don't try to repair it, call a qualified service technician. Force or attempted repair may result in a fire or explosion.

D. Do not use this appliance if any part has been under water. Immediately call a qualified service technician to inspect the appliance and to replace any part of the control system and any gas control which has been under water.

**WARNING:** Improper installation, adjustment, alteration, service or maintenance can cause injury or property damage. Refer to the user's information manual provided with this furnace. For assistance or additional information consult a qualified installer, service agency or the gas supplier.

This furnace must be installed in accordance with the manufacturer's instructions and local codes. In the absence of local codes follow the National Fuel Gas Code, ANSI Z223.1.

## OPERATING INSTRUCTIONS

1. STOP! Read the safety information above on this label.
2. Set the thermostat to lowest setting.
3. Turn off all electric power to the appliance.
4. This appliance is equipped with an automatic ignition system which automatically lights the burners. Do not try to light the burners by hand.
5. Remove control access panel.
6. Move the gas control switch or knob to "OFF".

7. Wait five (5) minutes to clear out any gas. If you then smell gas, STOP! Follow "B" in the safety information above on this label. If you don't smell gas, go to the next step.
8. Move the gas control switch or knob to "ON".
9. Replace control access panel.
10. Turn on all electric power to the appliance.
11. Set the thermostat to the desired setting.
12. If the appliance will not operate, follow the instructions "To Turn Off Gas To Appliance" and call your service technician or gas supplier.

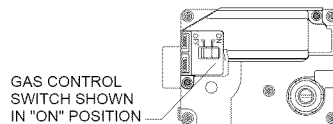
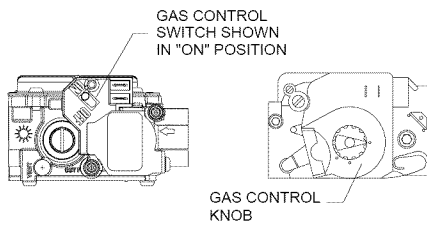

For indoor installation.

PGB & PGJ  
For outdoor installation only.

**WARNING:** If not installed, operated and maintained in accordance with the manufacturer's instructions, this product could expose you to substances in fuel combustion which can cause death or serious illness and which are known to the State of California to cause cancer, birth defects or other reproductive harm.

This product contains fiberglass insulation. Fiberglass insulation contains a chemical known by the State of California to cause cancer.

## TO TURN OFF GAS TO APPLIANCE

1. Set the thermostat to its lowest setting.
2. Turn off all electric power to the appliance if service is to be performed.
3. Remove control access panel.
4. Move the gas control switch or knob to "OFF". Do not force.
5. Replace control access panel.

**FOR YOUR SAFETY** Do not store or use gasoline or other flammable vapors and liquids in the vicinity of this or any other appliance.

B14933-228

## EXTERIOR MASONRY CHIMNEYS - CATEGORY I furnaces only.

An exterior masonry chimney is defined as a “Masonry chimney exposed to the outdoors on one or more sides below the roof line.”

The ability to use a clay lined masonry chimney depends on a parameter not associated with interior chimneys. This variable is the geographic location of the installation. Researchers have discovered that the winter design temperatures have a direct impact on the suitability of this type of venting.

In most situations, except in some Gulf Coast areas and Southern California, the existing masonry chimneys will require a properly sized metallic liner.

### DEFINITION of TERMS

**Fan Assisted Combustion System** - An appliance equipped with an integral mechanical means to either draw or force the products of combustion through the combustion chamber and/or the heat exchanger.

**FAN Min.** - Refers to the minimum appliance input rating of a Category I appliance with a fan assisted combustion system that could be attached to the vent.

**FAN Max.** - Refers to the maximum input rating of a Category I with a fan assisted combustion system that could be attached to the vent.

**NAT. Max.** - Refers to the maximum appliance input of a Category I appliance equipped with a draft hood that could be attached to the vent. There are no minimum appliance ratings for draft hood equipped appliances.

**FAN + FAN** - Refers to the maximum combined rating of two (2) or more fan assisted appliances attached to a common vent.

**FAN + NAT** - Refers to the maximum combined input rating of one or more fan-assisted appliance and one or more draft hood

equipped appliances attached to the common vent.

**NAT + NAT** - Refers to the maximum combined input rating of two (2) or more draft hood equipped appliances attached to the common vent.

**NA** - Means not applicable due to physical or geometric constraints.

**Vent** - A passageway used to convey flue gases from gas utilization equipment, or their vent connectors, to the outside atmosphere.

**Vent Connector** - The pipe or duct that connects a fuel-gas burning appliance to a vent or chimney.

**Flue Collar** - That portion of an appliance designed for the attachment of a draft hood, vent connector or venting system.

**Categorized Vent Diameter** - The minimum permissible vent diameter for Category I appliance to maintain a non-positive vent static pressure when tested according to nationally recognized standards.

## GENERAL VENTING REQUIREMENTS

The requirements contained herein apply to both Category I draft hood equipped and fan assisted combustion appliances. At no time should a venting system listed for a Category II, III, or IV appliance be sized with these tables. The alternate sizing methods described in the National Fuel Gas Code (NFPA54/ANSI Z223.1-1996) may also be used to size the venting system for a draft hood equipped appliance. At this time, alternate sizing methods have not been developed for fan assisted appliances. Therefore, until engineering data is developed to allow alternate sizing methods for Category I fan assisted appliances, the vent tables must be used.

1. The venting tables included in this instruction apply to vents and chimneys internal to the structure below the roof line. Exterior chimneys or vents not enclosed by the structure or chase below the roof line may experience continuous condensation depending on locality. Consult local gas utility, appliance manufacturer and/ or local codes. A chimney with one (1) or more sides exposed to the outside of the structure is considered to be an exterior chimney. A type B or listed chimney lining system passing through an unused masonry chimney flue is not considered to be exposed to the outdoors.

2. If the vent or connector size determined from the tables is smaller than the appliance draft hood outlet or flue collar, the smaller size may be used provided:

- a) The total vent height "H" is at least 10 ft.
- b) Vents or connectors for appliance outlets or flue collars 12" in diameter or smaller are not reduced more than one table size (e.g. 12" to 10" is a one size reduction).
- c) The maximum capacity listed in the tables for a fan assisted appliance is reduced by 10% (0.90 X maximum capacity).
- d) The draft hood is greater than 4" in diameter. Do not connect a 3" diameter vent or connector to a 4" diameter draft hood outlet. **THIS PROVISION DOES NOT APPLY TO FAN ASSISTED APPLIANCES.**

3. Single appliance venting configurations with zero lateral lengths, Tables 1 & 2, are assumed to have no elbows in the vent system. For all other configurations, the vent system is assumed to have two (2) 90° elbows. For each additional 90° elbow or equivalent (two

45° elbows are equivalent to one 90° elbow) beyond two, the maximum capacity listed in the venting table should be reduced by 10% (0.90 X maximum listed capacity).

4. The common venting Tables 3, 4, 7 & 8 were generated using a maximum horizontal vent connector length of 1 1/2 feet (18") for each inch of connector diameter as follows;

CONNECTOR DIA.	MAXIMUM HORIZONTAL CONNECTOR LENGTH
3 inches	4 1/2 feet
4 inches	6 feet
5 inches	7 1/2 feet
6 inches	9 feet
7 inches	10 1/2 feet
8 inches	12 feet
9 inches	13 1/2 feet
10 inches	15 feet

The vent connector should be routed to the vent utilizing the shortest possible route. Connectors with longer horizontal lengths than those listed above are possible under the following conditions:

- a) The maximum capacity (FAN MAX. OR NAT MAX.) or the vent connector shall be reduced 10% for each additional multiple of the length listed above. For example, the maximum length listed above for a 4 inch connector is 6 feet. With a connector greater than 6 feet but not exceeding 12 feet the maximum capacity must be reduced by 10% (0.90 X maximum vent connector capacity). With a vent connector length greater than 12 feet but not exceeding 18 feet, the maximum capac-

ity must be reduced by 20% (0.80 X maximum vent capacity).

- b) The minimum capacity (FAN MIN.) shall be determined by referring to the corresponding single appliance table (tables 1 & 2). In this case, for each appliance the entire vent connector and common vent from the appliance to the vent termination would be treated as a single appliance vent, as if the other appliances were not present.

5. If vent connectors are combined prior to entering the common vent, the maximum common vent capacity listed in the common vent tables must be reduced by 10%, the equivalent of one (1) 90° elbow. See figure 7. The horizontal length of the common vent connector or manifold (L) should not exceed 1 1/2 feet (18 inches) for each inch of common vent diameter.

6. If the common vent is offset as shown in figure 8, the maximum common vent capacity listed in the common venting tables should be reduced by 20%, the equivalent of two (2) 90° elbows. The horizontal length of the offset shall not exceed 1 1/2 feet for each inch of common vent diameter.

7. The common vent diameter must always be at least as large as the largest vent connector diameter. All interconnection fittings must also be the same size as the common vent.

8. Type B gas vents shall terminate above the roof surface with a listed cap or listed roof assembly according to their respective listing and the vent manufacturer's instructions.

**VENT CAPS 12" AND SMALLER**

Listed gas venting systems using listed vent caps 12" and smaller may terminate according to the VENT TERMINATION TABLE. (See figure 1)

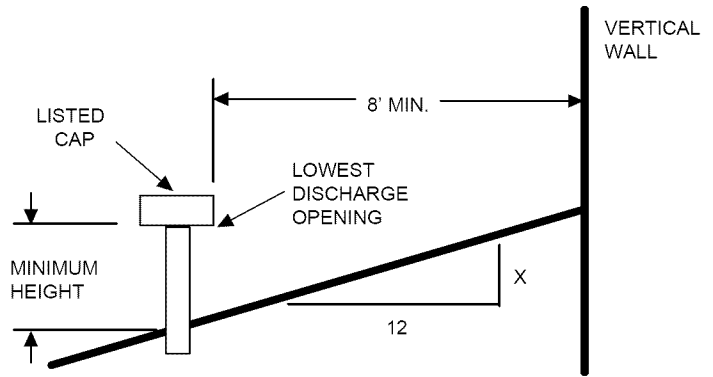

THE VENT TERMINATION SHOULD NOT BE LESS THAN 8 FT. FROM A VERTICAL WALL  
**FIGURE 1 -VENT CAPS 12" OR SMALLER**

**GAS VENT TERMINATION TABLE**

ROOF PITCH	MINIMUM HEIGHT
FLAT TO 7 / 12	1.0 FEET *
OVER 7 / 12 TO 8 / 12	1.5 FEET
OVER 8 / 12 TO 9 / 12	2.0 FEET
OVER 9 / 12 TO 10 / 12	2.5 FEET
OVER 10 / 12 TO 11 / 12	3.25 FEET
OVER 11 / 12 TO 12 / 12	4.0 FEET
OVER 12 / 12 TO 14 / 12	5.0 FEET
OVER 14 / 12 TO 16 / 12	6.0 FEET
OVER 16 / 12 TO 18 / 12	7.0 FEET
OVER 18 / 12 TO 20 / 12	7.5 FEET
OVER 20 / 12 TO 21 / 12	8.0 FEET

\* This requirement covers most installations

9. Use sea level input rating when determining maximum capacity for high altitude installation. Use actual input rating for determining minimum capacity for high altitude installation.
10. No portion of the vent system can extend into, or pass through any circulating air duct or plenum.
11. All vent pipe passing through floors, walls and ceilings must be installed with the listed clearance to combustible materials and be fire stopped according to local codes. In the absence of local codes refer to NFPA (Z223.1).
12. Vent connectors serving Category I appliances shall not be connected to any portion of mechanical draft systems operation under positive pressure such as Category III or IV Venting Systems.

13. A Category I appliance must never be connected to a chimney servicing a solid fuel appliance. If fireplace chimney flue is used to vent this appliance, the fireplace opening must be permanently sealed.
14. A vent connector shall be supported without any dips or sags and shall slope a minimum of 1/4" per linear foot of connector, back towards the appliance.
15. Vent connector shall be firmly attached to draft hood outlets or flue collars by sheet metal screws or other approved means, except vent connectors of type B vent material that shall be assembled according to the manufacturer's instructions. Joints between sections of single wall connector pipes shall be fastened by sheet metal screws or other approved means.
16. When the vent connector used for Category I appliances must be located in or pass through a crawl space or other area which may be cold, that portion of the vent connector shall be of listed double wall type B vent material or material having equivalent insulation qualities.
17. The entire length of single wall metal vent connector shall be readily accessible for inspection, cleaning or replacement.
18. For appliances with more than one input rate, the minimum vent or connector (Fan - Min) capacity determined from the tables shall be less than the lowest input rating and the maximum vent or connector (Fan or Nat Max) capacity determined from the tables shall be greater than the highest appliance input rating.
19. For single appliance vents:
  - a) If the vertical vent or tile lined chimney has a larger diameter or flow area than the vent connector, use the vertical vent diameter to determine the minimum vent capacity and vent connector diameter to determine the maximum vent capacity. The flow area of the vertical, however, shall not exceed 7 times the flow area

of the listed appliance categorized vent area, draft hood outlet area or flue collar area unless designed according to approved engineering methods. See table 9 for calculated areas.

For multiple appliance vents:

- b) The flow area of the largest section of a vertical vent or chimney shall not exceed 7 times the smallest listed appliance categorized vent area, flue area, or draft hood outlet area unless designed according to approved engineering methods. See table for calculated areas.

Maximum vent or tile lined chimney flow area  

$$= \frac{TT(D^*)^2 \times 7}{4}$$

\*Draft hood outlet diameter, flue collar diameter or listed appliance categorized vent diameter.

- c) In no case, shall the vent connector be upsized more than 2 consecutive table size diameters over the size of the draft hood outlet, flue collar or listed categorized vent. Example: An appliance with a 4 inch diameter flue outlet collar or draft hood connector cannot be vented with a connector larger than 6 inches.

20. Masonry chimneys used to vent Category I central furnaces must either be tile lined or lined with a listed metal lining system or dedicated gas vent. Unlined chimneys are prohibited. (See note 1)

21. A fan assisted furnace may be common vented into an existing chimney provided;
  - a) The chimney is currently serving at least one draft hood appliance.

SINGLE APPLIANCE VENTING OF A FAN ASSISTED FURNACE INTO A TILE LINED, MASONRY CHIMNEY IS PROHIBITED. THE CHIMNEY MUST FIRST BE LINED WITH EITHER TYPE B VENT SIZED IN ACCORDANCE WITH TABLES 1 OR 2 OR A LISTED SINGLE WALL, METAL LINING SYSTEM, SIZED IN ACCORDANCE WITH NOTE 22.

22. Listed, corrugated metallic chimney liner systems in masonry chimneys shall be sized by using tables 3 or 4 for common venting with the maximum capacity reduced by 20% (0.80 X maximum capacity) and the minimum capacity shown in the applicable table. Corrugated metal vent systems installed with bends or offsets require additional reduction of the vent maximum capacity (See note 6).
23. For multiple units of gas utilization equipment all located on one floor, available total height "H" is measured from the highest draft hood outlet or flue collar up to the level of the cap or terminal. Connector rise "R" is taken from the measured outlet or flue collar to the level where the vent gas streams come together. (Not applicable for multi-story).
24. For multi-story installations, available total height for each segment of the system "H" is the vertical distance between the draft hood outlet or flue collar entering that segment and the centerline of the next higher interconnection tee (See Figure 13).
25. The size of the lowest connector and of the vertical vent leading to the lowest interconnection of a multi-story system must be according to table 1 or 2, for available total height "H" up to the lowest connection (See figure 14).
26. Common vents in multi-story systems should be type B and have no offsets.
27. Numbers followed by an asterisk(\*) in Table 5 & 6, indicate the possibility of continuous condensation, depending upon locality. Consult appliance manufacturer, local serving gas supplier, and/or authority having jurisdiction.
28. In a single run of vent or vent connector, more than one diameter and type of pipe are permitted to be used, provided that all the sizes are permitted by the tables.
29. If the desired vent height and connector rise and/or lateral are between the table entries, linear interpolation is permitted for calculation of the permissible appliance input ratings. Extrapolation beyond the table entries is not recommended.
30. All combinations of pipe sizes, single wall, and double wall metal pipe are allowed within any connector run(s) or within the common vent provided ALL of the appropriate tables permit All of the desired sizes and type of pipe, as if they were used for the entire length of the subject connector vent. If a single wall and type B double wall pipe are used for vent connectors, the common vent must be sized using table 4.
31. Locate the draft hood outlet or flue collar of the smallest input appliance closest to or under the common vent.
32. When the vent table permits more than one diameter of pipe to be used for a connector or vent, the smallest permitted diameter should be preferred.



## EXAMPLES USING SINGLE APPLIANCE VENTING TABLE

### Single Fan Assisted Appliance

Suppose an installer has an 80,000 Btu / hr. input fan assisted appliance that must be installed using 10 ft. of lateral connector attached to a 30 ft. high Type B vent. Two 90° elbows are needed for the installation. Can a single wall metal vent connector be used for this installation?

**Solution** -Table 2 refers to the use of single wall metal vent connectors with Type B vent. In the first column find the row associated with a 30ft. height and a 10 ft. lateral. Read across this row, looking at the “Fan Min” and “Fan Max” columns, to find that a 3” diameter single wall metal connector is not recommended. Moving to the next larger size single wall connector (4”) we find that a 4” diameter single wall connector has a recommended maximum vent capacity of 91,000 Btu / hr. and a recommended maximum vent capacity of 144,000 Btu / hr. The 80,000 Btu / hr. fan assisted appliance is outside this range, so we conclude that a single wall connector cannot be used to vent this appliance using 10ft. of lateral for the connector.

However, we see that if the 80,000 Btu / hr. input appliance could be moved within 5ft. of the vertical vent, then a 4” single wall metal connector could be used for this appliance. Table 2 shows the acceptable range of vent capacities for a 4” vent with 5ft. of lateral to be between 72,000 Btu / hr. and 157,000 Btu / hr.

If the appliance cannot be moved closer to the vertical vent, then Type B vent could be used as the connector material. In this case, Table 1 shows that for a 30ft. high vent with 10ft. of lateral, the acceptable range of vent capacities for a 4” diameter vent attached to a fan assisted appliance are between 37,000 Btu / hr. and 150,000 Btu / hr.

### Common Venting a Draft Hood Water Heater with a Fan Assisted Furnace

In this case, a 35,000 Btu / hr draft hood equipped water heater with a 2ft. connector rise is to be common vented with a 100,000 Btu / hr fan assisted furnace with a 3ft. connector rise. The common vent consists of a 30ft rise of type B vent. What are the recommended vent diameters for each connector and the common vent? *Solution*-TABLE 4

**Water Heater vent connector diameter** - Let us assume the installer would like to use a single wall metal vent connector. Using table 4, Vent Connector Capacity, read down the total vent height “H” column to 30ft. and read across the 2ft. connector rise “R” row to the first Btu / hr rating in the “Nat Max” column that is equal to or greater than the water heater input rating. The table shows that a 3” connector has a maximum input rating of 37,000 Btu / hr. Since this is greater than the water heater input rating, a 3” vent connector is adequate. Furthermore, since the water heater is equipped with a draft hood, there are no minimum input rating restrictions.

**Furnace vent connector diameter** - Again, let us assume the installer would like to use a single wall vent connector. Using table 4, Vent connector capacity, read down the total vent height “H” column to 30ft. and across the 3ft. connector rise “R” row. Since the furnace has a fan assisted combustion system, find the first Fan Max column with a Btu / hr rating greater than the furnace input rating. The 4” vent connector has a maximum input rating of 119,000 Btu / hr and a minimum input rating of 85,000 Btu / hr. The 100,000 Btu / hr furnace in this example falls within this range, so a 4” connector is adequate. If the furnace would have had an input rating of 80,000 Btu / hr, than a type B vent connector (see Table 3) would have to be used to meet the minimum capacity limit.

**Common vent diameter** - The total input to the common vent is 135,000 Btu / hr. Using Table 4, common vent capacity, read down the total vent height “H” column to 30ft and across this row to find the smallest vent diameter in the Fan + Nat column that has a Btu / hr rating equal to or greater than 135,000 Btu / hr. The 4” common vent has a capacity of 132,000 Btu / hr and the 5” common vent has a capacity of 202,000 Btu / hr. Therefore, the 5” common vent should be used in this example.

**Summary** - In this example, the installer may use a 3” diameter single wall metal vent connector for the water heater and a 4” single wall metal vent connector for the furnace. The common vent should be a 5” diameter type B vent.

**Common Venting into a Masonry Chimney** - In this case, a 35,000 Btu / hr input 4” diameter draft hood equipped water heater with 2ft of connector rise and 4ft of horizontal length is to be common vented with a 100,000 Btu / hr fan assisted furnace with a 4” diameter flue collar, 3ft of connector rise and 6ft of horizontal length. The common vent is an 8” X 12” tile lined chimney that is 30ft tall. What are the recommended vent diameters for each connector? Is this an acceptable installation? **Solution-** Table 8 is used to size common venting installations involving single wall connectors into masonry chimneys.

**Water heater vent connector diameter** - Using Table 8, vent connector capacity, read down the total vent height “H” column to 30ft and read across the 2ft connector rise “R” row to the first Btu / hr rating in the Nat Max column that is equal to or greater than the water heater input rating. The table shows that a 3” vent connector has a maximum input of only 31,000 Btu / hr while a 4” vent connector has a maximum input of 57,000 Btu / hr. A 4” vent connector must therefore be used.

**Furnace vent connector diameter** - Using table 8 vent connector capacity, read down the total vent height “H” column to 30ft and across the 3ft connector rise “R” row. Since the furnace has a fan assisted combustion system, find the first Fan Max column with a Btu / hr rating greater than the furnace input rating. The 4” vent connector has a maximum input rating of 127,000 Btu / hr and a minimum input rating of 95,000 Btu / hr. The 100,000 Btu / hr furnace in this example falls within this range, so a 4” connector is adequate.

**Masonry Chimney** - From Table 9, the equivalent area for a nominal liner size of 8” X 12” is 63.6 sq. in. Using Table 8, common venting capacity, read down the Fan + Nat column under the minimum internal area of chimney value of 63 to the row for 30ft height to find a capacity value of 739,000 Btu / hr. The combined input rating of the furnace and water heater of 135,000 Btu / hr, is less than the table value, so this is an acceptable installation.

Note 19 requires the common vent area to be no greater than 7 times the flow area of the smallest appliance outlet area. Both appliances in this installation use 4” diameter outlets. From Table 9, the equivalent area for an inside diameter of 4” is 12.2 sq. in. Seven times 12.2 is 85.4, which is greater than 63.6, so this configuration is acceptable.

Note 1 specifies that table values are for vents or chimneys that are not exposed to the outdoors below the roof line. If the masonry chimney in this case were exposed below the roofline, then the appliance manufacturer, local gas utility, and/or authority having jurisdiction must be consulted.

# TYPICAL VENTING APPLICATIONS

TABLE 1 should be used when Type B vent is used for both the vent connector and the vertical vent.

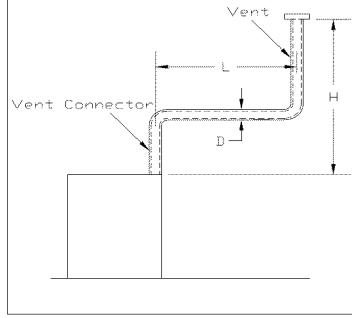

TABLE 2 should be used when a single wall metal vent connector is attached to Type B vertical vent.

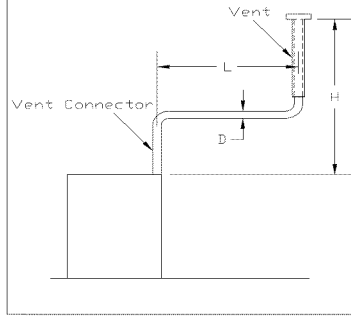

TABLE 3 should be used when Type B vent connectors are attached to a Type B common vent.

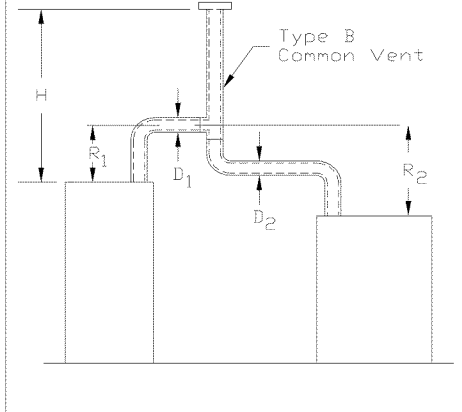
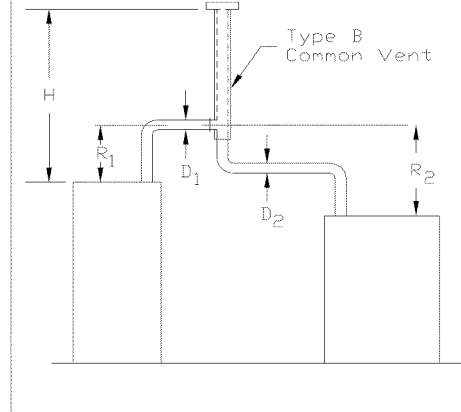
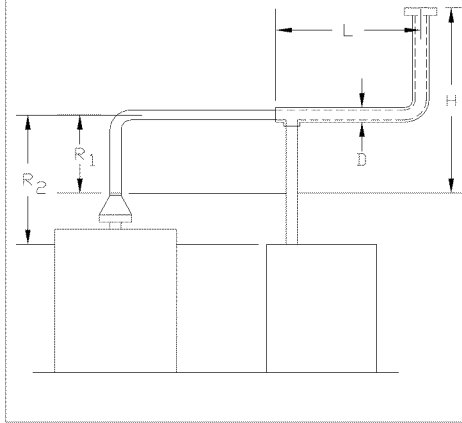

TABLE 4 should be used when single wall metal vent connectors are attached to a Type B common vent.



Schematic Diagram showing a typical manifolded common vent section "L" of the vent connector. (See Note 5)



Schematic Diagram showing offset in the common vent section of the vertical vent. (See Note 6)

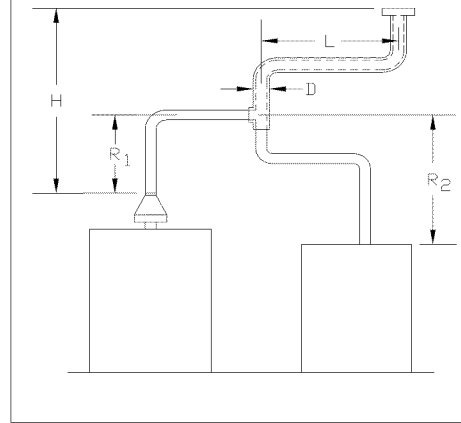

TABLE 5 shall be used when Type B double wall vent connector is attached to the tile lined masonry chimney.

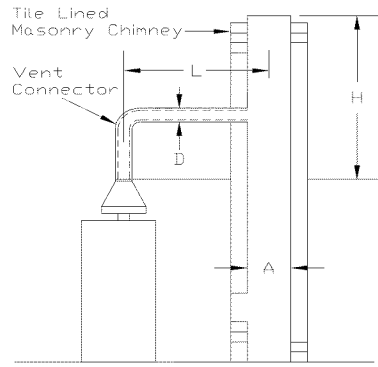

TABLE 6 shall be used when a single wall metal vent connector is attached to a tile lined masonry chimney.

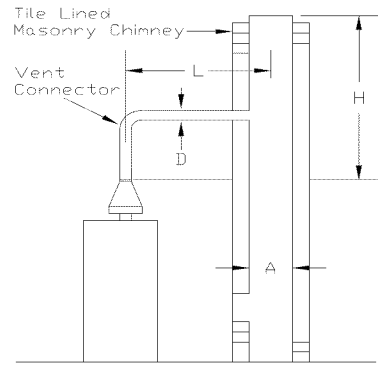

TABLE 7 shall be used when Type B double wall vent connectors are attached to a tile lined masonry chimney.

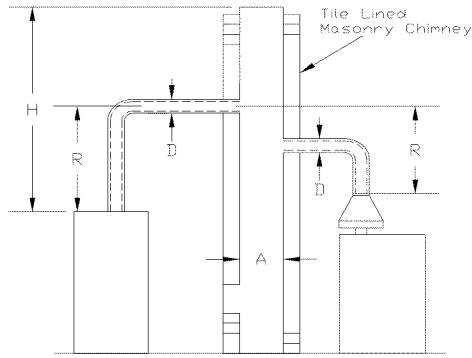
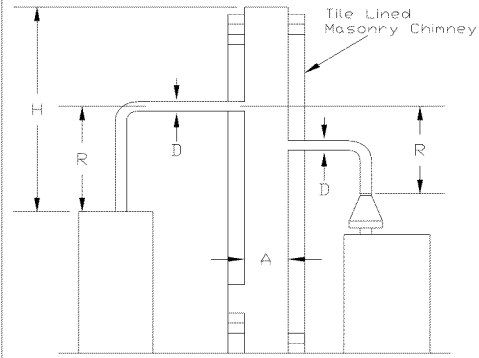

TABLE 8 shall be used when single wall metal vent connectors are attached to a tile lined masonry chimney.



### Masonry Chimney Liner Dimensions

**TABLE 9 With Circular Equivalents**

Nominal Liner Size - Inches	Inside Dimensions In Liner - Inches	Inside Diameter or Equivalent Diameter - Inches	Equivalent Area Square Inches
4 x 8	2 1/2 x 6 1/2	4	12.2
		5	19.6
		6	28.3
		7	38.3
8 x 8	6 3/4 x 6 3/4	7.4	42.7
		8	50.3
8 x 12	6 1/2 x 10 1/2	9	63.6
		10	78.5
12 x 12	9 3/4 x 9 3/4	10.4	83.3
		11	95
12 x 16	9 1/2 x 13 1/2	11.8	107.5
		12	113
		14	153.9
16 x 16	13 1/4 x 13 1/4	14.5	162.9
		15	176.7
16 x 20	13 x 17	16.2	206.1
		18	254.4
20 x 20	16 3/4 x 16 3/4	18.2	260.2
		20	314.1
		22	380.1

When liner sizes differ dimensionally from those shown in Table 9 equivalent diameters may be from published tables for square and rectangular ducts of equivalent carrying capacity or by other engineering methods.

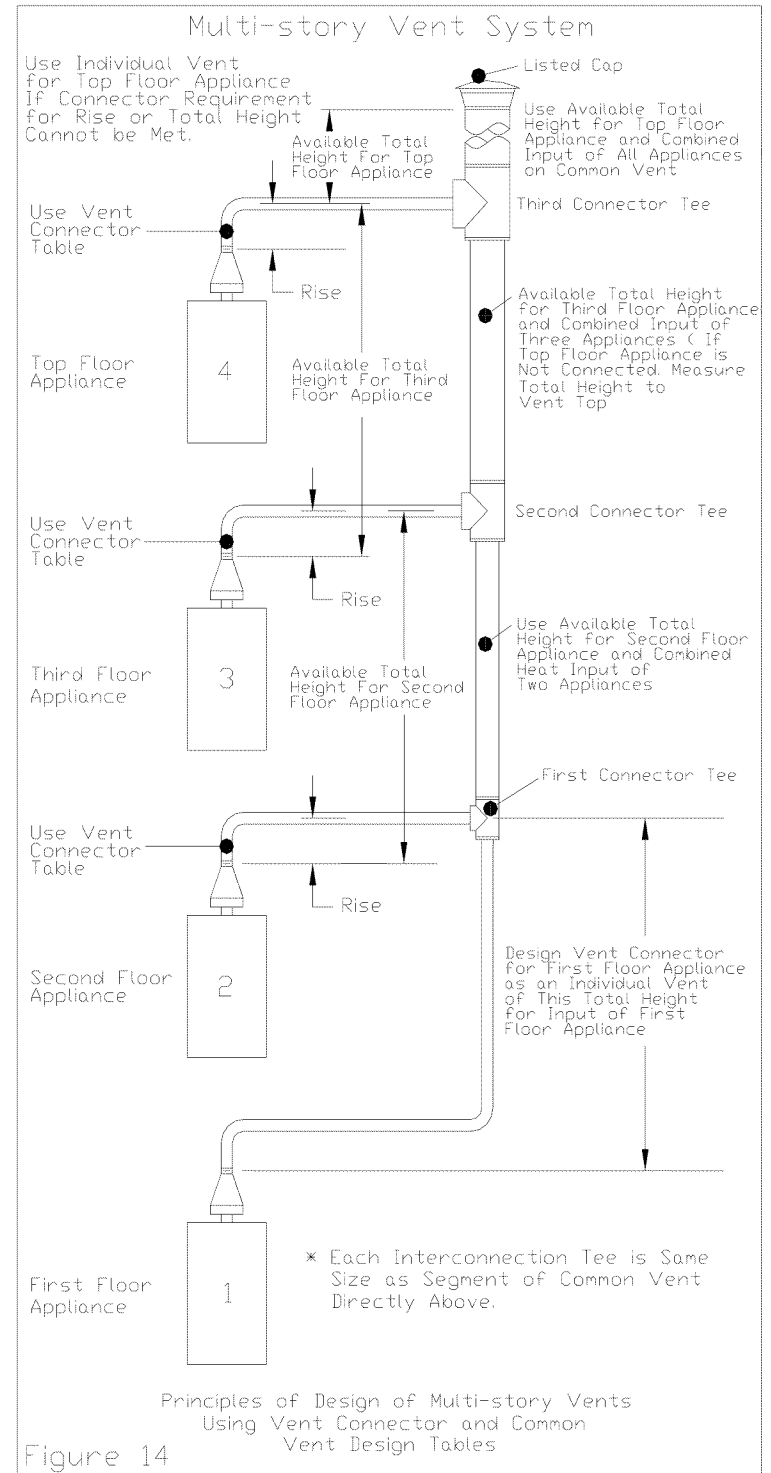
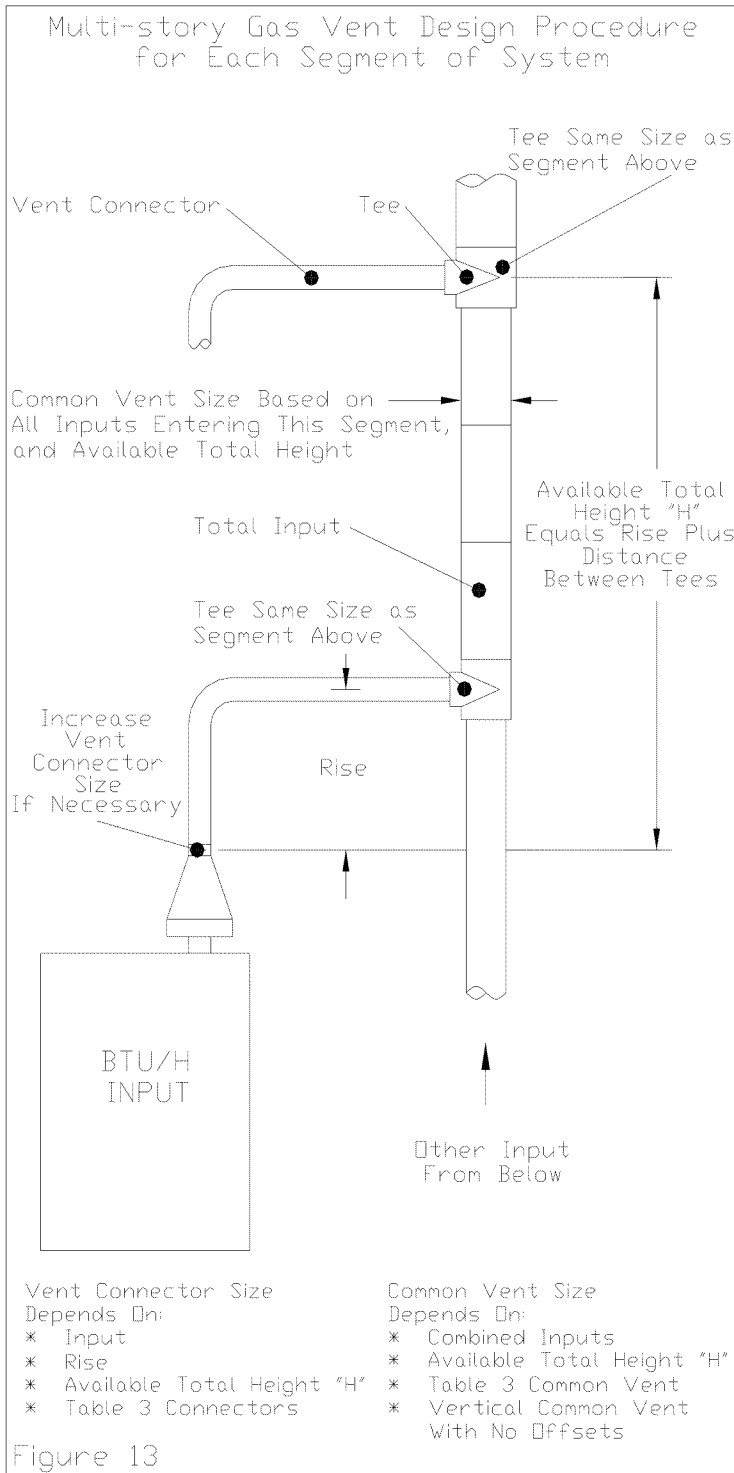

# VENT TABLES

Capacity of Type B Double-Wall Vents with Type B Double-Wall Connectors  
Serving a Single Category I Appliance

TABLE 1

		Vent and Connector Diameter - D (inches)																	
		3"		4"		5"		6"		7"		8"							
Height H (ft)	Lateral L (ft)	Appliance Input Rating in Thousands of Btu Per Hour																	
		FAN		NAT	FAN		NAT	FAN		NAT	FAN		NAT	FAN		NAT			
		Min	Max	Max	Min	Max	Max	Min	Max	Max	Min	Max	Max	Min	Max	Max	Min	Max	Max
6	0	0	78	46	0	152	86	0	251	141	0	375	205	0	524	285	0	698	370
	2	13	51	36	18	97	67	27	157	105	32	232	157	44	321	217	53	425	285
	4	21	49	34	30	94	64	39	153	103	50	227	153	66	316	211	79	419	279
	6	25	46	32	36	91	61	47	149	100	59	223	149	78	310	205	93	413	273
8	0	0	84	50	0	165	94	0	276	155	0	415	235	0	583	320	0	780	415
	2	12	57	40	16	109	75	25	178	120	28	263	180	42	365	247	50	483	322
	5	23	53	38	32	103	71	42	171	115	53	255	173	70	356	237	83	473	313
	8	28	49	35	39	98	66	51	164	109	64	247	165	84	347	227	99	463	303
10	0	0	88	53	0	175	100	0	295	166	0	447	255	0	631	345	0	847	450
	2	12	61	42	17	118	81	23	194	129	26	289	195	40	402	273	48	533	355
	5	23	57	40	32	113	77	41	187	124	52	280	188	68	392	263	81	522	346
	10	30	51	36	41	104	70	54	176	115	67	267	175	88	376	245	104	504	330
15	0	0	94	58	0	191	112	0	327	187	0	502	285	0	716	390	0	970	525
	2	11	69	48	15	136	93	20	226	150	22	339	225	38	475	316	45	633	414
	5	22	65	45	30	130	87	39	219	142	49	330	217	64	463	300	76	620	403
	10	29	59	41	40	121	82	51	206	135	64	315	208	84	445	288	99	600	386
	15	35	53	37	48	112	76	61	195	128	76	301	198	98	429	275	115	580	373
20	0	0	97	61	0	202	119	0	349	202	0	540	307	0	776	430	0	1057	575
	2	10	75	51	14	149	100	18	250	166	20	377	249	33	531	346	41	711	470
	5	21	71	48	29	143	96	38	242	160	47	367	241	62	519	337	73	697	460
	10	28	64	44	38	133	89	50	229	150	62	351	228	81	499	321	95	675	443
	15	34	58	40	46	124	84	59	217	142	73	337	217	94	481	308	111	654	427
	20	48	52	35	55	116	78	69	206	134	84	322	206	107	464	295	125	634	410
30	0	0	100	64	0	213	128	0	374	220	0	587	336	0	853	475	0	1173	650
	2	9	81	56	13	166	112	14	283	185	18	432	280	27	613	394	33	826	535
	5	21	77	54	28	160	108	36	275	176	45	421	273	58	600	385	69	811	524
	10	27	70	50	37	150	102	48	262	171	59	405	261	77	580	371	91	788	507
	15	33	64	NR	44	141	96	57	249	163	70	389	249	90	560	357	105	765	490
	20	56	58	NR	53	132	90	66	237	154	80	374	237	102	542	343	119	743	473
	30	NR	NR	NR	73	113	NR	88	214	NR	104	346	219	131	507	321	149	702	444
50	0	0	101	67	0	216	134	0	397	232	0	633	363	0	932	518	0	1297	708
	2	8	86	61	11	183	122	14	320	206	15	497	314	22	715	445	26	975	615
	5	20	82	NR	27	177	119	35	312	200	43	487	308	55	702	438	65	960	605
	10	26	76	NR	35	168	114	45	299	190	56	471	298	73	681	426	86	935	589
	15	59	70	NR	42	158	NR	54	287	180	66	455	288	85	662	413	100	911	572
	20	NR	NR	NR	50	149	NR	63	275	169	76	440	278	97	642	401	113	888	556
	30	NR	NR	NR	69	131	NR	84	250	NR	99	410	259	123	605	376	141	844	522
100	0	NR	NR	NR	0	218	NR	0	407	NR	0	665	400	0	997	560	0	1411	770
	2	NR	NR	NR	10	194	NR	12	354	NR	13	566	375	18	831	510	21	1155	700
	5	NR	NR	NR	26	189	NR	33	347	NR	40	557	369	52	820	504	60	1141	692
	10	NR	NR	NR	33	182	NR	43	335	NR	53	542	361	68	801	493	80	1118	679
	15	NR	NR	NR	40	174	NR	50	321	NR	62	528	353	80	782	482	93	1095	666
	20	NR	NR	NR	47	166	NR	59	311	NR	71	513	344	90	763	471	105	1073	653
	30	NR	NR	NR	NR	NR	NR	78	290	NR	92	483	NR	115	726	449	131	1029	627
	50	NR	NR	NR	NR	NR	NR	NR	NR	NR	147	428	NR	180	651	405	197	944	575

# VENT TABLES

Capacity of Type B Double-Wall Vents with Single-Wall Metal Connectors  
Serving a Single Category I Appliance

TABLE 2

		Vent and Connector Diameter - D (inches)																								
		3"			4"			5"			6"			7"			8"			9"			10"			
Height H (ft)	Lateral L (ft)	Appliance Input Rating in Thousands of Btu Per Hour																								
		FAN		NAT	FAN		NAT	FAN		NAT	FAN		NAT	FAN		NAT	FAN		NAT	FAN		NAT	FAN		NAT	
		Min	Max	Max	Min	Max	Max	Min	Max	Max	Min	Max	Max	Min	Max	Max	Min	Max	Max	Min	Max	Max	Min	Max	Max	
6	0	38	77	45	59	151	85	85	249	140	126	373	204	165	522	284	211	695	369	267	894	469	371	1118	569	
	2	39	51	36	60	96	66	85	156	104	123	231	156	159	320	213	201	423	284	251	541	368	347	673	453	
	4	NR	NR	33	74	92	63	102	152	102	146	225	152	187	313	208	237	416	277	295	533	360	409	664	443	
	6	NR	NR	31	83	89	60	114	147	99	163	220	148	207	307	203	263	409	271	327	526	352	449	656	433	
8	0	37	83	50	58	164	93	83	273	154	123	412	234	161	580	319	206	777	414	258	1002	536	360	1257	658	
	2	39	56	39	59	108	75	83	176	119	121	261	179	155	363	246	197	482	321	246	617	417	339	768	513	
	5	NR	NR	37	77	102	69	107	168	114	151	252	171	193	352	235	245	470	311	305	604	404	418	754	500	
	8	NR	NR	33	90	95	64	122	161	107	175	243	163	223	342	225	280	458	300	344	591	392	470	740	486	
10	0	37	87	53	57	174	99	82	293	165	120	444	254	158	628	344	202	844	449	253	1093	584	351	1373	718	
	2	39	61	41	59	117	80	82	193	128	119	287	194	153	400	272	193	531	354	242	681	456	332	849	559	
	5	52	56	39	76	111	76	105	185	122	148	277	186	190	388	261	241	518	344	299	667	443	409	834	544	
	10	NR	NR	34	97	100	68	132	171	112	188	261	171	237	369	241	296	497	325	363	643	423	492	808	520	
15	0	36	93	57	56	190	111	80	325	186	116	499	283	153	713	388	195	966	523	244	1259	681	336	1591	838	
	2	38	69	47	57	136	93	80	225	149	115	337	224	148	473	314	187	631	413	232	812	543	319	1015	673	
	5	51	63	44	75	128	86	102	216	140	144	326	217	182	459	298	231	616	400	287	795	526	392	997	657	
	10	NR	NR	39	95	116	79	128	201	131	182	308	203	228	438	284	284	592	381	349	768	501	470	966	628	
	15	NR	NR	NR	NR	NR	72	158	186	124	220	290	192	272	418	269	334	568	367	404	742	484	540	937	601	
20	0	35	96	60	54	200	118	78	346	201	114	537	306	149	772	428	190	1053	573	238	1379	750	326	1751	927	
	2	37	74	50	56	148	99	78	248	165	113	375	248	144	528	344	182	708	468	227	914	611	309	1146	754	
	5	50	68	47	73	140	94	100	239	158	141	363	239	178	514	334	224	692	457	279	896	596	381	1126	734	
	10	NR	NR	41	93	129	86	125	223	146	177	344	224	222	491	316	277	666	437	339	866	570	457	1092	702	
	15	NR	NR	NR	NR	NR	80	155	208	136	216	325	210	264	469	301	325	640	419	393	838	549	526	1060	677	
	20	NR	NR	NR	NR	NR	NR	186	192	126	254	306	196	309	448	285	374	616	400	448	810	526	592	1028	651	
30	0	34	99	63	53	211	127	76	372	219	110	584	334	144	849	472	184	1168	647	229	1542	852	312	1971	1056	
	2	37	80	56	55	164	111	76	281	183	109	429	279	139	610	392	175	823	533	219	1069	698	296	1346	863	
	5	49	74	52	72	157	106	98	271	173	136	417	271	171	595	382	215	806	521	269	1049	684	366	1324	846	
	10	NR	NR	NR	91	144	98	122	255	168	171	397	257	213	570	367	265	777	501	327	1017	662	440	1287	821	
	15	NR	NR	NR	115	131	NR	151	239	157	208	377	242	255	547	349	312	750	481	379	985	638	507	1251	794	
	20	NR	NR	NR	NR	NR	NR	181	223	NR	246	357	228	298	524	333	360	723	461	433	955	615	570	1216	768	
	30	NR	NR	NR	NR	NR	NR	NR	NR	NR	NR	NR	NR	NR	389	477	305	461	670	426	541	895	574	704	1147	720
	50	0	33	99	66	51	213	133	73	394	230	105	629	361	138	928	515	176	1292	704	220	1724	948	295	2223	1189
2		36	84	61	53	181	121	73	318	205	104	495	312	133	712	443	168	971	613	209	1273	811	280	1615	1007	
5		48	80	NR	70	174	117	94	308	198	131	482	305	164	696	435	204	953	602	257	1252	795	347	1591	991	
10		NR	NR	NR	89	160	NR	118	292	186	162	461	292	203	671	420	253	923	583	313	1217	765	418	1551	963	
15		NR	NR	NR	112	148	NR	145	275	174	199	441	280	244	646	405	299	894	562	363	1183	736	481	1512	934	
20		NR	NR	NR	NR	NR	NR	176	257	NR	236	420	267	285	622	389	345	866	543	415	1150	708	544	1473	906	
30		NR	NR	NR	NR	NR	NR	NR	NR	NR	315	376	NR	373	573	NR	442	809	502	521	1086	649	674	1399	848	
100	0	NR	NR	NR	49	214	NR	69	403	NR	100	659	395	131	991	555	166	1404	765	207	1900	1033	273	2479	1300	
	2	NR	NR	NR	51	192	NR	70	351	NR	98	563	373	125	828	508	158	1152	698	196	1532	933	259	1970	1168	
	5	NR	NR	NR	67	186	NR	90	342	NR	125	551	366	156	813	501	194	1134	688	240	1511	921	322	1945	1153	
	10	NR	NR	NR	85	175	NR	113	324	NR	153	532	354	191	789	486	238	1104	672	293	1477	902	389	1905	1133	
	15	NR	NR	NR	132	162	NR	138	310	NR	188	511	343	230	764	473	281	1075	656	342	1443	884	447	1865	1110	
	20	NR	NR	NR	NR	NR	NR	168	295	NR	224	487	NR	270	739	458	325	1046	639	391	1410	864	507	1825	1087	
	30	NR	NR	NR	NR	NR	NR	231	264	NR	301	448	NR	355	685	NR	418	988	NR	491	1343	824	631	1747	1041	
	50	NR	NR	NR	NR	NR	NR	NR	NR	NR	NR	NR	NR	NR	540	584	NR	617	866	NR	711	1205	NR	895	1591	NR

## VENT TABLES

Capacity of Type B Double-Wall Vents with Type B Double-Wall Connectors  
Serving Two or more Category I Appliances

**TABLE 3**  
Vent Connector Capacity

Vent Height H (ft)		Connector Rise R (ft)		Vent Connector Diameter - D (inches)																							
				3"			4"			5"			6"			7"			8"			9"					
				Appliance Input Rating Limits in Thousands of Btu Per Hour																							
				FAN		NAT		FAN		NAT		FAN		NAT		FAN		NAT		FAN		NAT		FAN		NAT	
				Min	Max	Max	Min	Max	Max	Min	Max	Max	Min	Max	Max	Min	Max	Max	Min	Max	Max	Min	Max	Max	Min	Max	Max
6	1	22	37	26	35	66	46	46	106	72	58	164	104	77	225	142	92	296	185	109	376	237					
	2	23	41	31	37	75	55	48	121	86	60	183	124	79	253	168	95	333	220	112	424	282					
	3	24	44	35	38	81	62	49	132	96	62	199	139	82	275	189	97	363	248	114	463	317					
8	1	22	40	27	35	72	48	49	114	76	64	176	109	84	243	148	100	320	194	118	408	248					
	2	23	44	32	36	80	57	51	128	90	66	195	129	86	269	175	103	356	230	121	454	294					
	3	24	47	36	37	87	64	53	139	101	67	210	145	88	290	198	105	384	258	123	492	330					
10	1	22	43	28	34	78	50	49	123	78	65	189	113	89	257	154	106	341	200	125	436	257					
	2	23	47	33	36	86	59	51	136	93	67	206	134	91	282	182	109	374	238	128	479	305					
	3	24	50	37	37	92	67	52	146	104	69	220	150	94	303	205	111	402	268	131	515	342					
15	1	21	50	30	33	89	53	47	142	83	64	220	120	88	298	163	110	389	214	134	493	273					
	2	22	53	35	35	96	63	49	153	99	66	235	142	91	320	193	112	419	253	137	532	323					
	3	24	55	40	36	102	71	51	163	111	68	248	160	93	339	218	115	445	286	140	565	365					
20	1	21	54	31	33	99	56	46	157	87	62	246	125	86	334	171	107	436	224	131	552	285					
	2	22	57	37	34	105	66	48	167	104	64	259	149	89	354	202	110	463	265	134	587	339					
	3	23	60	42	35	110	74	50	176	116	66	271	168	91	371	228	113	486	300	137	618	518					
30	1	20	62	33	31	113	59	45	181	93	60	288	134	83	391	182	103	512	238	125	649	305					
	2	21	64	39	33	118	70	47	190	110	62	299	158	85	408	215	105	535	282	129	679	360					
	3	22	66	44	34	123	79	48	198	124	64	309	178	88	423	242	108	555	317	132	706	405					
50	1	19	71	36	30	133	64	43	216	101	57	349	145	78	477	197	97	627	257	120	797	330					
	2	21	73	43	32	137	76	45	223	119	59	358	172	81	490	234	100	645	306	123	820	392					
	3	22	75	48	33	141	86	46	229	134	61	366	194	83	502	263	103	661	343	126	842	441					
100	1	18	82	37	28	158	66	40	262	104	53	442	150	73	611	204	91	810	266	112	1038	341					
	2	19	83	44	30	161	79	42	267	123	55	447	178	75	619	242	94	822	316	115	1054	405					
	3	20	84	50	31	163	89	44	272	138	57	452	200	78	627	272	97	834	355	118	1069	455					

Common Vent Capacity

Vent Height H (ft)		Common Vent Diameter - D (inches)																	
		4"			5"			6"			7"			8"			9"		
		Combined Appliance Input Rating in Thousands of Btu Per Hour																	
		FAN	FAN	NAT	FAN	FAN	NAT	FAN	FAN	NAT	FAN	FAN	NAT	FAN	FAN	NAT	FAN	FAN	NAT
		+FAN	+NAT	+NAT	+FAN	+NAT	+NAT	+FAN	+NAT	+NAT	+FAN	+NAT	+NAT	+FAN	+NAT	+NAT	+FAN	+NAT	+NAT
6		92	81	65	140	116	103	204	161	147	309	248	200	404	314	260	547	434	335
8		101	90	73	155	129	114	224	178	163	339	275	223	444	348	290	602	480	378
10		110	97	79	169	141	124	243	194	178	367	299	242	477	377	315	649	522	405
15		125	112	91	195	164	144	283	228	206	427	352	280	556	444	365	753	612	465
20		136	123	102	215	183	160	314	255	229	475	394	310	621	499	405	842	688	523
30		152	138	118	244	210	185	361	297	266	547	459	360	720	585	470	979	808	605
50		167	153	134	279	244	214	421	353	310	641	547	423	854	706	550	1164	977	705
100		175	163	NR	311	277	NR	489	421	NR	751	658	479	1025	873	625	1408	1215	800



## VENT TABLES

Capacity of Type B Double-Wall Vent with Single-Wall Connectors  
Serving Two or more Category I Appliances

TABLE 4  
Vent Connector Capacity

		Vent Connector Diameter - D (inches)																				
		3"			4"			5"			6"			7"			8"			9"		
Vent Height H (ft)	Connector Rise R (ft)	Appliance Input Rating Limits in Thousands of Btu Per Hour																				
		FAN		NAT	FAN		NAT	FAN		NAT	FAN		NAT	FAN		NAT	FAN		NAT	FAN		NAT
		Min	Max	Max	Min	Max	Max	Min	Max	Max	Min	Max	Max	Min	Max	Max	Min	Max	Max	Min	Max	Max
6	1	NR	NR	26	NR	NR	46	NR	NR	71	NR	NR	102	207	223	140	262	293	183	325	373	234
	2	NR	NR	31	NR	NR	55	NR	NR	85	168	182	123	215	251	167	271	331	219	334	422	281
	3	NR	NR	34	NR	NR	62	121	131	95	174	198	138	222	273	188	279	361	247	344	462	316
15	1	NR	NR	29	79	87	52	116	138	81	177	214	116	238	291	158	312	380	208	397	482	266
	2	NR	NR	34	83	94	62	121	150	97	185	230	138	246	314	189	321	411	248	407	522	317
	3	NR	NR	39	87	100	70	127	160	109	193	243	157	255	333	215	331	438	281	418	557	360
30	1	47	60	31	77	110	57	113	175	89	169	278	129	226	380	175	296	497	230	378	630	294
	2	50	62	37	81	115	67	117	185	106	177	290	152	236	397	208	307	521	274	389	662	349
	3	54	64	42	85	119	76	122	193	120	185	300	172	244	412	235	316	542	309	400	690	394
50	1	46	69	33	75	128	60	109	207	96	162	336	137	217	460	188	284	604	245	364	768	314
	2	49	71	40	79	132	72	114	215	113	170	345	164	226	473	223	294	623	293	376	793	375
	3	53	72	45	83	136	82	119	221	128	178	353	186	235	486	252	304	640	331	387	816	424

Common Vent Capacity

		Common Vent Diameter - D (inches)																	
		4"			5"			6"			7"			8"			9"		
Vent Height H (ft)		Combined Appliance Input Rating in Thousands of Btu Per Hour																	
		FAN	FAN	NAT	FAN	FAN	NAT	FAN	FAN	NAT	FAN	FAN	NAT	FAN	FAN	NAT	FAN	FAN	NAT
		+FAN	+NAT	+NAT	+FAN	+NAT	+NAT	+FAN	+NAT	+NAT	+FAN	+NAT	+NAT	+FAN	+NAT	+NAT	+FAN	+NAT	+NAT
6		89	78	64	136	113	100	200	158	144	304	244	196	398	310	257	541	429	332
8		98	87	71	151	126	112	218	173	159	331	269	218	436	342	285	592	473	373
10		106	94	76	163	137	120	237	189	174	357	292	236	467	369	309	638	512	398
15		121	108	88	189	159	140	275	221	200	416	343	274	544	434	357	738	599	456
20		131	118	98	208	177	155	305	247	223	463	383	302	606	487	395	824	673	512
30		145	132	113	236	202	179	350	286	257	533	446	349	703	570	459	958	790	593
50		159	145	128	268	233	204	406	337	296	622	529	410	833	686	535	1139	954	689

# VENT TABLES

Capacity of Masonry Chimney with Type B Double-Wall Vent Connectors  
Serving a Single Category I Appliance

TABLE 5

HEIGHT LATERAL		Connector Diameter - D (inches)																										
		To be used with chimney areas within the size limits at bottom																										
		3"		4"		5"		6"		7"		8"		9"		10"		12"										
		Appliance Input Rating in Thousands of Btu Per Hour																										
H (ft)	L (ft)	FAN		NAT	FAN		NAT	FAN		NAT	FAN		NAT	FAN		NAT	FAN		NAT	FAN		NAT	FAN		NAT	FAN		NAT
		Min	Max	Max	Min	Max	Max	Min	Max	Max	Min	Max	Max	Min	Max	Max	Min	Max	Max	Min	Max	Max	Min	Max	Max	Min	Max	Max
6	2	NR	NR	28	NR	NR	52	NR	NR	86	NR	NR	130	NR	NR	180	NR	NR	247	NR	NR	320	NR	NR	401	NR	NR	581
	5	NR	NR	25*	NR	NR	49	NR	NR	82	NR	NR	117	NR	NR	165	NR	NR	231	NR	NR	298	NR	NR	376	NR	NR	561
10	2	NR	NR	31	NR	NR	61	NR	NR	103	NR	NR	162	NR	NR	221	NR	NR	298	NR	NR	388	NR	NR	491	NR	NR	724
	5	NR	NR	28*	NR	NR	57	NR	NR	96	NR	NR	148	NR	NR	204	NR	NR	277	NR	NR	365	NR	NR	466	NR	NR	712
	10	NR	NR	25*	NR	NR	50*	NR	NR	87	NR	NR	139	NR	NR	181	NR	NR	263	NR	NR	347	NR	NR	444	NR	NR	668
15	2	NR	NR	35*	NR	NR	67	NR	NR	114	NR	NR	179	NR	NR	250	NR	NR	336	NR	NR	441	NR	NR	562	NR	NR	841
	5	NR	NR	33*	NR	NR	62	NR	NR	107	NR	NR	164	NR	NR	231	NR	NR	313	NR	NR	416	NR	NR	533	NR	NR	828
	10	NR	NR	28*	NR	NR	55*	NR	NR	97	NR	NR	153	NR	NR	216	NR	NR	296	NR	NR	394	NR	NR	567	NR	NR	777
	15	NR	NR	NR	NR	NR	48*	NR	NR	89*	NR	NR	141	NR	NR	201	NR	NR	281	NR	NR	375	NR	NR	485	NR	NR	742
20	2	NR	NR	38*	NR	NR	74	NR	NR	124	NR	NR	201	NR	NR	274	NR	NR	375	NR	NR	491	NR	NR	627	NR	NR	953
	5	NR	NR	36*	NR	NR	68*	NR	NR	116	NR	NR	184	NR	NR	254	NR	NR	350	NR	NR	463	NR	NR	597	NR	NR	933
	10	NR	NR	NR	NR	NR	60*	NR	NR	107*	NR	NR	172	NR	NR	237	NR	NR	332	NR	NR	440	NR	NR	566	NR	NR	879
	15	NR	NR	NR	NR	NR	NR	NR	NR	97*	NR	NR	159	NR	NR	220	NR	NR	314	NR	NR	418	NR	NR	541	NR	NR	840
	20	NR	NR	NR	NR	NR	NR	NR	NR	83*	NR	NR	148*	NR	NR	206	NR	NR	296	NR	NR	397	NR	NR	513	NR	NR	807
30	2	NR	NR	41*	NR	NR	82*	NR	NR	137	NR	NR	216	NR	NR	303	NR	NR	421	NR	NR	558	NR	NR	717	NR	NR	1112
	5	NR	NR	NR	NR	NR	76*	NR	NR	128*	NR	NR	198	NR	NR	281	NR	NR	393	NR	NR	526	NR	NR	683	NR	NR	1094
	10	NR	NR	NR	NR	NR	67*	NR	NR	115*	NR	NR	184*	NR	NR	263	NR	NR	373	NR	NR	500	NR	NR	648	NR	NR	1025
	15	NR	NR	NR	NR	NR	NR	NR	NR	107*	NR	NR	171*	NR	NR	243*	NR	NR	353	NR	NR	476	NR	NR	621	NR	NR	981
	20	NR	NR	NR	NR	NR	NR	NR	NR	91*	NR	NR	159*	NR	NR	227*	NR	NR	332	NR	NR	450	NR	NR	592	NR	NR	940
	30	NR	NR	NR	NR	NR	NR	NR	NR	NR	NR	NR	NR	NR	NR	188*	NR	NR	288*	NR	NR	416	NR	NR	555	NR	NR	877
50	2	NR	NR	NR	NR	NR	92*	NR	NR	161*	NR	NR	251*	NR	NR	351*	NR	NR	477	NR	NR	633	NR	NR	812	NR	NR	1243
	5	NR	NR	NR	NR	NR	NR	NR	NR	151*	NR	NR	230*	NR	NR	323*	NR	NR	445	NR	NR	596	NR	NR	774	NR	NR	1225
	10	NR	NR	NR	NR	NR	NR	NR	NR	138*	NR	NR	215*	NR	NR	304*	NR	NR	424*	NR	NR	567	NR	NR	733	NR	NR	1147
	15	NR	NR	NR	NR	NR	NR	NR	NR	127*	NR	NR	199*	NR	NR	282*	NR	NR	400*	NR	NR	539*	NR	NR	702	NR	NR	1099
	20	NR	NR	NR	NR	NR	NR	NR	NR	NR	NR	NR	185*	NR	NR	264*	NR	NR	376*	NR	NR	511*	NR	NR	669*	NR	NR	1050
	30	NR	NR	NR	NR	NR	NR	NR	NR	NR	NR	NR	NR	NR	NR	NR	NR	NR	327*	NR	NR	468*	NR	NR	623*	NR	NR	984
Minimum Internal Area of Chimney Square Inches		12		19		28		38		50		63		78		95		132										
Max Internal Area of Chimney Square Inches		49		88		137		198		269		352		445		550		792										

\* SEE NOTE 27

# VENT TABLES

Capacity of Masonry Chimney with Single-Wall Vent Connectors  
Serving a Single Category I Appliance

TABLE 6

HEIGHT LATERAL		Connector Diameter - D (inches)																													
		To be used with chimney areas within the size limits at bottom																													
		3"		4"		5"		6"		7"		8"		9"		10"		12"													
H (ft)		L (ft)		Appliance Input Rating in Thousands of Btu Per Hour																											
				FAN		NAT		FAN		NAT		FAN		NAT		FAN		NAT		FAN		NAT		FAN		NAT		FAN		NAT	
				Min	Max	Max	Min	Max	Max	Min	Max	Max	Min	Max	Max	Min	Max	Max	Min	Max	Max	Min	Max	Max	Min	Max	Max	Min	Max	Max	Min
6	2	NR	NR	28	NR	NR	52	NR	NR	86	NR	NR	130	NR	NR	180	NR	NR	247	NR	NR	319	NR	NR	400	NR	NR	580			
	5	NR	NR	25*	NR	NR	48	NR	NR	81	NR	NR	116	NR	NR	164	NR	NR	230	NR	NR	297	NR	NR	375	NR	NR	560			
10	2	NR	NR	31	NR	NR	61	NR	NR	102	NR	NR	161	NR	NR	220	NR	NR	297	NR	NR	387	NR	NR	490	NR	NR	722			
	5	NR	NR	28*	NR	NR	56	NR	NR	95	NR	NR	147	NR	NR	203	NR	NR	276	NR	NR	364	NR	NR	465	NR	NR	710			
	10	NR	NR	24*	NR	NR	49*	NR	NR	86	NR	NR	137	NR	NR	189	NR	NR	261	NR	NR	345	NR	NR	441	NR	NR	665			
15	2	NR	NR	35*	NR	NR	67	NR	NR	113	NR	NR	178	NR	NR	249	NR	NR	335	NR	NR	440	NR	NR	560	NR	NR	840			
	5	NR	NR	32*	NR	NR	61	NR	NR	106	NR	NR	163	NR	NR	230	NR	NR	312	NR	NR	414	NR	NR	531	NR	NR	825			
	10	NR	NR	27*	NR	NR	54*	NR	NR	96	NR	NR	151	NR	NR	214	NR	NR	294	NR	NR	392	NR	NR	504	NR	NR	774			
	15	NR	NR	NR	NR	NR	46*	NR	NR	87*	NR	NR	138	NR	NR	198	NR	NR	278	NR	NR	372	NR	NR	481	NR	NR	738			
20	2	NR	NR	38*	NR	NR	73	NR	NR	123	NR	NR	200	NR	NR	273	NR	NR	374	NR	NR	490	NR	NR	625	NR	NR	950			
	5	NR	NR	35*	NR	NR	67*	NR	NR	115	NR	NR	183	NR	NR	252	NR	NR	348	NR	NR	461	NR	NR	594	NR	NR	930			
	10	NR	NR	NR	NR	NR	59*	NR	NR	105*	NR	NR	170	NR	NR	235	NR	NR	330	NR	NR	437	NR	NR	562	NR	NR	875			
	15	NR	NR	NR	NR	NR	NR	NR	NR	95*	NR	NR	156	NR	NR	217	NR	NR	311	NR	NR	414	NR	NR	536	NR	NR	835			
	20	NR	NR	NR	NR	NR	NR	NR	NR	80*	NR	NR	144*	NR	NR	202	NR	NR	292	NR	NR	392	NR	NR	510	NR	NR	800			
30	2	NR	NR	41*	NR	NR	81*	NR	NR	136	NR	NR	215	NR	NR	302	NR	NR	420	NR	NR	556	NR	NR	715	NR	NR	1110			
	5	NR	NR	NR	NR	NR	75*	NR	NR	127*	NR	NR	196	NR	NR	279	NR	NR	391	NR	NR	524	NR	NR	680	NR	NR	1090			
	10	NR	NR	NR	NR	NR	66*	NR	NR	113*	NR	NR	182*	NR	NR	260	NR	NR	370	NR	NR	496	NR	NR	644	NR	NR	1020			
	15	NR	NR	NR	NR	NR	NR	NR	NR	105*	NR	NR	168*	NR	NR	240*	NR	NR	349	NR	NR	471	NR	NR	615	NR	NR	975			
	20	NR	NR	NR	NR	NR	NR	NR	NR	88*	NR	NR	155*	NR	NR	223*	NR	NR	327	NR	NR	445	NR	NR	585	NR	NR	932			
	30	NR	NR	NR	NR	NR	NR	NR	NR	NR	NR	NR	NR	NR	NR	182*	NR	NR	281*	NR	NR	408	NR	NR	544	NR	NR	865			
50	2	NR	NR	NR	NR	NR	91*	NR	NR	160*	NR	NR	250*	NR	NR	350*	NR	NR	475	NR	NR	631	NR	NR	810	NR	NR	1240			
	5	NR	NR	NR	NR	NR	NR	NR	NR	149*	NR	NR	228*	NR	NR	321*	NR	NR	442	NR	NR	593	NR	NR	770	NR	NR	1220			
	10	NR	NR	NR	NR	NR	NR	NR	NR	136*	NR	NR	212*	NR	NR	301*	NR	NR	420*	NR	NR	562	NR	NR	728	NR	NR	1140			
	15	NR	NR	NR	NR	NR	NR	NR	NR	124*	NR	NR	195*	NR	NR	278*	NR	NR	395*	NR	NR	533*	NR	NR	695	NR	NR	1090			
	20	NR	NR	NR	NR	NR	NR	NR	NR	NR	NR	NR	180*	NR	NR	258*	NR	NR	370*	NR	NR	504*	NR	NR	660*	NR	NR	1040			
	30	NR	NR	NR	NR	NR	NR	NR	NR	NR	NR	NR	NR	NR	NR	NR	NR	NR	318*	NR	NR	458*	NR	NR	610*	NR	NR	970			
Minimum Internal Area of Chimney Square Inches		12		19		28		38		50		63		78		95		132													
Maximum Internal Area of Chimney Square Inches		49		88		137		198		269		352		445		550		792													

\* SEE NOTE 27

## VENT TABLES

Capacity of Masonry Chimney with Type B Double-Wall Connectors  
Serving Two or More Category I Appliance

**TABLE 7**  
Vent Connector Capacity

		Vent Connector Diameter - D (inches)																				
		3"			4"			5"			6"			7"			8"			9"		
Vent Height H (ft)	Connector Rise R (ft)	Appliance Input Rating Limits in Thousands of Btu Per Hour																				
		FAN		NAT	FAN		NAT	FAN		NAT	FAN		NAT	FAN		NAT	FAN		NAT	FAN		NAT
		Min	Max	Max	Min	Max	Max	Min	Max	Max	Min	Max	Max	Min	Max	Max	Min	Max	Max	Min	Max	Max
6	1	24	NR	21	39	62	40	52	106	67	65	194	101	87	274	141	104	370	201	124	479	253
	2	26	43	28	41	79	52	53	133	85	67	230	124	89	324	173	107	436	232	127	562	330
	3	27	49	34	42	92	61	55	155	97	69	262	143	91	369	203	109	491	270	129	633	349
15	1	24	48	23	38	93	44	54	154	74	72	277	114	100	384	174	125	511	229	153	658	297
	2	25	55	31	39	105	55	56	174	89	74	299	134	103	419	192	128	558	260	156	718	339
	3	26	59	35	41	115	64	57	189	102	76	319	153	105	448	215	131	597	292	159	760	382
30	1	24	54	25	37	111	48	52	192	82	69	357	127	96	504	187	119	680	255	145	883	337
	2	25	60	32	38	122	58	54	208	95	72	376	145	99	531	209	122	715	287	149	928	378
	3	26	64	36	40	131	66	56	221	107	74	392	163	101	554	233	125	746	317	152	968	418
50	1	23	52	26	36	116	49	51	209	82	67	405	133	92	582	198	115	798	271	140	1049	362
	2	24	59	31	37	127	58	53	225	96	70	421	152	95	604	222	118	827	304	143	1085	400
	3	26	64	37	39	135	66	55	237	108	72	435	170	98	624	247	121	854	334	147	1118	439

Common Vent Capacity

		Minimum Internal Area of Chimney, Square Inches																	
		12			19			28			38			50			63		
Vent Height H (ft)		Combined Appliance Input Rating in Thousands of Btu Per Hour																	
		FAN		NAT	FAN		NAT	FAN		NAT	FAN		NAT	FAN		NAT	FAN		NAT
		+FAN	+NAT	+NAT	+FAN	+NAT	+NAT	+FAN	+NAT	+NAT	+FAN	+NAT	+NAT	+FAN	+NAT	+NAT	+FAN	+NAT	+NAT
6		NR	74	25	NR	119	46	NR	178	71	NR	257	103	NR	351	143	NR	458	188
8		NR	80	28	NR	130	53	NR	193	82	NR	279	119	NR	384	163	NR	501	218
10		NR	84	31	NR	138	56	NR	207	90	NR	299	131	NR	409	177	NR	538	236
15		NR	90	36	NR	152	67	NR	233	106	NR	334	152	NR	467	212	NR	611	283
20		NR	92	41	NR	159	75	NR	250	122	NR	368	172	NR	508	243	NR	668	325
30		NR	NR	NR	NR	NR	NR	NR	270	137	NR	404	198	NR	564	278	NR	747	381
50		NR	NR	NR	NR	NR	NR	NR	NR	NR	NR	NR	NR	NR	620	328	NR	831	461

## VENT TABLES

Capacity of Masonry Chimney with Type B Double-Wall  
Connectors Serving Two or More Category I Appliances

**TABLE 8**  
Vent Connector Capacity

Vent Height H (ft)		Connector Rise R (ft)		Type B Double-Wall Vent Connector Diameter - D (inches)															
				3"		4"		5"		6"		7"		8"					
				Appliance Input Rating Limits in Thousands of Btu Per Hour															
		FAN		NAT		FAN		NAT		FAN		NAT		FAN		NAT			
		Min	Max	Max	Min	Max	Max	Min	Max	Max	Min	Max	Max	Min	Max	Max	Min	Max	
6	1	NR	NR	21	NR	NR	39	NR	NR	66	179	191	100	231	271	140	292	366	200
	2	NR	NR	28	NR	NR	52	NR	NR	84	186	227	123	239	321	172	301	432	231
	3	NR	NR	34	NR	NR	61	134	153	97	193	258	142	247	365	202	309	491	269
15	1	NR	NR	23	NR	NR	43	129	151	73	199	271	112	268	376	171	349	502	225
	2	NR	NR	30	92	103	54	135	170	88	207	295	132	277	411	189	359	548	256
	3	NR	NR	34	96	112	63	141	185	101	215	315	151	286	439	213	368	586	289
30	1	NR	NR	24	86	108	47	126	187	80	193	347	124	259	492	183	338	665	250
	2	NR	NR	31	91	119	57	132	203	93	201	366	142	269	518	205	348	699	282
	3	NR	NR	35	95	127	65	138	216	105	209	381	160	277	540	229	358	729	312
50	1	NR	NR	25	85	113	48	124	204	80	188	392	130	252	567	194	328	778	265
	2	NR	NR	31	89	123	57	130	218	94	196	408	149	262	588	218	339	806	298
	3	NR	NR	35	94	131	65	136	231	106	205	422	167	271	607	243	349	831	328

Common Vent Capacity

Vent Height H (ft)		Minimum Internal Area of Masonry Chimney Flue (Square Inch)																			
		12			19			28			38			50			63				
		Combined Appliance Input Rating in Thousands of Btu Per Hour																			
		FAN		NAT		FAN		NAT		FAN		NAT		FAN		NAT		FAN		NAT	
		+FAN	+NAT	+NAT	+FAN	+NAT	+NAT	+FAN	+NAT	+NAT	+FAN	+NAT	+NAT	+FAN	+NAT	+NAT	+FAN	+NAT	+NAT		
6	NR	73	25	NR	118	45	NR	176	71	NR	255	102	NR	348	142	NR	455	187			
8	NR	79	28	NR	128	52	NR	190	81	NR	276	118	NR	380	162	NR	497	217			
10	NR	83	31	NR	136	56	NR	205	89	NR	295	129	NR	405	175	NR	532	234			
15	NR	88	36	NR	149	66	NR	230	105	NR	335	150	NR	460	210	NR	602	280			
20	NR	90	40	NR	157	74	NR	247	120	NR	362	170	NR	503	240	NR	661	321			
30	NR	NR	NR	NR	NR	NR	NR	266	135	NR	398	195	NR	558	275	NR	739	377			
50	NR	NR	NR	NR	NR	NR	NR	NR	NR	NR	NR	NR	NR	612	325	NR	821	456			