

PROHEAT 2X[®] REVOLUTION[™] Deep Cleaner

USER GUIDE
1548, 1550, 1551 SERIES

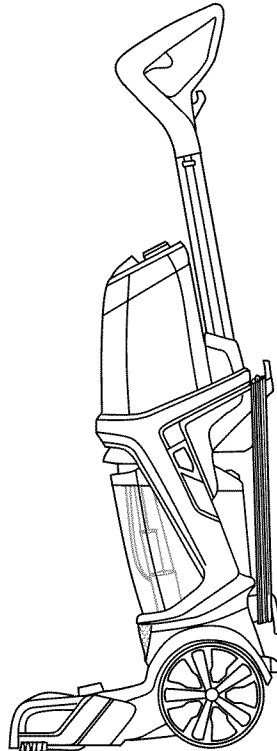
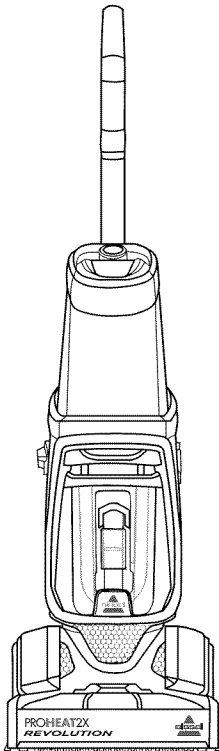

IMPORTANT SAFETY INSTRUCTIONS

READ ALL INSTRUCTIONS BEFORE USING YOUR DEEP CLEANER.

When using an electrical appliance, basic precautions should be observed, including the following:

⚠ WARNING

TO REDUCE THE RISK OF FIRE, ELECTRIC SHOCK, OR INJURY:

- » Connect to a properly grounded outlet only. See grounding instructions. Do not modify the 3-prong grounded plug.
- » Do not leave appliance when it is plugged in. Unplug from outlet when not in use and before servicing.
- » Use indoors only.
- » Do not allow to be used as a toy. Close attention is necessary when used by or near children.
- » Do not use for any purpose other than described in this User's Guide. Use only manufacturer's recommended attachments.
- » Do not use with damaged cord or plug. If appliance is not working as it should, or has been dropped, damaged, left outdoors, or dropped into water, have it repaired at an authorized service center.
- » Do not pull or carry by cord, use cord as a handle, close a door on cord, or pull cord around sharp edges or corners. Do not run appliance over cord. Keep cord away from heated surfaces.
- » Do not unplug by pulling on cord. To unplug, grasp the plug, not the cord.
- » Do not handle plug or appliance with wet hands.
- » Do not put any object into openings. Do not use with any opening blocked; keep openings free of dust, lint, hair, and anything that may reduce air flow.
- » Keep hair, loose clothing, fingers, and all parts of body away from openings and moving parts.
- » Turn off all controls before plugging or unplugging appliance.
- » Use extra care when cleaning on stairs.
- » Do not use to pick up flammable or combustible materials (lighter fluid, gasoline, kerosene, etc.) or use in areas where they may be present.
- » Do not use appliance in an enclosed space filled with vapors given off by oil base paint, paint thinner, some moth proofing substances, flammable dust, or other explosive or toxic vapors.
- » Do not use to pick up toxic material (chlorine bleach, ammonia, drain cleaner, etc.).
- » Do not pick up anything that is burning or smoking, such as cigarettes, matches, or hot ashes.
- » Use only BISSELL cleaning products intended for use with this appliance to prevent internal component damage. See the Cleaning Formula section of this guide.
- » Do not immerse. Use only on surfaces moistened by the cleaning process.
- » Keep appliance on a level surface.
- » Do not carry the appliance while in use.
- » Always install float before any wet pick-up operation.

NOTE: STORE CLEANER IN A PROTECTED, DRY AREA. SINCE THIS PRODUCT USES WATER, IT MUST NOT BE STORED WHERE THERE IS A DANGER OF FREEZING. FREEZING WILL DAMAGE INTERNAL COMPONENTS AND VOID THE WARRANTY.

SAVE THESE INSTRUCTIONS FOR FUTURE USE

This model is for household use only. Commercial use of this unit voids the manufacturer's warranty.

⚠ WARNING

Improper connection of the equipment-grounding conductor can result in a risk of electrical shock. Check with a qualified electrician or service person if you aren't sure if the outlet is properly grounded. **DO NOT MODIFY THE PLUG.** If it will not fit the outlet, have a proper outlet installed by a qualified electrician. This appliance is designed for use on a nominal 120-volt circuit, and has a grounding attachment plug that looks like the plug in the illustration. Make certain that the appliance is connected to an outlet having the same configuration as the plug. No plug adapter should be used with this appliance.

GROUNDING INSTRUCTIONS

This appliance must be connected to a grounded wiring system. If it should malfunction or break down, grounding provides a safe path of least resistance for electrical current, reducing the risk of electrical shock. The cord for this appliance has an equipment-grounding conductor and a grounding plug. It must only be plugged into an outlet that is properly installed and grounded in accordance with all local codes and ordinances.

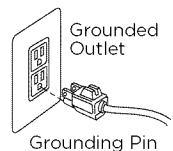

Thanks for buying a BISSELL carpet cleaner!

We love to clean and we're excited to share one of our innovative products with you. We want to make sure your carpet cleaner works as well in three years as it does today, so this guide has tips on using (page 11), maintaining (page 14-17), and if there is a problem, troubleshooting (page 18).

In just a few simple assembly steps, you'll be ready to deep clean. Flip to page 5 and let's get started!

Package Contents

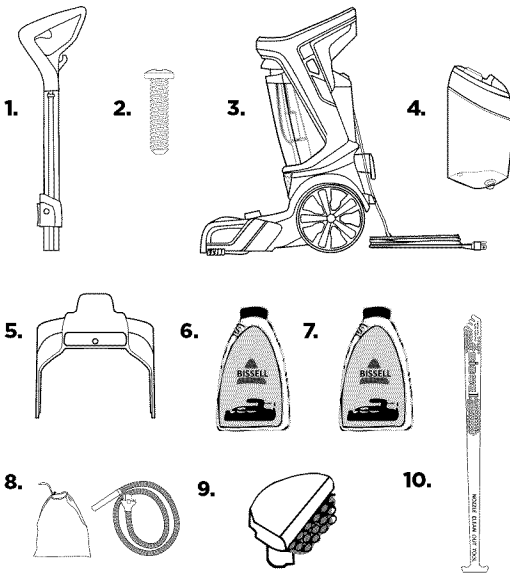

1. Upper Handle
2. 1 Screw attached to Upper Handle
3. Base with Dirty Water Tank
4. Clean Water Tank
5. Carry Handle
6. BISSELL Professional Deep Cleaning formula
7. BISSELL Deep Clean + Antibacterial Formula
8. Accessory bag & hose
9. Attachments/accessories (vary by model)
10. Nozzle Clean Out Tool

NOTE: Not all accessories come with every model. Be sure to check the carton for additional tools.

Safety Instructions.....	2	Troubleshooting	18
Product View.....	4	Warranty.....	19
Assembly	5	Service	19
Cleaning Formulas.....	6-8	Contact Information	19
Operations	9-13	Product Registration.....	20
Maintenance & Care	14-17	Parts & Supplies	20

Getting to Know Your Deep Cleaner

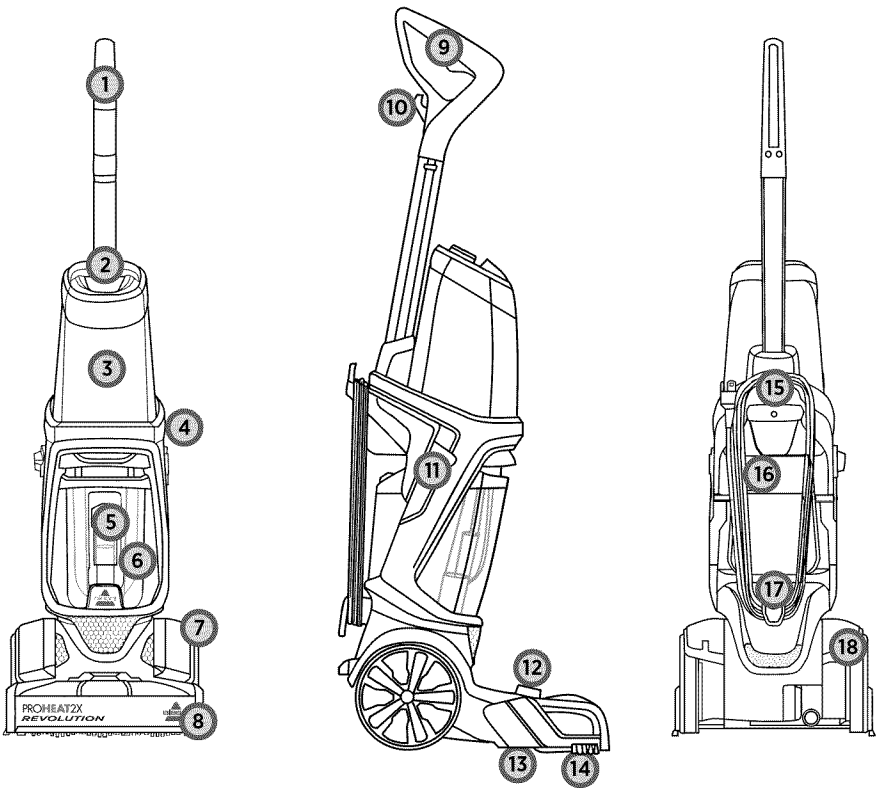

- | | | | |
|----|---|----|-------------------------------------|
| 1 | Upper Handle | 11 | Cleaning Mode Switch |
| 2 | Easy Fill/Formula Cap | 12 | Accessory Hose Door |
| 3 | Clean Water Tank
(1 Gallon Capacity) | 13 | Belt/Brush Access Plate |
| 4 | Power Button | 14 | EdgeSweep® Brushes |
| 5 | Float Stack | 15 | Carry Handle |
| 6 | Dirty Water Tank | 16 | Rubber Tab
(on Dirty Water Tank) |
| 7 | Belt Access Door | 17 | Quick Release for
Wrapped Cord |
| 8 | Foot | 18 | Recline Pedal |
| 9 | Spray Trigger | | |
| 10 | In-Use Cord Clip | | |

Assembly

WARNING

Do not plug in your deep cleaner until you are familiar with all instructions and operating procedures.

Your deep cleaner comes in four easy-to-assemble components and an accessory bag.

- Base
- Upper Handle
- Clean Water Tank
- Carry Handle

The only tool you will need to assemble your deep cleaner is a Phillips screwdriver.

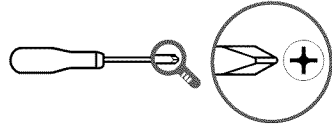

1

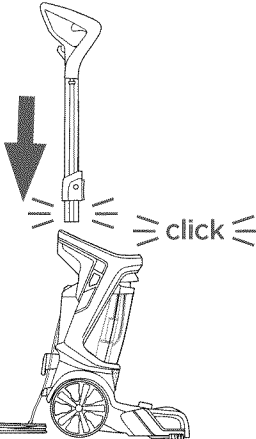

First, insert the upper handle at the top of the base until you hear a “click”.

2

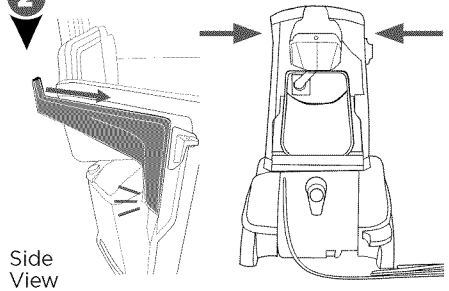

Side View

Next, align the carry handle with the slots on either side of the base (behind the power switch and cleaning mode switch). The carry handle will “click” into place.

3

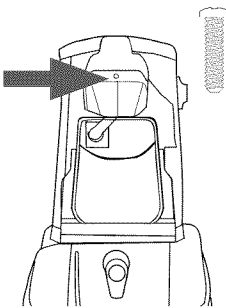

Using a Phillips screwdriver, secure the carry handle with the screw that’s taped to the upper handle.

4

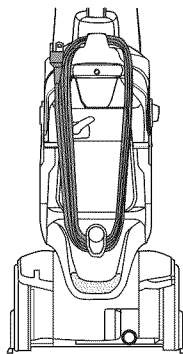

Wrap the cord around the carry handle and quick release hook.

5

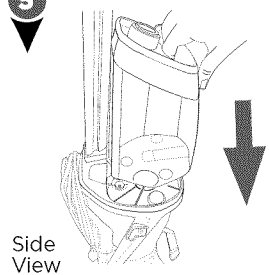

Side View

At the bottom of the upper handle, align the clean water tank with the grooves and slide the tank into place.







Cleaning Formulas









⚠ WARNING

To reduce the risk of fire and electric shock due to internal component damage, use only BISSELL cleaning fluids intended for use with the deep cleaner.

Keep plenty of genuine BISSELL 2X* formula on hand so you can clean and protect whenever it fits your schedule.

Always use genuine BISSELL deep cleaning formulas. Non-BISSELL cleaning solutions may harm the machine and will void the warranty.

BOOST CARPET CLEANING FORMULA ENHANCER				PRETREAT PRE TREAT SPOTS AND STAINS TO IMPROVE CARPET CLEANING PERFORMANCE		
						
Oxy Boost	Renew Boost	Prevent Boost	Pet Oxy Boost	Stain PreTreat	Pet Stain PreTreat	Pet PreTreat + Sanitize
Removes old, set-in stains permanently	Revives carpets to look their best	Repels stains from soaking into carpet fibers	Removes pet stains and odors permanently	Pretreat to penetrate and loosen tough stains	Pretreat to help remove tough pet stains and odors	Penetrates to sanitize and loosen tough stains

easy fill SYSTEM	PROFESSIONAL FORMULA	2X* CLEANING FORMULA					BARE FLOOR FORMULAS
							
DeepClean + Antibacterial	Professional Deep Cleaning	Pet Stain & Odor	DeepClean & Protect	Allergen Cleansing	DeepClean + Refresh	Deep Clean + Oxy	Hard Floor Solutions
2-in-1 formula	Out cleans all other formulas <i>Includes Scotchgard™ Protector</i>	Removes tough pet stains and contains patented odor removal technology <i>Includes Scotchgard™ Protector</i>	Deep cleans carpets and protects from future stains with Scotchgard™ Protector	Helps remove pet & pollen allergens	Powerful cleaning with a refreshing scent	Removes deep down dirt, pet stains, & pet odor	Safe use for linoleum, vinyl, and ceramic tile; removes tough dirt and grime

ONLY BISSELL Protects from future stains with Scotchgard™ Protector.

Scotchgard™ is a trademark of 3M®.

*2.5 fl. oz. of 2X concentrated formula is equivalent to 5.0 fl. oz. of non-concentrated formula.

Tips Before Carpet Cleaning

- If cleaning an entire room, consider moving your furniture to another area.
- Use a dry vacuum cleaner over area before using your deep cleaner.
- Pre-treat stains with BISSELL PreTreat to improve performance on coffee stains and ground-in dirt.

Customize Your Clean & Maximize Your Results

For Antibacterial Clean:

Use BISSELL Deep Clean + Antibacterial formula

Use BISSELL Deep Clean + Antibacterial with the Deep Clean Mode of your machine to achieve antibacterial results.



For Pet Stains & Odors:

Erase pesky stains & remove odors!

Pretreat pesky pet stains with BISSELL Pretreat spray before using your deep cleaner. Choose a BISSELL pet formula for your deep cleaner and clean as directed.



To Clean Dark Stains:

Remove stains permanently!

Use BISSELL Deep Clean + Oxy formula or add BOOST OXY to any of your favorite BISSELL formulas to maximize the stain removal power.



To Remove Ground-In Dirt:

Renew your carpet!

Pretreat ground-in dirt with a BISSELL Pretreat Spray. Choose BISSELL Professional Deep Cleaning formula and pair with a BISSELL Boost to enhance your cleaning.



To Refresh Your Home:

Choose your favorite scent!

Pair your carpet cleaner with BISSELL Febreze™ formulas to give your home a clean and refreshing scent.



To Prevent Future Stains:

Protect your newly cleaned carpets!

Prevent stains from setting in by deep cleaning with BISSELL Deep Clean + Protect plus Scotchgard™ Protector.

Add BISSELL Boost Prevent for enhanced performance.



Always use genuine BISSELL deep cleaning formulas. Non-BISSELL cleaning solutions may harm the machine and will void the warranty.

Customize Your Clean & Maximize Your Results

Pretreat Pesky Stains



Pretreat stains for improved deep cleaning performance.

Stains may include but are not limited to:

- » coffee
- » dirt
- » oil
- » cosmetic makeup
- » pet messes

Choose Your Formula



Prepare your deep cleaner using the dosing instructions or fill lines.

Always use genuine BISSELL deep cleaning formulas.

Non-BISSELL cleaning solutions may harm the machine and will void the warranty.

ONLY BISSELL protects from future stains with Scotchgard™ Protector.

Scotchgard™ is a trademark of 3M®

2.5 fl. oz. is equivalent to 5.0 fl. oz of non-concentrated formula.

BOOST Your Deep Clean

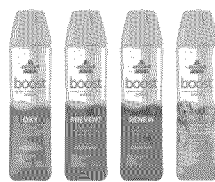

DESIGNED TO MAXIMIZE THE PERFORMANCE OF DEEP CLEANING MACHINES

BISSELL Boost OXY

Life makes messes, especially on carpet. OXY boost removes those stains from your life - permanently. Tough stains are no match for this oxygen formula.

BISSELL Boost PREVENT

Add stain-resisting power to your carpet every time you deep clean. PREVENT boost repels future stains from soaking into carpet.

BISSELL Boost RENEW

With RENEW boost, you can say goodbye to those heavily-soiled, high-traffic areas. Bring new life to dingy, matted carpet.

BISSELL Boost PET OXY

PET OXY boost removes pet stains and odors permanently. Enjoy life with your pet, stain and odor free!

BISSELL Deep Clean + Antibacterial

Fill your clean water tank with the prescribed amount of water and BISSELL Deep Clean + Antibacterial formula and deep clean as directed.

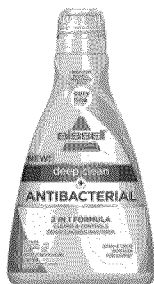

Always use genuine BISSELL deep cleaning formulas. Non-BISSELL cleaning solutions may harm the machine and will void the warranty.

Filling Your Clean Water Tank:

easy fill  formula
SYSTEM

If you're not using a formula with a yellow easy fill cap, please refer to filling instructions on page 10.

1

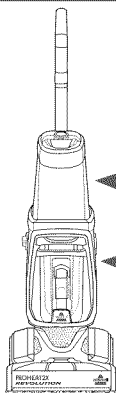

Clean Water Tank
(1 Gallon)

Dirty Water Tank

The clean water tank is at the top of the machine.

2

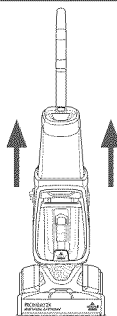

Lift the clean water tank straight up to remove from the machine.

3

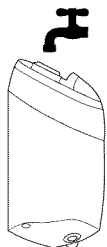

Unscrew the cap from the clean water tank. Add hot tap water to the water fill line. Twist cap back into place.

4

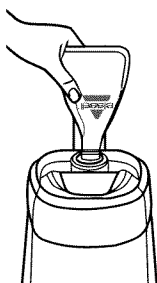

Firmly insert the formula bottle into the color coded cap on the clean water tank. Simply squeeze until formula reaches the EasyFill line.

5

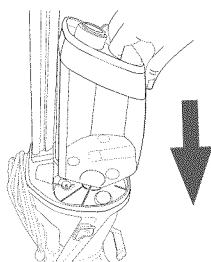

At the bottom of the upper handle, align the clean water tank with the grooves and slide the tank into place.

A few notes about filling the clean water tank:

- Fill with hot (140°F/60°C MAX) tap water and add the appropriate BISSELL solution. **DO NOT USE BOILING WATER. DO NOT HEAT WATER OR TANK IN MICROWAVE.**
- When using BISSELL Deep Clean + Antibacterial formula: Only fill your clean water tank with the recommended amount of water and formula to achieve anti-bacterial benefits.

ATTENTION

Do not over wet carpet. Be careful not to run over loose objects or edges of area rugs. Stalling the brush may result in premature belt failure.

Filling Your Clean Water Tank:

2X Concentrated Formula

1

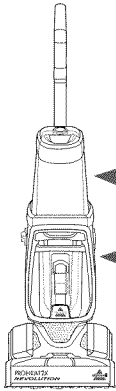

Clean Water Tank
(1 Gallon)

Dirty Water Tank

The clean water tank is at the top of the machine.

2

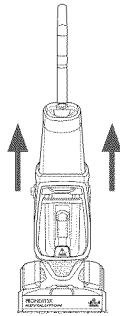

Lift the clean water tank straight up to remove from the machine.

3

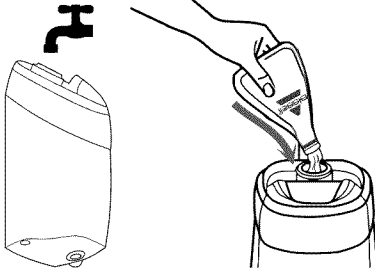

Unscrew the cap from the clean water tank. Add hot tap water to the water fill line. Next, reference the chart below for formula amounts to add to the tank. Twist cap back into place.

4

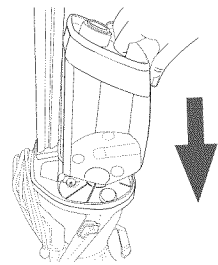

At the bottom of the upper handle, align the clean water tank with the grooves and slide the tank into place.

FORMULA FILLING INSTRUCTIONS

BISSELL 2X Concentrated Formulas

DEEP CLEAN MODE

Fill water to the Water Fill Line, then add 2.5 oz of formula.

EXPRESS CLEAN MODE

Fill water to the Water Fill Line, then add 1.25 oz of formula.

NOTE: Fill with hot (140°F/60°C MAX) tap water and add the appropriate BISSELL solution. **DO NOT USE BOILING WATER. DO NOT HEAT WATER OR TANK IN MICROWAVE.** Do not substitute BISSELL 2X Formula cleaning solution with other household cleaning products.

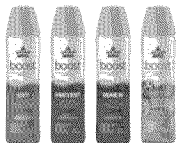

Pour in more power with BISSELL Boosts

- Fill tank with water and 2X formula (Step 3 above).
- Add 2 ounces of any BISSELL Boost per 1 gallon of water.
- The ProHeat 2X Revolution has a 1 gallon clean water tank.

Cleaning Your Carpet

1

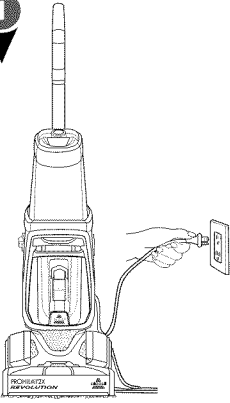

Plug into a properly grounded outlet.

2

Select cleaning mode:

Deep Clean
Delivers a deep clean to your carpet.

Express Clean
Provides a lighter clean with about 1 hour of dry time.

*Choose "Deep Clean" mode and use BISELL Deep Clean + Antibacterial to deliver antibacterial benefits.

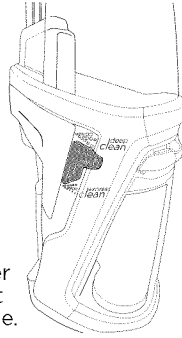

3

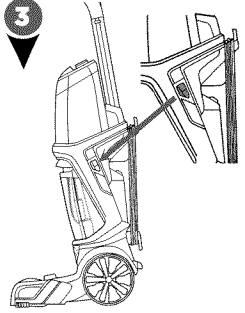

Press the power button to turn the machine on. To recline your machine for use, press the recline pedal with your foot.

4

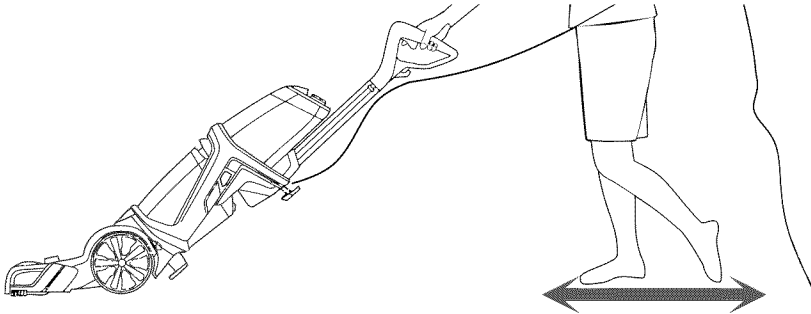

Deep Clean Mode:

1. Press the spray trigger to apply solution while making **2 slow wet passes** - 1 forward and 1 back.
2. Release the trigger.
3. Make **2 slow dry passes** - 1 forward and 1 back, to suck up the dirty solution. **(Do not hold down the trigger for this step.)**

NOTE: For best cleaning performance, clean with your machine in Deep Clean Mode.

Deep Clean Mode:

When using BISELL Deep Clean + Antibacterial Formula

1. Press the spray trigger to apply solution while making **3 slow wet passes** - 1 forward, 1 back, and 1 forward again.
2. Release the trigger.
3. Make **1 slow dry pass** back, to suck up the dirty solution. **(Do not hold down the trigger for this step.)**

Express Clean Mode:

1. Press the spray trigger to apply solution while making **2 wet passes** - 1 forward and 1 back.
2. Release the trigger.
3. Make **2 dry passes** - 1 forward, 1 back to suck up the dirty solution. **(Do not hold down the trigger for this step.)**

NOTE: In Express Clean Mode, the dirty tank will not get as full as when cleaning with Deep Clean Mode.

ATTENTION: To prevent damage to Berber carpets, avoid repeated strokes in the same area.

Cleaning Area Rugs

Important! Please check manufacturer's tag before cleaning area rugs for any specialized cleaning instructions. Not for use on silk or delicate area rugs.

Regularly clean your high-traffic area rugs in Express Clean mode to remove the forgotten dirt.

1 Select Express Clean Mode.

2 Test in a small inconspicuous area first for colorfastness.

3 Important: Keep the foot of the deep cleaner perpendicular to the rug's edge with each cleaning pass to prevent damage.

Cleaning with Hose and Tool

***Ensure the machine is upright while using the hose and tool. (The rotating brush rolls under the foot will lift off the ground.)**

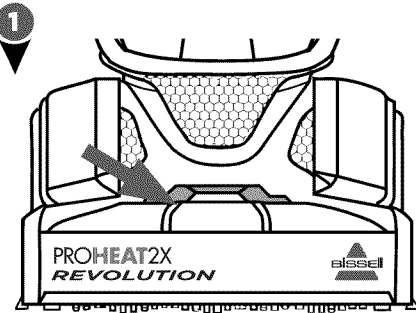

Lift the accessory hose door on top of foot on the front of the machine. The door flips toward the machine to open.

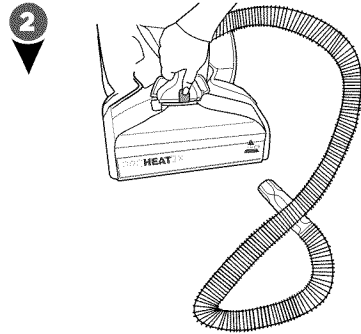

Insert the hose and snap into place. Be sure the colored hose release clip is facing out, away from machine.

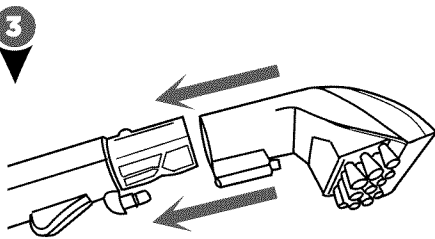

Attach the tool to the end of the hose. (Tools may vary by model.)

Press the power button to turn machine on.

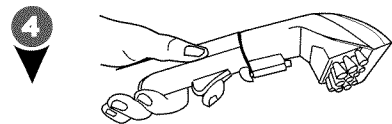

Press the spray trigger button to spray the soiled area, then slowly move tool back and forth over the area.

Release the trigger to suck up the dirty solution. Work in small sections until the area is clean.

When finished cleaning, turn the machine on to suction up warm clean water to rinse the inside of the hose and tool. Detach the hose and tool and close the accessory hose door. Let the hose and tool air dry before storing.

NOTE: If using the **Mini Deep Reach Tool**, be sure the needles of the tool are pressed down into the carpet so the spray gets into the carpet fibers.

Cleaning with the Bare Floor Tool

1

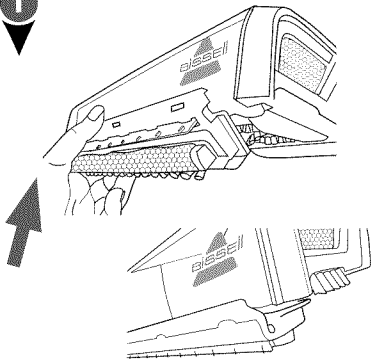

With the machine unplugged, attach the bare floor tool to the bottom of the machine by lining the tool to the edge of the nozzle. Rotate down until it clicks into place.

Follow filling instructions on page 10 and switch cleaning mode to Express Clean.

2

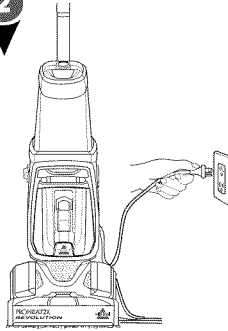

Plug into a properly grounded outlet and press the power button.

Clean by pressing the trigger for 1 wet pass forward, 1 wet pass back, and then release the trigger and make 1 dry pass forward, 1 dry pass back.

3

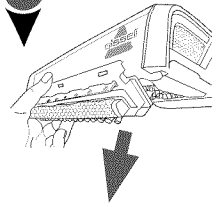

When finished, unplug the machine and remove the bare floor tool by rotating the tool up to unhook from the nozzle.

Rinse and let dry before storing. Refer to page 14 for emptying the dirty water tank. Refer to page 15 for cleaning your machine before storing.

WARNING

WARNING: To reduce the risk of fire and electric shock when cleaning a hard floor, the BISSELL bare floor tool (1606611) must be used and is only to be used with BISSELL Hard Floor Solutions formula intended for use with this appliance.

Maintenance: Empty Dirty Water Tank

⚠️ WARNING

To reduce the risk of fire, electric shock or injury, turn power OFF and disconnect plug from electrical outlet before performing maintenance or troubleshooting.

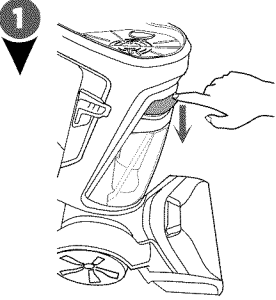

1 To release dirty water tank, press down on the colored tank handle.

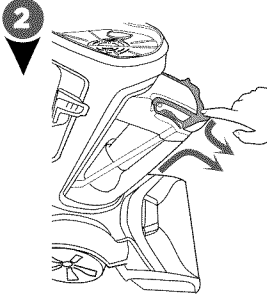

2 Tilt the tank slightly toward you. Grab the handle and tank with both hands.

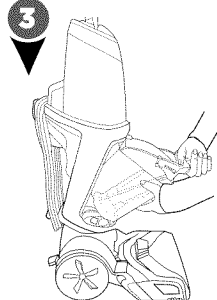

3 Pull dirty water tank up and away to remove.



4 **For quick empty:** Pull the rubber tab and tilt to pour. (Located at the corner of the top of the tank.)

When closing the rubber tab, make sure all edges are sealed tight.

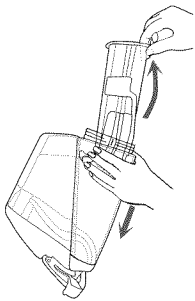

For final clean and rinse: Unscrew the ring at the bottom of tank.

Gently remove the float stack, rinse, and clean.

Once clean, return float stack into the tank by lining up the arrows so they point at each other. This is the only way the float stack will fit into the tank.

With the arrows aligned, the float stack should lock into place.

Return the ring and twist to lock. Water may leak if the ring is not fully tightened.



5 Clean the red filter below the dirty tank by wiping off any remaining dirt or debris.

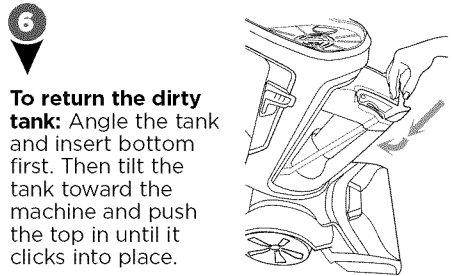

6 **To return the dirty tank:** Angle the tank and insert bottom first. Then tilt the tank toward the machine and push the top in until it clicks into place.

Did You Know?

The Float Stack is what prevents your dirty tank from overflowing.

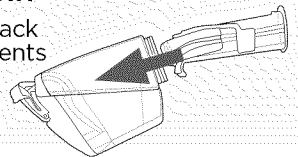

Maintenance: Cleaning Machine After Use

⚠️ WARNING

To reduce the risk of electric shock, turn power switch off and disconnect plug from electrical outlet before performing maintenance or troubleshooting checks.

1

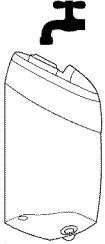

First, fill the clean water tank with warm tap water and then empty it all to rinse. Then fill again with warm tap water and return the tank to the machine.

Twist cap back on tightly.

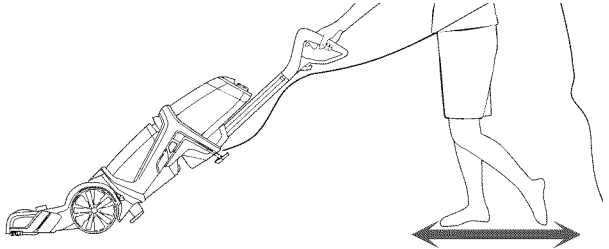

To flush and rinse the machine: Turn the machine on and press the trigger for 15 seconds while making back and forth passes on a section of carpet.

Finally, release the trigger and suck up the water.

See page 14 to clean the dirty tank from the water that was just sucked up.

Empty the clean water tank and let dry before storing.

Wipe your machine's exterior with a soft cloth.

Maintenance: Cleaning the Nozzle

1

If pet hair or debris become clogged in the nozzle, it can be cleaned out of the nozzle with the nozzle clean out tool.

Turn off and unplug the machine from the grounded outlet.

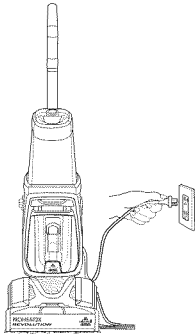

2

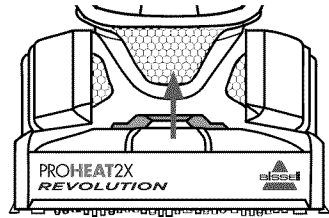

Remove the nozzle from the foot: flip the accessory hose door open and lift up on the nozzle and accessory hose door.

3

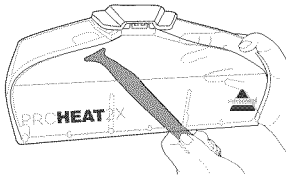

Hold the nozzle and insert the nozzle clean out tool into the thin slot, on the end of the nozzle that touches the floor. Clean until free of pet hair or debris.

4

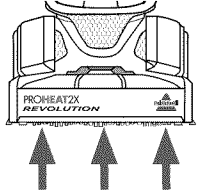

Return the nozzle back to the foot of the machine. Line up the three hooks on the nozzle to the bottom of the foot. (see arrows for location)

Rotate the nozzle up and click into place. Close the accessory hose door.

Maintenance: Cleaning the Brush Rolls

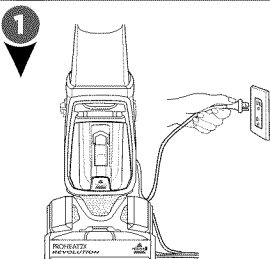

1 Turn off and unplug the machine from the grounded outlet.

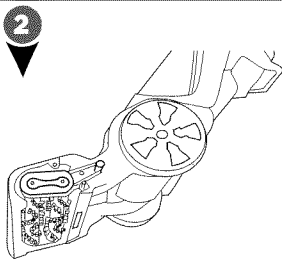

2 Lay the machine down on its back or side.

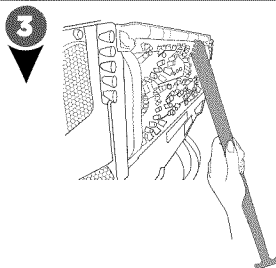

3 Use the comb to brush out the debris or hair from the brush rolls.

Maintenance: Replacing Small Belt, Large Belt, or Brush Rolls

What you will need: 1 Phillips screwdriver & 1 flathead screwdriver

1 Remove the clean water tank and make sure the dirty water tank is empty, then press the recline pedal and lay the machine on its side. Remove the 3 screws on the belt/brush access plate using the Phillips screwdriver. Remove the plate to expose the belt.

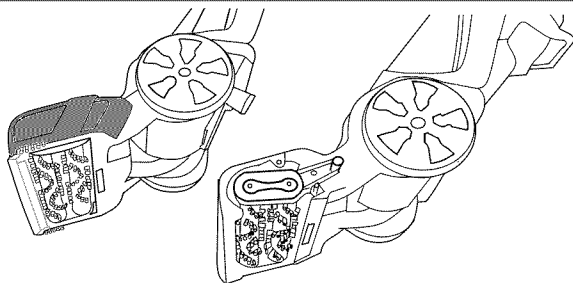

2 Small belt removal and/or brush roll replacement

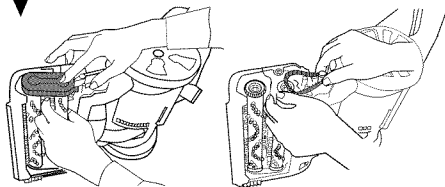

Remove the brush cover by lifting it up, then lift the belt to remove. The brush rolls can be gently removed and replaced with new brush rolls. (skip to step 7 for small belt replacement.)

NOTE: There is a small belt and end cap on the other end of the brush rolls. That belt needs to wrap around the tooth end of the brush rolls and the end cap needs to be secure before re-assembling the machine.

3 Large wheel belt replacement

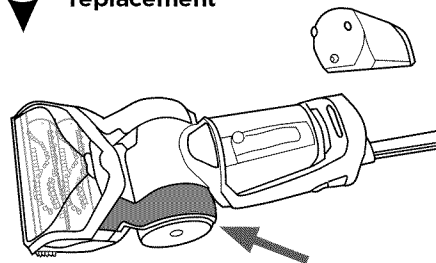

Make sure to press the recline pedal and lay the machine on its back. Use a flathead screwdriver to help lift the belt access door and remove.

NOTE: Must use force to lift the belt access door.

NOTE: If the belt is not broken, skip to step 7.

Maintenance: Replacing Small Belt, Large Belt, or Brush Rolls (continued)

4

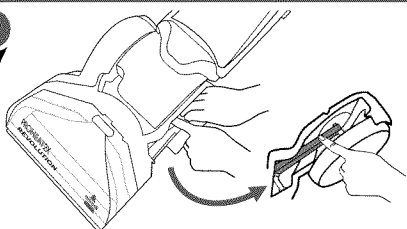

If the belt is broken, gently remove it from the machine.

5

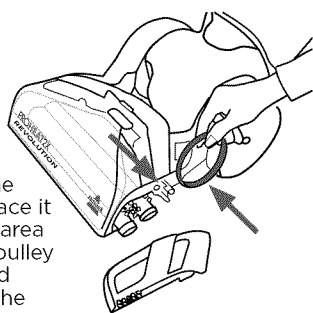

To replace the large belt, place it over the red area of the large pulley that is toward the front of the machine.

6

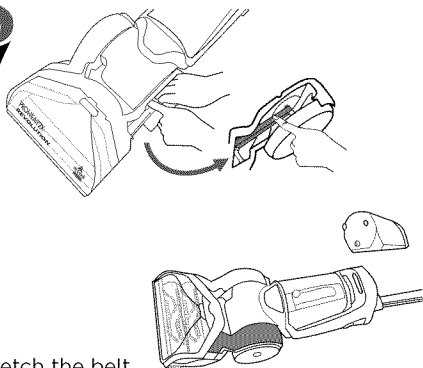

Stretch the belt towards the back of the machine with your thumb and transfer it onto the metal axle.

Snap the belt access door back into place.

7

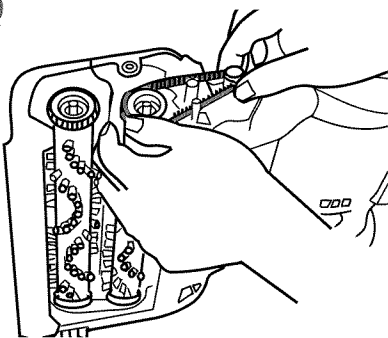

Replace smaller-toothed belt by wrapping around the small metal-toothed pulley, and the gear at the end of the rear-most brush.

8

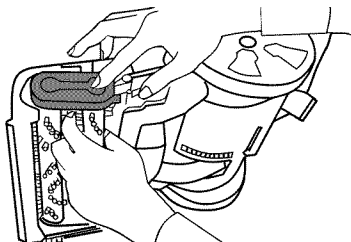

Replace the brush cover, making sure the brushes are aligned and the cover is secure.

NOTE: It is important that the brush rolls are aligned on both ends of the foot.

9

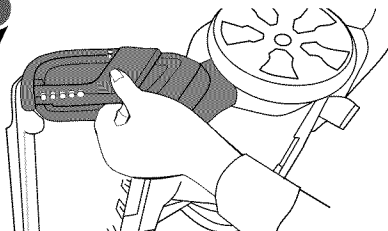

Return the belt/brush access plate to the end of the brush rolls. You should hear it "click" into place when the screws align. Using a screw driver, secure the plate with the three screws.

Troubleshooting

WARNING

To reduce the risk of electric shock, turn power switch off and disconnect plug from electrical outlet before performing maintenance or troubleshooting checks.

Problem	Possible causes	Remedies
Reduced spray OR no spray	Clean water tank may be empty	Refill tank
	Clean water tank may not be seated completely	Turn power OFF. Remove and reseat tank
	Pump may have lost prime in hose cleaning mode	Hold end of hose below water level in tank to prime
Loss of suction power	Tanks may not be seated properly	Pick up both tanks and reseat them so they fit properly on the unit
	Dirty tank has picked up maximum amount of dirty water and has reached full line	Empty dirty tank
	Clean water tank is empty	Check fluid levels in the clean water tank. Refill the tank if it is empty
	Rubber tab on dirty water tank is not sealed tight	Check the rubber tab on the dirty water tank and press firmly on all edges to secure it tightly (see step 4 on page 14 for detail)
	Accessory Hose Door may not be closed tightly in place	Check the Accessory Hose Door and make sure it is closed tightly - it should be locked into place
	Nozzle may be clogged from pet hair or debris	Use the nozzle clean out tool and follow steps on page 15 for "Cleaning Nozzle"

Helpful Hints: Drying Carpet & Returning Furniture

- » Clean on a day with low humidity to help carpets dry faster.

While Cleaning

- » Turn on any available ceiling fans and make sure the room is well ventilated to help the airstream in your home.
- » Additional dry strokes will aid in faster drying of carpet. The two exceptions are when using Express Clean Mode or when using DeepClean + Antibacterial formula. With these exceptions, the directions need to be followed exactly

After Cleaning

- » Use a portable fan directed towards the surface of the carpet and/or a dehumidifier to aid in drying carpet.
- » Adjust your heat up a few degrees in winter and use your air conditioning for dryer air in the summer.
- » On warm dry days, simply opening the windows can be an eco-friendly option to assist in drying carpet.
- » When the carpet feels dry to the touch, return furniture that was removed. To be sure to avoid staining, place wax paper or aluminum foil under the legs. Wait at least another three hours before removing wax paper or foil.



For more helpful tips and videos, check out BISSELL.com

Warranty

This warranty gives you specific legal rights, and you may also have other rights which may vary from state to state. If you need additional instruction regarding this warranty or have questions regarding what it may cover, please contact BISSELL Consumer Care by E-mail, telephone, or regular mail as described below.

Limited Three-Year Warranty

Subject to the *EXCEPTIONS AND EXCLUSIONS identified below, upon receipt of the product BISSELL will repair or replace (with new or remanufactured components or products), at BISSELL's option, free of charge from the date of purchase by the original purchaser, for three years any defective or malfunctioning part.

See information below on "If your BISSELL product should require service".

This warranty applies to product used for personal, and not commercial or rental service. This warranty does not apply to fans or routine maintenance components such as filters, belts, or brushes. Damage or malfunction caused by negligence, abuse, neglect, unauthorized repair, or any other use not in accordance with the User's Guide is not covered.

BISSELL IS NOT LIABLE FOR INCIDENTAL OR CONSEQUENTIAL DAMAGES OF ANY NATURE ASSOCIATED WITH THE USE OF THIS PRODUCT. BISSELL'S LIABILITY WILL NOT EXCEED THE PURCHASE PRICE OF THE PRODUCT.

Some states do not allow the exclusion or limitation of incidental or consequential damages, so the above limitation or exclusion may not apply to you.

*EXCEPTIONS AND EXCLUSIONS FROM THE TERMS OF THE LIMITED WARRANTY

THIS WARRANTY IS EXCLUSIVE AND IN LIEU OF ANY OTHER WARRANTIES EITHER ORAL OR WRITTEN. ANY IMPLIED WARRANTIES WHICH MAY ARISE BY OPERATION OF LAW, INCLUDING THE IMPLIED WARRANTIES OF MERCHANTABILITY AND FITNESS FOR A PARTICULAR PURPOSE, ARE LIMITED TO THE THREE YEAR DURATION FROM THE DATE OF PURCHASE AS DESCRIBED ABOVE.

Some states do not allow limitations on how long an implied warranty last so the above limitation may not apply to you.

NOTE: Please keep your original sales receipt. It provides proof of date of purchase in the event of a warranty claim.

Service

If your BISSELL product should require service:

Contact BISSELL Consumer Care to locate a BISSELL Authorized Service Center in your area.

If you need information about repairs or replacement parts, or if you have questions about your warranty, contact BISSELL Consumer Care.

Website:

www.BISSELL.com/service-centers

E-mail:

www.BISSELL.com/email-us

Call:

BISSELL Consumer Care
1-800-237-7691

Monday - Friday 8am - 10pm ET

Saturday 9am - 8pm ET

Sunday 10am - 7pm ET

Please do not return this product to the store.

Other maintenance or service not included in the manual should be performed by an authorized service representative.

For any questions or concerns, BISSELL is happy to be of service. Contact us directly at 1-800-237-7691.

Register your product today!

Registering is quick, easy and offers you benefits over the lifetime of your product.

You'll receive:

BISSELL Rewards Points

Automatically earn points for discounts and free shipping on future purchases.

Faster Service

Supplying your information now saves you time should you need to contact us with questions regarding your product.

Product Support Reminders and Alerts

We'll contact you with any important product maintenance reminders and alerts.

Special Promotions

Optional: Register your email to receive notice of offers, contests, cleaning tips and more!

Visit www.BISSELL.com/registration now!

Visit us online at: **BISSELL.com**

When contacting BISSELL, have model number of cleaner available.

Please record your

Model Number: _____

Please record your

Purchase Date: _____

NOTE: Please keep your original sales receipt. It provides proof of purchase date in the event of a warranty claim. See Warranty on page 19 for details.

We can't wait to hear from you!

We really do read your comments, tweets, and posts.

Rate this product on BISSELL.com

or any of our retailer sites and let us (and millions of your closest friends) know what you think!

Parts & Supplies

For Parts and Supplies, go to BISSELL.com and enter your model number in the search field.

For cleaning tips and more visit www.BISSELL.com or find us at:



BISSELL



BISSELLClean



BISSELLClean



BISSELL



BISSELL



©2015 BISSELL Homecare, Inc
Grand Rapids, Michigan
All rights reserved. Printed in China
Part Number 160-6104 Rev 05/15 RevF
Visit our website at: www.BISSELL.com
Scotchgard is a trademark of 3M