

# Refrigerator user manual

the possibilities

Thank you for purchasing this Samsung product.  
To receive more complete service,  
please register your product at  
[www.samsung.com/register](http://www.samsung.com/register)



# Features of your new Refrigerator

---

## KEY FEATURES OF YOUR NEW REFRIGERATOR

---

Your Samsung French Door Refrigerator comes equipped with various innovative storage and energy-efficient features.

- **Twin Cooling System**  
The Refrigerator and Freezer have separate evaporators. Due to this independent cooling system, the Freezer and Refrigerator cool more efficiently. Additionally, this separate air flow system prevents food odor of one compartment from seeping into other compartments.
- **7inch LCD**  
An easy access interface for users with a Touch Screen Panel
- **Cool Select Pantry™**  
The Cool Select pantry™ is a full-width drawer with adjustable temperature control.
- **Bigger & Wider Space**  
The wide shelf area and pantry provide enough space for larger items like a pizza box, etc. The wide freezer drawer also provides enough space for 2~3 turkeys.
- **Secure Auto Close**  
The Secure Auto Close feature will automatically close a door that is slightly open.
- **Compact Ice Maker**  
The Ice maker can dispense cubed or crushed ice.
- **Digital Display and Temperature Control**
- **Water Filtration System**
- **Door Alarm**  
A helpful beeper alerts you if a door is ajar.
- **Tilting Pocket**  
The Tilting pocket can be used to store up to a 16" pizza.
- **Auto Pull Out Drawer**  
The upper drawer in the freezer comes out automatically as you just open the freezer door.
- **Super Extended Drawer**  
The upper drawer can be pulled out to the Tilting Pocket.
- **Easy Handle**  
Freezer door can be opened with less effort.
- **Energy Star**  
This Energy star labeled product may save you money on your energy costs.



For easy future reference, write the model and serial number down. You will find your model number and serial number on the left side of the refrigerator.

Model # \_\_\_\_\_

Serial # \_\_\_\_\_











# Safety Information

## SAFETY INFORMATION

Before using your new Samsung French Door Refrigerator, please read this manual thoroughly to ensure that you know how to safely and efficiently operate the features and functions that your new appliance offers.

Because the following instruction covers various models, the characteristics of your Refrigerator may differ slightly from the Refrigerator described in this manual. If you have any question, contact us at 1-800-SAMSUNG or find help and information online at [www.samsung.com](http://www.samsung.com).

What the icons and signs in this user manual mean :

 WARNING	Hazards or unsafe practices that may result in <b>severe personal injury or death</b> .
 CAUTION	Hazards or unsafe practices that may result in <b>minor personal injury or property damage</b> .
 CAUTION	To reduce the risk of fire, explosion, electric shock, or personal injury when using your refrigerator, follow these basic safety precautions:
	Do NOT attempt.
	Do NOT disassemble.
	Do NOT touch.
	Follow directions explicitly.
	Unplug the power plug from the wall socket.
	Make sure the machine is grounded to prevent electric shock.
	Call the service center for help.

**These warning signs are here to prevent injury to you and others.**

**Please follow them explicitly**

**Keep this manual in a safe place for future reference.**

## SEVERE WARNING SIGNS

 **Do not plug several appliances into the same power receptacle.**

- Large appliances draw a lot of power. Powering more than one appliance or machine from a single power source could cause overheating and cause a fire.

**Make sure that the power plug is not kinked or damaged by the back of the Refrigerator.**

- A damaged power plug may overheat and cause a fire.

**Do not spray water directly into or on the outside of the Refrigerator/Freezer drawer.**

- Water could get into the interior machine parts and cause electric shock.

**Do not use aerosols near the Refrigerator.**

- Aerosols used near the Refrigerator may cause an explosion or fire.

# Safety Information

---

**Do not put undue stress on the power cord or place heavy articles on it.**

- Placing heavy articles on the power cord may create the risk of explosion or fire.

**Do not insert the power plug with wet hands.**

- It may cause electric shock.

**Do not put a container filled with water on the Refrigerator.**

- If it spills, it may cause fire or electric shock.

**Do not install the Refrigerator in a damp place or place where it may come in contact with water.**

- Wet and/or deteriorated insulation of the internal electrical parts may cause electric shock or fire.

**Do not store volatile or flammable substances in the Refrigerator.**

- Storing benzene, thinner, alcohol, ether, LP gas and other such products may cause explosions.

 **Do not disassemble or repair the Refrigerator by yourself.**

- You may run the risk of fire, appliance malfunctions and/or personal injury. Call your nearest service center for help from a qualified service technician.
- When the interior or exterior LED lamp has gone out, please contact your service agents.

 **Unplug the Refrigerator before changing the interior light.**

- Changing the light while the Refrigerator is plugged in may cause electric shock.

**If you wish to dispose of the Refrigerator, remove the doors and seals before throwing it away.**

- The doors(and their seals) can entrap a child if they climb into the Refrigerator. Make sure that the doors are off, and ensure that no one is suffocated by being locked inside.

 **The Refrigerator must be safely grounded**

- Always make sure that you have grounded the Refrigerator before attempting to investigate or repair any part of the appliance. Power leakages can cause severe electric shock.

**Never use gas pipes, telephone lines or other potential lightning attractors as an electrical ground.**

- Improper use of the grounding plug can result in a risk of electric shock. If it is necessary to use an extension cord to power the Refrigerator, use only a 3-wire extension cord that has a 3-blade ground plug and a 3-slot receptacle that will accept the plug on the appliance. The marked rating of the extension cord should be AC 115V~120V, 10A, or more. Additionally, if a grounding adapter is used, make sure the receptacle box is also fully grounded.

## CAUTION SIGNS

---



### **Use good judgment when filling the Refrigerator with food and drinks.**

- In an overfull Refrigerator, heavy, fragile, bulky or breakable items may fall out and cause personal injury and/or damage to surrounding objects.

### **Do not put bottles or glass containers in the Freezer drawer.**

- When the contents freeze and then expand, the glass may break and cause personal injury or leave dangerous glass shards in the Freezer.

### **If the electrical wall socket is loose, do not insert the power plug.**

- There is a risk of electric shock or fire. Have the plug looked at by a licensed electrician.



### **Never unplug your Refrigerator by pulling on the power cord.**

- Always grip the power cord firmly and pull straight out from the outlet. Yanking or pulling on the power cord may cause a short-circuit, fire and/or electric shock.
- A damaged power cord must be replaced by the manufacturer, a certified service agent or qualified service personnel.

### **Do not store articles on the top of the appliance.**

- When you open or close the door, the articles may fall and cause personal injury and /or damage to surrounding objects.

### **Do not store pharmaceutical products, scientific materials and temperature-sensitive products in the refrigerator.**

- Products that require exact temperature controls should not be stored in the Refrigerator.



CAUTION

**Do not allow children to climb, stand or hang on shelves and handles of the Refrigerator. They could damage the Refrigerator and seriously injure themselves. Do not sit on the freezer door. The door may break. Do not allow children to climb into the freezer basket.**



**If you notice a chemical or burning plastic smell or see smoke, unplug the Refrigerator immediately and contact your Samsung Electronics Service Center.**



**After your Refrigerator is in operation, do not touch the cold surfaces in the Freezer compartment. Particularly when hands are damp or wet, skin may adhere to these extremely cold surfaces.**

- Skin may stick to the surface and you may get frostbite.

### **Do not put your hands under the appliance.**

- Any sharp edges may cause personal injury.

# Safety Information

---

**Never put fingers or other objects into the water dispenser hole or ice chute.**

- It may cause personal injury and/or material damage.

 **If the Refrigerator will not be used for a long period of time (for example, over several months), unplug the power from the wall.**

- Over time, deterioration in the power cord insulation may cause fire.

 **Do not use a wet or damp cloth when cleaning the plug.**

**Remove any dust or foreign matter from the power plug pins.**

- A dirty power plug can increase the risk of fire.

**If the Refrigerator is disconnected from the power supply, you should wait for at least five minutes before plugging it back in.**

 **Do not place the refrigerator directly in sunlight.**

**The appliance must be positioned for easy access to power source.**

**If the power cord is damaged, it must be replaced by the manufacturer, a certified service agent or qualified service personnel.**

**If you have a long vacation planned, empty the Refrigerator and turn it off.**

- Wipe excess moisture from the inside and leave the doors open to keep odor and mold from developing.

 **Service warranty and Modification**

- Any changes or modifications performed by a 3rd party on this finished appliance is not covered under Samsung warranty service, nor can Samsung be responsible for safety issues that result from 3rd party modifications.



**Children can get trapped inside Refrigerators.**

**Before you throw away your old Refrigerator or Freezer, make sure that you;**

- Take off the doors.
- Leave all shelves in places so that children may not easily climb inside and shut the door while they are inside.

 **This appliance is not intended for use by small children or infirm persons without capable, adult supervision. Small children should be supervised when using the appliance.**

 **Do not block air holes**

- If the air holes are blocked, especially with a plastic bag, the refrigerator can be over cooled. If this cooling period lasts too long, the water filter may break and cause water leakage.

# Contents

---

## **SETTING UP YOUR FRENCH DOOR REFRIGERATOR**

08

- 08 Getting ready to install the refrigerator
- 09 Removing the refrigerator doors
- 11 Disassemble the freezer drawer
- 12 Reattaching the refrigerator doors
- 14 Assemble the freezer drawer
- 15 Adjusting the doors
- 16 Making minor adjustments between doors
- 17 Adjusting the freezer drawer level
- 18 Checking the water dispenser line
- 19 Installing the water line

## **OPERATING YOUR SAMSUNG FRENCH DOOR REFRIGERATOR**

21

- 21 Digital panel
- 21 View of panel
- 22 Plug in.
- 22 How to calibrate touch point.
- 23 Slide Show.
- 24 Home.
- 24 Dispenser.
- 26 Child Lock.
- 27 Cooling off.
- 28 Door open Alarm.
- 28 Calendar.
- 29 Temp. Control.
- 31 Water Filter.
- 32 Photo Album.
- 36 Nutrition Facts.
- 37 Conversions.
- 37 Settings.
- 42 Parts and features
- 43 Storing food in the refrigerator
- 43 Storing food in the freezer drawer
- 44 Using the Cool Select Pantry™
- 45 Removing the refrigerator accessories
- 46 Using the doors
- 46 Using the tilting pocket
- 47 Removing the freezer accessories
- 48 Cleaning the refrigerator
- 49 Changing the interior lights
- 50 Water filter chart
- 51 Water filter certification
- 52 Food storage tips

## **TROUBLESHOOTING**

54

- 54 Troubleshooting

## **WARRANTY**

56

- 56 Warranty

# Setting up your French Door Refrigerator

## GETTING READY TO INSTALL THE REFRIGERATOR

Congratulations on your purchase of the Samsung French Door Refrigerator. We hope you enjoy the state-of-art features and efficiencies that this new appliance offers.

### Selecting the best location for the Refrigerator

- A location with easy access to the water supply.
- A location without direct exposure to sunlight.
- A location with level (or nearly level) flooring.
- A location with enough space for the Refrigerator doors to open easily.
- Allow sufficient space to the right, left, back and top for air circulation. If the Refrigerator does not have enough space, the internal cooling system may not work properly.
- Please ensure that appliance can be moved freely in the event of maintenance & service.

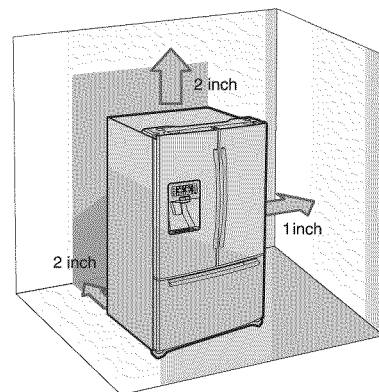

If your refrigerator has an ice maker, allow extra space at the back for the water line connections. When you install the refrigerator next to a fixed wall, minimum clearance is 3 3/4" (95mm) between the refrigerator and wall to allow the door to swing open.

First thing! Make sure that you can easily move your Refrigerator to its final location by measuring doorways (both width and height), thresholds, ceilings, stairways, etc.

The following chart details the exact height and depth of Samsung French Door Refrigerator.

MODEL		RFG299**	
Dimension (inches/mm)	Width (A)		35 5/8 (912mm)
	Case Height	with Hinge (B)	69 7/8 (1775mm)
		without Hinge (C)	68 1/8 (1730mm)
	Depth	with Door (D)	35 7/8 (912mm)
		without Door (E)	28 7/8 (734mm)

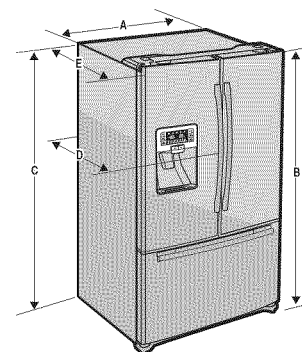

- ☑ Allow clearance to the right, left, back and top when installing. This will help reduce power consumption and keep your energy bills lower.
- Do not install the Refrigerator where the temperature will go below 50°F (10°C).

**CAUTION**  **When moving your refrigerator**  
To prevent floor damage be sure the front leveling legs are in the up position (above the floor). Refer to 'Leveling the refrigerator' in the manual (at page 15)

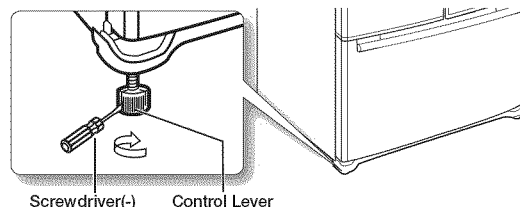

### FLOORING

For proper installation, this refrigerator must be placed on a level surface of hard material that is the same height as the rest of the flooring. This surface should be strong enough to support a fully loaded refrigerator, or approximately 660lbs(299kg). To protect the finish of the flooring, cut a large section of the cardboard carton and place under the refrigerator where you are working. When moving, be sure to pull the unit straight out and push back in straight.

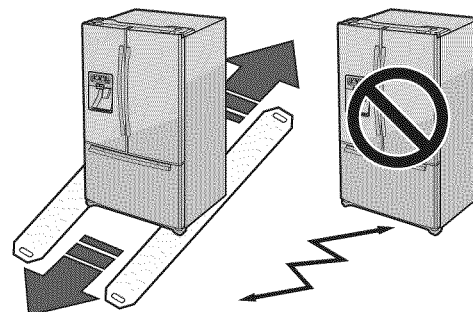



## SETTING UP THE REFRIGERATOR

Now that you have your new Refrigerator installed in place, you are ready to set up and enjoy the features and functions of the appliance. By completing the following steps, your Refrigerator should be fully operational.

1. Place the Refrigerator in an appropriate location with reasonable clearance between the wall and the Refrigerator. Refer to installation instructions in this manual.
2. Once the Refrigerator is plugged in, make sure the interior light comes on when you open the doors.
3. Set the Temperature control to the coldest temperature and wait for an hour. The Freezer will get slightly chilled and the motor will run smoothly.
4. After powering the Refrigerator, it will take a few hours to reach the appropriate temperature. You can store food and drinks in the Refrigerator after the temperature is sufficiently cool.

 Check the accessory list below.



Water filter  
(DA29-00003G)

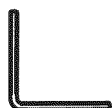

Hex wrench  
(DA80-00002C)



Fastener  
(DA60-00143B)



Compression fitting  
(DA62-00305A)



Compression nut  
(DA74-00070B)

## REMOVING THE REFRIGERATOR DOORS

If the Refrigerator is too large to pass through your doorway easily, you can remove the refrigerator doors.

### Tools you will need

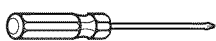

Phillips screwdriver

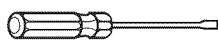

Flat-blade screwdriver

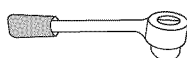

Wrench



Pliers



Allen wrench(3/16")  
(5mm)

### Disassemble the Refrigerator doors

1. With the door opened, remove the Hinge Cover cap (1) with a Flat head screwdriver, and close the door.

Remove the 3 screws holding down the Hinge Cover and remove the Hinge Cover (2).

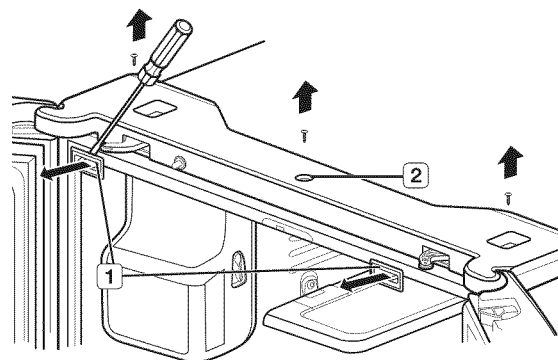

# Setting up your French Door Refrigerator

2. Disconnect two connectors (3) at each side of the top cap and the one connector (4) on left side door. Remove the tube (5) with pressing the dark gray color part (6) of the water line coupler.



If a red clip is on the coupler, it must be removed before removing the tube.

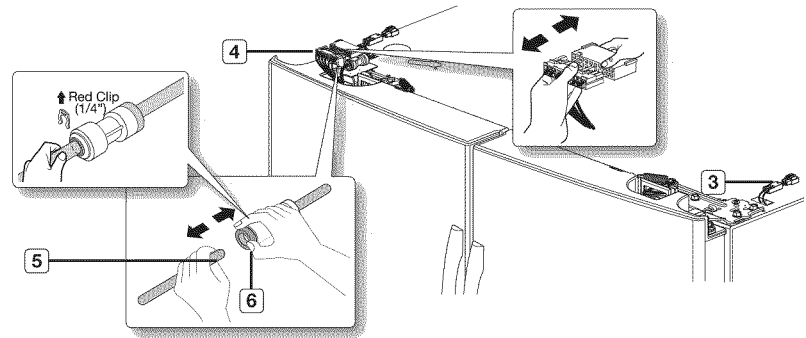

3. Remove the 3 hex head bolts (7) attached to the upper left and right door hinges with a wrench (13/32"). With a Philips head screwdriver, remove the ground screw (8) attached to the upper left and right door hinges. Remove the upper left and right door hinges (9).

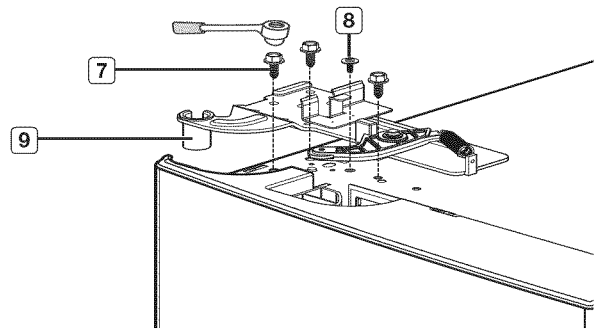

4. Lift the door straight up to remove.

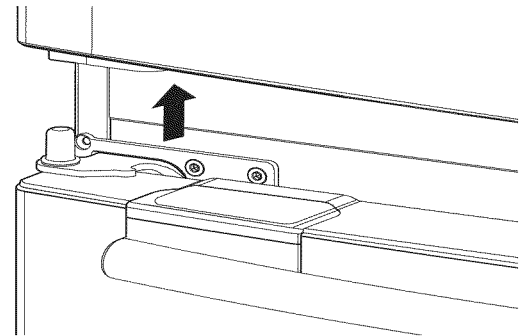

5. With a Philips head screwdriver, remove the screw (10) attached to the lower left and right door hinges. With a wrench (3/16"), remove the two hex head bolts (11) attached to the lower left and right door hinges. Remove the lower left and right door hinges (12).

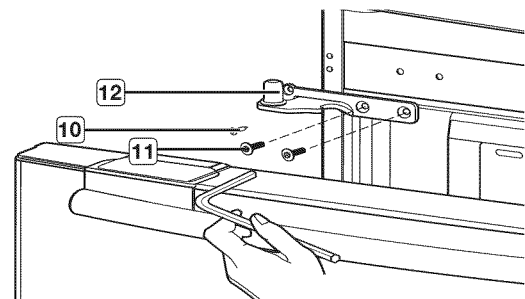

## DISASSEMBLE THE FREEZER DRAWER

1. Take out the upper drawer by lifting it up.

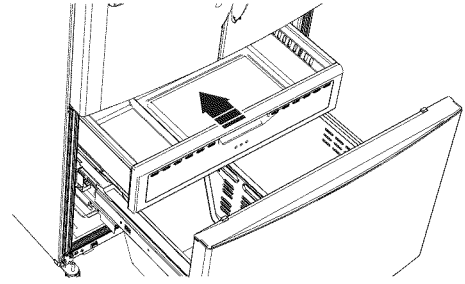

2. Remove the tilting pocket(1) by pulling on both brackets(2) upward at the same time.

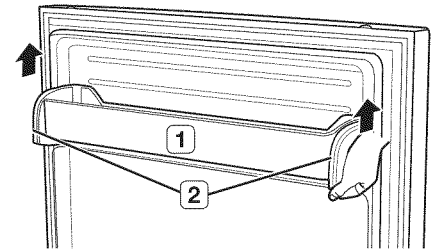

3. Take out the lower basket(3) by lifting the basket up from the rail system.

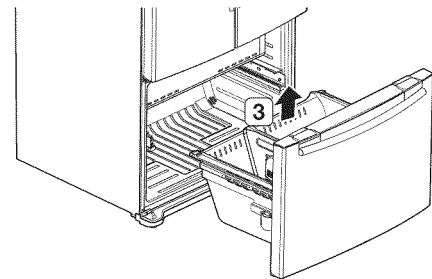

4. Remove four 10mm hex-head bolts from both sides.

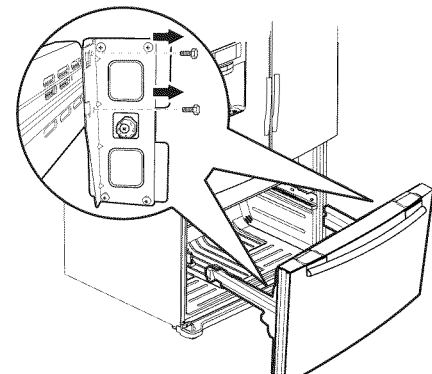

5. Lift the freezer door up from the rails.

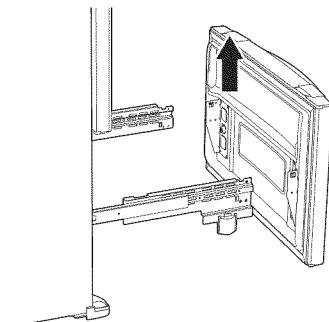

# Setting up your French Door Refrigerator

## REATTACHING THE REFRIGERATOR DOORS

### Assemble the Refrigerator doors

1. Reattach the lower left and right door hinges (12).  
With a Philips head screwdriver, insert and tighten the screw (10) into the lower left and right door hinges.  
With a wrench (13/16"), insert and tighten the 2 hex head bolts (11) into the lower left and right door hinges.

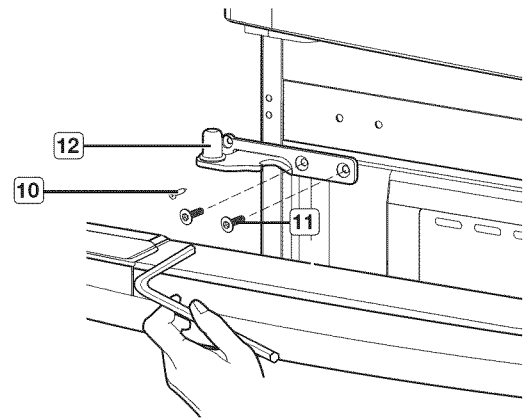

2. Place the hole in the bottom of the door over the lower hinge (12).

 Be careful not to miss the hinge cap because it can be easily taken off.

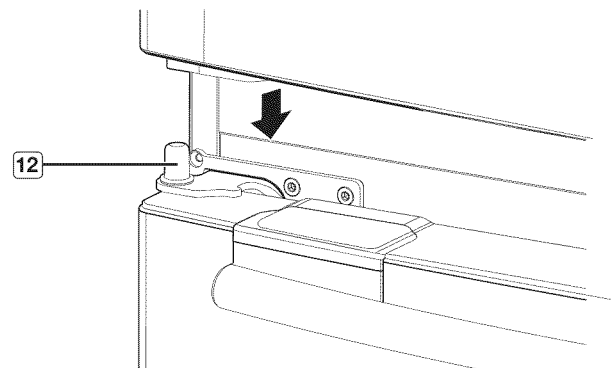

3. Insert the upper hinges (9) into the holes at the top of the doors.  
With a wrench (13/32"), insert and tighten the 3 hex head bolts (7) into the upper left and right door hinges.  
With a philips head screwdriver, insert and tighten the ground screw (8) into the upper left and right door hinges.

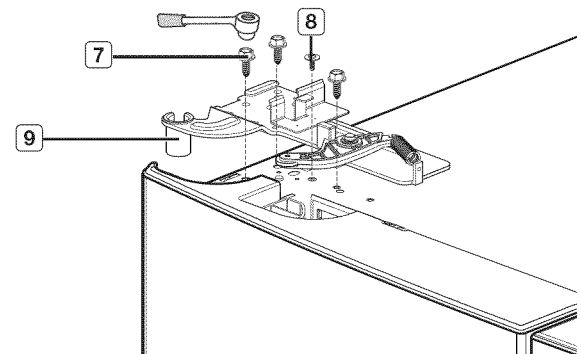

# Setting up your French Door Refrigerator

## REATTACHING THE REFRIGERATOR DOORS

4. Connect the water line (5) and then insert a clip on the coupler with pulling tube. Connect the one connector (4) on left side door and two connectors (3) at each side of the top cap.

 The clip is enveloped inside of the top cap.

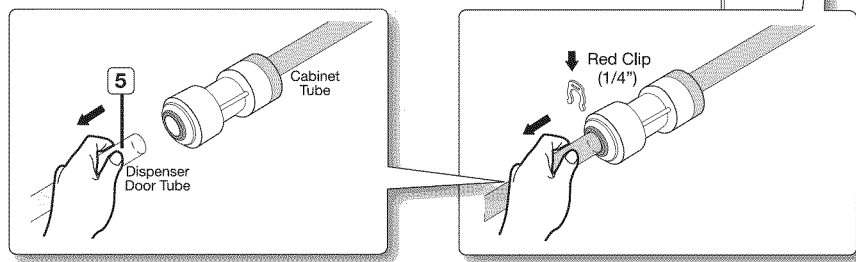

The water line (5) must be fully inserted to the marked line to prevent water leakage from the dispenser.

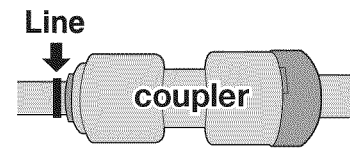

5. Position the Top Table (2) in place. With a philips head screwdriver, insert and tighten the 3 screws into the Hinge Cover. With the door opened, reinsert the Hinge Cover cap (1) and close the doors.

 When reattaching the hinge cover, make sure that the wires are not pressed or damaged by the hinge cover.

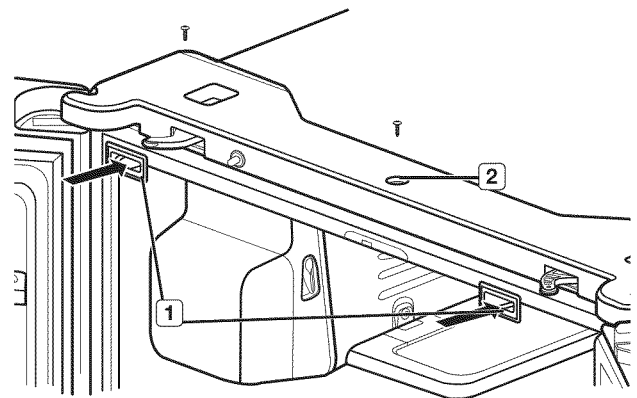

# Setting up your French Door Refrigerator

## ASSEMBLE THE FREEZER DRAWER

1. Pull out the rails fully on each side of the cabinet.

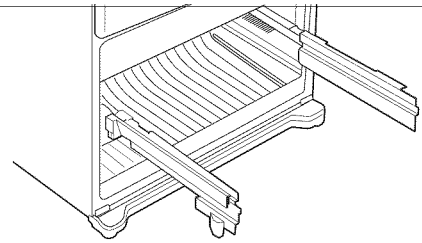

2. Attach the freezer door front onto the open slots on the sides.

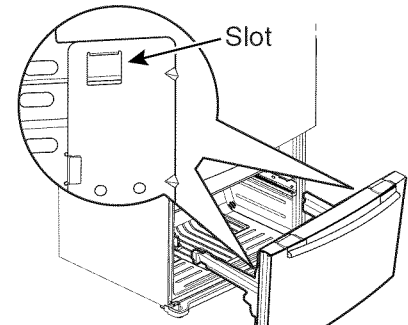

3. Tighten 4 hex head bolts completely with a socket wrench(7/16inch).

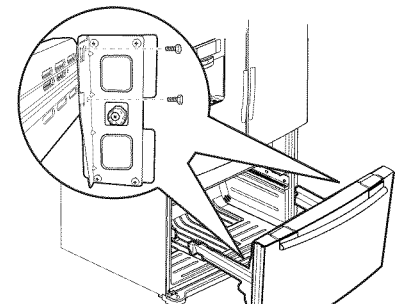

4. Insert the lower basket (6) into the rail system.

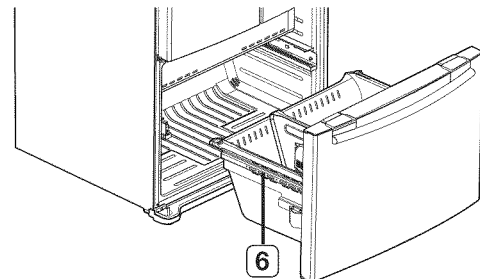

5. Hook the ends of the tilting pocket (7) onto the support guard and push down until they lock into place.

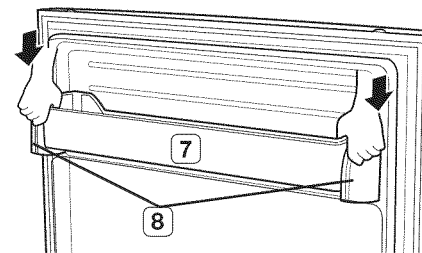

6. Insert the upper drawer.

- Remove 2 pieces of tape (1) attached to the side of the drawer bin. Reattach the tape in the same position when moving the refrigerator to prevent scratching the drawer bin.

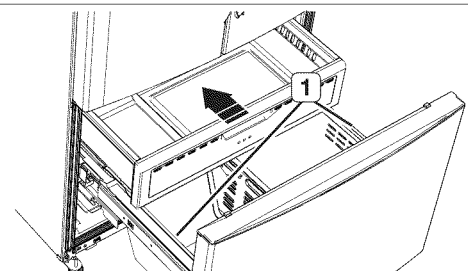

## ADJUSTING THE DOORS

---

Now that the doors are back on the Refrigerator, you want to make sure the Refrigerator is level so that you can make final adjustments. If the Refrigerator is not level, it will not be possible to get the doors perfectly even.

### When the Left door is lower than the Right door.

Insert a flat-blade screwdriver into a notch on the left control lever, turn it clockwise or counter-clockwise to level the left door.

---

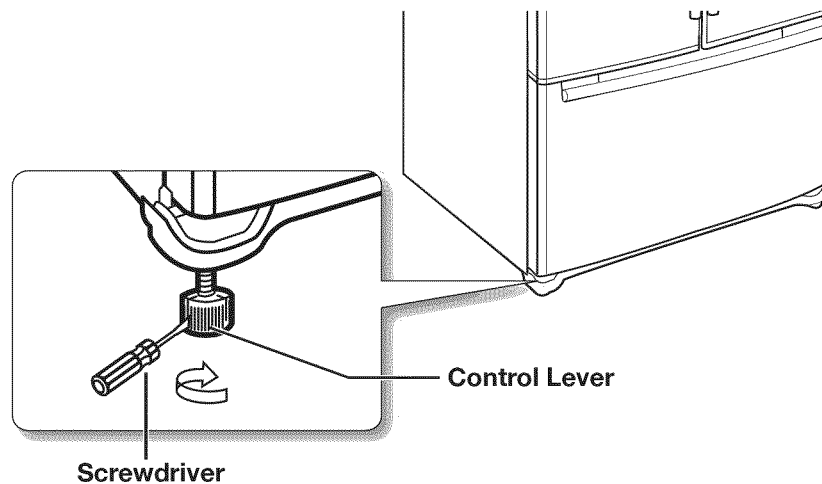

### When the Left door is higher than the Right door.

Insert a flat-blade screwdriver into a notch on the right control lever, turn it clockwise or counter-clockwise to level the right door.

---

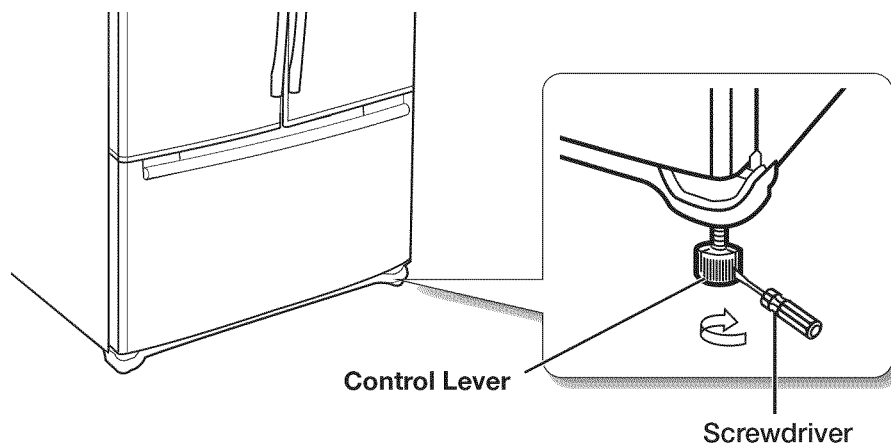

 We do not recommend making small adjustments with the control lever. Instead, refer to the next page for the best way to make minor adjustments to the doors.

# Setting up your French Door Refrigerator

## MAKING MINOR ADJUSTMENTS BETWEEN DOORS

Remember a level Refrigerator is necessary for getting the doors perfectly even. If you need help, review the previous section on leveling the Refrigerator.

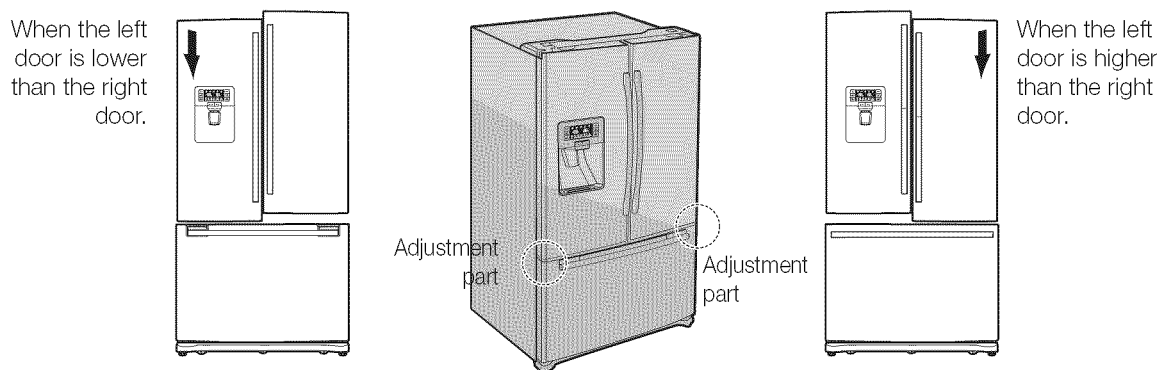

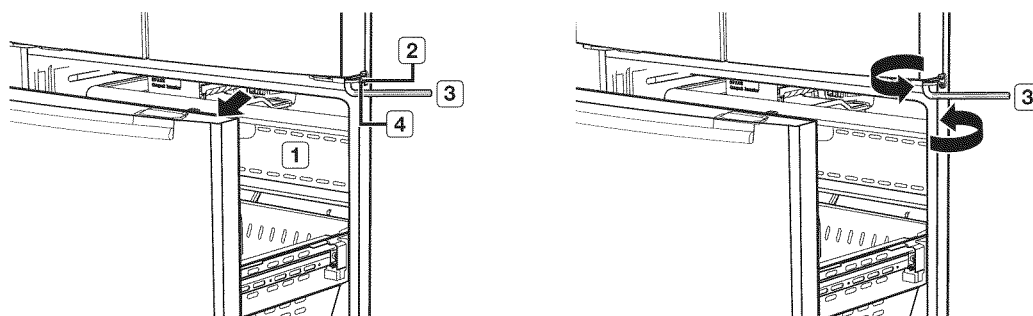

1. If you open the drawer ((1)), you can see the lower hinge ((2)).
2. Insert the supplied hex wrench ((3)) into the shaft ((4)) of the lower hinge.
3. Please adjust the height by turning the hex wrench ((3)) clockwise (↻) or counter-clockwise (↺).

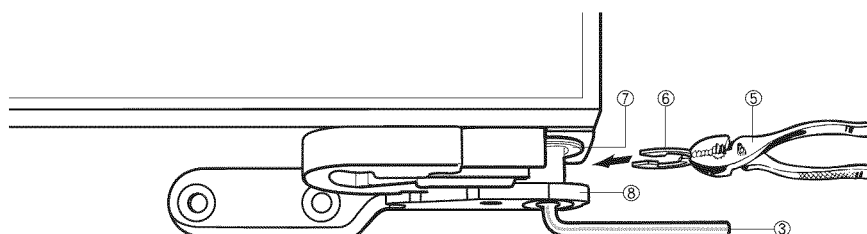

 When you turn the hex wrench counter-clockwise(↺), the door will move up.

1. After adjusting the doors, please insert the supplied fastener-ring ((5)) using a pair of pliers ((6)) in the gap between the hinge-grommet ((7)) and the lower hinge ((8)). The number of fastener-rings you'll need to insert depends on the gap.



 Two fastener-rings are enclosed with the refrigerator.  
The thickness of each fastener-ring is 0.04 inch.



# ADJUSTING THE FREEZER DRAWER LEVEL

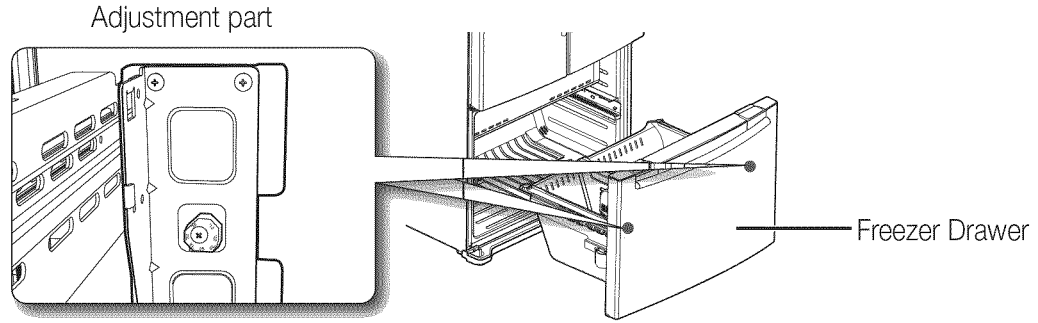

1. Locate the height-adjuster (1) in the freezer drawer.  
Unscrew the four Phillips screws (2) slightly to loosen the door.

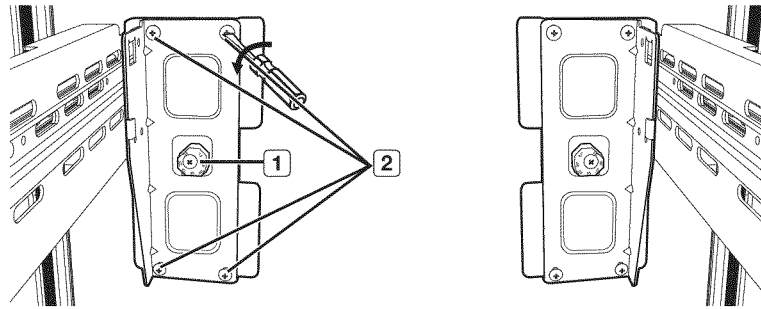

2. Loosen the controller screw (3) with a Phillips screwdriver.

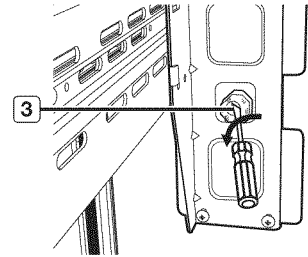

3. Find the best level to align the door slope.

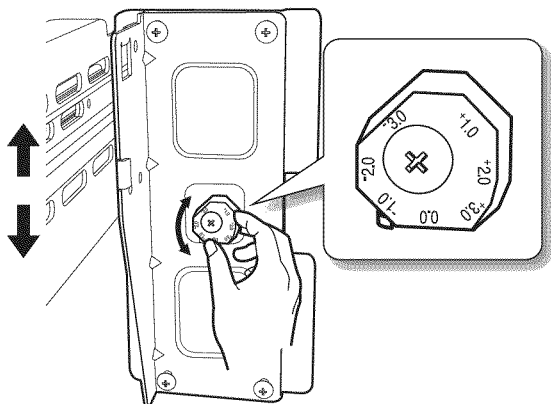

Example) The slope is about 2mm (0.08inch) as shown below.

Slope

Reference plane

- Rotate the Height Adjuster to -2.0 to reduce the door slope.

→ After adjustment, first tighten screw (3) and then screw (2) .

# Setting up your French Door Refrigerator

## CHECKING THE WATER DISPENSER LINE

A water dispenser is one of the helpful features on your new Samsung Refrigerator. To help promote better health, the Samsung water filter removes unwanted particles from your water. However, it does not sterilize or destroy microorganisms. You may need to purchase a water purifying system to do that.

In order for the ice maker to operate properly, a water pressure of 20~125 psi (pound per square inch) is required.

Under normal conditions, a 170 cc (5.75 oz.) cup can be filled in 10 seconds.

If the Refrigerator is installed in an area with low water pressure (below 20psi), you can install a booster pump to compensate for the low pressure.

Make sure the water storage tank inside the Refrigerator is properly filled. To do this, press the water dispenser lever until the water runs from the water outlet.

 Water line installation kits are available at extra cost from your dealer. We recommend using a water supply kit that contains copper tubing.

### Connecting to the water supply line

1. First, shut off the main water supply line and turn the ice-maker off.
2. Locate the nearest cold water drinking line.
3. After connecting the water supply with water filter, turn on water supply and Flush 3 gallons through filter before use (flush approximately 6 minutes)

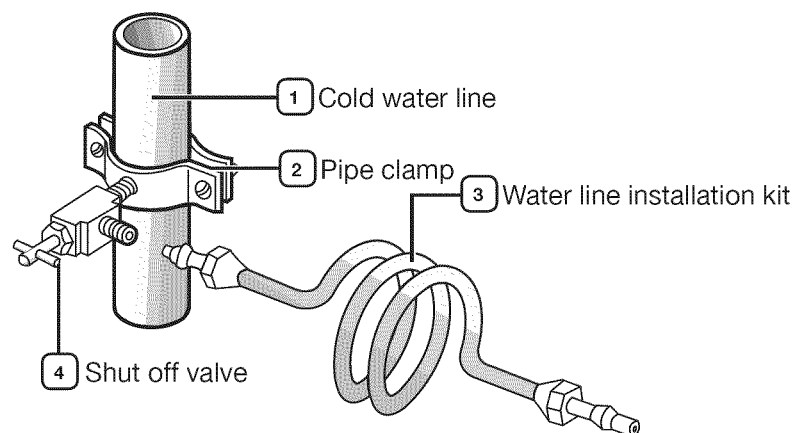

## INSTALLING THE WATER LINE

### Connecting the water line to the Refrigerator.

There are several items that you need to purchase to complete this connection. You may find these items sold as a kit at your local hardware store.

- 1/4" compression nut
- copper tubing
- plastic tubing
- ferrule

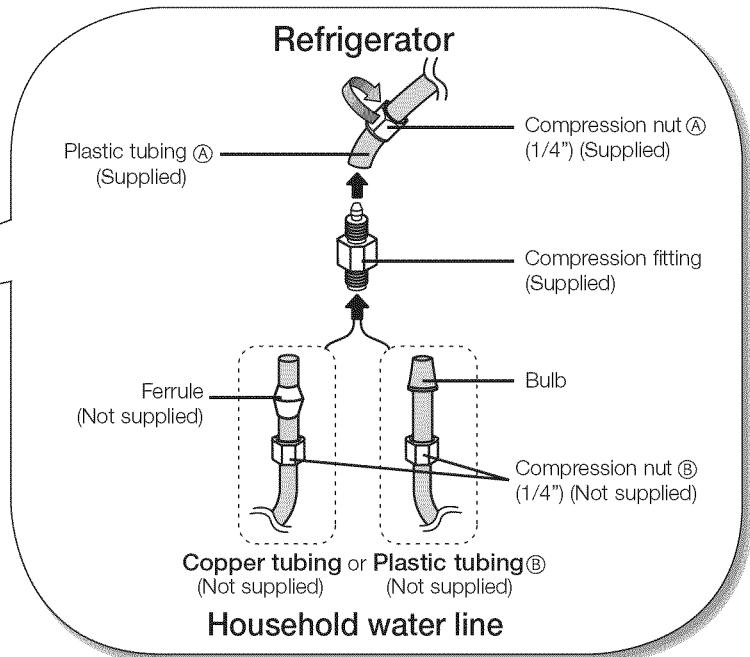
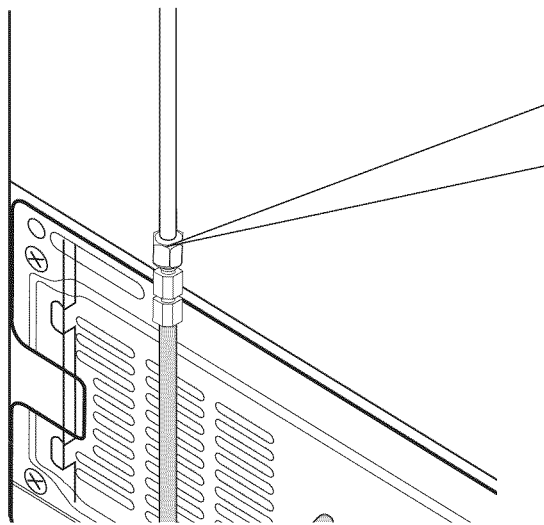

1. Slip the compression nut **A** through the supplied plastic tubing **A**.
2. Tighten the compression nut **A** onto the 1/4" compression fitting.
  - If you are using copper tubing, slip the compression nut **B** (not included) and ferrule (not included) on copper tubing (not included) as shown.
  - If you are using plastic tubing **B**, insert the molded end(Bulb) of the plastic tubing **B** into the compression fitting.



Do not use without the molded end(Bulb) of the plastic tubing **B**.

3. Tighten the compression nut **B** onto the compression fitting. Do not over-tighten the compression nut **B**.
4. Turn water on and check for any leakage.



Only connect the water line to a drinkable water source.

If you have to repair or disassemble the water line, cut off 1/4" of the plastic tubing to make sure you get a snug, leak-free connection.

### Installing the water filter.

1. Remove the water filter cover(**1**)
2. Remove the fixed cap by turning it counter clockwise. Keep the cap in a safe place for later use if you don't use the filter.
3. Remove the water filter from the box and put a replacement indicator sticker on the filter as shown. Place the sticker on the filter that dates six months in the future. For example, if you install the water filter in March, put the "SEP" sticker on the filter to remind you to replace it in September. That way you'll know when it is time to replace the filter. Normally, a filter life is about 6 months.

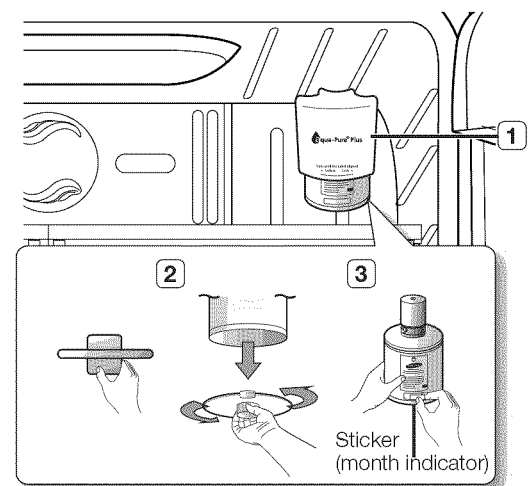

# Setting up your French Door Refrigerator

4. Remove the filter cap and insert the filter into the filter housing.
5. Slowly turn the water filter 90° clockwise to align with the printing mark on the cover, locking the filter in position. Make sure to align the water filter label mark with center of cover filter printing as illustrated. Remember, do not over-tighten.

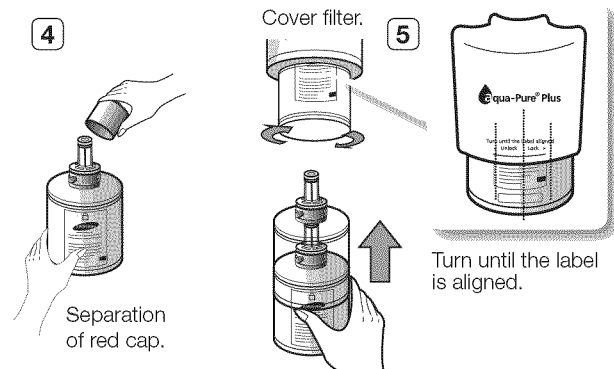

 You should remove the right side upper glass shelf before installing the water filter.

## Removing any residual matter inside the water supply line after installing the water filter.

1. Turn ON the main water supply & turn OFF the valve to the water supply line.
2. Run water through the dispenser until the water runs clear (approx. 6-7 minutes). This will clean the water supply system and remove air from the lines.
3. Additional flushing may be required in some households.
4. Open the Refrigerator door and make sure there are no water leaks coming from the water filter.

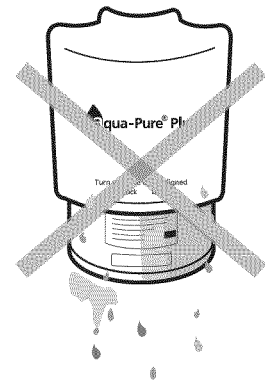

 Be sure to flush the dispenser thoroughly or water may drip from it. This is due to the fact that there is still air in the line.

## Reverse Osmosis Water Supply

**IMPORTANT :** The pressure of the water supply coming out of a reverse osmosis system going to the water inlet valve of the refrigerator needs to be between 35 and 120 psi (241 and 827 kPa).

If a reverse osmosis water filtration system is connected to your cold water supply, the water pressure to the reverse osmosis system needs to be a minimum of 40 to 60 psi (276 to 414 kPa.)

If the water pressure to the reverse osmosis system is less than 40 to 60 psi (276 to 414 kPa):

- Check to see whether the sediment filter in the reverse osmosis system is blocked. Replace the filter if necessary.
- Allow the storage tank on the reverse osmosis system to refill after heavy usage.
- If your refrigerator has a water filter, it may further reduce the water pressure when used in conjunction with a reverse osmosis system. Remove the water filter.

If you have questions about your water pressure, call a licensed, qualified plumber.

# Operating your SAMSUNG French Door Refrigerator

## DIGITAL PANEL

This refrigerator comes with an LCD touch screen which enables you to easily make many settings as well as view Photo images uploaded from a memory card.

Function	Description
Processor	Samsung S3C2440A 400MHz
RAM	SDRAM(64MB)
ROM	NAND Flash(128MB)
OS	Windows CE 5.0
Display	800x480 7" TFT-LCD
Interface	Secure Digital(SD) Card Slot

Graphic User Interface (GUI) is an easy access interface for users. Touch Screen allows access to all display functions.

## VIEW OF PANEL

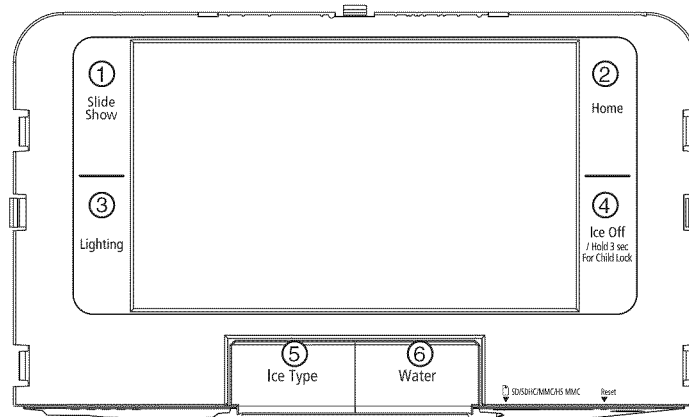

- (1)** Slide Show

Use this function to see images saved in a Photo Album.

- (2)** Home

Shows the initial screen view containing the refrigerator's main functions.

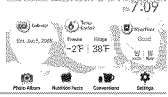
- (3)** Lighting

Turns the Dispenser Lamp on and off.
- (4)** Ice Off/Hold 3 sec For Child Lock

When pressed for less than 3 seconds, Ice Off will be on. When pressed for more than 3 seconds, Child Lock will be activated.
- (5)** Ice Type

Press it to select Dispenser Ice Type.  
When the button is pressed, the Ice Type is changed to cubed or crushed.

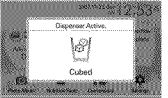
- (6)** Water

Press it to use the Water Dispenser.

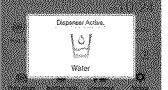

- Buttons 1-4 above are touch-sensitive.
- Use care, as buttons can be triggered by just brushing or touching on the panel.

# Operating your SAMSUNG French Door Refrigerator

## Plug in.

When the refrigerator is plugged in or the reset button is pressed, the “Current Date/Time” screen will be on.

### How to set the time.

1. Choose the desired date and time by pressing the <◀, ▶, ▲, ▼> buttons.
2. To apply your new settings, press [OK] button.

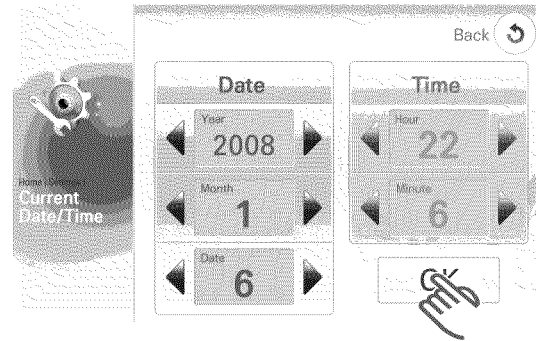
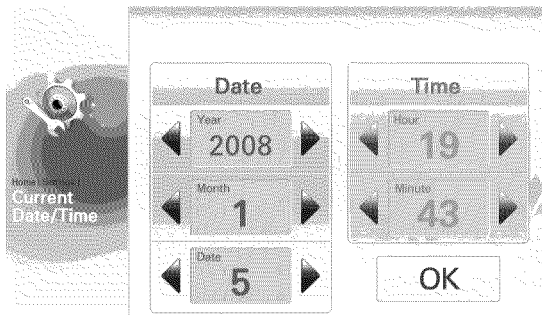

3. When the [OK] button is pressed, the “Home” screen will be displayed, showing the set time.

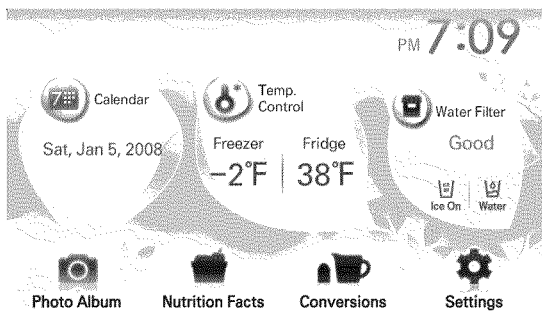

### How to calibrate the touch point.

This function can be used to calibrate the finger touch point to improve usability with the Touch screen.

1. Choose the [Settings] button.
2. Choose the [Touch Screen Correction] button, and then a screen will appear with pointer instructions on the top.

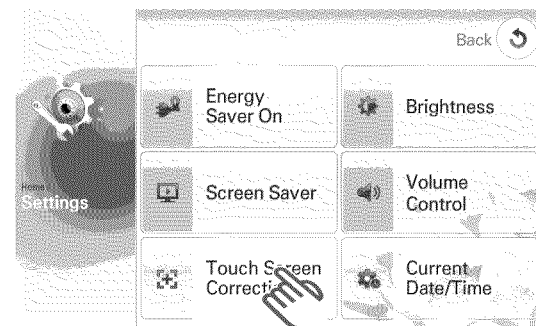
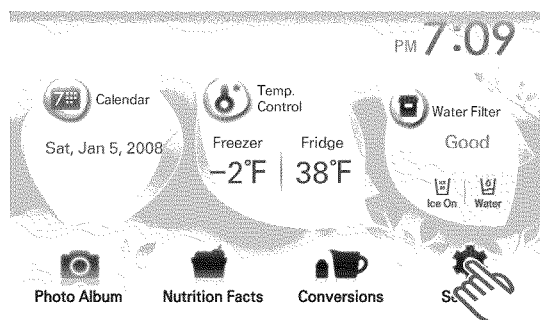

3. Press down lightly on the center of the “+” mark.  
Repeat as the “+” mark moves on the screen.

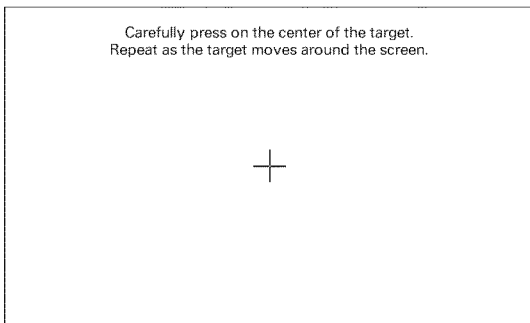

4. To save the new calibration data, touch the LCD screen within 30 seconds.

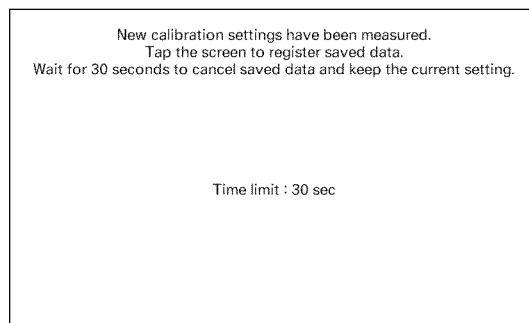

▶ To keep the current setting, wait for 30 seconds.

## Slide show.

You can select photos from the ‘Photo Album’ and set them to play in a slide show.

### How to use the slide show.

1. Choose the [Slide Show] button.

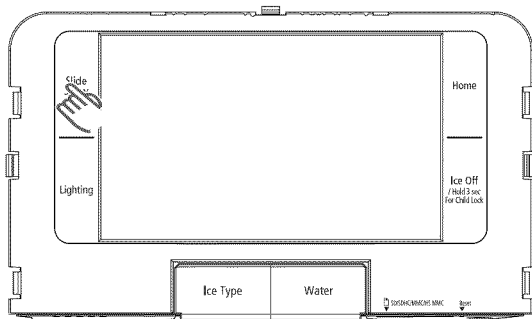

- ▶ The photos for the Slide show can be selected from the ‘Photo Album’.(refer to page 35)
- ▶ When photos are not selected from the‘Photo Album’, the screen shows 13 photos pre-loaded by Samsung.

2. To stop the Slide show, press the [Exit] button, and then the “Home” screen will be displayed.



- ▶ Based on the photo size, there may be black bars on the top or sides of the photo.
- ▶ It is optimized for 16:9 wide screen.

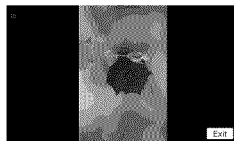

Images may be stretched or reversed. If an image is reversed,download it to your PC. Then, rotate it by 90 degrees and save it before uploading it.

# Operating your SAMSUNG French Door Refrigerator

## Home.

When the “Home” button is pressed, the panel shows the “Home” view.

“Home” shows the Calendar, freezer/fridge temp, water filter status and other general functions.

### How to use the Home mode.

1. Choose the [Home] button.

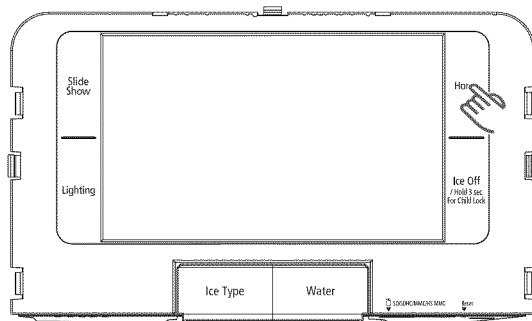

2. Choose the desired function.

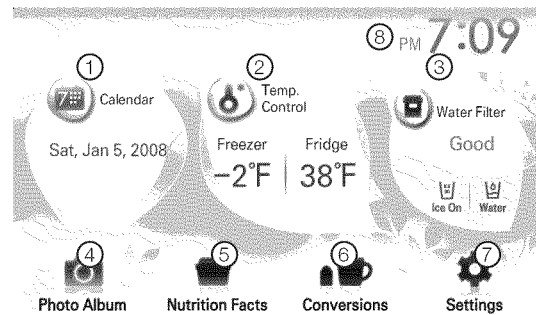

- ① **Calendar** : It shows the date and indicates holidays.
- ② **Temp. Control** : You can set the freezer and fridge temperature.
- ③ **Water Filter** : It shows the current status of the Water Filter and Dispenser.
- ④ **Photo Album** : Photos are saved here. You can also make your own slide show.
- ⑤ **Nutrition Facts** : It shows the nutritional composition of different foods.
- ⑥ **Conversions** : You can convert a unit to another unit (ie. quart to liter).
- ⑦ **Settings** : You can set the energy saver, brightness, screen saver, volume control, touch screen correction and current time.
- ⑧ **Task Bar** : Indicates the current time.

## Dispenser.

This button is used to turn the Dispenser lamp on and off, to stop Ice dispensing and to select Ice type or water dispensing.

### How to use the dispenser lamp.

1. Press the [Lighting] button to have the Dispenser lamp stay on.

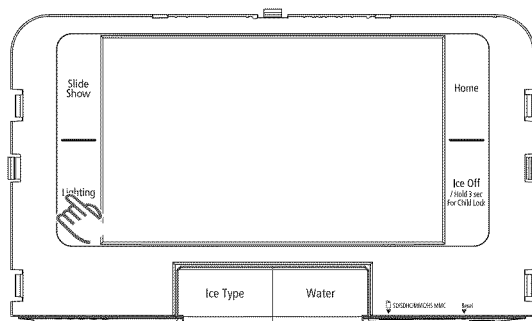

- Light ON : The Dispenser lamp stays on.
- Light OFF(Default) : The Dispenser lamp lights up when the Dispenser is being used and turns off 5 seconds after you are finished.

2. Press the [Lighting] button to turn off the Dispenser lamp.



### How to set the ice off.

1. Press the [Ice Off/Hold 3 sec for Child Lock] button for less than 3 seconds.

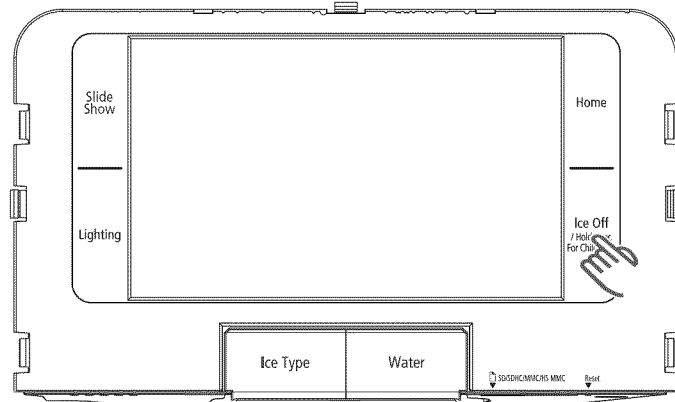

- ▶ When pressing the [Ice Off/Hold 3 sec for Child Lock] button for more than 3 seconds, the Lock function will be activated.
2. "Ice Off" message pops up on the display and ice production stops.
    - ▶ To re-start ice production, press the [Ice Off/Hold 3 sec for Child Lock] button again.

### Dispenser selection. How to set the ice type or water.

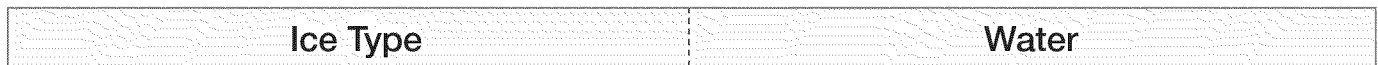

1. Press the [Ice Type] button.
  - ▶ When the button is pressed, the ice type is changed to cubed or crushed.

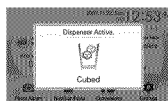
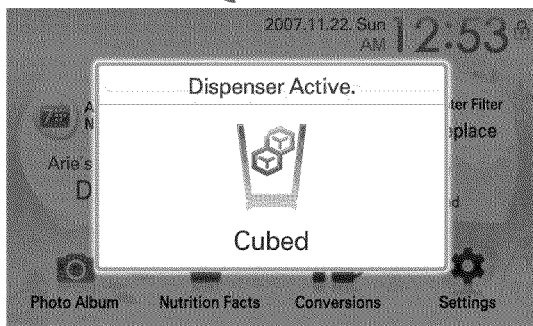
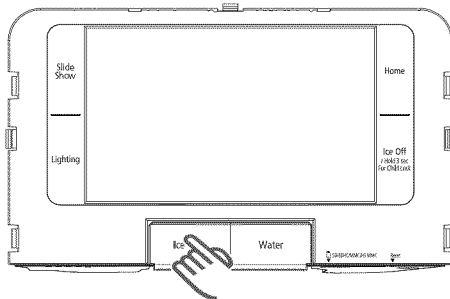

• With the Dispenser function, you can see the current Dispenser setting.

1. Press the [Water] button. Water can be dispensed.

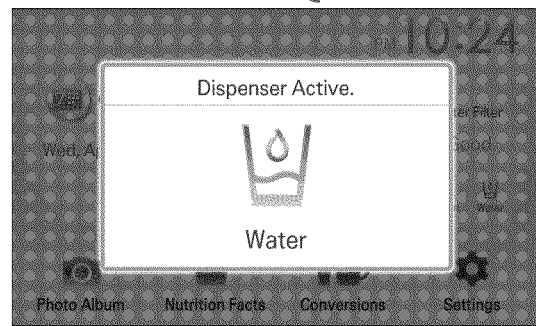
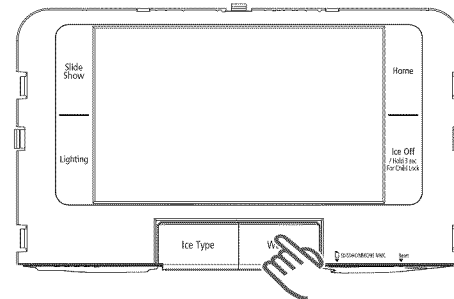

Before installing the water line, remove the ice bin/bucket and using a soft cloth, wash it with mild detergent. Rinse well and dry completely.

**DO NOT PUT YOUR HANDS IN THE ICE CHUTE WHILE CLEANING.**



Please wait 2 seconds before removing the glass under the dispenser to prevent spills. If the Refrigerator door opens, the Dispenser does not work.

# Operating your SAMSUNG French Door Refrigerator

## Child Lock.

When the Child Lock function is activated by pressing the [Ice Off/Hold 3 sec for Child Lock] button for more than 3 seconds, all the buttons and the touch screen will not work.

To unlock the Child Lock function, press the [Ice Off/Hold 3 sec for Child Lock] button again for more than 3 seconds.

### How to set the Child Lock/unlock.

1. Press the [Ice Off/Hold 3 sec for Child Lock] button for more than 3 seconds.

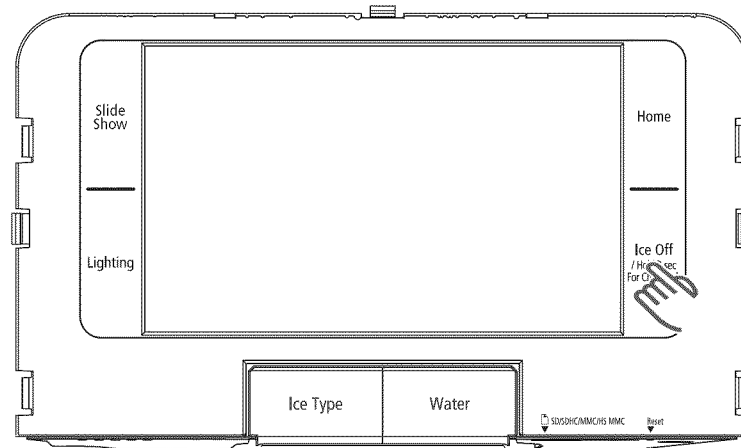

2. "Child Lock Setup Complete" message pops up on the screen and the Lock icon(  ) shows up on the right upper corner.

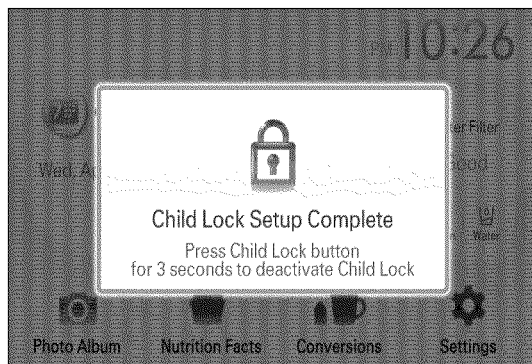

- ▶ When the Child Lock is set, all the buttons, dispenser and the touch screen do not work.

3. To turn off the Child Lock function, press the [Ice Off/Hold 3 sec for Child Lock] button again for more than 3 seconds. "Child Lock Deactivated" message pops up on the screen and the Lock icon (  ) disappears.

## Cooling off.

Cooling Off stops cooling in both the freezer and refrigerator compartments but does not shut off electrical power to the refrigerator.

### How to use the cooling off.

1. Press and hold the [Slide Show] button and [Lighting] button simultaneously for 3 seconds.

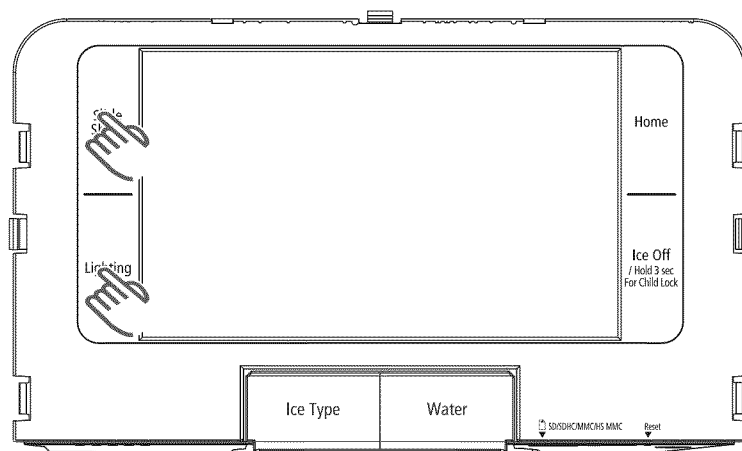

2. "Cooling OFF Setup Complete" message pops up on the screen.

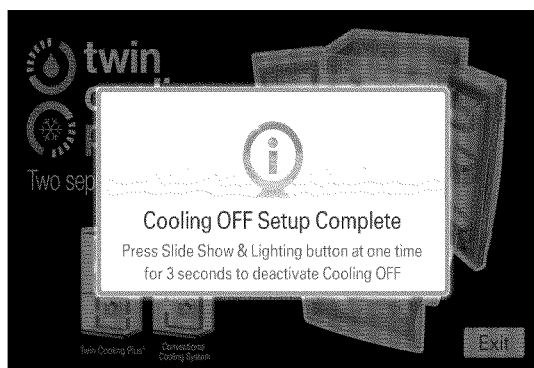

3. To turn off the Cooling Off function, press the [Slide Show] button and [Lighting] button again simultaneously for 3 seconds. "Cooling OFF Deactivated" message pops up on the screen.

# Operating your SAMSUNG French Door Refrigerator

## Door Open Alarm.

When the door is open for more than 3 minutes, it triggers the Door Open alarm sound.

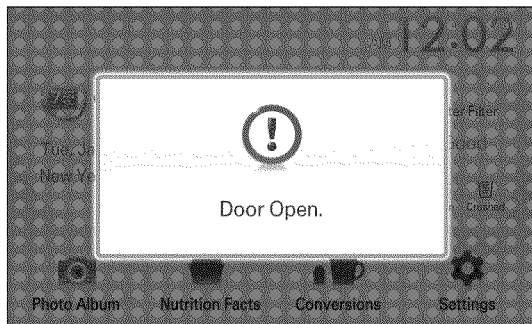

► The alarm stops right after the door is closed.

## Calendar.

The Calendar shows the date and indicates holidays.

1. Choose the [Calendar] button.

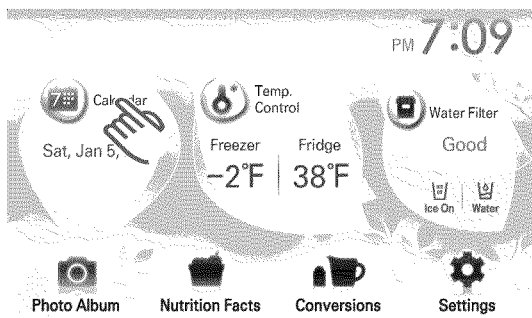

2. Choose the desired holiday using the “◀, ▶” buttons.

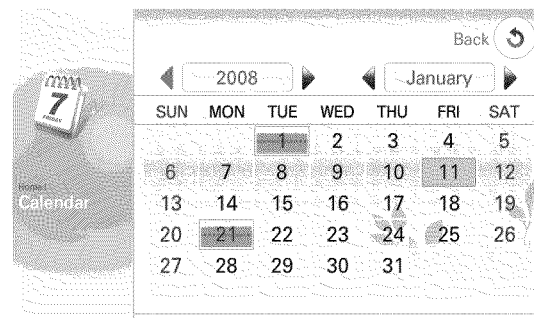

► Today is highlighted in blue(11) and Holidays are highlighted in pink(1).

3. Confirm the holiday and tap on the [OK] button.

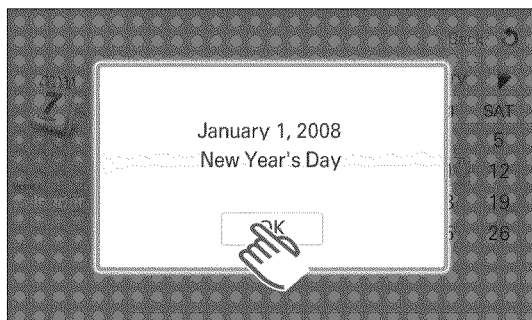

# Temp. Control.

To change the Freezer/Fridge temperatures, refer to the following (make sure that it is not locked.)

## How to change the freezer and fridge temperature.

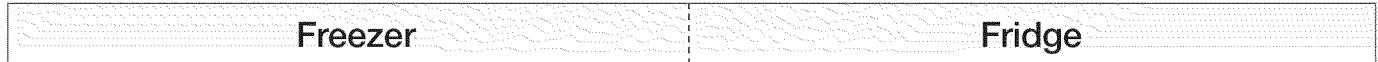

1. Choose the [Temp. Control] button.

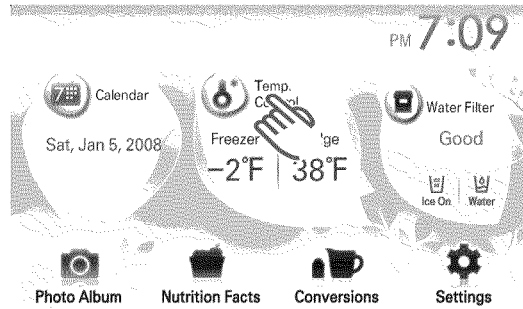

2. Choose the desired freezer temperature using the “◀, ▶” buttons.

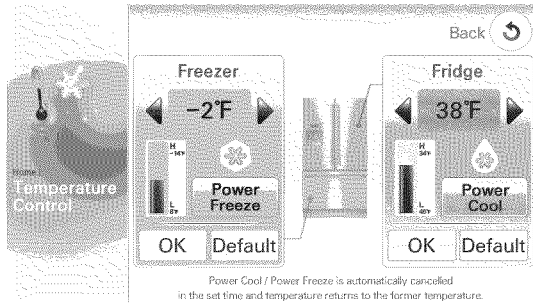

- ▶ The freezer temperature can be set between 8°F(-14°C) and -8°F(-22°C).

3. Choose the [OK] button to save.

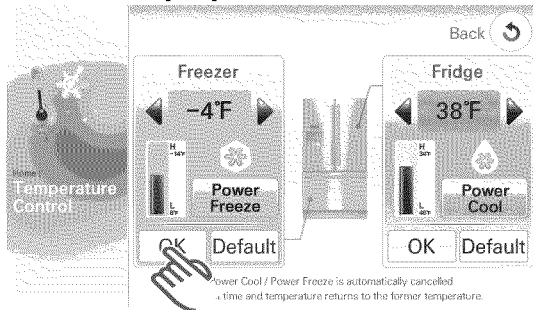

2. Choose the desired fridge temperature using the “◀, ▶” buttons.

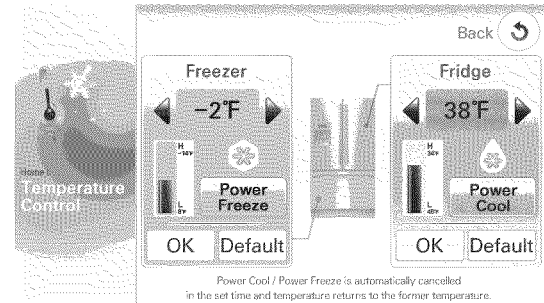

- ▶ The fridge temperature can be set between 46°F(7°C) and 34°F(1°C).

3. Choose the [OK] button to save.

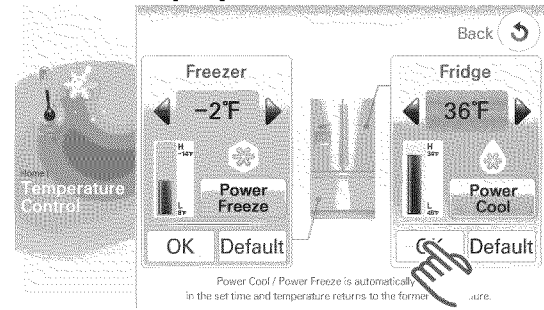

When ice cream is stored at a temperature above 4°F(-16°C) in freezer, it may melt.



If you choose the [Default] button, the default freezer (-2°F) and fridge (38°F) temperatures will be set.



The Freezer/Fridge temperatures may change depending on the door opening/closing frequency, the food quantity, the ambient temperature, etc. Temperatures vary at each food storage section in the Freezer/Fridge room. When power comes back after a short outage and the freezer temperature is lower than 42°F(5°C), it reads its previous temperature and function settings to operate.

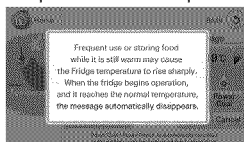

- When the Freezer/Fridge doors are used frequently or there is a temperature increase with hot items being stored, the pop-up window on the left appears on the screen.

This pop-up window disappears as the temperature goes down.

# Operating your SAMSUNG French Door Refrigerator

## How to set Power Freeze and Power Cool.

The Power Freeze and Power Cool features can be used to quickly lower the temperature of the freezer or fridge. If you select the Power Freeze or Power Cool, the inside temperature of the Freezer or Fridge will decrease for about two and a half hours.

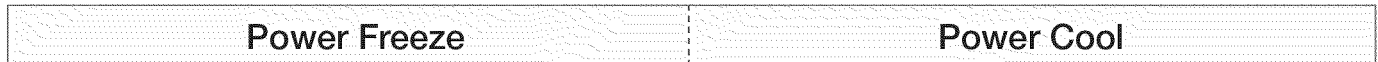

1. Choose the [Temp. Control] button.

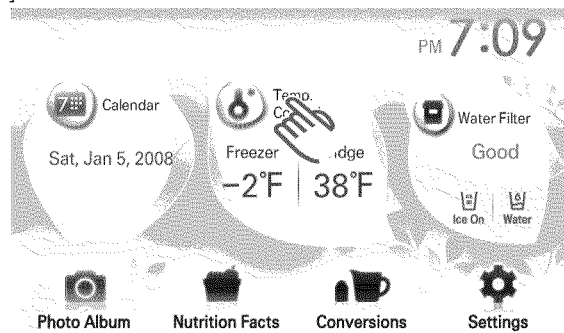

2. Choose the [Power Freeze] button.

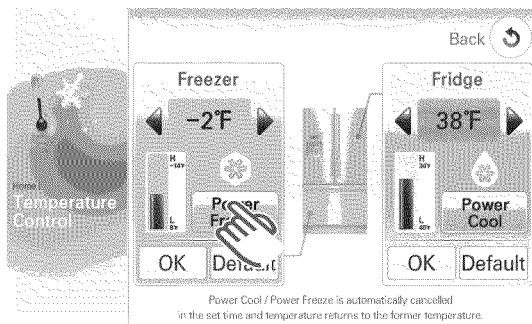

2. Choose the [Power Cool] button.

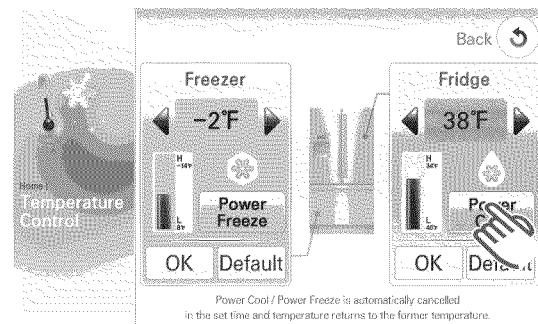

3. Choose the [OK] button to save.

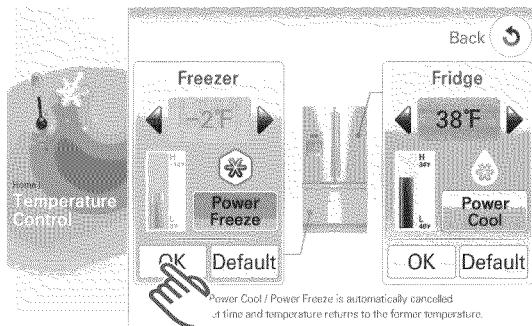

3. Choose the [OK] button to save.

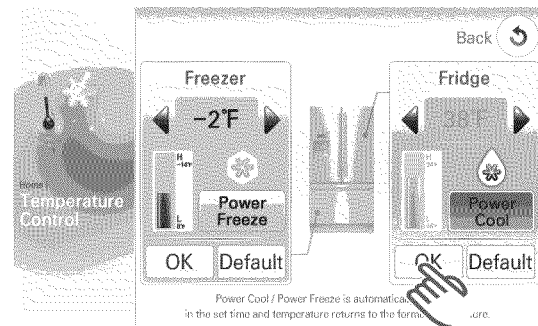

► This feature enables you to get ice faster.

- ▶ When “Power Freeze” or “Power Cool” is selected, the temperature setting buttons are deactivated.

 If you use this function, energy consumption will increase.

## Water Filter.

**WARNING** To reduce risk of water damage to your property DO NOT use generic brands of water filters in your SAMSUNG Refrigerator. USE ONLY SAMSUNG BRAND WATER FILTERS. SAMSUNG will not be legally responsible for any damage, including, but not limited to property damage caused by water leakage from use of a generic water filter. SAMSUNG Refrigerators are designed to work ONLY WITH SAMSUNG WATER Filter.

It shows the current status of the Water Filter and how to replace it.

### How to replace the water filter.

1. Choose the [Water Filter] button.

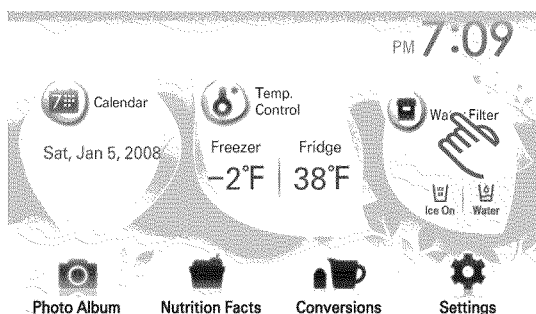

2. Choose the [Replace] button.

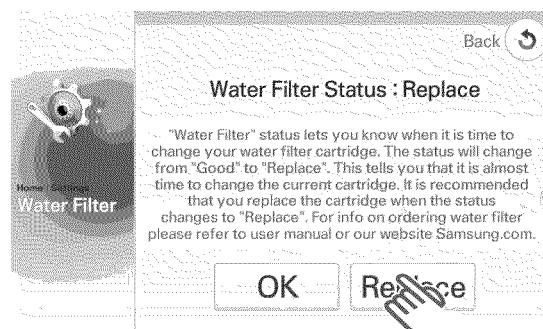

- ▶ Choose this when the Water Filter Status is “Order” or “Replace”.

### ※ Water Filter Status

Good	Order	Replace
<p>▶ Does not need replacement.</p>	<p>▶ It needs replacement soon.</p>	<p>▶ It needs replacement right away.</p>

3. Choose the [Next] button.

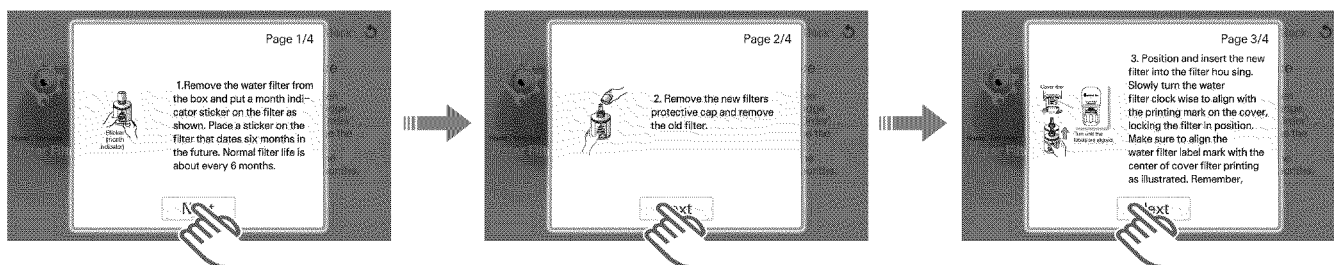

- ▶ Refer to the Water Filter replacement guide and replace the Water Filter at the right upper corner of the Fridge compartment.(refer to pages 19, 20)

# Operating your SAMSUNG French Door Refrigerator

4. When the replacement is done, select the [OK] button.

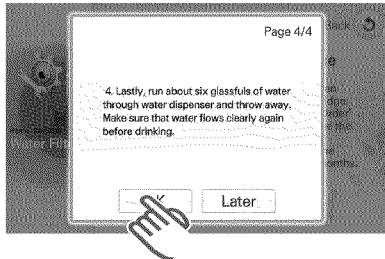

Be sure to flush the dispenser thoroughly, otherwise water may drip from it. If water drips, it means that there is still air in the line. Do NOT use the water or ice dispenser without a water filter cartridge because the water line may become blocked.

5. Filter Replacement is done.



## Ordering a Replacement Water Filter

For a replacement water filter, you can visit your local home improvement center or contact the Samsung Parts distributor. Be sure the replacement water filter has the SAMSUNG logo on the box and on the water filter.

Link: <http://www.samsungparts.com>

## Photo Album.

Photos can be uploaded from a Memory card into the Photo Album of this refrigerator. When the card is inserted, the Photo Album preview is automatically run.

### How to upload the images.

1. Pull the Slot cover out and move it to the side.
2. Insert the Memory Card(SD/SDHC/MMC/HS MMC) with images saved into the Card slot.

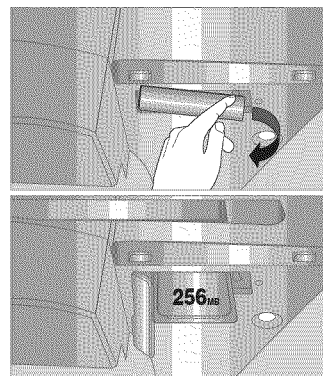
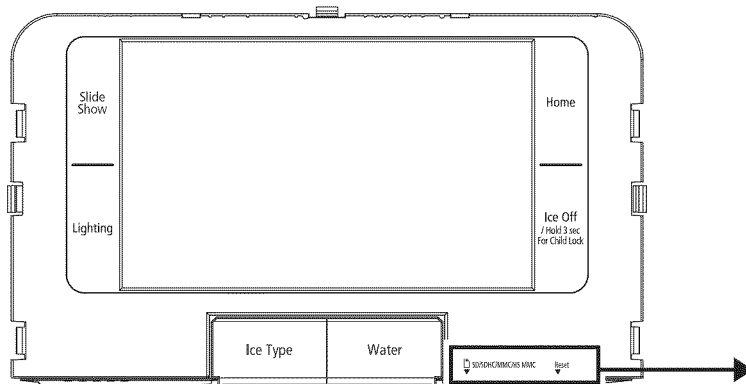

[Slot Location]

- ▶ The Photo Album will run after the "Memory Card Connected", "Reading Data" message appears on the screen.
- ▶ If there are no images saved on the Memory Card, the Photo Album does not run.



- ☒ • The Memory slot is only for SD/SDHC/MMC/HS MMC type memory cards.
- It reads only JPEG images.
- Up to a 10 mega pixel JPEG images(3872\*2592, 24bit) can be saved.  
(When images are larger than 10 mega pixel or their definitions are changed, they cannot be displayed on the screen.)
- If there are many photos saved on the Memory card, it will take awhile for the preview function to load.
- If the Memory Card is removed while transferring images, the Photo Album only shows the images that have completed transfer in its left upper corner. If not a single image has completely transferred, it returns to the screen before the Memory Card was inserted.
- The saved images are fit to the screen size.  
Depending on the size of an image, there may be black bars on the top or sides.
- A Memory Card is not supplied with the refrigerator.
- Depending on the type of SD/SDHC/MMC/HS MMC memory cards, there may be some that are be unreadable.  
(SanDisk 1GB and Transcend MMC PLUS are recommended.)
- The fridge has a capacity of 128MB.
- When saving photos from a memory card to the Panel, the photo size is automatically changed to 800\*480, regardless of the original size.
- The Panel has a capacity of 60 photos.

3. Select photos to save in the Photo Album among the photos saved in the Memory Card (SD/SDHC/MMC/HS MMC).

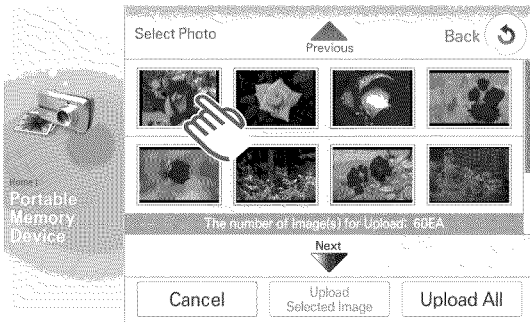

- ▶ Multiple images can be selected.
- ▶ It shows the possible number of images at the bottom of the image list.
- ▶ The “Portable Memory Device” screen provides a preview function of up to 100 saved images in the Memory Card.
- ▶ These Photos can be selected and saved in the Photo album.

4. Choose the [Upload Selected Image] button.

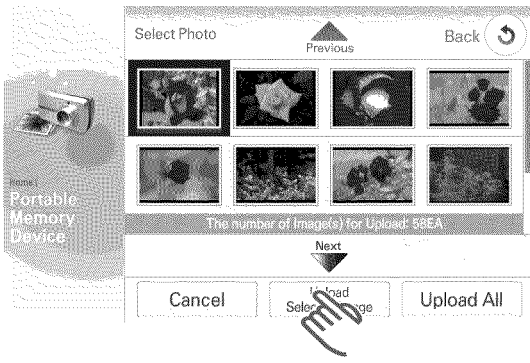

- ▶ To save all the images in the Memory Card to the Photo Album, press the [Upload All] button.
- ▶ When the [Cancel] button is selected, it goes to the screen before the Memory Card connection.
- ▶ Up to 60 photos can be saved.

5. The “Uploading Selected Image” appears on the screen while uploading photos from the Memory Card.

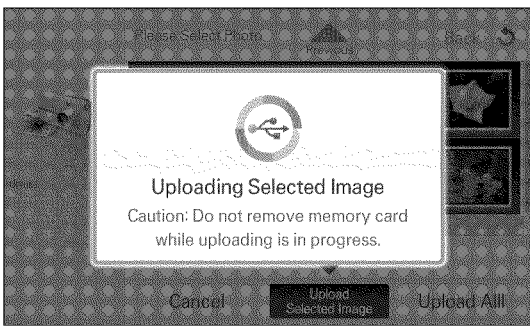

- ▶ Larger photo sizes will take longer to upload.
- ☒ High definition or sideways images may be distorted.

# Operating your SAMSUNG French Door Refrigerator

6. When all the images are transferred, select the [Finish] button and when there are more images to save, select the [Continue] button.

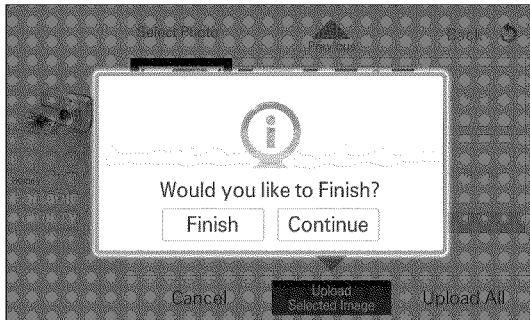

▶ When the [Continue] button is selected, it returns to the Portable Memory Device Select Photo screen.

7. When it says “Please Remove Memory Card.”, take out the Memory Card from the slot.

## How to delete the images.

1. Choose the [Photo Album] button.

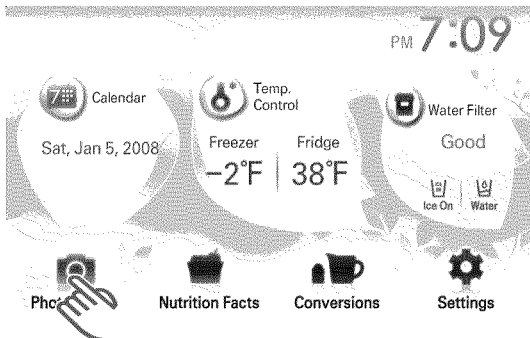

2. Select images to delete and select the [Delete Selected] button.

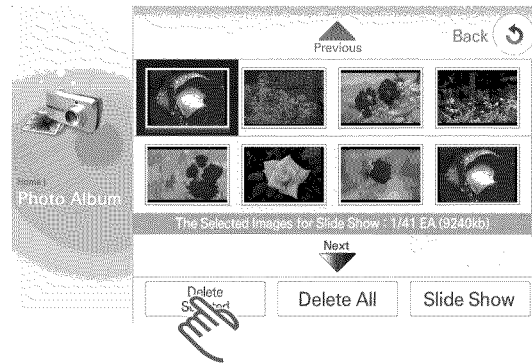

- ▶ Multiple selection is possible.
- ▶ To delete all the photos in the Photo Album, select the [Delete All] button.
- ▶ There are 13 photos that have been pre-loaded by Samsung. These Photos explain product features and cannot be deleted.

3. Choose the [OK] button.

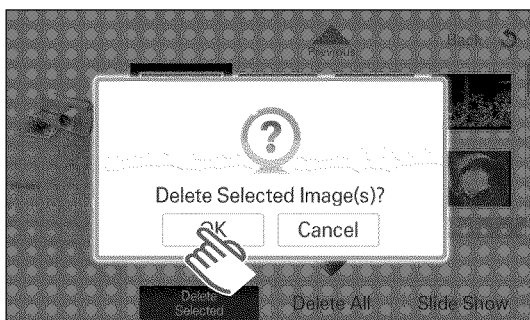

## How to set the slide show.

1. Choose the [Photo Album] button.

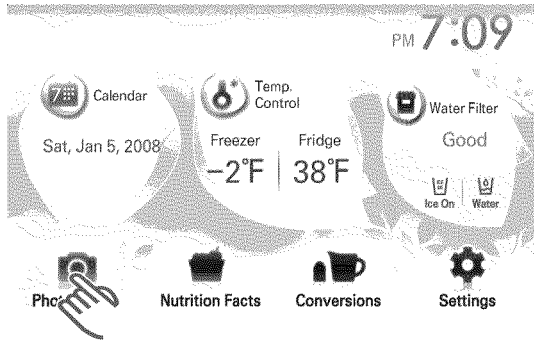

2. Choose the photos for Slide Show and select the [Slide Show] button.

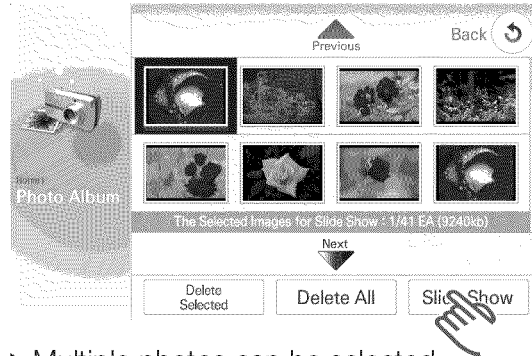

- ▶ Multiple photos can be selected.
- ▶ Depending on the photo size (Width\*Height), there could be blank bars on the top and sides of the image.
- ▶ When only the 13 pre-loaded photos are in the Photo album, these photos are set for Slide Show automatically.
- ▶ The screen is optimized for 16:9 wide (horizontal side) image size.

3. The slide show preview begins with the selected photos.

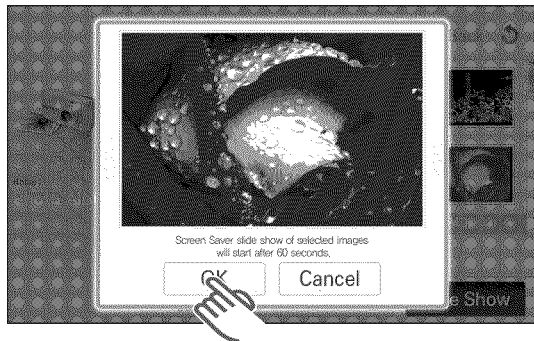

- ▶ If the preview contains all the photos you desire for the slide show, click OK; if not, click Cancel to select more photos.
- ▶ When the [Slide Show] button is selected, you can see the photos selected for the Slide Show.

4. To view the Slide Show, press Slide Show on the upper left.

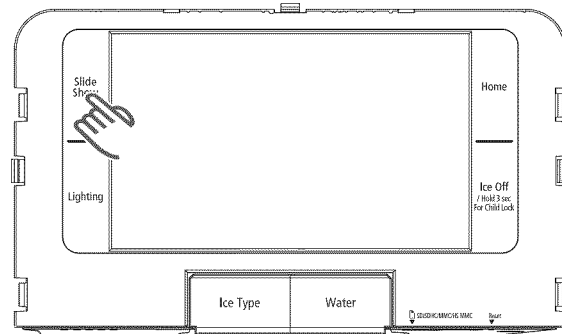

- ☒ If stationary images, images of the same size, or images with black bars on the top or sides are displayed for an extended time, screen burn may occur. To avoid this, display images with varied sizes.
- The warranty does not cover screen burn issues.



[Image with Left & Right Black Bars]

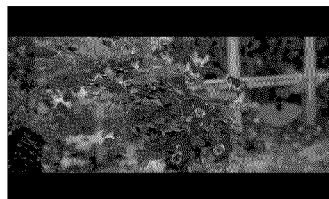

[Image with Top and Bottom Black Bars]

# Operating your SAMSUNG French Door Refrigerator

## Nutrition Facts.

Nutrition facts about various foods is displayed.

### How to use the nutrition facts.

1. Choose the [Nutrition Facts] button.

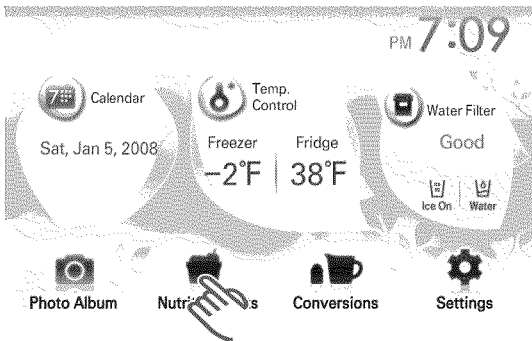

2. Choose the desired food.

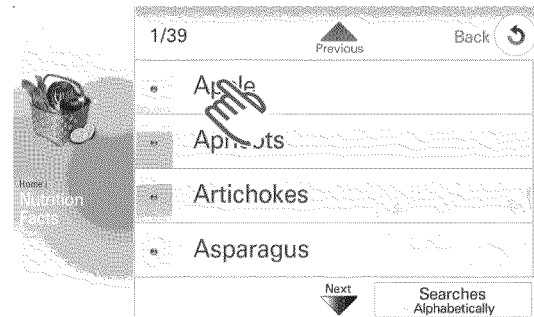

► It shows 4 ingredients in alphabetical order. To find others, scroll up and down by pressing the “▲”, “▼” buttons.

3. To find a food by its first letter, select the [Search Alphabetically] button.

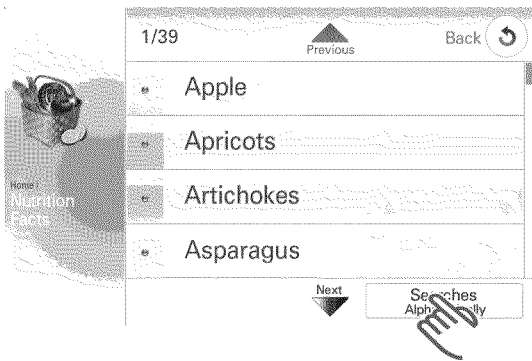

4. Select the first letter of the food.

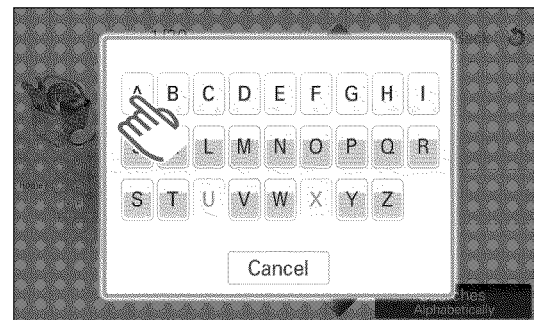

► Letters with no nutritional facts will be shown in lighter color.

5. Choose the desired food.

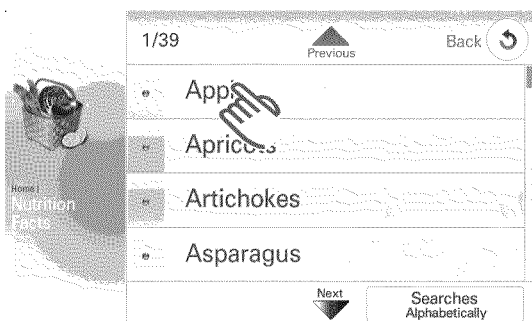

6. Nutritional facts about the food are shown.

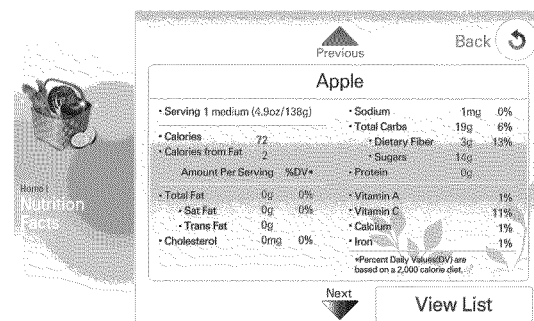

► The screen can be scrolled up and down with the “▲”, “▼” buttons.

## Conversions.

You can convert the current units to those you want to use.

### How to use the conversions.

1. Choose the [Conversions] button.

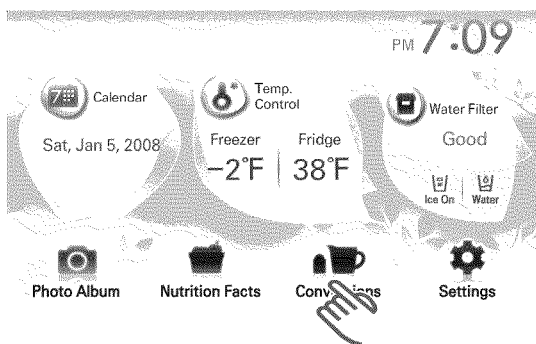

2. Choose the desired 'Unit' using the “◀, ▶” buttons.

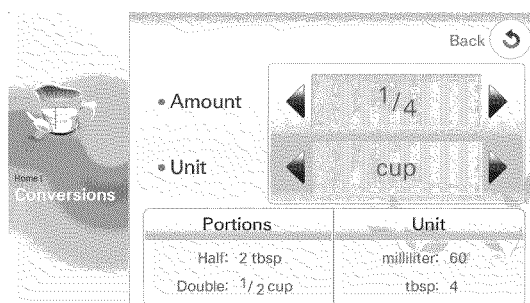

- ▶ Unit : Cup, Pint, Quart, Gallon, Fluid Ounce, Teaspoon, Tablespoon, Milliliter, Liter, Ounce, Pound, Gram, Kilogram.

3. Choose the desired 'Amount' using the “◀, ▶” buttons.

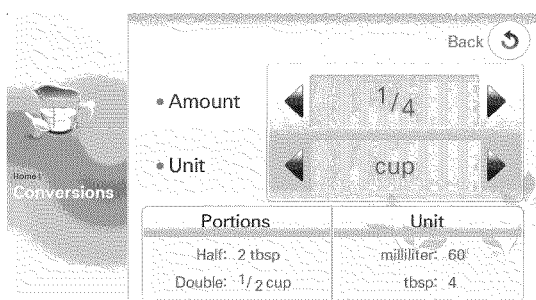

- ▶ When Amount and Unit are set with the “◀, ▶” buttons, the converted values show on the screen.

Portions	Unit
Half: 2 tbsp	milliliter: 60
Double: 1/2 cup	tbsp: 4

## Settings.

You can customize the following in the Settings mode.

Energy Saver, Brightness, Screen Saver, Volume Control, Touch Screen Correction, Date/Time.

### How to set the Energy Saver off.

If condensation occurs on the doors, turn the Energy Saver function off.

1. Choose the [Settings] button.

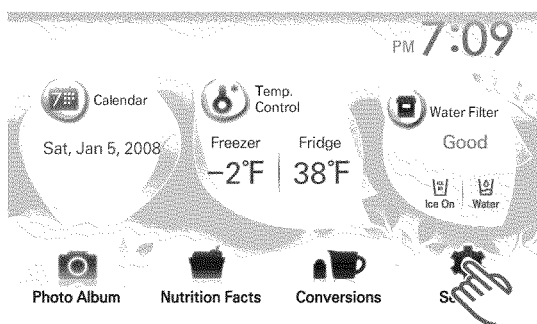

2. Choose the [Energy Saver On] button.

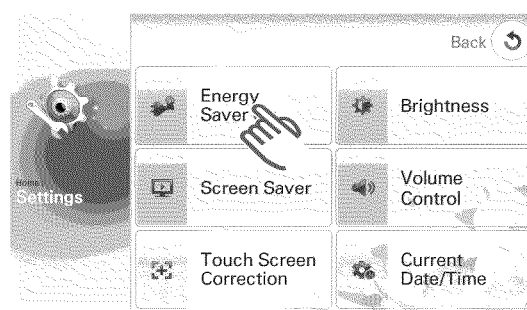

- ▶ The default Energy Saver setting is On.

# Operating your SAMSUNG French Door Refrigerator

3. After “Energy Saver Deactivated” window is displayed, the Energy Saver function is turned Off and the screen shows [Energy Saver Off].

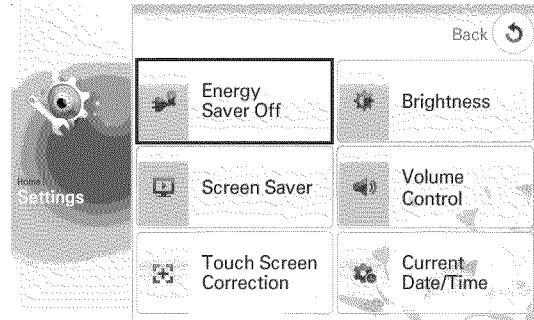
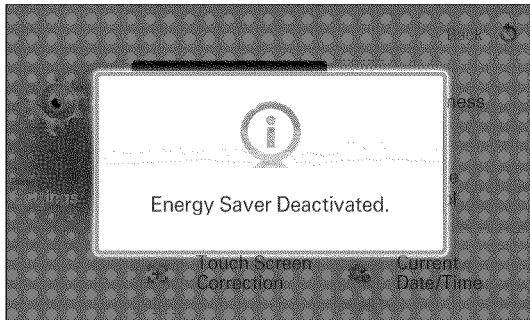

 Energy Saver Button shows the current set condition.

## How to set the screen brightness.

1. Choose the [Brightness] button.
2. Control the screen brightness using the [Dark], [Bright] buttons.

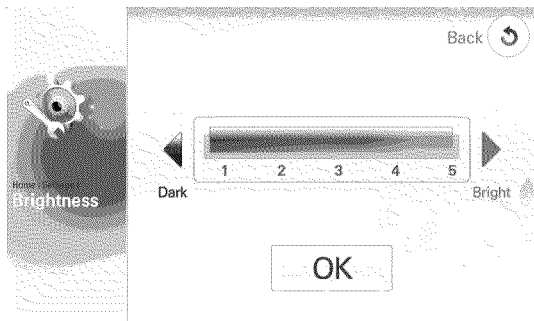
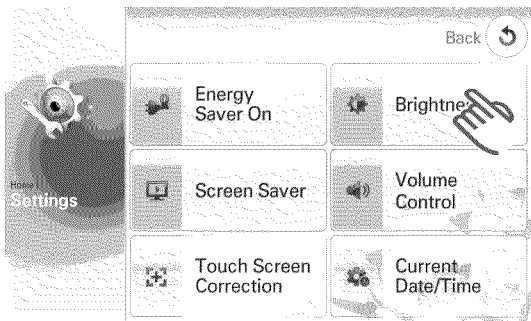

3. To apply your new settings, press [OK] button.

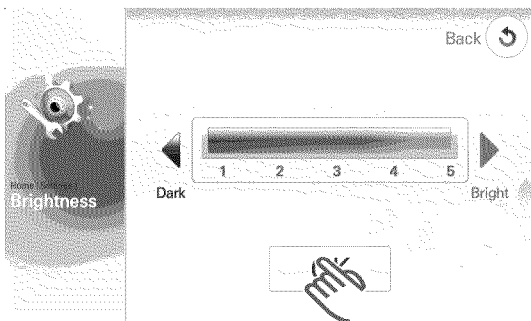

- ▶ Each time the button is pressed, the screen brightness changes.

## How to set the screen saver.

When not using the panel for awhile, the Photo Album's Slide Show feature can be set as a Screen Saver.

1. Choose the [Screen Saver] button.

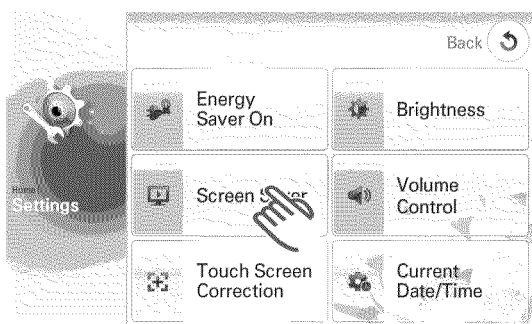

2. After setting the "Screen Saver Running Time" with the "◀, ▶" buttons, select the [OK] button. "Screen Saver Running Time" has 6 time settings (0/3/5/10/30/60 minutes).

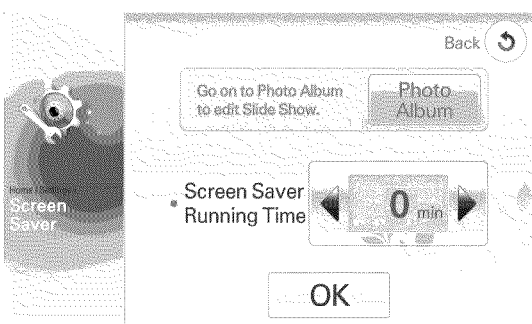

- ▶ After 60 seconds, the Screen Saver runs for the time you set, then the LCD panel turns off.
- ▶ If the Screen saver running time is set to 0 minutes, the Slide show will not run.
- ▶ When moving to other functions without selecting the [OK] button, the new setting does not apply.

3. To change the Screen Saver Slide Show, select the [Photo Album] button.

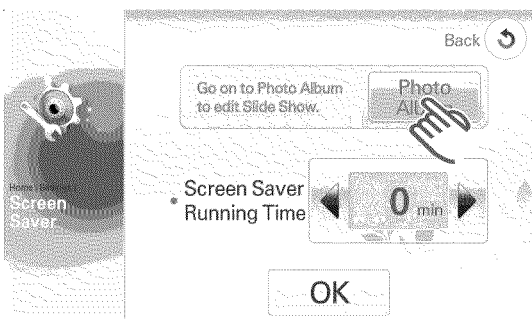

- ▶ Refer to Page 35 to change the Slide Show.

# Operating your SAMSUNG French Door Refrigerator

## How to set the volume control.

You can control the volume of the alert sounds.

1. Choose the [Volume Control] button.

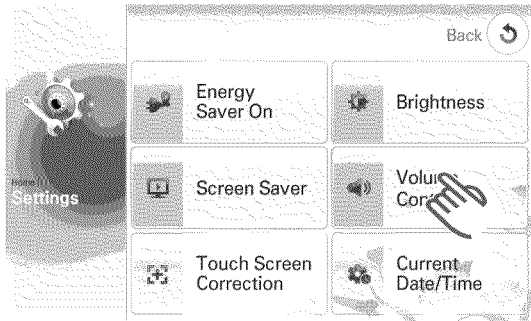

2. Control the alert sound volume using the [Low], [High] buttons.

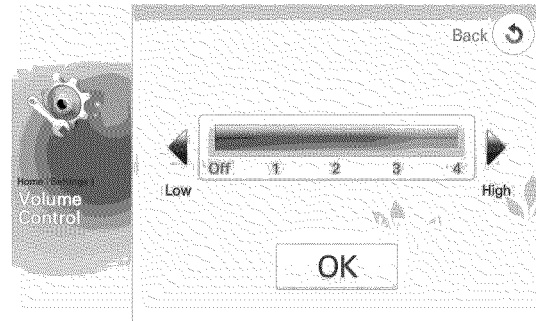

3. To apply your new settings, press [OK] button.

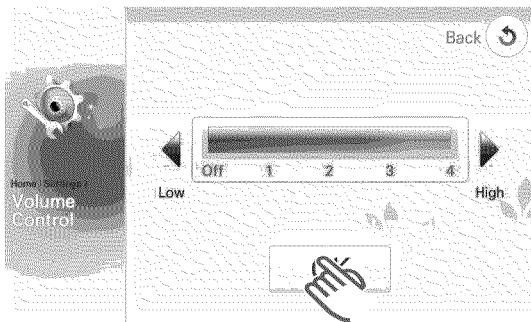

 An alert sound is heard when a button is pressed or a message window or menu list appears.



## How to change the Current Date/Time.

1. Choose the [Current Date/Time] button.

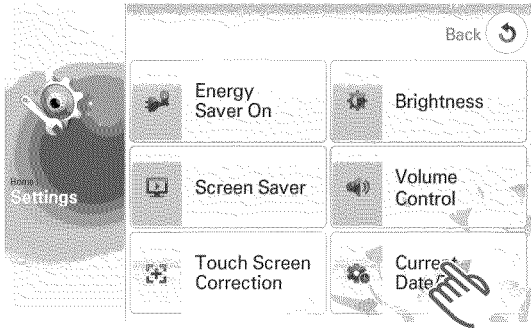

2. Choose the desired date and time.

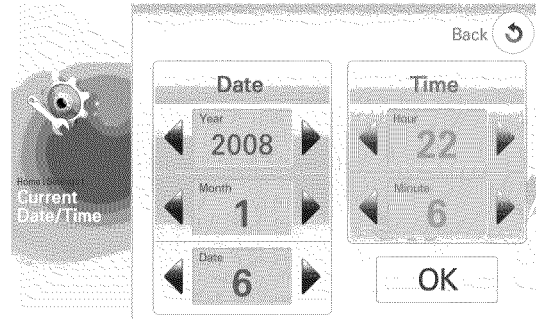

3. To apply your new settings, press [OK] button.

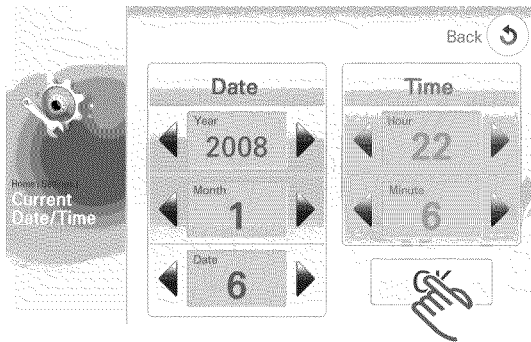

\* This product uses parts of the software from the Independent JPEG Group.

# Operating your SAMSUNG French Door Refrigerator

## PARTS AND FEATURES

Use this page to become more familiar with the parts and features of the Refrigerator.

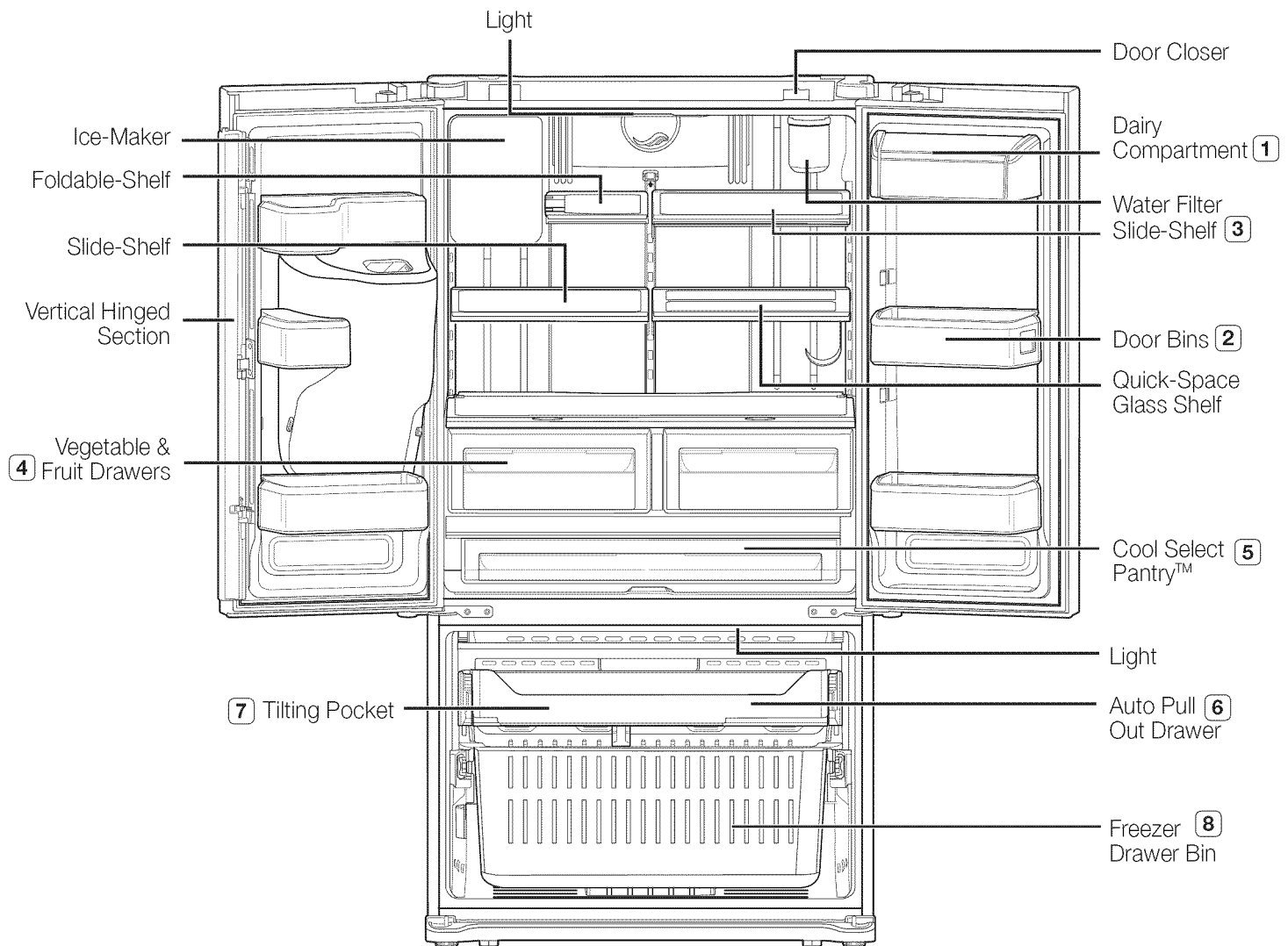

When closing the door, make sure the Vertical Hinged Section is in the correct position to avoid scratching the other door.

If the Vertical Hinged Section is reversed, put it back to the right position and close the door.





Moisture may occur at times on the Vertical Hinged Section.

The door handle may become loose over time. If this happens, tighten the bolts found on the inside of the door.

If you close one door with a lot of force, the other door may open.

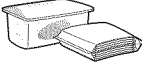

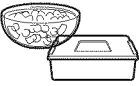
## STORING FOOD IN THE REFRIGERATOR

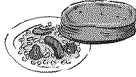

The Samsung French Door Refrigerator has been designed to provide you with maximum space saving features and functions. Here are some of the customized compartments we have created to keep your food fresher longer. In order to further prevent odor from seeping into the ice compartment, stored food should be wrapped securely and as airtight as possible.

(1) DAIRY COMPARTMENT	Can be used to store small dairy items like butter or margarine, yogurt or cream cheese bricks	
(2) DOOR BINS	Designed to handle large, bulky items such as gallons of milk or other large bottles and containers.	
(3) TEMPERED GLASS SHELVES	Designed to be crack-resistant, the shelves can be used to store all types of food and drinks. Circular marks on the glass surface are a normal phenomenon and can usually be wiped clean with a damp cloth.	
(4) VEGETABLE & FRUIT DRAWERS	Used to preserve the freshness of your stored vegetables and fruits. This drawer has been specifically designed to control the level of humidity within the compartment. Keep vegetables and fruits separate when possible.	
(5) COOL SELECT PANTRY™	Can be used for large party trays, deli items, pizza, beverages or miscellaneous items.	

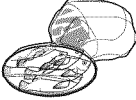
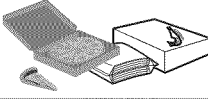
-  Do not place any large articles of food under the lamp in the Refrigerator. An air sensor is located near the lamp and if the sensor is blocked, your Refrigerator may become too cold. Please place Vegetable and Fruits in the Vegetable and Fruits drawers to avoid freezing them. If the food in your Refrigerator becomes frozen, please set the temperature higher.

## STORING FOOD IN THE FREEZER DRAWER

(6) AUTO PULL OUT DRAWER	Best used to store meats or dry foods. Stored food should be placed in a container or wrapped securely using foil or other suitable wrapping materials.	
(7) TILTING POCKET	Can be used for small packages of frozen food. You can store a 16" pizza.	
(8) FREEZER DRAWER BIN	Can be used to store meat and dry foods. Stored food should be placed in a container or wrapped securely using foil or other suitable wrapping materials.	

-  Bottles should be stored tightly together so that they do not tip and fall out when the Refrigerator door is opened.
-  If you plan to go away for a long time, empty the Refrigerator and turn it off. Wipe the excess moisture from the inside of the appliance and leave the doors open. This helps keep odor and mold from developing.

# Operating your SAMSUNG French Door Refrigerator

## USING THE COOL SELECT PANTRY™

The Cool Select Pantry™ is a full-width drawer with adjustable temperature control. This pantry can be used for large party trays, deli items, pizza, beverages or miscellaneous items. There is a temperature control which can adjust the amount of cold air allowed into the pantry.

The control is located on the right side of the pantry.

- Press the Temp button repeatedly until your desired mode is lit. The Fresh mode(38°F), Chilled mode(32°F) and Deli mode(41°F) will be selected whenever you press the Temp button. Initially, the Fresh mode is set. Though the setting temperature is different from the current temperature, the temperature will be changed to the setting temperature automatically.

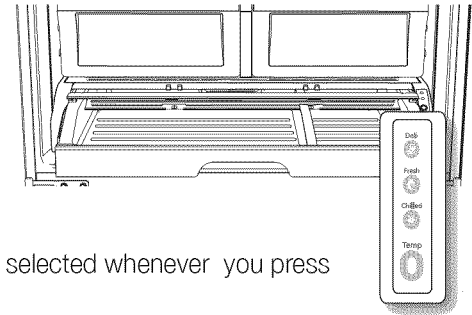

### Temp

You can select your Pantry temperature from among Fresh(38°F[3°C]), Chilled(34°F[0°C]), and Deli(41°F[5°C]) modes.

### Selection Button

1. When "Deli" is selected, the temperature of the pantry will be kept around 41°F(5°C). This feature helps keep food fresh for a long time.
2. When "Fresh" is selected, the temperature of the pantry will be kept around 38°F(3°C). This feature helps keep food fresh for a longer time.
3. When "Chilled" is selected, the temperature of the pantry will be kept around 34°F(1°C). This feature also helps keep meat or fish fresh for a longer time.

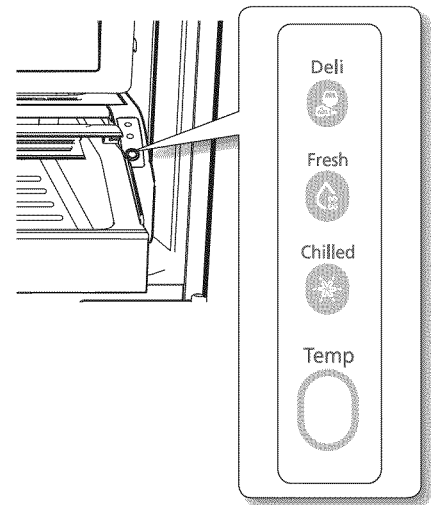

#### Deli

- pineapple
- lemon
- avocado
- potato

#### Fresh

- cucumbers
- apples
- oranges
- grapes
- zucchinis
- corn

#### Chilled

- steaks
- hard cheeses
- cold cuts
- bacon
- hot dogs



Fruits and vegetables may be damaged under the "Chilled" setting. Do not store lettuce or other leafy produce in this pantry.



CAUTION

Do not store glass bottles in this pantry. If they are frozen, they can break and cause personal injury.

## REMOVING THE REFRIGERATOR ACCESSORIES

### 1. Door Bins & Dairy Compartment

To remove - Simply lift the bin up and pull straight out.

To relocate - Slide it in above the desired location and push down until it stops.

 **CAUTION** Injury may occur if the door bins are not firmly assembled. Do not allow children to play with bins. Sharp corners of the bins may cause injury.

 Do not adjust a bin full of foods.

Dust removal method -Remove the guard and wash in water.

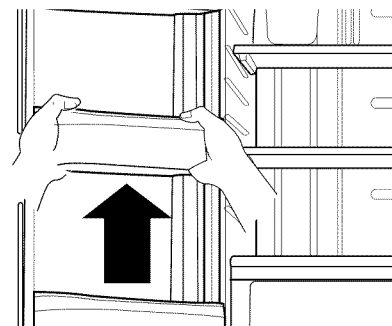

### 2. Tempered Glass shelves

To remove - Tilt the front of the shelf in the direction shown (1) and lift it up vertically (2). Pull the shelf out.

To relocate - Tilt the front of the shelf up and guide the shelf hooks into the slots at a desired height. Then lower the front of the shelf so that the hooks can drop into the slots.

 **CAUTION** The Tempered Glass shelves are heavy. Use special care when removing them.

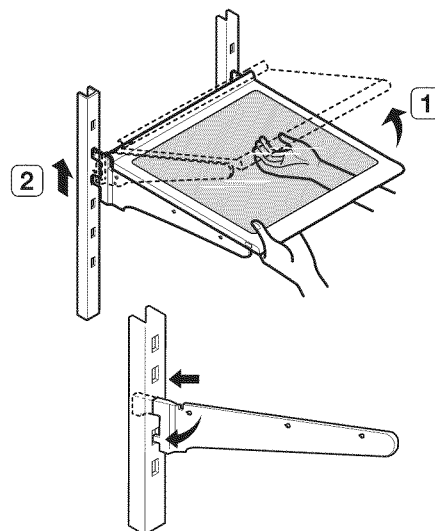

### 3. Vegetable & Fruit Drawers

To remove - Pull the drawer out to full extension. Tilt up the front of the drawer and pull straight out.

To relocate - Insert the drawer into the frame rails and push back into place.

 **CAUTION** The drawers need to be removed before the glass shelf above them can be lifted out. Do not open the drawers while the pantry is open. It may cause a scratch or breakage to the drawer covers.

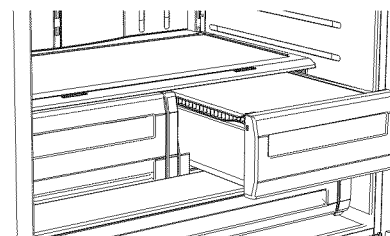
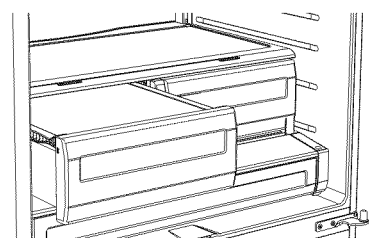

# Operating your SAMSUNG French Door Refrigerator

---

## 4. Cool Select Pantry™

To remove the pantry - Pull the pantry out to full extension. Tilt up the front side of pantry and pull straight out.

To relocate the pantry - Push the rails to the back of the Refrigerator. Place the drawer onto the rails and slide the pantry back until it is in place.

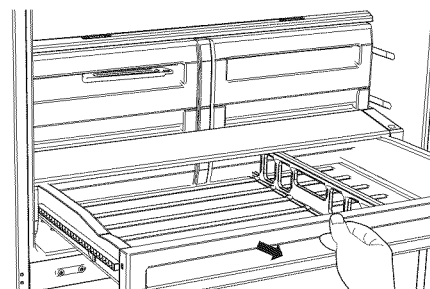

To remove the divider - Pull the pantry completely out to full extension and raise the front side of the divider to unhook it from the rear wall of the pantry, then lift the divider out.

To relocate the divider - Hook the back of the divider over the rear wall of the pantry and push the divider down.

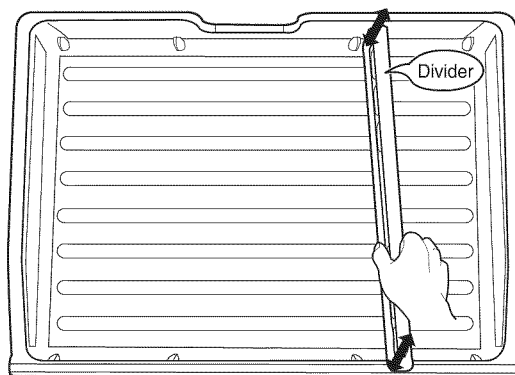

## USING THE DOORS

---

The Refrigerator doors ensure that the doors close all the way and are securely sealed.

When the Refrigerator door is only partially open, it will automatically close. The door will stay open when opened more than 3 inches.

## USING THE TILTING POCKET

---

The Tilting Pocket can be used to store up to a 16" pizza if you place it as shown in the illustration.

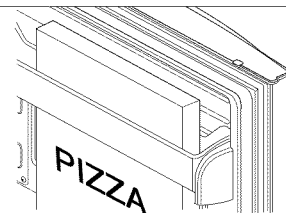

## REMOVING THE FREEZER ACCESSORIES

### 1. Tilting Pocket

To remove - Pull the brackets(1) upward until you hear a clicking sound and remove the pocket

To replace - Hook the ends of the pocket into both brackets (1) and push down until it locks into place.

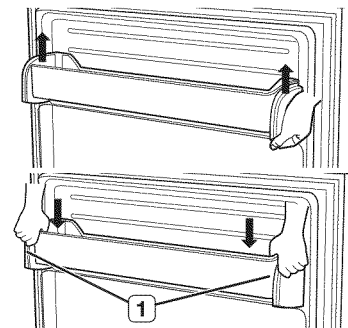

### 2. Auto Pull out Drawer

To remove - Pull the drawer out to full extension.  
Tilt up rear of drawer and lift straight out.

To relocate - Place the drawer onto the rails by tilting it up.  
Lower the drawer into place until it is horizontal and slide the drawer in.

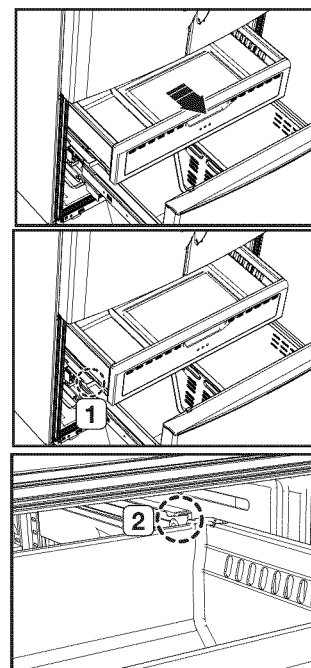

### 3. Freezer Drawer

**To remove the freezer drawer** - Pull the freezer drawer out fully.  
Tilt up the rear of the bin and lift it out to remove.

**To relocate the freezer drawer** - Place the bin into the rail assembly.

**To remove the divider** - Pull the divider straight up.

**To relocate the divider** - Hook the top corners of divider(1) over a hole in the bin (2).



CAUTION

Do not allow babies or children go inside the freezer drawer. They could damage the refrigerator and seriously injure themselves. Do not sit on the freezer door. The door may break. Do not allow children to climb into the freezer drawer.



WARNING

If you remove the divider to clean the freezer drawer, be sure to replace the divider. It is for the safety of babes or children.



CAUTION

• Children can become trapped inside and suffocate.

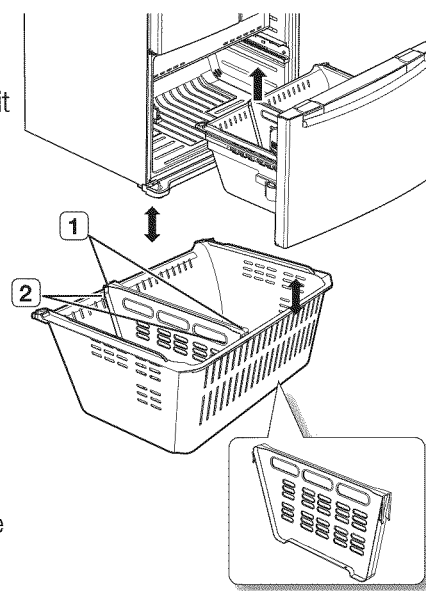

# Operating your SAMSUNG French Door Refrigerator

## CLEANING THE REFRIGERATOR

Caring for your Samsung French Door Refrigerator prolongs the life of your appliance and helps keep the refrigerator free of odor and germs.

### Cleaning the Interior

Clean the inside walls and accessories with a mild detergent and then wipe dry with a soft cloth. You can remove the drawers and shelves for a more thorough cleaning. Just make sure to dry drawers and shelves before putting them back into place.

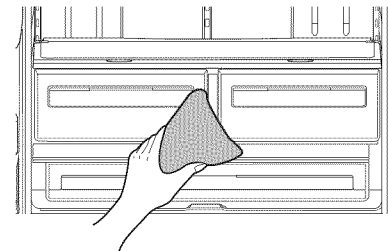

### Cleaning the Exterior

Wipe the control panel and digital display with a damp, clean, soft cloth. Do not spray water directly on the surface of the refrigerator. The doors, handles and cabinet surfaces should be cleaned with a mild detergent and then wiped dry with a soft cloth. To keep your appliance looking its best, polish the exterior once or twice a year.

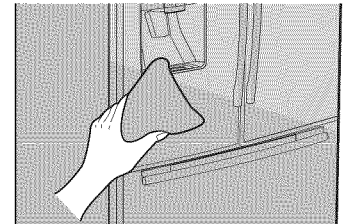

 Do not spray water directly or not use a wet or damp cloth.  
CAUTION

 Do not use benzene, thinner, or Clorox for cleaning. They may damage the surface of the appliance and may cause a fire.  
CAUTION



 Printed letters on the display may be erased if the stainless cleaner is applied directly to the area where the letters are printed.  
CAUTION

### Cleaning the Ice / Water Dispenser

Push down one end of the tray dispenser and remove it. Wipe the Ice / Water Dispenser with a clean and soft cloth.

 When using the crushed ice selection from the dispenser some residual ice chips may start to collect in the ice chute. In order to prevent that residual ice from melting and running out of the chute you should clean out the residual ice when you see it start to collect in the ice chute.  
CAUTION





## Cleaning the Rubber door seals

If the rubber door seals are dirty, the doors may not close properly, and the refrigerator will not operate efficiently. Keep the door seals free of dust or stain by cleaning the doors with a mild detergent and damp cloth. Wipe dry with a clean, soft cloth.

 Do not clean the refrigerator with benzene, thinner, or car  
CAUTION detergent due to risk of fire.

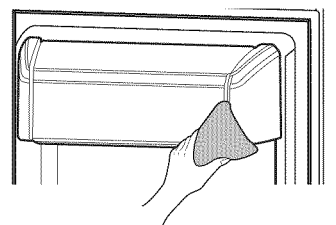

## Cleaning the rear side of the refrigerator

To keep cords and exposed parts free of dust and dirt accumulation. Vacuum the rear side of the appliance once or twice a year.

 Do not remove the back cover( 1 ). You could suffer an electric  
CAUTION shock.

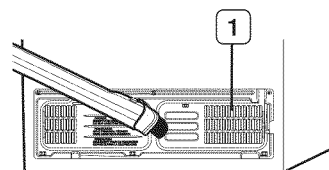

## REPLACING THE INTERIOR LIGHT

 For LED lamp, please contact service engineer to replace it.

# Operating your SAMSUNG French Door Refrigerator

## WATER FILTER CHART

### Performance Data Sheet For Samsung Model DA97-06317A Using Replacement Cartridge DA29-00003G

This system has been tested according to NSF/ANSI Standards 42 and 53 for the reduction of the substances listed below. The concentration of the indicated substances in water entering the system was reduced to a concentration less than or equal to the permissible limit for water leaving the system, as specified in NSF/ANSI 42 and 53.



System tested and certified by NSF International against NSF/ANSI Standard 42 for the reduction of Chlorine Taste and Odor, Particulate Class I, and against NSF/ANSI Standard 53 for the reduction of Cysts, Turbidity, Lead, Asbestos, Benzene, Carbofuran, p-Dichlorobenzene and Mercury.

To a capacity of 300 gallons (1,136 liters).

Note that while the testing was performed under standard laboratory conditions, actual performance may vary.

Contaminant Reduction	Average Influent Concentration	NSF Specified Influent Challenge Concentration Units apply to each row	Average % Reduction	Average Product Water Concentration	Max. Permissible Product Water Concentration	NSF Reduction Requirements	NSF Test
Chlorine taste and odor	2.1 mg/L	2.0 mg/L ± 10%	97.6	0.05 mg/L	NA	> 50%	J-00029741
Particulate Class I Particle size: < 0.5 to < 1 um	10,566,666 pt/mL	At least 10,000 particles/mL	98.4	171,833 pts/mL	NA	> 85%	J-00029739
Cysts*	127,500 cysts/L	Minimum 50,000 cysts/L	99.99	<1 cyst/L	NA	> 99.95%	J-00031000
Turbidity	10.5	11±1 NTU	98.6	0.15 NTU	0.5 NTU	> 0.5 NTU	J-00033223
Lead @ pH 6.5	153 ug/L	0.15±10%	99.3	<1ug/L	0.010 mg/L	10 ug/L	J-00039590
Lead @ pH 8.5	155 ug/L	0.15±10%	>99.4	<1ug/L	0.010 mg/L	10 ug/L	J-00039591
Mercury @ pH 6.5	5.97 ug/L	0.006±10%	96.6	<0.2 ug/L	0.002 mg/L	2 ug/L	J-00039589
Mercury @ pH 8.5	6.29 ug/L	0.006±10%	88.9	0.7 ug/L	0.002 mg/L	2 ug/L	J-00039586
Asbestos	140 MFL	107 to 108 fibers > um in length	> 99	<0.17 MFL	NA	99%	J-00029743
Benzene	13.88 ug/L	0.015±10%	96.4	<0.5 ug/L	0.005 mg/L	< 5 ug/L	J-0029751
Carbofuran	79.6 ug/L	0.190 mg/L	98.7	1 ug/L	0.001 mg/L	< 40 ug/L	J-00029750
p-Dichlorobenzene	237.5 ug/L	0.225±10%	99.8	0.525 ug/L	0.075 mg/L	< 75 ug/L	J-00029749

\* Based on the use of *Cryptosporidium parvum* oocysts

# Operating your SAMSUNG French Door Refrigerator

## WATER FILTER CERTIFICATION

State of California  
Department of Public Health  
Water Treatment Device  
Certificate Number

04 - 1660

Date Issued: July 7, 2004

Date Revised: June 2, 2008

---

---

**Trademark/Model Designation**

Samsung DA61-00159A-B

Samsung DA97-06317A

**Manufacturer:** Cuno Incorporated

---

---

**Replacement Elements**

DA29-00003

DA29-00003G

The water treatment device(s) listed on this certificate have met the testing requirements pursuant to Section 116830 of the Health and Safety Code for the following health related contaminants:

**Microbiological Contaminants and Turbidity**

Cysts  
Turbidity

**Organic Contaminants**

Benzene  
Carbofuran  
p-Dichlorobenzene

**Inorganic/Radiological Contaminants**

Asbestos  
Lead  
Mercury

---

**Rated Service Capacity:** 300 gal

**Rated Service Flow:** 0.5 gpm

---

**Conditions of Certification:**

Do not use where water is microbiologically unsafe or with water of unknown quality, except that systems certified for cyst reduction may be used on disinfected waters that may contain filterable cysts.

# Operating your SAMSUNG French Door Refrigerator

## FOOD STORAGE TIPS

Foods	Refrigerator	Freezer	Storage Tips
<b>DAIRY PRODUCTS</b>			
Butter	2-3 Weeks	6-9 Months	Wrap or cover tightly.
Milk	1-2 Weeks	Not recommended	Check date code. Most milk and similar products are sold in date-coded cartons that indicate a product's peak freshness. Re-seal with cap or wrap tightly. Do not return unused portions to original container.
Cream Cheese, cheese food, and cheese spread	2-4 Weeks	Not recommended	Check date code. Keep all cheese tightly packed in moisture proof wrap.
Hard Cheese(unopened)	3-4 Months	6 Months	
Hard Cheese(opened)	2 Months	Not recommended	
Cottage Cheese	10-15 Days	Not recommended	
Cream	7-10 Days	2 Months	Check date code. Most yogurt, creams, and similar products are sold in date-coded cartons that indicate a product's peak freshness. Re-seal or cover tightly. Do not return unused portions to original container.
Sour Cream	2 Weeks	Not recommended	
Cream Dips (opened)	1 week	Not recommended	
Yogurt	10-14 Days	Not recommended	Check date code. Keep covered.
Frozen Yogurt	n/a	2 Months	
<b>EGGS</b>			
Eggs (uncooked)	3-4 Weeks	Not recommended	Check date code. Store eggs in coldest part of refrigerator and in their original container.
Eggs (cooked)	1 week	Not recommended	Store in covered container.
Leftover egg dishes	3-4 Days	Not recommended	Store in covered container.
<b>FRESH FRUITS</b>			
Apples	1 Month	Not recommended	If storing in refrigerator, do not wash fruit before storing. Store in moisture resistant bags or containers. Wrap cut fruits. Some fruits darken when refrigerated.
Bananas	2-4 Days	Not recommended	
Peaches, Melons, Pears, Avocados	3-5 Days	Not recommended	
Berries and Cherries	2-3 Days	12 Months	
Apricots	3-5 Days	Not recommended	
Grapes	3-5 Days	n/a	
Pineapple (un-cut)	2-3 Days	Not recommended	
Pineapple (cut)	5-7 Days	6-12 Months	
Citrus	1-2 Weeks	Not recommended	Store uncovered.
Juice	6 Days	Not recommended	Check date code and re-seal in original container. Do not return unused portions to original container.
Frozen Juice	Thawing only	12 Months	Check date code. Do not re-freeze.

# Operating your SAMSUNG French Door Refrigerator

## FOOD STORAGE TIPS

Foods	Refrigerator	Freezer	Storage Tips
<b>FISH AND SHELLFISH</b>			
Fish			
Fatty Fish (mackerel, trout, salmon)	1-2 Days	2-3 Months	Keep in original wrapper and store in coldest part of refrigerator. Package in vapor-proof and moisture proof wrap for freezer. Freeze at 0°F. Thaw in refrigerator or under cold running water.
Lean Fish (cod, flounder, etc)	1-2 Days	6 Months	
Frozen or Breaded	n/a	3 Months	Check date code. Freeze in original packaging.
Shellfish			
Shrimp (uncooked)	1-2 Days	12 Months	To freeze package in vapor-proof and moisture-proof container.
Crab	3-5 Days	10 Months	
Cooked Fish or Shellfish	2-3 Days	3 Months	
<b>MEAT</b>			
Fresh, Uncooked			
Chops	2-4 Days	6-12 Months	Check date code for use. Store in coldest part of refrigerator in original packaging. Add more packaging in moisture-proof and vapor-proof container for freezing. Recommended refrigerator temperature 33°F to 36°F and freezer temperature 0°F to 2°F.
Ground	1 day	3-4 months	
Roast	2-4 Days	6-12 Months	
Bacon	1-2 weeks	1-2 Months	
Sausage	1-2 Days	1-2 Months	
Steak	2-4 Days	6-9 Months	
Poultry	1 day	12 Months	
Lunch meat	3-5 Days	1 month	
Cooked			
Meat	2-3 Days	2-3 Months	Check date code for use. Store in coldest part of refrigerator in original packaging. Package in moistureproof and vapor-proof container for freezing.
Poultry	2-3 Days	4-5 months	
Ham	1-2 weeks	1-2 Months	

### Sources :

American Meat Institute Foundation. 1994. Yellow pages: answers to predictable questions consumers ask about meat and poultry. American Meat Institute  
 Food Marketing Institute. 1999. The food keeper. Food Marketing Institute, Washington, D.C.  
 Feiland-Graves, J.H. and G.C. Peckham. 1996. Foundations of food preparation, 6th ed. Prentice-Hall, Inc. Englewood Cliffs, NJ.  
 Hillers, V.N. 1993. Storing foods at home. Washington State University Cooperative Extension, Pullman, WA. Publ. EB 1205.  
 National Restaurant Association. 2001. Be cool-chill out! Refrigerate promptly. National Restaurant Association Education Foundation's International Food Safety Council, Washington, D.C.  
 USDA. 1997. Basics for handling food safely. U.S. Department of Agriculture, Food Safety and Inspection Service, Washington, D.C.

# Troubleshooting

PROBLEM	SOLUTION
The Refrigerator does not work at all or it does not chill sufficiently.	<ul style="list-style-type: none"> <li>• Check that the power plug is properly connected.</li> <li>• Is the temperature control on the display panel set to the correct temperature? Try setting it to a lower temperature.</li> <li>• Is the Refrigerator in direct sunlight or located near a heat source?</li> <li>• Is the back of the Refrigerator too close to the wall and therefore keeping air from circulating?</li> </ul>
The food in the Refrigerator is frozen.	<ul style="list-style-type: none"> <li>• Is the temperature control on the display set to the correct temperature? Try setting it to a warmer temperature.</li> <li>• Is the temperature in the room too low?</li> <li>• Did you store the food with high water content in the coldest part of the Refrigerator? Try moving those items into the body of the Refrigerator instead of keeping them in the Cool Select Pantry™.</li> </ul>
You hear unusual noise or sounds.	<ul style="list-style-type: none"> <li>• Check that the Refrigerator is level and stable.</li> <li>• Is the back of the Refrigerator too close to the wall and therefore keeping air from circulating?</li> <li>• Was anything dropped behind or under the Refrigerator?</li> <li>• A “ticking” sound is heard from inside the Refrigerator. It is normal and occurs because various accessories are contracting or expanding according to the temperature of the Refrigerator interior.</li> </ul>
The front corners and vertical hinged section of the appliance are hot and condensation is occurring.	<ul style="list-style-type: none"> <li>• Some heat is normal as anti-condensators are installed in the vertical hinged section of the Refrigerator to prevent condensation.</li> <li>• Is the Refrigerator door ajar? Condensation can occur when you leave the door open for a long time.</li> </ul>
Ice Maker is not producing ice.	<ul style="list-style-type: none"> <li>• Did you wait for 12 hours after installation of the water supply line before making ice?</li> <li>• Is the water line connected and the shut-off valve opened?</li> <li>• Did you manually stop the ice making function?</li> <li>• Is the Freezer temperature too warm? Try setting the Freezer temperature lower.</li> </ul>
You can hear water bubbling in the Refrigerator.	<ul style="list-style-type: none"> <li>• This is normal. The bubbling comes from the Refrigerator coolant liquid circulating through the Refrigerator.</li> </ul>
There is a bad smell in the Refrigerator.	<ul style="list-style-type: none"> <li>• Check for spoiled food.</li> <li>• Foods with strong odors(for example, fish) should be tightly covered.</li> <li>• Clean out your Freezer periodically and throw away any spoiled or suspicious food.</li> </ul>
Frost forms on the walls of the Freezer.	<ul style="list-style-type: none"> <li>• Is the air vent blocked? Remove any obstructions so air can circulate freely.</li> <li>• Allow sufficient space between the foods stored for efficient air circulation.</li> <li>• Is the Freezer drawer closed properly?</li> </ul>
Water dispenser is not functioning.	<ul style="list-style-type: none"> <li>• Is the water line connected and the shut-off valve opened?</li> <li>• Has the water supply line tubing been crushed or kinked? Make sure the tubing is free and clear of any obstruction.</li> <li>• Is the water tank frozen because the Refrigerator temperature is too low? Try selecting a warmer setting on the main display panel.</li> </ul>

# Troubleshooting

PROBLEM	SOLUTION
When the Display function do not work.	Check to see if the child lock function is set. If so, set it off. If the child lock function is not set, push the Reset groove with sharp tool and make it initialize. (User's information is not removed.)
There is nothing on the "Portable Memory Device" screen even after inserting a memory card.	Check to see if images are saved in your memory card (SD/SDHC/MMC/HS MMC). If there are no images saved, no images will appear. If no images appear even though images are loaded on the card, make sure the files are ".jpg". Only ".jpg" files are compatible with this screen. Depending on the card type, it may take up to 5 seconds for the images to load.
LCD Screen is off frequently.	The LCD Backlight Off function is used to reduce the refrigerator power consumption. The Portable Memory Device screen will turn off after the set screen saver time or if there is no user operation for 20 minutes, With other functions, the screen will turn off after the set screen saver time or if there is no user operation for 1 minute.
Afterimage appears on the screen. Border line appears on the screen.	If stationary images, images of the same size or images with black bars on the top or sides are displayed for an extended time, screen burn may occur. To avoid this, display images with varied sizes.  The warranty does not cover screen burn issues.
Input point in the Touch Screen is not functioning correctly.	Perform the touch point calibration (see page 22).

# Warranty

---

## SAMSUNG REFRIGERATOR

---

### LIMITED WARRANTY TO ORIGINAL PURCHASER

This Samsung brand product, as supplied and distributed by Samsung Electronics America, Inc. (Samsung) and delivered new, in the original carton to the original consumer purchaser, is warranted by Samsung against manufacturing defects in materials and workmanship for a limited warranty period of:

**One (1) year Parts and Labor on Refrigerator**

**Five (5) years Parts and Labor on sealed Refrigeration system only\***

(\*Compressor, evaporator, condenser, drier, connecting tubing)

This limited warranty begins on the original date of purchase, and is valid only on products purchased and used in the United States. To receive warranty service, the purchaser must contact Samsung for problem determination and service procedures. Warranty service can only be performed by a Samsung authorized service center. The original dated bill of sale must be presented upon request as proof of purchase to Samsung or Samsung authorized service center.

Samsung will repair or replace any part found to be defective, at our option and at no charge as stipulatedX herein, with new or reconditioned parts during the limited warranty period specified above. All replaced parts and products become the property of Samsung and must be returned to Samsung. Replacement parts and products assume the remaining original warranty, or ninety (90) days, whichever is longer.

In-home service will be provided during the warranty labor period subject to availability within the contiguous United States. In-home service is not available in all areas. To receive in-home service, the product must be unobstructed and accessible from floor level to service personnel. If during in-home service repair cannot be completed, it may be necessary to remove, repair and return the product. If in-home service is unavailable, Samsung may elect, at our option, to provide for transportation of our choice to and from a Samsung authorized service center. Otherwise, transportation to and from the Samsung authorized service center is the responsibility of the purchaser.

This limited warranty covers manufacturing defects in materials and workmanship encountered in normal, noncommercial use of this product, and shall not apply to the following, including, but not limited to: damage which occurs in shipment; delivery and installation; applications and uses for which this product was not intended; altered product or serial numbers; cosmetic damage or exterior finish; accidents, abuse, neglect, fire, water, lightning or other acts of nature; use of products, equipment, systems, utilities, services, parts, supplies, accessories, applications, installations, repairs, external plumbing and leaks, external wiring, circuit breakers, fuses or connectors not supplied and authorized by Samsung, or which damage this product or result in service problems; incorrect electrical line voltage, fluctuations and surges; customer adjustments and failure to follow operating instructions, cleaning, maintenance and environmental instructions that are covered and prescribed in the instruction book; loss of food due to spoilage; consumable items including filters and light.



THERE ARE NO EXPRESS WARRANTIES OTHER THAN THOSE LISTED AND DESCRIBED ABOVE, AND NO WARRANTIES WHETHER EXPRESS OR IMPLIED, INCLUDING, BUT NOT LIMITED TO, ANY IMPLIED WARRANTIES OF MERCHANTABILITY OR FITNESS FOR A PARTICULAR PURPOSE, SHALL APPLY AFTER THE EXPRESS WARRANTY PERIODS STATED ABOVE, AND NO OTHER EXPRESS WARRANTY OR GUARANTY GIVEN BY ANY PERSON, FIRM OR CORPORATION WITH RESPECT TO THIS PRODUCT SHALL BE BINDING ON SAMSUNG. SAMSUNG SHALL NOT BE LIABLE FOR LOSS OF REVENUE OR PROFITS, FAILURE TO REALIZE SAVINGS OR OTHER BENEFITS, OR ANY OTHER SPECIAL, INCIDENTAL OR CONSEQUENTIAL DAMAGES CAUSED BY THE USE, MISUSE OR INABILITY TO USE THIS PRODUCT, REGARDLESS OF THE LEGAL THEORY ON WHICH THE CLAIM IS BASED, AND EVEN IF SAMSUNG HAS BEEN ADVISED OF THE POSSIBILITY OF SUCH DAMAGES. NOR SHALL RECOVERY OF ANY KIND AGAINST SAMSUNG BE GREATER IN AMOUNT THAN THE PURCHASE PRICE OF THE PRODUCT SOLD BY SAMSUNG AND CAUSING THE ALLEGED DAMAGE. WITHOUT LIMITING THE FOREGOING, PURCHASER ASSUMES ALL RISK AND LIABILITY FOR LOSS, DAMAGE OR INJURY TO PURCHASER AND PURCHASER'S PROPERTY AND TO OTHERS AND THEIR PROPERTY ARISING OUT OF THE USE, MISUSE OR INABILITY TO USE THIS PRODUCT SOLD BY SAMSUNG NOT CAUSED DIRECTLY BY THE NEGLIGENCE OF SAMSUNG. THIS LIMITED WARRANTY SHALL NOT EXTEND TO ANYONE OTHER THAN THE ORIGINAL PURCHASER OF THIS PRODUCT, IS NONTRANSFERABLE AND STATES YOUR EXCLUSIVE REMEDY.

Some states do not allow limitations on how long an implied warranty lasts, or the exclusion or limitation of incidental or consequential damages, so the above limitations or exclusions may not apply to you. This warranty gives you specific legal rights, and you may also have other rights, which vary from state to state.

To obtain warranty service, please contact Samsung at:

**SAMSUNG CUSTOMER CARE CENTER**

Samsung Electronics America, Inc. 85 Challenger Road Ridgefield Park, NJ 07660  
1-800-SAMSUNG (1-800-726-7864) and [www.samsung.com](http://www.samsung.com)



## QUESTIONS OR COMMENTS?

COUNTRY	CALL	OR VISIT US ONLINE AT	WRITE
U.S	800-SAMSUNG (800-726-7864)	<a href="http://www.samsung.com">www.samsung.com</a>	Samsung Electronics America, Inc. 85 Challenger Road Ridgefield Park, NJ 07660
CANADA	800-SAMSUNG (800-726-7864)	<a href="http://www.samsung.com/ca">www.samsung.com/ca</a>	Samsung Electronics Canada Inc. Customer Service, 55 Standish Court Mississauga, Ontario L5R 4B2 Canada

 In an effort to promote recycling this user manual is printed on recycled paper.