

AS3100 series

Upright vacuum cleaner; household type

Owner's Guide

Thank you for purchasing your new Eureka vacuum!

Important instructions

For easy assembly, please take a few moments to read this owner's guide.

If you have questions about your new vacuum, please contact our customer service helpline at **1-800-282-2886**. *We're here to help!*

Promotional code: eurekaad15

Special Offer – receive 15% off parts and accessories when ordering online. Promotion excludes vacuums.

www.eureka.com

© 2014 Electrolux Home Care Products, Inc. Printed in China WMT88658



eureka®

Where to find important vacuum information

Keep this information

Write the model, type and serial number here:

Date of purchase (keep your receipt) _____

Model number and type _____

Serial number _____

Find these numbers on a label on the middle back side of the vacuum cleaner. Refer to these numbers when ordering parts and accessories or if service is needed.

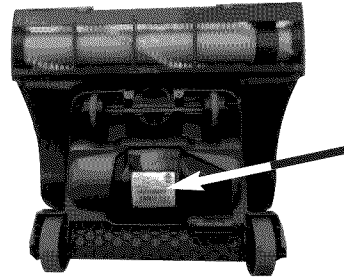

This Owner's Guide provides important instructions to prolong the life of your Eureka

Registration: To register your product visit www.eureka.com and click on the 'Register Your Product' link in the top right corner.

Inspection: Carefully unpack and inspect your new Eureka vacuum cleaner for shipping damage. Each unit is tested and thoroughly inspected before shipping. For instructions regarding any shipping damage, call Eureka Customer Service **HELPLINE 1-800-282-2886** immediately.

Contents

Important safeguards	3
What comes in the carton	4
How to assemble your vacuum cleaner	5
How to identify parts of your vacuum cleaner	6
Filter maintenance instructions	7
Dust cup, filter, screen and exhaust filter	
How to use your vacuum cleaner	8
How to use accessories	9
Brush roll on/off pedal, crevice tool, extension wand, dusting brush and turbo nozzle	
How to clear a blockage	10
How to maintain turbo nozzle	11
How to maintain brush roll	11
How to replace brush roll or belt	12
Thermal cut-off and problem solving	13
Eureka limited warranty information	14
Order forms and parts list	15

 Follow caution information wherever you see this symbol.

IMPORTANT SAFEGUARDS

When using an electrical appliance, basic precautions should always be followed, including the following:

READ ALL INSTRUCTIONS BEFORE USING THIS VACUUM CLEANER WARNING



To reduce the risk of fire, electric shock, or injury:

- Do not use outdoors or on wet surfaces.
- **Do not leave vacuum cleaner when plugged in.** Turn off the switch and unplug the electrical cord when not in use and before servicing.
- Do not allow to be used as a toy. Close attention is necessary when used by or near children.
- Use only as described in this manual. Use only manufacturer's recommended attachments.
- Do not use with damaged cord or plug. If vacuum cleaner is not working as it should, has been dropped, damaged, left outdoors, or dropped into water, return it to a service center before using.
- Do not pull or carry by cord. Do not use cord as a handle. Do not close a door on cord or pull cord around sharp edges or corners. Do not run vacuum cleaner over cord. Keep cord away from heated surfaces.
- Do not use extension cords or outlets with inadequate current carrying capacity.
- Turn off all controls before unplugging.
- Do not unplug by pulling on cord. To unplug, grasp the plug, not the cord.
- Do not handle plug or vacuum cleaner with wet hands.
- Do not put any object into openings. Do not use with any opening blocked; keep free of dust, lint, hair, and anything that may reduce airflow.
- This vacuum cleaner creates suction and contains a revolving brush roll. Keep hair, loose clothing, fingers, and all parts of body away from openings and moving parts.
- Do not place vacuum cleaner on furniture or stairs as the brush roll may cause damage. Use extra care when cleaning stairs. Place vacuum cleaner on floor with the handle in storage position while using attachments.
- Do not pick up anything that is burning or smoking, such as cigarettes, matches, or hot ashes.
- Do not use without dust cup, filter, screen and exhaust filter in place.
- Belt pulleys can become hot during normal use. To prevent burns, avoid touching the belt pulley when servicing the drive belt.
- Do not use to pick up flammable or combustible liquids such as gasoline, or use in areas where they may be present.
- Store your vacuum cleaner indoors in a cool, dry area.
- Keep your work area well lighted.
- Unplug electrical appliances before vacuuming them.
- Unplug before connecting turbo nozzle.

SAVE THESE INSTRUCTIONS

To reduce the risk of electric shock, this appliance has a polarized plug (one blade is wider than the other). This plug will fit in a polarized outlet only one way. If the plug does not fit fully into the outlet, reverse the plug. If it still does not fit, contact a qualified electrician to install the proper outlet. Do not change the plug in any way.



Motor

Do Not Oil the motor or the brush roll at any time. The bearings are permanently lubricated and sealed.

What comes in the carton

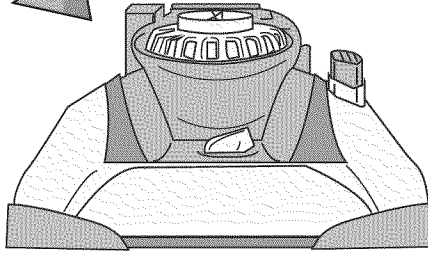
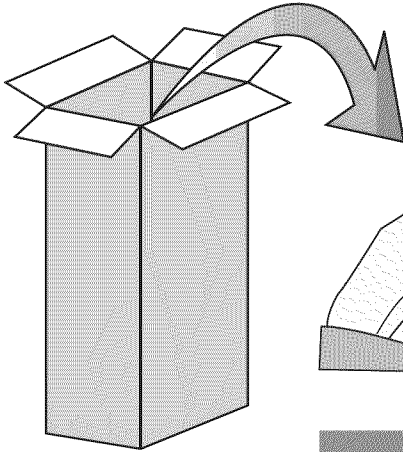

Vacuum cleaner

AS3100 Series

**OWNER'S
GUIDE**

Important
safeguards

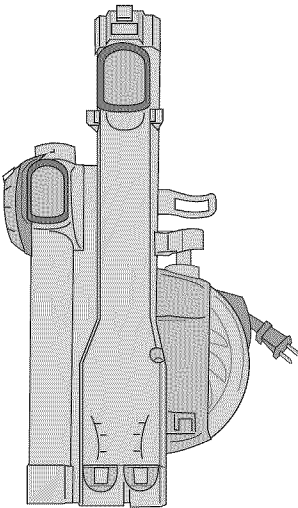

Vacuum back

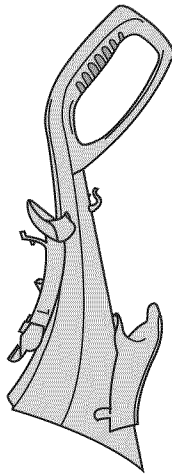

Handle

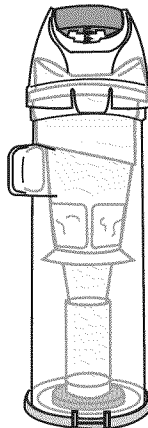

Dust cup

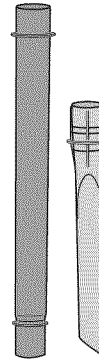

Extension wand
and crevice tool

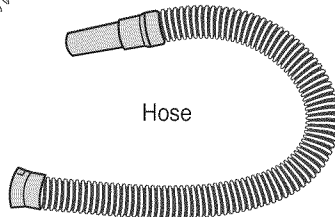

Hose

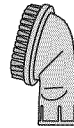

Dusting brush

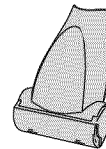

Turbo nozzle

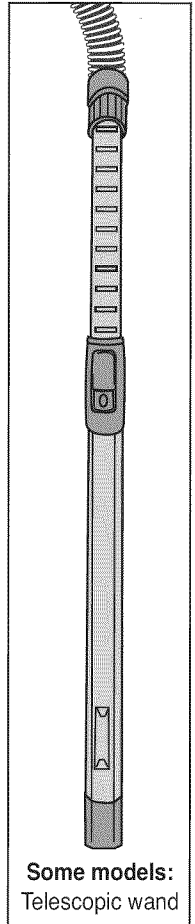

Some models:
Telescopic wand

How to assemble your vacuum cleaner

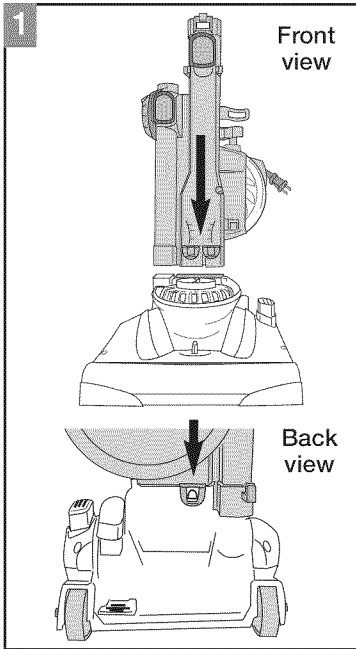

Place vacuum back on base and push down until it snaps into place.

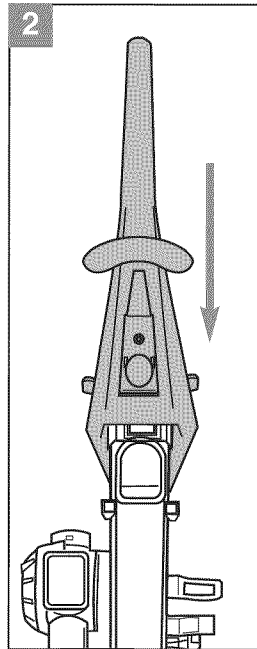

Slide handle onto vacuum back and push down until it snaps.

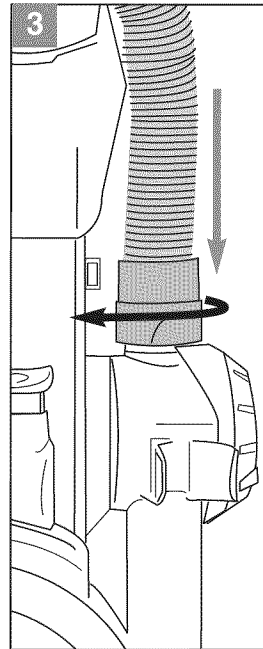

Install hose: Align tabs and push down; twist clockwise to lock.

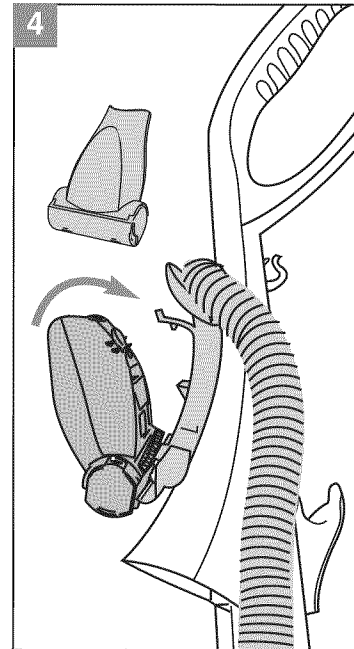

Snap turbo nozzle into holder, and loop hose on front of handle.

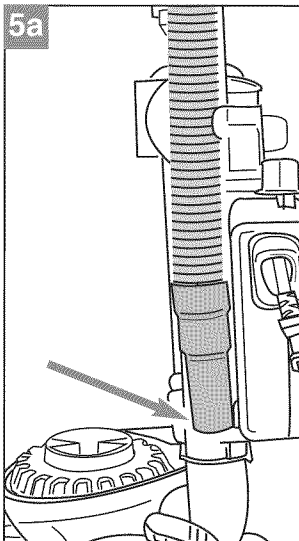

Secure loose end of hose over hose hook.

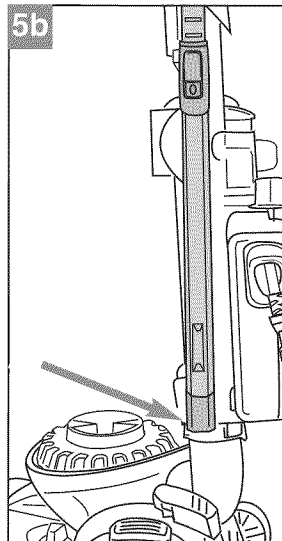

Some models: Secure loose end of telescopic wand over hose hook.

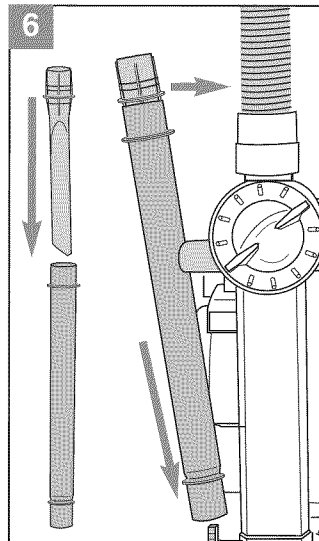

Slip crevice tool inside extension wand; store in holder on side of vacuum.

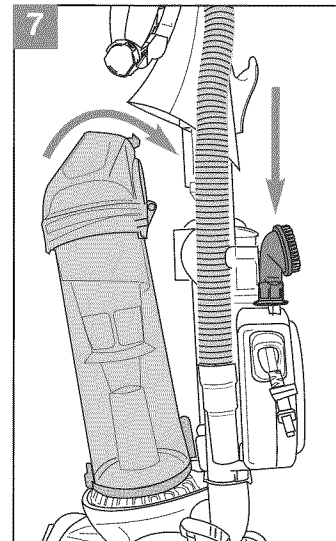

Place dust cup on base and snap into place. Store dusting brush on back of vacuum.

How to identify parts of your vacuum cleaner

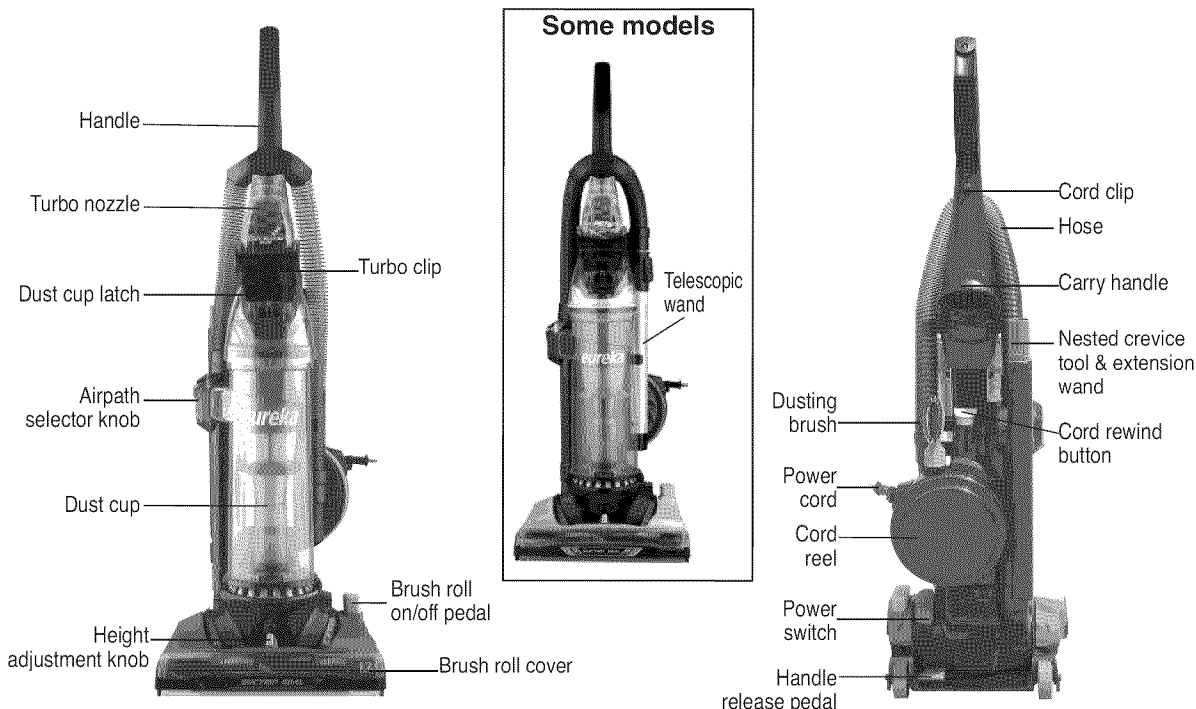

NOTE: For filter maintenance instructions, see page 7.

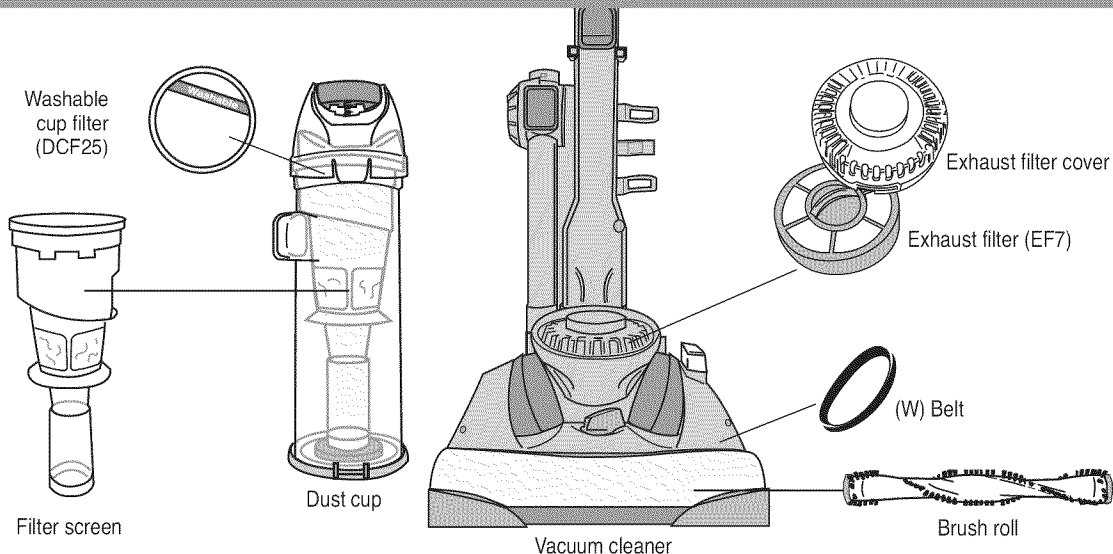

Filter maintenance instructions

Dust cup – Empty after each use

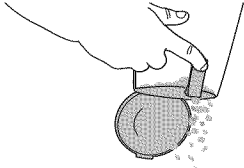

Press lever to release bottom lid. Debris will empty. Close lid until it clicks.

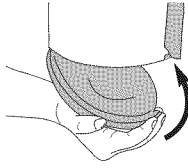

Belt – Check regularly

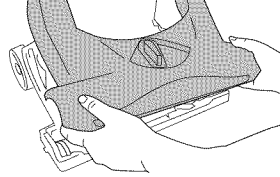

For belt change instructions, go to page 12.

Washable dust cup filter (DCF25) – Clean monthly

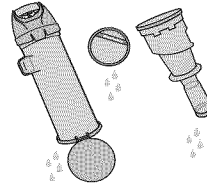
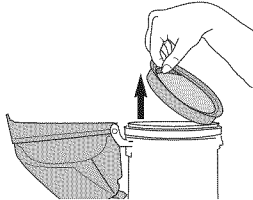
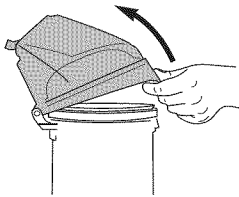

Pull latch to lift up cover. Lift out foam filter and filter screen; shake off dust. Rinse foam filter, screen and dust cup. Dry all thoroughly.

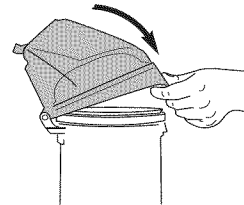
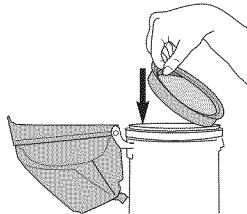
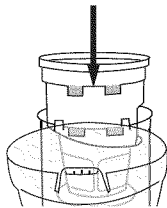

Align tabs on filter screen with slots on back of cup. Drop into position. Reinstall foam filter and close cover. *Warning: Filters and screen must be positioned properly for cover to lock.*

Exhaust filter (EF7) – Replace every 6-12 months

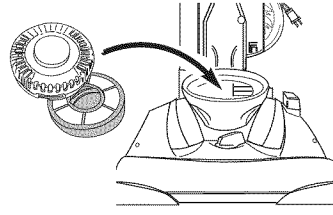
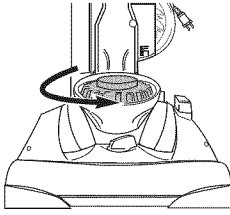
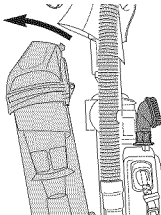

Remove dust cup. Twist filter cover counter-clockwise and lift off. Replace exhaust filter and cover. Turn to lock and snap dust cup back into place.

Exhaust filter cover must be in place at all times.



Brush roll – Clean monthly

How to use your vacuum cleaner

- Pull out cord to desired length (Fig. 1). Do not pull past red line. Press button to rewind cord.

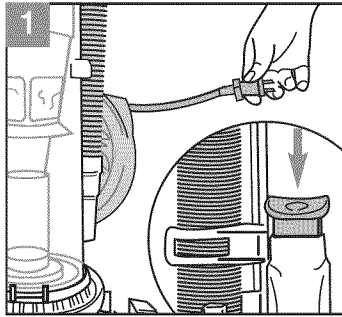

- Plug power cord into outlet.

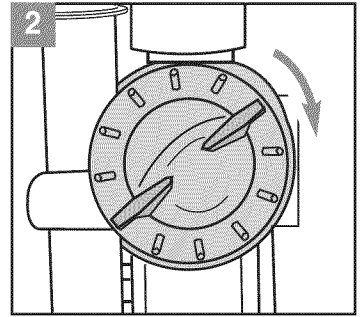

- To vacuum floors, turn air path knob to 'FLOORS' (Fig. 2).

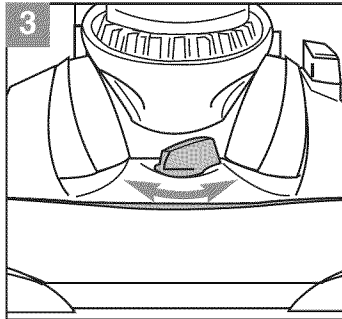

- Turn knob to adjust height for bare floor and Low to High pile carpet (Fig. 3).

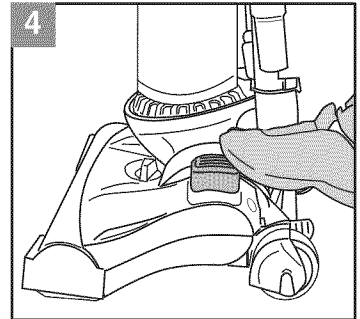

- Adjust brush roll on/off pedal. Step on pedal to turn brush roll on for carpet or off for bare floors (Fig. 4).

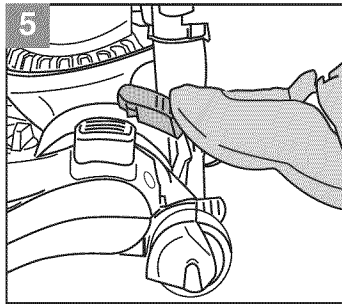

- Step on power switch to turn on. Step on again to turn off (Fig. 5).

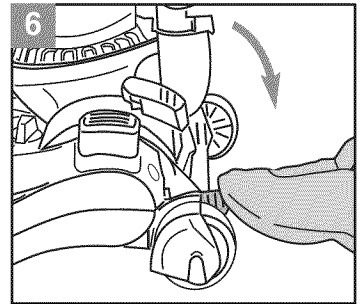

- Step on handle release to lower handle into position (Fig. 6).

Empty dust cup after every use

- Lift latch and pull out dust cup (Fig. 7).

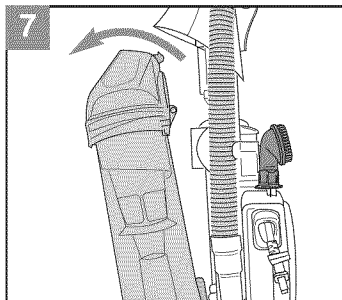

- To empty debris, press lever to release bottom lid (Fig. 8).

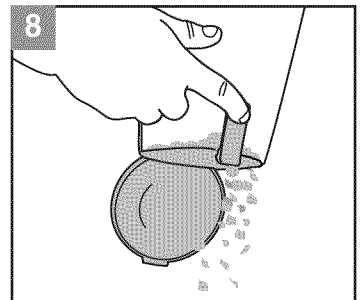

How to use accessories

CAUTION

When using tools, always place handle in upright position and turn off brush roll.

- Place vacuum in upright position (Fig. 1).
- Turn air path selector knob to 'TOOLS' (Fig. 2).
- Step on brush roll pedal to turn off brush roll (Fig. 3).
- Remove extension wand from clip and lift out crevice tool (Fig. 4). Push narrow end of wand over end of hose.
- Push tool onto extension wand or directly onto end of hose (Fig 5).
- **Some models:** Push tool onto telescopic wand. Push button to extend wand. (Fig. 6).

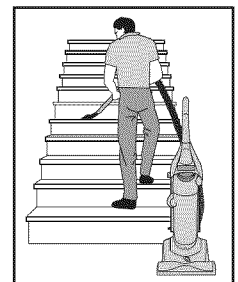
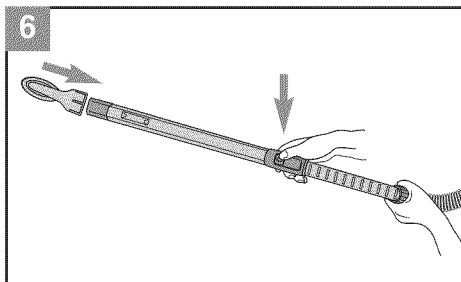
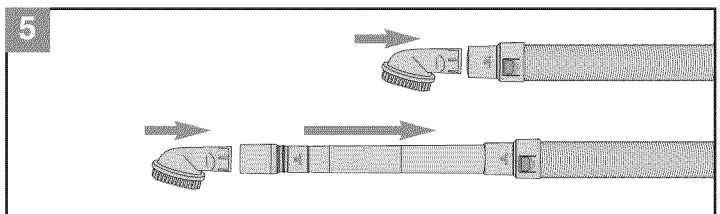
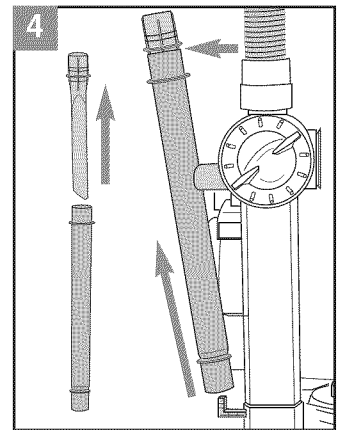
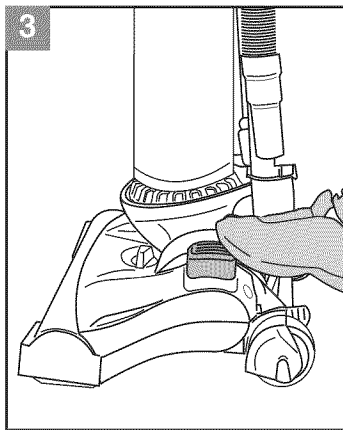
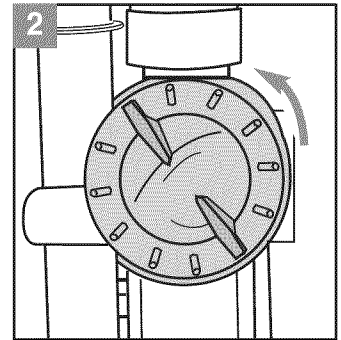
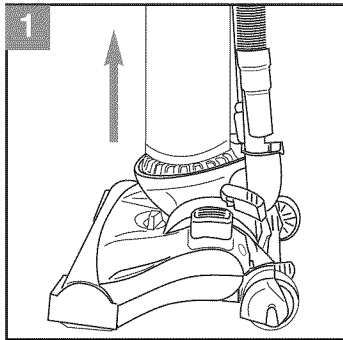

Dusting brush

Use for furniture, drapes and vents. To extend reach, attach brush to end of crevice tool.

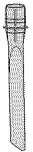

Crevice tool

Use for baseboards, corners, and tight spaces.



Turbo nozzle

Use for furniture and stairs. Attach turbo nozzle to end of hose or wand.



Make sure vacuum is turned off and power cord is unplugged when connecting turbo nozzle.

How to clear a blockage

CAUTION

Make sure vacuum is turned off and power cord is unplugged.

If vacuum is not cleaning carpet, air path on vacuum back may be blocked.

- Lift latch and pull out dust cup (Fig. 1).
- To empty debris, press lever to release bottom lid (Fig. 2).

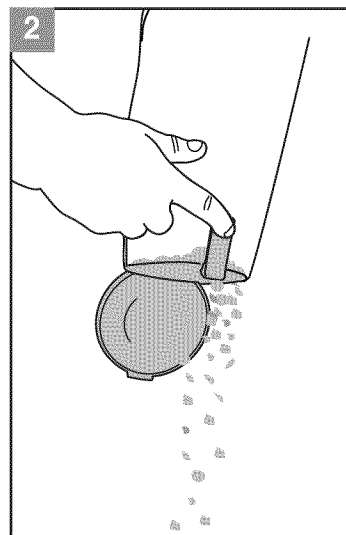
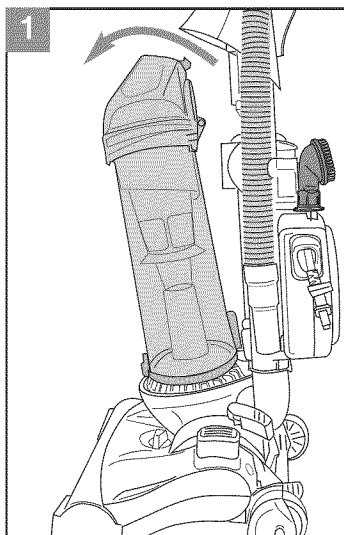

If no suction at end of hose, hose may be blocked.

- Remove dust cup.
- Turn air path knob to 'TOOLS.'
- Use finger to check for debris in air path (Fig. 3).
- If still clogged, twist hose counter-clockwise to remove hose from vacuum body (Fig. 4). Flex hose to loosen debris.

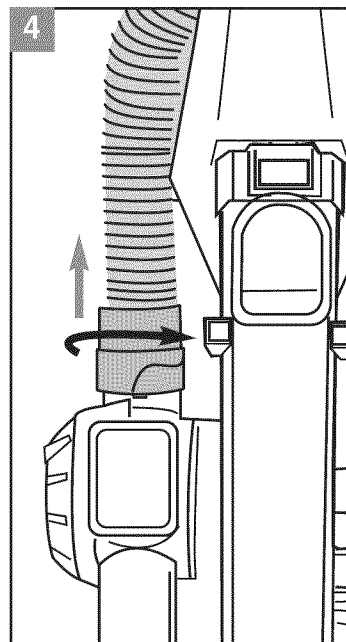
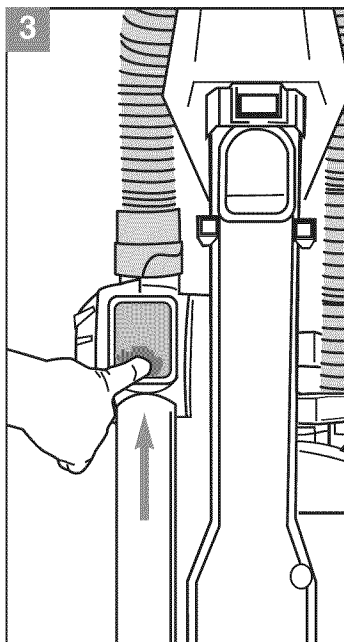
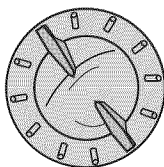

How to maintain turbo nozzle

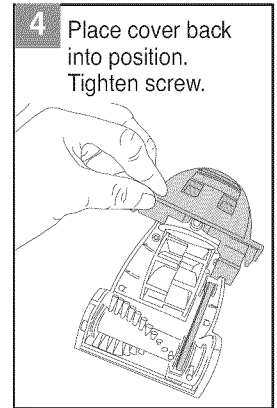
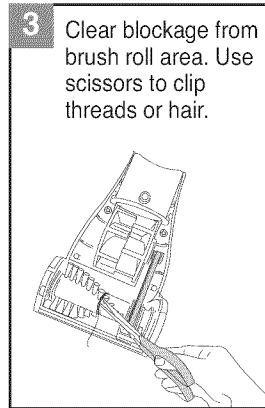
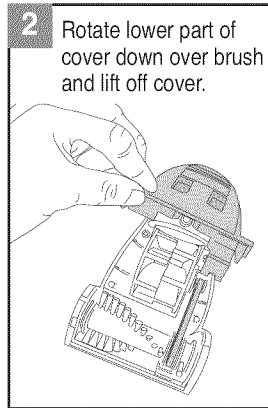
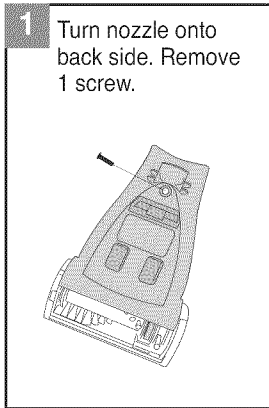

How to maintain brush roll

CAUTION

Make sure vacuum is turned off and power cord is unplugged.

How to clean brush roll

- Check brush roll periodically and remove debris.
- Step on handle release to lower handle (Fig. 1).
- Turn vacuum face down on floor.
- Use scissors to clip threads or hair (Fig. 2).

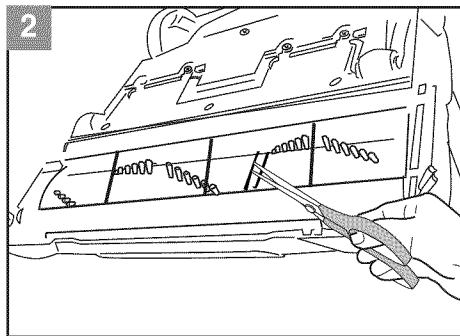
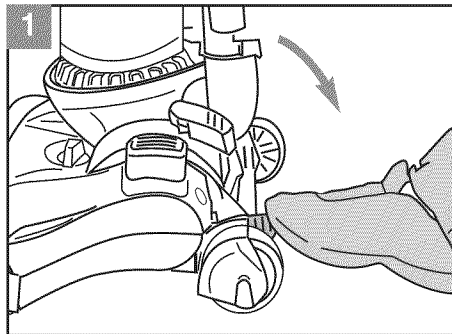

How to replace brush roll or belt

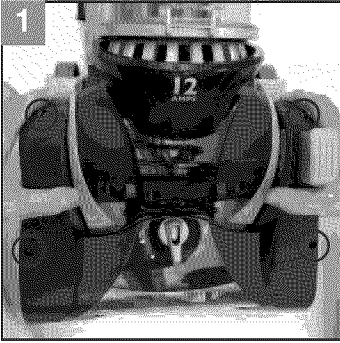

Remove 4 screws from brush roll cover. Lift off cover using rear tabs.

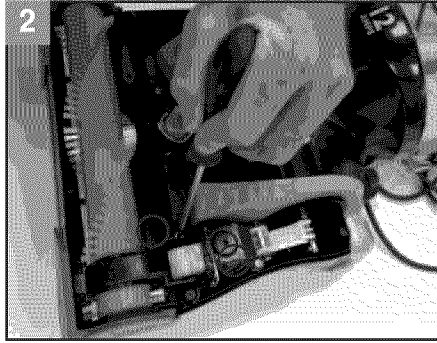

Use a Phillips screwdriver to remove 2 screws.

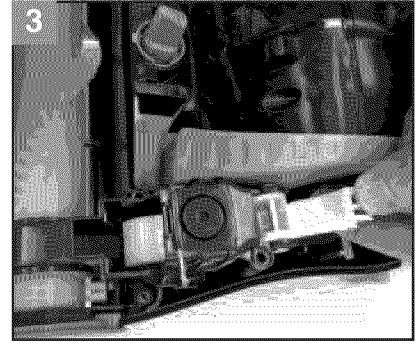

Pull up white latch to release the belt assembly and lift straight out.

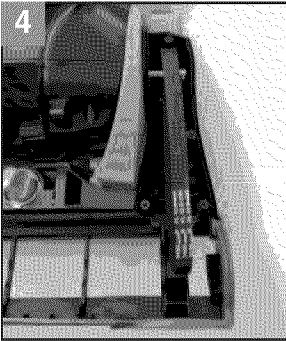

Remove belt from motor shaft and brush roll.

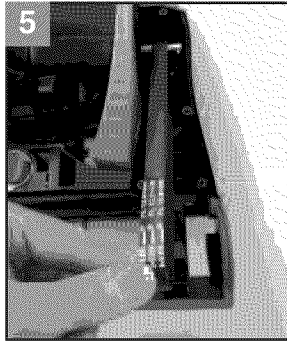

Replace belt around motor shaft.

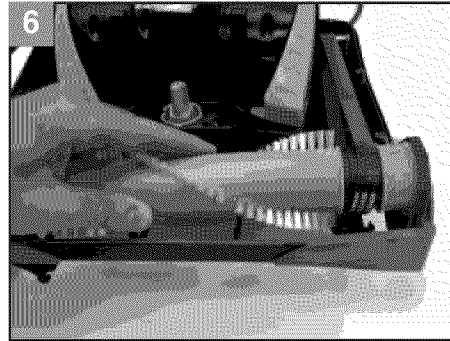

Insert left end of brush roll first. Loop new belt around right end of brush roll and insert right end cap into base.

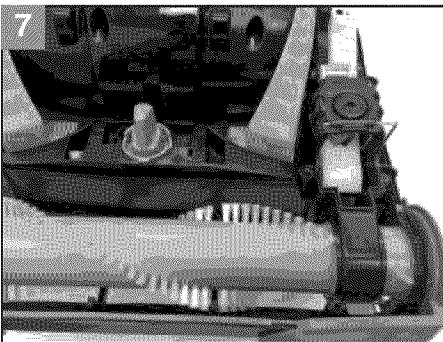

Replace the white latch assembly back into position.

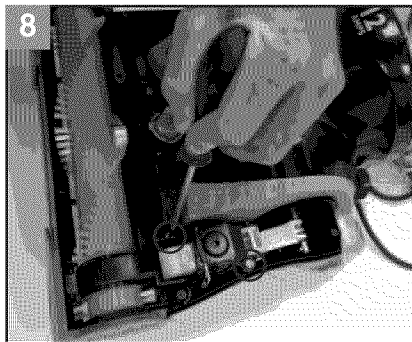

Reinstall 2 screws.

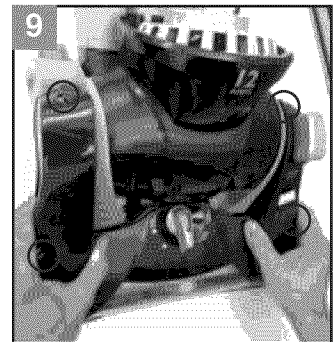

Replace brush roll cover and 4 screws.

Problem solving

 **Make sure vacuum is turned off and power cord is unplugged.**

NOTICE: Thermal cut-off

This vacuum cleaner has a special thermostat that protects the vacuum in case of motor overheating. **If the vacuum suddenly shuts off**, proceed as follows: 1) Push the power switch to off and unplug the vacuum. 2) Check the vacuum for a possible source of overheating such as a full dust cup, blocked hose or clogged filter. If these conditions are found, fix them and wait at least 30 minutes before attempting to use the vacuum. 3) After the **30 minute** period, plug the vacuum back in and turn on the switch. If the vacuum still does not work, call the Eureka customer service helpline.

Problem	Solution
Motor will not start.	<ul style="list-style-type: none"> • Push plug securely into outlet, try another outlet or check circuit breaker. • Step on power switch to turn vacuum on. • See detailed "thermal cut-off" instructions above.
Vacuum does not clean carpet or bare floor.	<ul style="list-style-type: none"> • Turn air path selector knob to 'FLOORS.' • Empty dust cup, clean and/or change filter. • Clean or replace filters regularly to maintain suction. • Check vacuum height knob position. • For carpet, be sure brush roll is on and lower handle into position for vacuuming. • For bare floors, step on pedal to turn off brush roll. Page 8.
No suction at the end of hose.	<ul style="list-style-type: none"> • Make sure air path selector knob is set to 'TOOLS.' • See other solutions above. • Remove clogs from the hose that restrict the airflow. Page 10.
Burning smell; brush roll will not turn.	<ul style="list-style-type: none"> • Check brush roll for debris. • Replace broken or out of shape belt. Page 12.
Cord will not rewind fully.	<ul style="list-style-type: none"> • Pull out entire cord removing any kinks, and push cord rewind button to rewind completely.
Turbo nozzle will not turn.	<ul style="list-style-type: none"> • Check turbo nozzle for debris. • Make sure air path selector knob is set to 'TOOLS.'
Vacuum is hard to push.	<ul style="list-style-type: none"> • Adjust vacuum height knob to a higher position.

The Eureka limited warranty

Eureka warrants this vacuum cleaner to be free from defects in material and workmanship for a term of three years for normal household use. Warranty is granted only to the original purchaser and members of immediate household.

This warranty is good for three years from the date of purchase only when the vacuum cleaner is used in the accordance with Eureka operating instructions. **Note:** refurbished or remanufactured products have a one year limited warranty.

This warranty does not cover

- Parts of the vacuum that require replacement under normal use such as disposable dust bags, filters, drive belts, light bulbs, brush roll, bristles, impellers and cleaning.
- Damages or malfunctions caused by negligence, abuse, and use not in accordance with the Owner's Guide.
- Defects or damages caused by unauthorized service or the use of other than Genuine Eureka, ARM & HAMMER™ and Filtrite™ by 3M parts.

What Eureka will do

Eureka will, at its option, repair or replace a defective vacuum or vacuum part that is covered by this warranty. As a matter of warranty policy, **Eureka will not refund the consumer's purchase price.**

Obtaining warranty service

To obtain warranty service you must return the vacuum or vacuum part along with "proof of purchase" to any Eureka Authorized Warranty Station. For Eureka Authorized Warranty Station or Service Information, visit www.eureka.com, write or telephone toll free:

USA: 1-800-282-2886
Electrolux Home Care
North America Service Division
P.O. Box 3900
Peoria, IL 61612

Mexico: (55) 5343-4384
Electrolux Home Care

Canada: 1-800-282-2886
Electrolux Home Care
North America Service Division
5855 Terry Fox Way
Mississauga, Ontario L5V 3E4

Obtaining warranty service outside your community

You must pay the shipping charges to the Eureka Authorized Warranty Station.

Return shipping charges will be paid by the Warranty Station. When returning parts for repair, please include the model, type and serial number located on the rating plate on the lower backside of the vacuum.

Further limitations and exclusions

Any warranty that may be implied in connection with your purchase or use of the vacuum, including any warranty of Merchantability or any warranty for Fitness For A Particular Purpose is limited to the duration of this warranty. Some states do not allow limitations on how long an implied warranty lasts, so the above limitations may not apply to you.

Your relief for the breach of this warranty is limited to the relief expressly provided above. In no event shall the manufacturer be liable for any consequential or incidental damages you may incur in connection with your purchase or use of the vacuum.

Some states do not allow the exclusion or limitation of incidental or consequential damages, so the above limitation or exclusion may not apply to you.

This warranty gives you specific legal rights. You may also have other rights, which may vary by state.









The ARM & HAMMER name is a trademark of Church and Dwight Co., Inc. 3M and Filtrite are trademarks of 3M Company, used by Electrolux Home Care Products, Inc. under license.



® ORDER GENUINE EUREKA ACCESSORIES AND REPLACEMENT PARTS
COMMANDE ACCESSOIRES ET PIÈCES DE RECHANGE D'ORIGINE EUREKA
PEDIDO ACCESORIOS Y REPUESTOS LEGÍTIMOS EUREKA

Visit / Visitez / Visite : www.eureka.com

By Phone / Au Téléphone / Por Teléfono : 1-800-282-2886

	DCF-25 Dust Cup Filter <i>DCF-25 Filtro del Recipiente para Polvo</i> <i>DCF-25 Filtre à Récipient À Poussière</i>	67600
	EF-7 Filter <i>Filtro EF-7</i> <i>Filtre EF-7</i>	091541
	W Belt <i>Courroie W</i> <i>Correa W</i>	Models with On/Off Brush Roll Pedal <i>Modelos con interruptor de Encendido / Apagado del cepillo circular</i> <i>Modèles avec interrupteur Marche / Arrêt du rouleau de brosse</i> 86389
	Combination Brush <i>Brosse Combinaison</i> <i>Cepillo Combinado</i>	090221
	Crevice Tool <i>Outil de Coin</i> <i>Accesorio para Rincones</i>	090230
	Extension Wand <i>Tube de Rallonge</i> <i>Tubo de Extensión</i>	090199
	Turbo Nozzle <i>Turbo-Brosse</i> <i>Boquilla Turbo</i>	81295
	Pet Turbo Nozzle <i>Turbo-Brosse Pour Animaux</i> <i>Boquilla Turbo Para Mascotas</i>	84148