

# FRIGIDAIRE

All about the

# Use & Care

of your Electric Range

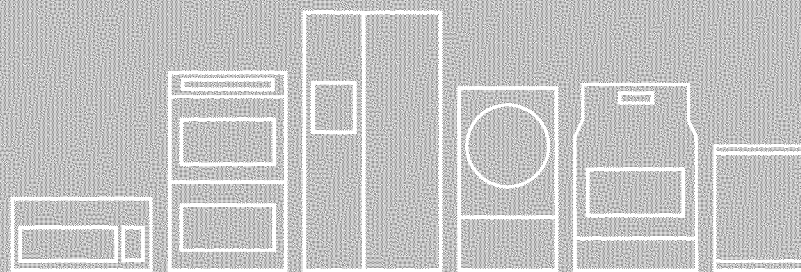

## TABLE OF CONTENTS

Product Record and Registration . . . . .	2	Setting Oven Controls . . . . .	16
Important Safety Instructions . . . . .	3	Care and Cleaning . . . . .	31
Before Setting Surface Controls . . . . .	8	Before You Call . . . . .	37
Setting Surface Controls . . . . .	11	Warranty . . . . .	40
Before Setting Oven Controls . . . . .	14		

# PRODUCT RECORD AND REGISTRATION

Product Record and Registration . . . . .	2
Important Safety Instructions . . . . .	3
Before Setting Surface Controls . . . . .	8
Setting Surface Controls . . . . .	11
Before Setting Oven Controls . . . . .	14
Setting Oven Controls . . . . .	16
Care and Cleaning . . . . .	31
Before You Call . . . . .	37
Warranty . . . . .	40

## Need Help?

Visit the Frigidaire web site at [www.frigidaire.com](http://www.frigidaire.com)

Before you call for service, there are a few things you can do to help us serve you better.

## Read this Use & Care Manual

This manual contains instructions to help you use and maintain your oven properly.

## If You Received a Damaged Oven...

Immediately contact the dealer (or builder) that sold you the oven.

## Save Time and Money

Check "Solutions to Common Problems:" on page 38. This section helps step you through some common problems that might occur.

If you do need service, help is only a phone call away. Call Frigidaire customer services at **1-800-944-9044**.

## Product Registration

Registering your product with Frigidaire enhances our ability to serve you. You can register online at <http://www.frigidaire.com> or by dropping your product registration card in the mail.

## Record model and serial numbers here

Purchase Date: \_\_\_\_\_

Frigidaire model number: \_\_\_\_\_

Frigidaire serial number: \_\_\_\_\_

## Serial Plate Location

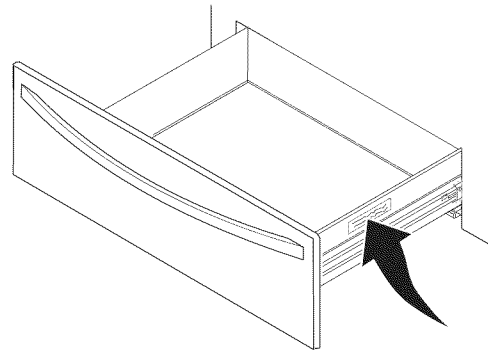

## Questions?

For toll-free telephone support in the U.S. and Canada call **1-800-944-9044**

For online support and product information go online to: [www.frigidaire.com](http://www.frigidaire.com).

## Thank you for choosing Frigidaire

This Use & Care manual is part of our commitment to customer satisfaction and product quality throughout the service life of your new appliance. We view your purchase as the beginning of a relationship. To ensure our ability to continue serving you, please use this page to record important product information.

# IMPORTANT SAFETY INSTRUCTIONS

## CAUTIONS AND WARNINGS

Read all instructions before using this appliance.

This manual contains important safety symbols and instructions. Please pay attention to these symbols and follow all instructions given.

Do not attempt to install or operate your appliance until you have read the safety precautions in this manual. Safety items throughout this manual are labeled with a WARNING or CAUTION statement based on the risk type.

## DEFINITIONS

 This is the safety alert symbol. It is used to alert you to potential personal injury hazards. Obey all safety messages that follow this symbol to avoid possible injury or death.

### WARNING

Indicates a potentially hazardous situation which, if not avoided, may result in death or serious injury.

### CAUTION

Indicates a potentially hazardous situation which, if not avoided, may result in minor or moderate injury.

### IMPORTANT

Indicates installation, operation, maintenance, or valuable information that is not hazard related.

### NOTE

Indicates a short, informal reference-something written down to assist the memory or for future reference.

### WARNING

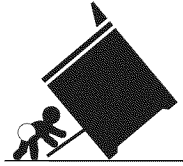

#### Tip Over Hazard

- A child or adult can tip the range and be killed.
- Verify the bracket is engaged with countertop or that the anti-tip device has been

installed to the walls of the cabinet, the wall, or the floor as per the installation instructions.

- Ensure the anti-tip device is re-engaged with the countertop, the walls of the cabinet, the wall, or the floor as per the installation instructions when the range is moved.
- Do not operate the range without the anti-tip device in place and engaged.
- Failure to follow these instructions can result in death or serious burns to children and adults.



To check if the anti-tip bracket is installed properly, use both arms and grasp the rear edge of range back. Carefully attempt to tilt range forward. When properly installed, the range should not tilt forward.

Refer to the anti-tip bracket installation instructions supplied with your range for proper installation.

### NOTE

Save these instructions for future use.

## IMPORTANT SAFETY INSTRUCTIONS

### WARNING

- Do not leave children alone - Children should not be left alone or unattended in the area where appliance is in use. They should never be allowed to sit or stand on any part of the appliance, including the storage drawer, lower broiler drawer, warmer drawer, or lower double oven.
- Stepping, leaning, or sitting on the door or drawers of this appliance can result in serious injuries and also cause damage to the appliance. Do not allow children to climb or play around the appliance. The weight of a child on an open oven door may cause the appliance to tip, resulting in serious burns or other injury. An open drawer when hot may cause burns.
- Never cover any slots, holes, or passages in the oven bottom or cover an entire oven rack with any oven liners or materials, such as aluminum foil. Aluminum foil linings may trap heat, causing a fire hazard.

### WARNING

Do not use oven or warmer drawer (if equipped) for storage. Never use your appliance as a space heater to heat or warm the room.

### WARNING

**Storage In or On Appliance—**Flammable materials should not be stored in an oven, near surface burners, or in the storage drawer or warmer drawer (if equipped). This includes paper, plastic, and cloth items, such as cookbooks, plastic ware, and towels, as well as flammable liquids. Do not store explosives, such as aerosol cans, on or near the range.

### IMPORTANT

Read and follow the below instructions and precautions for unpacking, installing, and servicing your appliance:

- Remove all tape and packaging before using the appliance. Destroy the carton and plastic bags after unpacking the appliance. Never allow children to play with packaging material. Do not remove the wiring label and other literature attached to the range. Do not remove model/serial number plate.
- Proper Installation—Be sure your appliance is properly installed and grounded by a qualified technician in accordance with the National Electrical Code ANSI/NFPA No. 70 latest edition and local electrical code requirements. In Canada, install in accordance with CSA Standard C22.1, Canadian Electrical code, Part 1-latest edition, and local electrical code requirements. Install only per installation instructions provided in the literature package for this range.
- User Servicing—Do not repair or replace any part of the appliance unless specifically recommended in the manuals. All other servicing should be done only by a qualified technician. This reduces the risk of personal injury and damage to the oven.
- Ask your dealer to recommend a qualified technician and an authorized repair service. Know how to disconnect the power to the appliance at the circuit breaker or fuse box in case of an emergency.
- Never modify or alter the construction of an oven by removing the leveling legs, panels, wire covers, anti-tip brackets/screws, or any other part of the oven.
- Remove the oven door from any unused oven if it is to be stored or discarded.
- Be sure to have an appropriate foam-type fire extinguisher available, visible, and easily accessible located near the appliance.

## IMPORTANT SAFETY INSTRUCTIONS

### IMPORTANT INSTRUCTIONS FOR USING YOUR COOKTOP

- Know which knob or key controls each surface heating area. Place cookware with food on the cooking area before turning it on. Turn the cooking area off before removing the cookware.
- Use proper pan size. This appliance is equipped with one or more surface units of different sizes. Select cookware with flat bottoms that match the surface unit heating element. The use of undersized cookware may expose a portion of the heating element to direct contact and may result in the ignition of clothing or other items. Using the proper cookware on the cooking zone will improve efficiency.
- To reduce the risk of burns, ignition of flammable materials, and spills due to unintentional contact with the utensil, the utensil handles should be turned inward and not extend over other cooking areas.
- Never leave surface elements unattended. Boil-overs may cause smoking and greasy spills may ignite. A pan that has boiled dry could be damaged and may damage the cooktop.
- Improper cookware may break due to sudden changes in temperature. Check the cookware manufacturer's recommendations for cooktop use.
- When you are flaming foods under a ventilating hood, turn on the fan.
- Glazed cooking utensils—Only certain types of glass, glass/ceramic, ceramic, earthenware, or other glazed utensils are suitable for cooktop service without breaking due to the sudden change in temperature. Check the manufacturer's recommendations for cooktop use.

- Do not use decorative surface burner covers. If an element is accidentally turned on, the decorative cover will become hot and possibly melt. Burns will occur if the hot covers are touched. Damage may also be done to the cooktop.
- Do not use searing grill on the cooktop. The searing grill is not designed for use on the cooktop. Doing so may result in a fire.

### IMPORTANT

Important Safety Notice - The California Safe Drinking Water and Toxic Enforcement Act requires the governor of California to publish a list of substances known to cause cancer, birth defects, or other reproductive harms, and requires businesses to warn customers of potential exposures to such substances.

Cold temperatures can damage the electronic control. When using this appliance for the first time, or when the appliance has not been used for an extended period of time, be sure the appliance has been in temperatures above 32°F (0°C) for at least 3 hours before turning on the power to the appliance.

Do not attempt to operate the appliance during a power failure. If the power fails, always turn off the unit. If the unit is not turned off and the power resumes, the appliance will not operate. Once the power resumes, reset the clock and the oven function.

## IMPORTANT SAFETY INSTRUCTIONS

### CAUTION

- When heating fat or grease, watch it closely. Grease may catch fire if it becomes too hot.
- Do not use water or flour on grease fires. Smother fire or flame or use a dry chemical or foam-type extinguisher. Cover the fire with a pan lid or use baking soda.
- Use dry potholders. Moist or damp potholders on hot surfaces may result in burns from steam. Do not let potholders touch hot cooking areas. Do not use towels or other bulky cloths.
- Do not heat unopened food containers. Build-up of pressure may cause container to burst and result in injury.
- Wear proper apparel. Loose-fitting or hanging garments should never be worn while using the appliance.
- Do not touch heating elements or interior surfaces of oven. Heating elements may be hot even though they are dark in color. Interior surfaces of an oven become hot enough to cause burns.
- During and after use, do not touch, or let clothing or other flammable materials contact heating elements or interior surfaces of oven until they have had sufficient time to cool. Other surfaces of the appliance may become hot enough to cause burns - among these surfaces are for example, oven vent openings and surfaces near these openings, oven doors, and windows of oven doors.

### IMPORTANT INSTRUCTIONS FOR USING YOUR OVEN

- Use care when opening oven door, lower oven door, or warmer drawer (some models). Stand to the side of the appliance when opening the door of a hot range. Let hot air or steam escape before you remove or replace food in the oven.
- Keep oven vent ducts unobstructed. Touching surfaces in this area when the oven is on may cause severe burns. Do not place plastic or heat-sensitive items on or near the oven vent. These items can melt or ignite.
- Placement of oven racks - Always place oven racks in desired location while oven is cool. If rack must be moved while oven is hot, do not let potholder contact hot heating element in oven. Use potholders and grasp the rack with both hands to reposition. Remove all cookware and utensils before moving the rack.
- Do not use a broiler pan without its insert. Broiler pans and inserts allow dripping fat to drain away from the high heat of the broiler. Do not cover the broiler insert with aluminum foil or any other materials; exposed fat and grease could ignite.
- Protective liners—Do not use aluminum foil or any other oven liners or materials to line oven bottom or any other part of the appliance. Only use aluminum as recommended for baking if used as a cover placed on the food. Any other use of protective liners or aluminum foil may result in a risk of electric shock or fire or a short circuit.
- Do not cook food on the oven bottom. Always cook in proper cookware and always use the oven racks.

## IMPORTANT SAFETY INSTRUCTIONS

### IMPORTANT INSTRUCTIONS FOR CLEANING YOUR OVEN

#### CAUTION

Before manually cleaning any part of the appliance, be sure all controls are turned off and the range is cool. Cleaning a hot oven can cause burns.

- Clean the range regularly to keep all parts free of grease that could catch fire. Pay particular attention to the area around each surface element. Do not allow grease to accumulate. Greasy deposits in the fan could catch fire. Follow the manufacturer's instructions for cleaning hoods.
- Always follow the manufacturer's recommended directions for use of kitchen cleaners and aerosols. Be aware that excess residue from cleaners and aerosols may ignite causing damage and injury.
- Clean ventilating hoods frequently. Grease should not be allowed to accumulate on the hood or filter.
- Do not touch a hot oven light bulb with a damp cloth. Doing so could cause the bulb to break. Disconnect the appliance or shut off the power to the appliance before removing and replacing the bulb.

### FOR GLASS COOKTOP ONLY

- Do not clean or operate a broken cooktop. If cooktop should break, cleaning solutions and spillovers may penetrate the broken cooktop and create a risk of electric shock. Contact a qualified technician immediately.
- Clean cooktop glass with caution. If a wet sponge or cloth is used to wipe spills on a hot cooking area, be careful to avoid a steam burn. Some cleaners can produce harmful fumes if applied to a hot surface.
- Avoid scratching the cooktop glass with sharp objects.

### SELF CLEANING OVENS

- Clean only the parts listed in this manual. Before using clean, remove the broiler pan, any food, utensils, and cookware from the oven.
- Do not use oven cleaners. No commercial oven cleaner or oven liner protective coating of any kind should be used in or around any part of the appliance.
- Do not clean the oven door gasket. The door gasket is essential for a good seal. Care should be taken not to rub, damage, or move the gasket.
- Some birds are extremely sensitive to the fumes given off during the clean cycle of any oven. Move birds to another well-ventilated room.
- Remove oven racks. If left in the oven during a clean cycle the oven racks color will change.

### GROUNDING INSTRUCTIONS

#### WARNING

Avoid fire hazard or electrical shock. Failure to follow this warning may cause serious injury, fire, or death.

For personal safety, this appliance must be properly grounded. For maximum safety, the power cord must be plugged into an electrical outlet that is the correct voltage, is correctly polarized and properly grounded in accordance with local codes.

It is the personal responsibility of the consumer to have the appropriate outlet with the correct, properly grounded wall receptacle installed by a qualified electrician. It is the responsibility and obligation of the consumer to contact a qualified installer to assure that the electrical installation is adequate and is in conformance with all local codes and ordinances.

See the installation instructions packaged with this appliance for complete installation and grounding instructions.

# BEFORE SETTING SURFACE CONTROLS

## Using Proper Cookware

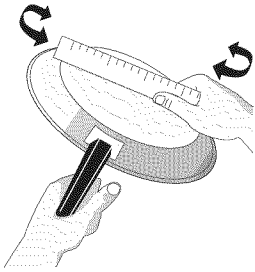

The size and type of cookware used will influence the radiant element power level setting needed for best cooking results. Be sure to follow the recommendations for using proper cookware as illustrated in Figure 1 and Figure 2.

**Figure 1: Testing cookware**

Check for flatness by rotating a ruler across the bottom of the cookware (See Figure 1). Cookware should have flat bottoms that make good contact with the entire surface heating element (See Figure 2). For detailed information about the ceramic cooktop, refer to the "Cooktop Maintenance (cont'd)" on page 33.

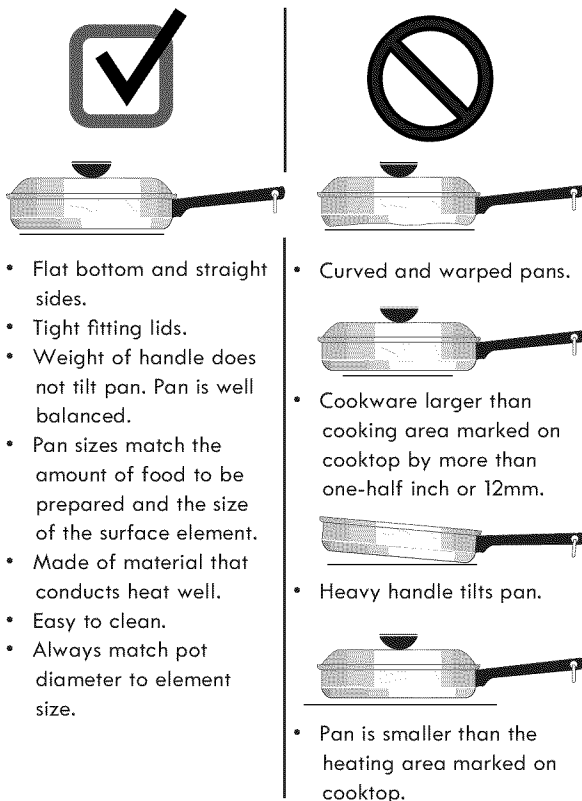

- Flat bottom and straight sides.
  - Tight fitting lids.
  - Weight of handle does not tilt pan. Pan is well balanced.
  - Pan sizes match the amount of food to be prepared and the size of the surface element.
  - Made of material that conducts heat well.
  - Easy to clean.
  - Always match pot diameter to element size.
- Curved and warped pans.
  - Cookware larger than cooking area marked on cooktop by more than one-half inch or 12mm.
  - Heavy handle tilts pan.
  - Pan is smaller than the heating area marked on cooktop.

**Figure 2: Proper cookware**

## Cookware Material Types

The cookware material determines how evenly and quickly heat is transferred from the surface element to the pan bottom. The most popular materials available are:

- Aluminum - Excellent heat conductor. Some types of food will cause it to darken (Anodized aluminum cookware resists staining and pitting). If aluminum pans slide across the ceramic cooktop, they may leave metal marks which will resemble scratches. Remove these marks immediately.
- Copper - Excellent heat conductor but discolors easily (See Aluminum).
- Stainless - Slow heat conductor with uneven cooking results. Is durable, easy to clean and resists staining.
- Cast Iron - A slow heat conductor however will retain heat very well. Cooks evenly once cooking temperature is reached. Not recommended for use on ceramic cooktops.
- Porcelain-enamel on metal - Heating characteristics will vary depending on base material. Porcelain-enamel coating must be smooth to avoid scratching ceramic cooktops.
- Glass - Slow heat conductor. Not recommended for ceramic cooktop surfaces because it may scratch the glass.

### ▶ IMPORTANT

Do not place empty aluminum, glass or porcelain-enamel coated cookware on the ceramic cooktop! The melting point of cookware made with these materials may be reached quickly especially if left empty, and they may bond to the ceramic cooktop. If the cookware melts it will damage the cooktop. Be sure to follow all the cookware manufacturer's suggestions when using any type of cookware on the ceramic cooktop.

### ↳ NOTE

(White glass cooktops only). Due to the high intensity of heat generated by the surface elements, the glass surface will turn green when the element is turned off. This phenomenon is normal and the glass will return to its original white color after it has completely cooled down.



## BEFORE SETTING SURFACE CONTROLS

### About the Ceramic Glass Cooktop

The ceramic cooktop has radiant surface elements located below the surface of the glass. The design of the ceramic cooktop outlines the area of the surface element underneath. Be sure to match the pan size with the diameter of the element outline on the cooktop and only flat-bottomed cookware should be used.

The type and size of cookware, the number of surface elements in use and their settings are all factors that will affect the amount of heat that will spread to areas beyond the surface elements. The areas surrounding the elements may become hot enough to cause burns.

### IMPORTANT

The cooktop should not be used as a cutting board or work surface. Dropping heavy or hard objects on the cooktop may crack it.

Pans with rough bottoms may scratch the cooktop surface. Placing food directly on the smoothtop surface (without cooking utensil) is not recommended as difficult cleaning will result and foods may smoke and cause potential fire hazard.

Always lift cookware before moving on ceramic glass cooktop. Any cookware that has rough or dirty bottoms can scratch the ceramic cooktop. Always start with clean cookware.

### About the Radiant Surface Elements

The element temperature rises gradually and evenly. As the temperature rises, the element will glow red. To maintain the selected setting the element will cycle on and off. The heating element retains enough heat to provide a uniform and consistent heat during the off cycle.

For efficient cooking, turn off the element several minutes before cooking is complete. This will allow residual heat to complete the cooking process.

### CAUTION

Do not allow aluminum foil, or any material that can melt, to make contact with the ceramic glass cooktop. If these items melt on the cooktop, they will damage the ceramic cooktop.

### NOTE

- Radiant elements have a limiter that allows the element to cycle on and off, even at the HI setting. This helps to prevent damage to the ceramic smooth top. Cycling at the HI setting is normal and can occur if the cookware is too small for the radiant element or if the cookware bottom is not flat.
- Be sure to read detailed instructions for ceramic glass cooktop cleaning in the General Care & Cleaning section and Before You Call checklist section of this Use and Care Guide.
- The element on and hot surface indicator lights will glow when the element is turned on and will continue to glow after the control knob is turned to the OFF position. It will glow until the heating surface area has cooled sufficiently. The glass surface may still be hot and burns may occur if the glass surface is touched before the indicator light has turned off.

## BEFORE SETTING SURFACE CONTROLS

### Element On and Hot Surface Indicator Lights

When a burner is turned on the ELEMENT ON indicator light will glow. The HOT SURFACE indicator light will turn on when the burner is hot enough to cause burns and will remain on until the surface has cooled to a safe temperature after the burner is turned off. The ELEMENT ON indicator light will glow when one or more elements are turned on. A quick glance at these indicator lights when cooking is finished is an easy check to be sure all surface elements are turned off.

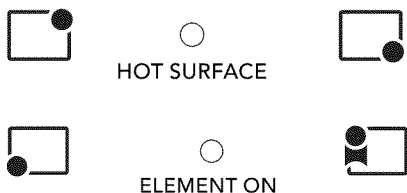

### Home Canning

#### CAUTION

Canning can generate large amounts of steam. Use extreme caution to prevent burns. Always raise the lid to vent steam away from you. Safe canning requires that harmful micro-organisms are destroyed and the jars are sealed completely. When canning in a water bath canner, a gentle but steady boil must be maintained continuously for the required time.

Be sure to read and observe all the following points when home canning with your appliance. Check with the USDA (United States Department of Agriculture) Web site and be sure to read all the information they have available as well as follow their recommendations for home canning procedures.

### Home Canning Do's and Don'ts

- Use only quality flat bottom canners when home canning.
- Use a straight-edge to check canner bottom.
- Use only a completely flat bottom canner with no ridges that radiate from the bottom center when home canning. Heat is spread more evenly when the bottom surface is flat.
- Make sure the diameter of the canner does not exceed 1 inch beyond the surface element markings or burner.
- It is recommended to use smaller diameter canners on electric coil and ceramic glass cooktops and to center canners on the burner grates.
- Start with hot tap water to bring water to boil more quickly.
- Use the highest heat setting when first bringing the water to a boil. Once boiling is achieved, reduce heat to lowest possible setting to maintain that boil.
- Use tested recipes and follow instructions carefully. Check with your local Cooperative Agricultural Extension Service or a manufacturer of glass jars for the latest canning information.
- It is best to can small amounts and light loads.
- Do not leave water bath or pressure canners on high heat for an extended amount of time.
- Alternate surface units between each batch to allow the units and surrounding surfaces to cool down. Try to avoid canning on the same burner unit all day.

## SETTING SURFACE CONTROLS

### Surface Control Settings

The size and type of utensil used, and the amount and type of food being cooked will influence the surface element power level setting needed for best cooking results.

Use Table 1 to determine the correct setting for the type of food you are preparing.

### NOTE

The size and type of cookware used will influence the setting needed for best cooking results.

**Table 1: Recommended settings for surface elements**

Setting	Type of Cooking
HIGH (HI)	Start most foods; bring water to a boil and pan broiling.
MEDIUM HIGH (8-10)	Continue a rapid boil; frying, deep fat frying
MEDIUM (6)	Maintain a slow boil; thicken sauces and gravies; steaming vegetables
MEDIUM LOW (2-4)	Keep foods cooking; poaching and stewing
LOW (LO)	Keep warm, melting and simmering

### IMPORTANT

Start most cooking operations on a higher setting and then turn to a lower setting to finish cooking. A glowing red surface heating area extending beyond the bottom edge of the cookware indicates the cookware is too small for the surface heating area. Never straddle cookware between two surfaces unless designed for that purpose.

### CAUTION

Do not place plastic items such as salt and pepper shakers, spoon holders or plastic wrappings on top of the range when it is in use. These items could melt or ignite. Potholders, towels or wooden spoons could catch fire if placed too close to the surface elements.

Do not allow aluminum foil, empty glass/porcelain cookware or any material that can melt to make contact with the ceramic cooktop. If these items melt on the cooktop they may damage the ceramic cooktop.

### CAUTION

Radiant surface elements may appear to have cooled after they have been turned off. The hot surface light will turn on and will continue to glow until the glass cooktop has cooled down to a moderate level. The glass surface may still be hot and burns may occur if the glass surface is touched before the indicator light has turned off.

### Single Radiant Surface Elements (some models)

The cooktop has two or three single radiant surface elements: the left rear position, the right rear position. The left rear element may also be used with the bridge element.

#### To operate the single radiant surface elements:

1. Place correctly sized cookware on the radiant surface element.
2. Push in and turn the surface control knob in either direction to the desired setting (See Figure 3). Start most cooking operations on a higher setting and then turn to a lower setting to finish cooking. Each surface element provides a constant amount of heat at each setting. A glowing red surface heating area extending beyond the bottom edge of the cookware indicates the cookware is too small for the surface heating area.
3. When cooking has completed, turn the surface control knob to **OFF** before removing the cookware.

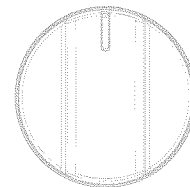

**Figure 3: Control knob single surface burner**

### NOTE

The surface control knobs do not have to be set exactly on a particular spot. Use the graphics provided as a guide and adjust the control knob as needed. Each surface element provides a constant amount of heat at each setting. Refer to Table 1 for suggested settings.

## SETTING SURFACE CONTROLS

### Dual Surface Radiant Element (some models)

The expandable burner can handle 9 inch or 12 inch cookware. This dual burner is especially useful for bringing large cookware to boil for canning or heating large amounts of water.

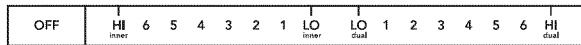
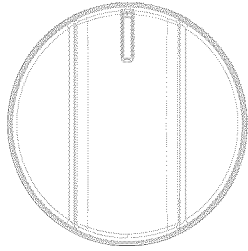

**Figure 4: Dual element control for 9 or 12 inch burner**

#### To operate the dual surface element:

1. Place correctly sized cookware on the dual surface element.
2. Push in and turn the control knob toward the inner element side for smaller cookware or to the dual element side for larger cookware (See Figure 4).
3. Turn the knob to adjust the setting as needed. Start most cooking operations on a higher setting and then turn to a lower setting to finish cooking. Each surface element provides a constant amount of heat at each setting. A glowing red surface heating area extending beyond the bottom edge of the cookware indicates the cookware is too small for the surface heating area.
4. When cooking has completed, turn the surface control knob to **OFF** before removing the cookware.

### **CAUTION**

Do not straddle cookware between two cooking surfaces unless the designed for that specific purpose (griddles)

### Warmer Zone

#### **CAUTION**

The warmer zone will not glow red when it is hot, but becomes hot enough to cause burns. Avoid placing hands on or near the warmer zone until the hot surface indicator light is off. Always use potholders or oven mitts when removing food from the warmer zone as cookware and plates will be hot.

The purpose of the warmer zone is to keep hot cooked foods at serving temperature. Use the feature to keep cooked foods hot such as: vegetables, gravies, casseroles, soups, stews, breads, pastries and oven-safe dinner plates. Always start with hot food. Do not heat cold food on the warmer zone. All food placed on the warmer zone should be covered with a lid to maintain quality. For best results, when warming pastries or breads, the cover should have an opening to allow moisture to escape. Do not use plastic wrap to cover food. Plastic may melt onto the surface and be very difficult to clean. Use only plates, utensils and cookware recommended for oven and cooktop use on the warmer zone.

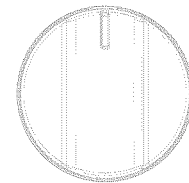

**Figure 5: Warmer zone control knob**

#### To set the keep warmer zone control:

1. Turn the warmer zone control knob clockwise to the ON position. The warmer zone uses a pre-set temperature designed to keep foods at serving temperature.
2. When ready to serve, turn the warmer zone control knob to the off position. The warmer zone will remain hot until the hot surface indicator light turns off.

#### **WARNING**

Food Poisoning Hazard. Do not let food sit for more than one hour before or after cooking. Doing so can result in food poisoning or sickness.

## SETTING SURFACE CONTROLS

### Bridge Element

On the left side of the cooktop there are two single burners with a bridge element between them. When turned on, the bridge element allows for a larger cooking area by cycling at the same temperature as the left front element. For the bridge to be operational, the left front burner must be on. When the left rear burner is also on the entire left side of the cooktop can accommodate specialized cookware.

#### CAUTION

Use only cookware specifically designed for use with the bridge element.

The bridge is located on the left side of the cooktop and must be activated in two steps.



#### To operate the bridge element:

1. Turn on the front and rear controls to the desired level of heat.
2. Turn the bridge control to the **ON** position.

**Note:** The bridge element will heat at the same level as the front element. If either the front control or rear control is turned off, the bridge will also turn off.

3. Be sure to turn the bridge control to the off position when finished cooking.

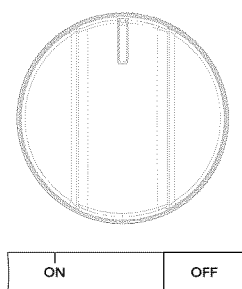

Figure 6: Bridge element control

#### CAUTION

Radiant surface elements may appear to have cooled after they have been turned off. The hot surface indicator light will turn on and will continue to glow until the glass cooktop has cooled down to a moderate level. The glass surface may still be hot and burns may occur if the glass surface is touched before the indicator light has turned off. The message may remain on even though the controls are turned off.

## BEFORE SETTING OVEN CONTROLS

### Oven Vent Location

The oven is vented as shown below. When the oven is on, warm air is released through the vent. This venting is necessary for proper air circulation in the oven and good baking results. Do not block oven vent. Never close off the openings with aluminium foil or any other material. Steam or moisture may appear near the oven vent. This is normal.

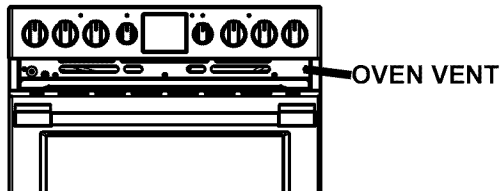
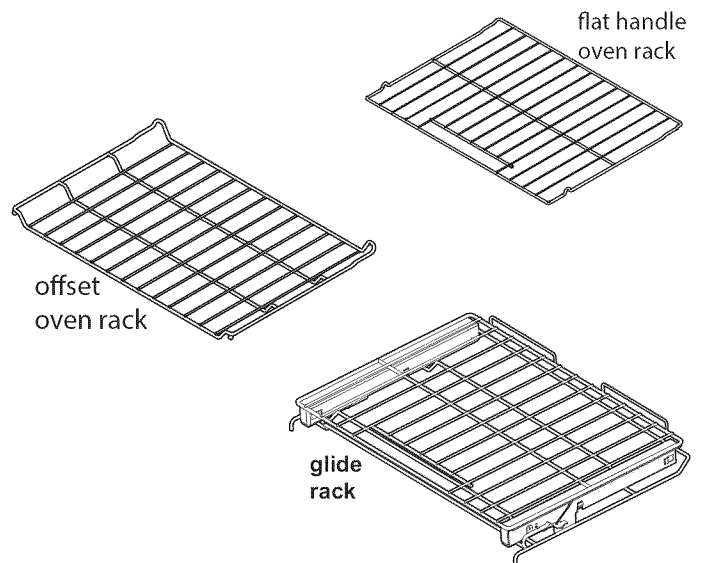

Figure 7: Do not block oven vent

### Type of oven racks



### CAUTION

Always use pot holders or oven mitts when using the oven. When cooking, the oven interior and exterior, oven racks, and cooktop will become very hot which can cause burns.

### WARNING

Protective Liners — Do not use aluminum foil or any other material to line the oven bottom. Only use aluminum foil as recommended in this manual. Improper installation of these liners may result in risk of electric shock or fire.

### IMPORTANT

All oven racks should be removed before a clean operation. Racks left in the oven during the high heat of the clean function can easily discolor. The ability of the racks to easily slide in and out along the rack positions may also be affected. Remove all oven racks and clean according to instructions provided in the Care & Cleaning section of this manual. Never pick up hot oven racks or parts.

### Oven Rack Descriptions

- **Flat oven racks** (or the **flat handle oven rack**) may be used for most cooking needs and may be placed in most oven rack positions.
- The **offset oven rack** (some models) provides additional step down positions from the standard flat rack design. The offset design positions the base of the rack about  $\frac{1}{2}$  of a rack position lower than the flat rack and may be used in most oven rack positions.
- The fully extendable oven **glide rack** allows you to effortlessly extend your food away from the oven.

### Removing, replacing, and arranging flat or offset oven racks

**To arrange** - Always arrange the oven racks when the oven is cool (prior to operating the oven).

**To remove** - Pull the oven rack straight forward until it reaches the stop position. Lift up front of oven rack slightly and slide out.

**To replace** - Place the oven rack on the rack guides on both sides of oven walls. Tilt the front of oven rack upward slightly and slide the oven rack back into place. Be sure oven racks are level before using.

## BEFORE SETTING OVEN CONTROLS

### Removing and Replacing the Glide Racks

The fully extendable Glide rack makes food preparation easier. This oven rack has glide tracks that allow the rack to be pulled away from the oven without rubbing the sides of the oven wall.

**To remove** - Using one hand, reach through handle opening and lift up on the release lever located across the lower front of the rack as shown in Figure 8.

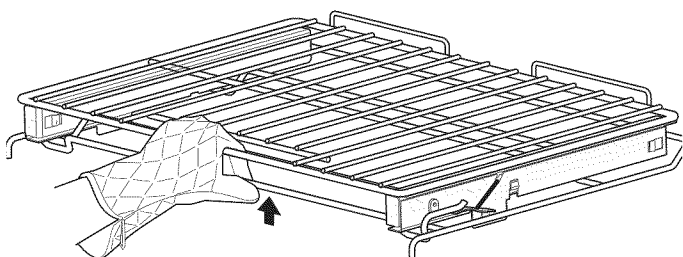

**Figure 8: Grasp handle and lift up on bar**

While holding up the release lever, pull the glide rack out of the oven until the stop position is reached (Figure 9)

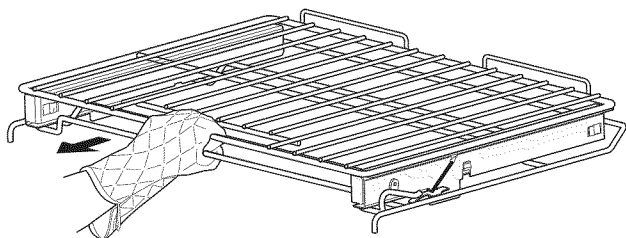

**Figure 9: Pull rack to stop position**

Using both hands, grasp the upper and lower portions of the glide rack. Lift up the front of the rack slightly and continue to pull the rack away from the oven (Figure 10). Be sure to grasp both upper and lower rack portions together when removing or handling the glide rack.

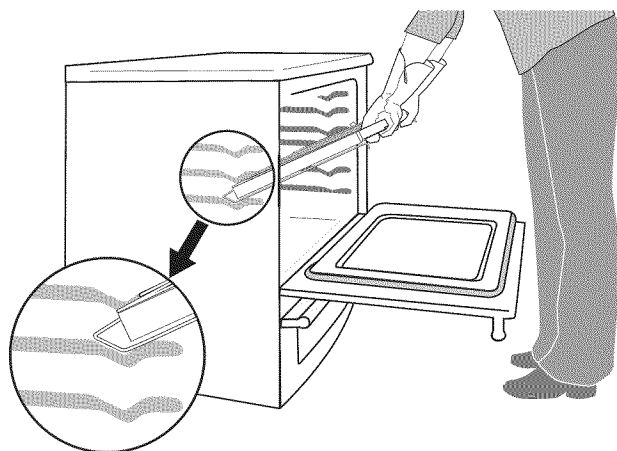

**Figure 10: Remove and replace using both hands**

The rack portions move independently and are difficult to handle unless held together.

**To replace** - grasp both upper and lower portions of glide rack, lift and hold the rack level between the oven cavity walls. Tilt the front of the rack upward slightly and slide the rack completely into position.

**Important:** To prevent possible damage to the oven, do not attempt to close the oven door until all the oven racks are fully positioned back inside the oven cavity.

### ➔ IMPORTANT

Do not line the oven walls, racks, bottom or any other parts of the range with aluminum foil or with any other materials or oven liners. Doing so will alter heat distribution and may cause permanent damage to the oven interior. During clean the oven temperatures will be hot enough to melt foil.

# SETTING OVEN CONTROLS

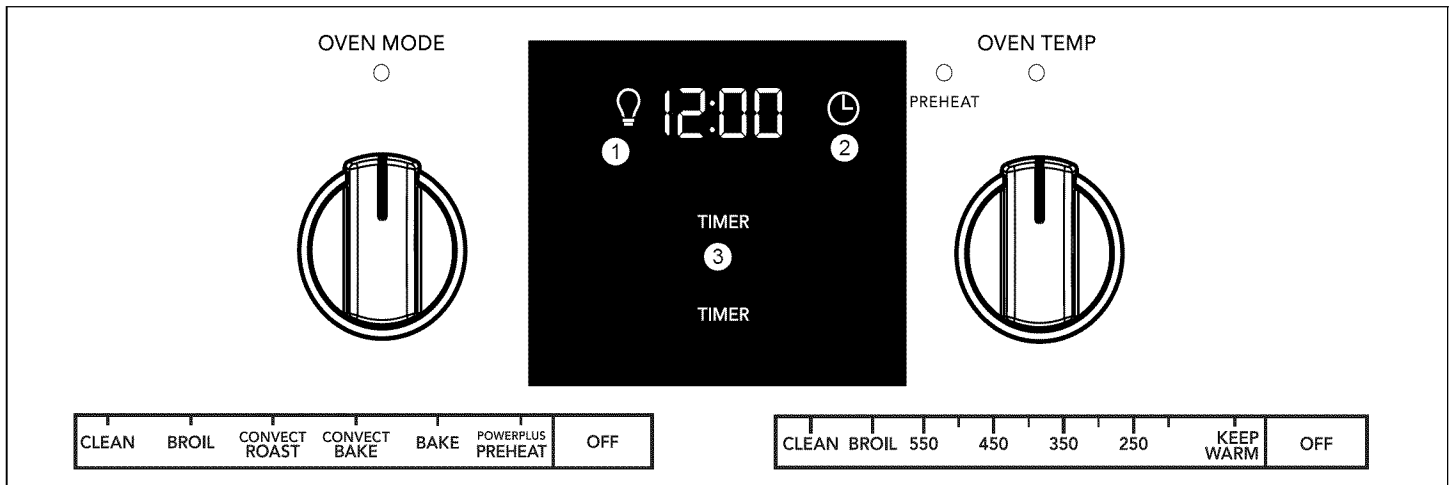

## OVEN MODE SETTINGS

**POWERPLUS™ PREHEAT** - Use powerplus preheat for single rack items only and place food in center of oven.

**BAKE** - Use to select bake function before setting temperature.

**CLEAN** - Use to select clean feature cycle before setting clean with oven temperature selector.

**CONVECT BAKE** - Use to select convection baking before setting oven temperature.

**CONVECT ROAST** - Use to select convection roast for beef, lamb, pork, and poultry before setting oven temperature.

**BROIL** - Use to set broil feature before setting broil with oven temperature selector.

**KEEP WARM** - Keep warm provides a low heat for keeping cooked foods at serving temperature.

## OVEN DISPLAY FEATURES

- Oven light** - Use to turn on the internal oven light.
- Clock** - Use to set the time of day.
- TIMER** - Use to set or cancel the minute timer. The minute timer does not start or stop any cooking function.

**OVEN TEMP SETTINGS** - Use to set oven temperatures between 170°F (KEEP WARM) and 550°F. The CLEAN setting should only be used after reading all cautions and warnings in the “Setting Clean” section of this manual starting on page 29.

## Oven Minimum and Maximum Control Settings

Feature	Min. Temp/Time	Max. Temp/Time
BAKE	170°F (77°C) (KEEP WARM)	550°F (288°C)
POWERPLUS PREHEAT	170°F (77°C) (KEEP WARM)	550°F (288°C)
CONVECT BAKE	170°F (77°C) (KEEP WARM)	550°F (288°C)
CONVECT ROAST	170°F (77°C) (KEEP WARM)	550°F (288°C)
MEAT PROBE	140°F (60°C)	210°F (99°C)
BROIL	550°F (288°C)	
TIMER	0:01 Hr	11:59
CLOCK (12hr)	1:00 Hr	12:59 Hr

## User Preference Settings

The default (factory) settings for sounds, energy saving, temperature offset, and convection convert are pre-set in the oven control. These may be changed by accessing the user preference display while the oven is in the idle mode and no timers are active.

Once the user preference menu is activated, the user can make changes and scroll through a menu of options, choosing from **AUd** (audible control setting), **ES** (energy saving), **UPO** (User Programmable Offset for changing the oven temperature), **Aut** (automatic convection convert), and **dEF** (default) setting with **rSt** reset choice (which will allow all preferences to reset to default settings).



## SETTING OVEN CONTROLS

### Setting the Clock

The clock icon is used to access the time of day setting. When the oven is first plugged in or if there has been an interruption in power to the range, **12:00** will flash in the display.

#### To set the correct time of day:

1. Press the clock icon.
2. The display will show a time along with a **–** and a **+** key in the display below.
3. Press either **–** or **+** key to scroll to the correct time of day and release the key.
4. The control will accept the new set time with a chime, and the control will show the time of day along with the two timers that are available.

#### NOTE

The clock cannot be changed when the oven is set for cooking or clean is active. Only a 12 hour clock is available on the Frigidaire Professional model.

### Oven Lights

The oven lights will turn on automatically when the oven door is opened. The oven lights may be turned on when the door is closed by using the oven light key located on the control panel.

**Note:** Keep oven lights off while baking. The oven lights will turn off during a clean cycle and not operate.

#### To toggle the oven lights on and off:

1. Press oven light symbol .

The interior oven lights are covered with a glass shield. The glass shield must be in place whenever the oven is in use.

To change the interior oven lights, see “Replacing the oven interior light bulbs:” in the Care & Cleaning section.

### Setting the Timer

The minute timers in the oven display serve as extra timers to help keep track of cooking functions. The timer cannot be used during a clean cycle or if the meat probe function associated with the timer display is in use. The minimum timer setting is 1 minute and the maximum setting is 11:59 (HR:MIN).

#### To set the timer:

1. Press either **TIMER** key.
2. The timer display will show **0:00** and the **–** and **+** keys on either side of the time display. **NOTE:** If the **–** key is pressed at this time an invalid key chime will sound.
3. Press the **+** key to begin to scroll to the desired setting. If the **+** key is held, the timer value will increase rapidly. Once the desired setting is reached, release the key and the timer will start counting down automatically after a short time-out.
4. The timer display will show the **H:M** icon if the timer is set for more than 1 minute. If the value is under 1 minute, the timer will display the time in seconds and the **H:M** icon will not appear.
5. When the timer ends, a reminder chime will sound and repeat once every 60 seconds for a period of five minutes. Before the user can program an expired timer again, the timer key must be pressed.
6. To cancel the timer before the set time expires, press the **TIMER** key.

#### NOTE

The minute timers will not start or stop the cooking process. The minute timers can be used alone or while using most of the other oven features.

## SETTING OVEN CONTROLS

### Setting Continuous Bake or 6 Hour Energy Saving

The oven is preset to cook up to 6 hours and to shut off automatically. For longer periods of cooking, this feature can be changed to continuous cooking by setting the user preference and turning the energy saving feature off.

#### To set the oven for continuous cooking:

1. Press and hold both the **light** icon and the **clock** icon at the same time for a few seconds until the display sounds an acceptance chime and the display will show one of the user preferences.
2. Press the **+** key in the upper part of the display until **ES** appears and **ON** is showing.

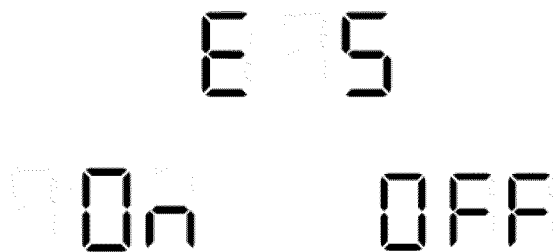

Figure 11: Energy saving with ON and OFF options

3. To turn the energy saving feature **off**, press the **+** or **-** key in the lower part of the display and **OFF** will appear in the display.
4. The control will accept the change in a few seconds and sound the acceptance chime. The oven is now set for continuous cooking.
5. To return to the time of day display, press and hold the **light** and **clock** icons at the same time for a few seconds until the display chimes and fades back to showing the time of day in the display.

### → IMPORTANT

Changing to continuous bake does not change how the cooktop controls operate.

### Setting Control for Silent Operation

The oven is set to operate with certain chimes and tones (default settings) that alert the user to certain oven functions. The silent operation feature allows the oven control to be operated without sounds when necessary. By accessing user preferences, this option can be later returned to operate with normal programming sounds.

#### To set the oven control for silent operation:

1. Press and hold both the **light** icon and the **clock** icon at the same time for a few seconds until the display sounds an acceptance chime. **AUd** should appear in the display.
2. If **Aud** is not showing, press the **+** key in the upper part of the display until **AUd** appears and **HI** is showing in the lower part of the display. This is the normal (default) setting.



Figure 12: Default setting for oven control sounds

3. To turn the energy saving feature to a lower sound or completely OFF, press the **+** or **-** key in the lower part of the display until **LO** or **OFF** appears in the display.



Figure 13:

4. When the desired setting appears in the display, release the key and wait for an acceptance chime.
5. To return to the time of day display, press and hold both the **light** and **clock** icons at the same time for a few seconds until the display chimes and fades back to showing the time of day.

## SETTING OVEN CONTROLS

### Setting PowerPlus™ Preheat

The PowerPlus™ Preheat feature uses the convection fan to quickly bring the oven up to the set temperature. Use powerplus preheat for single rack items only and place food in center of oven.

**Important:** When baking delicate items like cakes and cookies use the convection bake mode.

#### To set powerplus preheat:

1. Turn the oven mode selector to **POWERPLUS PREHEAT**. The oven mode light will turn on.
2. Turn the oven temperature selector to the desired temperature. The convection fan will turn on and remain on as a convection bake. Once the set temperature is reached the control will chime alerting the user that the oven is preheated.
3. When finished baking, turn both oven selectors to the **OFF** position.

### Setting Bake

#### Baking tips

##### For best bake results:

- Fully preheat the oven before baking.
- For batter and dough-based baked goods such as cookies, cakes, pastries, and breads, use the convection function for best results.
- When using any single rack, position the rack so that the food is in the center of the oven.
- For best results when baking cakes using two oven racks, place flat rack in position 5 and the glide rack in position 1. (See Figure 14).
- When using two oven racks, position cookware as shown in Figure 15. Allow at least 2-4 inches (5-10 cm) of space between cookware for proper air circulation.
- Dark or dull bakeware absorbs more heat than shiny bakeware. It may be necessary to reduce oven temperature and cook time to prevent overbrowning of some foods. Dark bakeware is recommended for pies. Shiny bakeware is recommended for cakes, cookies, and muffins.

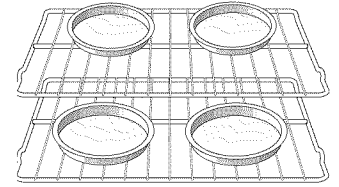
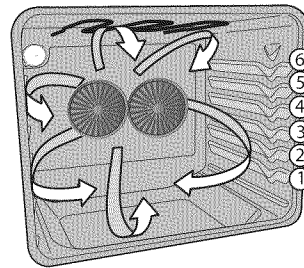

**Figure 14: Rack positions**    **Figure 15: Pan spacing**

Use the **Bake** function whenever a recipe calls for baking using normal temperatures. When the set bake temperature is reached the control will sound a chime to alert that the oven is fully preheated. The convection fan will be on during preheat and then turn off and on occasionally as needed.

Bake may be set for any temperature between 170°F (77°C) and 550°F (288°C).

#### To set a bake for 350°F:

1. Be sure to arrange racks to the desired positions for the item(s) to be baked.
2. Turn the oven mode selector to the **BAKE** position.
3. Turn the oven temperature selector to **350°F**.
4. The **PREHEAT** and the oven temperature light will turn on and sound an acceptance tone. The oven will begin heating.
5. When the set temperature is reached the **PREHEAT** light will turn off and a reminder chime will sound alerting you to place food in oven. Set either timer to keep track of actual cooking time if necessary.
6. When finished baking, be sure to return both the temperature selector knob and the oven mode knob to the **OFF** positions.

**Note:** Do not open the oven door often. Doing so will reduce the temperature in the oven and may increase the cooking time necessary for best results.

## SETTING OVEN CONTROLS

### Convection Cooking

This mode of cooking enables you to obtain the best results when baking with multiple pans and racks. The oven can be programmed for convection baking at any temperature between 170°F to 550°F. The convection function uses a fan to circulate the oven heat uniformly and continuously around the oven (Figure 16). This improved heat distribution allows for fast, even cooking and browning results. It also gives better baking results when using two oven racks at the same time.

#### Benefits of convection cooking:

- Multiple rack baking.
- Some foods may cook faster, saving time and energy.

#### Convection baking tips:

- Fully preheat the oven before baking items like cookies, cakes, biscuits, and breads.
- For single rack baking, position the rack so that food is in the center of the oven.
- If your recipe cooking temperature has already been converted for convection baking, there is no need to reduce your oven temperature. If not, see “Setting Convection Convert” on page 21 for further instructions on temperature conversion.
- For best results when baking cakes using two oven racks, place flat rack in position 5 and the glide rack in position 1 (See Figure 16). When baking using two oven racks, position cookware as shown in Figure 17. Allow at least 2 inches (5 cm) of space between cookware for proper air circulation.
- Dark or dull bakeware absorbs more heat than shiny bakeware. It may be necessary to reduce oven temperature and cook time to prevent overbrowning of some foods. Dark bakeware is recommended for pies. Shiny bakeware is recommended for cakes, cookies, and muffins.
- Do not open oven door too often. Doing so reduces oven temperature and may extend cooking time.
- Most baked goods (except cakes) should be baked on pans with no sides or low sides to allow air to circulate.

### Setting Convection Bake

**To set the oven for convection bake and temperature to 375°F:**

1. Arrange interior oven racks.
2. Turn the oven mode selector to **CONVECT BAKE**.
3. Turn the oven temperature selector to **375°F**.
4. The oven temperature light will blink before sounding a chime confirming the setting. The convection fan will turn on and the oven will begin heating.
5. Once the oven reaches the set temperature the oven will sound a chime indicating the food items can be placed in the oven.
6. When finished baking, be sure to return both the temperature selector knob and the oven mode knob to the **OFF** positions.

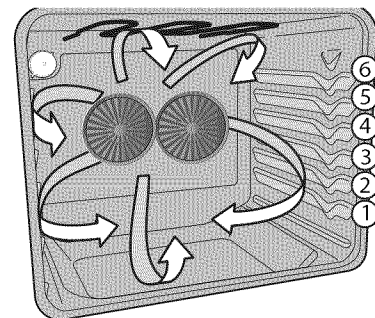

**Figure 16: Convection air flow**

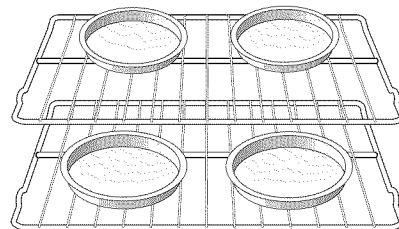

**Figure 17: Pan spacing suggestion**

## SETTING OVEN CONTROLS

### Setting Convection Convert

Convection convert automatically converts a standard baking recipe for convection baking. Convection convert may only be used with convection bake. This feature must be set before selecting the oven mode and oven temperature by using the user preference setting in the oven display.

Because convection baking generally cooks food faster than normal baking, food items should be checked for doneness before the suggested normal recipe cook times.

#### To set convection convert:

1. The oven temperature selector must be in the **OFF** position. Turn the oven mode selector to **CONVECT BAKE**.
2. Press and hold both the oven **light** icon and the **clock** icon for about 3 seconds until **Aut°** (automatic convection convert) appears in the display.

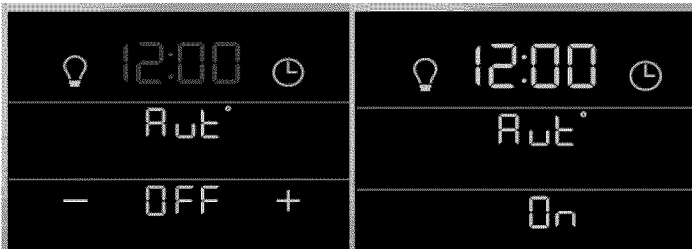

**Figure 18: Convection convert off (L) and on (R)**

Press either the **-** or **+** key until **On** appears.

Turn the oven mode selector to the **OFF** position. The oven will accept the convection convert setting with an acceptance chime and the control will return to display the time of day. The convection bake function will now automatically convert normal baking temperatures for convection baking.

To change back to regular convection baking, repeat the same steps in this process and press the **+** or **-** key until **OFF** appears. Once the control accepts the change with a chime, turn the oven mode selector to **OFF**.

### Setting Convection Roast

Convection roast is best for cooking tender cuts of beef, lamb, pork, and poultry. Use this mode when cooking speed is desired. Convection roasting gently browns the exterior and seals in the juices. Convection roasting uses the bake element, convection element, broil element, and fan to circulate the heat evenly and continuously within the oven.

#### Convection roasting tips:

- Use a broiler pan and grid, as well as a roasting rack (available by mail order). The broiler pan will catch grease drippings, and the grid will help prevent spatters. The roasting rack will hold the meat. Make sure the roasting rack is securely seated on the grid in the broiler pan. Do not use the broiler pan without the grid or cover the grid with aluminum foil or any other material.
- Pull the rack out to the stop position before removing food. Position food (fat side up) on the roasting rack.
- Do not open the oven door often. Doing so will reduce the temperature in the oven and may increase the cooking time necessary for best results.
- It is not recommended to roast chicken on a roasting rack. Use a deep pan and place on rack position 1 (offset rack).

#### To set oven for convection roasting:

1. Place meat on roasting rack and place in oven.
2. Turn oven mode selector to **CONVECT ROAST**.
3. Turn oven temperature selector to desired roasting temperature.

**Note:** Preheating the oven for convection roasting is not necessary. At this time you may want to set **TIMER** as a reminder for checking food.

## SETTING OVEN CONTROLS

Table 2: Convection roasting temperature and time recommendations

Meat		Weight	Oven Temp	Internal Temp	Minutes per lb.
Beef	Standing rib roast*	4 to 6 lb.	350°F (177°C)	*160°F (71°C)	25-30
	Rib eye roast*	4 to 6 lb.	350°F (177°C)	*160°F (71°C)	25-30
	Tenderloin roast	2 to 3 lb.	400°F (204°C)	*160°F (71°C)	15-25
Poultry	Turkey whole**	12 to 16 lb.	325°F (163°C)	180°F (82°C)	8-10
	Turkey whole**	16 to 20 lb.	325°F (163°C)	180°F (82°C)	10-15
	Turkey whole**	20 to 24 lb.	325°F (163°C)	180°F (82°C)	12-16
	Chicken	3 to 4 lb.	350°F-375°F (177°C-191°C)	180°F (82°C)	12-16
Pork	Ham roast, fresh	4 to 6 lb.	325°F (163°C)	160°F (71°C)	30-40
	Shoulder blade roast	4 to 6 lb.	325°F (163°C)	160°F (71°C)	20-30
	Loin	3 to 4 lb.	325°F (163°C)	160°F (71°C)	20-25
	Pre-cooked ham	5 to 7 lb.	325°F (163°C)	160°F (71°C)	30-40

\* The U.S. Department of Agriculture states, "Rare fresh beef is popular, but you should know that cooking it to only 140°F (60°C) means some food poisoning organisms may survive." (Source: Safe Food Book, Your Kitchen Guide, USDA Rev. June 1985.) The lowest temperature recommended by the USDA is 145°F (63°C) for medium rare fresh beef. For well done 170°F (77°C)

\*\* Stuffed turkey requires additional roasting time. Shield legs and breast with foil to prevent over browning and drying of the skin.

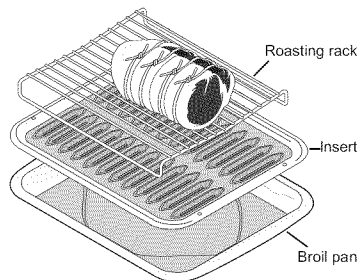

Figure 19: Roast with broil pan and insert and roasting rack

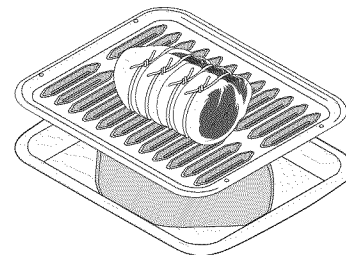

Figure 20: Roast with broil pan and insert

### CAUTION

Do not use the broiler pan without the insert. A roasting rack (some models) can be used when convection roasting. Do not cover the broil pan or insert with aluminum foil or any other material; the exposed grease could ignite.

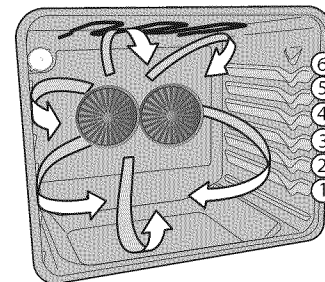

Figure 21: When convection roasting use the offset rack in position 1 for best results. When roasting chicken do not use a roasting rack; use a deep pan instead and place on rack position 1 (offset rack).

## SETTING OVEN CONTROLS

### Using the Broil Feature

Use the broil feature to cook meats requiring direct exposure to radiant heat for optimum browning results.

#### **CAUTION**

Always use pot holders or oven mitts when working with a hot oven. When broiling, the oven interior, oven racks and cooktop will become hot enough to cause burns. Do not use the broiler pan without the insert. The insert is slotted and allows the grease to drain away from the meat and the high heat of the broiler into the broiler pan. Do not cover the broil pan or insert with aluminum foil or any other material; the exposed grease could ignite.

#### **WARNING**

Should an oven fire occur, do not open oven door, turn off the oven. If the fire continues, throw baking soda on the fire or use a fire extinguisher. Do not put water or flour on the fire. Flour may be explosive, and water can cause a grease fire to spread and cause personal injury. To prevent grease splattering, use the broil pan and insert when broiling.

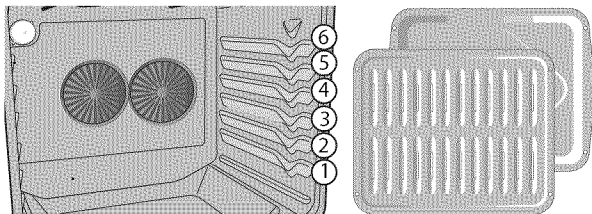

Figure 22: Rack positions (L); and broil pan and insert (R)

Table 3: Broiling Suggestions

Food	Rack Position	Temperature	Cook time (minutes)		Internal Temperature	Doneness
			1st side	2nd side		
Steak 1" thick	6th*	550F (288°C)	6	4	145°F (63°C)	Medium*
Steak 1" thick	6th*	550F (288°C)	8	7	170°F (77°C)	Well
Pork Chops 3/4" thick	6th	550F (288°C)	8	6	170°F (77°C)	Well
Chicken bone-in	5th	550F (288°C)	20	10	170°F (77°C)	Well
Chicken boneless	5th	550F (288°C)	8	6	170°F (77°C)	Well
Fish	4th	550F (288°C)	13	n/a	170°F (77°C)	Well
Shrimp	4th	550F (288°C)	5	n/a	170°F (77°C)	Well
Hamburger 1" thick	6th*	550F (288°C)	5	5	135°F (57°C)	Rare**
Hamburger 1" thick	6th*	550F (288°C)	9	7	145°F (63°C)	Medium
Hamburger 1" thick	6th*	550F (288°C)	10	8	170°F (77°C)	Well

\*Use offset rack in top position. The U.S. Department of Agriculture states, \*\*Rare fresh beef is popular, but you should know that cooking it to only 140°F (60°C) means some food poisoning organisms may survive." (Source: Safe Food Book, Your Kitchen Guide, USDA Rev. June 1985.) The lowest temperature recommended by the USDA is 145°F (63°C) for medium rare fresh beef. For well done 170°F (77°C). All cook times shown are after 2 minutes of preheating.

#### To set broil:

1. Arrange oven racks while oven is cool.
2. Turn the mode selector knob to **broil**. The corresponding indicator light will flash.
3. Turn the temperature selector knob to **broil**. The indicator light will turn on and remain lit. For optimum browning results, preheat oven for 2 minutes before adding food.
4. Place the broiler pan on the rack. Be sure to center the broiler pan directly under the broiler element. Broil with the oven door closed.
5. Pull oven rack out to the stop position before turning food to broil on second side.
6. Turn the temperature and the selector knobs to **OFF** when broiling is complete or to cancel broil.

#### **WARNING**

To prevent food from contacting the broil element and to prevent grease splattering, do not use the roasting rack when broiling.

#### Recommended Broiling Times

Depending on the type, the thickness, and the desired doneness of meat, it might be necessary to increase or decrease suggested broiling times or adjust the broiling pan to different rack positions. If a broiler pan and insert are not supplied with this appliance, they may be purchased from [frigidaire.com](http://frigidaire.com).

## SETTING OVEN CONTROLS

### Meat Probe

Use the probe feature for best results when cooking foods such as roasts, hams or poultry, using a probe to check internal temperature is the safest method to ensure properly cooked food. Before using the meat probe read the important information listed here:

#### → IMPORTANT

- The probe feature must be set before setting the cooking mode and oven temperature.
- If a timer is running when the meat probe is plugged in, the control will sound a triple beep once and the timer will keep running. The timer must be canceled before the probe temperature can be set.
- If the meat probe is unplugged during cooking function, or plugged in during BROIL, the oven will stop cooking and turn off.
- If the meat probe is plugged in while the oven is in a function that allows for the meat probe, the control will sound a triple beep indicating that the meat probe is not allowed to be plugged in while the oven is running. After the alert, the oven will continue to cook to the set oven temperature.
- If no cooking mode is selected within 30 seconds of setting the target temperature, the oven mode indicator light will stop blinking. The display will continue to show the meat probe settings until an allowable cooking cycle is selected.
- When the meat probe is set correctly, the control will signal an alert when the internal food temperature reaches the desired set target temperature. When active, the internal food temperature is visible in the display during the cooking process. This eliminates any guesswork or the need to open the oven door to check the thermometer.

**Note:** If the meat probe is plugged while the oven is in a function which allows probe cooking, it may be set the following way:

1. Cancel the active cooking function. The display will show the meat probe icon and temperature 000°.
2. The meat probe temperature can now be set and the control will sound an acceptance chime. The oven mode indicator light will blink until an allowable cooking function is selected.

#### Proper placement of probe in food.

- Insert the probe so that the probe tip rests inside the center of the thickest part of meat or food (Figure 23). For best results, do not allow the probe to contact bone, fat, gristle, or the cookware.
- For bone-in ham or lamb, insert the probe into the center of lowest large muscle or joint.
- For meatloaf or casseroles, insert the probe into center of food.
- When cooking fish, insert meat probe just above the gill.
- For whole poultry or turkey, fully insert the probe into the thickest part of the breast.

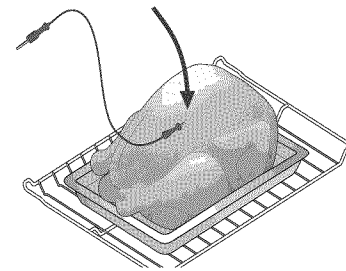

**Figure 23: Placing probe in poultry**

#### To set probe:

1. Insert the probe into the food. Place prepared food on the desired oven rack position and slide into the oven.
2. Plug the connector end of the probe into the probe receptacle while the oven is still cool.

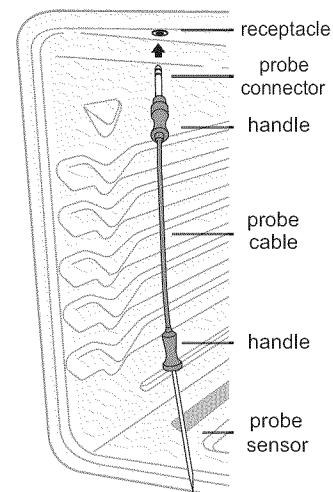



## SETTING OVEN CONTROLS

### Meat Probe (cont'd)

- When the probe is inserted, an acceptance tone will sound, the probe icon appears in the display (See Figure 24). Close the oven door.



**Figure 24: Probe inserted and ready to set temperature**

- Press the **+** key to set the desired probe temperature between 140°F and 210°F. If no selection is made within 10 seconds, the control will automatically set the default temperature of 170°F and the display will sound an acceptance chime.

**Note:** The probe must be fully set before setting the oven mode and temperature mode.

- Set the **oven mode** to **POWERPLUS PREHEAT**, **BAKE**, **CONVECT BAKE**, or **CONVECT ROAST**.
- Set the **oven temp** control to the desired cooking temperature. The oven will begin heating.
- During the cooking process, an up arrow **↑** and the current meat probe temperature will appear in the display until the meat probe target temperature is reached.
- When 75% of the target temperature is reached, the control will chime and a **CHECK FOOD** reminder will appear in the display. **CHECK FOOD** will remain in the display and continue to chime every 60 seconds for five minutes or until the oven door is open.
- Once the target temperature of the food is reached, the control will chime to signal the end of cooking. At this time the **↑** will turn off and the display will show the **FOOD READY** and **OVEN WARM** messages.

### Trailing Keep Warm with Meat Probe

When the meat probe reaches the target temperature, the oven will automatically switch to keep warm (170°F) and remain on for up to 3 hours before turning off automatically. The display will continue to show the meat probe temperature until either **keep warm** is canceled or by disconnecting the meat probe from the receptacle. Once turned off, the probe icon and temperature will fade from the display.

**Important:** If the meat probe temperature should exceed the maximum allowable temperature, the oven control will beep and **HOT** will appear in the display for 40 seconds to notify that the probe temperature is too high.

### Setting Keep Warm

**Keep Warm** maintains a temperature of 170°F (77°C) for keeping oven baked foods at serving temperature until canceled. The feature may be used with **BAKE**, **CONVECT BAKE**, **CONVECT ROAST**, and **POWERPLUS PREHEAT**.

#### Keep warm tips:

- Always start with hot food. Do not use the keep warm feature to heat cold food.
- Food in heat-safe glass and glass ceramic containers may need higher temperature settings compared to food in regular containers. Avoid repeated openings of the oven, it will allow hot air to escape and the food to cool.
- Aluminum foil may be used to cover food to increase moisture content.

#### To set keep warm:

- Arrange interior oven racks and place food in oven.
- Turn the oven mode selector to **BAKE**, **CONVECT BAKE**, **CONVECT ROAST**, or **POWERPLUS PREHEAT**.
- Set the oven temperature selector to **KEEP WARM**.
- The indicator light will blink and then an acceptance chime will sound.
- The preheat indicator light will turn on and stay on until the oven reaches the keep warm temperature of 170°F.

## SETTING OVEN CONTROLS

### Setting the Sabbath Feature



This appliance provides special settings for use when observing the Jewish Sabbath/Holidays. For further assistance, guidelines for proper usage, and a complete list of models with the Sabbath feature, please visit the web at [www.star-k.org](http://www.star-k.org).

Sabbath mode disables all audible tones or visual display changes on the oven control. The Sabbath feature may only be used with the bake function. Once the oven is properly set using bake with the Sabbath feature active, the oven will remain on until cancelled. The Sabbath feature overrides the factory preset 6 hour energy saving feature.

**Important:** The oven light will turn off during the Sabbath mode and remain off until the Sabbath mode is canceled.

The meat probe feature is not available in Sabbath mode.

#### **WARNING**

Food Poisoning Hazard. Do not let food sit for more than one hour before or after cooking. Doing so can result in food poisoning or sickness. Foods that can easily spoil such as milk, eggs, fish, meat, or poultry should be chilled in the refrigerator first. Even when chilled, they should not stand in the oven for more than 1 hour before cooking begins and should be removed promptly when finished cooking.

#### **To set the oven for baking and activate the Sabbath feature:**

1. Be sure the clock is set to the correct time of day. Place food in the oven.
2. Turn the oven mode selector to **BAKE**.
3. Turn the oven temperature selector to the desired bake temperature.
4. An acceptance chime will sound, the oven will start heating and the LED lights will stop blinking and remain on.
5. To enter Sabbath mode press and hold the **oven light** key and the **clock** key at the same time for about 3 seconds. The control will sound an acceptance chime and **SAB** will appear in the display below the time of day.

**Figure 25: Oven display showing Sabbath mode**

**Note:** During the Sabbath mode all normal sounds of the oven control will be turned off. However the control will allow any sounds associated with alarms.

During Sabbath operation the oven temperature may be changed by adjusting the oven temperature selector. The oven will remain in Sabbath until canceled by the user.

#### **To turn off the Sabbath feature:**

1. Turning the oven mode selector and the oven temperature selector to the **OFF** position will cancel BAKE only.
2. To turn off the Sabbath feature press and hold both the oven light key and the clock key for about 3 seconds.
3. The acceptance chime will sound and SAB will disappear from the display. Be sure both oven selectors are returned to the **OFF** positions

#### **Power failure while using Sabbath feature:**

Should you experience a power failure or interruption, the oven will shut off. When power is returned, **SF** (Sabbath Failure) will be displayed, and the oven will not turn back on automatically. If your food was nearly fully cooked, you may allow the trapped heat in the oven to finish the cooking process. Otherwise, you should remove the food when the power failure occurs because you may only start the oven once during the Sabbath/Jewish holidays.

After the Sabbath observance turn off the Sabbath feature. Press and hold both the **oven light** and **clock** keys for at least 3 seconds. **SAB** will disappear from the display, and the oven may be used with all normal functions.

## SETTING OVEN CONTROLS

### Adjusting the Oven Temperature

The temperature in the oven is pre-set at the factory. When first using the oven, be sure to follow recipe times and temperatures.

#### NOTE

Do not use oven thermometers such as those found in grocery stores to check the temperature settings inside your oven. These oven thermometers may vary as much as 20 to 40 degrees from actual temperatures.

If you think the oven is cooking too hot or too cool for the temperature you select, you can adjust the actual oven temperature to be more or less than what is displayed by accessing the UPO (User Programmable Offset).

Before adjusting, test a recipe by using a temperature setting higher or lower than the recommended temperature. The baking results should help you to decide how much of an adjustment is needed.

**Important:** Before making a temperature adjustment, make sure both the oven mode and oven temperature control knobs are in the OFF position.

#### To adjust the oven temperature:

1. When the oven is idle, press and hold both the light icon and the clock icon at the same time for a few seconds until the display sounds an acceptance chime. **AUd** should appear in the display.
2. Press the **+** key in the upper part of the display until **UPO** appears and the default setting of **0°** (or the last offset temperature) is showing.

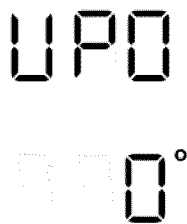

Figure 26: UPO shown at default setting

3. Using the **+** or **-** key in the bottom of the display, press until the desired temperature change (offset) is reached. The display will change  $\pm 5^\circ$  with each key press to a maximum of **+ 35°** or a minimum of **- 35°F**.



Figure 27: UPO shown 10° higher than default

If a lower temperature offset is desired, press the **-** key in the bottom of the display until the desired lower temperature appears.



Figure 28: UPO shown 10° lower than default

Once the new offset appears in the display, release the key and the control will accept the change.

4. To return the display to normal, press and hold both the oven **light** icon and the **clock** icon at the same time until an acceptance chime sounds. The display will return to show the time of day.

#### NOTE

Changing the UPO will not affect the broil or clean temperatures.

## SETTING OVEN CONTROLS

### Self Cleaning

A self cleaning oven cleans itself with temperatures well above normal cooking temperatures which eliminate soils completely or reduces them to a fine powdered ash you can wipe away with a damp cloth. While the oven is in operation, the oven heats to temperature much higher than those used in normal cooking. Sounds of metal expansion and contraction are normal. Odor is also normal because the food soil is being removed. Smoke may appear through the oven vent.

### → IMPORTANT

#### Adhere to the following self clean precautions:

- Do not use oven cleaners or oven protective coatings in or around any part of the oven interior.
- Do not clean the oven door gasket (Figure 29). The woven material of the oven door gasket is essential for a good seal. Care should be taken not to rub, damage, or remove the gasket.
- Do not use any cleaning materials on the oven door gasket. Doing so could cause damage.
- Remove the broiler pan and insert, all utensils, and any aluminum foil. These items cannot withstand high cleaning temperatures and will melt.
- Completely remove all oven racks and any accessories. If the oven racks are not removed, they will lose their special coating properties and no longer slide in and out of the oven cavity easily.
- Remove any excessive spills. Any spills on the oven bottom should be wiped up and removed before starting the clean cycle. To clean, use hot, soapy water and a cloth. Large spills can cause heavy smoke or fire when subjected to high temperatures.
- Do not allow food spills with a high sugar or acid content (such as milk, tomatoes, sauerkraut, fruit juices, or pie filling) to remain on the surface as they may leave a dull spot even after cleaning.
- Clean any soil from the oven frame, the door liner outside the oven door gasket, and the small area at the front center of the oven bottom. These areas heat sufficiently to burn soil on. Clean with soap and water. These areas are shown in white (Figure 29).

### ⚠ CAUTION

During the clean cycle, the outside of the range can become very hot to the touch. Do not leave small children unattended near the appliance.

The health of some birds is extremely sensitive to the fumes given off during the clean cycle of any range. Move birds to another well ventilated room.

Do not force the oven door open. This can damage the automatic door locking system. Use caution when opening the door after the clean cycle is complete. The oven may still be very hot.

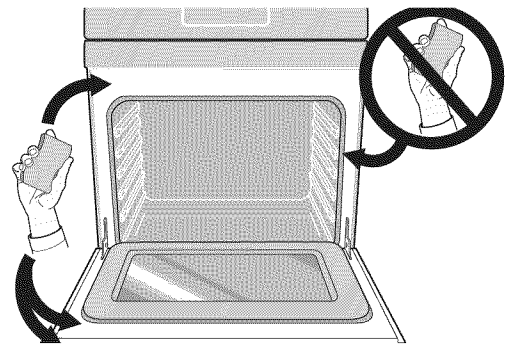

Figure 29: Clean around the oven door gasket

### ⚠ CAUTION

To avoid possible burns, use care when opening the oven door after the clean cycle. Stand to the side of the oven when opening the door to allow hot air or steam to escape.

Do not leave small children unattended near the appliance during a clean cycle; the range may become very hot to the touch.

Do not line the oven walls, racks, bottom, or any other part of the range with aluminum foil or with any other materials or oven liners. Doing so will destroy heat distribution, produce poor baking results, and cause permanent damage to the oven interior and aluminum foil will melt to the interior surface of the oven.

## SETTING OVEN CONTROLS

### Setting Clean

If you are planning to use the oven directly after a clean cycle, remember to allow time for the oven to cool down and the oven door to unlock. This normally takes about one hour. A 3 hour clean cycle will actually take about 4 hours to complete.

It is recommended to use a 2 hour clean cycle for light soils, a 3 hour cycle for average soils, and a 4 hour cycle for heavy soils.

#### To set the controls for a 3 hour clean cycle and shut off automatically:

1. Turn both the oven mode and oven temperature selectors to **CLEAN**. The display will show a 3 hour time (normal clean) and the **-** and **+** keys.

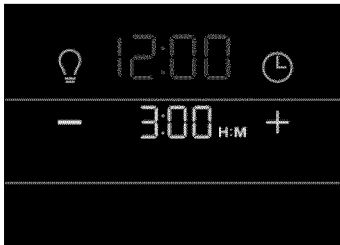

Figure 30: Oven set for 3 hour clean

2. If a 3 hour clean is desired, the control will accept the time within 3 seconds. However, the user may select a 2 or 4 hour clean by using the **-** or **+** keys to change to the desired clean time and then allow the control to accept the change.

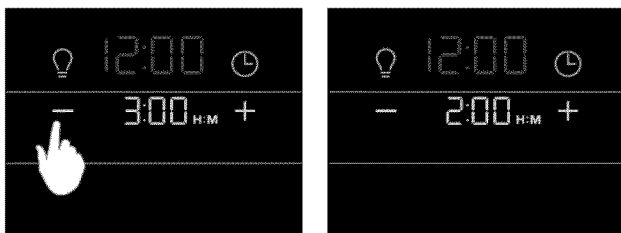

Figure 31: Setting 2 hour clean

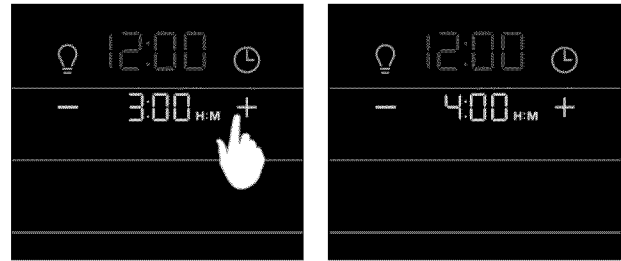

Figure 32: Setting 4 hour clean

Once the control accepts the clean time the display will flash a reminder for the user to **REMOVE RACKS**. The

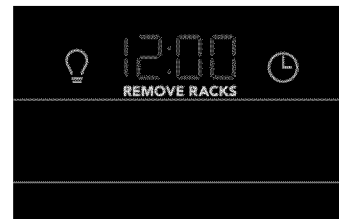

Figure 33: Display prompting user to remove racks

**REMOVE RACKS** notification will flash for a few seconds prompting the user to remove all oven racks. If the oven door is opened as this time the display will show **CLO** to indicate that the door must be closed before the clean cycle can begin. If the door remains open for more than 3 minutes, the clean function will be canceled.



Figure 34: Message of open door that must be closed before oven can begin the clean cycle

When the oven is set to run the clean cycle, the motor door lock will begin locking the oven door. Do not open the oven door while the lock motor is running or when any locking indicators or displays are showing. The oven door is completely locked in about 15 seconds.

## SETTING OVEN CONTROLS

- Once the door is closed the time of day will be visible along with the selected clean time and the door lock icon will be blinking in the display.



**Figure 35: Clean cycle in progress**

- During the clean cycle the time of day remains in the display and the time remaining in the clean cycle will also be active. (Figure 35)



**Figure 36: Hot oven after clean with door still locked**

- When the clean cycle ends the oven will be too hot for the door to unlock until the oven cools to a safe temperature. This may take up to an hour. During this time the display will show **Hot** along with the door lock icon.
- At this point **CLn** will appear in the display and the lock icon will blink to signal the end of the clean cycle with a chime. The internal oven temperature will still be hot enough to cause burns.



**Figure 37: Clean lock icon blinks as door unlocks**

### CAUTION

To avoid possible burns, use care when opening the oven door after the cleaning cycle. Be careful when opening and stand to the side to allow any steam and heat to escape.

The oven bake and broil elements may appear to have cooled after they have been turned off and after a clean when the door is first opened. These elements may still be hot and may cause burns if touched before they have cooled.

**Note:** Once the clean cycle ends the oven will not be available for another clean for 4 hours.

#### **To cancel a clean before it ends:**

Turn both the oven selector knob and the oven temperature knob to the **OFF** position.

## Cleaning Various Parts of Your Oven

Before cleaning any part of the oven, be sure all controls are turned off and the oven is cool. Remove spills and any heavy soiling as soon as possible. Regular cleaning will reduce the number of major cleanings later.

Surface Type	Recommendation
Aluminum and Vinyl	Use hot, soapy water and a cloth. Dry with a clean cloth.
Painted and plastic control knobs Painted body parts Painted decorative trims	Using a soft cloth, clean with mild dish detergent and water or a 50/50 solution of vinegar and water. Follow by rinsing the area with clean water; dry and polish with a soft cloth. Glass cleaners may be used if sprayed on a soft cloth first. Do not spray liquids directly on the oven control and display area.
Control panel	Do not use large amounts of water on the control panel - excess water on the control area may cause damage to the appliance. Do not use other liquid cleaners, abrasive cleaners, scouring pads, or paper towels - they will damage the finish.
Control knobs	To remove control knobs, turn to the OFF position; grasp firmly and pull straight off the shaft. To replace knobs after cleaning, line up the knob markings with the matching markings on the control panel; then push the knobs into place. On the single burner knobs line up the OFF markings before replacing the knobs.
Stainless Steel Smudge Proof™ Stainless Steel (some models)	Your oven finish may be made with stainless steel (some models). Clean the stainless with warm soapy water using a clean sponge or cloth. Rinse with clean water and dry with a soft clean cloth.  Do not use cleaners containing any abrasive, chlorides, chlorine, or ammonia. It is recommended to use mild dish soap and water or a 50/50 solution of water and vinegar.
Porcelain enamel broiler pan and insert (available by mail order) Oven interior (Porcelain) Door liner and body parts	Gentle scouring with a soapy scouring pad will remove most spots. Rinse with a 1:1 solution of clear water and ammonia. If necessary, cover difficult spots with an ammonia-soaked paper towel for 30 to 40 minutes.  Rinse with clean water and a damp cloth, and then scrub with a soap-filled scouring pad. Rinse and wipe dry with a clean cloth. Remove all cleaners or the porcelain may become damaged during future heating.
Ceramic Cooktop	For special care instructions see "Cooktop Maintenance" on page 32.
Oven racks	Oven racks must be removed from oven cavity. Clean by using a mild, abrasive cleaner following manufacturer's instructions. Rinse with clean water and dry.
Oven door	Use soap and water to thoroughly clean the top, sides, and front of the oven door. Rinse well. You may use a glass cleaner on the outside glass of the door. Do not immerse the door in water. Do not spray or allow water or the glass cleaner to enter the door vents. Do not use oven cleaners, cleaning powders, or any harsh abrasive cleaning materials on the outside of the oven door.  Do not clean the oven door gasket. On self-clean models, the oven door gasket is made of a woven material which is essential for a good seal. Care should be taken not to rub, damage, or remove this gasket.

## CARE AND CLEANING

### Cooktop Maintenance

Consistent and proper cleaning is essential to maintaining your ceramic glass cooktop.

Prior to using your cooktop for the first time, apply a ceramic cooktop cleaning cream (available in most hardware, grocery, and department stores) to the ceramic surface. Clean and buff with a clean paper towel. This will make cleaning easier when soiled from cooking. The special cooktop cleaning cream leaves a protective finish on the glass to help prevent scratches and abrasions.

Sliding aluminum or copper clad bottom pans on the cooktop can cause metal markings on the cooktop surface. These marks should be removed immediately after the cooktop has cooled using the cooktop cleaning cream. Metal marks can become permanent if not removed prior to future use.

Cookware (cast iron, metal, ceramic or glass) with rough bottoms can mark or scratch the cooktop surface.

Do not:

- Slide anything metal or glass across the cooktop.
- Use cookware with dirt or dirt build up on bottom; replace with clean cookware before using.
- Use your cooktop as a cutting board or work surface in the kitchen.
- Cook foods directly on the cooktop surface without a pan.
- Drop heavy or hard objects on the ceramic glass cooktop, they may cause it to crack.

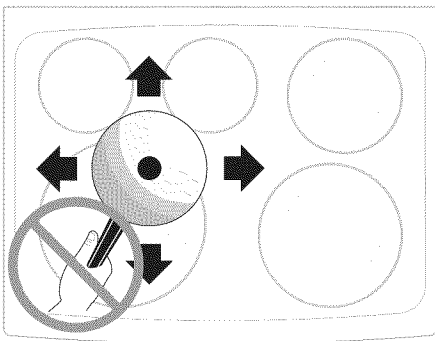

Figure 38: Cooktop care

### Cooktop Cleaning

#### ⚠ WARNING

Do not use a cooktop cleaner on a hot cooktop. The fumes can be hazardous to your health, and can chemically damage the ceramic-glass surface.

#### ⚠ CAUTION

Before cleaning the cooktop, be sure the controls are turned to OFF and the cooktop is cool. The glass surface could be hot and burns may occur if the glass surface is touched before it has cooled sufficiently.

#### For light to moderate soil:

Apply a few drops of cooktop cleaning cream directly to the cooktop. Use a paper towel or use a non-abrasive cloth or sponge to clean the entire cooktop surface. Make sure the cooktop is cleaned thoroughly, leaving no residue.

#### For heavy, burned on soil:

Apply a few drops of cooktop cleaning cream directly to the soiled area. Rub the soiled area using a non-abrasive cleaning tool, applying pressure as needed. Do not use the pad you use to clean the cooktop for any other purpose.

If soils remain, carefully scrape soils with a metal razor blade scraper, holding scraper at a 30 degree angle to the surface. Remove loosened soils with cooktop cleaning cream and buff surface clean.

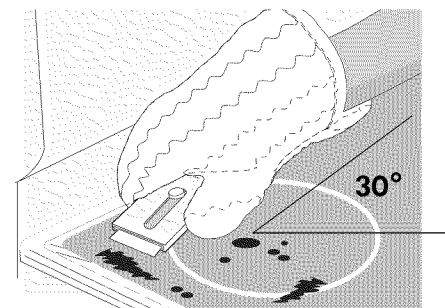

Figure 39: Cooktop cleaning



## CARE AND CLEANING

### Cooktop Maintenance (cont'd)

Plastic or foods with a high sugar content need be removed immediately if spilled or melted onto the ceramic cooktop surface. Permanent damage (such as pitting of the cooktop surface) may occur if not removed immediately. After turning the surface elements off, use a razor blade scraper or a metal spatula with a mitt and scrape the soil from the hot surface (as illustrated). Allow the cooktop to cool, and use the same method for heavy or burned on soils.

#### Do not use the following on the cooktop:

- Do not use abrasive cleaners and scouring pads, such as metal and some nylon pads. They may scratch the cooktop, making it more difficult to clean.
- Do not use harsh cleaners, such as chlorine bleach, ammonia or oven cleaners, as they may etch or discolor the cooktop.
- Do not use dirty sponges, cloths or paper towels, as they can leave soil or lint on the cooktop which can burn and cause discoloration.

### → IMPORTANT

Damage to the ceramic glass cooktop may occur if you use an abrasive type cleaning pad. Only use cleaning products that have been specifically designed for ceramic glass cooktops.



Figure 40: Cleaning products to avoid

### General Cleaning

Refer to “Cleaning Various Parts of Your Oven” on page 31 for more detailed information about cleaning specific parts of the range.

### ⚠ CAUTION

Before manually cleaning any part of the range, be sure all controls are turned off and the range is cool. The range may be hot and can cause burns.

### ⚠ CAUTION

Ammonia must be rinsed before operating the oven. Provide adequate ventilation.

### Aluminum Foil and Utensils

### ⚠ WARNING

Never cover any slots, holes, or passages in the oven bottom or cover an entire oven rack with materials such as aluminum foil or any oven liners or other materials. Aluminum foil linings may trap heat, causing a fire hazard. Protective Liners — Do not use aluminum foil to line the oven bottom. Only use aluminum foil as recommended in this manual. Improper installation of these liners may result in risk of electric shock, or fire.

- Aluminum foil - Use of aluminum foil on a hot cooktop can damage the cooktop. Do not use thin aluminum cooking utensils or allow aluminum foil to touch the surface elements under any circumstances.
- Aluminum utensils - The melting point of aluminum is much lower than that of other metals. Care must be taken when aluminum pots or pans are used on the cooktop. If aluminum pans are allowed to boil dry when using the cooktop, not only will the utensil be damaged or destroyed, but it may fuse to, break, or mark the ceramic glass surface, permanently damaging the cooktop surface.

## CARE AND CLEANING

### Removing and Replacing the Oven Door

#### **⚠ WARNING**

To prevent possible burns, do not attempt to remove door until the oven has completely cooled.

#### **To remove oven door:**

1. Open oven door completely horizontal with floor (See Figure 41).
2. Pull the door hinge locks on both left and right door hinges up from the oven frame completely towards the oven door (See Figure 42). A tool such as a small flat-blade screwdriver may be required to unlock the hinge (Figure 43).
3. Grasp both sides of oven door along the door sides. Do not use the oven door handle (See Figure 44).
4. Keep pulling the bottom of the door toward you while rotating the top of the door toward the appliance to completely disengage the hinge levers(Figure 44).

#### **To replace oven door:**

1. Firmly grasp both sides of oven door along the door sides. Do not use the oven door handle (See Figure 44).
2. Holding the oven door at the same angle as the removal position, seat the hook of the hinge arm over the roller pins located on each side of the oven door frame (See Figure 44). The hook of the hinge arms must be fully seated onto the roller pins.
3. Fully open the oven door, horizontal with floor See Figure 41).
4. Push the door hinge locks up towards and into the oven frame on both left and right oven door hinges to the locked position (See Figure 42).
5. Close the oven door.

#### **➔ IMPORTANT**

**Special door care instructions** - Most oven doors contain glass that can break. Do not close the oven door until all the oven racks are fully in place. Do not hit the glass with pots, pans, or any other object. Scratching, hitting, jarring, or stressing the glass may weaken its structure and increase risk of breakage at a later time.

#### **⚠ CAUTION**

The door is heavy. For safe, temporary storage, lay the door flat with the inside of the door facing down.

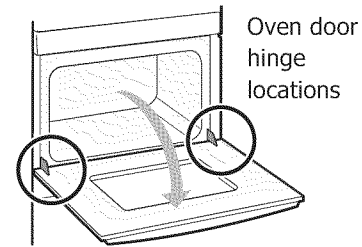

**Figure 41: Door hinge location**

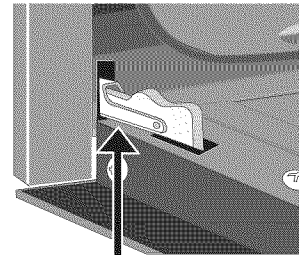

**Figure 42: Door hinge locks**

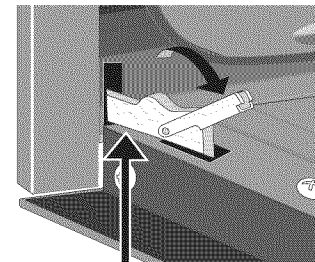

**Figure 43: Hinge in unlocked position**

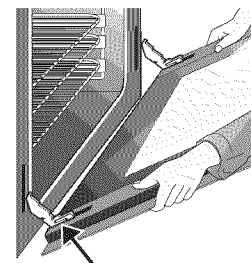

**Figure 44: Holding door for removal**

## CARE AND CLEANING

### Caring for your glide racks

Handle oven racks only when they are cool.

After cooking or after the self clean cycle, racks will be very hot and can cause burns.

#### Important Notes:

- It is recommended to remove all racks from the oven during clean cycles. After a self clean cycle, or anytime the gliding is rough, the glide racks should be treated with graphite lubrication.
- Do not use cooking oil, cooking spray, or other oil-based lubrication products on the glide rack extension tracks. Use only the graphite lubrication in this area.
- It is important that the parts of the rack that contact the oven sides always have a light coating of vegetable oil. Apply a thin layer of vegetable oil to the sides of the rack after every clean cycle and when the rack becomes difficult to reposition in the oven.

#### To lubricate the glide rack:

1. Remove the rack from the oven and place the rack on a large flat surface covered with newspaper or scrap cloth. Fully extend the rack.
2. Wipe away debris and crumbs from the glide track using a cloth or sponge.

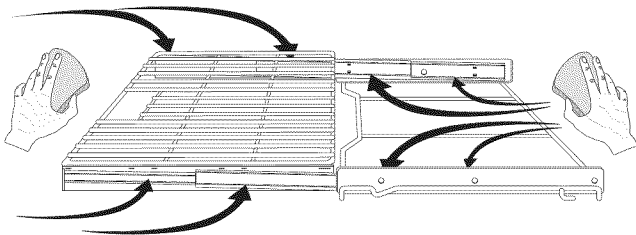

3. Shake graphite lubrication very well before applying. Place four drops of graphite lubrication along the tracks (see area circled on figure below). Repeat on both sides of the glide rack.

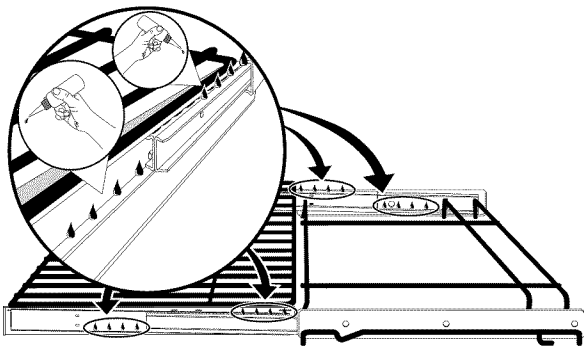

4. Extend and return the glide rack several times along the tracks to distribute the lubrication.

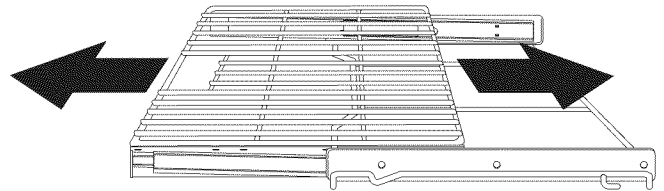

5. Turn glide rack over. Shake graphite lubrication very well before applying. Place four drops of graphite lubrication along the tracks. Repeat on both sides of the glide rack.

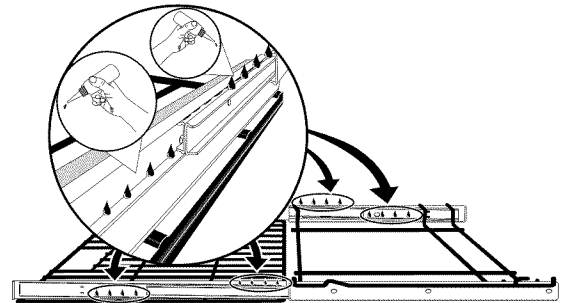

6. Extend and return the glide rack several times along the tracks to distribute the lubrication.

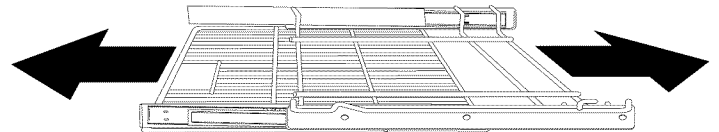

7. Apply a thin layer of cooking oil to the outer frame of the glide rack as shown below. Keeping the frame sides lightly lubricated allows the entire rack to slide easily when changing rack positions.

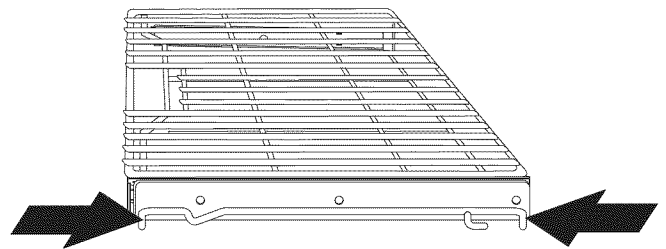

Replace rack in oven right side up.

## CARE AND CLEANING

### Replacing the oven interior light bulbs:

#### **CAUTION**

Be sure the oven is unplugged and all parts are cool before replacing oven light.

The interior oven lights are located at the rear of the oven cavity. The glass shield must be in place whenever the oven is in use (Figure 45).

1. Turn electrical power off at the main source or unplug the appliance.
2. Remove interior oven light by turning the glass cover counter-clockwise.
3. Replace bulb with a new halogen appliance bulb.
4. Replace glass oven light shield by turning the glass cover clockwise until tight.
5. Turn power back on again at the main source (or plug the appliance back in).
6. Be sure to reset the time of day on the clock.

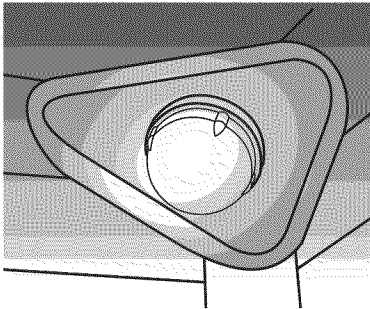
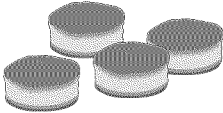
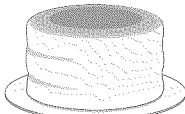
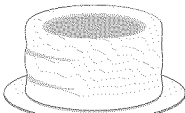
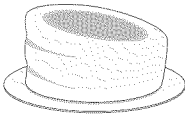



**Figure 45: Oven light protected by glass shield**

**Oven Baking**

For best cooking results, heat the oven before baking cookies, breads, cakes, pies, pastries, etc. There is no need to preheat the oven for roasting meat or baking casseroles. The cooking times and temperatures needed to bake a product may vary slightly from your previously owned appliance.

**Baking Problems and Solutions**

Baking Problems	Causes	Corrections
<p>Cookies and biscuits burn on the bottom.</p> 	<ul style="list-style-type: none"> <li>• Cookies and biscuits put into oven before preheating time is completed.</li> <li>• Oven rack is overcrowded.</li> <li>• Dark pans absorb heat too fast.</li> </ul>	<ul style="list-style-type: none"> <li>• Allow oven to preheat to desired temperature before placing food in oven.</li> <li>• Choose pan sizes that will permit 2" to 4" of air space (5.1 cm to 10.2 cm) on all sides when placed in the oven.</li> <li>• Use a medium weight baking sheet.</li> </ul>
<p>Cakes too dark on top or bottom</p> 	<ul style="list-style-type: none"> <li>• Cakes put in oven before preheating time is completed.</li> <li>• Rack position too high or too low, and oven too hot.</li> </ul>	<ul style="list-style-type: none"> <li>• Allow oven to preheat to the selected temperature before placing food in the oven.</li> <li>• Use proper rack position for baking needs.</li> <li>• Set oven temperature 25°F (13°C) lower than recommended.</li> </ul>
<p>Cakes not done in center</p> 	<ul style="list-style-type: none"> <li>• Oven too hot.</li> <li>• Incorrect pan size.</li> <li>• Pan not centered in oven.</li> <li>• Glass cookware slow heat conductor.</li> </ul>	<ul style="list-style-type: none"> <li>• Set oven temperature 25°F (13°C) lower than recommended.</li> <li>• Use pan size suggested in recipe.</li> <li>• Use proper rack position and place pan so there are 2" to 4" (5.1 cm to 10.2 cm) of space on all sides of pan.</li> <li>• Reduce temperature and increase cook time or use shiny bakeware.</li> </ul>
<p>Cakes not level.</p> 	<ul style="list-style-type: none"> <li>• Oven not level.</li> <li>• Pan too close to oven wall or rack overcrowded.</li> <li>• Pan warped.</li> <li>• Oven light left on while baking.</li> </ul>	<ul style="list-style-type: none"> <li>• Place a marked glass measuring cup filled with water on the center of the oven rack. If the water level is uneven, refer to the installation instructions for leveling the oven.</li> <li>• Do not leave oven light on while baking.</li> <li>• Use proper rack position and place pan so there are 2" to 4" (5.1 cm to 10.2 cm) of space on all sides of pan.</li> <li>• Do not use pans that are dented or warped.</li> </ul>
<p>Foods not done when cooking time is over.</p> 	<ul style="list-style-type: none"> <li>• Oven too cool.</li> <li>• Oven overcrowded.</li> <li>• Oven door opened too frequently.</li> </ul>	<ul style="list-style-type: none"> <li>• Set oven temperature 25°F (13°C) higher than suggested and bake for the recommended time.</li> <li>• Be sure to remove all pans from the oven except the ones to be used for baking. Open oven door only after shortest recommended baking time.</li> </ul>

## BEFORE YOU CALL

### Solutions to Common Problems:

Before you call for service, review the following list. It may save you time and expense. Possible solutions are provided with the problem listed:

<b>Problem</b>	<b>Solution</b>
Poor baking results.	Many factors effect baking results. Use proper oven rack position. Center food in the oven and space pans to allow air to circulate. Preheat oven to the set temperature before placing food in the oven. Try adjusting the recipe's recommended temperature or baking time. See "Adjusting the Oven Temperature" on page 27 if you feel the oven is too hot or cold.
Flames inside oven or smoking from oven vent.	Excessive spills in oven. Grease or food spilled onto oven bottom or oven cavity. Wipe up excessive spills before starting oven. If flames or excessive smoke are present when using broil, see "Using the Broil Feature" on page 23.
Oven smokes excessively when broiling.	Incorrect setting. Follow the "Using the Broil Feature" instructions on page 23. Meat too close to the broil element. Reposition broil rack to provide proper clearance between the meat and broil element. Remove excess fat from meat. Cut remaining fatty edges to prevent curling, but do not cut into lean. Grease build up on oven surfaces. Regular cleaning is necessary when broiling frequently. Grease or food splatters will cause excessive smoking.
Self clean does not work.	Oven control not set properly. See "Setting Clean" on page 29.
Oven racks discolored or do not slide easily.	Oven racks left in oven cavity during self clean. Remove oven racks from oven cavity before starting a clean cycle. Clean by using a mild abrasive cleaner following manufacturer's instructions. Rinse with clean water, dry, and replace in oven.
Oven control panel beeps and displays any F or E code error.	Oven control has detected a fault or error condition. To clear the error rotate the mode or temperature selector to an ON position then back to OFF. Once the error code is cleared, try the bake or broil function. If the F or E code error repeats, turn off the power to appliance, wait 5 minutes, and then repower appliance. Set clock with correct time of day. Try bake or broil function again. If fault recurs, press the <b>off</b> key to clear.
Areas of discoloration with metallic sheen on cooktop surface.	Mineral deposits from water and food. Remove using a ceramic cooktop cleaning cream to the ceramic surface. Buff with a non-abrasive cloth or sponge
Soil not completely removed after self clean.	Self clean was interrupted. Review instructions on "Self Cleaning" on page 28. Excessive spills on oven bottom. Clean before starting self clean. Failure to clean soil from the oven frame, the door liner outside the oven door gasket, and the small area at the front center of the oven bottom. These areas are not in the cleaning area, but get hot enough to burn on residue. Clean these areas before starting the clean cycle. Burned-on residue can be cleaned with a stiff nylon brush and water or a nylon scrubber. Be careful not to damage the oven gasket.
Oven light does not work.	Be sure the oven light is secure in the socket. See "Replacing the oven interior light bulbs:" on page 36.
Convection fan does not rotate.	Oven door is open. Convection fan will turn off if oven door is opened when convection is active. Close oven door.

## BEFORE YOU CALL

Surface element is too hot or not hot enough.	Incorrect surface control setting. Adjust power level setting.
Surface element does not heat or does not heat evenly.	Be sure the correct surface control knob is turned on for element needed. Lightweight or warped pans used. Use only flat, evenly balanced, medium or heavy-weight cookware. Flat pans heat better than warped pans. Cookware materials and weight of the material affect heating. Heavy and medium-weight pans heat evenly. Because lightweight pans heat unevenly, foods may burn easily.
Scratches or abrasions on cooktop surface.	Coarse particles such as salt or hardened soils between cooktop and utensils can cause scratches. Be sure cooktop surface and bottoms of utensils are clean before usage. Small scratches do not affect cooking and will become less visible with time. Cleaning materials not recommended for ceramic-glass cooktop have been used. Apply a ceramic cooktop cleaning cream to the ceramic surface. Buff with a non-abrasive cloth or sponge. Cookware with rough bottom was used. Use smooth, flat-bottomed cookware.
Metal marks on the cooktop.	Sliding or scraping of metal utensils on cooktop surface. Do not slide metal utensils on cooktop surface. Apply a ceramic cooktop cleaning cream to the ceramic surface. Buff with a non-abrasive cloth or sponge. For more information, see "Cooktop Maintenance (cont'd)" on page 33.
Brown streaks or specks on cooktop surface.	Boil overs are cooked onto surface. Use razor blade scraper to remove soil. For more information see "Cooktop Maintenance" on page 32.
Appliance is not level.	Be sure floor is level, strong, and stable enough to adequately support range. If floor is sagging or sloping, contact a carpenter to correct the situation. Poor installation. Place oven rack in center of oven. Place a level on the oven rack. Adjust leveling legs at base of appliance until the rack is level. Kitchen cabinet alignment may make range appear not level. Be sure cabinets are square and have sufficient room for appliance clearance.
Cannot move appliance easily. Appliance must be accessible for service.	Cabinets not square or are built in too tightly. Contact builder or installer to make appliance accessible. Carpet interferes with appliance. Provide sufficient space so appliance can be lifted over carpet.
Entire appliance does not operate.	Make sure power cord is plugged properly into outlet. Electrical power outage. Check house lights to be sure. Call your local electric company for service outage information. Service wiring is not complete. Call 1-800-4-MY-HOME® for assistance (See back cover).

# WARRANTY

Your appliance is covered by a one year limited warranty. For one year from your original date of purchase, Electrolux will pay all costs for repairing or replacing any parts of this appliance that prove to be defective in materials or workmanship when such appliance is installed, used and maintained in accordance with the provided instructions.

## Exclusions

This warranty does not cover the following:

1. Products with original serial numbers that have been removed, altered or cannot be readily determined.
2. Product that has been transferred from its original owner to another party or removed outside the USA or Canada.
3. Rust on the interior or exterior of the unit.
4. Products purchased "as-is" are not covered by this warranty.
5. Food loss due to any refrigerator or freezer failures.
6. Products used in a commercial setting.
7. Service calls which do not involve malfunction or defects in materials or workmanship, or for appliances not in ordinary household use or used other than in accordance with the provided instructions.
8. Service calls to correct the installation of your appliance or to instruct you how to use your appliance.
9. Expenses for making the appliance accessible for servicing, such as removal of trim, cupboards, shelves, etc., which are not a part of the appliance when it is shipped from the factory.
10. Service calls to repair or replace appliance light bulbs, air filters, water filters, other consumables, or knobs, handles, or other cosmetic parts.
11. Surcharges including, but not limited to, any after hour, weekend, or holiday service calls, tolls, ferry trip charges, or mileage expense for service calls to remote areas, including the state of Alaska.
12. Damages to the finish of appliance or home incurred during installation, including but not limited to floors, cabinets, walls, etc.
13. Damages caused by: services performed by unauthorized service companies; use of parts other than genuine Electrolux parts or parts obtained from persons other than authorized service companies; or external causes such as abuse, misuse, inadequate power supply, accidents, fires, or acts of God.

## DISCLAIMER OF IMPLIED WARRANTIES; LIMITATION OF REMEDIES

CUSTOMER'S SOLE AND EXCLUSIVE REMEDY UNDER THIS LIMITED WARRANTY SHALL BE PRODUCT REPAIR OR REPLACEMENT AS PROVIDED HEREIN. CLAIMS BASED ON IMPLIED WARRANTIES, INCLUDING WARRANTIES OF MERCHANTABILITY OR FITNESS FOR A PARTICULAR PURPOSE, ARE LIMITED TO ONE YEAR OR THE SHORTEST PERIOD ALLOWED BY LAW, BUT NOT LESS THAN ONE YEAR. ELECTROLUX SHALL NOT BE LIABLE FOR CONSEQUENTIAL OR INCIDENTAL DAMAGES SUCH AS PROPERTY DAMAGE AND INCIDENTAL EXPENSES RESULTING FROM ANY BREACH OF THIS WRITTEN LIMITED WARRANTY OR ANY IMPLIED WARRANTY. SOME STATES AND PROVINCES DO NOT ALLOW THE EXCLUSION OR LIMITATION OF INCIDENTAL OR CONSEQUENTIAL DAMAGES, OR LIMITATIONS ON THE DURATION OF IMPLIED WARRANTIES, SO THESE LIMITATIONS OR EXCLUSIONS MAY NOT APPLY TO YOU. THIS WRITTEN WARRANTY GIVES YOU SPECIFIC LEGAL RIGHTS. YOU MAY ALSO HAVE OTHER RIGHTS THAT VARY FROM STATE TO STATE.

## If You Need Service

Keep your receipt, delivery slip, or some other appropriate payment record to establish the warranty period should service be required. If service is performed, it is in your best interest to obtain and keep all receipts. Service under this warranty must be obtained by contacting Electrolux at the addresses or phone numbers below.

This warranty only applies in the USA and Canada. In the USA, your appliance is warranted by Electrolux Major Appliances North America, a division of Electrolux Home Products, Inc. In Canada, your appliance is warranted by Electrolux Canada Corp. Electrolux authorizes no person to change or add to any obligations under this warranty. Obligations for service and parts under this warranty must be performed by Electrolux or an authorized service company. Product features or specifications as described or illustrated are subject to change without notice.

USA  
1.800.944.9044  
Electrolux Home Products, Inc.  
10200 David Taylor Drive  
Charlotte, NC 28262



Canada  
1.800.265.8352  
Electrolux Canada Corp.  
5855 Terry Fox Way  
Mississauga, Ontario, Canada  
L5V 3E4