

en-us Use and Care Manual, Installation Instructions

**Washer**  
**WAT28401UC**



**Welcome to Your New Washer!**

Congratulations on your selection of a new Bosch washer for your laundry needs. We are confident you will enjoy the superior performance and reliability.

Please do not hesitate to contact our Customer Service department if you have any questions or comments about your new washer.

Thank you for choosing Bosch.

Visit our web site at [www.bosch-home.com/us](http://www.bosch-home.com/us) for more information and to view a selection of our products.

# Table of contents

<b>Important information</b> .....	<b>4</b>	<b>Laundry</b> .....	<b>23</b>
Purchase information .....	4	Preparing the laundry .....	23
Customer service .....	4	Sorting the Laundry .....	23
<b>Your washing machine is intended for</b> .....	<b>5</b>	Identifying and treating stains .....	23
<b>Importance and meaning of symbols</b> .....	<b>5</b>	<b>Laundry detergents and additives</b> .....	<b>24</b>
<b>IMPORTANT SAFETY INSTRUCTIONS</b> .....	<b>6</b>	Adding the correct amount of HE detergent .....	24
<b>Introduction to your new washer</b> .....	<b>7</b>	<b>Program selection table</b> .....	<b>25</b>
Standard features and helpful information .....	7	Starching .....	26
Special features .....	7	Dyeing/bleaching .....	26
Environmentally friendly use of your washer .....	8	Soaking .....	26
<b>Dimensions and clearances required</b> .....	<b>8</b>	<b>Default Program and Option settings</b> .....	<b>27</b>
Appliance dimensions .....	8	Changing the temperature range .....	27
Length of power cord and water supply hoses .....	8	Changing the spin speed range .....	27
Installation types .....	9	Finish in .....	27
<b>Installation instructions</b> .....	<b>10</b>	<b>Additional Program Option settings</b> .....	<b>27</b>
Introduction .....	10	Extra Rinse <sup>+1, +2</sup> .....	27
Tools needed .....	11	Prewash <sup>PW</sup> .....	27
Waste disposal .....	11	SpeedPerfect  .....	27
Parts provided with your washer .....	11	<b>Cleaning and maintenance</b> .....	<b>28</b>
Set up on a pedestal with drawer .....	12	Cleaning the housing and control panel .....	28
Installation checklist .....	12	Cleaning the drum .....	28
Importance of installing on a solid, level floor .....	12	Descaling the washer .....	28
Remove the transport bolts .....	12	Cleaning the detergent dispenser tray .....	28
Water connections .....	13	Cleaning the water inlet strainers .....	28
Leveling the washer .....	15	Cleaning the drain pump .....	29
Electrical connection .....	16	<b>Troubleshooting</b> .....	<b>31</b>
Transporting the washer .....	17	Emergency door lock release .....	31
<b>Getting to know your appliance</b> .....	<b>18</b>	General Troubleshooting .....	31
Control panel .....	18	Error messages .....	34
<b>Operating Instructions</b> .....	<b>19</b>	<b>Customer service</b> .....	<b>34</b>
Before doing any laundry		<b>STATEMENT OF LIMITED PRODUCT WARRANTY ...</b>	<b>35</b>
with your washing machine .....	19	What this Warranty Covers & Who it Applies to .....	35
Before loading your first load of laundry .....	19		
Using the cycle selector to choose a wash cycle .....	19		
Changing default cycle settings .....	19		
Selecting additional cycle settings .....	19		
Loading the laundry .....	19		
Filling the detergent and additives compartments .....	20		
Starting the cycle .....	21		
Child lock .....	21		
Selecting a different cycle .....	21		
Pausing/Adding a garment to the cycle .....	21		
Cancel cycle .....	21		
Cycle end .....	21		
Removing laundry/switching the appliance off .....	22		
<b>Signal</b> .....	<b>22</b>		

Additional information on products, accessories, replacement parts and services can be found at [www.bosch-home.com](http://www.bosch-home.com) and in the online shop [www.bosch-eshop.com](http://www.bosch-eshop.com)

Questions?  
1-800-944-2904  
[www.bosch-home.com](http://www.bosch-home.com)  
1901 Main Street, Suite 600  
Irvine, CA 92614

We look forward to hearing from you!

# Important information

## Purchase information

Please take a moment to record the following basic information about your new Bosch washer.

This information will be helpful in the event you need to contact Customer Service or would like to order accessories or replacement parts.

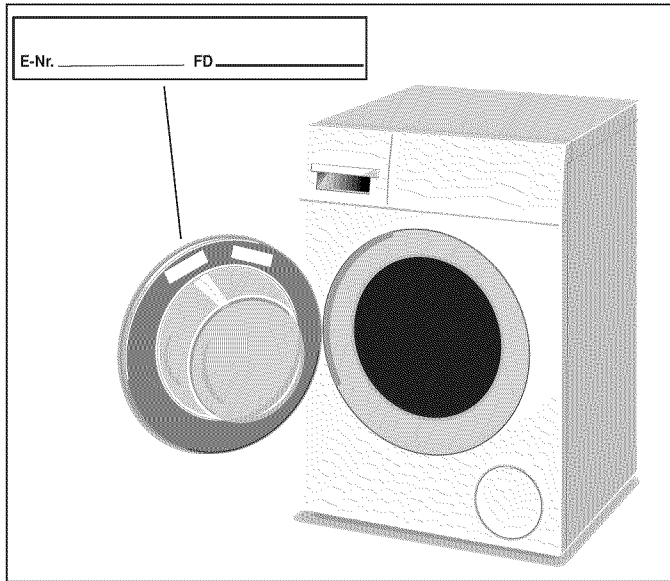

The **E-Nr.** (model number) and the **FD** (serial) number are found on the rating plate label.

*see illustration*

The model number includes the slash and a two digit number (eg: "/27"). Please be sure to include the final 2 digit number when filling in your model number. This helps make sure any parts you may need are correctly matched to your specific machine.

Date of Purchase: \_\_\_/\_\_\_/\_\_\_

Where Purchased: \_\_\_\_\_

**E-Nr.** : \_\_\_\_\_/\_\_\_\_ (ex: WFVC5330US/27)

**FD** : \_\_\_\_\_ - \_\_\_\_\_ (ex: FD 9005 | 90001)

## Customer service

Your washer does not require any special care other than the maintenance and care mentioned in this manual. If you have a problem with your washer, please consult

→ *Troubleshooting; Page 31*

This may save you money. If a technician comes out to advise you of information that is in the Troubleshooting table you may be charged, even if your washer is still under warranty.

If problems persist and service becomes necessary, contact your dealer, installer or an authorized service center. Do not attempt to repair the appliance yourself. Any work performed by unauthorized personnel may void the warranty.

If you are having a problem with your washing machine and are not pleased with the service you have received, please follow these steps:

1. Contact your installer or the Authorized Service Provider in your area and explain to them why you are not satisfied. This will usually correct the problem.
2. If after working with your installer or service technician the problem still has not been resolved to your satisfaction, please let us know either by writing to us at:

BSH Home Appliances  
1901 Main Street, Suite 600  
Irvine, CA 92614

or calling us at:  
1-800-944-2904

When writing or calling please have the following information available:

- E-Nr. (model number, example: WTVC3300UC/27)
- FD (serial) number
- Date of Original Purchase (receipt required)
- Date Problem Occurred
- Explanation of Problem

If writing, please also include a daytime telephone number and a copy of the sales invoice.

When calling Customer Service, please be ready to provide the model number **E-Nr.** and **FD** (serial) number. This information will help provide the best support for your washer.

Additional information is available at our website.

[www.bosch-home.com/us](http://www.bosch-home.com/us)

---

## Your washing machine is intended for

- Only household use and in a non-commercial environment.
- Household use only washing machine-washable textiles.
- Washing with common cold and hot (maximum 140 °F/60 °C) tap water and commercially available detergents and cleaning products suitable for use in washing machines.
- **We recommend HE (High Efficiency) detergents because they are designed to deliver optimum performance from your front-loading washer. Not using HE detergent could cause problems such as oversudsing, extended cycle periods, or a decrease in wash performance.**
- When measuring all detergents/stain removers/laundry care products be sure to follow the manufacturer's instructions.
- Children must not do any laundry without supervision.
- Keep pets away from the washer.
- Set-up conditions:  
Ambient temperature: 32-104 °F/0-40 °C  
Relative humidity: under 95%
- Installation by qualified installers.
- Installation in accordance with all regulatory requirements; if in doubt have the appliance installed by a specialist familiar with these requirements.

**NOTICE: Do not use chlorine bleach!**→ *Operating Instructions; Page 19*

Read the use and set-up instructions and all other information included with the washer and act accordingly.

Keep documents for future use.

---

## Importance and meaning of symbols

Important safety information is contained in this manual and on the warning labels located on your washer.

Standard symbols and headings are used to identify areas where you should take precautions to avoid injury or damage. Please take a moment to become familiar with each of these symbols and what they mean before proceeding.

---

### **▲ WARNING**

#### **ELECTRICAL SHOCK HAZARD**

This indicates that death or serious injuries may occur as a result of non-observance of this warning.

---

---

### **▲ CAUTION**

This indicates that minor or moderate injuries may occur as a result of non-observance of this warning.

---

**NOTICE:** This indicates that damage to the appliance or property may occur as a result of non-observance of this warning.

**Tip:** This symbol is used to draw the user's attention to important matters.

# **IMPORTANT SAFETY INSTRUCTIONS**

## READ AND SAVE THESE INSTRUCTIONS

---

### **WARNING**

When properly cared for, your new appliance has been designed to be safe and reliable. Read all instructions carefully before use. These precautions will reduce the risk of burns, electric shock, fire, and injury to persons. When using appliances, basic safety precautions must be followed, including those in the following pages.

---

Examine the appliance after unpacking it. In the event of transport damage, do not plug it in.

---

### **WARNING**

TO REDUCE THE RISK OF FIRE, ELECTRIC SHOCK, SERIOUS INJURY OR DEATH WHEN USING YOUR WASHING MACHINE, FOLLOW BASIC PRECAUTIONS INCLUDING THE FOLLOWING

- Bosch washers are provided with an Operating, Care and Installation Instruction manual. Read and understand all instructions before using the washing machine.
  - Do not wash articles that have been previously cleaned, washed, soaked, or spotted with gasoline, dry cleaning solvents, other flammable or explosive substances as they give off vapors that could ignite or explode.
  - Do not add gasoline, dry cleaning solvents, or other flammable or explosive substances to the wash water. These substances give off vapors that could ignite or explode.
  - Under certain conditions hydrogen gas may be produced in a hot water system that has not been used for 2 weeks or more. **HYDROGEN GAS IS EXPLOSIVE.** If the hot water system has not been used for this length of time, turn on all hot water faucets and let the water flow out of each faucet for several minutes before using the washing machine. This will release any accumulated hydrogen gas. As the gas is flammable, do not smoke or use an open flame while carrying out this procedure.
  - Before the appliance is removed from service or discarded, remove the door to prevent children from playing or hiding inside. Also remove the power cord/plug.
  - Do not allow anyone to climb, lean or hang on any part of the washer including any protruding components such as the appliance door or a pullout shelf.
  - Use caution when draining hot water from the washer drum such as during pump maintenance or when using the emergency door open procedure.
  - Do not reach into the appliance if the wash drum is moving.
  - Do not tamper with the controls.
  - Do not repair or replace any part of the appliance or attempt any service unless specifically recommended in the user manual or in published user repair instructions that you understand and have the skills to carry out.
- Always unplug the washing machine from the power supply before attempting any service. Disconnect the power cord by grasping the plug, not the cord.
  - Do not machine wash fiberglass materials (such as curtains and window coverings that use fiberglass materials). Small particles may remain in the washing machine and stick to fabrics in subsequent wash loads causing skin irritation.
  - Do not install or store the washer where it will be exposed to the weather. Hoses and internal parts may be damaged if exposed to freezing temperatures.
  - Do not use the washing machine if it has a worn power cord or loose plug.
  - The washing machine must only be used for its intended purpose.
  - Always follow the fabric care instructions recommended by the clothing manufacturer.
  - Make sure all water connections to the washing machine have shut-off valves that are readily accessible during normal operation of the washer. Turn off both valves during periods in which the washer is not in use and before leaving for extended periods such as vacations to reduce the risk of water damage in the event of a leak. Turn the valves back on prior to resuming use of the washer.
  - Do not operate the washing machine if parts are missing or broken.
  - Do not operate the washing machine until you are sure that:
    - the washing machine has been installed according to the Installation Instructions.
    - all water, drain, power and grounding connections are in compliance with all local regulations and/or other applicable regulations and requirements.
  - See the installation instructions in this manual for grounding requirements.

→ *Electrical connection; Page 16*

---

# **IMPORTANT SAFETY INSTRUCTIONS**

READ AND SAVE THESE INSTRUCTIONS

---

## **WARNING**

---

### WARNINGS FOR CHILDREN

- Do not allow children to play on or in the appliance. Close supervision of children is necessary when the appliance is used near children.
  - Make sure to utilize all child lock/safety features of your appliance, and be sure to turn the appliance **Off** when not in use.
  - Appliances are not intended for use by children, however when children become old enough to operate the appliance, it is the responsibility of the parents or legal guardians to ensure they are instructed in safe practices by qualified persons.
  - Keep all laundry aids (including detergents, bleach, fabric softener, etc.) out of the reach of children.
- 

---

## **WARNING**

---

### STATE OF CALIFORNIA PROPOSITION 65 WARNINGS

This product contains chemicals known to the State of California to cause cancer, birth defects or other reproductive harm.

---

### SAVE THESE INSTRUCTIONS!

Keep These Instructions for Future Reference.

In case of change of ownership, manual should be conveyed with the washer.

---

## **Introduction to your new washer**

---

### **WARNING**

---

#### RISK OF FIRE, ELECTRIC SHOCK OR INJURY

To reduce the risk of fire, electric shock or injury to persons, read the **IMPORTANT SAFETY INSTRUCTIONS** of this manual before installing or operating this appliance.

→ *IMPORTANT SAFETY INSTRUCTIONS; Page 6*

---

## **Standard features and helpful information**

### **Thank you for choosing Bosch for your laundry appliance needs.**

Please read and follow the use & care, important safety instructions and troubleshooting information contained in this manual. Please retain this manual for future reference.

#### **Standard features**

- 17.7 lb (8 kg) large drum capacity (for regular cotton loads).
- Low washing and spinning noise levels.
- Large door opening featuring magnetic lock, 180° opening angle.

#### **Quality tested**

Every Bosch washer is thoroughly tested before leaving the factory. As a result, a small amount of residual water may remain in the washer drum. We recommend running the **Drum Clean** cycle to remove this water prior to washing your first load of laundry.

→ *Before loading your first load of laundry; Page 19*

#### **Web Site**

Visit our web site at [www.bosch-home.com/us](http://www.bosch-home.com/us) for more information and to view a selection of our products.

#### **About this manual**

These operating and installation instructions may apply to more than one model of washer. Illustrations used may show details that differ from your particular model. Read your user manual. It contains valuable information about safety, installation and operation of your new appliance.

This can save you time, make it easier to correctly install and use your washer, and improve your overall satisfaction with your new appliance.

#### **Special features**

- Load adjust matches the water and power consumption to each program according to the amount of laundry sensed in the drum and the type of fabric.  
The load adjust function runs automatically to keep energy and water consumption as low as possible. The water level sensor ensures the water level is correct for the laundry and the program selected.
- The automatic unbalanced load detection system spins the laundry several times to ensure even distribution.  
If the laundry is not evenly distributed, the spin speed is reduced, or the laundry may not be spun for reasons of safety.  
In the Wool program, the spin cycle is attempted only twice in order to prevent felting.

## Environmentally friendly use of your washer

Your new Bosch washing machine is designed to use water, energy and detergent in a highly efficient way to help reduce operating costs, conserve resources and protect the environment.

- Utilize the maximum amount of laundry for the appropriate program.
- Avoid using too much detergent.
- Wash normally soiled laundry without a prewash.

- Save energy and detergent when washing lightly and normally soiled laundry.
- **Energy-saving mode:** The display panel lighting goes out after a few minutes and **Start/Pause** flashes. To activate the display, touch any button. Energy-saving mode is not activated if a program is running.
- If the laundry will be dried in a dryer afterwards, select spin speed according to the dryer manufacturer's instruction.

## Dimensions and clearances required

### Appliance dimensions

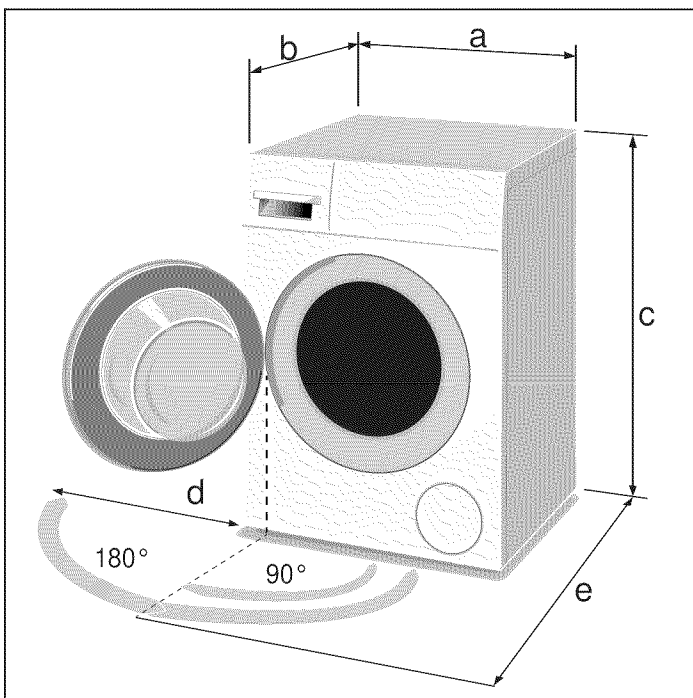

Label	Dimension	U.S.	Metric
a	width	23.6 in.	60 cm
b	depth (to front of door)	25 in.	64 cm
c	height (minimum*)	33.2 in.	85 cm
	height (maximum*)	33.8 in.	86 cm
d	side clearance (door open 180°)	15.8 in.	40 cm
e	depth (door open 90°)	42.5 in.	108 cm
Weight	approximate gross	164 lbs.	77.2 kg

\* height of appliance depends on the extension of the height adjustable appliance feet.

### Length of power cord and water supply hoses

	To left of washer*		To right of washer*	
	U.S.	Metric	U.S.	Metric
Electric power cord	25 in.	64 cm	43 in.	109 cm
Water supply hoses	43 in.	109 cm	28 in.	71 cm
Drain Hose	27 in.	69 cm	46 in.	117 cm

\* All distances are measured from indicated side when facing front of washer.



## Installation types

### Stacked washer and dryer

A Bosch dryer of the same dimensions can be placed on top of the washer to save space.

Use the special washer-dryer stacking kits (noted in Bosch Dryer User Manuals) which can be purchased from customer service or your local dealer.

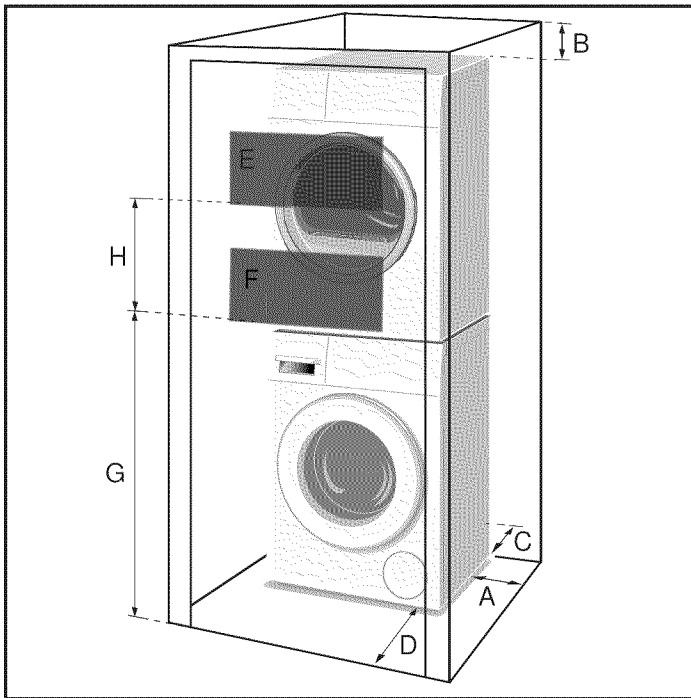

#### Clearance requirements (Minimum)

A	Both Sides	0.6 in.	1.5 cm
B	Top	6.3 in.	16 cm
C	Rear*	2.5 in.	6.4 cm
D	Front	2.4 in.	6.1 cm

\* Rear clearance as close to wall as venting or water connection will allow. If the washer is installed with a dryer, the greater rear clearance for the dryer venting is required for the laundry pair.

#### Ventilation area (Minimum)

E	Top	63 sq. in.	404 sq. cm
F	Bottom	63 sq. in.	404 sq. cm

#### Vent spacing (actual not minimum dimensions)

G	37 in.	94 cm
H	26 in.	66 cm
J	3 in.	7.6 cm
K	29 in.	73 cm

## Stand alone (shown) or Side-by-Side

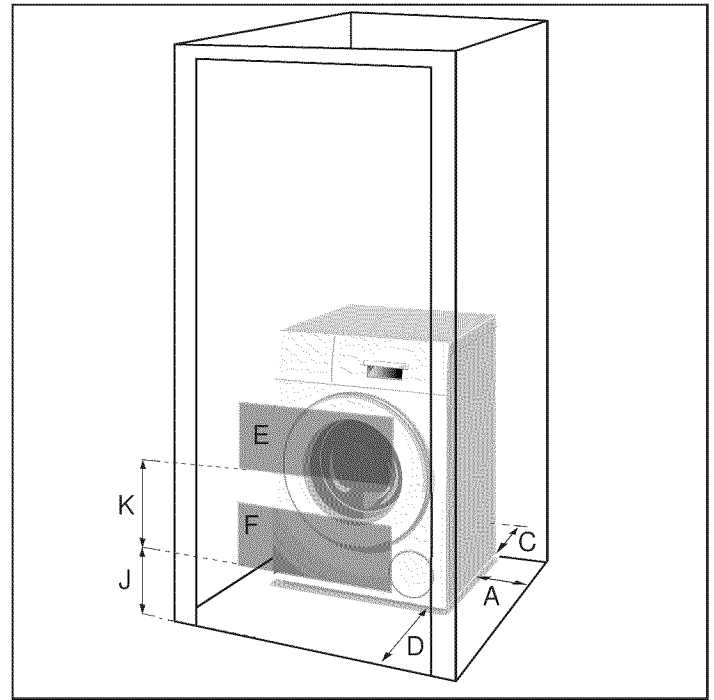

### Under counter (Preferred)

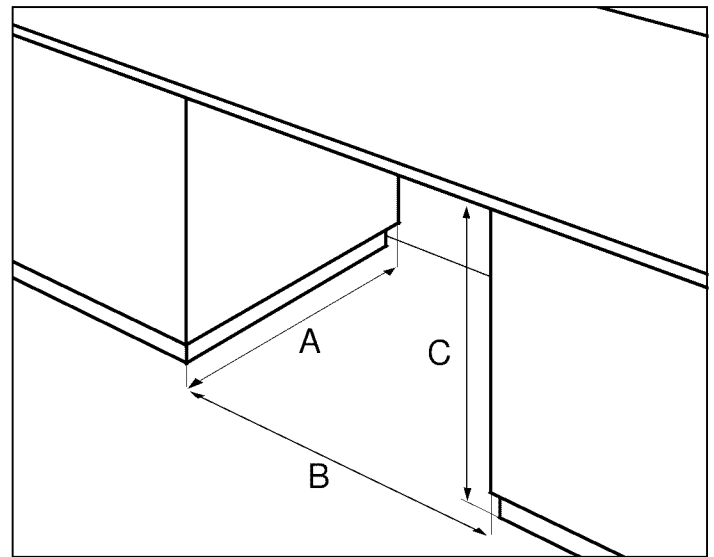

Front of the appliance fully open.  
No doors or coverings.

#### Minimum opening dimensions

A	28 in.	71.1 cm
B	23.8 in.	60.5 cm
C	35.5 in.	90.2 cm

## Under counter (Less Desirable)

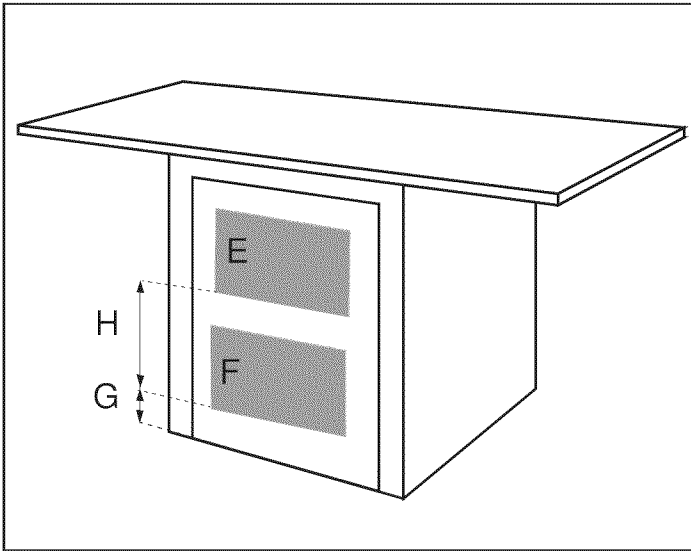

If front of the appliance is covered ventilation openings must be installed.

### E & F are minimum area sizes

E	63 sq.in.	404 sq.cm
F	63 sq.in.	404 sq.cm

### G & H actual spacing dimensions for min. open area sizes

G	3 in.	7.6 cm
H	14 in.	35.6 cm

## Installation instructions

### ▲ WARNING

RISK OF FIRE, ELECTRICAL SHOCK OR INJURY TO PERSONS

To reduce the risk of fire, electric shock or injury to persons, read the Important Safety Instructions at the front of this manual before installing or operating this appliance.

### ▲ CAUTION

WASHING MACHINE IS HEAVY  
Use additional help and care when lifting and positioning.

## Introduction

Read these installation instructions completely and carefully before starting to install your new washing machine. The information contained can save you time and effort and will help to ensure optimum performance of your new washer. Be sure to observe all warnings and cautions.

### NOTICES

- Frozen hoses can tear or burst. Do not install the washing machine outdoors or in an area exposed to freezing conditions.
- If the washing machine is located in a room which will be exposed to temperatures below freezing, or if it is located in a cabin that is being shut down for the winter, any residual water in the pump or water inlet hose(s) must be drained.
- Take care not to damage the washing machine. Do not hold on to protruding parts (e.g. door) when lifting. Do not push against the appliance door glass due to risk of damage.
- In addition to the safety information listed here, the local water and electric authorities may have special requirements that must be followed.
- If in doubt, have the appliance installed by an authorized technician.
- Hidden surfaces may have sharp edges. During service use caution when reaching inside the washer housing.

These installation instructions are intended for use by qualified installers. In addition to these instructions, the installation must comply with:

- for the United States - National Electrical Code, ANSI/NFPA70 - and latest editions of the State and municipal and/or local regulations.
- for Canada - Canadian Electrical Code C22.1 - and the latest editions of the Provincial, Municipal and/or local regulations.

## Tools needed

The following tools may be helpful during installation of your washer.

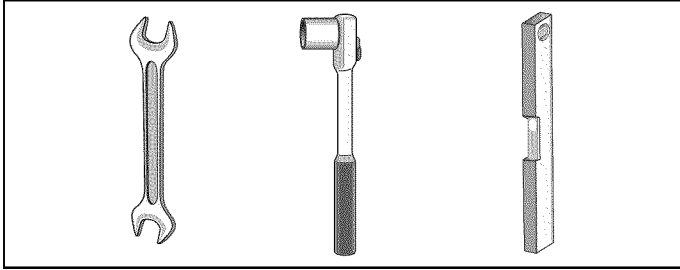

- 13mm socket for removing the transport bolts.
- 17mm wrench for adjusting the appliance feet.
- Bubble level for leveling the appliance.

## Waste disposal

### Disposal of Packaging Materials

After unpacking your new appliance dispose of the protective packaging materials in an environmentally friendly way. Ask your dealer or inquire with your local authority regarding currently acceptable means of disposal.

---

### ▲ WARNING

#### WARNINGS FOR CHILDREN

Do not let children play with packaging and associated parts to avoid risk of choking or suffocation.

---

### Disposal of Your Old Appliance

Your old appliance can be recycled if it is no longer to be used. Prior to disposing of your old appliance observe the following precautions to reduce safety risks.

---

### ▲ WARNING

#### TO AVOID RISK OF INJURY OR DEATH, DO THE FOLLOWING

- after unplugging the old appliance, remove the electric power cord and dispose of properly.
  - remove the door or permanently disable the door lock to prevent children from being locked inside.
- 

## Parts provided with your washer

Back side of the washing mashine

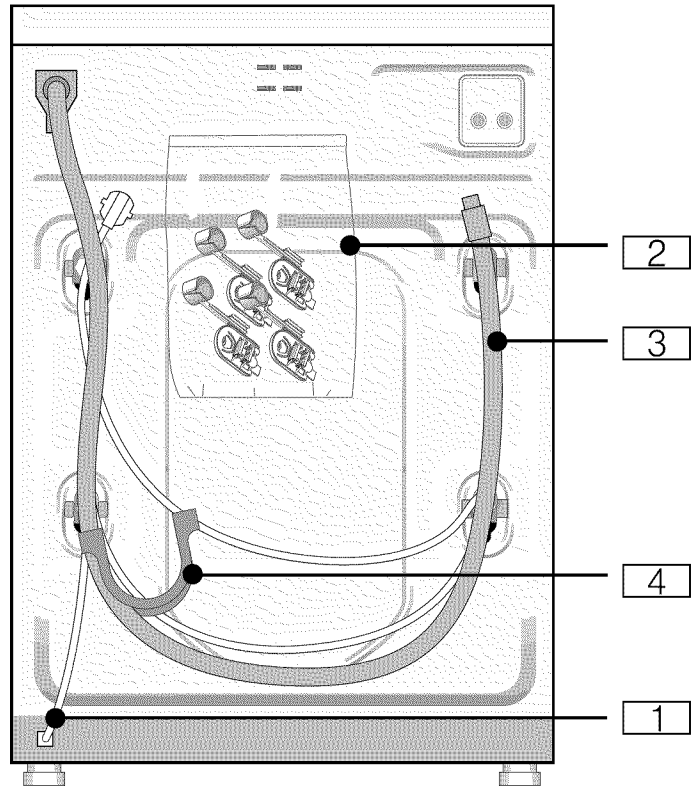

- 1 Power cord with plug
  - 2 Literature pack; contents:
    - User manual
    - Warranty
    - Covers with hose holders
  - 3 Drain hose
  - 4 Elbow to form the hose to fit the drain pipe
-

## Washer drum contents

Two AquaShield® water supply hoses are shipped in the washer drum. Be sure to remove each of these items from the drum before using the washer.

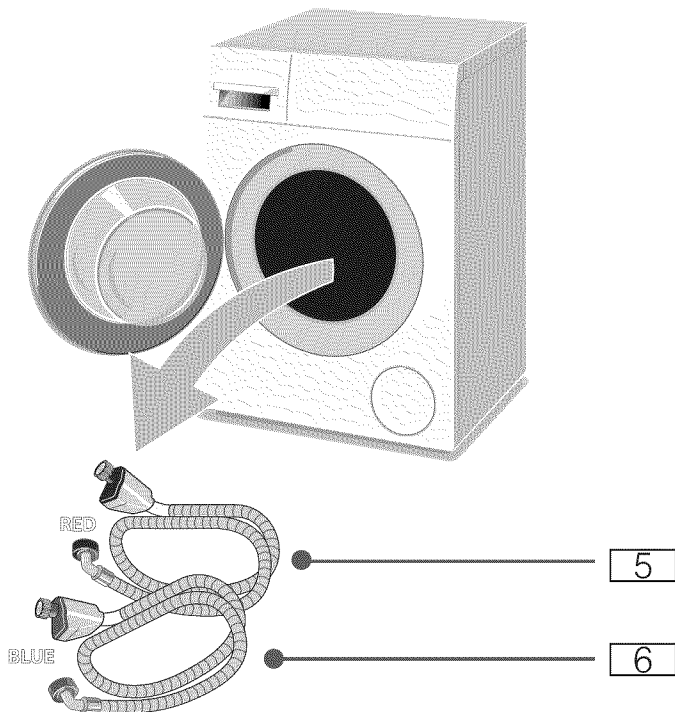

5 Hot water AquaShield® hose

6 Cold water AquaShield® hose

**NOTICE:** If any parts are missing please notify your dealer immediately.

## Set up on a pedestal with drawer

Pedestal item number: WMZ 20490

Mount washer on the pedestal according to the instructions in the installation kit.

## Installation checklist

Review the following list and check off each step as it is completed during installation.

✓ Installation Step	Page
If installing to a pedestal (base), complete the base installation before removing the transportation bolts	→ <i>Remove the transport bolts; Page 12</i>
Completely remove all four shipping bolts keeping the bolt and bushing assemblies intact	→ <i>Remove the transport bolts; Page 12</i>
Connect the water supply hose and drain hose	→ <i>Water connections; Page 13</i>
Connect the electrical power	→ <i>Electrical connection; Page 16</i>
Slide the washing machine into its final location	
Level the washing machine (as low as possible)	→ <i>Leveling the washer; Page 15</i>

✓ Installation Step	Page
Before washing laundry, run the <b>Drum Clean</b> program	→ <i>Before loading your first load of laundry; Page 19</i>

## Importance of installing on a solid, level floor

Your new Bosch washing machine utilizes high spin speeds to achieve superior water removal from your laundry resulting in reduced drying time. It is important to install your washing machine on a floor that will provide firm support. This prevents the washer from experiencing excess vibration during spinning that could cause the washer to move or be noisy.

The installation surface must be solid and level in both directions. Avoid installing your washer on soft surfaces such as floors with carpet or foam backed covering material.

If installing the washer on a wooden floor, observe the following:

- install the washer in a corner for better support if possible.
- if necessary, reinforce the floor by screwing a water resistant wooden board to the floor (minimum of 1.18 in./30 mm thick).

## Remove the transport bolts

### ▲ CAUTION

**DAMAGE TO THE APPLIANCE OR INJURY POSSIBLE**

- The machine is secured for transport with transport bolts.

Transport bolts that are not removed can damage the drum during operation of the machine, the washer will vibrate, and it will be much noisier during spin cycles if the transport bolts are not removed before use.

Be sure to remove all 4 transport bolts completely before first use. Keep the transport bolts.

If a pedestal was purchased with the washer, it must be installed first, prior to removing the transport bolts. Please consult the pedestal installation instructions.

- In order to prevent transport damage during later transport, be sure to re-install the bolts before transport.

1. Remove hoses from the brackets.

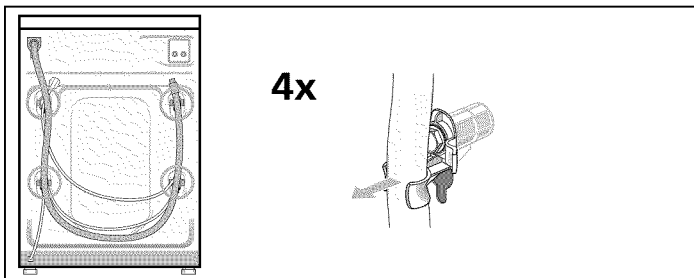

2. Loosen and remove all 4 transport bolts. Remove the sleeves. Take the power cable out of the brackets.

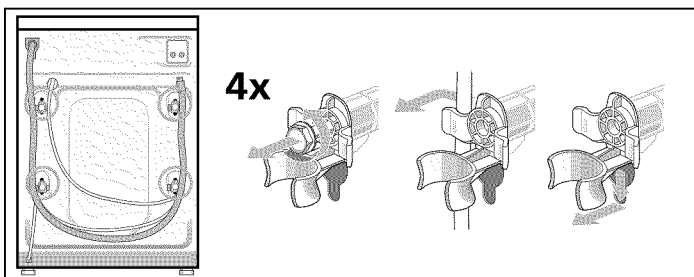

3. Place covers over the transport bolt holes. Four plastic covers are provided in the small parts bag included with your washer. Separate these covers and install one in each hole where the transport bolts were removed. Lock covers firmly by pressing on the snap hook. Insert hose holder. Secure hoses in the hose holders.

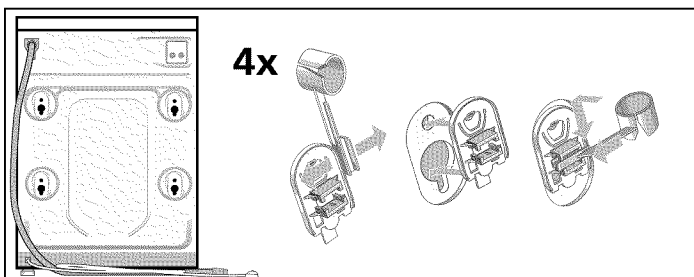

**NOTICE:** Keep the assemblies together and store them for later use such as when moving the washer.

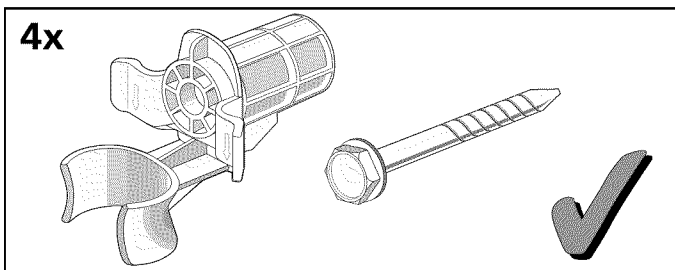

## Water connections

### Water supply hose connections

#### NOTICES

- The washing machine must only be operated with cold and hot (max. 140 °F/60 °C) tap water. Do not connect the appliance to the mixer tap of a pressurized hot-water boiler.
- To prevent water damage, the hot and cold water valves should be accessible when the washing machine is in place and should always be turned off when the washing machine is not in use.
- If installing the washing machine in a new building or a building in which the plumbing system was recently installed or upgraded, flush the lines before installing the washing machine to remove any sand, dirt or residue.
- To prevent leakage or water damage, follow the instructions in this chapter.
- If in doubt, have the appliance installed by an authorized technician.

Connect your washer to the wall faucets using the included AquaShield® water supply hose.

Observe each of the following:

- Only use the new water supply hose shipped with your washer. Never use old used hoses.
- The water supply hoses must not be kinked, bent, or pinched causing hose damage or restricting water flow.
- The water supply pressure must be between **14,5 to 145 psi (1 - 10 bar)** with a minimum of 2.2 U.S. gallons (8 liters) of flow per minute. A pressure regulator valve must be installed if the maximum water pressure is exceeded.
- Make sure the water supply faucet is easily accessible when the washer is in use. The faucet should be turned off if the washer is going to be unused for extended periods of time.
- Make sure rubber washers are in place at both ends of the water supply hose. Missing washers could cause leaks.
- The connection points are under full water pressure. Turn on the water tap and check for leaks.
- Periodically inspect the water supply hose and replace with a new hose if cuts, kinks or leaks are observed.

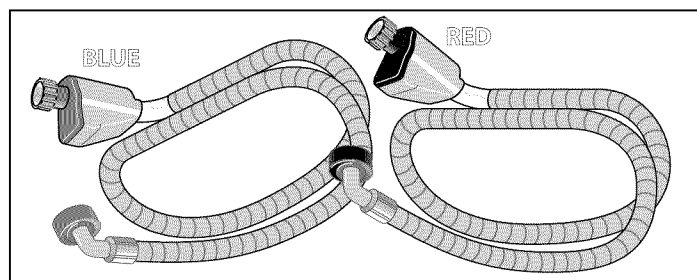

Water connection hoses

- blue - Cold water-hose
- red - Hot water-hose

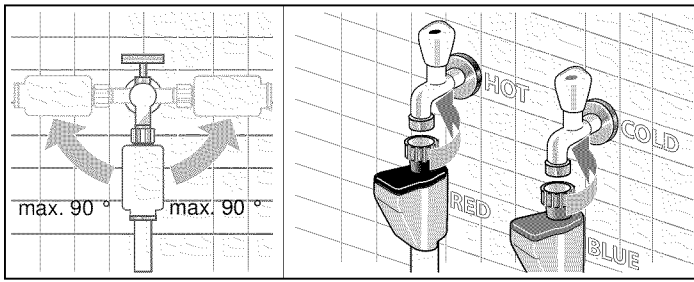

Attach this end to water tap. Hand tighten only.

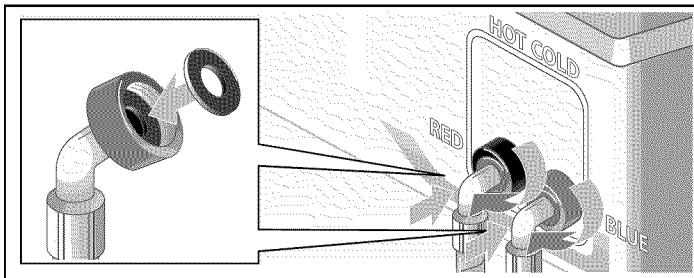

Attach this end of the hose to the back of the washing machine as shown in the following pictures. Be sure to use clamps and route hoses as instructed. Hand tighten only.

Position hoses as shown when routing hoses to right side of washer (facing from front)

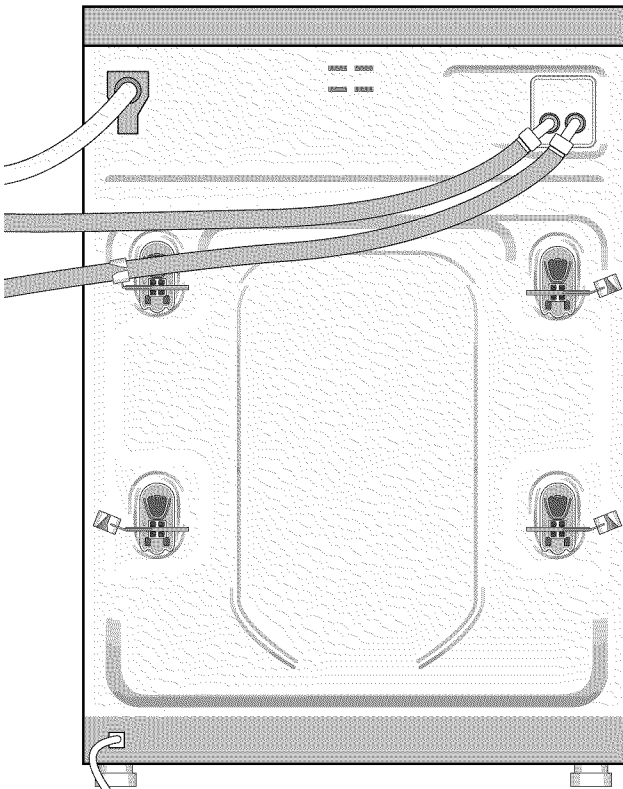

Position hoses as shown when routing hoses to left side of washer (facing from front).

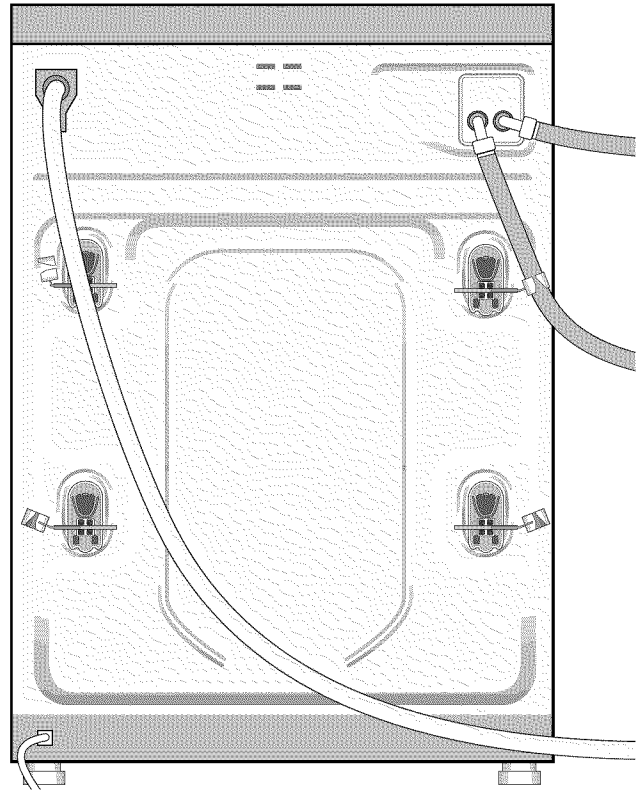

#### About the AquaShield® Hose

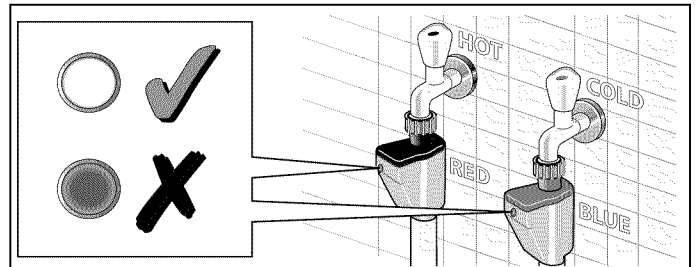

The AquaShield® hose prevents potential flooding in the event the hose develops an internal leak. If the hose leaks, the indicator turns red and water flow is blocked. Once the internal valve in the hose activates (indicator is red) the hose must be discarded. Contact customer service for a replacement.

#### Water drain hose connection

##### NOTICES

- Do not reuse an old drain hose. Only use the drain hose and parts included with your washer.
- Do not kink or modify the water drain hose.

#### Height of drain point

Height difference between the floor and drainage point: max. 39 in. (100 cm).

## Types of drainage hookups

### Standpipe

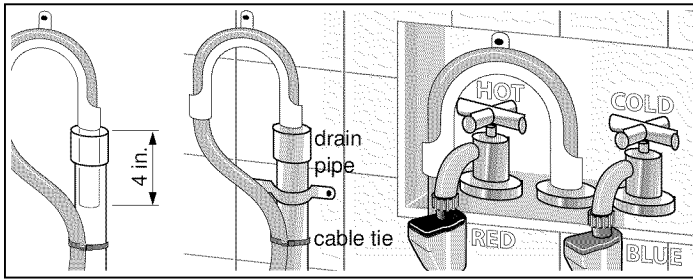

Attach the drain hose to the elbow included with your washer.

Position the elbow on the drain hose 4" from end of hose as shown. Insert this section of the drain hose into the drain pipe. Secure the elbow and hose with a nylon tie strap or the equivalent to keep the hose from coming out of the drain pipe during use.

### Sink siphon

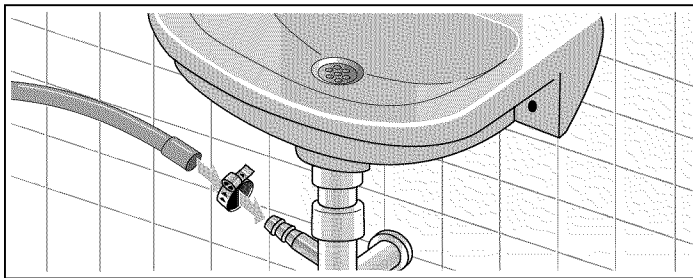

Secure the drain hose to the sink siphon using a Ø 0.9 - 1.6 in. (20-44 mm) hose clip (available from a hardware store).

### Wash Basin

#### ▲ WARNING

##### SCALDING

When washing at high temperatures, there is a risk of scalding if you touch hot suds, e.g. when pumping out hot suds into a wash basin.

Do not reach into the hot suds.

#### NOTICE: APPLIANCE DAMAGE/DAMAGE TO TEXTILES

If the end of the drain hose touches the discharge water (water drained from washer) it (the discharge water) can be sucked back into the appliance and may damage the appliance or textiles.

#### Make sure that:

- There is no stopper in the sink drain.
- The end of the hose does not touch the discharge water.
- The sink drain is free flowing and not partially clogged.

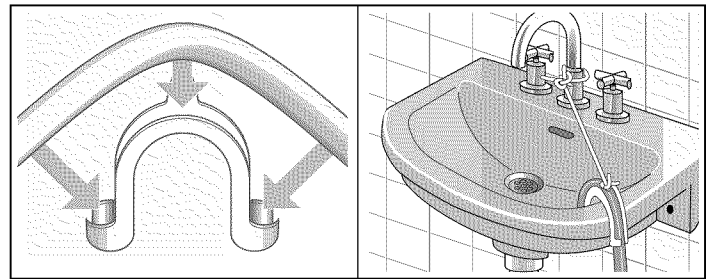

Attach the drain hose securely to the wash basin.

**NOTICE:** In any multi-story installation, the washer should be installed on a drained floor to prevent water damage to rooms below in the event of a leak.

## Leveling the washer

### Importance of leveling the washer

Your new washer uses high spin speeds to remove water at the end of the wash cycle. It is important that your washer is level and that all four washer feet press with equal pressure against the floor. This will help assure the quietest, most vibration-free use of your washer.

#### Follow these steps:

1. Install the washer on a level and solid surface, preferably in a corner of a room.
2. If the floor is uneven (or unlevel) adjust the washer feet as required to level the washer. Do not place anything under the washer feet to help level the washer.
3. Extend the washer feet no more than is necessary. The more the feet are extended, the more vibration the washer will experience. Start with the washer feet turned all the way in and adjust each foot as necessary.
4. Use a bubble level to check the top of the washer to make sure it is level side to side and front to rear.
5. Press down on each corner of the washer top to make sure the washer doesn't "wobble". There should be no "give" or movement. All four washer feet should press equally against the floor. This is just as important as the washer being level to prevent vibration.
6. When the washer is level and does not wobble, lock the washer feet in place by tightening the locknuts against the washer bottom. Be sure to do this without changing the height of the foot (hold the foot while tightening the locknut).

## Procedure for adjusting the washer feet:

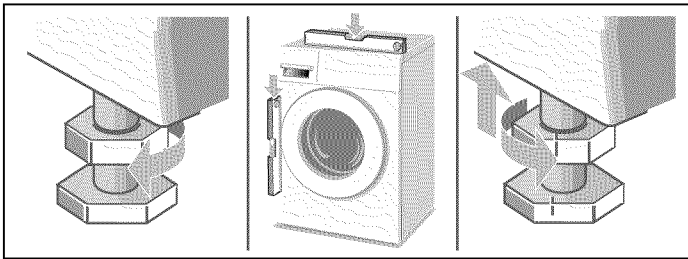

1. After determining which washer feet need to be extended, have someone lift up on the washer slightly to take pressure off the foot to be adjusted.
2. Turn the grey plastic foot to extend it downward as far as necessary to raise the corner of the washer the correct amount to level the washer.
3. When the height of the foot is correct, use a 17 mm open end wrench to tighten the locknut against the washer bottom. The locknut should be tight against the bottom of the washer to lock the foot in place.

## Electrical connection

### ⚠ WARNING

#### ELECTRICAL SHOCK HAZARD

Improper connection of the equipment-grounding conductor may result in electric shock. Have the appliance checked by a qualified technician or licensed electrician if you are in doubt as to whether the washer has been properly grounded.

### ⚠ WARNING

#### ELECTRICAL SHOCK HAZARD

To reduce the risk of fire or electrical shock, DO NOT use an extension cord or an adapter to connect the washing machine to the power supply.

### ⚠ WARNING

#### ELECTRICAL SHOCK HAZARD

To reduce the risk of electrical shock:

- Only pull out the power cord by the plug end and never by the cable, as this could damage it.
- Never touch or hold the plug end or power cord with wet hands.
- Never unplug the plug end or power cord during operation.

## Grounding Instructions

### ⚠ WARNING

#### ELECTRICAL SHOCK HAZARD

This appliance must be grounded. In the event of malfunction or breakdown, grounding will reduce the risk of electric shock by providing a path of least resistance for the electric current. This appliance is equipped with a cord that has an equipment grounding conductor and a grounding plug. The plug must be plugged into an appropriate outlet that is properly installed and grounded in accordance with all local codes and ordinances.

- Do not modify the plug provided with the appliance. If the plug will not fit into the outlet have a properly grounded outlet installed by a qualified electrician. Do not cut, remove or bypass the grounding prong on the washer power cord plug.
- The washer power cord plug must be easily accessible when the washer is operating.
- When unplugging or plugging in the washer power cord, grasp the plug end. Do not pull on the cable to unplug the washer.
- The household electrical supply must be suitable for the voltage specification shown on the washer rating plate (located inside the washer door, immediately below the drum opening).  
→ *Purchase information; Page 4*  
See the table below for connection specifications and fuse/breaker requirements.

Volts	Hertz	Ampers	Watts
240	60	12	2.880 max.



- The wiring for the electrical outlet circuit must be sufficient to meet the appliance requirements. Use of a Ground Fault Circuit Interrupter (GFCI) is recommended.
- Protect the power cord from physical damage, such as being twisted, kinked, pinched, caught in a door, or walked upon.
- If the power cord is damaged, it must be replaced by a qualified technician to avoid a fire/shock hazard. Replacement power cords can be purchased through Customer Service.  
→ *Customer service; Page 4*
- The washing machine must only be connected to an individual branch circuit via a socket which has been properly installed and grounded.
- Make sure that:
  - the power plug fits into the socket
  - the wire size is sufficient
  - the grounding system is properly installed
- The power cord may be replaced by an electrician only. Replacement power cords can be purchased from Customer Service. To reduce the risk of fire or electrical shock, DO NOT use an extension cord or an adapter to connect the washing machine to the power supply. If a ground fault circuit breaker is to be used, only use the types marked with the following symbol: . Only this symbol can guarantee compliance with all current regulations.

## Transporting the washer

### Before transporting the washer

1. Disconnect the washer power cord from the wall outlet.
2. Turn off the water supply to the washer.
3. Disconnect water supply lines from the tap.
4. Disconnect the drain hose from the drain location.
5. Install the transport bolt assemblies as shown in the following images.

### Remove the transport bolt hole covers

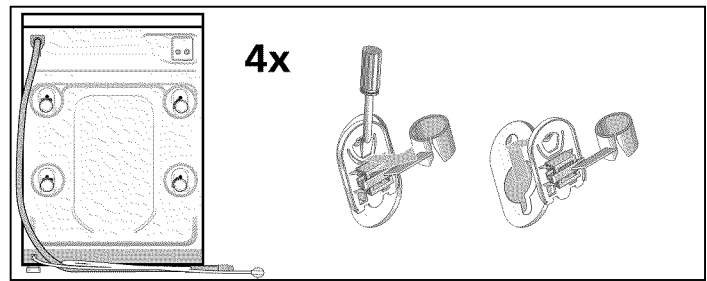

1. Remove all four transport bolt hole covers.
2. Pull the tip of the arrow on the cover out slightly to disengage the locking tab.
3. Rotate the cover counterclockwise to remove. Repeat for all 4 transport bolt hole covers.

### Insert the transport bolt assemblies

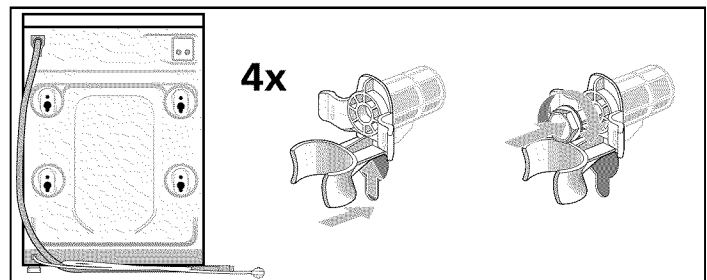

1. Each assembly consists of a plastic bushing and a bolt that extends through the bushings. Unscrew the bolt until the threaded end is flush with the end of the plastic bushing.
2. Insert the transportation bolt and bushing assembly as shown. The metal housing slides around the bolt through the slot in the plastic bushing as the bushing is slid into place. The open part of the bushing slot should be facing the direction shown to allow the assembly to slide fully into place.
3. When the bolt is in place screw it in until the bolt threads engage the drum. Double check and ensure bolts are screwed into threaded holes and not into cracks or crevices. Repeat the process for all 4 transportation bolt assemblies before tightening any all the way. Complete tightening all 4 bolt assemblies until they are each snug in place.

# Getting to know your appliance

## Control panel

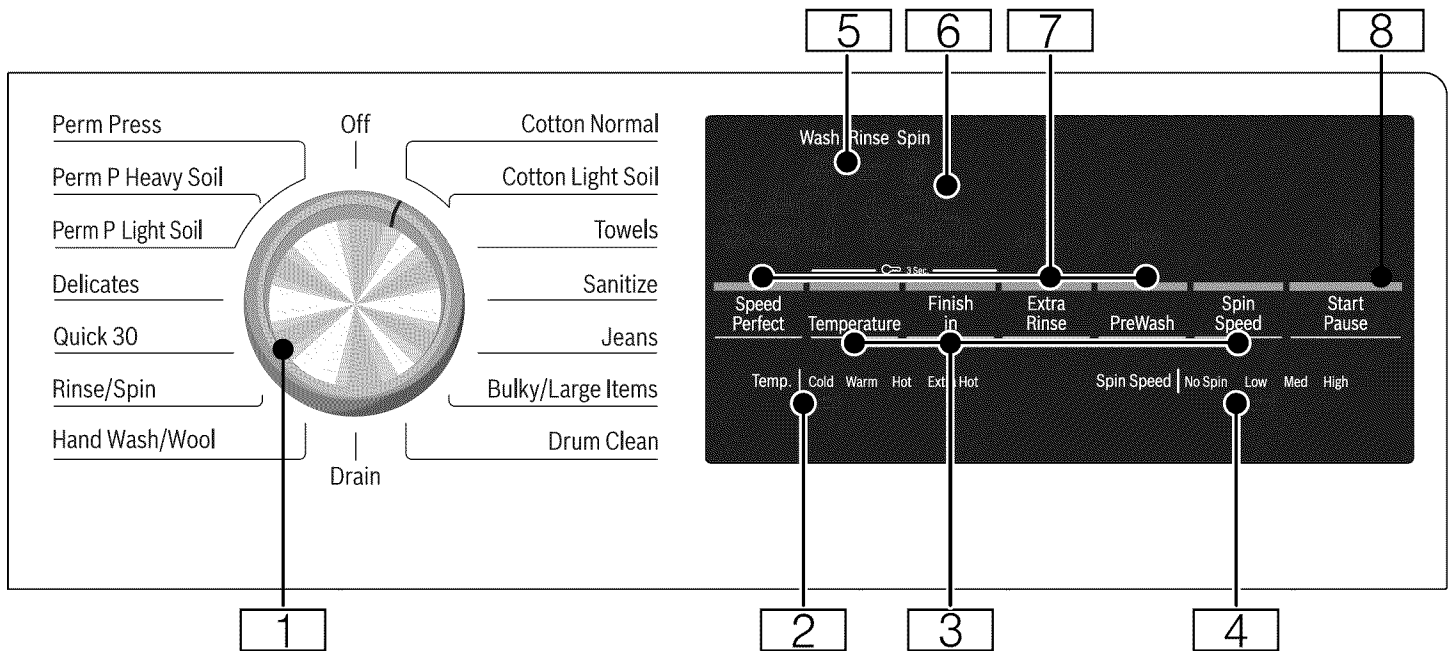

### 1 Program Selector

for selecting a program and on/off switch; turns in both directions.

### 2 Selectable temperature ranges

Cold, Warm, Hot, Extra Hot

### 3 Temperature, Finish in, Spin Speed

To change the default program settings. Indicator lamp lights up if the setting is active.

### 4 Selectable Spin Speed ranges

No Spin, Low, Med, High

### 5 Program status sequence

- Wash 🧺
- Rinse 🚿
- Spin 🌀

### 6 4 Digit Display

for settings and information

- Finish time  
adjustable in 1h (hour) steps to 24 hours
- program duration  
e.g. 2:40 (hours:minutes)

### 7 SpeedPerfect , Prewash <sup>PW</sup>, Extra Rinse <sup>+1, +2</sup>

Additional program settings. Indicator on = setting is active.

### 8 Start/Pause

- starts or pauses the selected program
- lit steady - program running, can be paused
- blinking - Options can be changed; program can be started; door is locked (water may be hot); program is in Pause mode

---

# Operating Instructions

---

## ▲ WARNING

To reduce the risk of fire, electric shock, or injury to persons, read the Important Safety Instructions and Operating Instructions before operating this appliance.

---

## Before doing any laundry with your washing machine

Check to make sure your washer has been installed properly by following the installation instructions in this manual.

→ *Installation instructions; Page 10*

Check the machine. Never connect the utilities (power or water) to or start a damaged machine! Contact customer service!

Check to be sure your household electrical system voltage and the voltage specifications on the washing machine rating plate correspond.

Check to be sure the washer hot and cold water supply taps are turned on.

## Turning the washing machine on and off

The rotating Cycle Selector turns the washer on as wash cycles are selected and off when the selector is later turned to the vertical **Off** position.

## Before loading your first load of laundry

Your new washing machine was tested before leaving the factory. This process involves running various wash cycles. As a result, a small amount of water may remain in the tub and drainage system. Run a **Drum Clean** cycle with no laundry to clean the system before your first load of laundry.

First add 1 to 2 tablespoons of detergent to the main-wash chamber II. Then run the **Drum Clean** cycle.

Wait for the cycle to finish.

## Using the cycle selector to choose a wash cycle

**NOTICE:** If the child lock feature is activated, you must deactivate it before you can set a cycle.

→ *Child lock; Page 21*

Use the cycle selector to select the desired cycle. Turns in both directions.

The machine is switched on.

In the display field, the cycle duration for the selected cycle appears and the indicator lamps for the pre-set temperature and spin speed options light up.

## Changing default cycle settings

You can use the default settings or change them to your desired settings.

Touch the appropriate button until the desired setting is displayed.

The settings or options are active when the related indicator is lit. There is no need for additional confirmation on your part. The settings or options are not retained after the appliance is switched off (all are set back to default automatically).

→ *Program selection table; Page 25*

→ *Default Program and Option settings; Page 27*

## Selecting additional cycle settings

By selecting additional settings, you can adjust the washing process to better suit the items you are washing.

The settings can be selected and deselected depending on the cycle progress.

The indicator lamps of the buttons light up if the setting is active.

The settings are not retained after the appliance is switched off.

## Loading the laundry

---

## ▲ WARNING

To avoid risk of explosion! Laundry items that have been pretreated with any material containing solvents (e.g. stain remover, cleaner's solvent) must be rinsed out thoroughly by hand before they are placed in the washing machine.

---

## Loosen the laundry being loaded and mix small and large items

Unfold the sorted items and place them loosely in the drum. Mix small and large items to help them better distribute in the drum during the spin cycle.

**Tip:** Do not exceed the maximum load recommended for the type of wash. Overloading will cause poor wash results and will cause wrinkles.

## Recommended Load Size

Recommended maximum load size can be found:  
 → *Standard features and helpful information; Page 7*

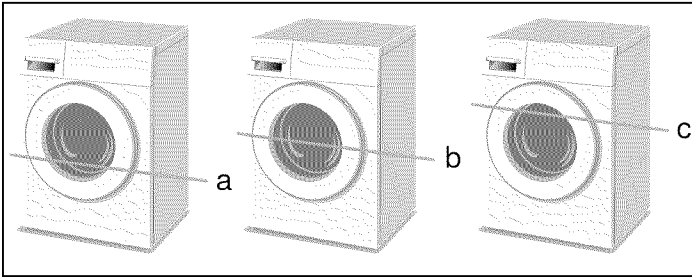

- a **1/3 Load** - woolens, delicates, silk
- b **1/2 Load** - cotton, synthetic fabrics, or knitted textiles
- c **Full Load** - cotton and linen

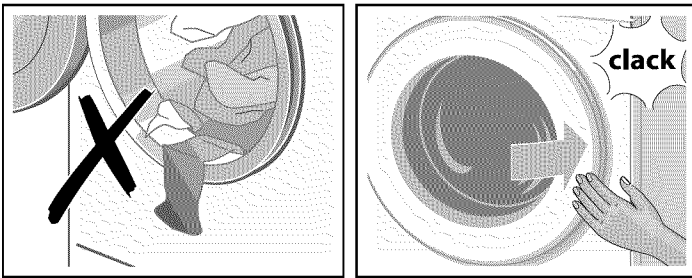

## Tips

After loading, close the door carefully so as not to trap any items between the door and the rubber seal. The door should close easily and should not be forced to close.

Foreign objects left in the drum may damage laundry. Before inserting any laundry, check to make sure no foreign objects are in the drum.

## Filling the detergent and additives compartments

**NOTICE:** Damage to the appliance  
 Detergent and laundry pre-treatment aids (e.g. spot remover, pre-wash sprays, etc.) can cause damage if they come into contact with the surfaces of the washer. Do not let these substances touch the surfaces of the washer. If necessary, wipe off spray traces and other traces/drops immediately with a soft cloth.

### Measuring

Measure out the detergent and laundry care products according to:

- the water hardness; consult your water utility company for details
- the manufacturer's instructions on the packaging
- quantity of laundry
- amount of soiling (heavy, normal, light)

## Filling

### ⚠ WARNING

#### IRRITATION OF EYES/SKIN!

When opening the detergent drawer during operation, detergent or laundry care products may spray out.

Open the drawer carefully.

In case of contact with detergent or laundry care products, rinse the eyes or skin thoroughly.

In case of accidental ingestion, consult a doctor.

**NOTICE:** To prevent build up and possible clogging of water ways, dilute thick fabric softener or other laundry care products with water.

Pour the detergent and laundry care product into the appropriate chambers:

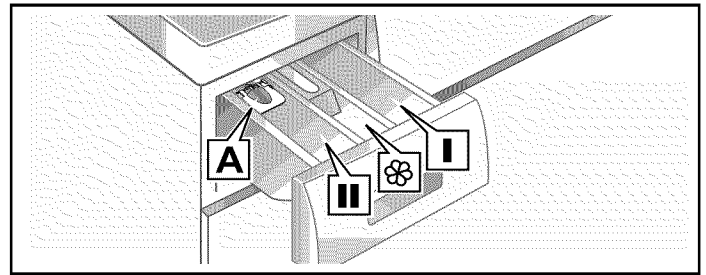

Liquid detergent insert A	for liquid detergent
Pre-wash chamber I	Detergent for pre-wash
Softener chamber	Fabric softener, starch Do not exceed max
Main-wash chamber II	Detergent for main wash, water softener, spot remover,

### Tips

Do not pour fabric softener directly into the wash load.

Fabric softener is automatically dispensed during the last rinse cycle.

Dilute concentrated or thick fabric softener or fabric conditioner with water (2/3's water) before pouring it into the dispenser (prevents blockage of overflow).

**NOTICE:** Do not use Chlorine based or color safe bleaches as these could damage the washer. Detergents and/or solid bleaching agents based on Oxygen (like Sodium Percarbonate) are safe to use.

1. Open the detergent dispenser tray.
2. Add detergent or additive.
3. Avoid overfilling the compartment to prevent early dispensing.
4. Close the detergent dispenser tray completely before starting the wash cycle.

**Tip:** DO NOT operate the washer without the detergent compartment in place and fully closed.

### Liquid detergent insert

To measure liquid detergent:

1. Pull out the detergent dispenser tray. Press down on the insert and remove the drawer completely.
2. Push the liquid detergent insert forward and down as shown.
3. Reinsert the tray into its compartment.

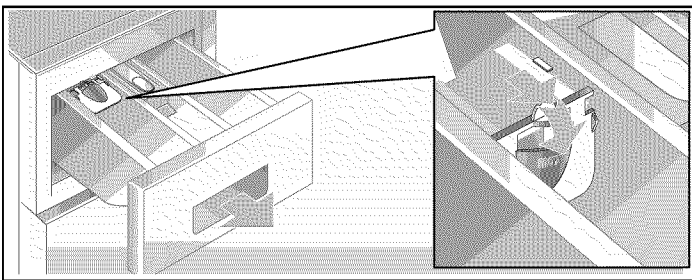

**NOTICE:** Do not use the liquid detergent insert with gel-type detergents and powdered detergents or for cycles with pre-wash and selected "Finish in" time.

### Starting the cycle

Touch the **Start/Pause** button. Indicator lamp lights up and the cycle starts.

**NOTICE:** If you want to protect the cycle against inadvertent adjustment, select the child lock.



→ *Child lock; Page 21*

During the cycle, the display field indicates the "Finish at" time and, after starting the washing cycle, the cycle duration and the symbols for the cycle progress.

### Child lock

You can secure the washer against inadvertent changing of the set functions. To do this, activate the child lock after cycle start.

To **Activate/Deactivate**, touch and hold Temperature and Finish in buttons for approximately 3 seconds. The  symbol appears in the display.

-  lit steady: The child lock is active.
-  blinking: The child lock is active and the cycle selector has been adjusted. To prevent a cycle interruption, set the cycle selector back to the initial cycle. The symbol lights up again.

**NOTICE:** The child lock can remain activated until the next cycle start even after switching the machine off.

Then you must deactivate the child lock before cycle start and if necessary activate it again after cycle start.

### Selecting a different cycle

If you have inadvertently started the wrong cycle, you can change this as follows:

1. Touch **Start/Pause**.
2. Select another cycle.
3. Touch **Start/Pause**. The new cycle starts from the beginning.

### Pausing/Adding a garment to the cycle

Pausing the wash cycle can be useful for several purposes.

e.g. for soaking → *Soaking; Page 26*

Touch **Start/Pause**.  appears on the display. Wash load will soak in water until continued by touching **Start/Pause**.

#### For adding a garment after the cycle begins.

1. Touch **Start/Pause**.
2. Open door carefully and add or remove laundry item.

**Note:** You can do this as long as the **Start/Pause** indicator flashes and it is safe to do so.

3. Close door.
4. Touch **Start/Pause**.  
The cycle continues.

**NOTICE:** If the cycle is paused but the door will not unlock it could be for safety reasons (high water level, water temperature or drum speed).

### Cancel cycle

For cycles with a high temperature:

1. Touch **Start/Pause**.
2. Cool the laundry off: Select **Rinse**.
3. Touch **Start/Pause**.

For cycles with a low temperature:

1. Touch **Start/Pause**.
2. Select **Drain**.
3. Touch **Start/Pause**.

### Cycle end

**End** appears in the display field and the Start/Pause button indicator lamp is off.

If this symbol  appears in the display, the washer has detected too much foam and it automatically adds an additional rinse to remove the foam.

**NOTICE:** Use less detergent the next time you run the washer with the same load.

## Removing laundry/switching the appliance off

1. Open the front door of the washer and remove the laundry.
2. Turn the cycle selector to the **Off** position. Appliance is switched off.
3. Turn off the water tap.

### NOTICES

- Do not leave any laundry in the drum. It can shrink or become discolored by the next laundry.

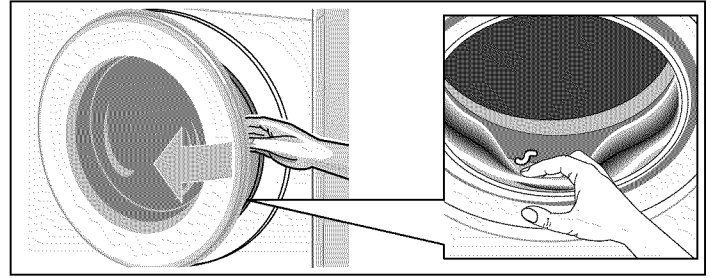

- Remove any remaining items from the drum and rubber gasket.
- Leave the front door and detergent drawer open so that any remaining water can dry.
- Always wait for the end of the cycle; otherwise the appliance may still be locked. If locked, switch the appliance on and wait until it unlocks.
- If at the end of the cycle the display is not lit up, the energy saving mode is active. To see display, press any button.

## Signal

You can change the following settings:

- volume for button signals
- volume for indicator signals

To change these settings always activate adjustment mode first.

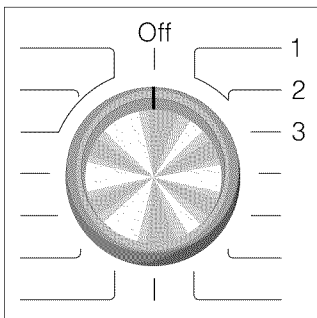

### Activate adjustment mode

1. Select **Cotton Normal** on Position 1.  
The appliance is on.
2. Hold down **Start Pause** and turn the Program Selector to the right (Position 2). Release **Start Pause** button.  
Adjustment mode is now activated and the default volume for indicator signals appears in the display.

### Changing the volume

You can set the volume by touching the **Finish in** button with the program selector in one of the following positions:

- Position 2: for indicator volume
- Position 3: for button signals volume



0 = off, 1 = soft,  
2 = mid, 3 = loud,  
4 = very loud

### Quit adjustment mode

Turn the Cycle Selector to **Off** position. The settings were saved.

# Laundry

## Preparing the laundry

**NOTICE:** Damage to the appliance/fabrics  
Foreign objects (e.g. coins, paper-clips, needles, nails) may damage the laundry or components in the washing machine.

Therefore, note the following tips when preparing your laundry:

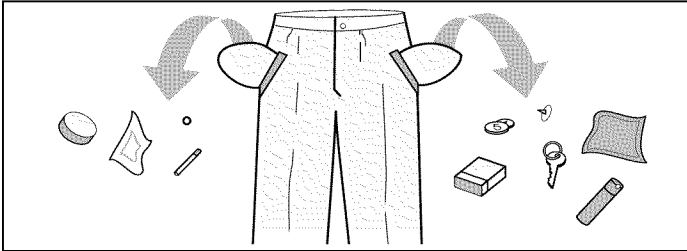

- Empty all pockets to ensure no loose debris (coins, keys, other hard objects) are placed in the washer drum.
- Close any fasteners (such as zippers and hooks) that could cause laundry to catch or become entangled.
- Remove any foreign objects or non-washable parts.
- Turn trousers and knitted wear inside out prior to washing.
- Place small items (such as socks and handkerchiefs) and underwired bras into a mesh bag prior to washing.

## Sorting the Laundry

Sort laundry items according to color, degree of soiling and recommended wash temperature range.

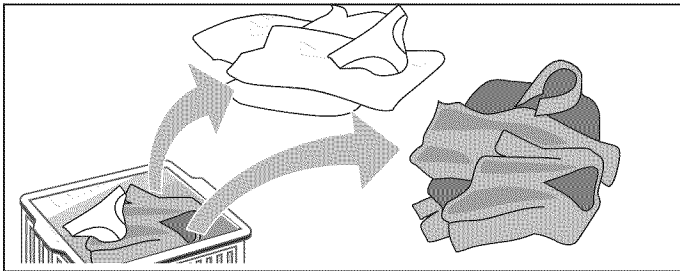

Wash white items separately from colored items. Otherwise, white items may tend to become grey.

## Observe laundry care labels

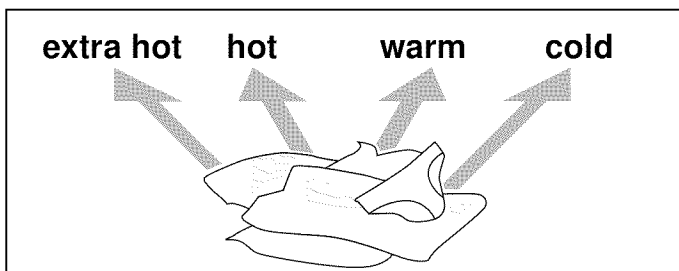

Check the care labels on each laundry item prior to washing. Choose an appropriate wash cycle that does not exceed the temperature recommended.

## Determining degree of soiling

### • Light soiling

No visible soiling or stains, but may have absorbed some body odor. This could include light weight summer clothing such as T-shirts, shirts, or blouses worn for only one day. Also to freshen bed linen or guest towels.

### • Normal soiling

Visible soiling and/or a few light stains. This could include clothing such as T-shirts, shirts, or blouses that have been sweated in or worn several times. Also tea towels, hand towels or bed linen used for up to one week. Net curtains (without nicotine stains) that have not been washed for up to a half year.

### • Heavy soiling

Visible soiling and stains. This could include kitchen towels, fabric napkins, baby bibs, children's outer clothing or football jerseys and shorts stained with grass and/or earth. Also could include working clothes such as overalls and jeans and other clothing worn for outside work and activities such as gardening, home and yard maintenance or worn during sports activities.

## Identifying and treating stains

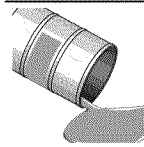

Oils and grease: normal body skin oil, cooking oils/fats, sauces, mineral oil, or wax (containing fat/oil). Treatment: scrape residue from fabric. Pretreat. Wash using hottest water safe for the fabric. For heavy stains, apply non-flammable dry cleaning fluid to back of stain, replacing towels under stain frequently. Rinse thoroughly and wash using hottest water safe for the fabric.



Beverages and juices: tea, coffee, red wine, fruit, vegetables. Treatment: Pretreat stain. Wash using cold water.



Proteins and carbohydrates: blood, egg, milk, starch. Treatment: Rinse immediately in cold water. If stain remains, soak in cold water with an enzyme prewash.



Soot, earth, sand (pigments), red clay (such as soiling of tennis clothing). Brush off residue if present. Pretreat or soak with a laundry product containing enzymes.

## Removing stains

- Remove/pretreat stains as soon as possible after they have occurred.
- Dab with a soapy solution. Do not rub.
- Select an appropriate wash cycle and wash the item. Several washing cycles may be required in order to remove stubborn or dried-in stains.

# Laundry detergents and additives

## Adding the correct amount of HE detergent

### ⚠ WARNING

To avoid risk of poisoning, keep detergents and cleaning products out of the reach of children.

Avoid overuse of detergent.

Measure out the detergent according to:

- The amount of laundry.  
→ *Sorting the Laundry; Page 23*
- The degree of soiling.
- The water hardness. This information can be obtained from your local water authority. Soft water requires less detergent.

### Too much detergent

- Excessive foam will reduce washing agitation and cause poor washing and rinsing results.
- Not environmentally compatible (wastes detergent and is not good for the environment).

### Too little detergent

- Laundry will not be washed clean.
- Eventually the laundry will take on a grey and hard appearance. Greyish-brown grease spots may stain the laundry, heating elements may begin to calcify.

The fabric care label is important for selecting the correct detergent, temperature and treatment of the laundry.

If desired you can visit the following sites for additional information on detergents and fabric care.

→ [www.textileaffairs.com](http://www.textileaffairs.com) or [www.cleanright.eu](http://www.cleanright.eu)

- **Standard detergent with optical brighteners**  
Suitable for white laundry made from linen or cotton  
Program: Cottons / Cold - Extra hot
- **Detergent for colors without bleach or optical brighteners**  
Suitable for colored laundry made from linen or cotton  
Program: Cottons / Cold - Hot
- **Detergent for colors/delicates without optical brighteners**  
Suitable for colored laundry made from easy-care and synthetic fabrics.  
Program: Easy-Care / Cold - Hot

- **Detergent for delicates**

Suitable for delicate, fine fabrics, silk or viscose  
Program: Delicate/Silk / Cold - Hot

- **Detergent for woolens**

Suitable for wool  
Wool program: Cold - Warm

## Saving energy and reduce detergent

For light and normal soiling, you can save energy (lower washing temperature) and detergent.

Saving	Soiling/note
Reduced temperature and detergent quantity as per the recommended dosage	<b>Light</b> e.g.: <ul style="list-style-type: none"><li>• Light summer/sports clothing (worn for a few hours)</li><li>• T-shirts, shirts, blouses (worn for up to one day)</li><li>• Guest bed linen and hand towels (used for one day)</li></ul> No visible dirt or stains. Clothing has taken on some body odor.
Temperature as per the care label and detergent quantity as per the recommended dosage for heavy soiling	<b>Normal</b> e.g.: <ul style="list-style-type: none"><li>• T-shirts, shirts, blouses (sweat soaked, worn a few times)</li><li>• Towels, bedding (used for up to one week)</li></ul> Visible dirt or a few light stains.
	<b>Heavy</b> Dirt and/or stains clearly visible, e.g. tea towels, baby items, work clothing

**NOTICE:** When measuring the amount of all detergents/additives/care products and cleaning agents, please always check the manufacturer's instructions and information.



# Program selection table

Programs	Max. Load up to:	Selectable program settings, default settings (bold)		Type of laundry	Additional program settings ; Information
		Temperature	Spin speed		
<b>Cotton Normal</b>	full load	Extra hot Hot <b>Warm</b> Cold	<b>High</b>	Sturdy fabric, cotton or linen fabric that withstands very hot water	SpeedPerfect, Prewash, Extra Rinse +1, +2
<b>Cotton Light Soil</b>	1/2 load	Extra hot Hot <b>Warm</b> Cold	<b>High</b> Med Low No spin	Half load or less of lightly soiled sturdy fabric, cotton or linen fabric that withstands very hot water.	Prewash, Extra Rinse +1, +2
<b>Towels</b>	1/2 load	<b>Extra hot</b> Hot Warm Cold	<b>High</b> Med Low No spin	Durable, cotton towels; especially soft towels	SpeedPerfect, Prewash, Extra Rinse +1, +2
<b>Sanitize</b>	full load	<b>Extra hot</b>	<b>High</b> Med Low No spin	Sturdy fabric, cotton or linen fabric that withstands very hot water	SpeedPerfect, Prewash, Extra Rinse +1, +2 longer wash and rinse with more water for especially sensitive skin
<b>Jeans</b>	1/2 load	Hot <b>Warm</b> Cold	High <b>Med</b> Low No spin	Dark cotton textiles and dark easy-care textiles; Wash textiles inside-out.	SpeedPerfect, Prewash, Extra Rinse +1, +2
<b>Bulky/Large Items</b>	1/2 load (1 item)	Extra hot <b>Hot</b> Warm Cold	High <b>Med</b> Low No spin	Machine-washable fabrics stuffed with down, such as pillows and duvets; also suitable for items stuffed with synthetic fibres  <b>Note:</b> Wash large items separately. Use a detergent designed for delicates and follow the instructions on the item's care label. Use detergent sparingly.	SpeedPerfect, Extra Rinse +1, +2
<b>Drum Clean</b>	empty	<b>Extra Hot</b>	<b>High</b>	Special cycle for cleaning the drum	
<b>Drain</b>	full load				
<b>Hand Wash/Wool</b>	1/3 load	Hot <b>Warm</b> Cold	<b>Med</b> Low No spin	Hand and machine washable wool/wool blend fabrics	Especially gentle washing cycle to avoid shrinkage, long cycle pauses (clothing rests in suds and water)
<b>Rinse/Spin</b>	full load		<b>High</b> Med Low No spin	Extra rinse with spin Spin only with selectable speed	Extra Rinse "+1" is lit indicating cycle with one rinse and a spin. Touch Extra Rinse button until no symbol is lit and cycle will be spin only (no rinse)

Programs	Max. Load up to:	Selectable program settings, default settings (bold)		Type of laundry	Additional program settings ; Information
		Temperature	Spin speed		
<b>Quick 30</b> (approx. 30 minute cycle)	1/2 load	Hot <b>Warm</b> Cold	High <b>Med</b> Low No spin	Easy-care fabrics made of cotton, linen, synthetic fibers or blended fabrics; suitable for lightly soiled laundry	
<b>Delicates</b>	1/3 load	Hot <b>Warm</b> Cold	<b>Med</b> Low No spin	For delicate, washable fabrics, e.g. made of cotton, satin, synthetic fibres or blended fabrics (e.g. curtains) bulky items (e.g. comforters)	SpeedPerfect, Prewash, Extra Rinse +1, +2
<b>Perm Press Light Soil</b>	1/2 load	Hot <b>Warm</b>	<b>High</b> Med	Cotton, linen synthetic or blended fabrics	
<b>Perm Press Heavy Soil</b>		Cold	Low No spin		SpeedPerfect, Prewash, Extra Rinse +1, +2
<b>Perm Press</b>					
<b>Tips</b>					
Do not wash new multicolored laundry together with other laundry.					
The cycles are time-controlled for lightly soiled fabrics. If fabrics are heavily soiled, reduce the load.					
Rinse cycles use cold water only.					

## Starching

**NOTICE:** Laundry must not be treated with fabric softener.

Starching is possible in all wash programs if liquid starch is used. Measure starch into compartment  in accordance with the manufacturer's instructions (clean first if necessary).

## Dyeing/bleaching

Dye should only be used in normal household quantities. Salt may damage stainless steel. Always follow the dye manufacturer's instructions.

Do **not** use the washing machine to bleach clothes.

## Soaking

1. Pour soaking agent/detergent into compartment **II** in accordance with the manufacturer's instructions.
2. Turn the program selector to **Cotton Normal Cold** program.
3. Touch **Start/Pause**.
4. After approximately ten minutes, touch **Start/Pause**.
5. After the required soaking time, touch **Start/Pause** again to continue or change the program.

### NOTICES

- Load laundry of the same color.
- No additional detergent is required; the soaking solution is used for washing.

---

## Default Program and Option settings

At the factory, temperature and spin speed options, and cycle duration ("Finish in" time) are pre-set for all cycles. After selection of the cycle, these values are displayed in the display field.

You can change the default settings as follows.

### Changing the temperature range

Before and during the cycle, you can change the default temperature range depending on the cycle progress.

Press the appropriate button until the desired setting is displayed.

The maximum temperature range that can be set depends on the cycle selected.

### Changing the spin speed range

Before and during the cycle, you can change the spin speed range depending on the cycle progress.

Touch the appropriate button until the desired setting is displayed.

**No Spin:** This option eliminates the final spin and the load remains saturated with the final rinse water. The pump is activated to remove all residual water.

→ *Program selection table; Page 25*

### Finish in

The program end (Finished in) time can be set in one hour increments to a maximum of 24 h (hours). After selecting the desired washing program (at the dial) but before touching the Start button, touch the Finish in button until the desired time is displayed, e.g. 8 h, then touch the Start button to start the washer.

**NOTICE:** The cycle duration is included in the set Finish in time.

Here is an example of a 2hr:30min cycle time and an 8 h Finish in time.

8 h is displayed (until the Energy-Saving mode activates) and counts down (approximately 5hr:30min) until the washing cycle begins (at 2hr:30min) then the cycle duration 2:30 is displayed and began. Total time approximately 8 hours.

---

## Additional Program Option settings

### Extra Rinse <sup>+1, +2</sup>

This feature is helpful for locations with very soft water or to generally improve rinsing results. It allows up to 2 additional rinse cycles to be added to selected programs and will increase program time.

### Prewash <sup>PW</sup>

For heavily soiled washing. Pour 1/3 of normal detergent amount into pre-wash chamber I and remaining 2/3 into main wash chamber II.

### SpeedPerfect

For washing in a shorter time with a washing result comparable to that of the standard program.

**Note:** Do not exceed the maximum load. → *Program selection table; Page 25*

# Cleaning and maintenance

Your washer is designed to give you many years of service. Observe the following instructions to maintain and protect your washer and keep it in top operating condition.

## ▲ WARNING

### RISK OF ELECTRIC SHOCK HAZARD!

To avoid risk of electric shock always disconnect the washer from the power outlet prior to cleaning. Never clean the washer with a pressure washer.

## Cleaning the housing and control panel

## ▲ WARNING

### RISK OF EXPLOSION!

To avoid risk of explosion never clean the washer with flammable solvents.

As required, you may clean the washer housing and control panel.

- use hot soapy water or a mild (non-abrasive) cleansing agent.
- Dry with a soft towel.
- Remove residue immediately.
- Do not use high pressure spray.

## Cleaning the drum

Metallic debris left in the drum can produce rust spots on the drum. Never use steel wool to try to remove these. Use a chlorine-free cleansing agent and follow the manufacturer's instructions.

## Descaling the washer

Provided that you use correct amounts of detergent with your wash loads, descaling is not necessary. If descaling the washer drum does become necessary, please follow the descaling product manufacturer's instructions.

Small amounts of descaling agent can be used to remove white spots on the washer drum caused by lime or mineral deposits or small amounts of rust caused by metal objects left in the drum.

**NOTICE:** Descaling agents contain acids which may attack parts of the washing machine and may discolor the laundry.

## Cleaning the detergent dispenser tray

If there is a buildup of residual detergent or additives, or if the softener compartment is not rinsed out well enough, it may be helpful to clean the dispenser.

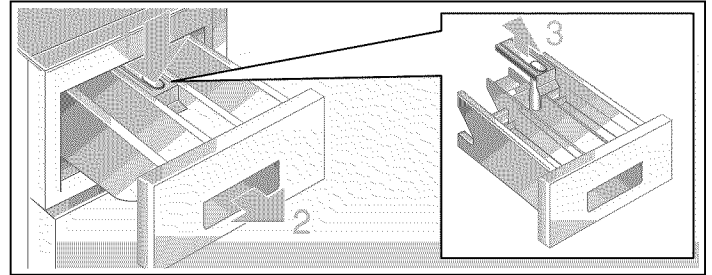

1. Open the detergent dispenser tray fully. Press down on the drawer catch (1) and pull the tray (2) from the washer housing.
2. Remove the insert (3) by grasping it and pulling it upwards from the detergent dispenser tray.
3. Clean the insert and the detergent dispenser tray by holding it under warm running water. Lightly wipe away any remaining detergent residue.
4. Attach the insert and slide the detergent dispenser tray back into place and close the tray securely.

**Tip:** Do not operate the washer without the detergent dispenser tray in place. Always keep the tray completely closed.

## Cleaning the water inlet strainers

If the washer water supply slows or stops completely, the water inlet strainer may be blocked. Cleaning is recommended every 6 months in any event to reduce chances of valve blockage in areas using hard water.

### Release the water under pressure in the supply hoses

Normal water pressure in your home will cause some water to leak when you remove the water supply hose from the back of the washer. You can minimize this by first de-pressurizing the hoses.

1. Turn off the water tap.
2. Turn the cycle selector to any wash cycle (not to Drain or Spin).
3. Touch Start/Pause and allow 30 seconds to pass.
4. Turn the cycle selector to the **Off** position.

This should reduce the water pressure on the water supply hose.

## Clean the strainers at the water tap end of the hose

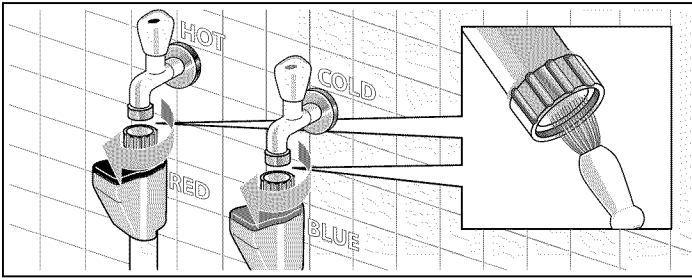

1. Remove the hose from the tap.
2. Rinse the strainer under running water. Look at the strainer to see if any visible debris is still present. Rinse again if necessary to remove the debris.
3. Reconnect the hose to the tap.

## Clean the strainers at the washer end of the hose

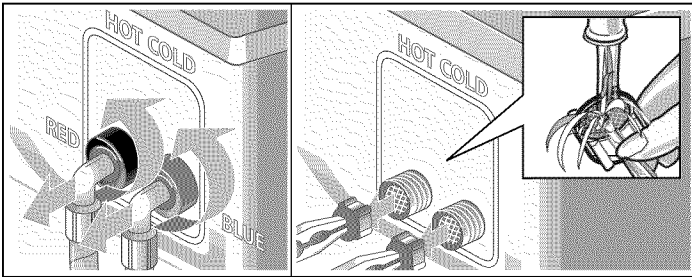

1. Remove the hose from the inlet on the back of the washer.
2. Using narrow pliers, grasp and pull the strainer from the inlet port.
3. Rinse the strainer under running water.
4. Reconnect the hose to the back of the washer and turn on the water tap. Check to see if water flows by starting a warm water wash cycle.

**NOTICE:** Check for leaks to be sure the rubber washers are seated at both ends of the water supply hose and the connections are properly tightened.

## Cleaning the drain pump

### ▲ WARNING

#### RISK OF SCALDING

Risk of hot water injury to skin!

Allow the water to cool down prior to actuating the emergency door lock release.

You are responsible for ensuring all safety precautions are followed when draining water from washer and/or manually opening the washer door.

It may be necessary to clean the washer drain pump if the washer fails to drain (sound of water being pumped from the washer cannot be heard when the washer should be draining and other nearby drains, such as a sink, are draining properly).

The washer pump can become blocked by loose debris (a good reason to check the drum and remove any visible debris after each load.) Fabrics that give off large amounts of fluff may also cause blockage.

To access the washer drain pump, the service cover must first be removed (see steps below). With the service cover removed, proceed as follows:

1. If the washer has not been drained, try to drain it now. Turn the program selector to the **Drain** and touch the **Start/Pause** button. Wait a few moments to let the cycle drain the water from the drum. If the pump is totally blocked, the water will be unable to drain and the cycle will end.
2. Shut off the tap so that no more water flows in and has to be drained.  
Switch the appliance off. Unplug the power plug.

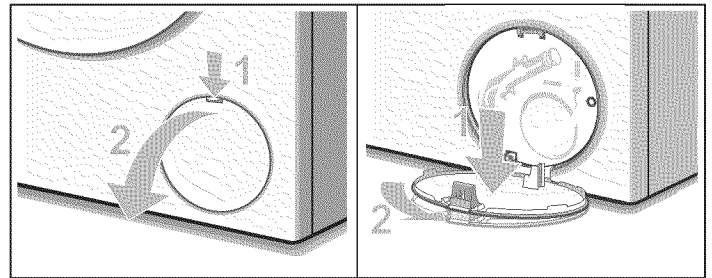

3. Open and remove the service cover.

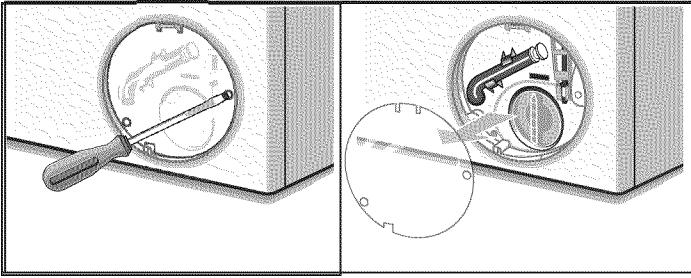

4. Loosen the screws and remove the protective film.

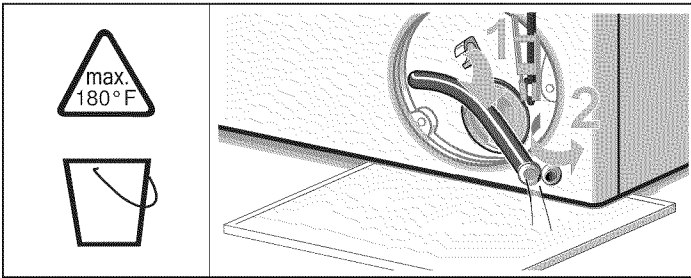

5. Use the pull-out drain hose located in the pump access opening to drain the remaining water into a suitable container (up to 5.3 U.S. gallons/20 liters of water may be drained). Pull the sealing cap from the hose and lay the hose over the side of the container and allow the water to finish draining from the drum. When finished, replace the sealing cap into the end of the hose and restore the hose to its storage location.

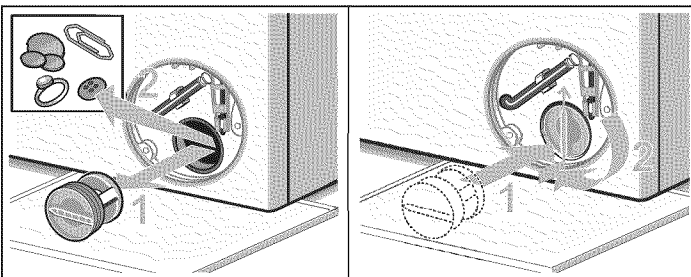

6. Turn the pump cover counterclockwise to remove it. A small amount of residual water may flow out when the cover is removed. Clean the interior of the pump housing, removing any debris or foreign objects. Check to be sure the impeller wheel at the back of the pump housing can now turn freely. Remove any lint, debris or detergent residue from the threads of the pump cover and the pump cover housing. Replace the pump cover by screwing tightly into position. Handle must be vertical.
7. Reinstall the protective film over the pump access using both screws.

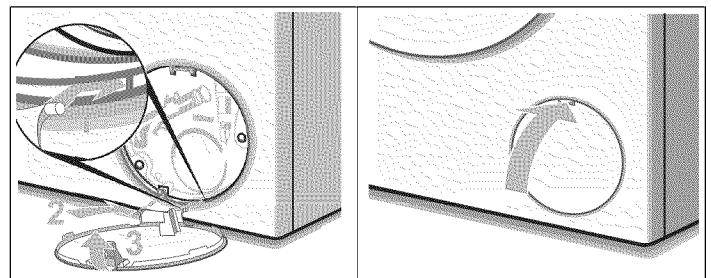
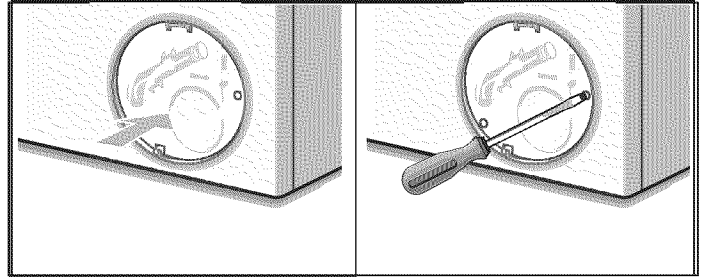

8. Snap the service cover in place at the hinges and close it. Wipe up any spilled water.

**NOTICE:** In order to prevent detergent from flowing unused into the drain during the next wash cycles: pour 0.26 U.S. gallons/1 liter water into the chamber II. Turn the cycle selector to the **Drain** and touch the **Start/Pause** button.

# Troubleshooting

## Emergency door lock release

In the event of a power interruption the program will continue running when the power supply has been restored.

If the washer door must be opened and the normal door unlock procedures do not work, the emergency door lock release rod can be actuated to open the door.

---

### ▲ WARNING

#### RISK OF SCALDING

To avoid risk of scalding, allow water to cool down prior to activating the emergency door lock release. The drum may be full of hot water which could cause burn injury.

---

---

### ▲ WARNING

#### RISK OF INJURY

You may injure your hands if you reach into the drum while it is turning.

**Do not** reach into the drum when it is turning. Wait until the drum has stopped turning.

---

---

### ▲ CAUTION

#### WATER DAMAGE AND BURN INJURY

Any escaping water may cause water damage and burns.

Do not open the washing machine door if water can be seen through the glass.

---

1. Turn the washer off by rotating the cycle selector to the **Off** position. Any running program will then be cancelled. Disconnect the mains plug.
2. Allow the water in the drum to cool off.
3. Allow the washer drum to come to a stand still (no longer spinning).
4. Before opening the washer door, perform the drain procedure included in the pump maintenance section.  
→ *Cleaning the drain pump; Page 29*
5. Loosen screws and remove the protective foil.
6. The washing machine door can then be opened. Pull the emergency release downwards with a tool and release.

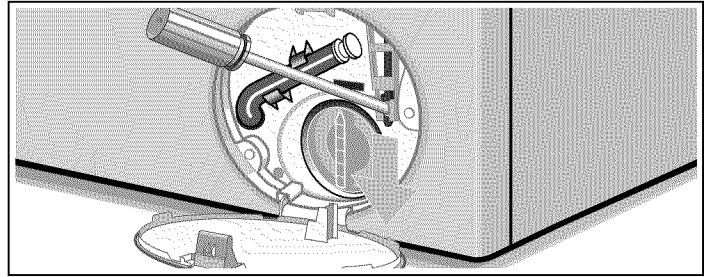

7. The door can now be opened.

## General Troubleshooting

If you encounter a problem, consider the suggestions and instructions below before you call customer service.

---

### ▲ WARNING

#### ELECTRIC SHOCK HAZARD

To avoid risk of electric shock, repairs should be carried out by an authorized technician.

---

If repairs are necessary and you cannot eliminate the fault with the aid of the table below, follow these steps:

1. Turn the cycle selector to **Off**.
2. Disconnect the washer from the power outlet.
3. Turn off the water taps.
4. Call Customer Service.

→ *Customer service; Page 4*

**NOTICE:** The troubleshooting items listed below can help you resolve minor issues with your washer quickly and without the necessity of waiting for a service call.

**Service calls for issues that could have been solved by using this table may not be covered under the warranty. Please rule out any of these issues before calling customer service.**



## Determining the Problem

Problem	Possible cause(s)	Solution(s)
Washer door cannot be opened.	Child lock is activated.	Deactivated Child lock (touch and hold <b>Temperature</b> and <b>Finish in</b> for approximately 3 seconds).
	A power failure occurred.	If a cycle is interrupted by a power failure, it will resume when the power is restored.
	Cycle is running, or water level is too high and/or too hot.	Wait until the cycle ends.
	Electric power cord has become loose or unplugged.	Make sure the electric cord is securely plugged in.
	Program selector turned to <b>Off</b> before end of cycle.	Turn the program selector to a cycle.
	Emergency door lock released is activated.	→ <i>Emergency door lock release; Page 31</i>
Door still cannot be opened, even after turning the washer <b>Off</b> and back on again.	Child lock is activated	Deactivated Child lock (touch and hold <b>Temperature</b> and <b>Finish in</b> for approximately 3 seconds).
	Door is locked for safety reasons (high water level, temperature of water hot, or high drum speed (drum is turning)).	
Wash cycle time is increased.	Your washer utilizes sensors to monitor certain characteristics of the wash load. Increases in wash cycle time could be due to:	Solutions are based on the specific reason the wash time has been extended.
	Excess suds.  displays at end of cycle.	Use less detergent.
	The automatic unbalanced load detection system spins the laundry several times to ensure even distribution.	Always load the washer with a mixture of large and small wash items (easier to distribute in the drum).
Cycle does not start - <b>Start/Pause</b> flashes.	<b>Start/Pause</b> button not touched / selected?	Touch the <b>Start/Pause</b> button to start the cycle.
	Washer door is not closed properly.	Check if laundry is caught in the door. Close the door until a click is heard, the cycle should start.
Cycle does not start - Finish in-Time is displayed.	Cycle ending time has been selected and activated.	Wash cycle will begin at proper time to complete at the selected finish time.
Cycle does not start -  symbol flashes.	Child lock is activated.	Deactivate Child lock (touch and hold <b>Temperature</b> and <b>Finish in</b> for approximately 3 seconds).
Detergent residue remains in the detergent dispenser.	Dry detergent may have been damp or lumpy.	Clean and dry the detergent dispenser.
	Excess liquid detergent may have been added.	See <i>Adding the correct amount of HE detergent</i> to determine proper detergent usage.
	Use the dosing cup for liquid detergent when dosing powder detergent. Powder detergent may have been damp or lumpy.	Clean and dry the detergent dispenser.
Water does not appear to be coming into the washer, or detergent is not washed away.	<b>Start/Pause</b> selected?	Select <b>Start/Pause</b> .
	Water taps not turned on.	Turn on water taps.
	Supply hose kinked or pinched (reduce flow).	Eliminate the cause.
	Water supply hose strainers clogged.	Clean the water inlet strainers.
	Water pressure too low.	Eliminate the cause.
Water cannot be seen in the drum.	The water level in your high efficiency front load washer is below the visible part of the drum, this is normal.	No action needed.



<b>Problem</b>	<b>Possible cause(s)</b>	<b>Solution(s)</b>
Water has not drained completely.	Suds may be excessive (usually due to too much detergent or non-HE detergent being used).	Use less detergent for future loads. Be sure to use only high efficiency HE-detergents.
	Pump is blocked.	Check and clean the drain pump, water drain hose and/or the drain pipe.
	Drain hose or drain pipe is blocked.	Clean drainage pipe and/or drainage hose.
Water is coming out from underneath the washer.	Water supply hose is leaking: is not screwed on tight at both ends, or rubber washer not placed in hose.	Eliminate the cause: tighten the hose (by hand at the washer end), check for rubber washer in place.
	Drain hose is leaking.	Check the drain hose, be sure that it is on the washer securely with the clamp in place; may need to replace the drain hose if leaking continues.
Foam comes out of the detergent dispenser drawer. The cycle status sequence Wash flashes in the display.	Too much detergent was used, or a non-HE detergent was used; pump was not able to pump out the increased suds. 🌀 displays at end of cycle.	Immediate fix: mix 1 tablespoon of fabric softener with 1/2 liter (1 pint) of water and pour this mixture into the detergent compartment (not with waterproof fabrics).
		To prevent: use less detergent for future wash loads.
Repeated spinning.	The Unbalanced Load Detection system is attempting to balance the load through repeated spins.	To prevent: always load the washer with a mixture of large and small wash items (easier to distribute in the drum).
No spin took place (laundry is still wet).	Load size too small.	Add more laundry.
	Large items may have become entangled in the drum and could not be distributed by the Unbalanced Load Detection system; spin cycle therefore canceled for safety reasons.	To prevent: always load the washer with a mixture of large and small wash items (easier to distribute in the drum).
	Excessive suds: too much detergent was used, or a non-HE detergent was used. 🌀 displays at end of cycle.	Immediate fix: mix 1 tablespoon of fabric softener with 1/2 liter (1 pint) of water and pour this mixture into the detergent compartment (not with waterproof fabrics). To prevent: use less detergent for future wash loads.
	No Spin was selected	Select a spin speed setting (Low, Med or High)
Detergent residue on the laundry.	Some phosphate free detergents contain water insoluble ingredients that may appear as light spots on the laundry.	Brush off when laundry is dry or execute the program <b>Rinse</b> .
System shakes or shudders when spin speed increases.	The washer drum suspension system shifts during spinning as the speed increases. This may result in a slight shaking of the washer during the spin speed transition.	Mix small and large laundry items together in the load to minimize this effect. Check to be sure the washer is level and all four feet press equally against the floor. Transport bolts removed? → <i>Remove the transport bolts; Page 12</i>

## Error messages

Display	Fault	Measure
 flashes	Door not closed properly.	Check to be sure no laundry is caught in the washer door. Close the door securely.
	Cold water tap not turned on.	Turn on the cold water tap.
	Supply hose for cold water kinked or pinched closed.	Eliminate the cause, replace the hose if damaged.
	Strainer in water supply hose clogged.	Clean the water inlet strainer. → <i>Cleaning the water inlet strainers; Page 28</i>
	Cold water pressure too low.	Eliminate the cause.
E:93 (Displayed at end of first cycle without hot water. Not displayed in subsequent cycles if hot water is not available. Reset after second cycle with hot water)	Hot water tap not turned on.	Turn on the hot water tap.
	Supply hose for hot water kinked or pinched closed.	Eliminate the cause, replace the hose if damaged.
	Hot water pressure too low.	Eliminate the cause.
	Strainer in water supply hose clogged.	Connect both supply hoses (hot and cold water) for hot water appliances. → <i>Water connections; Page 13</i>
E:32 (alternating display with END when program is finished)	Not a fault – the unbalanced load detection system has interrupted the spin cycle because the laundry is unevenly distributed.	Distribute small and large items of laundry evenly in the drum. If necessary, start an additional spin program.
E:18	Too much detergent used or non-HE detergent used.  displays at end of cycle.	Use less detergent for future loads. Only use HE detergents. → <i>Your washing machine is intended for; Page 5</i>
	Pump is blocked (obstructed).	Clean the washer drain hose and/or the drain pipe. May need to perform pump maintenance to clear blockage. → <i>Cleaning the drain pump; Page 29</i>
Others		Turn off machine, wait 5 seconds and turn on again. If the display shows again, call customer service.

## Customer service

Contact the Customer Service department if your appliance needs repair. Our representatives will be happy to provide details for an authorized service provider close to you.

**E-Nr.** and **FD** (serial) number:

When you contact Customer Service, please have the **E-Nr.** (model number) and the **FD** (serial) number for your appliance available. You can find the identification plate with these numbers on this information on inside of the appliance door or on the back of the appliance.

Questions? Please contact us. We look forward to hearing from you!

1-800-944-2904

[www.bosch-home.com](http://www.bosch-home.com)

1901 Main Street, Suite 600  
Irvine, CA 92614

# STATEMENT OF LIMITED PRODUCT WARRANTY

## What this Warranty Covers & Who it Applies to

The limited warranty provided by BSH Home Appliances ("Bosch") in this Statement of Limited Product Warranty applies only to the Bosch appliance sold to you, the first using purchaser, provided that the Product was purchased:

- For your normal, household (non-commercial) use, and has in fact at all times only been used for normal household purposes.
- New at retail (not a display, "as is", or previously returned model), and not for resale, or commercial use.
- Within the United States or Canada, and has at all times remained within the country of original purchase.

The warranties stated herein apply only to the first purchaser of the Product and are not transferable. Please make sure to return your registration card; while not necessary to effectuate warranty coverage, it is the best way for Bosch to notify you in the unlikely event of a safety notice or product recall.

## Limitation for Third Party Accessories and Water Supply Hoses:

Third party accessories, including water supply hoses other than those shipped with your Bosch washer, and any consequential damages resulting therefrom, are not covered by this warranty. This limitation expressly includes the implied warranties of merchantability and fitness for a particular purpose, which are also expressly excluded with respect to third party accessories, including water supply hoses other than those shipped with your Bosch washer. Use of third party accessories, including water supply hoses other than those shipped with your Bosch washer, does not void this warranty on any other part, and all other provisions of this warranty remain in effect.

**How Long the Warranty Lasts:** Bosch warrants that the Product is free from defects in materials and workmanship for a period of three hundred sixty-five (365) days from the date of purchase. The foregoing timeline begins to run upon the date of purchase, and shall not be stalled, tolled, extended, or suspended, for any reason whatsoever. This Product is also warranted to be free from cosmetic defects in material and workmanship (such as scratches of stainless steel, paint/porcelain blemishes, chips, dents, or other damage to the finish) of the Product, for a period of thirty (30) days from the date of purchase or closing date for new construction. This cosmetic warranty excludes slight color variations due to inherent differences in painted and porcelain parts, as well as differences caused by kitchen lighting, product location, or other similar factors. This cosmetic warranty specifically excludes any display, floor, "As Is", or "B" stock appliances.

**Repair/Replace as Your Exclusive Remedy:** During this warranty period, Bosch or one of its authorized service providers will repair your Product without charge to you (subject to certain limitations stated herein) if your Product proves to have been manufactured with a defect in materials or workmanship. If reasonable attempts to repair the Product have been made without success, then Bosch will replace your Product (upgraded models may be available to you, in Bosch's sole discretion, for an additional charge). All removed parts and components shall become the property of Bosch at its sole option. All replaced and/or repaired parts shall assume the identity of the original part for purposes of this warranty and this warranty shall not be extended with respect to such parts. Bosch's sole liability and responsibility hereunder is to repair manufacturer-defective Product only, using a Bosch authorized service provider during normal business hours. For safety and property damage concerns, Bosch highly recommends that you do not attempt to repair the Product yourself, or use an un-authorized servicer; Bosch will have no responsibility or liability for repairs or work performed by a non-authorized servicer. If you choose to have someone other than an authorized service provider work on your Product, THIS WARRANTY WILL AUTOMATICALLY BECOME NULL AND VOID. Authorized service providers are those persons or companies that have been specially trained on Bosch products, and who possess, in Bosch's opinion, a superior reputation for customer service and technical ability (note that they are independent entities and are not agents, partners, affiliates or representatives of Bosch). Notwithstanding the foregoing, Bosch will not incur any liability, or have responsibility, for the Product if it is located in a remote area (more than 100 miles from an authorized service provider) or is in a reasonably inaccessible, hazardous, threatening, or treacherous locale, surroundings, or environment; in any such event, if you request, Bosch would still pay for labor and parts and ship the parts to the nearest authorized service provider, but you would still be fully liable and responsible for any travel time or other special charges by the service company, assuming they agree to make the service call.

## SCOPE OF EXTENDED LIMITED WARRANTY

Bosch will repair or replace, free of charge any printed circuit boards, drive motor or component part of the motor that proves defective under conditions of normal home use during the first seven hundred thirty (730) days from the date of purchase, labor charges excluded.

**Out of Warranty Product:** Bosch is under no obligation, by law or otherwise, to provide you with any concessions, including repairs, pro-rates, or Product replacement, once this warranty has expired.

**Warranty Exclusions:** The warranty coverage described herein excludes all defects or damage that are not the direct fault of Bosch, including without limitation, one or more of the following:

Use of the Product in anything other than its normal, customary and intended manner (including without limitation, any form of commercial use, use or storage of an indoor product outdoors, use of the Product in conjunction with air or water-going vessels).

- Any party's willful misconduct, negligence, misuse, abuse, accidents, neglect, improper operation, failure to maintain, improper or negligent installation, tampering, failure to follow operating instructions, mishandling, unauthorized service (including self performed "fixing" or exploration of the appliance's internal workings).
- Adjustment, alteration or modification of any kind.
- A failure to comply with any applicable state, local, city, or county electrical, plumbing and/or building codes, regulations, or laws, including failure to install the product in strict conformity with local fire and building codes and regulations.
- Ordinary wear and tear, spills of food, liquid, grease accumulations, or other substances that accumulate on, in, or around the Product.
- Any external, elemental and/or environmental forces and factors, including without limitation, rain, wind, sand, floods, fires, mud slides, freezing temperatures, excessive moisture or extended exposure to humidity, lightning, power surges, structural failures surrounding the appliance, and acts of God.

In no event shall Bosch have any liability or responsibility whatsoever for damage to surrounding property, including cabinetry, floors, ceilings, and other structures or objects around the Product. Also excluded from this warranty are Products on which the serial numbers have been altered, defaced, or removed; service visits to teach you how to use the Product, or visits where there is nothing wrong with the Product; correction of installation problems (you are solely responsible for any structure and setting for the Product, including all electrical, plumbing or other connecting facilities, for proper foundation/flooring, and for any alterations including without limitation cabinetry, walls, floors, shelving, etc.); and resetting of breakers or fuses. TO THE EXTENT ALLOWED BY LAW, THIS WARRANTY SETS OUT YOUR EXCLUSIVE REMEDIES WITH RESPECT TO PRODUCT, WHETHER THE CLAIM ARISES IN CONTRACT OR TORT (INCLUDING STRICT LIABILITY, OR NEGLIGENCE) OR OTHERWISE. THIS WARRANTY IS IN LIEU OF ALL OTHER WARRANTIES, WHETHER EXPRESS OR IMPLIED. ANY WARRANTY IMPLIED BY LAW, WHETHER FOR MERCHANTABILITY OR FITNESS FOR A PARTICULAR PURPOSE, OR OTHERWISE, SHALL BE EFFECTIVE ONLY FOR THE PERIOD THAT THIS EXPRESS LIMITED WARRANTY IS EFFECTIVE. IN NO EVENT WILL THE MANUFACTURER BE LIABLE FOR CONSEQUENTIAL, SPECIAL, INCIDENTAL, INDIRECT, "BUSINESS LOSS", AND/OR PUNITIVE DAMAGES, LOSSES, OR EXPENSES, INCLUDING WITHOUT LIMITATION TIME AWAY FROM WORK, HOTELS AND/OR RESTAURANT MEALS, REMODELLING EXPENSES IN EXCESS OF DIRECT DAMAGES WHICH ARE DEFINITELY CAUSED EXCLUSIVELY BY BOSCH, OR OTHERWISE. SOME STATES DO NOT ALLOW THE EXCLUSION OR LIMITATION OF INCIDENTAL OR CONSEQUENTIAL DAMAGES, AND SOME STATES DO NOT ALLOW LIMITATIONS ON HOW LONG AN IMPLIED WARRANTY LASTS, SO THE ABOVE LIMITATIONS MAY NOT APPLY TO YOU. THIS WARRANTY GIVES YOU SPECIFIC LEGAL RIGHTS, AND YOU MAY ALSO HAVE OTHER RIGHTS WHICH VARY FROM STATE TO STATE. No attempt to alter, modify or amend this warranty shall be effective unless authorized in writing by an officer of BSH.

**How to Obtain Warranty Service:** To obtain warranty service for your Product, you should contact the nearest Bosch Customer Service Department.

**BSH Home Appliances Corporation** - 1901 Main Street, Suite 600, Irvine, CA 92614 / 800-944-2904



9001002426  
9504



1901 Main Street, Suite 600 • Irvine, CA 92614 • 1-800-944-2904  
[www.bosch-home.com](http://www.bosch-home.com) • © 2012 BSH Home Appliances