

Use & Care Guide

Model No.

153.332620 40 Gallon Tall

153.332640 50 Gallon Tall



Kenmore Elite[®]

Gas Water Heater

For potable water heating only.

Not suitable for space heating.

Not for use in mobile homes.

INSTALLER: Affix these instructions to or near the water heater.

OWNER: Retain these instructions for future reference.

FOR YOUR SAFETY: An odorant is added to the gas used by this water heater.

ADVERTENCIA

Si no puede leer o entender el inglés y necesita el manual de instrucciones en español, puede solicitarlo al 1-800-821-2017. NO TRATE DE INSTALAR U OPERAR ESTE CALENTADOR DE AGUA SI NO ENTIENDE LAS INSTRUCCIONES. No hacer caso de esta advertencia podría originar lesiones graves o mortales.

P/N 317997-001 (0711)

Sears Brands Management Corporation,
Hoffman Estates, IL 60179 U.S.A.

www.kenmore.com
www.sears.com







WARNING: If the information in these instructions is not followed exactly, a fire or explosion may result causing property damage, personal injury or death.

- Do not store or use gasoline or other flammable vapors and liquids in the vicinity of this or any other appliance.
- **WHAT TO DO IF YOU SMELL GAS:**
 - Do not try to light any appliance.
 - Do not touch any electrical switch; do not use any phone in your building.
 - Immediately call your gas supplier from a neighbor's phone. Follow the gas supplier's instructions.
 - If you cannot reach your gas supplier, call the fire department.
- Installation and service must be performed by a qualified installer, service agency or the gas supplier.

SAFE INSTALLATION, USE AND SERVICE

Your safety and the safety of others is extremely important in the installation, use and servicing of this water heater.

Many safety-related messages and instructions have been provided in this manual and on your own water heater to warn you and others of a potential injury hazard. Read and obey all safety messages and instructions throughout this manual. It is very important that the meaning of each safety message is understood by you and others who install, use or service this water heater.

	This is the safety alert symbol. It is used to alert you to potential personal injury hazards. Obey all safety messages that follow this symbol to avoid possible injury or death.
	DANGER indicates an imminently hazardous situation which, if not avoided, will result in death or injury.
	WARNING indicates a potentially hazardous situation which, if not avoided, could result in death or injury.
	CAUTION indicates a potentially hazardous situation which, if not avoided, could result in minor or moderate injury.
	CAUTION used without the safety alert symbol indicates a potentially hazardous situation which, if not avoided, could result in property damage.

All safety messages will generally tell you about the type of hazard, what can happen if you do not follow the safety message and how to avoid the risk of injury.

The California Safe Drinking Water and Toxic Enforcement Act requires the Governor of California to publish a list of substances known to the State of California to cause cancer, birth defects, or other reproductive harm, and requires businesses to warn of potential exposure to such substances. **WARNING:** This product contains a chemical known to the State of California to cause cancer, birth defects, or other reproductive harm. This appliance can cause low-level exposure to some of the substances included in the Act.

IMPORTANT DEFINITIONS

- **Qualified Technician:** A qualified technician must have ability equivalent to a licensed tradesman in the fields of plumbing, air supply, venting, and gas supply, including a thorough understanding of the requirements of the National Fuel Gas Code as it relates to the installation of gas fired water heaters. The qualified technician must also be familiar with the design features and use of flammable vapor ignition resistant water heaters, and have a thorough understanding of this instruction manual.
- **Service Agency:** A service agency also must have ability equivalent to a licensed tradesman in the fields of plumbing, air supply, venting and gas supply, including a thorough understanding of the requirements of the National Fuel Gas Code as it relates to the installation of gas fired water heaters. The service agency must also have a thorough understanding of this instruction manual, and be able to perform repairs strictly in accordance with the service guidelines provided by the manufacturer.
- **Gas Supplier:** The natural gas or propane utility or service who supplies gas for utilization by the gas burning appliances within this application. The gas supplier typically has responsibility for the inspection and code approval of gas piping up to and including the natural gas meter or propane storage tank of a building. Many gas suppliers also offer service and inspection of appliances within the building.

SAFETY PRECAUTIONS

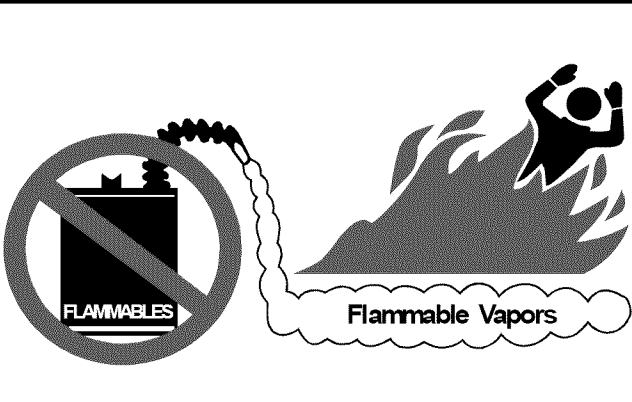

Flammable Vapors

⚠️ WARNING

FIRE AND EXPLOSION HAZARD

Can result in serious injury or death

⚠️ Do not store or use gasoline or other flammable vapors and liquids in the vicinity of this or any other appliance. Storage of or use of gasoline or other flammable vapors or liquids in the vicinity of this or any other appliance can result in serious injury or death.

Read and follow water heater warnings and instructions.

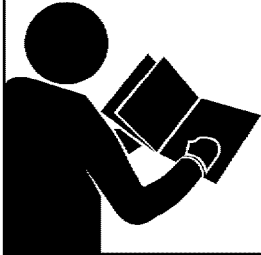

⚠️ WARNING

Read and understand instruction manual and safety messages before installing, operating or servicing this water heater.

Failure to follow instructions and safety messages could result in death or serious injury.

Instruction manual must remain with water heater.



⚠️ WARNING

Fire Hazard

For continued protection against risk of fire:

- Do not install water heater on carpeted floor.
- Do not operate water heater if flood damaged.

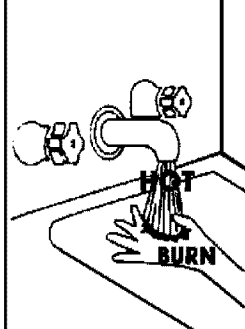

⚠️ DANGER

Water temperature over 125°F (52°C) can cause severe burns instantly resulting in severe injury or death.

Children, the elderly, and the physically or mentally disabled are at highest risk for scald injury.

Feel water before bathing or showering.

Temperature limiting valves are available.

Read instruction manual for safe temperature setting.

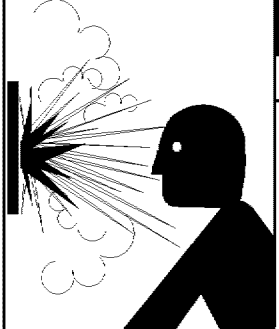

⚠️ WARNING

Explosion Hazard



- Overheated water can cause water tank explosion.
- Properly sized temperature and pressure relief valve must be installed in opening provided.

⚠️ WARNING

Fire or Explosion Hazard

- Do not store or use gasoline or other flammable vapors and liquids in the vicinity of this or any other appliance.
- Avoid all ignition sources if you smell Natural or LP gas.
- Do not expose water heater control to excessive gas pressure.
- Use only gas shown on rating plate.
- Maintain required clearances to combustibles.
- Keep ignition sources away from faucets after extended period of non-use.

Read instruction manual before installing, using or servicing water heater.

⚠️ WARNING

Breathing Hazard - Carbon Monoxide Gas

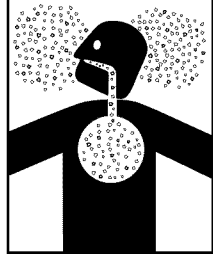

- Install vent system in accordance with codes.
- Do not operate water heater if flood damaged
- Heater should not be installed for High Altitude operation above 10,100 feet (3,078 m).
- Do not operate if soot buildup.
- Do not obstruct water heater air intake with insulating jacket.
- Do not place chemical vapor emitting products near water heater.
- Gas and carbon monoxide detectors are available.

Breathing carbon monoxide can cause brain damage or death. Always read and understand instruction manual.

CAUTION

Improper installation and use may result in property damage.

- Do not operate water heater if flood damaged.
- Install in location with drainage.
- Fill tank with water before operation.
- Be alert for thermal expansion.

Refer to instruction manual for installation and service.

TABLE OF CONTENTS

SAFE INSTALLATION, USE AND SERVICE	2
Important Definitions	2
SAFETY PRECAUTIONS	2-3
Table of Contents	4-5
PRODUCT WARRANTY	6
CUSTOMER RESPONSIBILITIES	7
PRODUCT SPECIFICATIONS	8
MATERIALS AND BASIC TOOLS NEEDED	9
TYPICAL INSTALLATION	10
Get to know your Water Heater	10
IMPORTANT INFORMATION ABOUT THIS WATER HEATER	11
Installation Checklist	11
INSTALLATION INSTRUCTIONS	12-14
Removing the Old Water Heater	12
Location Requirements	13
Site Location	13
Clearances and Accessibility	14
High Altitude Installation	14
GAS SUPPLY	15
Gas Requirements	15
Gas Piping	15
Gas Pressure	15
Gas Pressure Testing	15
COMBUSTION AIR SUPPLY & VENTILATION	17-20
Unconfined Space	17
Confined Space	17
All Air from Inside the Building	17
All Air from Outdoors	18
Louvers and Grilles	18
Vent Pipe System	19
Draft Hood Installation	19-20
Vent Pipe Size	20
Vent Connectors	20
Chimney Connection	20
Vertical Exhaust Gas Vent	20
WATER SYSTEM PIPING	21-22
Piping Installation	21
Closed System/Thermal Expansion	22
Temperature and Pressure Relief Valve	22
T&P Relief Valve and Pipe Insulation	23

ELECTRICAL	24
Electrical Connections	24
Solar Installation	24
Wiring Diagram	24
OPERATING YOUR WATER HEATER	25-30
Lighting Instructions	25
Water Heater Operation	26
Checking the Draft	26
Burner Flames	27
Emergency Shut Down	27
Water Temperature Regulation	27-28
Powered Anode Rod Operation	28
SERVICE AND ADJUSTMENT	29
Draining and Flushing	29
Routine Preventive Maintenance	29
Temperature and Pressure Relief Valve	29
MAINTENANCE OF YOUR WATER HEATER	30-32
Replacement Parts	30
Removing the Manifold/Burner Assembly	30
Removing the Burner from the Manifold/Burner Assembly	30
Replacing the Flame Sense/Hot Surface Igniter Assembly	30
External Inspection & Cleaning of the Air Intake Chamber Screen	31
Cleaning the Combustion Chamber and Air Diverter Assembly	31
Replacing the Manifold/Burner Assembly	31
Removing and Replacing the Gas Control Valve/Thermostat	32
TROUBLESHOOTING GUIDE	33-35
Start Up Conditions	33
Operational Conditions	34
Service	34
Leakage Checkpoints	35
Pressurized Combustion Chamber System Operational Checklist	36
TROUBLESHOOTING CHART	36-37
ELECTRONIC CONTROL DISPLAY TROUBLESHOOTING	38-40
TROUBLESHOOTING FLOWCHART	41
PARTS ORDER LIST	42

PRODUCT WARRANTY

12 - YEAR LIMITED WARRANTY ON WATER HEATER

For twelve years from the date of purchase, if this water heater is installed and operated in a single-family home in accordance with the owner's manual instructions and all local applicable plumbing codes, Sears will:

1. Supply free water heater parts for those that are defective in material or workmanship.
2. Supply a free water heater for one that develops a leak.

For the second through twelfth year from the purchase date, you must pay the labor cost for installation of parts or water heater.

For commercial, institutional, industrial or residential use by two or more families, the above limited warranty is only for two years. During the second year you must pay the labor cost for parts or water heater installation.

If governmental regulations prohibit Sears from furnishing a comparable model replacement water heater under this warranty, Sears will furnish a new water heater of comparable output as permitted by such governmental regulations; however, the Owner will be charged for the additional cost associated with the changes made to comply with such governmental regulations.

Replacements furnished under this warranty do not carry a new warranty; and are only covered by the unexpired portion of the original warranty.

1 - YEAR EXCLUSIVE KENMORE LABOR WARRANTY

For the first year from the date of purchase, Sears will, free of charge, supply and install new water heater parts for defective ones or a new water heater for one that develops a leak.

WARRANTY SERVICE

To obtain warranty service, call 1-800-4-MY-HOME® (1-800-469-4663).

This warranty applies only while this product is in use in the United States.

This warranty gives you specific legal rights, and you may also have other rights which vary from state to state.

SEARS BRANDS MANAGEMENT CORPORATION, Hoffman Estates, IL 60179

The price of your water heater does not include a free checkup service call. On water heater installations arranged by Sears, Sears warrants the installation.

A charge will be made on service calls due to poor or incomplete installation. These include:

- a. Adjusting thermostat
- b. Condensation
- c. Leaks in pipes or fittings

Master Protection Agreements

Congratulations on making a smart purchase. Your new Kenmore® product is designed and manufactured for years of dependable operation. But like all products, it may require preventive maintenance or repair from time to time. That's when having a Master Protection Agreement can save you money and aggravation.

The Master Protection Agreement also helps extend the life of your new product. Here's what the Agreement* includes:

- **Parts and labor** needed to help keep products operating properly **under normal use**, not just defects. Our coverage goes **well beyond the product warranty**. No deductibles, no functional failure excluded from coverage— **real protection**.
- **Expert service** by a force of more than **10,000 authorized Sears service technicians**, which means someone you can trust will be working on your product.
- **Unlimited service calls and nationwide service**, as often as you want us, whenever you want us.
- **"No-lemon"** guarantee – replacement of your covered product if four or more product failures occur within twelve months.
- **Product replacement** if your covered product can't be fixed.
- **Annual Preventive Maintenance Check** at your request – no extra charge.
- **Fast help by phone** – we call it **Rapid Resolution** – phone support from a Sears representative on all products. Think of us as a "talking owner's manual."
- **Power surge protection** against electrical damage due to power fluctuations.

- **\$250 Food Loss Protection** annually for any food spoilage that is the result of mechanical failure of any covered refrigerator or freezer.
- **Rental reimbursement** if repair of your covered product takes longer than promised.
- **10% discount** off the regular price of any non-covered repair service and related installed parts.

Once you purchase the Agreement, a simple phone call is all that it takes for you to schedule service. You can call anytime day or night, or schedule a service appointment online.

The Master Protection Agreement is a risk free purchase. If you cancel for any reason during the product warranty period, we will provide a full refund. Or, a prorated refund anytime after the product warranty period expires. Purchase your Master Protection Agreement today!

Some limitations and exclusions apply. For prices and additional information in the U.S.A. call 1-800-827-6655.

*** Coverage in Canada varies on some items. For full details, call Sears Canada at 1-800-361-6665.**

Sears Installation Service

For Sears professional installation of home appliances, garage door openers, water heaters, and other major home items, in the U.S.A. or Canada call **1-800-4-MY-HOME®**.

CUSTOMER RESPONSIBILITIES

Thank You for purchasing a Kenmore water heater. Properly installed and maintained, it should give you years of trouble free service. If you should decide that you want the new water heater professionally installed by Sears call 1-800-4-MY-HOME®. They will arrange for prompt, quality installation by Sears authorized contractors.

Abbreviations Found In This Instruction Manual:

- CSA - Canadian Standards Association
- ANSI - American National Standards Institute
- NFPA - National Fire Protection Association
- ASME - American Society of Mechanical Engineers
- GAMA - Gas Appliance Manufacturers Association

Important Information About This Water Heater:

This gas water heater was manufactured to voluntary safety standards to reduce the likelihood of a flammable vapor ignition incident. New technology used in meeting these standards makes this product more sensitive to installation errors or improper installation environments. Please review the Installation Checklist section and make any required installation upgrades or changes.

This product is certified to comply with a maximum weighted average of 0.25% lead content as required in some areas.

This manual contains instructions for the installation, operation, and maintenance of the gas-fired water heater. It also contains warnings through out the manual that you must read and be aware of. All warnings and all instructions are essential to the proper operation of the water heater and your safety. Since we cannot put everything on the first few pages, **READ THE ENTIRE MANUAL BEFORE ATTEMPTING TO INSTALL OR OPERATE THE WATER HEATER.**

- The installation must conform with these instructions and the local code authority having jurisdiction. In the absence of local codes, installations shall comply with the following:

In the United States: The National Fuel Gas Code ANSI Z223.1/ NFPA 54. This publication is available from the Canadian Standards Association, 8501 East Pleasant Valley Rd, Cleveland Ohio 44131, or The National Fire Protection Association, 1 Batterymarch Park, Quincy, MA 02269.

- If after reading this manual you have any questions or do not understand any portion of the instructions, call the Sears Service Center.
- Carefully plan the place where you are going to put the water heater. Correct combustion, vent action, and vent pipe installation are very important in preventing death from possible carbon monoxide poisoning and fires. See Figure 1.
- Examine the location to ensure the water heater complies with the *Installation Instructions* section in this manual.
- Keep combustibles such as boxes, magazines, clothes, etc., away from water heater area.

- For California installation, this water heater must be braced, anchored, or strapped to avoid falling or moving during an earthquake. See instructions for correct installation procedures. Instructions may be obtained from California's Office of the State Architect, 1102 Q Street, Suite 5100, Sacramento, CA 95811. Instructions can also be downloaded to your computer at www.dsa.dgs.ca.gov/Pubs.
- Massachusetts Code requires this water heater to be installed in accordance with Massachusetts 248-CMR 2.00: State Plumbing Code and 248-CMR 5.00.
- Complies with 40 Ng/J NOx requirements of Texas and most California AQM Districts.



IMPORTANT: Do not remove any permanent instructions, labels, or the data label from either the outside of the water heater or on the inside of water heater panels.

- Remove exterior packaging and place installation components aside.
- Inspect all parts for damage prior to installation and start-up.
- Completely read all instructions before attempting to assemble and install this product.
- After installation, dispose of/recycle all packaging materials.

PRODUCT SPECIFICATIONS

MODEL NUMBER	TANK CAPACITY IN GALS (LTRS)	TYPE OF GAS	INPUT RATE (Btu/hr)	RECOVERY RATE GALS. PER HOUR @ 90°F RISE	MINIMUM VENT PIPE DIA. INCHES (mm)	DIAMETER INCHES (mm)	HEIGHT TO JACKET TOP INCHES (mm)
153.332620	40 (151)	Natural	40,000	42.6	3 (76) or 4 (102)	20 (508)	58 (1473)
153.332640	50 (189)	Natural	40,000	42.6	3 (76) or 4 (102)	22 (559)	57.13 (1451)

MATERIALS AND BASIC TOOLS NEEDED

MATERIALS NEEDED

To simplify the installation Sears has available the installation parts shown below. You may or may not need all of these materials, depending on your type of installation.

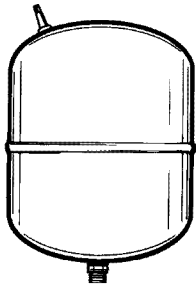

EXPANSION TANKS FOR THERMAL EXPANSION CONDITIONS AVAILABLE IN 2 GALLONS (7.6 LITERS) AND 5 GALLONS (18.9 LITERS) CAPACITY THROUGH LOCAL SEARS STORE OR SERVICE CENTER.

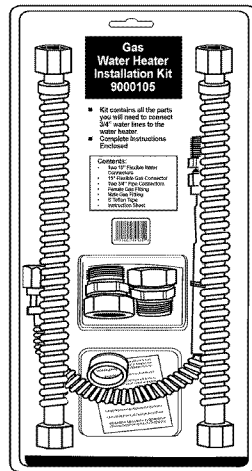

WATER HEATER INSTALLATION KIT WITH FLEXIBLE CONNECTORS FOR 3/4" (19.05 mm) COPPER PLUMBING AND FLEXIBLE GAS CONNECTOR WITH FITTINGS.

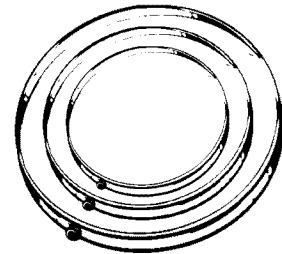

METAL DRAIN PANS AVAILABLE IN 20" (508 mm) DIAMETER FOR WATER HEATERS HAVING A DIAMETER 18" (457 mm) OR LESS, 24" (610mm) DIAMETER FOR WATER HEATERS HAVING A DIAMETER 22" (559 mm) OR LESS AND AVAILABLE IN 28" (711 mm) DIAMETER FOR WATER HEATERS HAVING A DIAMETER 26" (660 mm) OR LESS.

BASIC TOOLS

You may or may not need all these tools, depending on your type of installation. These tools can be purchased at your local Sears Store.

- Pipe Wrenches (2) 14" (356 mm)
- Screwdriver
- Tin Snips
- 6' (1.82 m) Tape or Folding Ruler
- Garden Hose
- Drill
- Pipe Dope or Teflon Tape



SLOT-HEAD SCREWDRIVER



PHILLIPS SCREWDRIVER



ROLL OF TEFLON TAPE (USE ONLY ON WATER CONNECTIONS)

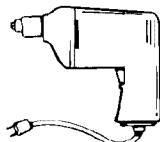

DRILL



TIN SNIPS



PIPE DOPE (SQUEEZE TUBE) USE FOR WATER AND GAS CONNECTIONS



GARDEN HOSE



6 FOOT TAPE



PIPE WRENCH

ADDITIONAL TOOLS NEEDED WHEN SWEAT SOLDERING

- Tubing Cutters or Hacksaw
- Propane Torch
- Soft Solder
- Solder Flux
- Emery Cloth
- Wire Brushes



TUBING CUTTER



PROPANE TORCH

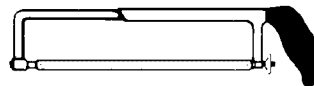

HACKSAW



ROLL OF EMERY CLOTH

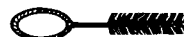

3/4" (19 mm) WIRE BRUSH



1/2" (13 mm) WIRE BRUSH



ROLL OF LEAD-FREE SOFT SOLDER



SOLDER FLUX

IMPORTANT INFORMATION ABOUT THIS WATER HEATER

This gas water heater was manufactured to voluntary safety standards to reduce the likelihood of a flammable vapor ignition incident. The new technology used in meeting these standards makes this product more sensitive to installation errors. Please review the following checklist and make any required installation upgrades or changes.

Questions? Contact Sears at (1-800-469-4663).

Installation Checklist

Water Heater Location

Water heater location is important and can affect system performance. Please check the following:

- Installation area free of corrosive elements and flammable materials.
- Centrally located with the water piping system (For new installations). Located as close to the gas piping, vent pipe system and 120VAC outlet as possible.
- Located indoors and in a vertical position. Protected from freezing temperatures.
- Proper clearances from combustible surfaces maintained and not installed directly on a carpeted floor.
- Provisions made to protect the area from water damage. Metal drain pan installed and piped to an adequate drain.
- Sufficient room to service the water heater. See Clearances and Accessibility section of this manual.
- Water heater not located near an air moving device.
- Is the installed environment dirty (excessive amounts of lint, dirt, dust, etc.)? If so, the air intake chamber louvers located on the side of the water heater will need to be cleaned periodically. Refer to the maintenance section of your water heater's manual for information on cleaning the "Air Intake Chamber Screen".

Combustion Air Supply and Ventilation

Check for sufficient combustion air supply. Insufficient air for the combustion of gas will result in a inferior burner flame "yellow-lazy", thereby allowing smoking and carbon formation (sooting) to build up in the combustion chamber.

Is the water heater installed in a closet or other small, enclosed space? If so:

- Are there openings for make-up air to enter and exit the room/area?
- Are the openings of sufficient size? Remember, if there are other gas-fired or air-consuming appliances in the same room, you need more make-up air. Refer to the Location Requirements section of this water heater manual for specific requirements.

Fresh air not taken from areas that contain negative pressure producing devices such as exhaust fans, dryers, fireplaces, etc.

- Is there a furnace/air handler in the same room space as the water heater? If so, has a return air duct system been attached that exits the room? If so, check for leaks on the air duct system. If no air duct system is present, correct immediately by contacting a local Heating, Ventilation, Air-Conditioning & Refrigeration (HVAC-R) authorized service provider.
- Fresh air supply free of corrosive elements and flammable vapors.
- Ductwork is the same cross-sectional area as the openings.

Vent Pipe System

Check for proper drafting at the water heater draft hood. Refer to the "Checking the Draft" section of this manual for the test procedure. If the procedure shows insufficient draft is present, please check the following.

- Draft hood properly installed.
- Vent connectors securely fastened with screws and supported properly to maintain six inch clearance.
- Vent connector made of approved material and sized correctly.
- Vent pipe system installed according to all local and state codes or, in the absence of local and state codes, the "National Fuel Gas Code", ANSI Z223.1(NFPA 54)-current edition.
- Flue baffle properly positioned in the flue tube.
- Check the vent system for restrictions/obstructions and check the vent termination height. Refer to the "Combustion Air and Ventilation" section of this water heater manual for specific requirements.
- Recheck for sufficient combustion air supply.

Water System Piping

- Temperature and pressure relief valve properly installed with a discharge line run to an open drain and protected from freezing.
- All piping properly installed and free of leaks.
- Heater completely filled with water.
- Closed system pressure build-up devices installed.
- Mixing valve (when applicable) installed per manufacturer's instructions (See Water Temperature Regulation section).

Gas Supply and Piping

- Gas type is the same as that listed on the water heater rating plate.
- Gas line equipped with shut-off valve, union, and drip leg.
- Use pipe joint compound or teflon tape marked as being resistant to the action of petroleum gases.
- Adequate pipe size and approved pipe material.
- An approved noncorrosive leak detection solution used to check all connections and fittings for possible gas leaks. Correct any leak found.

Electrical Supply

- Water heater to be located as close as possible to a 120VAC outlet (extension cord is not allowed).
- Electrical supply installed according to all local and state codes or, in the absence of local and state codes, the "National Electrical Code", ANSI/NFPA 70 current edition.

INSTALLATION INSTRUCTIONS

Removing the Old Water Heater

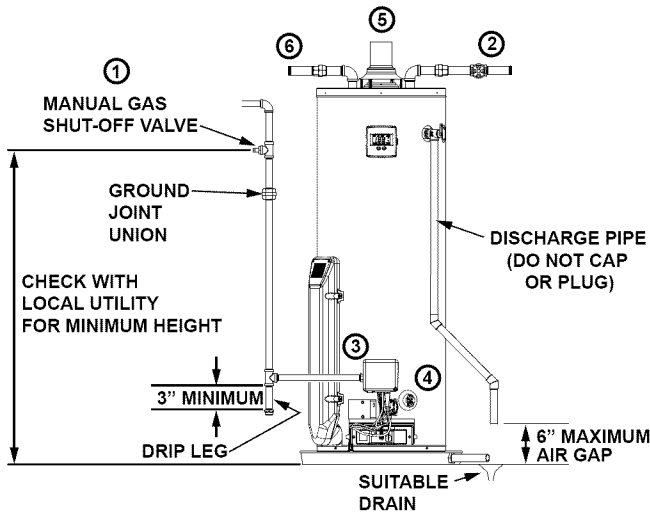

FIGURE 2.

1. Turn "OFF" the gas supply to the water heater.

If the main gas line shutoff valve serving all gas appliances is used, also shut "OFF" the gas at each appliance. Leave all gas appliances shut "OFF" until the water heater installation is completed. See Figures 2 and 3.

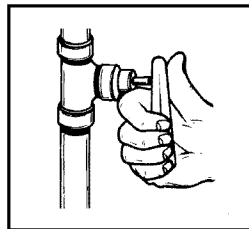

FIGURE 3.

2. Open a nearby hot water faucet until the water is no longer hot. When the water has cooled, turn "OFF" the water supply to the water heater at the water shut off valve or water meter. Some installations require that the water be turned off to the entire house. See Figures 2 and 4.

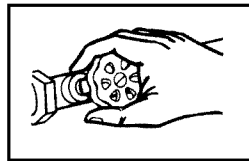

FIGURE 4.

3. Check again to make sure the gas supply is "OFF" to the water heater. Then disconnect the gas supply connection from the gas control valve.

▲ DANGER

- Burn hazard
- Hot water discharge.
- Keep hands clear of drain valve discharge.

4. Attach a hose to the water heater drain valve and put the other end in a floor drain or outdoors. (See Figures 2 and 5.) Open the water heater drain valve.

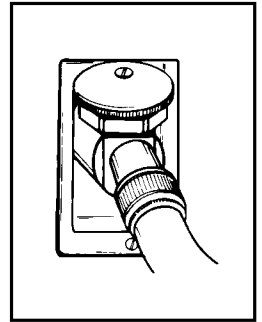

FIGURE 5.

5. Disconnect the vent pipe from the draft hood where it connects to the water heater. In most installations the vent pipe can be lifted off after any screw or other attached devices are removed. Dispose of the draft hood. The new water heater has a draft hood which must be used for proper operation.

6. If you have copper piping to the water heater, the two copper water pipes can be cut with a hacksaw approximately four inches away from where they connect to the water heater. See Figure 6. This will avoid cutting off pipes too short. Additional cuts can be made later if necessary. Disconnect the temperature-pressure relief valve drain line. When the water heater is drained, disconnect the hose from the drain valve. Close the drain valve. The water heater is now completely disconnected and ready to be removed.

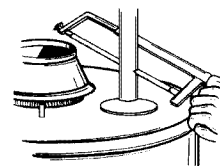

FIGURE 6.

If you have galvanized pipes to the water heater, loosen the two galvanized pipes with a pipe wrench at the union in each line. Also disconnect the piping remaining to the water heater. See Figure 7. These pieces should be saved since they may be needed when reconnecting the new water heater. Disconnect the temperature-pressure relief valve drain line. When the water heater is drained, disconnect the hose from the drain valve. Close the drain valve. The water heater is now completely disconnected and ready to be removed. Mineral buildup or sediment may have accumulated in the old water heater. This causes the water heater to be much heavier than normal and this residue, if spilled out, could cause staining.

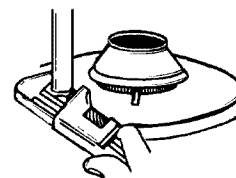

FIGURE 7.

Location Requirements

⚠ WARNING
Carbon Monoxide Poisoning Hazard
Do not install in a mobile home.
Doing so can result in carbon monoxide poisoning and death.

The FVIR System is designed to reduce the risk of flammable vapor-related fires. Flammable liquids (such as gasoline, solvents, propane, etc.) emit flammable vapors which can be ignited by a gas water heater's hot surface igniter or main burner. The resulting flashback and fire can cause death or serious burns to anyone in the area.

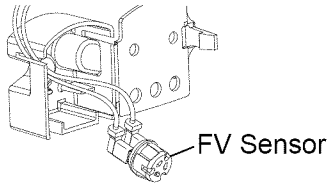

FIGURE 8.

This heater is equipped with a FV sensor for detecting the presence of flammable vapors. When the sensor detects those vapors, the unit will shut down and not operate. Should this happen, please refer to the troubleshooting guide on pages 38-40 (numbers 9,11,12). Even though this water heater is a flammable vapors ignition resistant water heater and is designed to reduce the chances of flammable vapors being ignited, gasoline and other flammable substances should never be stored or used in the same vicinity or area containing a gas water heater or other open flame or spark producing appliance.

⚠ WARNING
FIRE AND EXPLOSION HAZARD
Can result in serious injury or death
Do not store or use gasoline or other flammable vapors and liquids in the vicinity of this or any other appliance. Storage of or use of gasoline or other flammable vapors or liquids in the vicinity of this or any other appliance can result in serious injury or death.
Read and follow water heater warnings and instructions

Do not use or store flammable products such as gasoline, solvents, or adhesives in the same room or area near the water heater. If such flammables must be used, all gas burning appliances in the vicinity must be shut off and their pilot lights extinguished. Open the doors and windows for ventilation while flammable substances are in use.

If flammable liquids or vapors have spilled or leaked in the area of the water heater, leave the area immediately and call the fire department from a neighbor's home. Do not attempt to clean the spill until all ignition sources have been extinguished.

⚠ WARNING
Fire or Explosion Hazard
<ul style="list-style-type: none"> • Read instruction manual before installing, using or servicing water heater. • Improper use may result in fire or explosion. • Maintain required clearances to combustibles.

Keep combustibles such as boxes, magazines, clothes, etc. away from the water heater area.

Site Location

- Select a location near the center of the water piping system. The water heater must be installed indoors and in a vertical position on a level surface. DO NOT install in bathrooms, bedrooms, or any occupied room normally kept closed.
- Locate the water heater as close to the chimney or gas vent as practical. Consider the vent system piping and combustion air supply requirements when selecting the water heater location. The venting system must be able to run from the water heater to termination with minimal length and elbows.
- Locate the water heater near the existing gas piping. If installing a new gas line, locate the water heater to minimize the pipe length and elbows.
- The water heater should be located in an area not subject to freezing temperatures. Water heaters located in unconditioned spaces (i.e., attics, basements, etc.) may require insulation of the water piping and drain piping to protect against freezing. The drain and controls must be easily accessible for operation and service. Maintain proper clearances as specified on the water heater.
- Do not locate the water heater near an air-moving device. The operation of air-moving devices such as exhaust fans, ventilation systems, clothes dryers, fireplaces, etc., can affect the proper operation of the water heater. Special attention must be given to conditions these devices may create. Flow reversal of flue gases may cause an increase of carbon monoxide inside of the dwelling (Figure 10).
- The water heater is to be located as close as possible to a 120VAC outlet. NOTE: all electrical wiring should be in accordance to the NEC and all local/state electrical codes (extension cord is **not** allowed).

NOTE: This water heater must be installed according to all local and state codes or, in the absence of local and state codes, the "National Fuel Gas Code", ANSI Z223.1(NFPA 54)-current edition and the "National Electrical Code", ANSI/NFPA 70 current edition.

CAUTION

Property Damage Hazard

- All water heaters eventually leak
- Do not install without adequate drainage.

IMPORTANT: The water heater should be located in an area where leakage of the tank or connections will not result in damage to the area adjacent to the water heater or to lower floors of the structure. Due to the normal corrosive action of water, the tank will eventually leak after an extended period of time. Also any external plumbing leak, including those from improper installation, may cause early failure of the tank due to corrosion if not repaired. If the homeowner is uncomfortable with making the repair a qualified technician should be contacted. A suitable metal drain pan should be installed under the water heater as shown below, to help protect the property from damage which may occur from condensate formation or leaks in the piping connections or tank. The pan must limit the water level to a maximum depth of 1-3/4" and be two inches wider than the heater and piped to an adequate drain. Locate the water heater near a suitable indoor drain. Outside drains are subject to freezing temperatures which can obstruct the drain line. The piping should be at least 3/4" ID and pitched for proper drainage.

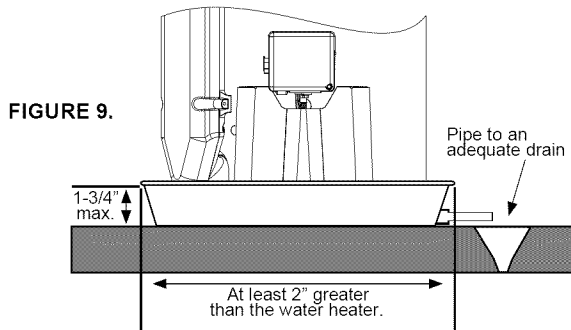

Water heater life depends upon water quality, water usage, water temperature and the environment in which the water heater is installed. Water heaters are sometimes installed in locations where leakage may result in property damage, even with the use of a metal drain pan piped to a drain. However, unanticipated damage can be reduced or prevented by a leak detector or water shut-off device used in conjunction with a piped metal drain pan. These devices are available from some plumbing supply wholesalers and retailers, and detect and react to leakage in various ways:

- Sensors mounted in the metal drain pan that trigger an alarm or turn off the incoming water to the water heater when water is detected.
- Sensors mounted in the metal drain pan that turn off the water supply to the entire home when water is detected in the metal drain pan.
- Water supply shut-off devices that activate based on the water pressure differential between the cold water and hot water pipes connected to the water heater.
- Devices that will turn off the gas supply to a gas water heater while at the same time shutting off its water supply.

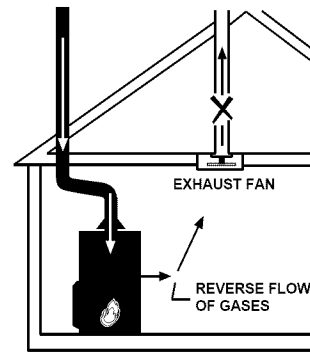

Clearances and Accessibility

NOTE: Minimum clearances from combustible materials are stated on the label on the front of the heater adjacent to the gas control valve/thermostat of the water heater.

The water heater is certified for installation on a combustible floor.

- **IMPORTANT:** If installing over carpeting, the carpeting must be protected by a metal or wood panel beneath the water heater. The protective panel must extend beyond the full width and depth of the water heater by at least five inches (127mm) in any direction; or if in an alcove or closet installation, the entire floor must be covered by the panel.
- Figure 11 may be used as a reference guide to locate the specific clearance locations. A minimum of 5 inches of front clearance should be provided for inspection and service.

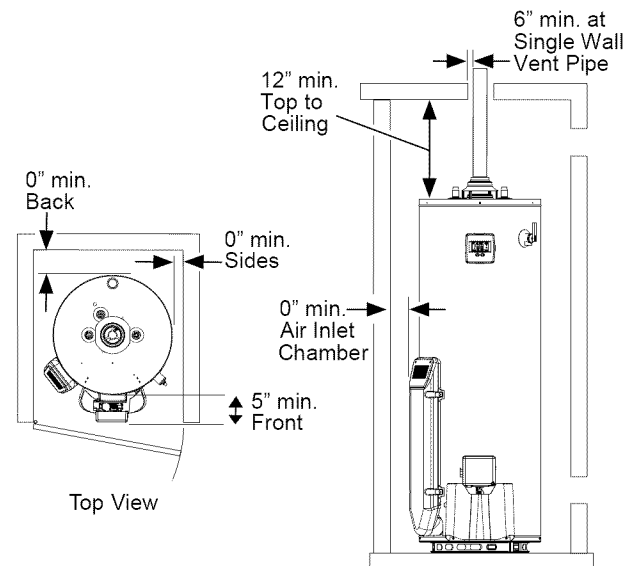

FIGURE 11.

High Altitude Installation

This water heater should not be installed for operation at elevations above 10,100 ft. (3,078 m).

GAS SUPPLY

WARNING



Explosion Hazard

- Use a new CSA approved gas supply line.
- Install a shut-off valve.
- Do not connect a natural gas water heater to an L.P. gas supply.
- Do not connect an L.P. gas water heater to a natural gas supply.
- Failure to follow these instructions can result in death, explosion, or carbon monoxide poisoning.

Gas Requirements

IMPORTANT: Read the rating plate to be sure the water heater is made for the type of gas you will be using in your home. This information will be found on the rating plate located near the gas control valve/thermostat. If the information does not agree with the type of gas available, do not install or light. Call your dealer.

NOTE: An odorant is added by the gas supplier to the gas used by this water heater. This odorant may fade over an extended period of time. Do not depend upon this odorant as an indication of leaking gas.

Gas Piping

The gas piping must be installed according to all local and state codes or, in the absence of local and state codes, the "National Fuel Gas Code", ANSI Z223.1(NFPA 54)-current edition.

Tables 1 and 2 on the following page provide a sizing reference for commonly used gas pipe materials. Consult the "National Fuel Gas Code" for the recommended gas pipe size of other materials.

NOTE: Use pipe joint compound or teflon tape marked as being resistant to the action of petroleum gases (See Figure 12.)

1. Install a readily accessible manual shut-off valve in the gas supply line as recommended by the local utility. Know the location of this valve and how to turn off the gas to this unit.
2. Install a drip leg (if not already incorporated as part of the water heater) as shown. The drip leg must be no less than three inches long for the accumulation of dirt, foreign material, and water droplets.
3. Install a ground joint union between the gas control valve/thermostat and the manual shut-off valve. This is to allow easy removal of the gas control valve/ thermostat.
4. Turn the gas supply on and check for leaks. Test all connections by brushing on an approved noncorrosive leak-detection solution. Bubbles will show a leak. Correct any leak found.

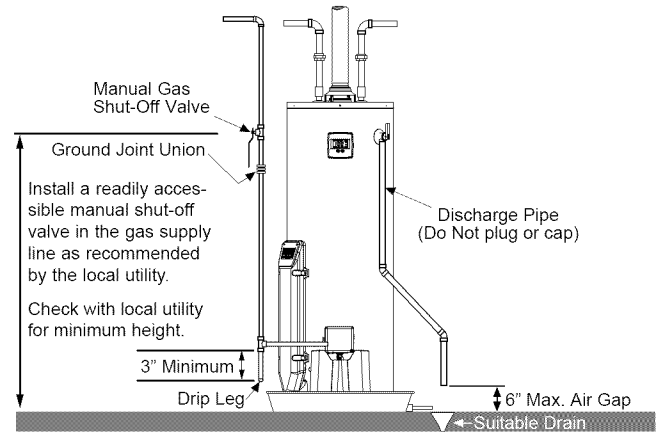

FIGURE 12.

Gas Pressure

WARNING



Explosion Hazard

- Gas leaks can not always be detected by smell.
- Gas suppliers recommend that you use a gas detector approved by UL or CSA.
- For more information, contact your gas supplier.
- If a gas leak is detected, follow the "What to do if you smell gas" instructions on the cover of this manual.

IMPORTANT: The gas supply pressure must not exceed the maximum supply pressure as stated on the water heater's rating plate. The minimum supply pressure is for the purpose of input adjustment.

Gas Pressure Testing

IMPORTANT: This water heater and its gas connection must be leak tested before placing the appliance in operation.

- If the code requires the gas lines to be tested at a pressure exceeding 14" W.C., the water heater and its manual shut-off valve must be disconnected from the gas supply piping system and the line capped.
- If the gas lines are to be tested at a pressure less than 14" W.C., the water heater must be isolated from the gas supply piping system by closing its manual shut-off valve.

NOTE: Air may be present in the gas lines and could prevent the burner from lighting on initial start-up. The gas lines should be purged of air by a qualified technician after installation of the gas piping system. While purging the gas piping system of air, insure that the fuel is not spilled in the area of the water heater installation, or any source of ignition (NOTE: spilled fuel may trip the FV Sensor preventing heater from starting). If the fuel is spilled while purging the piping system of air follow the "WHAT TO DO IF YOU SMELL GAS" instructions on the cover of this manual.

Gas Pipe Capacity Table

⚠ WARNING



Explosion Hazard

- Use a new CSA approved gas supply line.
- Install a shut-off valve.
- Do not connect a natural gas water heater to an L.P. gas supply.
- Do not connect an L.P. gas water heater to a natural gas supply.
- Failure to follow these instructions can result in death, explosion, or carbon monoxide poisoning.

⚠ WARNING



Explosion Hazard

- Gas leaks can not always be detected by smell.
- Gas suppliers recommend that you use a gas detector approved by UL or CSA.
- For more information, contact your gas supplier.
- If a gas leak is detected, follow the “What to do if you smell gas” instructions on the cover of this manual.

Table 1
Natural Gas Pipe Capacity Table (Cu. Ft./Hr.)
 Capacity of gas pipe of different diameters and lengths in cu. ft. per hr. with pressure drop of 0.3 in. and specific gravity of 0.60 (natural gas.)

Nominal Iron Pipe Size, in.	Length of Pipe, Feet													
	10	20	30	40	50	60	70	80	90	100	125	150	175	200
1/2	132	92	73	63	56	50	46	43	40	38	34	31	28	26
3/4	278	190	152	130	115	105	96	90	84	79	72	64	59	55
1	520	350	285	245	215	195	180	170	160	150	130	120	110	100
1-1/4	1050	730	590	500	440	400	370	350	320	305	275	250	225	210
1-1/2	1600	1100	890	760	670	610	560	530	490	460	410	380	350	320

After the length of pipe has been determined, select the pipe size which will provide the minimum cubic feet per hour required for the gas input rating of the water heater. By formula:

$$\text{Min. Cu. Ft. Per Hr. Required} = \frac{\text{Gas Input of Water Heater (BTU/HR)}}{\text{Heating Value of Gas (BTU/FT}^3\text{)}}$$

The gas input of the water heater is marked on the water heater data plate. The heating value of the gas (BTU/FT³) may be determined by consulting the local natural gas utility.

Table 2
LP Gas Capacity Table
 Maximum capacity of pipe in thousands of BTU per hour of undiluted liquefied petroleum gases (at 11 inches water column pressure.) Based on a pressure drop of 0.5 inch water column.

Nominal Iron Pipe Size, in.	Length of Pipe, Feet											
	10	20	30	40	50	60	70	80	90	100	125	150
1/2	275	189	152	129	114	103	96	89	83	78	69	63
3/4	576	393	315	267	237	217	196	185	173	162	146	132
1	1071	732	590	504	448	409	378	346	322	307	275	252
1-1/4	2205	1496	1212	1039	913	834	771	724	677	630	567	511

Example: Input BTU requirement of the water heater 100,000 BTUH.
 Total pipe length, 80 feet = 3/4" IPS required.

Additional tables are available in the latest edition of the "National Fuel Gas Code", ANSI Z223.1.

COMBUSTION AIR & VENTILATION

! WARNING

Carbon Monoxide Warning

Water heater must be vented to outdoors.

Vent must be installed by a qualified technician using the installation instructions.

Examples of a qualified technician include: gas technicians, authorized gas company personnel, and authorized service persons.

Failure to so do can result in death or carbon monoxide poisoning.

IMPORTANT: Air for combustion and ventilation must not come from a corrosive atmosphere. Any failure due to corrosive elements in the atmosphere is excluded from warranty coverage. The following types of installation (not limited to the following) will require outdoor air for combustion due to chemical exposure and may reduce but not eliminate the presence of corrosive chemicals in the air:

- beauty shops
- photo processing labs
- buildings with indoor pools
- water heaters installed in laundry, hobby, or craft rooms
- water heaters installed near chemical storage areas

Combustion air must be free of acid-forming chemicals such as sulfur, fluorine, and chlorine. These elements are found in aerosol sprays, detergents, bleaches, cleaning solvents, air fresheners, paint, and varnish removers, refrigerants, and many other commercial and household products. When burned, vapors from these products form highly corrosive acid compounds. These products should not be stored or used near the water heater or air inlet.

Combustion and ventilation air requirements are determined by the location of the water heater. The water heater may be located in either an open (unconfined) area or in a confined area or small enclosure such as a closet or small room. Confined spaces are areas with less than 50 cubic feet for each 1,000 BTUH of the total input for all gas-using appliances.

Unconfined Space

A water heater in an unconfined space uses indoor air for combustion and requires at least 50 cubic feet for each 1,000 BTUH of the total input for all gas appliances. The table below shows a few examples of the minimum square footage (area) required for various BTUH inputs.

TABLE 3

BTUH Input	Minimum Square Feet with 8' Ceiling	Typical Room with 8' Ceiling
30,000	188	9 x 21
45,000	281	14 x 20
60,000	375	15 x 25
75,000	469	15 x 31
90,000	563	20 x 28
105,000	657	20 x 33
120,000	750	25 x 30
135,000	844	28 x 30

IMPORTANT:

- The area must be open and be able to provide the proper air requirements to the water heater. Areas that are being used for storage or contain large objects may not be suitable for water heater installation.
- Water heaters installed in open spaces in buildings with unusually tight construction may still require outdoor air to function properly. In this situation, outside air openings should be sized the same as for a confined space.
- Modern home construction usually requires supplying outside air into the water heater area.

Confined Space

For the correct and proper operation of this water heater, ample air must be supplied for the combustion, ventilation, and dilution of flue gases. Small enclosures and confined areas must have two permanent openings so that sufficient fresh air can be drawn from outside of the enclosure. One opening shall be within 12 inches of the top and one within 12 inches of the bottom of the enclosure as shown in Figure 13.

The size of each opening (free area) is determined by the total BTUH input of all gas utilization equipment (i.e., water heaters, furnaces, clothes dryers, etc.) and the method by which the air is provided. The BTUH input can be found on the water heater rating plate. Additional air can be provided by two methods:

1. All air from inside the building.
2. All air from outdoors.

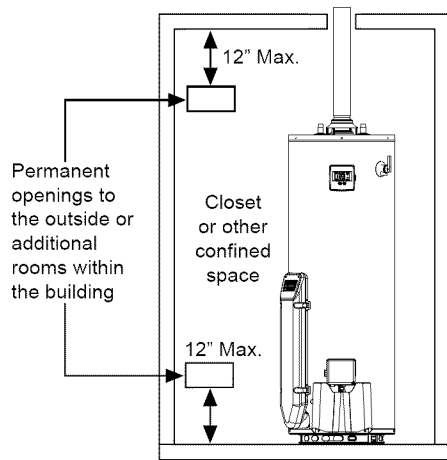

FIGURE 13.

All Air from the Building

When additional air is to be provided to the confined area from additional room(s) within the building, the total volume of the room(s) must be of sufficient size to properly provide the necessary amount of fresh air to the water heater and other gas utilization equipment in the area. If you are unsure that the structure meets this requirement, contact your local gas utility company or other qualified agency for a safety inspection. Each of the two openings shall have a minimum free area of 1 square inch per 1,000 BTUH of the total input rating of all gas utilization equipment in the confined area, but not less than 100 square inches (Figure 14).

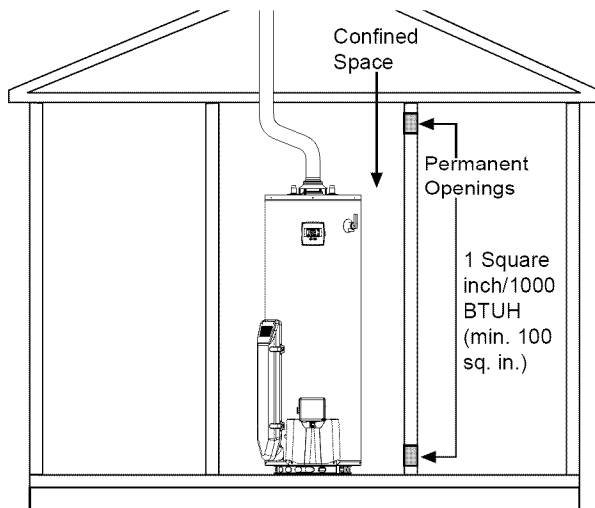

FIGURE 14.

All Air from Outdoors

Outdoor fresh air can be provided to a confined area either directly or by the use of vertical and horizontal ducts. The fresh air can be taken from the outdoors or from crawl or attic spaces that freely communicate with the outdoors. Attic or crawl spaces cannot be closed and must be properly ventilated to the outside. Ductwork must be of the same cross-sectional area as the

free area of the opening to which they connect. The minimum dimension of rectangular air ducts cannot be less than three inches.

The size of each of the two openings is determined by the method in which the air is to be provided. Refer to Table 4 to calculate the minimum free area for each opening. Figures 15, 16, 17 and 18 are typical examples of each method.

Louvers and Grilles

In calculating free area for ventilation and combustion air supply openings, consideration must be given to the blocking effect of protection louvers, grilles, and screens. These devices can reduce airflow, which in turn may require larger openings to achieve the required minimum free area. Screens must not be smaller than 1/4" mesh. If the free area through a particular design of louver or grille is known, it should be used in calculating the specified free area of the opening. If the design and free area are not known, it can be assumed that most wood louvers will allow 20 - 25% of free area while metal louvers and grilles will allow 60 - 75% of free area.

Louvers and grilles must be locked open or interconnected with the equipment so that they are opened automatically during equipment operation.

Keep louvers and grilles clean and free of debris or other obstructions.

TABLE 4

Minimum Free Area of Permanent Openings for Ventilation and Combustion Air Supply - All Air from Outdoors Only.

Based on total BTUH input rating for all utilizing equipment within the confined space.

Opening Source	Minimum Free Area Per Opening (sq. in.)	Reference Drawing
*Direct to outdoors	1 sq. in. per 4000 BTUH	Figure 15
Vertical Ducts	1 sq. in. per 4000 BTUH	Figure 16
Horizontal Ducts	1 sq. in. per 2000 BTUH	Figure 17
Single Opening	1 sq. in. per 3000 BTUH	Figure 18

Example: A water heater with an input rating of 50,000 BTUH using horizontal ducts would require each opening to have a minimum free area of 25 square inches.

Minimum free area = 50,000 BTUH x 1 sq. in. / 2000 BTUH = 25 sq. in.

* These openings connect directly with the outdoors through a ventilated attic, a ventilated crawl space, or through an outside wall.

Consult the local codes of your area for specific ventilation and combustion air requirements.

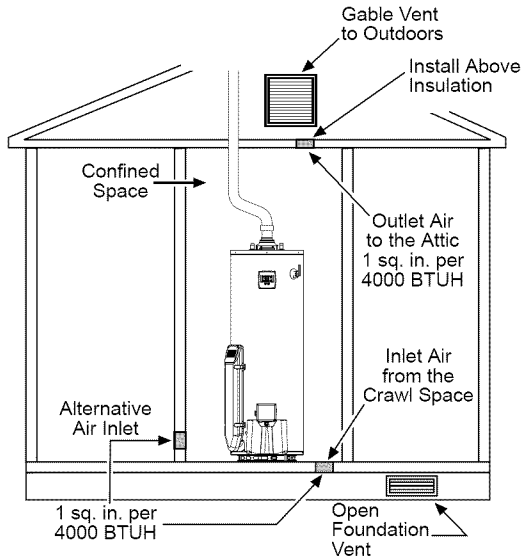

All Air From Outdoors: Inlet Air From Ventilated Crawl Space/Outlet Air To Ventilated Attic

FIGURE 15.

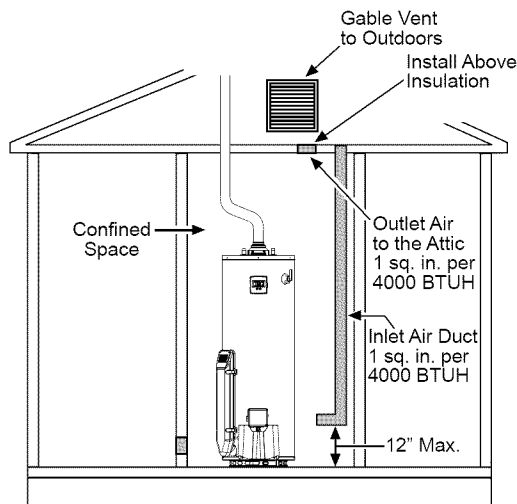

All Air from Outdoors Through Ventilated Attic

FIGURE 16.

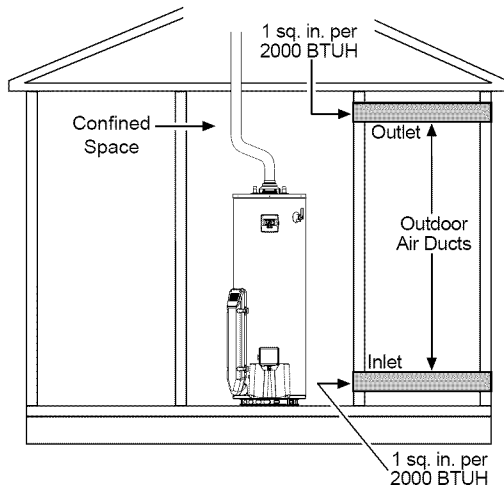

All Air From Outdoors Using Horizontal Ducts

FIGURE 17.

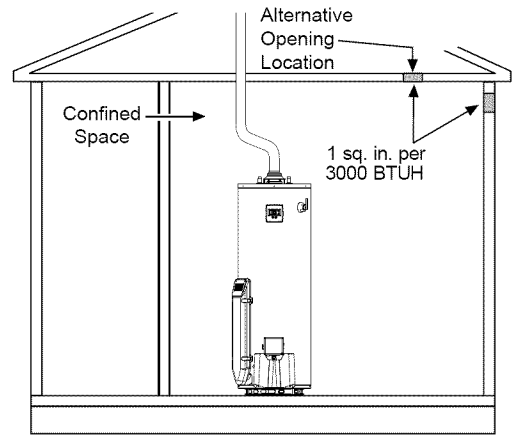

All Air From Outdoors - Using A Single Permanent Opening

FIGURE 18.

Vent Pipe System

This water heater uses a non-direct, single-pipe vent system to remove exhaust gases created by the burning of fossil fuels. Air for combustion is taken from the immediate water heater location or is ducted in from the outside (see "Combustion Air Supply and Ventilation").

This water heater must be properly vented for the removal of exhaust gases to the outside atmosphere. Correct installation of the vent pipe system is mandatory for the proper and efficient operation of this water heater and is an important factor in the life of the unit.

The vent pipe must be installed according to all local and state codes or, in the absence of local and state codes, the "National Fuel Gas Code", ANSI Z223.1(NFPA 54)-current edition. The vent pipe installation must not be obstructed so as to prevent the removal of exhaust gases to the outside atmosphere.

IMPORTANT: The use of vent dampers is not recommended by the manufacturer of this water heater. Although some vent dampers are certified by CSA International, this certification applies to the vent damper device only and does not mean they are certified for use on this water heater.

U.L. recognized fuel gas and carbon monoxide (CO) detectors are recommended in all applications and should be installed using the manufacturer's instructions and local codes, rules, or regulations.

IMPORTANT: If you lack the necessary skills required to properly install this venting system, you should not proceed, but get help from a qualified technician.

Draft Hood Installation

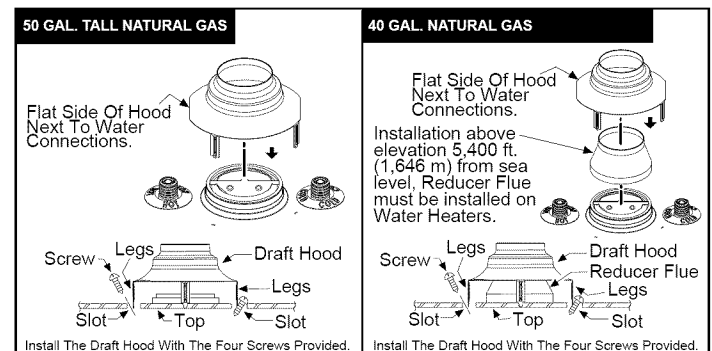

FIGURE 19.

40 Gallon Water Heaters: NOTE: Reducer flue must be installed on the water heaters above elevation 5,400 Ft. (1,646 m) from sea level. Separate the reducer flue from the draft hood and align the reducer flue on 40 gallon units over top of baffle as shown in Figure 19 (see next paragraph for draft hood installation instructions).

40 & 50 Gallon Water Heaters' Draft Hood Installation: Align the legs of the draft hood with the slots provided. Insert the legs and secure the draft hood to the water heater's top with the four screws provided as shown in Figure 19. Do not alter the draft hood in any way. If you are replacing an existing water heater, be sure to use the draft hood supplied with this water heater.

Vent Pipe Size

It is important that you follow the guidelines in these instructions for sizing a vent pipe system. If a transition to a larger vent size is required, the vent transition connection must be made at the draft hood outlet.

Vent Connectors

1. Type B, Double wall, U.L. Listed Vent Pipe.
2. Single wall Vent Pipe.

Maintain the manufacturer's specified minimum clearance from combustible materials when using type B double wall vent pipe. Vent connectors made of type B, double wall vent pipe material may pass through walls or partitions constructed of combustible material if the minimum listed clearance is maintained.

Maintain a six inch minimum clearance from all combustible materials when using single wall vent pipe.

IMPORTANT: Single wall vent pipe cannot be used for water heaters located in attics and may not pass through attic spaces, crawl spaces or any confined or inaccessible location. A single wall metal vent connector cannot pass through any interior wall. When installing a vent connector, please note the following (See Figures 20-22):

- Install the vent connector avoiding unnecessary bends, which create resistance to the flow of vent gases.
- Install without dips or sags with an upward slope of at least 1/4-inch per foot.
- Joints must be fastened by sheet metal screws or other approved means. It must be supported to maintain clearances and prevent separation of joints and damage.
- The length of the vent connector cannot exceed 75% of the vertical vent height.
- The vent connector must be accessible for cleaning, inspection, and replacement.
- Vent connectors cannot pass through any ceiling, floor, firewall, or fire partition.
- It is recommended (but not mandatory) that a minimum 12 inches of vertical vent pipe be installed on the draft hood prior to any elbow in the vent system.

IMPORTANT: Existing vent systems must be inspected for obstructions, corrosion, and proper installation.

Chimney Connection

IMPORTANT: Before connecting a vent to a chimney, make sure the chimney passageway is clear and free of obstructions. The chimney must be cleaned if previously used for venting solid fuel appliances or fireplaces. Also consult local and state codes for proper chimney sizing and application or, in the absence

of local and state codes, the "National Fuel Gas Code", ANSI Z223.1(NFPA 54)-current edition.

- The connector must be installed above the extreme bottom of the chimney to prevent potentially blocking the flue gases.
- The connector must be firmly attached and sealed to prevent it from falling out.
- To aid in removing the connector, a thimble or slip joint may be used.
- The connector must not extend beyond the inner edge of the chimney as it may restrict the space between it and the opposite wall of the chimney (Figure 20).

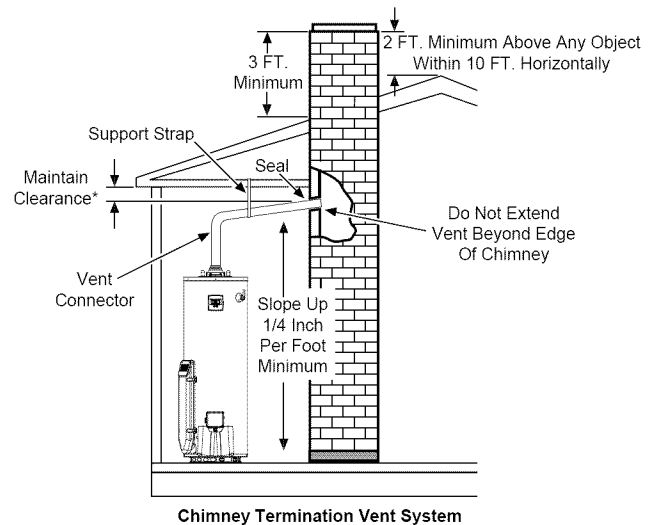

FIGURE 20.

Do not terminate the vent connector in a chimney that has not been certified for this purpose. Some local codes may prohibit the termination of vent connectors in a masonry chimney.

Vertical Exhaust Gas Vent

Vertical exhaust gas vents must be installed with U.L. listed type B vent pipe according to the vent manufacturer's instructions and the terms of its listing.

It must be connected to the water heater's draft hood by a listed vent connector or by directly originating at the draft hood opening.

Vertical gas vents must terminate with a listed cap or other roof assembly and be installed according to their manufacturer's instructions.

Gas vents must be supported to prevent damage, joint separation, and maintain clearances to combustible materials (Figures 21 and 22).

IMPORTANT: This gas vent must be terminated in a vertical position to facilitate the removal of the burnt gases.

An unused chimney flue or masonry enclosure may be used as a passageway for the installation of a gas vent (Figure 22).

Common (combined) venting is allowable with vertical type B vent systems and lined masonry chimneys as long as proper draft for the water heater is established under all conditions of operation. **CAUTION:** DO NOT common vent this water heater with any power vented appliance.

Figures 20-22 are examples of vent pipe system installations and may or may not be typical for your specific application. Consult the "National Fuel Gas Code", NFPA 54, ANSI Z223.1-current edition and the guidelines set forth by prevailing local codes.

WATER SYSTEM PIPING

Piping Installation

Piping, fittings, and valves should be installed according to the installation drawing (Figure 23). If the indoor installation area is subject to freezing temperatures, the water piping must be protected by insulation.

The water supply pressure should not exceed 80 psi. If this occurs, a pressure reducing valve with a bypass should be installed in the cold water inlet line. This should be placed on the supply to the entire house in order to maintain equal hot and cold water pressures.

IMPORTANT: Heat cannot be applied to the water fittings on the heater as they may contain nonmetallic parts. If solder connections are used, solder the pipe to the adapter before attaching the adapter to the hot and cold water fittings.

IMPORTANT: Always use a good grade of joint compound and be certain that all fittings are drawn up tight.

1. Install the water piping and fittings as shown in Figure 23. Connect the cold water supply (3/4" NPT) to the cold water inlet fitting. Connect the hot water piping (3/4" NPT) to the hot water outlet fitting.

IMPORTANT: Some models may contain energy saving heat traps to prevent the circulation of hot water within the pipes. Do not remove the inserts within the heat traps.

2. The installation of unions in both the hot and cold water supply lines is recommended for ease of removing the water heater for service or replacement.
3. The manufacturer of this water heater recommends installing a mixing valve or an anti-scald device in the domestic hot water line as shown in Figure 24. These valves reduce the point-of-use temperature of the water by mixing cold and hot water and are readily available for use.
4. If installing the water heater in a closed water system, install an expansion tank in the cold water line as specified under Closed System/Thermal Expansion.
5. Install a shut-off valve in the cold water inlet line. It should be located close to the water heater and be easily accessible. Know the location of this valve and how to shut off the water to the heater.
6. A temperature and pressure relief valve must be installed in the opening marked "Temperature and Pressure (T & P) Relief Valve" on the water heater. A discharge line must be added to the opening of the T&P Relief Valve. Follow the instructions under Temperature and Pressure Relief Valve.
7. After piping has been properly connected to the water heater, remove the aerator at the nearest hot water faucet. Open the hot water faucet and allow the tank to completely fill with water. To purge the lines of any excess air, keep the hot water faucet open for 3 minutes after a constant flow of water is obtained. Close the faucet and check all connections for leaks.

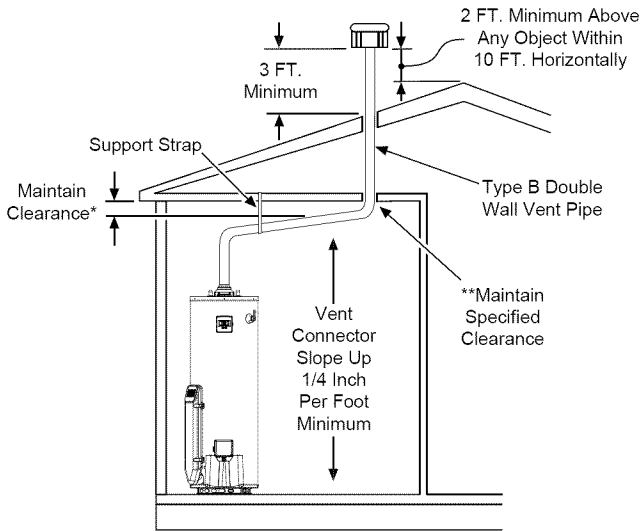

Venting Gas Vent System With Type B Double Wall Vent Pipe.

FIGURE 21.

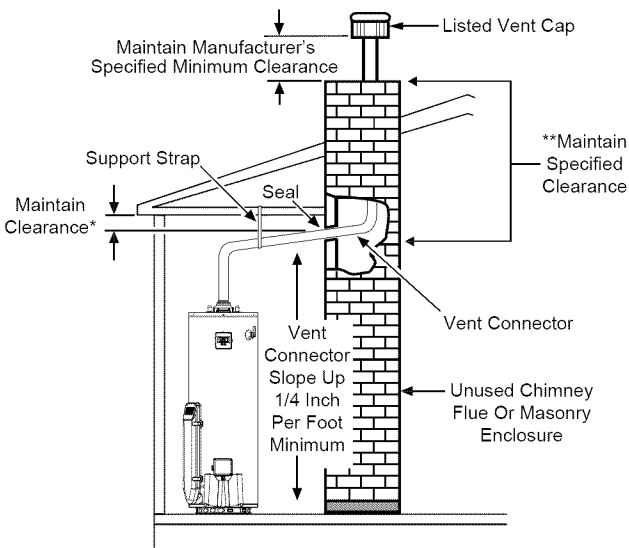

Venting Through Chimney With Type B Double Wall Vent Pipe.

FIGURE 22.

* Maintain vent pipe clearance requirements to local, state and/or the "National Fuel Gas Code", ANSI Z223.1(NFPA 54)-current edition.

** NFPA 211, Standard for Chimneys, Fireplaces, Vents, and Solid Fuel-Burning Appliances states that these chimneys are intended to be installed in accordance with the installation instructions provided with each chimney support assembly. Minimum air space clearance to combustible materials should be maintained as marked on the chimney sections.

Closed System/Thermal Expansion

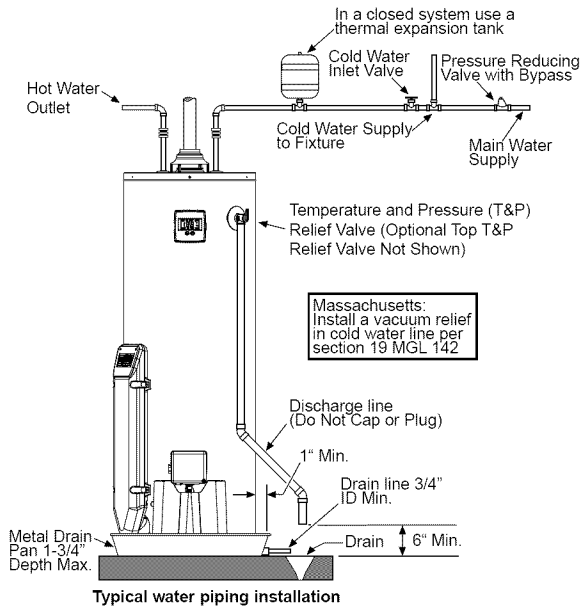

FIGURE 23.

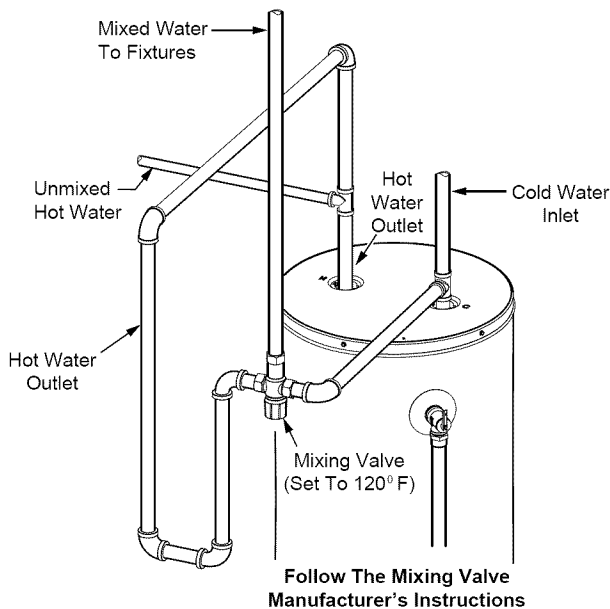

FIGURE 24.

Please note the following:

- The system should be installed only with piping that is suitable for potable (drinkable) water such as copper, CPVC, or polybutylene. This water heater must not be installed using iron piping or PVC water piping.
- Use only pumps, valves, or fittings that are compatible with potable water.
- It is recommended that only full flow ball or gate valves are used in water piping installations. The use of valves that may cause excessive restriction to water flow is not recommended.
- Use only 95/5 tin-antimony or other equivalent solder. Any lead based solder must not be used.
- Piping that has been treated with chromates, boiler seal, or other chemicals must not be used.
- Chemicals that may contaminate the potable water supply must not be added to the piping system.

CAUTION

Property Damage Hazard

- All water heaters eventually leak
- Do not install without adequate drainage.

As water is heated, it expands (thermal expansion). In a closed system, the volume of water will increase. As the volume of water increases, there will be a corresponding increase in water pressure due to thermal expansion. Thermal expansion can cause premature tank failure (leakage). This type of failure is not covered under the limited warranty. Thermal expansion can also cause intermittent temperature-pressure relief valve operation: water discharged from the valve due to excessive pressure build up. The temperature-pressure relief valve is not intended for the constant relief of thermal expansion. This condition is not covered under the limited warranty.

A properly-sized thermal expansion tank should be installed on all closed systems to control the harmful effects of thermal expansion. Contact a plumbing service agency or your retail supplier regarding the installation of a thermal expansion tank.

Temperature and Pressure Relief Valve

WARNING

Explosion Hazard

- Temperature-pressure relief valve must comply with ANSI Z21.22-CSA 4.4 and ASME code.
- Properly sized temperature-pressure relief valve must be installed in opening provided.
- Can result in overheating and excessive tank pressure.
- Can cause serious injury or death.

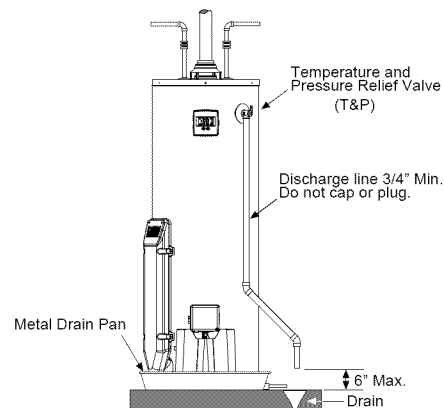

FIGURE 25.

For protection against excessive pressures and temperatures, a temperature and pressure relief valve must be installed in the opening marked “T & P RELIEF VALVE” (see Figure 25). This valve must be design certified by a nationally recognized testing laboratory that maintains periodic inspection of the production of listed equipment or materials as meeting the requirements for Relief Valves for Hot Water Supply Systems, ANSI Z21.22. The function of the temperature and pressure relief valve is to discharge water in large quantities in the event of excessive temperature or pressure developing in the water heater. The valve’s relief pressure must not exceed the working pressure of the water heater as stated on the rating plate.

IMPORTANT: Only a new temperature and pressure relief valve should be used with your water heater. Do not use an old or existing valve as it may be damaged or not adequate for the working pressure of the new water heater. Do not place any valve between the relief valve and the tank.

The Temperature & Pressure Relief Valve:

- Must not be in contact with any electrical part.
- Must be connected to an adequate discharge line.
- Must not be rated higher than the working pressure shown on the rating plate of the water heater.

The Discharge Line:

- Must not be smaller than the pipe size of the relief valve or have any reducing coupling installed in the discharge line.
- Must not be capped, blocked, plugged or contain any valve between the relief valve and the end of the discharge line.
- Must terminate a maximum of six inches above a floor drain or external to the building. In cold climates, it is recommended that the discharge pipe be terminated at an adequate drain inside the building.
- Must be capable of withstanding 250°F (121°C) without distortion.
- Must be installed to allow complete drainage of both the valve and discharge line.

T&P Relief Valve and Pipe Insulation

1. Locate the temperature and relief valve on the water heater (also known as a T&P Relief Valve, Figure 26).
2. Locate the slit running the length of the insulation.
3. Spread this slit open and slip it up under the T&P Relief Valve. See Figure 26. Apply gentle pressure to the insulation to ensure it is fully seated on the T&P Relief Valve. Once sealed secure the insulation with a section of duct tape, electrical tape, or equivalent.

IMPORTANT: The insulation or tape must not block the discharge opening or hinder access to the manual relief lever. Ensure a discharge pipe is installed into the T&P valve discharge opening per the instructions manual.

4. Locate the hot water (outlet) & cold water (inlet) pipes to the water heater.
5. Locate the slit running the length of a section of pipe insulation.
6. Spread the slit open and slip the insulation over the cold water (inlet) pipe. Apply gentle pressure along the length of the insulation to ensure it is fully seated around the pipe. Also ensure that the base of insulation is flush with the water heater. Once seated, secure the insulation with duct tape, electrical tape, or equivalent.
7. Repeat steps 5 through 6 for the hot water (outlet) pipe.
8. Add additional sections of pipe insulation as needed.

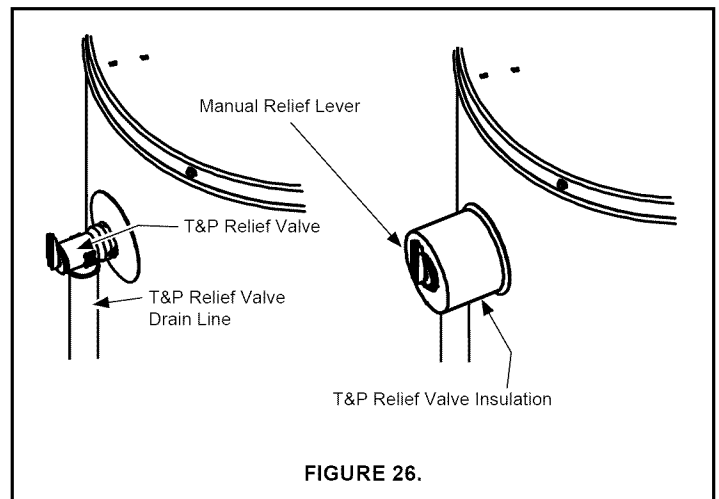

ELECTRICAL

Electrical Connections

Before plugging in the water heater, always make sure:

- The Voltage and frequency correspond to that specified on the water heater.
- The electrical outlet has the proper overload fuse or breaker protection.
- Unit is to connect to a 120VAC electrical supply outlet (extension cord is **not** allowed).

IMPORTANT: Do not use an extension cord to connect the water heater to an electrical outlet.

- The water heater and the outlet are properly grounded.
- Installed in accordance with prevailing provisions of local codes, or in the absence of such, National Electric Code, ANSI/NFPA 70 current edition.

Completely fill the tank with water and check all connections for leaks. Open the nearest hot water faucet and let it run for three (3) minutes to purge the water lines of air and sediment and to ensure complete filling of the tank. The electrical power may then be turned on. Verify proper operation after servicing.

⚠ WARNING



Electric Shock Hazard

Disconnect power before servicing.

Replace all parts and panels before operating.

Failure to do so can result in death or electrical shock.

Solar Installation

If this water heater is used as a solar storage heater or as a backup for the solar system, the water supply temperatures to the water heater tank may be in excess of 120°F. A mixing valve or other temperature limiting valve must be installed in the water supply line to limit the supply temperature to 120°F.

NOTE: Solar water heating systems can often supply water with temperatures exceeding 180°F and may result in water heater malfunction.

Wiring Diagram
FIGURE 27.

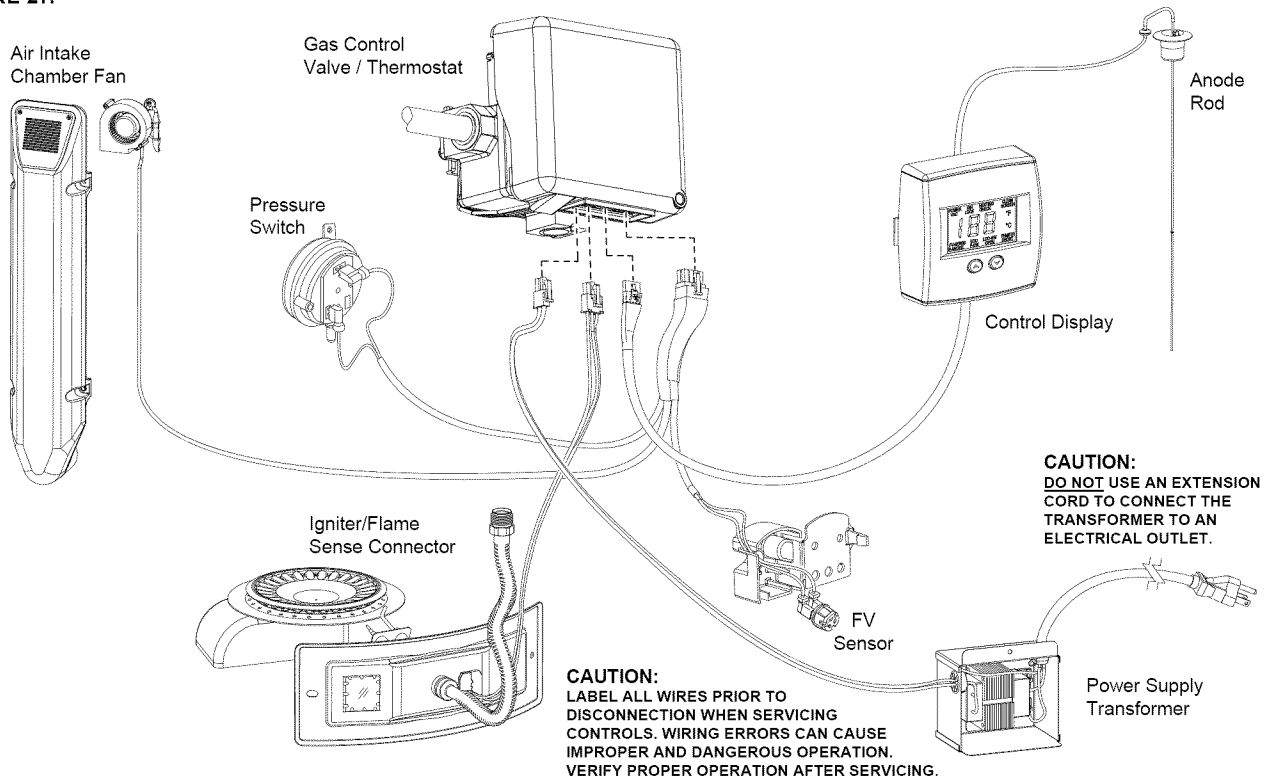

OPERATING YOUR WATER HEATER

Operating Instructions

Read and understand these directions thoroughly before attempting to operate the water heater. Make sure the view port is not missing or damaged (See Figure 36). Make sure the tank is completely filled with water before operating the water heater. The gas control valve/thermostat has a "On/Off Switch" and needs to be turned on before water heater is operational. Check the label on the front of heater near the gas control valve/thermostat for the correct gas. Do not use this water heater with any gas other than the one listed on the label. If you have any questions or doubts, consult your gas supplier or gas utility company.



⚠ WARNING

Explosion Hazard

Replace view port if glass is missing or damaged.

Failure to do so can result in death, explosion or fire.

FOR YOUR SAFETY READ BEFORE OPERATING



⚠ WARNING: If you do not follow these instructions exactly, a fire or explosion may result causing property damage, personal injury or loss of life.



FLAMMABLE

BEFORE OPERATING: ENTIRE SYSTEM MUST BE FILLED WITH WATER AND AIR PURGED FROM ALL LINES.

A. This appliance does not have a pilot. It is equipped with an ignition device that will automatically light the burner. Do not try to light the burner by hand.

B. **BEFORE OPERATING** smell all around the appliance area for gas. Be sure to smell next to the floor because some gas is heavier than air and will settle on the floor.

WHAT TO DO IF YOU SMELL GAS:

- Do not try to light any appliance.
- Do not touch any electric switch; do not use any phone in your building.
- Immediately call your gas supplier from a neighbor's phone. Follow the gas supplier's instructions.

● If you cannot reach your gas supplier, call the fire department.





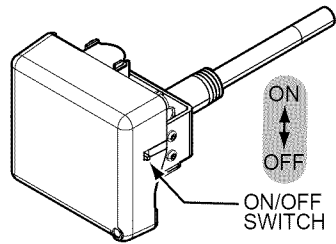

C. Use only your hand to push in the electronic display buttons and gas control switch. Never use tools. If the control buttons will not push in, don't try to repair them, call a qualified service technician. Force or attempted repair may result in a fire or explosion.

D. Do not use this appliance if any part has been under water. Immediately contact a qualified installer or service agency to replace a flooded water heater. Do not attempt to repair the unit. It must be replaced!

OPERATING INSTRUCTIONS



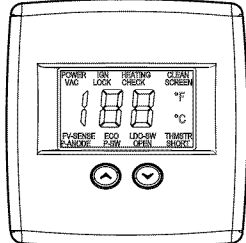

"GAS CONTROL"

1.  STOP! Read the safety information above on the label.
2. Turn on all electrical power to the appliance.
3. Set the ON/OFF switch on the gas control to the "ON" position.
4. Set the Electronic Display to the lowest setting by first pressing the COOLER  and HOTTER  buttons together and holding for 1 second. Then press the COOLER  button to the lowest setting.
5. Set the ON/OFF switch on the gas control to the "OFF" position.
6. This appliance is equipped with a device which automatically lights the burner.
7. Wait five (5) minutes to  clear out any gas. If you then smell gas,  STOP! Follow "B" in the safety information above on this label. If you don't smell gas, go to the next step.



"ELECTRONIC DISPLAY"

8. Set the ON/OFF switch on the gas control to the "ON" position.
9. Set the Electronic Display to the desired setting by first pressing the COOLER  and HOTTER  buttons together and holding for 1 second. Then press the HOTTER  button until the desired setting is reached.

⚠ DANGER: Hotter water increases the risk of scald injury. Consult the instruction manual before changing temperature.

10. If the appliance will not operate, follow the instructions "TO TURN OFF GAS TO APPLIANCE" and call your technician or gas supplier.

⚠ WARNING: TURN OFF ALL ELECTRIC POWER BEFORE SERVICING.

TO TURN OFF GAS TO APPLIANCE



1. Set the Electronic Display to the lowest setting by first pressing the COOLER  and HOTTER  buttons together and holding for 1 second. Then press the COOLER  button to the lowest setting.
2. Set the ON/OFF switch on the gas control to the "OFF" position.
3. Turn off all electrical power to the appliance if service is to be performed.

FIGURE 28.

Water Heater Operation

Figure 29 below shows the water heater's sequence of operation when a call for heat is initiated. The ignition control module will attempt to light the burner three times. If the ignition control does not detect ignition it will enter lockout mode, indicated by display flashing status code (see status code 3 page 38 and/or status code 8 page 39).

SEQUENCE OF OPERATION

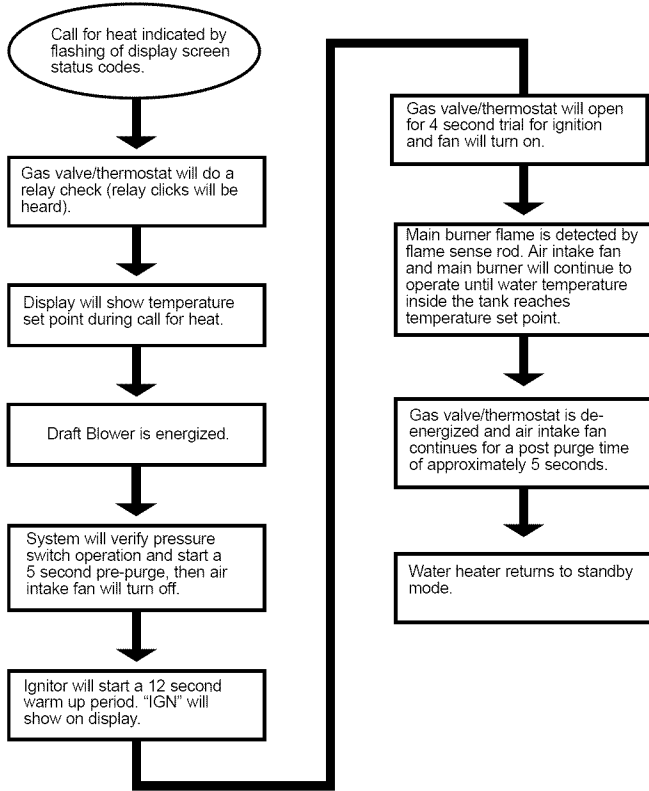
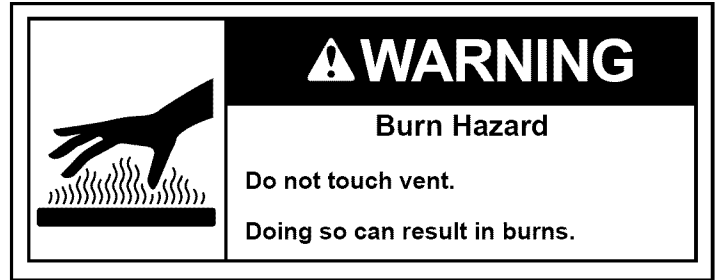

FIGURE 29.

Checking the Draft



After successfully lighting the water heater, allow the unit to operate for 15 minutes and check the draft hood relief opening for proper draft (Figure 30). Make sure all other appliances in the area are operating and all doors/windows are closed when performing the draft test. Pass a match flame or smoke around the relief opening of the draft hood. A steady flame or smoke drawn into the opening indicates proper draft.

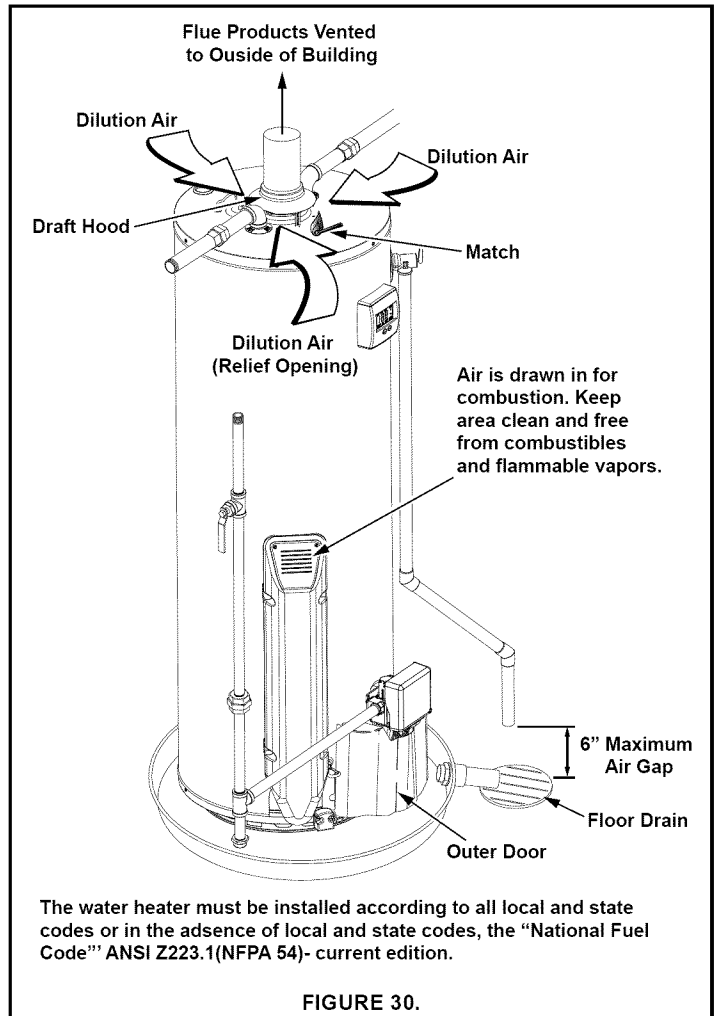

FIGURE 30.

If the flame flutters or is blown out, combustion products are escaping from the relief opening. If this occurs, do not operate the water heater until proper adjustments or repairs are made to the vent pipe system and/or air supply requirements.

Burner Flames

Inspect the burner flames through the viewport and compare them to the drawings in Figure 31. A properly operating burner should produce a soft blue flame. Blue tips with yellow inner cones are satisfactory. The tips of the flame may have a slight yellow tint. The flame should not be all yellow or have a sharp blue-orange color. Contaminated air may cause an orange colored flame. Contact a qualified technician if the flame is not satisfactory.

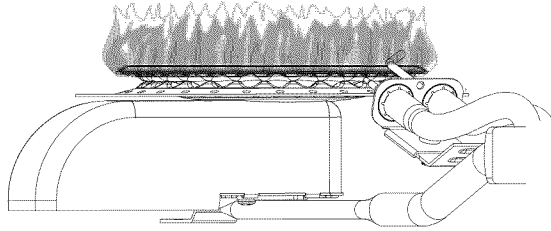
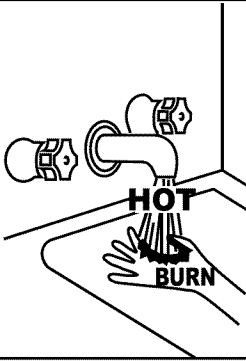

FIGURE 31.

Emergency Shut Down

IMPORTANT: Should overheating occur or the gas supply fails to shut off, turn off the heater's manual gas control valve and the electrical power. Call a qualified technician.

Water Temperature Regulation



⚠ DANGER Water temperature over 125°F (52°C) can cause severe burns instantly resulting in severe injury or death.

Children, the elderly, and the physically or mentally disabled are at highest risk for scald injury.

Feel water before bathing or showering.

Temperature limiting valves are available.

Read instruction manual for safe temperature setting.

Due to the nature of the typical gas water heater, the water temperature in certain situations may vary up to 30°F (16.7 °C) higher or lower at the point of use such as, bathtubs, showers, sink, etc.

HOTTER WATER CAN SCALD: Water heaters are intended to produce hot water. Water heated to a temperature which will satisfy space heating, clothes washing, dish washing, and other sanitizing needs can scald and permanently injure you upon contact. Some people are more likely to be permanently injured by hot water than others. These include the elderly, children, the infirm, or physically/mentally handicapped. If anyone using hot water in your home fits into one of these groups or if there is a local code or state law requiring a certain temperature water at the hot water tap, then you must take special precautions. In addition to using the lowest possible temperature setting that satisfies your hot water needs, a means such as a mixing valve

should be used at the hot water taps used by these people or at the water heater. Mixing valves are available at plumbing supply or hardware stores, see Figure 24. Follow manufacturer's instructions for installation of the valves. Before changing the factory setting on the thermostat see Table 5 and Figure 32. Using the lowest hot water temperature that meets your needs will also provide the most energy efficient operation of the water heater. Never allow small children to use a hot water tap, or to draw their own bath water. Never leave a child or handicapped person unattended in a bathtub or shower.

NOTE: A water temperature range of 120°F-140°F (49°C-60°C) is recommended by most dishwasher manufacturers.

The thermostat of this water heater has been factory set at its lowest position. It is adjustable and must be reset to the desired temperature setting to reduce the risk of scald injury. The electronic control display temperature should be set at approximately 120°F (49°C) and this is the preferred starting point, see Table 5. Some states have a requirement for a lower setting. If you need hotter water, follow directions for temperature adjustment, but beware of the warnings in this section.

Water Temperature °F	Time for 1st Degree Burn (Less Severe Burns)	Time for Permanent Burns 2nd & 3rd Degree (Most Severe Burns)
110	(normal shower temp.)	
116	(pain threshold)	
116	35 minutes	45 minutes
122	1 minute	5 minutes
131	5 seconds	25 seconds
140	2 seconds	5 seconds
149	1 second	2 seconds
154	instantaneous	1 second

(U.S. Government Memorandum, C.P.S.C., Peter L. Armstrong, Sept. 15,1978)

TABLE 5

Pressing the "COOLER" ⏴ button decreases temperature and pressing the "HOTTER" ⏵ button increases the temperature.

To avoid any unintentional changes in water temperature settings, the control has a tamper resistant feature for changing the temperature setting. To change the temperature setting follow these instructions:

- "Unlock" the temperature indicators by holding down both "COOLER" and "HOTTER" temperature adjustment buttons at the same time for one second (See Figure 32). The display will light up. The display will only remain on for 30 seconds if no further buttons are pressed. After 30 seconds the control will go back to "Lock" mode ("Lock" mode indicates a temperature setting is locked into the control memory).
- Release both of the temperature adjustment buttons.
 - To decrease the temperature press and release the "COOLER" ⏴ button until the desired setting is reached.
 - To increase the temperature press and release the "HOTTER" ⏵ button until the desired setting is reached.

NOTE: Should overheating occur or the gas supply fail to shut off, turn off the manual gas control valve to the appliance.

NOTE: During low demand periods when hot water is not being used, a lower thermostat setting will reduce energy losses and

may satisfy your normal hot water needs. If hot water use is expected to be more than normal, a higher thermostat setting may be required to meet the increased demand. When leaving your home for extended periods (vacations, etc.) Set the electronic control display temperature “COOLER”  button to its lowest setting. This will maintain the water at low temperatures with minimum energy losses and prevent the tank from freezing during cold weather.

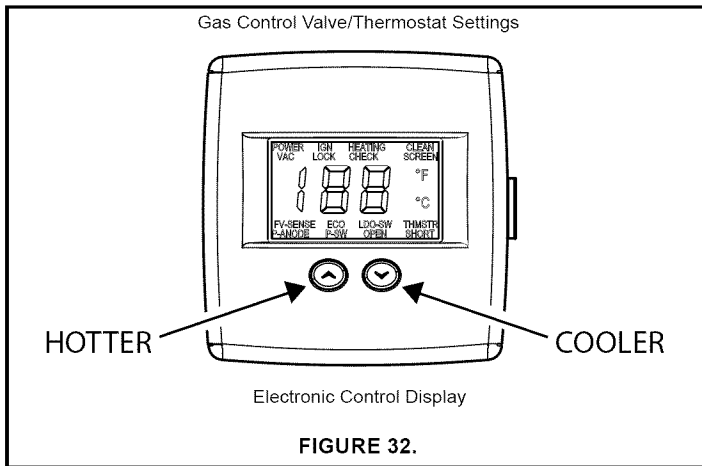

Powered Anode Operation

To protect the glass-lined water tank from corrosion through electrolysis, this water heater is equipped with a non sacrificial powered anode rod. The powered anode rod is non sacrificial and should not need to be replaced unless damaged.

If the powered anode rod has been damaged then the powered anode rod should be removed from the water heater tank and replaced. **IMPORTANT:** If the damaged powered anode rod has not been replaced but has been removed permanently, this will void any warranties.

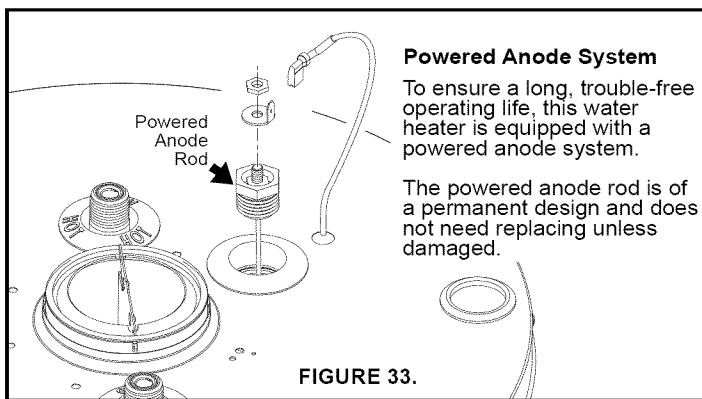

NOTE: Whether re-installing or replacing the powered anode rod, check for any leaks and immediately correct if found.

To replace the powered anode rod:

1. Set the gas control valve/thermostat to its lowest setting by pressing the “COOLER” and “HOTTER” buttons together at the same time holding for 1 second. Then press the “COOLER” button to the lowest setting (Figure 32).
2. Turn gas control switch to the “OFF” position (located right side of the gas control valve/thermostat (Figure 28), and turn off the gas supply to the unit.

3. Disconnect the electric connection by unplugging the water heater from the wall outlet.
4. Shut off the incoming water supply to the water heater and open a nearby hot water faucet to depressurize the water tank.
5. Remove the manifold cover outer door and connect a hose to the drain valve and terminate it to adequate drain or to the exterior of the building. Open the drain valve and allow at least 5 gallons of water from the tank to drain. Close drain and remove hose.
6. Unplug the electrical connection on top of the powered anode by pulling the wire connector up and off of the powered anode rod electrical connector (Figure 33).
7. Remove the powered anode rod by using a ratchet and a 1-1/16” socket turning counterclockwise (Figure 33) (Note: Figure 33 is shown exploded). If the socket used is short well you may have to remove the top male connector first before removing the powered anode rod.
8. Use Teflon[®] tape or an approved pipe sealant on threads of the new powered anode rod.
9. Prior to installing, it will be necessary to use pliers to bend up approximately 90° the electrical male connector on the top of the powered anode rod. The electrical connector should be bent upward in order to allow the 1-1/16” deep well socket to pass over the connector. Note: if using a short well socket the male connector must first be removed (Figure 33 is shown exploded for clarity).
10. Place the powered anode rod in the spud (top of the tank) and turn clockwise until the threads are hand tight. Using a ratchet and 1-1/16” socket tighten down water tight (Torque should be between 65 to 120 foot pounds).
11. Open a nearby hot water faucet to purge air from the water line. Fill water heater tank completely (Note: To assure the water heater tank is full, keep the hot water faucet open for 3 minutes after a constant flow of water is obtained).
12. After turning off the hot water faucet, check for water leaks around powered anode rod and immediately correct any if found.
13. Upon determining there’s no water leak at the newly installed powered anode rod, reconnect the electrical plug connector to the top of the anode male terminal.
14. Plug the electric transformer in the wall outlet and turn the gas supply back on to the gas control valve/thermostat.
15. Turn the gas control switch to the “ON” position (located on the side of the gas control valve/thermostat (Figure 28).
16. To restart the water heater, follow the directions on the “Lighting and Operating Instructions” label located on the front of the water heater near the gas control valve/thermostat (Figure 28).
17. Upon verifying proper operation of the water heater, replace the manifold cover outer door.

TEFLON[®] is a registered trademark of E.I. Du Pont De Nemours and Company

SERVICE AND ADJUSTMENT

Draining and Flushing

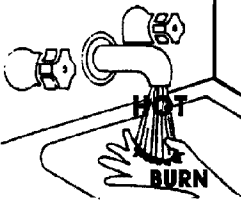
	<p>⚠ DANGER</p> <ul style="list-style-type: none">• Hot water discharge burn hazard.• Keep clear of relief valve discharge unit.• Temperature limiting valves are available.• Read instruction manual for safe temperature setting.
---	---

It is recommended that the tank be drained and flushed every 6 months to remove sediment which may build up during operation. The water heater should be drained if being shut down during freezing temperatures. To drain the tank, perform the following steps:

1. Turn off the gas to the water heater at the manual gas shut-off valve and turn off the electrical power to the gas control/thermostat valve.
2. Open a nearby hot water faucet until the water is not longer hot.
3. Close the cold water inlet valve.
4. Connect a hose to the drain valve and terminate it to an adequate drain or external to the building.
5. Open the water heater drain valve and allow all the water to drain from the tank. Flush the tank with water as needed to remove sediment.
6. Close the drain valve, refill the tank, and restart the heater as directed in this manual.

If the water heater is going to be shut down for an extended period, the drain valve should be left open.

IMPORTANT: Condensation may occur when refilling the tank and should not be confused with a tank leak.

Routine Preventive Maintenance

At least annually, a visual inspection should be made of the venting and air supply system, piping systems, and main burner. Check the water heater for the following:

- Obstructions, damage, or deterioration in the venting system. Make sure the ventilation and combustion air supplies are not obstructed.
- Clean any dust or debris from the screen of the air intake chamber.
- Soot and/or carbon on the main burner. Contact a qualified technician.
- Leaking or damaged water and gas piping.
- Presence of flammable or corrosive materials in the installation area.
- Presence of combustible materials near the water heater.
- After servicing this water heater, check to make sure it is working properly. (See "Operating Your Water Heater" section of this manual.)

IMPORTANT: If you lack the necessary skills required to properly perform this visual inspection, you should not proceed, but get help from a qualified technician.

Temperature and Pressure Relief Valve

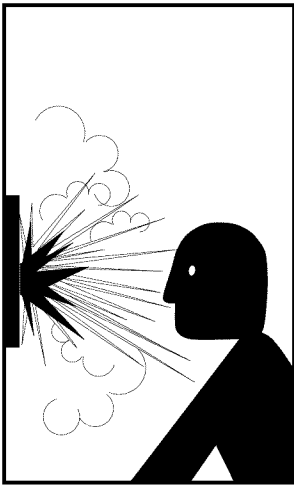
	<p>⚠ WARNING</p> <p>Explosion Hazard</p> <ul style="list-style-type: none">• Temperature-pressure relief valve must comply with ANSI Z21.22-CSA 4.4 and ASME code.• Properly sized temperature-pressure relief valve must be installed in opening provided.• Can result in overheating and excessive tank pressure.• Can cause serious injury or death.
--	--

Manually operate the temperature and pressure relief valve at least once a year to make sure it is working properly. To prevent water damage, the valve must be properly connected to a discharge line which terminates at an adequate drain. Standing clear of the outlet (discharged water may be hot), slowly lift and release the lever handle on the temperature and pressure relief valve to allow the valve to operate freely and return to its closed position. See Figure 34. If the valve fails to completely reset and continues to release water, immediately shut off the electrical power, manual gas control valve and the cold water inlet valve and call a qualified technician. Contact Sears Service 1-800-4-MY-HOME® (www.sears.com).

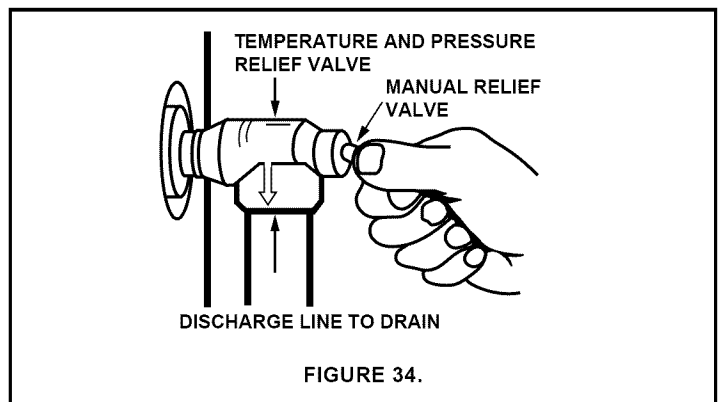

MAINTENANCE OF YOUR WATER HEATER

Replacement Parts

IMPORTANT: The following maintenance procedures are for the FVIR System components and should be performed by a qualified technician.

Replacement parts may be ordered from Sears Parts and Service Centers or by calling 1-800-4-MY-HOME (1-800-469-4663). When ordering replacement parts, always have the following information ready:

1. model, serial, and product number
2. type of gas
3. item number
4. parts description

See "Parts Order List" section for a list of available repair parts.

Removing the Manifold/Burner Assembly

1. Turn off the gas supply to the water heater at the manual gas shut-off valve. This valve is typically located beside the water heater. Note the position of the shut-off valve in the open/on position then proceed to turn it off (Figure 12).
2. Disconnect power supply to the heater.
3. Remove the outer door. Remove the 2 screw securing the manifold door assembly to the skirt.
4. Disconnect all wiring connectors from the gas control valve/thermostat (Figure 35). Disconnect the manifold tube at the gas control valve/thermostat.
5. Grasp the manifold tube and push down slightly to free the manifold from the gas control valve/thermostat.
6. Carefully remove the manifold assembly from the burner compartment. **NOTE:** Be sure not to damage internal parts (Figure 39).
7. Check the burner to see if it is dirty or clogged. The burner may be cleaned with soap and hot water.

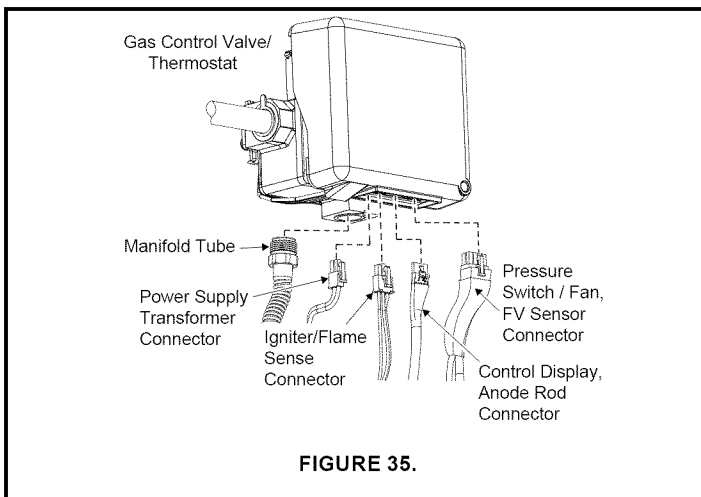

Removing the Burner from the Manifold/Burner Assembly

Natural Gas Burner

1. Take off the burner by removing the two (2) screws located underneath the burner.
2. Check the burner to see if it is dirty or clogged. The burner may be cleaned with soap and hot water (Figure 36).

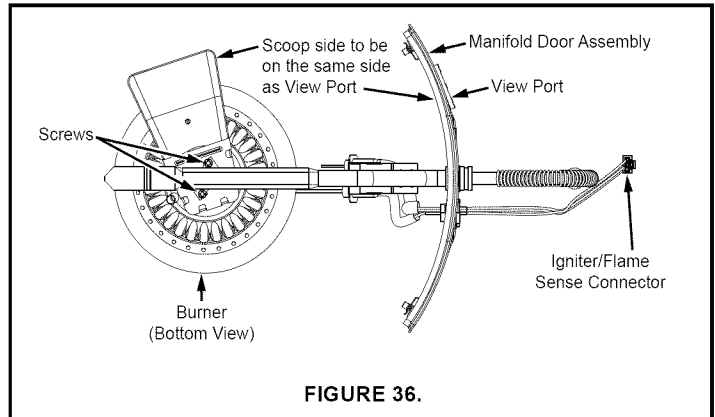

Replacing the Flame Sense/Hot Surface igniter Assembly

1. Remove the manifold/burner assembly. See Removing the Manifold/Burner Assembly.
2. Lift the retainer clip straight up from the back of the manifold component block (using a flat-blade screwdriver), then remove the manifold component block from the manifold door (Figure 37).
3. Remove and keep the screw securing the flame sense/hot surface igniter assembly (Figure 37)
4. Remove and discard the old flame sense/hot surface igniter assembly.
5. Route the new flame sense/hot surface igniter connector wire through manifold/burner door opening as shown in figure 37. Secure assembly to bracket using screw removed earlier.

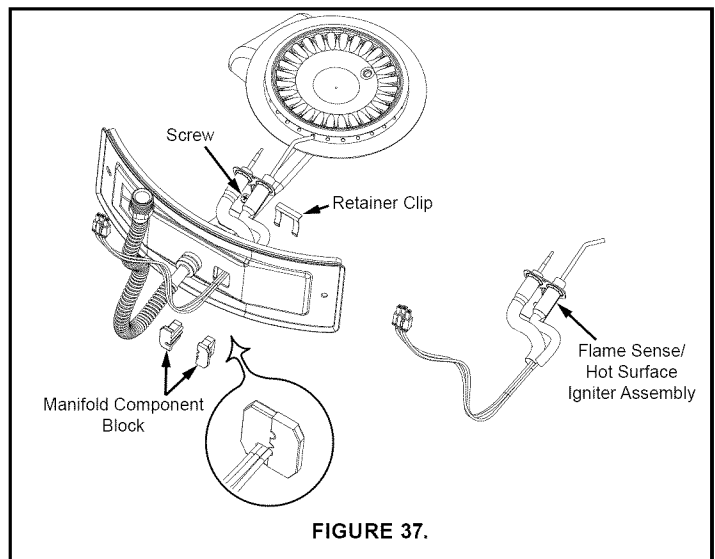

6. Reposition the manifold component block in the mani-fold door opening and secure it with the retainer clip.
7. See Replacing the Manifold/Burner Assembly.

External Inspection & Cleaning of the Air Intake Chamber Screen

1. At least twice annually inspect the air intake chamber screen (Figure 38) for any dust or debris that may have accumulated on the louvers. NOTE: If the water heater is located in an area that is subjected to lint and dirt, it may be necessary to check the air intake chamber screen more frequently.
2. Use a vacuum cleaner with a hose attachment to remove any dust or debris that may have accumulated on the screen.

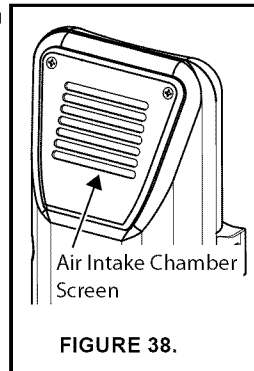

Cleaning the Combustion Chamber and Air Diverter Assembly

1. Follow procedure outlined in “Removing the Manifold/Burner Assembly”.
2. Use a vacuum cleaner/shop vac to remove all loose debris in the combustion chamber (Figure 39). Use compressed air to clear any dust or debris that may have accumulated on the air diverter assembly.

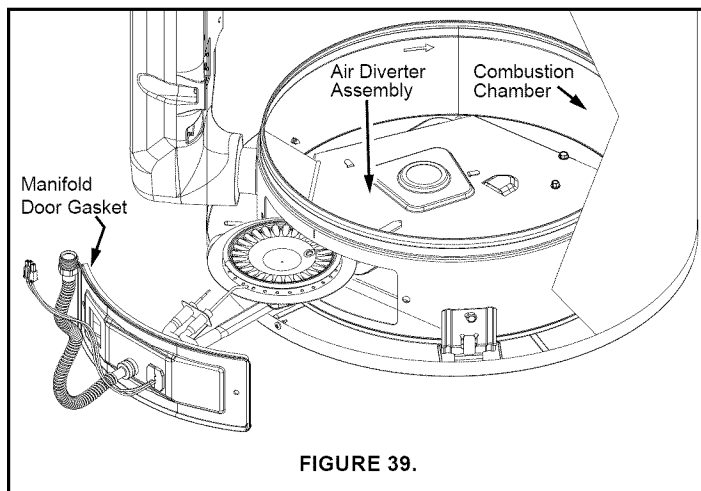

3. Reassemble following the procedure under “Replacing the Manifold/Burner Assembly”

Replacing the Manifold/Burner Assembly

⚠ WARNING



Explosion Hazard

- Remove any fiberglass between gasket and combustion chamber.
- Replace viewport if glass is missing or damaged.
- Replace two piece wire connector if missing or removed.
- Replace door gasket if damaged.
- Tighten both manifold door screws securely.
- Failure to follow these instructions can result in death, explosion, or fire.

1. Check the door gasket for damage or imbedded debris prior to installation.
2. Inspect the view port for damage and replace as required.
3. Insert the manifold/burner assembly into the burner compartment making sure that the tip of the manifold tube engages in the slot of the bracket inside the combustion chamber (Figure 40).
4. Inspect the door gasket and make sure there is no fiberglass insulation between the gasket and the combustion chamber.
5. Replace the two screws, which secure the manifold/burner assembly door to the combustion chamber and tighten securely. Once the manifold/burner assembly door is tightened, visually inspect the door gasket between the manifold/burner assembly door and the combustion chamber for spaces or gaps that would prevent a seal. **IMPORTANT:** Do not operate the water heater if the door gasket does not create a seal between the manifold door and the combustion chamber.
6. During the following procedure, do not cross-thread or apply any thread sealant to any of the fittings listed below. First, reconnect the manifold tubing to the gas control valve/thermostat.
7. Reconnect the flame sense/hot surface igniter wire to the gas control valve/thermostat (Figure 35).
8. Turn gas supply on and refer to the Lighting Instructions.
9. With the burner lit, check the gas control valve/thermostat supply line, two piece wire connector, and manifold tube connections for leaks. Check for leaks by brushing on an approved noncorrosive leak detection solution. **IMPORTANT: Do Not splash solution onto the electrical connections.** Bubbles forming indicate a leak. Correct any leak found. All leaks must be fixed immediately.

10. Replace the outer door (see item K page 10).

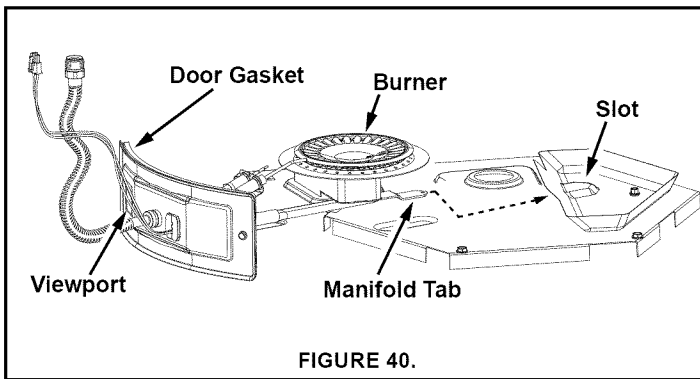

Removing and Replacing the Gas Control Valve/Thermostat

IMPORTANT: Use only factory authorized replacement parts.

Removing the Gas Control Valve/Thermostat:

1. Set the gas control valve/thermostat to its lowest setting by first depressing the COOLER (▼) and HOTTER (▲) buttons together and hold for 1 second. Then press the COOLER (▼) button until the VAC indicator light appears (Figure 32).
2. Unplug the water heater from the wall outlet.
3. Turn off the gas supply to the water heater at the manual gas shut-off valve. This valve is typically located beside the water heater. Note the position of the shut-off valve in the open/on position then proceed to turn it off (Figure 12).
4. Drain the water heater. Refer to the section of "Draining and Flushing" section and follow the procedure.
5. Disconnect the the flame sense/hot surface igniter wire, power supply transformer, pressure switch/fan and display connector wires from the thermostat (Figure 35). Disconnect the manifold tube at the thermostat (Figure 35).
6. Refer to "Gas Piping" section (Figure 12) and disconnect the ground joint union in the gas piping. Disconnect the remaining pipe from the gas control valve/thermostat.
7. To remove the gas control valve/thermostat, thread a correctly sized pipe into the inlet and use it to turn the gas control valve/thermostat (counterclockwise.) Do not use pipe wrench or equivalent to grip body. Damage may result, causing leaks. Do not insert any sharp objects into the inlet or outlet connections. Damage to the gas control valve/thermostat may result.

Replacing the Gas Valve:

1. To replace the gas control valve/thermostat, reassemble in reverse order. When replacing the gas control valve/thermostat, thread a correctly sized pipe into the inlet and use it to turn the gas valve (clockwise.) DO NOT OVER TIGHTEN or damage may result. NOTE: Use an approved TEFLON[®] tape or pipe compound only on the threaded section of the gas control valve/thermostat that screws into the tank.

2. Reconnect the gas piping to the gas control valve/thermostat. NOTE: Use an approved Teflon tape or pipe compound on the gas piping connections.
3. Reconnect the manifold tube, flame sense/hot surface igniter wire, power supply transformer, pressure switch/fan and display connector wires (Figure 35).
4. Fill the tank completely with water. NOTE: To purge the lines of any excess air, keep the hot water faucet open for 3 minutes after a constant flow of water is obtained.
5. Turn on the gas supply and test the gas supply connections by brushing on an approved noncorrosive leak detection solution. **IMPORTANT: Do Not splash solution onto the electrical connections.** Bubbles forming indicate a leak. Correct any leak found.
6. Check the operation of the burner by following the lighting instructions on the front of the water heater. With the burner lit, check the gas control valve/thermostat supply line, manifold tube connections for leaks.
7. Verify proper operation and then replace the outer door.

TEFLON[®] is a registered trademark of E.I. Du Pont De Nemours and Company

TROUBLESHOOTING GUIDE

Start Up Conditions

Thermal Expansion

CAUTION

Property Damage Hazard

- Avoid water heater damage.
- Install thermal expansion tank or device if necessary.
- Contact qualified installer or service agency.

As water is heated, it expands (thermal expansion). In a closed system, the volume of water will grow. As the volume of water grows, there will be a corresponding increase in water pressure due to thermal expansion. Thermal expansion can cause premature tank failure (leakage). This type of failure is not covered under the limited warranty. Thermal expansion can also cause intermittent temperature-pressure relief valve operation: water discharged from the valve due to excessive pressure build up. The temperature-pressure relief valve is not intended for the constant relief of thermal expansion. This condition is not covered under the limited warranty.

A properly sized thermal expansion tank should be installed on all closed systems to control the harmful effects of thermal expansion. Thermal expansion tanks are available from Sears stores and through the Sears Service Centers. Contact the local plumbing inspector, water supplier and/or the Sears Service Center for assistance in controlling these situations. See Figure 41.

Thermal Expansion Tank Specifications

Model Number	Tank Capacity In Gallons	Dimensions in Inches		Pipe Fitting On Tank
		Diameter	Length	
153.331020	2	8 (203 mm)	12-3/4 (323 mm)	3/4" Male
153.331050	5	11 (279 mm)	14-3/4 (375 mm)	3/4" Male

TABLE 6

Expansion Tank Sizing Chart

Expansion Tank Capacity Needed	Inlet* Water Pressure	Water Heater Capacity (Gallons)				
		30	40	50	66	82
	40psi	2	2	2	5	5
	50psi	2	2	2	5	5
	60psi	2	2	5	5	5
	70psi	2	2	5	5	5
	80psi	2	5	5	5	5

TABLE 7

*Highest recorded inlet water pressure in a 24 hour period or regulated water pressure.

NOTE: Expansion tanks are pre-charged with a 40 psi air charge. If the inlet water pressure is higher than 40 psi, the expansion tank's air pressure must be adjusted to match that pressure, but must not be higher than 80 psi.

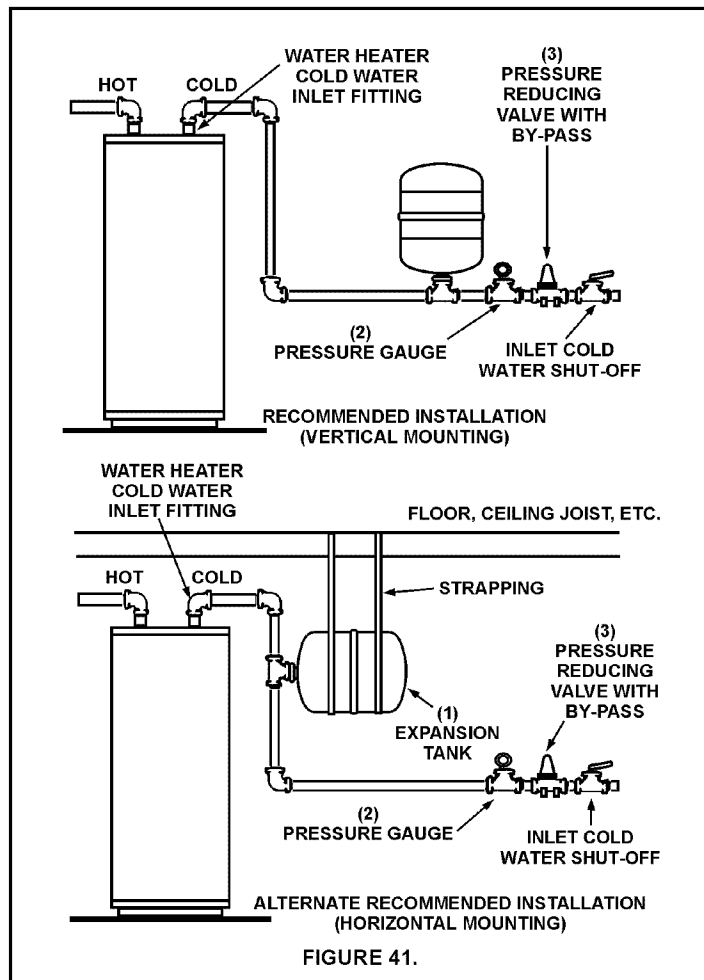

Strange Sounds

Possible noises due to expansion and contraction of some metal parts during periods of heat-up and cool-down do not represent harmful or dangerous conditions.

Condensation causes sizzling and popping within the burner area during heating and cooling periods and should be considered normal. See "Condensation" section.

Draft Hood Operation

Check draft hood operation by performing a worst case depressurization of the building. With all doors and windows closed, and with all air handling equipment and exhaust fans operating such as furnaces, clothes dryers, range hoods and bathroom fans, a match flame should still be drawn into the draft hood of the water heater with its burner firing. If the flame is not drawn toward the draft hood, shut off water heater and make necessary air supply changes to correct.

Condensation

Whenever the water heater is filled with cold water, some condensate will form while the burner is on. A water heater may appear to be leaking when in fact the water is condensation. This usually happens when:

- A new water heater is filled with cold water for the first time.
- Burning gas produces water vapor. In water heaters, particularly high efficiency models where flue temperatures are lower.
- Large amounts of hot water are used in a short time and the refill water in the tank is very cold.

Moisture from the products of combustion condense on the cooler tank surfaces and form drops of water which may fall onto the burner or other hot surfaces to produce a “sizzling” or “frying” noise.

Because of the suddenness and amount of water, condensation water may be diagnosed as a “tank leak”. After the water in the tank warms up (about 1-2 hours), the condition should disappear.

Do not assume the water heater is leaking until there has been enough time for the water in the tank to warm up.

An undersized water heater will cause more condensation. The water heater must be sized properly to meet the family's demands for hot water including dishwashers, washing machines and shower heads.

Excessive condensation may be noticed during the winter and early spring months when incoming water temperatures are at their lowest.

Good venting is essential for a gas fired water heater to operate properly as well as to carry away products of combustion and water vapor.

Smoke Odor

It is not uncommon to experience a small amount of smoke and odor during the initial start-up. This is due to burning off of oil from metal parts, and will disappear in a short while.

Operational Conditions

“AIR” In Hot Water Faucets

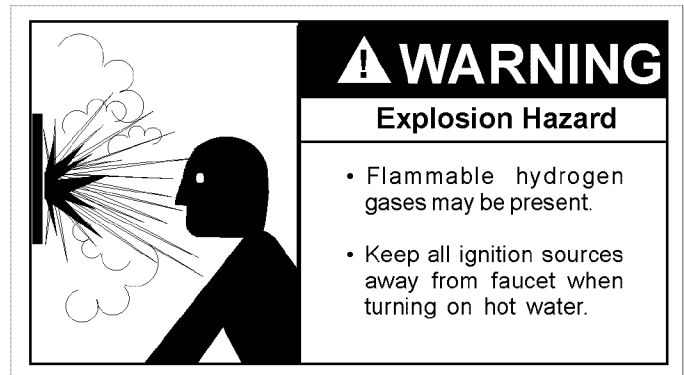

HYDROGEN GAS: Hydrogen gas can be produced in a hot water system that has not been used for a long period of time (generally two weeks or more). Hydrogen gas is extremely flammable and explosive. To prevent the possibility of injury under these conditions, we recommend the hot water faucet, located farthest away, be opened for several minutes before any electrical appliances which are connected to the hot water system are used (such as a dishwasher or washing machine). If hydrogen gas is present, there will probably be an unusual sound similar to air escaping through the pipe as the hot water faucet is opened. There must be no smoking or open flame near the faucet at the time it is open.

Do not remove the anode, leaving the tank unprotected. By doing so, all warranty on the water heater tank is voided.

Safety Shut-off and Thermal Switch

This water heater is designed to automatically shut-off in the event of the following:

1. The burner flame is extinguished for any reason.
2. The water temperature exceeds 195°F (91°C).
3. Excessive build up of dust on the louvers of the air intake chamber. See Maintenance of your Water Heater Section.

This unit is also equipped with a flammable vapor sensor (FV Sensor), designed to shut off the gas supply in the event the water heater has been exposed to flammable vapors (e.g., spilled gasoline). NOTE: If the FV-Sense senses the presence of flammable vapors a special FV-Sense reset sequence is required to be input into the Electronic Control Display in order to restore operation of the water heater.

A high temperature limit switch or ECO (Energy Cut Off) in the tank is used to shut off the unit if the water temperature exceeds 195°F (91°C). The ECO is a single-use switch, which, if activated, requires complete replacement of the entire gas control valve/thermostat. If the ECO should activate, the water heater cannot be used until the gas control valve/thermostat is replaced by a qualified technician. Contact Sears Service 1-800-4-MY-HOME® (www.sears.com).

Service

Before calling for repair service, please read the Troubleshooting Guide in this manual. If a condition persists or you are uncertain about the operation of the water heater, let the Sears Service Center check it out. Contact Sears Service 1-800-4-MY-HOME® (1-800-469-4663).

Leakage Checkpoints

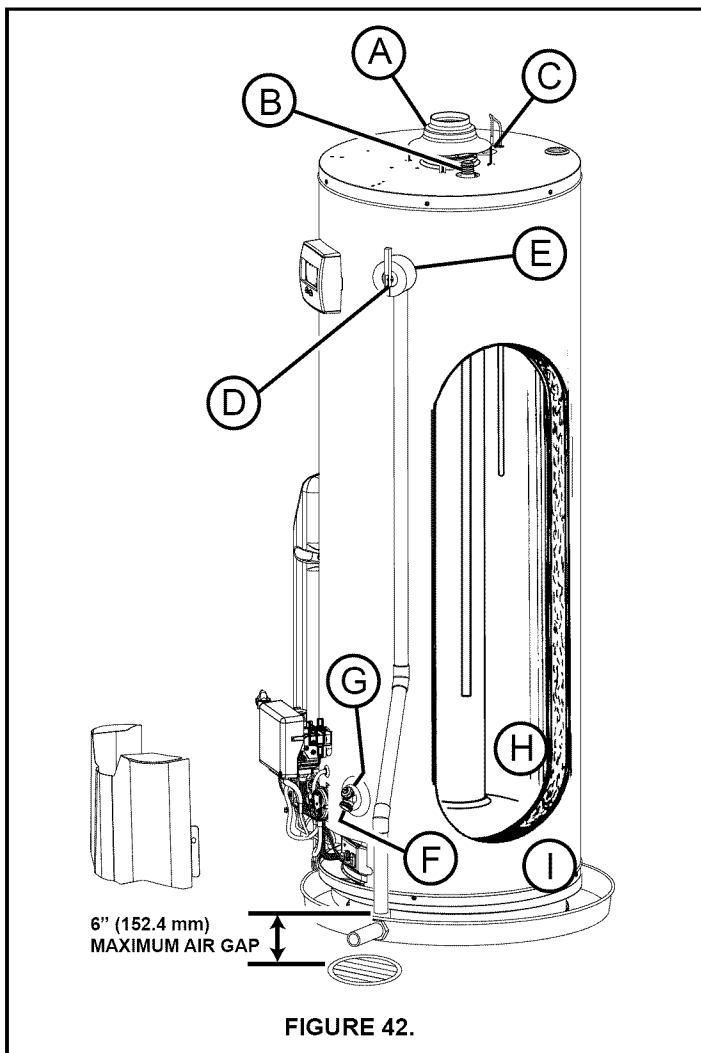

- B. *Condensation may be seen on pipes in humid weather or pipe connections may be leaking.
- C. *The anode rod fitting may be leaking.
- D. Small amounts of water from temperature-pressure relief valve may be due to thermal expansion or high water pressure in your area.
- E. *The temperature-pressure relief valve may be leaking at the tank fitting.
- F. Water from a drain valve may be due to the valve being slightly opened.
- G. *The drain valve may be leaking at the tank fitting.
- H. Combustion products contain water vapor which can condense on the cooler surfaces of the tank. Droplets form and drip onto the burner or run on the floor. This is common at the time of start-up after installation and when incoming water is cold.
- I. Water in the water heater bottom or on the floor may be from condensation, loose connections, or the relief valve. DO NOT replace the water heater until a full inspection of all possible water sources is made and necessary corrective steps taken.

Leakage from other appliances, water lines, or ground seepage should also be checked.

- * To check where threaded portion enters tank, insert cotton swab between jacket opening and fitting. If cotton is wet, follow draining instructions in the "Draining and Flushing" section and then remove fitting. Put pipe dope or teflon tape on the threads and replace. When you are finished, follow the steps in "Filling the Water Heater" in the Installation Instructions earlier in this manual.

Teflon® is a registered trademark of E.I. Du Pont De Numours and Company.

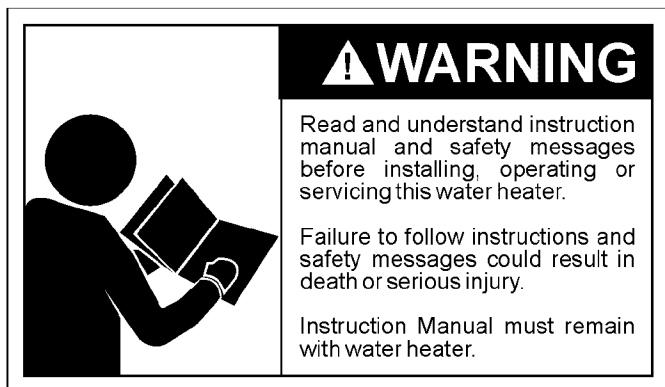

Read this manual first. Then, before checking the water heater, make sure the gas supply has been turned "OFF", and never turn the gas "ON" before the tank is completely full of water.

Never use this water heater unless it is completely filled with water. To prevent damage to the tank, the tank must be filled with water. Water must flow from the hot water faucet before turning "ON" gas to the water heater.

- A. Water at the draft hood is water vapor which has condensed out of the combustion products. This is caused by a problem in the vent. Contact a qualified technician.

Pressurized Combustion Chamber System Operational Checklist

1. Manifold gasket properly sealed.
2. Viewport not damaged or cracked.
3. Combustion chamber free of debris and undamaged.
4. Manifold component block properly installed.
5. No leaks at manifold connection.
6. Manifold door screws securely tightened.

TROUBLESHOOTING CHART

PROBLEM	POSSIBLE CAUSE(S)	CORRECTIVE ACTION
NO HOT WATER	<ol style="list-style-type: none"> 1. Transformer unplugged. 2. No power at outlet. 3. Thermostat defective. 4. Air Intake Chamber Fan defective. 5. Pressure Switch defective. 6. Gas Valve/Thermostat Switch in "OFF POSITION". 	<ol style="list-style-type: none"> 1. Plug transformer back into 120 VAC. outlet. 2. Repair service to outlet. 3. Replace Thermostat. 4. Replace Air Intake Chamber Fan Assembly. 5. Replace Pressure Switch Assembly. 6. Move Gas Valve/Thermostat Switch to "ON POSITION".
INSUFFICIENT HOT WATER	<ol style="list-style-type: none"> 1. Thermostat set too low. 2. Thermostat defective. 3. Heater undersized. 4. Low gas pressure. 5. Incoming water is unusually cold. 6. Leaking hot water pipes or fixtures. 	<ol style="list-style-type: none"> 1. Set temperature control higher. 2. Replace thermostat. 3. Reduce hot water use. 4. Contact dealer. 5. Allow more time for heater to reheat. 6. Have plumber check and repair leaks.
SLOW HOT WATER RECOVERY	<ol style="list-style-type: none"> 1. Low gas pressure. 2. Improper calibration. 3. Thermostat set too low. 4. Water heater too small. 5. Wrong piping connections. 6. Wasted hot water. 	<ol style="list-style-type: none"> 1. Check with gas utility company. 2. Replace thermostat. 3. Turn temperature dial to desired setting. 4. Install adequate heater. 5. Correct piping-dip tube must be in cold inlet. 6. Advise customer.
WATER TOO HOT	<ol style="list-style-type: none"> 1. Thermostat set too high. 	<ol style="list-style-type: none"> 1. Set temperature control lower. see, "WATER TEMPERATURE REGULATION", section.
BURNER FLAME YELLOW - LAZY	<ol style="list-style-type: none"> 1. Dirt in burner ports. 2. Combustion air path restricted. 3. Not enough dilution air for proper combustion. 4. Main burner line clogged. 5. Obstruction in main burner orifice. 6. Burner flame too high. 7. Flame burns at orifice/thermostat not functioning properly. 8. Low gas pressure. 	<ol style="list-style-type: none"> 1. Turn off heater and gas, clean burner head. 2. Check intake venting arrangements for obstructions. 3. Check intake venting arrangements for obstructions. 4. Clean, locate source and correct. 5. Clean or replace orifice. 6. Check orifice and replace if necessary. 7. Replace thermostat 8. Check with gas utility company.
BURNER FLAME FLOATS AND LIFTS OFF PORTS	<ol style="list-style-type: none"> 1. Orifice too large/wrong orifice. 2. High gas pressure. 3. Water heater flue or vent system blocked. 4. Cold drafts. 	<ol style="list-style-type: none"> 1. Replace with correct-orifice. 2. Check with gas utility company. 3. Clean flue and burner-locate source and correct. 4. Locate source and correct.
COMBUSTION ODORS	<ol style="list-style-type: none"> 1. Insufficient secondary air. 2. Water heater flue or vent system blocked. 3. Heater installed in a confined area. 	<ol style="list-style-type: none"> 1. Provide ventilation to water heater. Check flue. 2. Clean, locate source and correct. 3. Provide fresh air ventilation.

continued:

PROBLEM	POSSIBLE CAUSE(S)	CORRECTIVE ACTION
WATER LEAKS	<ol style="list-style-type: none"> 1. Improperly sealed, hot or cold supply connections, relief valve, drain valve or thermostat threads. 2. Leakage from other appliances or water lines. 3. Condensation of flue products. 4. Excessive water pressure. 5. Heater stacking. 6. Closed water system. 	<ol style="list-style-type: none"> 1. Tighten threaded connections. 2. Inspect other appliances near water heater. 3. See "START UP CONDITIONS", section. 4. Use a pressure reducing valve and relief valve. 5. Lower the thermostat setting. 6. See "Closed System/Thermal Expansion".
LEAKING T&P	<ol style="list-style-type: none"> 1. Thermal expansion in closed water system. 2. Improperly seated valve. 	<ol style="list-style-type: none"> 1. Install thermal expansion tank (DO NOT plug T&P valve). 2. Check relief valve for proper operation (DO NOT plug T&P valve).
HOT WATER ODORS	<ol style="list-style-type: none"> 1. High sulfate or mineral content in water supply. 2. Bacteria in water supply. 	<ol style="list-style-type: none"> 1. Drain and flushing heater thoroughly then refill. 2. Chlorinate water supply.
WATER HEATER SOUNDS SIZZLING-RUMBLING	<ol style="list-style-type: none"> 1. Condensation dripping on burner. 2. Sediment at bottom of heater tank. 	<ol style="list-style-type: none"> 1. See "START UP CONDITIONS", section. 2. See "DRAINING AND FLUSHING", section.
SMOKING AND CARBON FORMATION (SOOTING)	<ol style="list-style-type: none"> 1. Insufficient secondary air. 2. Low gas pressure. 3. Water heater flue or vent system blocked. 4. Thermostat not functioning properly. 5. Heater installed in a confined area. 6. Burner flame yellow-lazy. 	<ol style="list-style-type: none"> 1. Provide ventilation to water heater. Check flue way, flue baffle, burner. 2. Check with gas utility company. 3. Clean, locate source and correct. 4. Replace thermostat. 5. Provide fresh air ventilation. 6. See "Burner Flame Yellow-Lazy".
HIGH OPERATION COSTS	<ol style="list-style-type: none"> 1. Thermostat set too high. 2. Sediment or lime in tank. 3. Water heater too small for job. 4. Wrong piping connections. 5. Leaking faucets. 6. Gas leaks. 7. Wasted hot water. 8. Long runs of exposed piping. 9. Hot water piping in exposed wall. 	<ol style="list-style-type: none"> 1. Set temperature to lower setting. 2. Drain/flush-provide water treatment if needed. 3. Install adequate heater. 4. Correct piping-dip tube must be in cold inlet. 5. Repair faucets. 6. Check with utility-repair at once. 7. Advise customer. 8. Insulate piping. 9. Insulate piping.
THERMOSTAT FAILS TO SHUT-OFF	<ol style="list-style-type: none"> 1. Thermostat not functioning properly. 2. Improper calibration. 	<ol style="list-style-type: none"> 1. Replace thermostat. 2. Replace thermostat.
DRIP FROM RELIEF VALVE	<ol style="list-style-type: none"> 1. Excessive water pressure. 2. Heater stacking. 3. Closed water system. 	<ol style="list-style-type: none"> 1. Use a pressure reducing valve and relief valve. 2. Lower the thermostat setting. 3. See "CLOSED SYSTEM/THERMAL EXPANSION", section.

ELECTRONIC CONTROL DISPLAY TROUBLESHOOTING

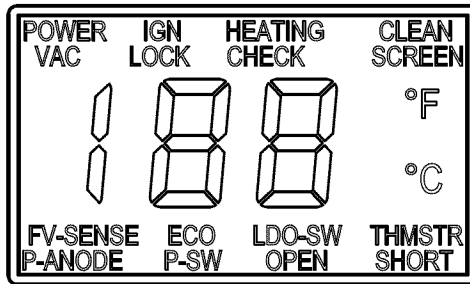

ELECTRONIC CONTROL DISPLAY

Please check guidelines below. For your safety, water heater service should be performed only by a qualified service person.
Read the GENERAL SAFETY INFORMATION supplied by the water heater manufacturer.

	CONTROL DISPLAY STATUS	PROBLEM	SOLUTION
1.	"POWER" Flashing	Communication Error The system has detected a communication error between the upper and lower controls.	<ol style="list-style-type: none"> 1. Check the 5-conductor data cable that runs between the upper and lower controls. Check that the wiring is not broken, and the connectors on both ends are properly seated in the mating connectors. 2. Replace the upper control, if the error code does not clear - cycle power to the water heater "Off" and "On" to reset. 3. Replace the lower control if the problem persists.
2.	"HEATING" and "SHORT" Flashing	The self-diagnostic tests have found a problem with an internal circuit.	<ol style="list-style-type: none"> 1. Turn the power off for 10 to 20 seconds then on again to clear the error code. 2. If the error code persists or cannot be cleared, replace the lower control.
3.	"HEATING" and "OPEN" Flashing	Ignition/flame failure. The water heater has reached the maximum number of retries and is currently locked out for one hour. Cycle the power to the water heater off and on to reset.	<ol style="list-style-type: none"> 1. Gas supply is turned off – pressure too low. Ensure supply and manifold gas pressures are within requirements in the installation manual. Manifold gas pressure is non-adjustable, if pressure is off by more than 0.3" W.C. (75 Pa) replace the lower control. 2. Low supply voltage – should be 115 – 125 VAC. 3. Ensure flame sensor is making good contact with the burner flame, ensure flame is steady. 4. Ensure the flame sensor is clean – use ultra fine steel wool or Scotch-Brite™ pad to clean the flame sensor. 5. Ensure the hot surface ignitor is positioned to provide consistent ignition. 6. Check for any cracks in the ignitor assembly ceramic insulators – replace ignitor assembly if damaged. 7. Check resistance of the ignitor at room temperature (77°F – 25°C) at the plug end. Replace ignitor if the resistance is not within 1.72 to 2.4 ohms at room temperature.
4.	"HEATING", "OPEN", and "SHORT" Flashing	Weak flame sensor current.	<ol style="list-style-type: none"> 1. Ensure flame sensor is making good contact with the burner flame, ensure flame is steady. 2. Ensure the flame sensor is clean – use ultra fine steel wool or Scotch-Brite™ pad to clean the flame sensor.
5.	"ECO" and "OPEN" Flashing	Water temperature in the tank has exceeded 185°F (85°C) and has activated the ECO.	<ol style="list-style-type: none"> 1. Turn the power off for 10 – 20 seconds then on again to clear this error code. 2. Replace the lower control if the error code persists.

	CONTROL DISPLAY STATUS	PROBLEM	SOLUTION
6.	"P-SW", "OPEN", and "CLEAN SCREEN" Flashing	The air pressure switch contacts remain open longer than 11 seconds after the combustion fan is energized.	<ol style="list-style-type: none"> 1. Clean the screen on the combustion air intake chamber. Turn the power "OFF" for 10 to 20 seconds then "ON" again to clear the error code. If the problem persists: 2. Ensure the pressure switch sensing tube is in good condition and securely connected at both ends. 3. Ensure the inner door to the combustion chamber is secure and the gasket is properly sealing. 4. Check operation of the air intake chamber fan and pressure switch. <ol style="list-style-type: none"> A. Turn off power to the water heater. B. Remove the tubing from the pressure switch and the wires from both terminals of the pressure switch. C. Connect a digital manometer to the open end of the tubing from the air intake chamber. Turn on the power to the water heater and when the fan turns on, measure the pressure reading in the tubing. If the pressure reading reaches the .22" WC <i>make point</i> of the pressure switch, turn off power to the water heater and reconnect tubing to the pressure switch. If pressure reading does not reach the .22" WC <i>make point</i>, check the system and tubing for restrictions and cleanliness. D. Attach leads of ohmmeter or continuity tester to the terminals of the pressure switch. Turn on power to the water heater and when the air intake fan comes on, check for continuity across the pressure switch contacts. If switch contacts remain open (no continuity) while the fan is in operation - replace the pressure switch.
7.	"P-SW" and "SHORT" Flashing	The air pressure switch contacts remain closed for more than 5 seconds when they should be open.	<ol style="list-style-type: none"> 1. Turn off power to the water heater. 2. Locate the pressure switch wiring – ensure pressure switch wiring is correct and not jumped. 3. Remove wires to both terminals on pressure switch. 4. Check pressure switch contacts with an ohmmeter for continuity. <ol style="list-style-type: none"> A. If pressure switch contacts show continuity (closed circuit) replace the pressure switch. B. If pressure switch contacts show open circuit and all wiring is correct – replace the lower control.
8.	"IGN" Flashing	Open ignitor circuit	<ol style="list-style-type: none"> 1. Check all wiring to the hot surface ignitor. 2. Check the 3 pin Molex ignitor assembly plug and receptacle on the lower control for a good connection. Repair or replace parts if necessary. 3. Check resistance of the ignitor with an ohmmeter on the ignitor assembly plug. Replace ignitor if resistance is not within 1.72 and 2.40 ohms. 4. If above checks are good – turn off power for 10 seconds and then back on. If this error code will not clear and the ignitor resistance is within specifications – replace the lower control.
9.	"FV-SENSE" Flashing	Flammable Vapor Sensor has detected the presence of flammable vapors and is in lockout	<ol style="list-style-type: none"> 1. Do not touch any electrical switch, do not use any phone in the building and do not try to light any appliance. 2. Smell around the water heater to ensure there are no gas leaks at the gas control valve or in the supply gas line or for any other type of flammable vapors in the area. 3. Carefully inspect the area surrounding the water heater for any substances such as gasoline, paint, paint thinners, varnish, or cleaners that could emit flammable vapors. Remove anything that can potentially emit flammable vapors from the area and store it properly in a different location. <p style="text-align: center;">~ continued next page ~</p>

	CONTROL DISPLAY STATUS	PROBLEM	SOLUTION
9.	"FV-SENSE" Flashing (Continued from previous page)		4. System must be manually reset by entering a special FVS reset sequence into the Electronic Control Display. See Electronic Control Display - FV - Sense Reset Sequence in the Kenmore PCC Water Heater Service Handbook.
10.	"LDO-SW", "OPEN", and "CLEAN SCREEN" Flashing	The air pressure switch contacts remain open longer than 5 seconds after the combustion fan is energized.	1. Clean the screen on the combustion air intake chamber, retest. 2. If the problem persists: Cycle power to the water heater "OFF" and "ON" to reset.
11.	"FV-SENSE" and "OPEN" Flashing	Flammable Vapor Sensor is open	1. Check all wiring to the flammable vapor sensor. 2. Remove the connectors from the flammable vapor sensor and measure the resistance of the sensor with an ohmmeter. A. If the reading taken is more than 1.7 million ohms, replace the flammable vapor sensor. B. If the reading taken is less than 1.7 million ohms, and the wiring from the control to the sensor is good, replace the lower control.
12.	"FV-SENSE" and "SHORT" Flashing	Flammable Vapor Sensor is shorted	1. Check all wiring to the flammable vapor sensor. 2. Remove the connectors from the flammable vapor sensor and measure the resistance of the sensor with an ohmmeter. A. If the reading taken is less than 2000 ohms, replace the flammable vapor sensor. B. If the reading taken is more than 2000 ohms, and the wiring from the control to the sensor is good, replace the lower control.
13.	"THMSTR" and "OPEN" Flashing	The self-diagnostic test has detected the temperature sensor (thermistor) inside the immersion probe is open.	1. Turn power off for 10 to 20 seconds then on again to clear this error code. 2. This part of the control cannot be replaced or serviced. If the error code cannot be cleared, the lower control must be replaced.
14.	"THMSTR" and "SHORT" Flashing	The self-diagnostic test has detected the temperature sensor (thermistor) inside the immersion probe is shorted.	1. Turn power off for 10 to 20 seconds then on again to clear this error code. 2. This part of the control cannot be replaced or serviced. If the error code cannot be cleared, the lower control must be replaced.
15.	All Segments Flashing	The self-diagnostic check has detected one or both of the temperature adjustment buttons are stuck.	1. Press and release each of the temperature adjustment buttons. If the above action does not clear the error, the control will continue to regulate the water temperature at the last setting. However, settings will no longer be adjustable – the upper control should be replaced.
16.	"P-ANODE" and "OPEN" Flashing	No current to Power Anode.	1. Check the wire that runs from the power anode to the upper control. Check the wire for damage, and to ensure that the connectors are fully seated into the mating connectors on both ends. 2. Check that the tank is full of water. Never use this water heater unless it is completely full of water. To prevent damage to the tank, the tank must be filled with water. Water must flow from the hot water faucet before turning "ON" gas to the water heater. 3. Cycle power to the water heater "OFF" and "ON" to reset.
17.	"P-ANODE" Flashing	Power Anode circuit failure.	1. Turn the power off for 10 to 20 seconds then on again to clear the error code. 2. If the error code persists or cannot be cleared, replace the upper control.

TROUBLESHOOTING FLOWCHART

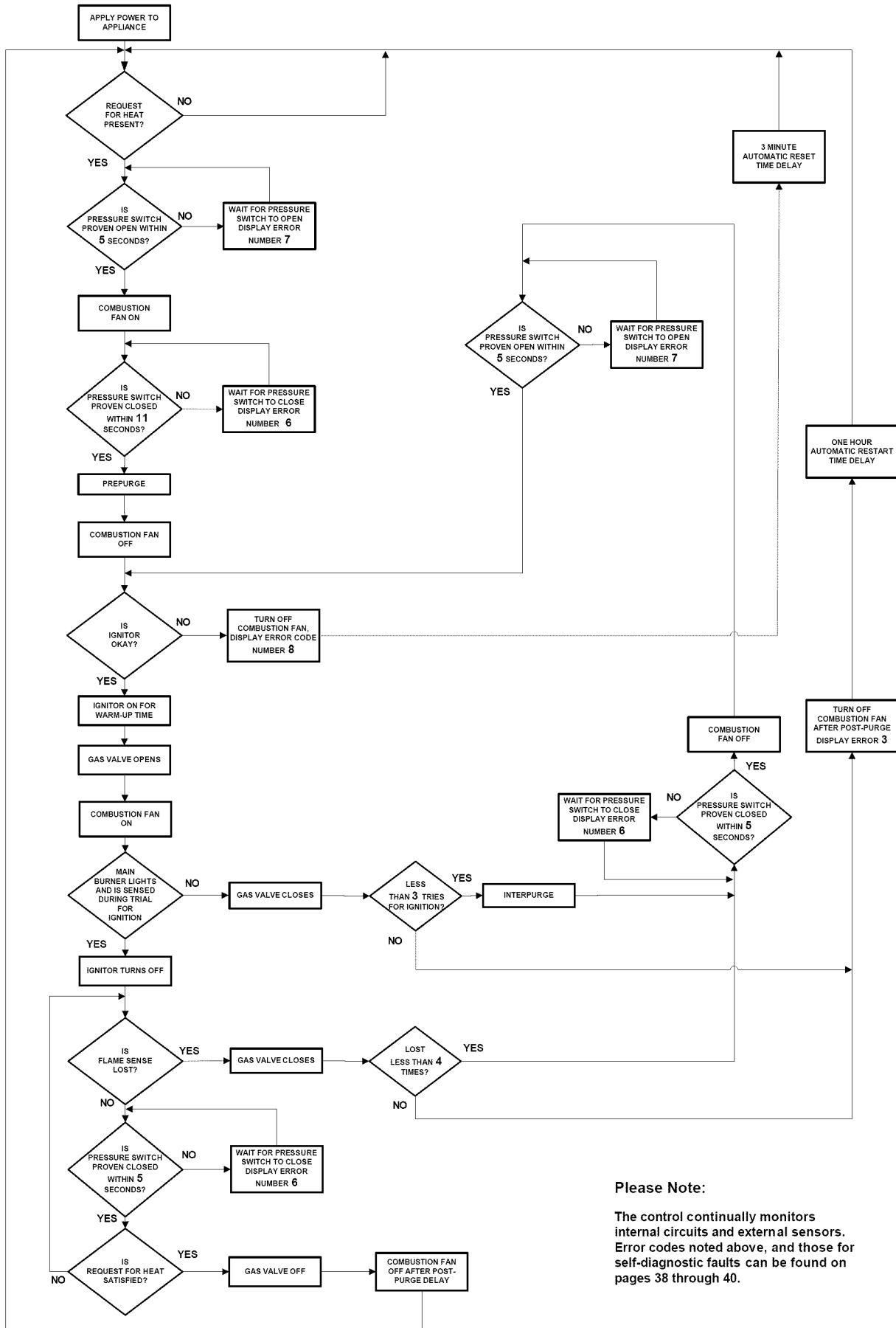

Please Note:
 The control continually monitors internal circuits and external sensors. Error codes noted above, and those for self-diagnostic faults can be found on pages 38 through 40.

PARTS ORDER LIST

**KENMORE® ELITE HIGH EFFICIENCY PCC
(Pressurized Combustion Chamber)
NATURAL GAS WATER HEATERS**

MODEL NUMBERS

153.332620	40 Gallon Tall (Natural)
153.332640	50 Gallon Tall (Natural)

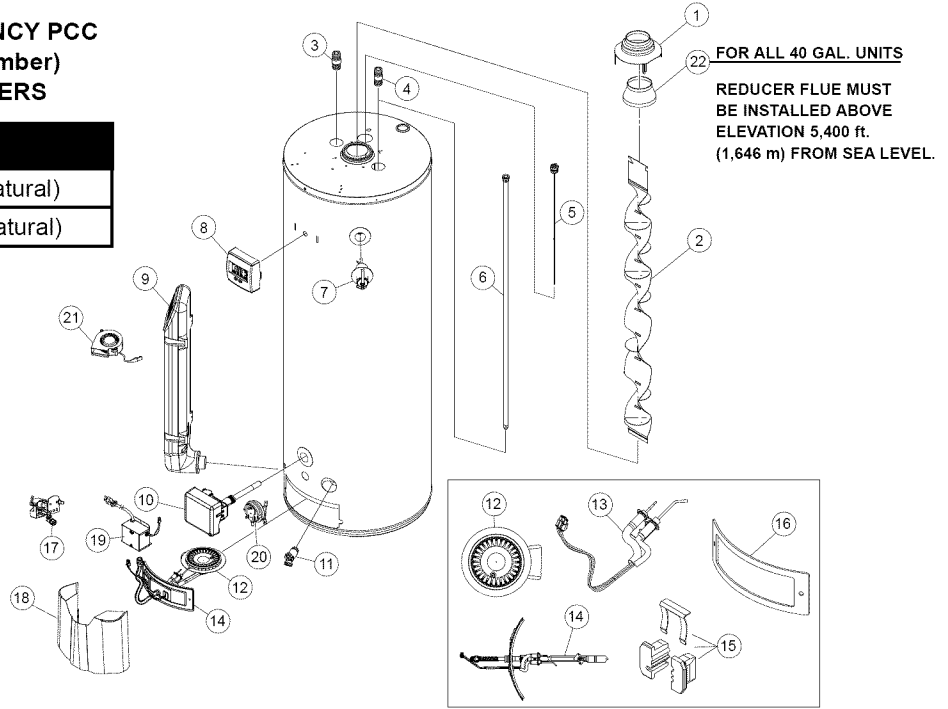

Key No.	Parts Description	153.332620	153.332640
1	Draft Hood (includes Reducer Flue)	9007362005	9007362005
2	Flue Baffle	9007363005	9007363005
3	Nipple (Hot)	9003719015	9003719015
4	Nipple (Cold)	9003719015	9003719015
5	Anode Rod	9007324005	9007324005
6	Cold Water Inlet Tube	9007364005	9007364005
7	Temperature and Pressure Valve	9000728015	9000728015
8	Electronic Control Display	9007320005	9007320005
9	Air Intake Chamber	9007316005	9007316005
10	Gas Control Valve/Thermostat	9007322005	9007322005
11	Drain Valve	9000580015	9000580015
12	Natural Gas Burner	9006948005	9006948005
13	Hot Surface Igniter (HSI)	185760-000	185760-000
14	Manifold Door Assembly (Includes: Manifold, Door, Burner, Burner Orifice, Hot Surface Igniter, Manifold Door Gasket and Manifold Component Block)	9007626005	9007627005
15	Manifold Component Block w/Retainer Clip	9006449015	9006449015
16	Manifold Door Gasket	9006141015	9006141015
17	FV Sensor	9005968015	9005968015
18	Outer Door	186295-002	186295-002
19	Electrical Transformer	9007311005	9007311005
20	Pressure Switch	9007323015	9007323015
21	Air Intake Chamber Fan	9007314005	9007314005
22	Reducer Flue	9008094005	N/A

Now that you have purchased your gas water heater, should a need ever exist for repair parts or service, simply contact any Sears Service Center or call 1-800-4-MY-HOME® (1-800-469-4663). Be sure to provide all pertinent facts when you call or visit.

WHEN ORDERING REPAIR PARTS, ALWAYS GIVE THE FOLLOWING INFORMATION:

- MODEL NUMBER
- TYPE GAS - NATURAL
- SERIAL NUMBER
- PART DESCRIPTION

THIS IS A REPAIR PARTS LIST, NOT A PACKING LIST.

NOTES

Get it fixed, at your home or ours!

Your Home

For troubleshooting, product manuals and expert advice:



www.managemylife.com

For repair – **in your home** – of **all** major brand appliances, lawn and garden equipment, or heating and cooling systems, **no matter who made it, no matter who sold it!**

For the replacement parts, accessories and owner's manuals that you need to do-it-yourself.

For Sears professional installation of home appliances and items like garage door openers and water heaters.

1-800-4-MY-HOME[®] (1-800-469-4663)

Call anytime, day or night (U.S.A. and Canada)

www.sears.com www.sears.ca

Our Home

For repair of carry-in items like vacuums, lawn equipment, and electronics, call anytime for the location of your nearest

Sears Parts & Repair Service Center

1-800-488-1222 (U.S.A.)

www.sears.com

1-800-469-4663 (Canada)

www.sears.ca

To purchase a protection agreement on a product serviced by Sears:

1-800-827-6655 (U.S.A.)

1-800-361-6665 (Canada)

Para pedir servicio de reparación a domicilio, y para ordenar piezas:

1-888-SU-HOGAR[®]

(1-888-784-6427)

www.sears.com

Au Canada pour service en français:

1-800-LE-FOYER^{MC}

(1-800-533-6937)

www.sears.ca

The Sears logo, consisting of the word "sears" in a lowercase, sans-serif font.

® Registered Trademark / TM Trademark of KCD IP, LLC in the United States, or Sears Brands, LLC in other countries

® Marca Registrada / TM Marca de Fábrica de KCD IP, LLC en Estados Unidos, o Sears Brands, LLC in otros países

^{MC} Marque de commerce / ^{MD} Marque déposée de Sears Brands, LLC