

SONY[®]

4-294-472-11(1)

FM Stereo FM/AM Receiver

Operating Instructions

STR-DH130

WARNING

To reduce the risk of fire or electric shock, do not expose this apparatus to rain or moisture.

To reduce the risk of fire, do not cover the ventilation opening of the apparatus with newspapers, tablecloths, curtains, etc. Do not place the naked flame sources such as lighted candles on the apparatus.

Do not install the appliance in a confined space, such as a bookcase or built-in cabinet.

To reduce the risk of fire or electric shock, do not expose this apparatus to dripping or splashing, and do not place objects filled with liquids, such as vases, on the apparatus.

As the main plug is used to disconnect the unit from the mains, connect the unit to an easily accessible AC outlet. Should you notice an abnormality in the unit, disconnect the main plug from the AC outlet immediately.

Do not expose batteries or apparatus with battery-installed to excessive heat such as sunshine, fire or the like.

The unit is not disconnected from the mains as long as it is connected to the AC outlet, even if the unit itself has been turned off.

Excessive sound pressure from earphones and headphones can cause hearing loss.



This symbol is intended to alert the user to the presence of the Hot Surface that may be hot if it is touched during the normal operation.

For customers in the United States

Owner's Record

The model and serial numbers are located on the rear of the unit. Record these numbers in the space provided below. Refer to them whenever you call upon your Sony dealer regarding this product.

Model No. _____ Serial No. _____



This symbol is intended to alert the user to the presence of uninsulated "dangerous voltage" within the product's enclosure that may be of sufficient magnitude to constitute a risk of electric shock to persons.



This symbol is intended to alert the user to the presence of important operating and maintenance (servicing) instructions in the literature accompanying the appliance.

Important Safety Instructions

- 1) Read these instructions.
- 2) Keep these instructions.
- 3) Heed all warnings.
- 4) Follow all instructions.
- 5) Do not use this apparatus near water.
- 6) Clean only with dry cloth.
- 7) Do not block any ventilation openings. Install in accordance with the manufacturer's instructions.
- 8) Do not install near any heat sources such as radiators, heat registers, stoves, or other apparatus (including amplifiers) that produce heat.
- 9) Do not defeat the safety purpose of the polarized or grounding-type plug. A polarized plug has two blades with one wider than the other. A grounding type plug has two blades and a third grounding prong. The wide blade or the third prong are provided for your safety. If the provided plug does not fit into your outlet, consult an electrician for replacement of the obsolete outlet.
- 10) Protect the power cord from being walked on or pinched particularly at plugs, convenience receptacles, and the point where they exit from the apparatus.
- 11) Only use attachments/accessories specified by the manufacturer.

- 12) Use only with the cart, stand, tripod, bracket, or table specified by the manufacturer, or sold with the apparatus. When a cart is used, use caution when moving the cart/apparatus combination to avoid injury from tip-over.



- 13) Unplug this apparatus during lightning storms or when unused for long periods of time.
- 14) Refer all servicing to qualified service personnel. Servicing is required when the apparatus has been damaged in any way, such as power-supply cord or plug is damaged, liquid has been spilled or objects have fallen into the apparatus, the apparatus has been exposed to rain or moisture, does not operate normally, or has been dropped.

The following FCC statement applies only to the version of this model manufactured for sale in the U.S.A. Other versions may not comply with FCC technical regulations.

NOTE:

This equipment has been tested and found to comply with the limits for a Class B digital device, pursuant to Part 15 of the FCC Rules. These limits are designed to provide reasonable protection against harmful interference in a residential installation.

This equipment generates, uses and can radiate radio frequency energy and, if not installed and used in accordance with the instructions, may cause harmful interference to radio communications. However, there is no guarantee that interference will not occur in a particular installation. If this equipment does cause harmful interference to radio or television reception, which can be determined by turning the equipment off and on, the user is encouraged to try to correct the interference by one or more of the following measures:

- Reorient or relocate the receiving antenna.
- Increase the separation between the equipment and receiver.
- Connect the equipment into an outlet on a circuit different from that to which the receiver is connected.
- Consult the dealer or an experienced radio/TV technician for help.

CAUTION

You are cautioned that any changes or modifications not expressly approved in this manual could void your authority to operate this equipment.

To reduce the risk of electric shock, the speaker cord should be connected to the apparatus and the speakers in accordance with the following instructions.

- 1) Disconnect the AC power cord from the MAINS.
- 2) Strip 10 to 15 mm of the wire insulation of the speaker cord.
- 3) Connect the speaker cord to the apparatus and the speakers carefully so as not to touch the core of speaker cord by hand. Also disconnect the AC power cord from the MAINS before disconnecting the speaker cord from the apparatus and the speakers.

For customers in Europe



Disposal of Old Electrical & Electronic Equipment (Applicable in the European Union and other European countries with separate collection systems)

This symbol on the product or on its packaging indicates that this product shall not be treated as household waste. Instead it shall be handed over to the applicable collection point for the recycling of electrical and electronic equipment. By ensuring this product is disposed of correctly, you will help prevent potential negative consequences for the environment and human health, which could otherwise be caused by inappropriate waste handling of this product. The recycling of materials will help to conserve natural resources. For more detailed information about recycling of this product, please contact your local Civic Office, your household waste disposal service or the shop where you purchased the product.



Disposal of waste batteries (applicable in the European Union and other European countries with separate collection systems)

This symbol on the battery or on the packaging indicates that the battery provided with this product shall not be treated as household waste.

On certain batteries this symbol might be used in combination with a chemical symbol. The chemical symbols for mercury (Hg) or lead (Pb) are added if the battery contains more than 0.0005% mercury or 0.004% lead.

By ensuring these batteries are disposed of correctly, you will help prevent potentially negative consequences for the environment and human health which could otherwise be caused by inappropriate waste handling of the battery. The recycling of the materials will help to conserve natural resources.

In case of products that for safety, performance or data integrity reasons require a permanent connection with an incorporated battery, this battery should be replaced by qualified service staff only.

To ensure that the battery will be treated properly, hand over the product at end-of-life to the applicable collection point for the recycling of electrical and electronic equipment.

For all other batteries, please view the section on how to remove the battery from the product safely. Hand the battery over to the applicable collection point for the recycling of waste batteries.

For more detailed information about recycling of this product or battery, please contact your local Civic Office, your household waste disposal service or the shop where you purchased the product.

Notice for customers: The following information is only applicable to equipment sold in countries applying EU Directives.

The manufacturer of this product is Sony Corporation, 1-7-1 Konan Minato-ku Tokyo, 108-0075 Japan. The Authorized Representative for EMC and product safety is Sony Deutschland GmbH, Hedelfinger Strasse 61, 70327 Stuttgart, Germany. For any service or guarantee matters please refer to the addresses given in separate service or guarantee documents.

About This Manual

- The instructions in this manual are for model STR-DH130. The model number is located at the lower right corner of the front panel. The illustrations used in this manual are of Europe model and they may be different from your model. Any differences in operation are marked in the manual as "Europe model only".
- The instructions in this manual describe the operation of the receiver with the supplied remote control. You can also use the buttons or knobs on the receiver if they have the same or similar names as those on the remote control.

Table of Contents

About This Manual	4
Supplied accessories	6
Description and location of parts	7
Getting started	13

Connections

1: Installing the speakers	13
2: Connecting the speakers	14
3: Connecting the audio/video equipment ...	14
4: Connecting the antennas (aerials).....	17
5: Connecting the AC power cord (mains lead)	18

Preparing the Receiver

Initializing the receiver	18
Selecting the speaker system	19
Adjusting the tone.....	19

Basic Operations

Playback	20
Viewing information on the display panel	21
Recording using the receiver	22

Tuner Operations

Listening to FM/AM radio	22
Presetting FM/AM radio stations (Preset Tuning)	24
Receiving RDS broadcasts	26
(Europe model only)	

Menu Operations

Using the setting menu	26
------------------------------	----

Using the Remote Control

Reassigning the input button	27
Resetting the input buttons	28

Additional Information

Precautions	29
Troubleshooting	30
Specifications	32
Index	34

Supplied accessories

- Operating Instructions (this manual)
- Quick Setup Guide
- FM wire antenna (aerial) (1)



- AM loop antenna (aerial) (1)



- Remote control (RM-AAU130) (1)

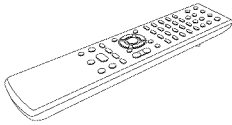

- R6 (size AA) batteries (2)



Inserting batteries into the remote control

Insert two R6 (size AA) batteries (supplied) by matching \oplus and \ominus on the batteries to the diagram inside the battery compartment of the remote control.

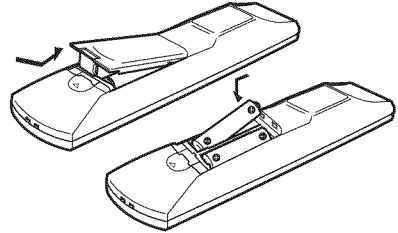

Notes

- Do not leave the remote control in an extremely hot or humid place.
- Do not use a new battery with old ones.
- Do not mix manganese batteries and other kinds of batteries.
- Do not expose the remote control sensor to direct sunlight or lighting apparatuses. Doing so may cause a malfunction.
- If you do not intend to use the remote control for an extended period of time, remove the batteries to avoid possible damage from battery leakage and corrosion.
- When you replace or remove the batteries, the remote control buttons may be reset to their default settings. If this happens, reassign the input buttons (page 27).
- When the receiver no longer responds to the remote control, replace all the batteries with new ones.

Description and location of parts

Front panel

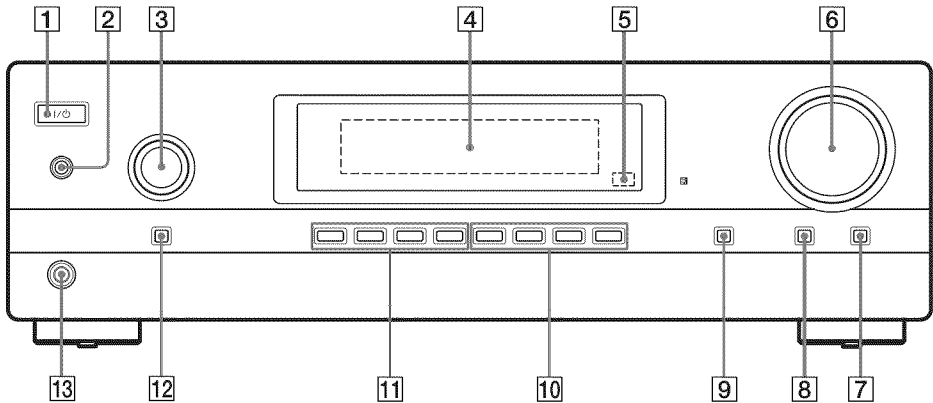

Indicators on the display panel

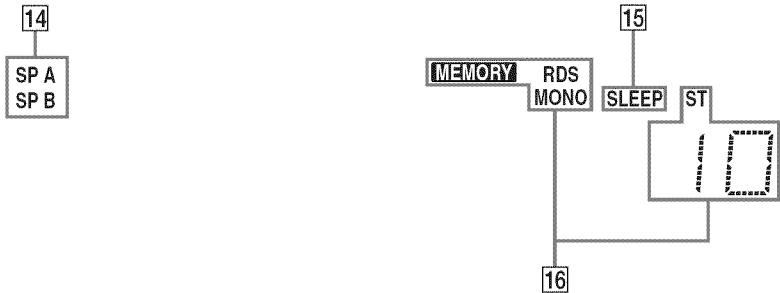

- 1 I/⏻ (on/standby) (page 18, 24)
- 2 SPEAKERS (OFF/A/B/A+B) (page 14, 19)
- 3 INPUT SELECTOR (page 20, 22 - 25)
- 4 Display panel
- 5 Remote control sensor
Receives signals from remote control.
- 6 MASTER VOLUME (page 20)
- 7 MUTING (page 20)
- 8 DIMMER
Adjusts the brightness of the display panel in 3 levels.
- 9 DISPLAY (page 21)
- 10 BASS +/-, TREBLE +/- (page 19)
- 11 TUNING MODE, TUNING +/-, MEMORY/ENTER (page 23, 25)
- 12 FM MODE (page 23)
- 13 PHONES jack (page 30)

continued

14 SP A/SP B

Lights up according to the speaker system used (page 19). However, these indicators do not light up if the speaker output is turned off or if headphones are connected.

15 SLEEP

Lights up when the Sleep Timer is activated (page 11).

16 Tuning indicators

Lights up when the receiver tunes to a radio station.

MEMORY

A memory function, such as Preset Memory (page 24), etc., is activated.

RDS (Europe model only)

Tuned to a station with RDS services.

MONO

Monaural broadcast

ST

Stereo broadcast





Preset station number (The number will change according to the preset station you select.)

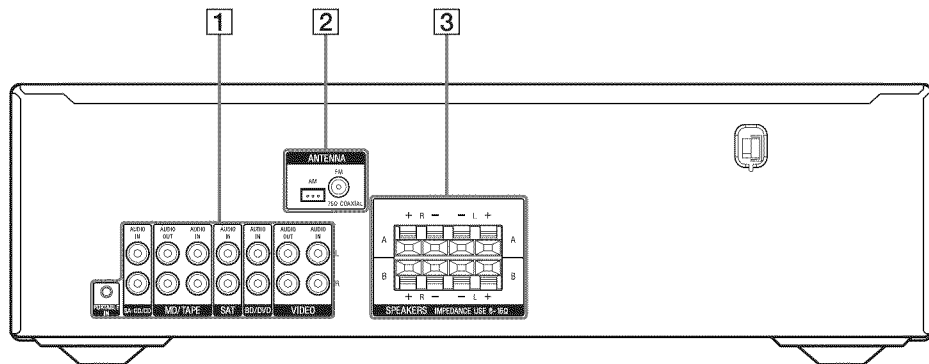

Rear panel



1 Audio signal section (page 14, 16)

-  White (L)
AUDIO IN/OUT jacks
-  Red (R)
-  PORTABLE IN jack

2 ANTENNA section (page 17)

-  FM ANTENNA jack
-  AM ANTENNA terminals

3 SPEAKERS section (page 14)







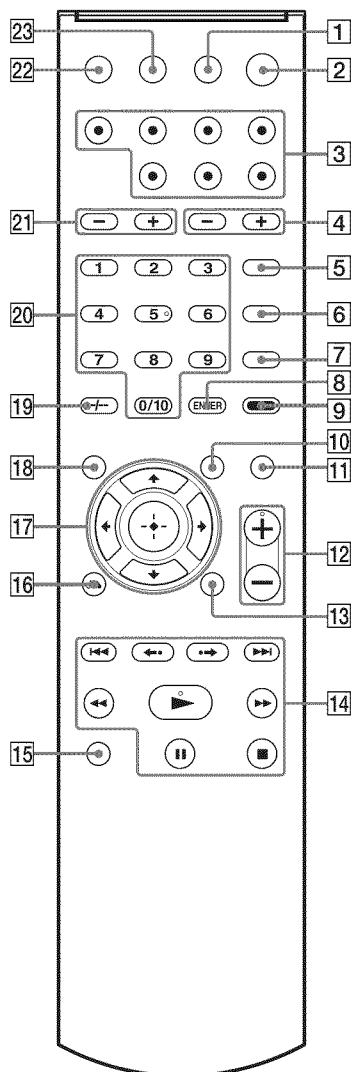

Remote control

Use the supplied remote control to operate this receiver and other equipment. The remote control is assigned to operate Sony audio/video equipment. You can reassign the input button to match the equipment connected to your receiver (page 27).

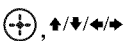
RM-AAU130



To control the receiver

- 2 I/O* (on/standby)**
Turns the receiver on or sets it to standby mode.
- 3 Input buttons**
Selects the equipment you want to use. When you press any of the input buttons, the receiver turns on. The buttons are assigned to control Sony equipment.
- 7 D.TUNING**
Enters direct tuning mode.
- 8 ENTER/MEMORY**
Stores a station during tuner operation.
- 9 AMP MENU**
Displays the menu to operate the receiver.
- 11 MUTING**
Turns off the sound temporarily.
Press the button again to restore the sound.
- 12 MASTER VOL +**/-**
Adjust the volume level of all speakers at the same time.
- 14 TUNING +/-**
Scans a station.
PRESET +/-
Selects preset stations.
FM MODE
Selects the FM monaural or stereo reception.
- 16 RETURN/EXIT**
Returns to the previous menu.
- 17** 
Press /// to select the settings, then press  to enter/confirm the selection.
- 18 DISPLAY**
Views information on the display panel.
- 20 Numeric buttons****
Presets or tune to the preset stations.

22 SLEEP

Sets the receiver to turn off automatically at a specified time.

Each time you press this button, the display changes cyclically as follows.

0-30-00 → 1-00-00 → 1-30-00 → 2-00-00 → OFF

When Sleep Timer is being used, "SLEEP" indicator lights up in the display panel.

Tip

To check the remaining time before the receiver turns off, press SLEEP. The remaining time appears on the display panel. If you press SLEEP again, the Sleep Timer will be canceled.

- * If you press AV I/⏻ (1) and I/⏻ (2) simultaneously, the receiver and connected equipment will turn off (SYSTEM STANDBY). The function of the AV I/⏻ (1) changes automatically each time you press the input buttons (3).
- ** The number 5, MASTER VOL +/TV VOL +, and ► buttons have tactile dots. Use the tactile dots as references when operating the receiver.

To control a Sony TV

Hold down TV (15), then press the button printed in orange to select the function you want.

Example: Hold down TV (15), then press TV CH +.

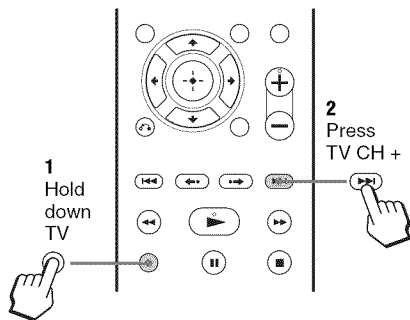

1 TV I/⏻ (on/standby)

Turns the TV on or off.

8 ENTER/MEMORY

Enters the selections.

10 TOOLS/OPTIONS

Displays the TV function options.

11 MUTING

Activates the TV's muting function.

12 TV VOL +**/-

Adjusts the TV volume.

13 MENU/HOME

Displays the TV menus.

14 TV CH +/-

Scans for the preset TV channels.

16 RETURN/EXIT ↶

Returns to the previous TV menu.

18 DISPLAY

Displays information related to the current TV program.

19 -/--

Selects TV channel entry mode.

>10/-

Selects the channel numbers of the Digital CATV terminal.

For example, to select 2.1, press 2, >10/- and 1.

20 Numeric buttons**

Selects the TV channels.

23 TV INPUT

Selects the input signal.

- * If you press AV I/⏻ (1) and I/⏻ (2) simultaneously, the receiver and connected equipment will turn off (SYSTEM STANDBY). The function of the AV I/⏻ (1) changes automatically each time you press the input buttons (3).

- ** The number 5, MASTER VOL +/TV VOL +, and ► buttons have tactile dots. Use the tactile dots as references when operating the receiver.

To control other Sony equipment

Name	Blu-ray Disc, DVD player	Satellite tuner, Cable TV tuner	VCR	CD player	MD deck, Tape deck
1 AV I/⏻ ^{a)}	Power	Power	Power	Power	Power ^{c)}
5 POP UP/MENU	Menu	–	–	–	–
6 TOP MENU	On-screen guide	–	–	–	–
8 ENTER/MEMORY	Enter	Enter	Enter	Enter	–
10 TOOLS/OPTIONS	Options menu	Options menu	–	–	–
13 MENU/HOME	Menu	Menu	Menu	–	–
14 ⏮/⏭	Skip track	Select channel	Search index	Skip track	Skip track
REPLAY ⏮/⏭ ADVANCE ⏮/⏭	Replay, fast forward	–	Replay, fast forward	–	–
⏮/⏭	Search forward, backward	–	Fast forward, rewind	Fast forward, rewind	Fast forward, rewind
▶ ^{b)}	Play	–	Play	Play	Play
⏸	Pause	–	Pause	Pause	Pause
■	Stop	–	Stop	Stop	Stop
16 RETURN/EXIT ↶	Return	Return, exit	–	–	–
17 ⊕	Enter	Enter	Enter	Enter	Enter ^{c)}
⬆/⬇/⬅/➡	Select	Select	Select	–	–
18 DISPLAY	Display	Display	Display	Display	Display ^{c)}
19 -/--	–	–	–	–	–
>10/•	–	(.)dot ^{d)}	Track > 10	Track > 10	–
CLEAR	Clear	Clear	–	–	–
20 Numeric buttons ^{b)}	Track	Channel	Channel	Track	Track ^{c)}

^{a)}If you press AV I/⏻ (1) and I/⏻ (2) simultaneously, the receiver and connected equipment will turn off (SYSTEM STANDBY). The function of the AV I/⏻ (1) changes automatically each time you press the input buttons (3).

^{b)}The number 5, MASTER VOL +/TV VOL +, and ▶ buttons have tactile dots. Use the tactile dots as references when operating the receiver.

^{c)}For MD deck only.

^{d)}For example, to select 2.1, press 2, >10/• and 1.

Notes

- The above explanation is intended to serve as examples.
- Depending on the model of your connected equipment, some functions explained in this section may not work with the supplied remote control.

Getting started

You can enjoy your audio/video equipment connected to the receiver by following the simple steps below.

Installing and connecting the speakers (page 13, 14)



Connecting the audio/video equipment (page 14, 16)



Preparing the receiver

See “5: Connecting the AC power cord (mains lead)” (page 18) and “Initializing the receiver” (page 18).



Selecting the speaker system (page 19)

Connections

1: Installing the speakers

This receiver allows you to use a 2.0 channel system.

Example of speaker system configuration

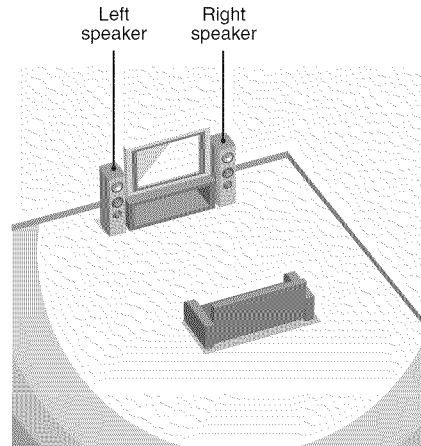

2: Connecting the speakers

Before connecting the cords, be sure to disconnect the AC power cord (mains lead).

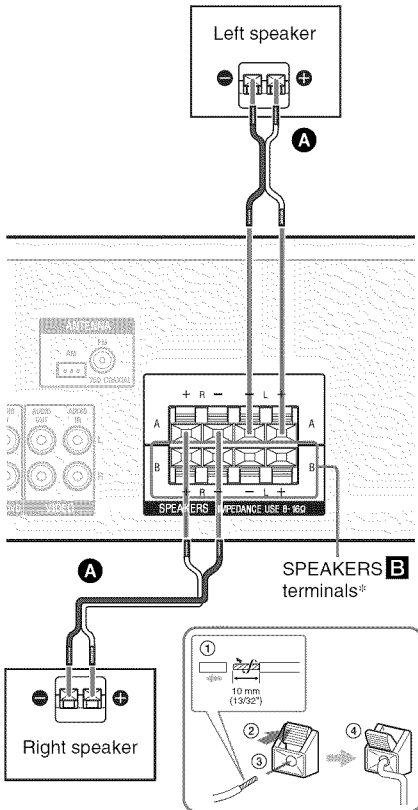

A Speaker cords (not supplied)

* If you have an additional speaker system, connect them to the SPEAKERS **B** terminals. You can select the speakers you want to use with the SPEAKERS (OFF/A/B/A+B) button on the receiver (page 19).

3: Connecting the audio/video equipment

Connecting the audio equipment

Before connecting cords, be sure to disconnect the AC power cord (mains lead).

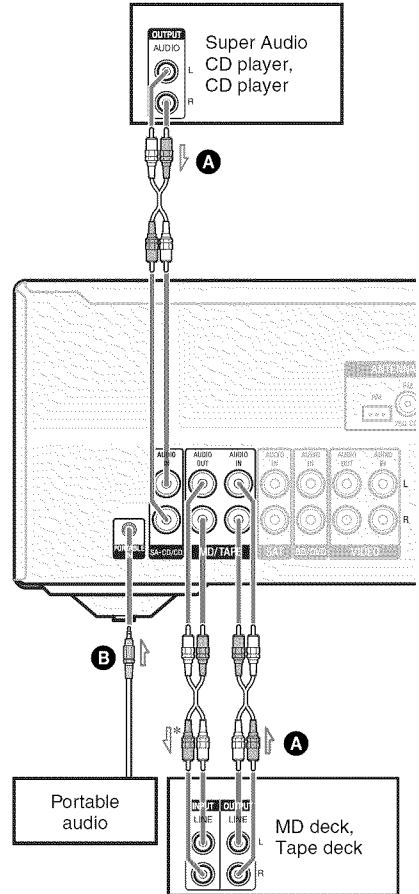

A Audio cord (not supplied)

B Phono cord with stereo headphone jack (not supplied)

* If you want to record, you must make this connection (page 22).

Notes

- When listening to a equipment connected to the PORTABLE IN jack, sound may be distorted or interrupted. This is not a malfunction and will depend on the connected equipment.
- If the sound from the equipment connected to the PORTABLE IN jack is very soft, you may increase the volume level. However, before you switch to other input, be sure to reduce the volume level to avoid damaging your speaker.

Connecting the video equipment

Before connecting cords, be sure to disconnect the AC power cord (mains lead).

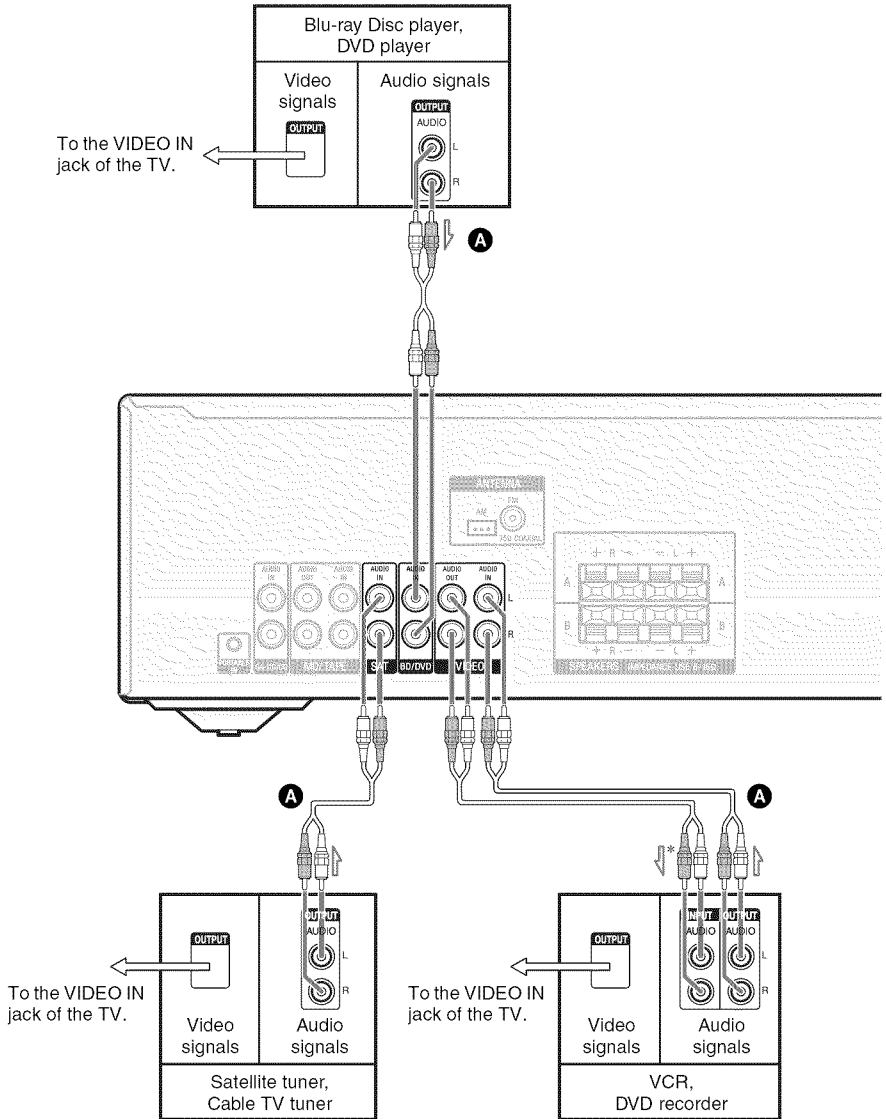

A Audio cord (not supplied)

* If you want to record, you must make this connection (page 22).

Notes

- The default setting for the BD/DVD and VIDEO input buttons on the remote control is as follows:
BD/DVD: Blu-ray Disc player
VIDEO: VCR
Be sure to change the default setting of the BD/DVD (and VIDEO) input button so that you can use the button to control your DVD player (and DVD recorder). For details, see “Reassigning the input button” (page 27).
- You can also rename the BD/DVD and VIDEO input so that it can be displayed on the receiver’s display panel. For details, see “Naming inputs” (page 20).

4: Connecting the antennas (aerials)

Before connecting antennas (aerials), be sure to disconnect the AC power cord (mains lead).

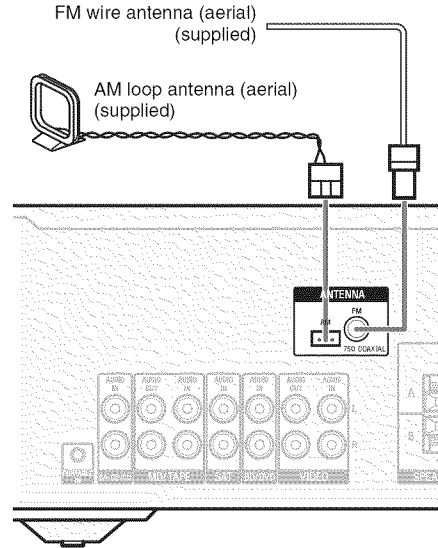

Notes

- To prevent noise pickup, keep the AM loop antenna (aerial) away from the receiver and other equipment.
- Be sure to fully extend the FM wire antenna (aerial).
- After connecting the FM wire antenna (aerial), keep it as horizontal as possible.

5: Connecting the AC power cord (mains lead)

Connect the AC power cord (mains lead) to a wall outlet.

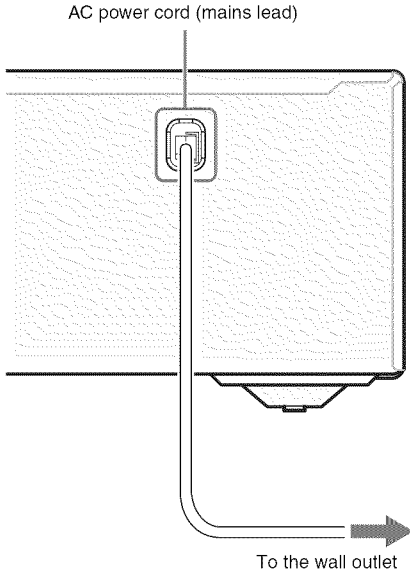

Preparing the Receiver

Initializing the receiver

Before using the receiver for the first time, initialize the receiver by performing the following procedure. This procedure can also be used to revert back to the factory default settings.

Be sure to use the buttons on the receiver to perform this operation.

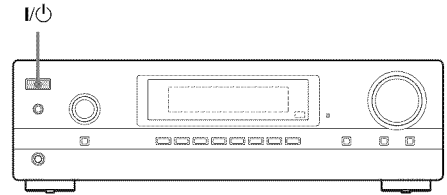

- 1 Press I/Power to turn off the receiver.**
- 2 Hold down I/Power for 5 seconds.**

The “CLEARING” appears on the display panel for a while, then changes to “CLEARED”.

Changes or adjustments made to the settings are now reset to the defaults.

Selecting the speaker system

You can select the speakers you want to drive, if you have connected the speakers to SPEAKERS **A** and **B** terminals. Be sure to use the buttons on the receiver to perform this operation.

SPEAKERS (OFF/A/B/A+B)

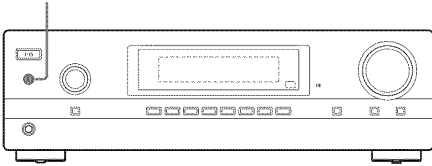

Press SPEAKERS (OFF/A/B/A+B) repeatedly to select the speaker system you want to drive.

To select	Light up
The speakers connected to the SPEAKERS A terminals	SP A
The speakers connected to the SPEAKERS B terminals	SP B
The speakers connected to both the SPEAKERS A and B terminals (parallel connection)	SP A SP B

To turn off the speaker output

Press SPEAKERS (OFF/A/B/A+B) repeatedly until the “SP A” and “SP B” indicators on the display do not light up.

Note

You cannot switch the speaker system by pressing SPEAKERS (OFF/A/B/A+B) when the headphones are connected.

Adjusting the tone

You can adjust the tonal quality of the speakers.

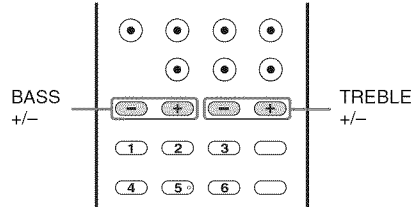

Press TREBLE + or TREBLE – repeatedly to adjust the treble level.

Press BASS + or BASS – repeatedly to adjust the bass level.

You can adjust from -10 dB to $+10$ dB in 1 dB step.

The initial setting is 0 dB.

Basic Operations

Playback

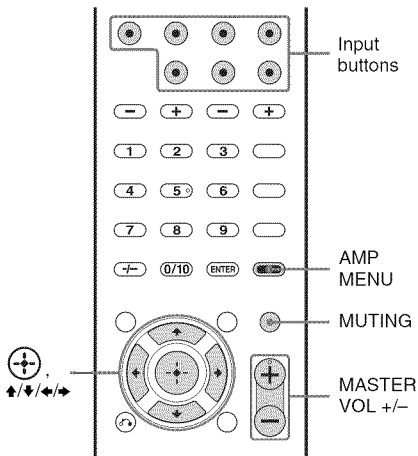

- 1 Turn on the connected equipment.**
- 2 Turn on the receiver.**
- 3 Press the input button which corresponds to the equipment you want.**

You can also use INPUT SELECTOR on the receiver.
The selected input appears on the display panel.

Note

When you press TUNER, "FM TUNER" or "AM TUNER" appears for a while, and then frequency appears on the display panel.

- 4 Play back the source.**
- 5 Press MASTER VOL +/- to adjust the volume.**

You can also use MASTER VOLUME on the receiver.

To activate the muting function

Press MUTING.

The muting function will be canceled when you do the following.

- Press the button again.
- Increase the volume.
- Turn off the receiver.

To avoid damaging your speakers

Before you turn off the receiver, be sure to turn down the volume level.

Naming inputs

You can enter a name of up to 8 characters for inputs (except TUNER) to appear on the display panel.

It is more recognizable having the equipment named on the display than the jacks.

- 1 Press the corresponding input button which you want to create an index name.**
You can also use INPUT SELECTOR on the receiver.
- 2 Press AMP MENU.**
- 3 Press \uparrow/\downarrow repeatedly to select "NAME IN", then press \oplus or \rightarrow .**
The cursor flashes and you can enter a character.
- 4 Press \uparrow/\downarrow to select a character, then press \leftarrow/\rightarrow to move the input position backward and forward.**

Tips

- You can select the character type as follows by pressing \uparrow/\downarrow .
Alphabet (upper case) \rightarrow Numbers \rightarrow Symbols
- To enter a blank space, press \rightarrow without selecting a character.

If you made a mistake

Press ←/→ until the character you want to change flashes, then press ↑/↓ to select the correct character.

5 Press .

The name you entered is registered.

When receiving RDS broadcasts (Europe model only)

Program Service name or preset station name* → Frequency, band and preset number → Volume level

* Index name appears only when you have assigned one to the input or preset station (page 20, 25). Index name does not appear when only blank spaces have been entered, or it is the same as the input name.

Viewing information on the display panel

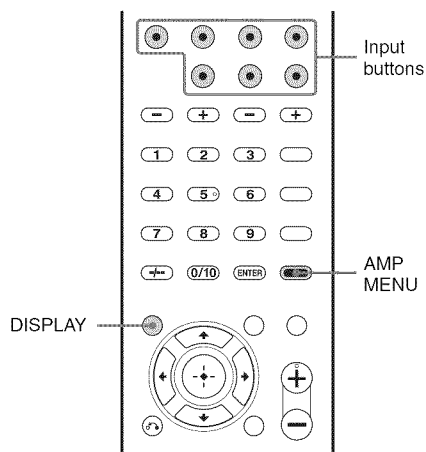

1 Press the corresponding input button which you want to check the information.

2 Press AMP MENU, then press DISPLAY repeatedly.

Each time you press the button, the display changes cyclically as follows:

Index name of the input* → Selected input → Volume level

When listening to FM and AM radio

Preset station name* → Frequency, band and preset number → Volume level

Note

Character or marks may not be displayed for some languages.

Recording using the receiver

You can record sound from an audio/video equipment using the receiver. Refer to the operating instructions supplied with your recording equipment.

1 Press the input button which corresponds to the playback equipment.

You can also use INPUT SELECTOR on the receiver.

2 Prepare the playback equipment for playing.

For example, insert the CD you want to copy into the CD player.

3 Prepare the recording equipment.

Insert a blank MD, tape or video tape into the recording equipment (connected to MD/TAPE AUDIO OUT or VIDEO AUDIO OUT jacks).

4 Start recording on the recording equipment, then start the playback equipment.

Notes

- Some sources contain copyright protection to prevent recording. In this case, you may not be able to record from the source.
- Sound adjustments do not affect the signal output from the MD/TAPE AUDIO OUT or VIDEO AUDIO OUT jacks.
- While the source is being recorded, the auto standby function of the receiver may start up and interrupt the recording. In this case, set the "AUTO.STBY" to "STBY OFF" (page 27).
- You can record the sound from the video equipment connected to this receiver. However, you cannot record the image via this receiver.

Tuner Operations

Listening to FM/AM radio

You can listen to FM and AM broadcasts through the built-in tuner. Before operation, make sure you have connected the FM and AM antennas (aerials) to the receiver (page 17).

Tip

The tuning scale for direct tuning is shown below.

Area	FM	AM
USA, Canada	100 kHz	10 kHz*
Europe	50 kHz	9 kHz

* The AM tuning scale can be changed (page 24).

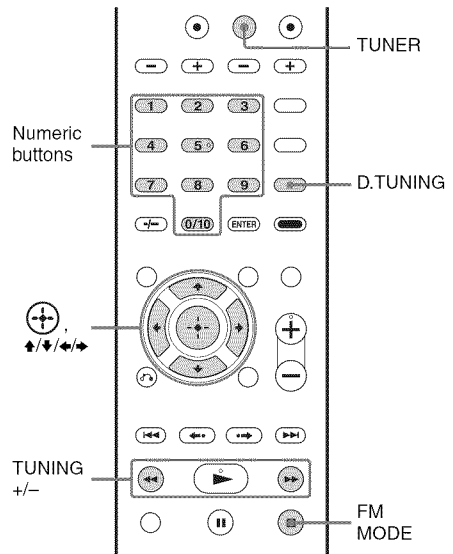

Tuning to a station automatically (Automatic Tuning)

- 1** Press **TUNER** repeatedly to select the FM or AM band.
- 2** Press **TUNING +** or **TUNING -**.
TUNING + scans from lower to higher frequency stations and **TUNING -** for scanning higher to lower.
 The receiver stops scanning whenever a station is received.

Using the control buttons on the receiver

- 1** Turn **INPUT SELECTOR** to select the FM or AM band.
- 2** Press **TUNING MODE** repeatedly to select "AUTO".
- 3** Press **TUNING +** or **TUNING -**.

In case of poor FM stereo reception

If the FM stereo reception is poor and "ST" flashes on the display panel, select monaural audio to lessen the sound distortion.

Press **FM MODE** repeatedly until the "MONO" indicator lights up on the display panel.

To return to the stereo mode, press **FM MODE** repeatedly until the "MONO" indicator on the display panel does not light up.

Tuning to a station directly (Direct Tuning)

You can enter the frequency of a station directly by using the numeric buttons.

- 1** Press **TUNER** repeatedly to select the FM or AM band.
 You can also use **INPUT SELECTOR** on the receiver.
- 2** Press **D.TUNING**.
- 3** Press the numeric buttons to enter the frequency.

Example 1: FM 102.50 MHz

• USA and Canada models only:

Select 1 → 0 → 2 → 5

• Other models:

Select 1 → 0 → 2 → 5 → 0

Example 2: AM 1,350 kHz

Select 1 → 3 → 5 → 0

Tip

Adjust the direction of the AM loop antenna (aerial) for optimum reception upon tuning to an AM station.

- 4** Press **⊕**.

If you cannot tune to a station

"- - - - - MHz" or "- - - - - kHz" appears and then the screen returns to the current frequency.

Make sure you have entered the right frequency. Try repeating steps 2 to 4. If you still cannot tune to a station, the frequency may not be in use in your area.

Changing the AM tuning scale

(USA and Canada models only)

You can change the AM tuning scale to either 9 kHz or 10 kHz using the buttons on the receiver.

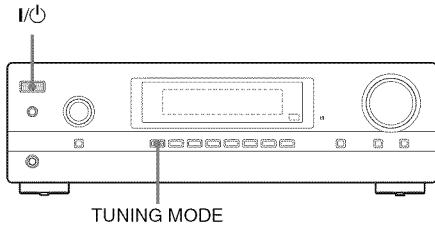

- 1 Press I/Power to turn off the receiver.**
- 2 While holding down TUNING MODE, press I/Power.**
- 3 Change the current AM tuning scale to 9 kHz (or 10 kHz).**

To reset the scale to 10 kHz (or 9 kHz), repeat the procedure above.

Note

All preset stations will be erased when you change the tuning scale.

Presetting FM/AM radio stations

(Preset Tuning)

You can store up to 30 FM and 30 AM stations as your favorite stations as preset stations.

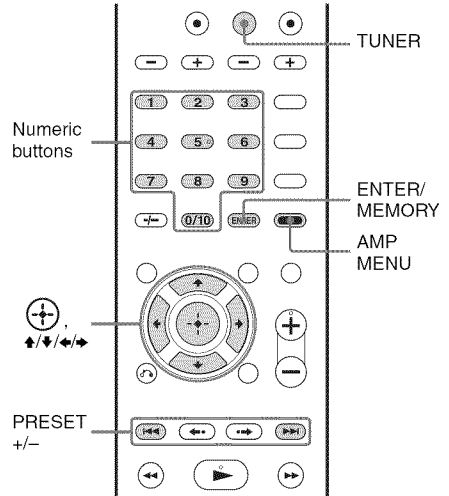

- 1 Press TUNER repeatedly to select the FM or AM band.**
You can also use INPUT SELECTOR on the receiver.
- 2 Tune to the station that you want to preset using Automatic Tuning (page 23) or Direct Tuning (page 23).**
- 3 Press ENTER/MEMORY.**
You can also use MEMORY/ENTER on the receiver.
- 4 Press the numeric buttons to select a preset number.**
You can also press PRESET + or PRESET - to select a preset number.

5 Press **⊕**.

The station is stored as the selected preset number.

6 Repeat steps 1 to 5 to store another station.

Tuning to preset stations

1 Press **TUNER** repeatedly to select the FM or AM band.

You can also use **INPUT SELECTOR** on the receiver.

2 Press **PRESET +** or **PRESET -** repeatedly to select the station.

Each time you press the button, you can select a preset station as follows:

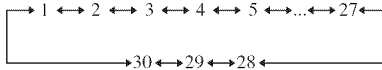

You can also press the numeric buttons to enter the preset station. To tune to the selection, press **⊕**.

Using the control buttons on the receiver

- 1** Turn **INPUT SELECTOR** to select the FM or AM band.
- 2** Press **TUNING MODE** repeatedly to select “PRESET”.
- 3** Press **TUNING +** or **TUNING -** to select the preset station you want.

Naming preset stations

1 Press **TUNER** repeatedly to select the FM or AM band.

You can also use **INPUT SELECTOR** on the receiver.

2 Tune to the preset station you want to create an index name for (page 25).

3 Press **AMP MENU**.

4 Press **↑/↓** repeatedly to select “NAME IN”, then press **⊕** or **➔**.

The cursor flashes and you can enter a character.

5 Press **↑/↓** to select a character, then press **←/→** to move the input position backward and forward.

You can enter up to 8 characters to name the station.

Tips

- You can select the character type as follows by pressing **↑/↓**.
Alphabet (upper case) → Numbers → Symbols
- To enter a blank space, press **➔** without selecting a character.

If you made a mistake

Press **←/→** until the character you want to change flashes, then press **↑/↓** to select the correct character.

6 Press **⊕**.

The name you entered is registered.

Note (Europe model only)

When you name an RDS (Radio Data System) station and tune to that station, the Program Service name appears instead of the name you entered.

Receiving RDS broadcasts

(Europe model only)

This receiver allows you to use Radio Data System (RDS), which enables radio stations to send additional information along with the regular programming signal. This receiver offers convenient RDS features, such as Program Service name display. RDS is available only for FM stations.*

* Not all FM stations provide RDS service, nor do they provide the same type of services. If you are not familiar with the RDS services in your area, check with your local radio stations for details.

Simply select a station on the FM band using Direct Tuning (page 23), Automatic Tuning (page 23), or Tuning with Preset Station (page 25).

When you tune to a station that provides RDS services, “RDS” lights up and the Program Service name appears on the display panel.

Note

RDS may not work properly if the station you tuned to is not transmitting the RDS signal or if the signal strength is weak.

Tip

While a Program Service name is displayed, you can check the frequency by pressing DISPLAY repeatedly (page 21).

Menu Operations

Using the setting menu

You can customize the receiver by making various adjustments with setting menu.

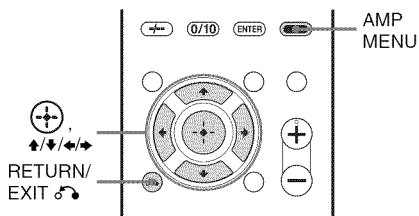

- 1 Press AMP MENU.**
- 2 Press \uparrow/\downarrow repeatedly to select the menu item you want, then press \oplus or \rightarrow .**
- 3 Press \uparrow/\downarrow repeatedly to select the setting you want, then press \oplus .**

To return to the previous display

Press \leftarrow or RETURN/EXIT .

To exit the menu

Press AMP MENU.

Note

Some parameters and settings may appear dimmed on the display panel. This means that they are either unavailable or fixed and unchangeable.

Overview of the menus

■ BALANCE (Speaker balance)

Lets you adjust the balance between left and right speakers.

You can adjust from BAL. L+10 to

BAL. R+10 in 1dB/step.

The initial setting is BAL. 0.

■ NAME IN (Naming)

Lets you set the name of inputs and preset stations. For details, see “Naming inputs” (page 20) and “Naming preset stations” (page 25).

■ AUTO.STBY (Auto Standby)

Lets you set the receiver switch to standby mode automatically when you do not operate the receiver or when there is no signals input to the receiver.

- STBY ON

Switches to standby mode after approximately 30 minutes.

- STBY OFF

Does not switch to standby mode.

Notes

- This function does not work when TUNER input is selected.
- If you use the Auto standby mode and the Sleep Timer at the same time, the Sleep Timer has priority.

Using the Remote Control

Reassigning the input button

You can change the default settings of the input buttons to suit the equipment in your system. For example, if you connect a Blu-ray Disc player to the SAT jack on the receiver, you can set the SAT button on this remote control to control the Blu-ray Disc player.

Note

You cannot reassign the TUNER and PORTABLE input buttons.

1 Hold down the input button of which you want to change the assignment.

Example: Hold down SAT.

2 Referring to the table below, press the corresponding button for the category you want.

Example: Press 8.

Now you can use the SAT button to control the Blu-ray Disc player.

Categories and the corresponding buttons

Categories	Press
VCR (command mode VTR 3) ^{a)}	1
DVD player (command mode DVD1)	2
DVD recorder (command mode DVD3) ^{b)}	3
CD player	4
Euro Digital Satellite Receiver	5
DVR (Digital CATV terminal)	6
DSS (Digital Satellite Receiver)	7
Blu-ray Disc player (command mode BD1) ^{c)}	8
Blu-ray Disc recorder (command mode BD3) ^{c)}	9
MD deck	0/10
Tape deck	-/--

^{a)} Sony VCRs are operated with a VTR 3 setting which corresponds to VHS.

^{b)} Sony DVD recorders are operated with a DVD1 or DVD3 setting. For details, refer to the operating instructions supplied with the DVD recorders.

^{c)} For details on the BD1 or BD3 setting, refer to the operating instructions supplied with the Blu-ray Disc player or Blu-ray Disc recorder.

Resetting the input buttons

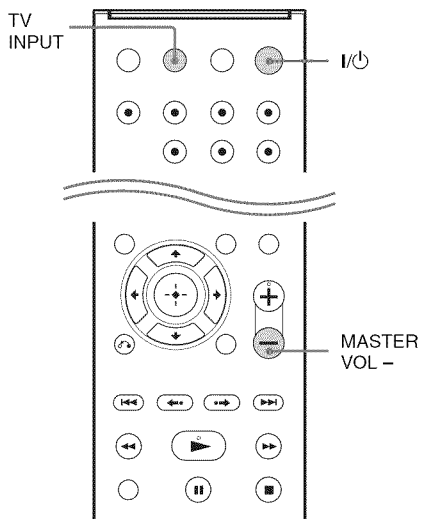

1 While holding down **MASTER VOL -**, press **I/O** and **TV INPUT**.

2 Release all buttons.

The input buttons are reset to the default setting.

Precautions

On safety

Should any solid object or liquid fall into the cabinet, unplug the receiver and have it checked by qualified personnel before operating it any further.

On power sources

- Before operating the receiver, check that the operating voltage is identical with your local power supply.
The operating voltage is indicated on the nameplate on the back of the receiver.
- The unit is not disconnected from the AC power source (mains) as long as it is connected to the wall outlet, even if the unit itself has been turned off.
- If you are not going to use the receiver for a long time, be sure to disconnect the receiver from the wall outlet. To disconnect the AC power cord (mains lead), grasp the plug itself; never pull the cord.
- The AC power cord (mains lead) must be changed only at a qualified service shop.
- (USA and Canada models only)
One blade of the plug is wider than the other for the purpose of safety and will fit into the wall outlet only one way. If you are unable to insert the plug fully into the outlet, contact your dealer.

On heat buildup

Although the receiver heats up during operation, this is not a malfunction. If you continuously use this receiver at a large volume, the cabinet temperature of the top, side and bottom rises considerably. To avoid burning yourself, do not touch the cabinet.

On placement

- Place the receiver in a location with adequate ventilation to prevent heat buildup and prolong the life of the receiver.
- Do not place the receiver near heat sources, or in a place subject to direct sunlight, excessive dust, or mechanical shock.
- Do not place anything on top of the cabinet that might block the ventilation holes and cause malfunctions.
- Do not place the receiver near equipment such as a TV, VCR, or tape deck. (If the receiver is being used in combination with a TV, VCR, or tape deck, and is placed too close to that equipment, noise may result, and picture quality may suffer. This is especially likely when using an indoor antenna (aerial). Therefore, we recommend using an outdoor antenna (aerial).)
- Use caution when placing the receiver on surfaces that have been specially treated (with wax, oil, polish, etc.) as staining or discoloration of the surface may result.

On operation

Before connecting other equipment, be sure to turn off and unplug the receiver.

On cleaning

Clean the cabinet, panel, and controls with a soft cloth slightly moistened with a mild detergent solution. Do not use any type of abrasive pad, scouring powder, or solvent, such as alcohol or benzine.

If you have any questions or problems concerning your receiver, please consult your nearest Sony dealer.

Troubleshooting

If you experience any of the following difficulties while using the receiver, use this troubleshooting guide to help you remedy the problem. Should any problem persist, consult your nearest Sony dealer. Note that if service personnel changes some parts during repair, these parts may be retained.

Power

The receiver is turned off automatically.

- “AUTO.STBY” is set to “STBY ON” (page 27).
 - The Sleep Timer function is working (page 11).
-

Sound

There is no sound from one of the speakers.

- Connect a pair of headphones to the PHONES jack to verify that sound is output from the headphones. If only one channel is output from the headphones, the equipment may not be connected to the receiver correctly. Check that all the cords are fully inserted into the jacks on both the receiver and the equipment. If both channels are output from the headphones, the speaker may not be connected to the receiver correctly. Check the connection of the speaker which is not outputting any sound.
- Make sure you have connected to both the L and R jacks of an analog equipment, analog equipment requires both L and R jack connections. Use an audio cord (not supplied).

There is no sound from a specific equipment.

- Check that the equipment is connected correctly to the audio input jacks for that equipment.
 - Check that the cord(s) used for the connection is (are) fully inserted into the jacks on both the receiver and the equipment.
-

There is no sound, no matter which equipment is selected, or only a very low-level sound is heard.

- Check that all connecting cords are inserted to their input/output jacks for the respective jacks of the receiver, speakers and the equipment.
 - Check that both the receiver and all equipment are turned on.
 - Check that MASTER VOLUME is not set to “VOL MIN”.
 - Check that the SPEAKERS (OFF/A/B/A+B) is not set to “OFF”.
 - Check that headphones are not connected.
 - Press MUTING to cancel the muting function.
 - Try pressing the input button on the remote control or turning INPUT SELECTOR on the receiver to select the equipment of your choice (page 20).
 - The protective device on the receiver has been activated. Turn off the receiver, eliminate the short-circuit problem, and turn on the power again.
-

There is severe hum or noise.

- Check that the speakers and equipment are connected securely.
- Check that the connecting cords are away from a transformer or motor, and at least 3 meters (10 feet) away from a TV set or fluorescent light.
- Move your audio equipment away from the TV.
- The plugs and jacks are dirty. Wipe them with a cloth slightly moistened with alcohol.

The left and right sounds are unbalanced or reversed.

- Check that the speakers and equipment are connected correctly and securely.
- Adjust the speaker balance (page 27).

There is severe hum, interrupted noise or distortion from the equipment connected to the PORTABLE IN jack.

- Check that the equipment are connected securely.
- This is not a malfunction and will depend on the connected equipment.

Recording cannot be carried out.

- Check that the equipment are connected correctly.
- Select the source equipment using the input buttons (page 20).
- Copyright protection to prevent recording is contained in the sources. In this case, you may not be able to record from the sources.

Tuner

Tuner function is not selectable.

- Consult your nearest Sony dealer.

The FM reception is poor.

- Use a 75-ohm coaxial cable (not supplied) to connect the receiver to an outdoor FM antenna (aerial) as shown below.

Outdoor FM antenna (aerial)

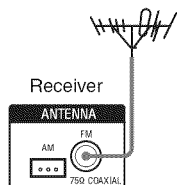

Radio stations cannot be tuned in.

- Check that the antennas (aerials) are connected securely. Adjust the antennas (aerials) and connect an external antenna (aerial), if necessary.
- The signal strength of the stations is too weak with automatic tuning. Use direct tuning.
- Make sure you set the tuning scale correctly (when tuning in AM stations with direct tuning) (page 23).
- No stations have been preset or the preset stations have been cleared (when tuning by scanning preset stations is used). Preset the stations (page 24).
- Press DISPLAY repeatedly so that the frequency appears on the display panel.

RDS does not work.*

- Make sure that you are tuned to an FM RDS station.
- Select a stronger FM station.
- The station you tuned to is not transmitting the RDS signal or the signal strength is weak.

The RDS information that you want does not appear.*

- The service may be temporarily out of order. Contact the radio station and find out whether they actually provide the service in question.

* Europe model only.

Remote control

The remote control does not function.

- Point the remote control at the remote control sensor on the receiver.
- Remove any obstacles in the path between the remote control and the receiver.
- Replace all the batteries in the remote control with new ones, if they are weak.
- Make sure you select the correct input on the remote control.

Error messages

If there is a malfunction, a message appears on the display panel. You can check the condition of the system by the message. If any problem persists, consult your nearest Sony dealer.

PROTECT

Irregular current is output to the speakers, or the receiver is covered and ventilation holes are blocked. The receiver will automatically turn off after a few seconds. Check the speaker connection and turn on the power again.

Clearing the memory

Reference section

To clear	See
All memorized settings	page 18

Specifications

AUDIO POWER SPECIFICATIONS

POWER OUTPUT AND TOTAL HARMONIC DISTORTION: (USA model only)

With 8 ohm loads, both channels driven, from 20 – 20,000 Hz; rated 90 watts per channel minimum RMS power, with no more than 0.09% total harmonic distortion from 250 milliwatts to rated output.

Amplifier section

USA, Canada and Europe models¹⁾

Minimum RMS Output Power (8 ohms, 20 Hz – 20 kHz, THD 0.09%)

90 W + 90 W

Stereo Mode Output Power (8 ohms, 1 kHz, THD 1%)

100 W + 100 W

¹⁾Measured under the following conditions:

Area	Power requirements
USA, Canada	120 V AC, 60 Hz
Europe	230 V AC, 50 Hz

Frequency response

Analog 10 Hz – 70 kHz
+0.5/-2 dB (with BASS = 0 dB, TREBLE = 0 dB)

Input

Analog (PORTABLE IN)
Sensitivity: 1 V/
50 kilohms
S/N²⁾: 96 dB (A, 500 mV³⁾)

Inputs

Analog (Except PORTABLE IN)
Sensitivity: 500 mV/
50 kilohms
S/N²⁾: 96 dB (A, 500 mV³⁾)

Outputs

Analog (AUDIO OUT)
Voltage: 500 mV/
10 kilohms

Tone

Gain levels ± 10 dB, 1 dB step

²⁾INPUT SHORT (with BASS = 0 dB, TREBLE = 0 dB).

³⁾Weighted network, input level.

FM tuner section

Tuning range 87.5 MHz – 108.0 MHz

Antenna (aerial) FM wire antenna (aerial)

Antenna (aerial) terminals
75 ohms, unbalanced

AM tuner section

Tuning range

Area	Tuning scale	
	10 kHz step	9 kHz step
USA, Canada	530 kHz – 1,710 kHz	531 kHz – 1,710 kHz
Europe	–	531 kHz – 1,602 kHz

Antenna (aerial) Loop antenna (aerial)

General

Power requirements

Area	Power requirements
USA, Canada	120 V AC, 60 Hz
Europe	230 V AC, 50/60 Hz

Power consumption 200 W

Power consumption (during standby mode)
0.3 W

Dimensions (w/h/d) (Approx.)
430 mm \times 132.5 mm \times
279 mm (17 in \times 5 1/4 in \times
11 in) including projecting
parts and controls

Mass (Approx.) 6.4 kg (14 lb 2 oz)

Design and specifications are subject to
change without notice.

Halogenated flame retardants are not used in the certain printed wiring boards.
--

Index

A

AUTO.STBY 27

B

BALANCE 27

BASS 19

Blu-ray Disc player
connecting 16

C

Cable TV tuner
connecting 16

CD player
connecting 14

Clear
memory 18
remote control 28

D

DVD player
connecting 16

DVD recorder
connecting 16

E

Error messages 32

I

Initial setup 18

M

MD deck
connecting 14

Muting 20

N

Naming
inputs 20
preset stations 25

R

RDS 26

Recording 22

Remote control 10

S

Satellite tuner
connecting 16

Sleep Timer 11

Speakers
connecting 14
installing 13

Super Audio CD player
connecting 14

T

Tape deck
connecting 14

TREBLE 19

Tuner
connecting 17

Tuning
automatically 23
directly 23
to preset stations 25

V

VCR
connecting 16

<http://www.sony.net/>

©2012 Sony Corporation Printed in Malaysia



* 4 2 9 4 4 7 2 1 1 * (1)