

Use & Care Guide

Convection Microwave Oven

Guía de Uso y Cuidado

Microondas de convección

Mode d'emploi et d'entretien

Four de Micro-onde à convection

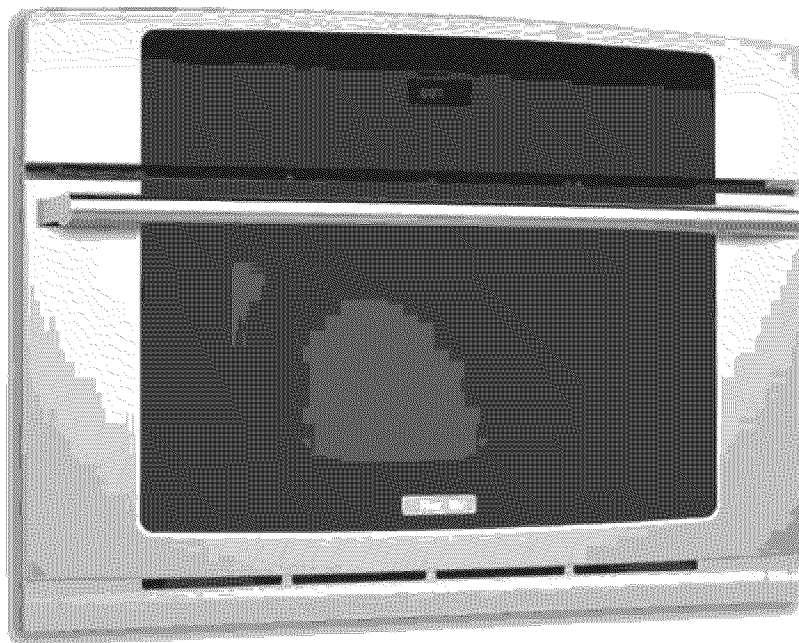

 **Electrolux**

PN316902930 TINSLB038MRR0

March 2014

Please read and save this guide

Thank you for choosing Electrolux, the new premium brand in home appliances. This Use & Care Guide is part of our commitment to customer satisfaction and product quality throughout the service life of your new appliance.

We view your purchase as the beginning of a relationship. To ensure our ability to continue serving you, please use this page to record important product information.

Keep a record for quick reference

Purchase date

Electrolux model number

Electrolux serial number (see page 10 for location)

NOTE

Registering your product with Electrolux enhances our ability to serve you. You can register online at www.electroluxusa.com or by dropping your Product Registration Card in the mail.

Questions?

For toll-free telephone support in the U.S. and Canada: **1-877-4ELECTROLUX (1-877-435-3287)**

For online support and Internet production information visit <http://www.electroluxusa.com>

Table of Contents

Finding Information	2
Safety	3-5
Precautions To Avoid Possible Exposure To Excessive Microwave Energy	4
Information You Need To Know	6-9
Part Names	10
Control Panel and Menu	11
Before Operating	12
Manual Operation	13
Auto Cook	14-18
Fast Recipe	19-25
Fast Features	26-32
Convenient Features	33-35
Cleaning and Care	36
Service Call Check	37
Specifications	38
Warranty Information	39

IMPORTANT SAFETY INSTRUCTIONS

WARNING

When using electrical appliances, basic safety precautions should be followed to reduce the risk of burns, electric shock, fire, injury to persons or exposure to excessive microwave energy:

- **READ ALL** instructions before using the appliance.
- **READ AND FOLLOW** the specific "PRECAUTIONS TO AVOID POSSIBLE EXPOSURE TO EXCESSIVE MICROWAVE ENERGY" on page 4.
- This appliance must be grounded. Connect only to properly grounded outlet. See "GROUNDING INSTRUCTIONS" found on page 5.
- Install or locate this appliance only in accordance with the provided installation instructions.
- Some products such as whole eggs and sealed containers - for example, closed jars - are able to explode and **SHOULD NOT** be **HEATED** in this oven.
- Use this appliance **ONLY** for its intended use as described in this manual. **DO NOT** use corrosive chemicals or vapors in this appliance. This type of oven is specifically designed to heat, cook or dry food. It is not designed for industrial or laboratory use.
- As with any appliance, **CLOSE SUPERVISION** is necessary when used by **CHILDREN** or **INFIRM PERSONS**.
- **DO NOT** operate this appliance if it has a damaged cord or plug, if it is not working properly or if it has been damaged or dropped.
- This appliance, including power cord, must be serviced **ONLY** by qualified service personnel. Contact nearest Electrolux Authorized Servicer for examination, repair or adjustment.
- **DO NOT** cover or block any vents or openings on the oven.
- **DO NOT** store or use this appliance outdoors. **DO NOT** use this product near water—for example, near a kitchen sink, in a wet basement, near a swimming pool, or similar locations.
- **DO NOT** immerse cord or plug in water.
- Keep cord **AWAY** from **HEATED** surfaces.

- **DO NOT** let cord hang over edge of table or counter.
- Review the door cleaning instructions on page 36.
- **DO NOT** mount over a sink.
- **DO NOT** store anything directly on top of the appliance surface when the appliance is in operation.

CAUTION

To reduce the risk of fire in the oven cavity:

- **DO NOT overcook food. Carefully attend to appliance when paper, plastic or other combustible materials are placed inside the oven to facilitate cooking.**
- Remove wire twist-ties from paper or plastic bags before placing bag in oven.
- **If materials inside the oven ignite, keep oven door closed, turn oven off and disconnect the power cord or shut off power at the fuse or circuit breaker panel.**
- **DO NOT** use the cavity for storage purposes. **DO NOT** leave paper products, cooking utensils or food in the cavity when not in use.

Liquids, such as water, coffee or tea are able to be overheated beyond the boiling point without appearing to be boiling. Visible bubbling or boiling when the container is removed from the Convection Microwave Oven is not always present. **THIS COULD RESULT IN VERY HOT LIQUIDS SUDDENLY BOILING OVER WHEN A SPOON OR OTHER UTENSIL IS INSERTED INTO THE LIQUID.**

To reduce the risk of injury to persons:

- **DO NOT** overheat the liquid.
- Stir the liquid both before and halfway through heating it.
- **DO NOT** use straight-sided containers with narrow necks. Use a wide-mouthed container.
- After heating, allow the container to stand in the Convection Microwave Oven at least for 20 seconds before removing the container.
- Use extreme care when inserting a spoon or other utensil into the container.

If the oven light fails, consult a Electrolux Authorized Servicer.

SAVE THESE INSTRUCTIONS

What you need to know about safety instructions

Warning and Important Instructions appearing in this guide are not meant to cover all possible conditions and situations that may occur. Common sense, caution and care must be exercised when installing, maintaining or operating a microwave.

ALWAYS contact your dealer, distributor, service agent or manufacturer about problems or conditions you do not understand.

Recognize Safety Symbols, Words, Labels



WARNING

WARNING — Hazards or unsafe practices which **COULD** result in severe personal injury or death.



CAUTION

CAUTION — Hazards or unsafe practices which **COULD** result in minor personal injury.

PRECAUTIONS TO AVOID POSSIBLE EXPOSURE TO EXCESSIVE MICROWAVE ENERGY

- **DO NOT** attempt to operate this oven with the door open since open-door operation can result in harmful exposure to microwave energy. It is important not to defeat or tamper with the safety interlocks.
- **DO NOT** place any object between the oven front face and the door or allow soil or cleaner residue to accumulate on sealing surfaces.
- **DO NOT** operate the oven if it is damaged. It is particularly important that the oven door close properly and that there is no damage to the: (1) door (bent), (2) hinges and latches (broken or loosened), (3) door seals and sealing surfaces.
- The oven should not be adjusted or repaired by anyone except properly qualified service personnel.

GROUNDING INSTRUCTIONS

This appliance must be grounded. This oven is equipped with a cord having a grounding wire with a grounding plug. It must be plugged into a wall receptacle that is properly installed and grounded in accordance with the National Electrical Code and local codes and ordinances. In the event of an electrical short circuit, grounding reduces risk of electric shock by providing an escape wire for the electric current.

WARNING

Improper use of the grounding plug can result in a risk of electric shock.

Electrical Requirements

The electrical requirements are a 120 volt 60 Hz, AC only, 15 amp. or more protected electrical supply. It is recommended that a separate circuit serving only this appliance be provided.

The oven is equipped with a 3-prong grounding plug. It must be plugged into a wall receptacle that is properly installed and grounded.

A short power-supply cord is provided to reduce risk of becoming entangled in or tripping over a longer cord. **DO NOT USE AN EXTENSION CORD.** If the power supply cord is too short, have a qualified electrician or serviceperson install an outlet near the appliance.

NOTES:

1. If you have any questions about the grounding or electrical instructions, consult a qualified electrician or serviceperson.
2. Neither Electrolux nor the dealer can accept any liability for damage to the oven or personal injury resulting from failure to observe the correct electrical connection procedures.

Federal Communications Commission Radio Frequency Interference Statement (U.S.A. Only)

This equipment generates and uses ISM frequency energy and if not installed and used properly, that is in strict accordance with the manufacturer's instructions, may cause interference to radio and television reception. It has been type tested and found to comply with limits for ISM Equipment pursuant to part 18 of FCC Rules, which are designed to provide reasonable protection against such interference in a residential installation.

However, there is no guarantee that interference will not occur in a particular installation. If this equipment does cause interference to radio or television reception, which can be determined by turning the equipment off and on, the user is encouraged to try to correct the interference by one or more of the following:

- Reorient the receiving antenna of the radio or television.
- Relocate the microwave oven with respect to the receiver.
- Move the microwave oven away from the receiver.
- Plug the microwave oven into a different outlet so that the microwave oven and the receiver are on different branch circuits.

The manufacturer is not responsible for any radio or television interference caused by **unauthorized modification** to this convection microwave oven. It is the responsibility of the user to correct such interference.

6 Information You Need To Know

About your oven

This Use and Care Guide is valuable: read it carefully and always save it for reference.

NEVER use the Convection Microwave Oven without the turntable and support nor turn the turntable over so that a large dish could be placed in the oven. The turntable will turn both clockwise and counterclockwise.

ALWAYS have food in the Convection Microwave Oven when it is on to absorb the microwave energy.

When using the Convection Microwave Oven at power levels below 100%, you may hear the magnetron cycling on and off. It is normal for the exterior of the oven to be warm to the touch when cooking or reheating.

Condensation is a normal part of microwave cooking. Room humidity and the moisture in food will influence the amount of moisture that condenses in the oven. Generally, covered foods will not cause as much condensation as uncovered ones. Ventilation openings must not be blocked.

The Convection Microwave Oven is for food preparation only. It should not be used to dry clothes or newspapers.

Your Convection Microwave Oven is rated 900 watts by using the IEC Test Procedure. In using recipes or package directions, check food a minute or two before the minimum time and add time accordingly.

About safety

- Check foods to see that they are cooked to the United States Department of Agriculture's recommended temperatures.

Temp	Food
160°F	For fresh pork, ground meat, boneless white poultry, fish, seafood, egg dishes and frozen prepared food.
165°F	For leftover, ready-to-reheat refrigerated, and deli and carry-out "fresh" food.
170°F	White meat of poultry.
180°F	Dark meat of poultry.

To test for doneness, insert a meat thermometer in a thick or dense area away from fat or bone. **NEVER** leave the thermometer in the food during cooking, unless it is approved for microwave use.

- **ALWAYS** use potholders to prevent burns when handling utensils that are in contact with hot food. Enough heat from the food can transfer through utensils to cause skin burns.

- Avoid steam burns by directing steam away from the face and hands. Slowly lift the farthest edge of a dish's covering and carefully open popcorn and oven cooking bags away from the face.
- Stay near the oven while it's in use and check cooking progress frequently so that there is no chance of overcooking food.
- **NEVER** use the cavity for storing cookbooks or other items.
- Select, store and handle food carefully to preserve its high quality and minimize the spread of foodborne bacteria.
- Keep waveguide cover clean. Food residue can cause arcing and/or fires.
- Use care when removing items from the oven so that the utensil, your clothes or accessories do not touch the safety door latches.
- Keep aluminum foil used for shielding at least 1 inch away from walls, ceiling and door.

About microwave cooking

- Arrange food carefully. Place thickest areas towards outside of dish.
- Watch cooking time. Cook for the shortest amount of time indicated and add more as needed. Food severely overcooked can smoke or ignite.
- Cover foods while cooking. Check recipe or cookbook for suggestions: paper towels, wax paper, microwave plastic wrap or a lid. Covers prevent spattering and help foods to cook evenly.
- Shield with small flat pieces of aluminum foil any thin areas of meat or poultry to prevent overcooking before dense, thick areas are cooked thoroughly.
- Stir foods from outside to center of dish once or twice during cooking, if possible.
- Turn foods over once during microwaving to speed cooking of such foods as chicken and hamburgers. Large items like roasts must be turned over at least once.
- Rearrange foods such as meatballs halfway through cooking both from top to bottom and from the center of the dish to the outside.
- Add standing time. Remove food from oven and stir, if possible. Cover for standing time which allows the food to finish cooking without overcooking.
- Check for doneness. Look for signs indicating that cooking temperatures have been reached.
- Doneness signs include:
 - Food steams throughout, not just at edge.
 - Center bottom of dish is very hot to the touch.
 - Poultry thigh joints move easily.
 - Meat and poultry show no pinkness.
 - Fish is opaque and flakes easily with a fork.

About food

Food	Do	Don't
Eggs, sausages, nuts, seeds, fruits & vegetables	<ul style="list-style-type: none"> • Puncture egg yolks before cooking to prevent "explosion". • Pierce skins of potatoes, apples, squash, hot dogs and sausages so that steam escapes. 	<ul style="list-style-type: none"> • Cook eggs in shells. • Reheat whole eggs. • Dry nuts or seeds in shells.
Popcorn	<ul style="list-style-type: none"> • Use specially bagged popcorn for the microwave. • Listen while popping corn for the popping to slow to 1 or 2 seconds or use special popcorn pad. 	<ul style="list-style-type: none"> • Pop popcorn in regular brown bags or glass bowls. • Exceed maximum time on popcorn package.
Baby food	<ul style="list-style-type: none"> • Transfer baby food to small dish and heat carefully, stirring often. Check temperature before serving. • Put nipples on bottles after heating and shake thoroughly. "Wrist" test before feeding. 	<ul style="list-style-type: none"> • Heat disposable bottles. • Heat bottles with nipples on. • Heat baby food in original jars.
General	<ul style="list-style-type: none"> • Cut baked goods with filling after heating to release steam and avoid burns. • Stir liquids briskly before and after heating to avoid "eruption". • Use deep bowl, when cooking liquids or cereals, to prevent boilovers. 	<ul style="list-style-type: none"> • Heat or cook in closed glass jars or air tight containers. • Can in the microwave as harmful bacteria may not be destroyed. • Deep fat fry. • Dry wood, gourds, herbs or wet papers.

8 Information You Need To Know

About utensils and coverings

It is not necessary to buy all new cookware. Many pieces already in your kitchen can be used successfully in your Convection Microwave Oven. The chart below will help you decide what utensils and coverings should be used in each mode.

Utensils and Coverings	Microwave Only	Convection, Broil	Fast Roast, Fast Bake
Aluminum foil	YES - Small flat pieces of aluminum foil placed smoothly on food can be used to shield areas from cooking or defrosting too quickly. Keep foil at least 1 inch from walls of oven.	YES - For shielding	YES - For shielding
Aluminum containers	NO	YES - Broil. No cover.	YES - Can be used if 3/4 filled with food. Keep 1 inch away from walls and do not cover with foil.
Browning dish	YES - Do not exceed recommended preheating time. Follow manufacturer's directions.	NO	NO
Glass ceramic (Pyroceram [®])	YES - Excellent	YES - Excellent	YES - Excellent
Glass, heat-resistant	YES - Excellent.	YES - Excellent	YES - Excellent
Glass, non-heat-resistant	NO	NO	NO
Lids, glass	YES	YES - Broil. No cover.	YES
Lids, metal	NO	YES - Broil. No cover.	NO
Metal cookware	NO	YES	YES - Do not use metal covering.
Metal, misc.: dishes with metallic trim, screws, bands, handles. Metal twist ties	NO	NO	NO
Oven cooking bags	YES - Good for large meats or foods that need tenderizing. DO NOT use metal twist ties.	YES - Broil. No cover.	YES - Do not use metal twist ties.
Paper plates	YES - For reheating	NO	NO
Paper towels	YES - To cover for reheating and cooking. Do not use recycled paper towels which may contain metal fillings.	NO	NO

Utensils and Coverings	Microwave Only	Convection, Broil	Fast Roast, Fast Bake
Paper, ovenable	YES	YES - For temperatures up to 400°F. Do not use for broiling.	YES - For temperatures up to 400°F.
Microwave-safe plastic containers	YES - Use for reheating and defrosting. Some microwave-safe plastics are not suitable for cooking foods with high fat and sugar content. Follow manufacturer's directions.	NO	NO
Plastic, Thermoset®	YES	YES - Are heat resistant up to 425°F. Do not use for broiling.	YES
Plastic wrap	YES - Use brands specially marked for microwave use. DO NOT allow plastic wrap to touch food. Vent so steam can escape.	NO	NO
Pottery, porcelain stoneware	YES - Check manufacturer's recommendation for being microwave safe.	YES	YES - Must be microwave safe AND ovenable.
Styrofoam	YES - For reheating	NO	NO
Wax paper	YES - Good covering for cooking and reheating.	NO	NO
Wicker, wood, straw	YES - May be used for short periods of time. Do not use with high fat or high sugar content foods. Could char.	NO	NO

DISH CHECK If you wish to check if a dish is safe for microwaving, place the empty dish in the oven and microwave on HIGH for 30 seconds. If the dish becomes very hot, DO NOT use it for microwaving.

ACCESSORIES There are many microwave accessories available for purchase. Evaluate carefully before you purchase so that they meet your needs. A microwave-safe thermometer will assist you in determining correct doneness and assure you that foods have been cooked to safe temperatures when using microwave-only cooking.

Electrolux is not responsible for any damage to the oven when accessories are used.

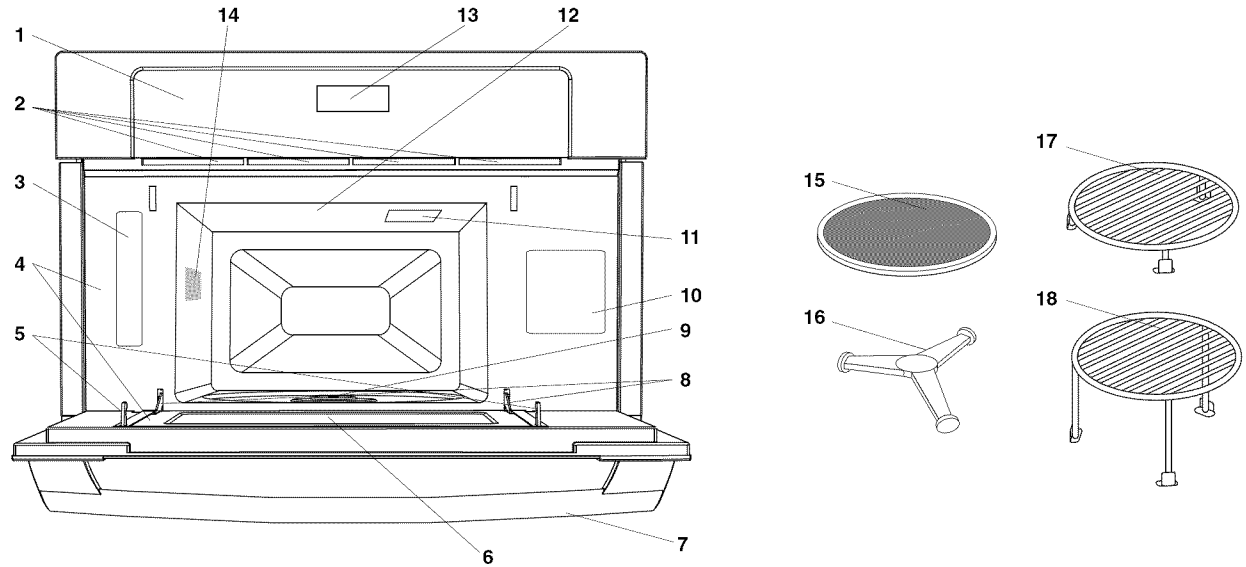

- 1 Control panel
- 2 Ventilation openings
- 3 Model / Serial label
- 4 Door seals and sealing surfaces
- 5 Safety door latches — The oven will not operate unless the door is securely closed.
- 6 Oven door with see-through window
- 7 Door handle
- 8 Door hinges
- 9 Turntable motor shaft
- 10 Menu label
- 11 Oven light — It will light when oven is operating or door is open.
- 12 Waveguide cover: DO NOT REMOVE.
- 13 Time display: 99 minutes, 99 seconds
- 14 Convection Fan
- 15 Removable turntable — Place the turntable on the turntable support securely. The turntable will rotate clockwise or counterclockwise. Only remove for cleaning.
- 16 Removable turntable support — Carefully place the turntable support in the center of the oven floor.
- 17 Low Rack
- 18 High Rack

Accessories

The accessories 17 and 18 are designed especially for use in the microwave oven for convection, fast bake, fast roast or broil cooking. **DO NOT USE FOR MICROWAVE ONLY COOKING.** Do not substitute similar types of racks for these specially designed ones.

High rack (Baking rack)—for convection and fast bake.

- This rack is placed on the turntable for two-level cooking, such as layer cakes, muffins, etc.

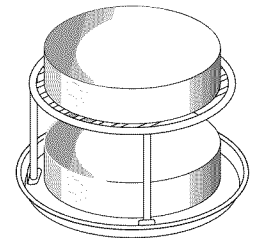

Low rack (Broiling rack)—for convection, broiling or fast roast.

- Place on the turntable and use for roasting or broiling to allow juices to drain away from food.

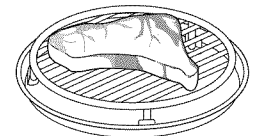

Words in the lower portion of the display will light to indicate what function is in progress.

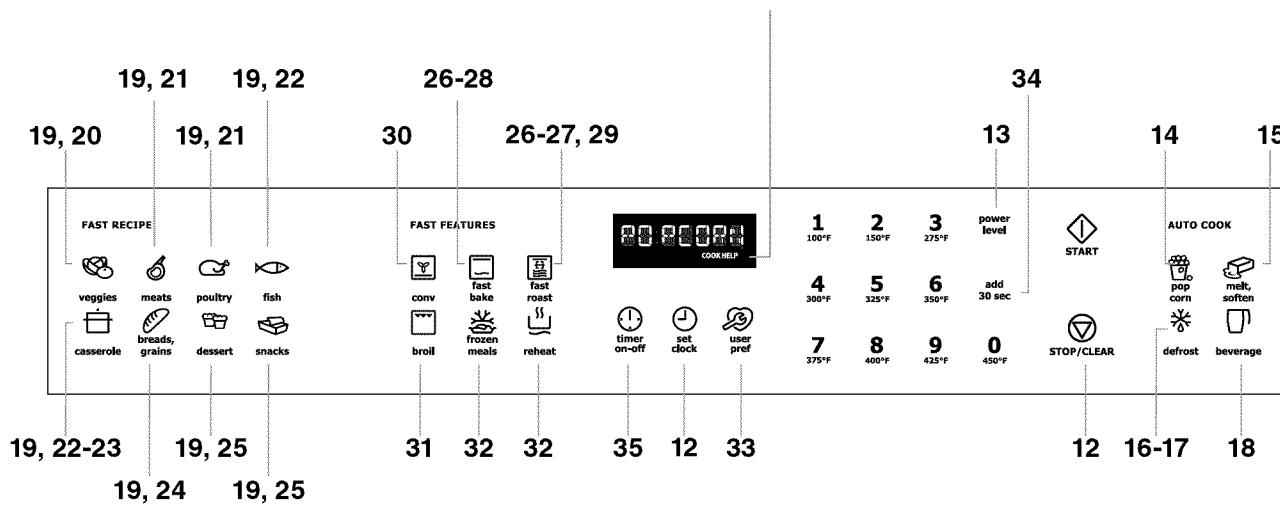

Number next to the control panel illustration indicates pages on which there are feature descriptions and usage information.

Refer to the menu label for quick references.



<p>Veggies</p> <ul style="list-style-type: none"> 1 Baked Potato 2 Fresh Veggies 3 French Fries 4 Frozen Veggies 	<p>Meats</p> <ul style="list-style-type: none"> 1 Beef Franks 2 Ground Meat 3 Hamburgers 4 Roast Pork 5 Steaks 	<p>Poultry</p> <ul style="list-style-type: none"> 1 Chicken Pieces 2 Chicken Breasts 3 Chicken Nuggets 4 Roast Chicken 5 Roast Turkey 6 Roast Turkey Breast
<p>Fish</p> <ul style="list-style-type: none"> 1 Fish/Seafood 2 Salmon Fillets 	<p>Dessert</p> <ul style="list-style-type: none"> 1 Bundt Cake 2 Cookies 	<p>Breads</p> <ul style="list-style-type: none"> 1 Crescent Rolls 2 Fresh Rolls/Muffins 3 Frozen Rolls/Muffins 4 Muffins Bake 5 Rice
<p>Casserole</p> <ul style="list-style-type: none"> 1 Pasta 2 Caramelized Onion, Green Bean, and Tomato Gratin 3 Spring Vegetable Lasagna 	<p>Quick Start</p> <ul style="list-style-type: none"> 1 1 minute 2 2 minutes 3 3 minutes 4 4 minutes 5 5 minutes 6 6 minutes 	<p>Snacks</p> <ul style="list-style-type: none"> 1 Frozen Kid's Meals 2 Hand Held Snack 3-4 oz 3 Hand Held Snack 5-6 oz 4 Pizza Frozen 5 Pizza Slice
<p>Defrost</p> <ul style="list-style-type: none"> 1 Ground Meat 2 Steaks/Chops/Fish 3 Chicken Pieces 4 Roast 5 Casserole 6 Soup 	<p>Melt, Soften</p> <ul style="list-style-type: none"> 1 Ice Cream 2 Cream Cheese 3 Butter 4 Chocolate 	

- Before operating your new Convection Microwave Oven make sure you read and understand this Use and Care Guide completely.
- Before the Convection Microwave Oven can be used, follow these procedures:
 1. Plug in the oven. Close the door. The oven display will show *ENJOY YOUR OVEN TOUCH CLEAR AND TOUCH CLOCK*.
 2. Touch the **STOP/CLEAR** pad. : will appear.
 3. Set clock. See below.

To set the clock

- Suppose you want to enter the correct time of day 12:30 (A.M. or P.M.).

Procedure

Step	Touch/Display
1. Touch set clock .	 ENTER TIME
2. Enter the correct time of day by touching the numbers in sequence. ①②③①	12:30 TOUCH CLOCK
3. Touch set clock again.	 12:30

This is a 12 hour clock. If you attempt to enter an incorrect clock time, *ERROR* will appear in the display. Touch the **STOP/CLEAR** pad and re-enter the time.

- If the electrical power supply to your Convection Microwave Oven should be interrupted, the display will intermittently show *ENJOY YOUR OVEN TOUCH CLEAR AND TOUCH CLOCK* after the power is reinstated. If this occurs during cooking, the program will be erased. The time of day will also be erased. Simply touch **STOP/CLEAR** pad and reset the clock for the correct time of day.

NOTE

Your Convection Microwave Oven can be programmed with the door open except for **START, popcorn and reheat**.

Stop/Clear

Touch the **STOP/CLEAR** to:

1. Erase if you make a mistake during programming.
2. Cancel timer.
3. Stop the oven temporarily during cooking.
4. Return the time of day to the display.
5. Cancel a program during cooking, touch twice.

Time cooking

Your Convection Microwave Oven can be programmed for 99 minutes 99 seconds (99.99). Always enter the seconds after the minutes, even if they are both zeros.

- Suppose you want to cook for 5 minutes at 100%.

Procedure

Step Touch/Display

1. Enter cooking time **500**.



2. Touch **START**.



To set power level

There are eleven preset power levels.

Using lower power levels increases the cooking time which is recommended for foods such as cheese, milk and long slow cooking of meats.

Touch power level pad once then touch	Approx. Percentage of power	Common words for power levels
Power level	100%	High
9	90%	
8	80%	
7	70%	Medium High
6	60%	
5	50%	Medium
4	40%	
3	30%	Med Low/ Defrost
2	20%	
1	10%	Low
0	0%	

- Suppose you want to defrost for 5 minutes at 30%.

Procedure

Step Touch/Display

1. Enter defrosting time **500**.



2. Touch **power level** and number **3**.

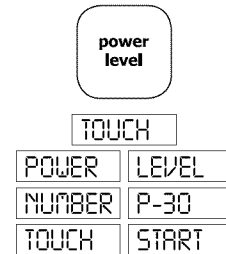

3. Touch **START**.



You can program up to 4 automatic cooking sequences. Follow directions on page 34.

The sensor is a semi-conductor device that detects the vapor (moisture and humidity) emitted from the food as it heats. The sensor adjusts the cooking times and power level for various foods and quantities.

USING SENSOR MODES:

1. After oven is plugged in, wait 2 minutes before using sensor modes.
2. Be sure the exterior of the cooking container and the interior of the oven are dry. Wipe off any moisture with a dry cloth or paper towel.
3. The oven works with foods at normal storage temperature. For example, popcorn would be at room temperature.
4. Any Sensor Modes selection can be programmed with More or less time adjustment. See page 34.
5. More or less food than the quantity listed in the chart should be cooked following the guidelines in any microwave cookbook.
6. During the first part of any sensor cooking or reheating, food name will appear on the display. Do not open the oven door or touch **STOP/CLEAR** during this part of the cycle. The measurement of vapor will be interrupted. If this occurs, an error message will appear. To continue cooking, touch the **STOP/CLEAR** pad and cook manually.

When the sensor detects the vapor emitted from the food, remainder of cooking time will appear. Door may be opened when remaining cooking time appears on the display. At this time, you may stir or season food, as desired.
7. Except for popcorn, if the sensor does not detect vapor properly when cooking other foods, **ERROR** will be displayed.
8. Check food for temperature after cooking. If additional time is needed, continue to cook manually.
9. Each food has a cooking hint. Touch **user pref** pad when the **HELP** indicator is lighted in the display.

COVERING FOODS:

Some foods cook better when covered. Use the cover recommended in the food charts.

1. Casserole lid.
2. Plastic wrap: Use plastic wrap recommended for microwave cooking. Cover dish loosely; allow approximately 1/2 inch to remain uncovered to allow steam to escape. Plastic wrap should not touch food.
3. Wax paper: Cover dish completely; fold excess wrap under dish to secure. If dish is wider than paper, overlap two pieces at least one inch to cover.

Be careful when removing any covering to allow steam to escape away from you.

Popcorn

- Suppose you want to pop a 3.5 oz. bag of popcorn.

Procedure

Step

Touch/Display



Touch **popcorn** pad once for regular. Touch **popcorn** pad twice for snack size.

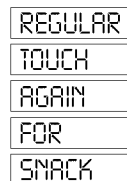

Regular	3.0 - 3.5 oz bag
Snack	1.5 - 1.75 oz bag

Use only popcorn packaged for the microwave. Do not try to pop unpopped kernels. This sensor works well with most brands of microwave popcorn. You may wish to try several and choose your favorite. Pop only one bag at a time. Unfold the bag and place in oven according to directions.

Melt, Soften

melt, soften automatically computes the correct heating time and microwave power level for softening and melting foods shown in the chart.

- Suppose you want to melt 1 square of chocolate.

Procedure

Step Touch/Display



1. Touch **melt, soften** pad.



2. Select desired food by touching number pad.
Ex: Touch number ④ for chocolate.



Procedure

Step Touch/Display

3. Touch number ② pad to select 1 square.

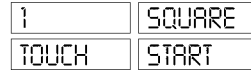

4. Touch **START** pad.



NOTE

1. To soften or melt other food or foods except the quantity listed in the Melt, Soften chart, use manual operation programming time and power level.
2. Auto Cook can be programmed with More or less time adjustment. See page 34.

Melt, Soften chart





Setting/Food	Amount	Procedure
Melt, Soften		DO NOT COVER.
1. Ice Cream	1 pint	After touching melt, soften , touch number 1 for 1 pint.
	1/2 gallon	After touching melt, soften , touch number 2 for 1/2 gallon.
2. Cream	3 oz	After touching melt, soften , touch number 1 for 3 oz.
Cheese	8 oz	After touching melt, soften , touch number 2 for 8 oz.
3. Butter		Use a Pyrex measuring cup. Cover with plastic wrap.
	2 tbsp	After touching melt, soften , touch number 1 for 2 tbsp.
	1/2 cup	After touching melt, soften , touch number 2 for 1/2 cup.
4. Chocolate	1 cup chips	After touching melt, soften , touch number 1 for 1 cup of chips.
	1 square	After touching melt, soften , touch number 2 for 1 square.

Defrost

defrost automatically defrosts all the foods found in the Defrost chart below.

- Suppose you want to defrost a 2.0 pound steak.

Procedure

Step	Touch/Display
1. Touch defrost pad.	 SEE LABEL SELECT FOOD NUMBER
2. Touch number ② for steak.	STEAK CHOP FISH USE MICRO WAVE SAFE DISH ENTER WEIGHT
3. Enter weight by touching the number pads ② and ①. Ex: 2.0 lb steak.	2.0 TOUCH START
4. Touch START pad. The oven will stop so the food can be checked.	 TURN FOOD OVER COVER EDGE
5. After the 1st stage, open the door. Turn steak over and shield any warm portions. Close the door. Touch START .	 CHECK FOOD COVER EDGE TOUCH START
6. After the 2nd stage, open the door. Shield any warm portions. Close the door. Touch START . After defrost cycle ends, let stand, covered.	 LET STAND COVERED

NOTE

1. To defrost other food or foods above or below the weights allowed on the Defrost chart, use time and 30% power. See Manual defrost on page 18.
2. Defrost can be programmed with More or less time adjustment. Touch the **power level** pad once or twice before touching **START** pad.
3. Touch **user pref** pad when the **HELP** indicator is lighted in the display for a helpful hint.
4. If you attempt to enter more or less than the amount as indicated in the Defrost chart, an error message will appear in the display.
5. Check foods when oven signals. After final stage, small sections may still be icy. Let stand to continue thawing. Do not defrost until all ice crystals are thawed.
6. Shielding prevents cooking from occurring before the center of the food is defrosted. Use small smooth strips of aluminum foil to cover edges and thinner sections of the food.

Defrost chart

Setting/Food	Amount	Procedure
1. Ground Meat	0.5 - 3.0 lb	Remove any thawed pieces after each stage. Let stand, covered, for 5 to 10 minutes.
2. Steaks/Chops/ Fish	0.5 - 4.0 lb	After each stage, rearrange and if there are warm or thawed portions, shield with small flat pieces of aluminum foil. Remove any meat or fish that is almost defrosted. Let stand, covered, for 10 to 20 minutes.
3. Chicken Pieces	0.5 - 3.0 lb	After each stage, rearrange pieces or remove portions should they become warm or thawed. Let stand, covered, for 10 to 20 minutes.
4. Roast	2.0 - 4.0 lb	Start defrosting with fat side down. After each stage, turn roast over and shield the warm portions with aluminum foil. Let stand, covered, for 30 to 60 minutes.
5. Casserole	2 - 6 cups	After audible signal, stir if possible. At end, stir well and let stand, covered, for 5 to 10 minutes.
6. Soup	1 - 6 cups	After audible signal, stir if possible. At end, stir well and let stand, covered, for 5 to 10 minutes.

Manual defrost

If the food that you wish to defrost is not listed on the Defrost chart or is above or below the limits in the "Amount" column on the Defrost chart, you need to defrost manually.

You can defrost any frozen food, either raw or previously cooked, by using Power level 3. Follow the exact 3-step procedure found under Time cooking on page 13. Estimate defrosting time and touch **3** for 30% when you select the **power level**.

For either raw or previously cooked frozen food the rule of thumb is approximately 5 minutes per pound. For example, defrost 5 minutes for 1 pound of frozen spaghetti sauce.

Always stop the oven periodically to remove or separate the portions that are defrosted. If food is not defrosted at the end of the estimated defrosting time, program the oven in 1 minute increments on power level 3 until totally defrosted.

When using plastic containers from the freezer, defrost only long enough to remove from the plastic in order to place in a microwave-safe dish.

Beverage

Beverage automatically heats beverage 0.5-2.0 cups. This setting is good for restoring a cool beverage to a better drinking temperature. Stir liquid briskly before and after heating to avoid "eruption". The beverage setting must be entered in 0.5 cup measurements.

- Suppose you want to heat 1 cup of water.

Procedure

Step Touch/Display

1. Touch **beverage** pad.



ENTER CUPS

2. Enter cups by touching the number pads **1** and **0**.

1.0 CUP
TOUCH START

3. Touch **START**.



NOTE

1. Beverage setting can be programmed with More or less time adjustment. See page 34.
2. The final cooking result will vary according to the food condition (e.g. initial temperature, shape, quality). Check food for temperature after cooking. If additional time is needed, continue to cook manually.

Fast Recipe has 8 functions: **veggies, meats*, poultry, fish, casserole, breads, grains, dessert*** and **snacks**. Each function will automatically compute the correct cooking time and microwave power level for foods shown in the following charts.

* Functions with preheat.

TO COOK WITH PREHEAT

- Suppose you want to broil 2 hamburgers.

Procedure

Step Touch/Display



1. Touch **meats**.

SEE	LABEL
SELECT	FOOD
NUMBER	

2. Select desired setting.
Ex: for hamburgers, touch number ③.

HAM	BURGER
USE	LOW
RACK	
HOW	MANY
TOUCH	NUMBER

3. Touch number ② pad to enter quantity.

NO FOOD	IN OVEN
FOR	MEDIUM
TOUCH	START
OR	FOR
DONE	NESS
OPTION	TOUCH
POWER	LEVEL

Follow information in display for cooking information. For well done or rare burgers, touch **power level** pad once for well done, touch power level twice for rare.

4. Touch **START**.



PREHEAT

After preheat cycle ends, the oven will stop and directions will be displayed. Follow the indicated message. Open the door and place hamburgers into oven. Close the door.

Procedure

Step Touch/Display

PREHEAT	OVER
PLACE	FOOD
IN OVEN	
TOUCH	START

5. Touch **START**.



TO COOK WITHOUT PREHEAT

- Suppose you want to reheat 2 pieces of pizza slice.

Procedure

Step Touch/Display



1. Touch **snacks** pad.

SEE	LABEL
SELECT	FOOD
NUMBER	

2. Touch number ⑤ for pizza slice.

PIZZA	SLICE
REHEAT	USE
MICRO	WAVE
SAFE	DISH
PLACE	ON
PAPER	TOWEL
ENTER	QUANTITY

3. Touch number ② for 2 pieces of pizza slice.

2	SLICES
TOUCH	START

4. Touch **START**.



 **NOTE**

1. Each functions can be programmed with More or less time adjustment (except for veggies: Fresh Veggies and French Fries). See page 34.
2. The final result will vary according to the food condition (e.g. initial temperature, shape, quality). Check food for temperature after heating. If additional time is needed, continue to heat manually.
3. If you attempt to enter more or less than the allowed amount as indicated in the chart, an error message will appear in the display.

 **CAUTION**

The oven cabinet, cavity, door, turntable, turntable support, racks and dishes will become hot. To **PREVENT BURNS**, use thick oven gloves when removing the food or turntable from the oven.

Veggies chart

* Microwave menu

Setting/Food	Amount	Procedure
1. Baked Potato*	1 - 8 med.	Pierce with fork in several places. Place on paper towel on turntable. After cooking, remove from oven and let stand wrapped in foil for 5 to 10 minutes.
2. Fresh Veggies*:		Wash and place in casserole. Add no water if vegetables have just been washed. Cover with lid for tender vegetables. Use plastic wrap for tender-crisp vegetables. Touch veggies pad and number 2 for Soft. After cooking, stir, if possible. Let stand, covered, for 2 to 5 minutes.
Soft		
Broccoli	0.25 - 2.0 lb	
Brussels sprouts	0.25 - 2.0 lb	
Cabbage	0.25 - 2.0 lb	
Cauliflower (flowerets)	0.25 - 2.0 lb	
Cauliflower (whole)	1 medium	
Spinach	0.25 - 1.0 lb	
Zucchini	0.25 - 2.0 lb	
Baked apples	2 - 4 medium	
Hard		Place in casserole. Add 1-4 tbsp. water. Cover with lid for tender vegetables. Use plastic wrap cover for tender-crisp vegetables. Touch veggies pad, number 2 and power level for Hard. After cooking, stir, if possible. Let stand, covered, for 2 to 5 minutes.
Carrots, sliced	0.25 - 2.0 lb	
Corn on cob	2 - 4 pcs.	
Green beans	0.25 - 2.0 lb	
Winter squash		
- diced	0.25 - 2.0 lb	
- halves	1 - 2	
3. French Fries	3 - 24 oz 1 or 2 pizza pans For more than 12 oz use 2 pans	Use frozen prepared French fries. No preheat is required for the French fries baking procedure. Place French fries on pizza pan. For shoestring potatoes, touch power level pad twice to enter less time before touching START pad.
4. Frozen Veggies*	0.25 - 1.5 lb	Add no water. Cover with lid or plastic wrap. After cooking, stir and let stand, covered, for 3 minutes.

Meats chart

* Microwave menu ** With preheat

Setting/Food	Amount	Procedure
1. Beef Franks*	1 - 6	Place hot dog in bun. Wrap each with paper towel or napkin. Touch meats pad and the number 1. Enter the quantity of hot dogs and touch START .
2. Ground Meat*	0.25 - 2.0 lb	Use this setting to cook ground beef or turkey as patties or in a casserole to be added to other ingredients. Place patties on a microwave-safe rack and cover with wax paper. Place ground meat in a casserole and cover with wax paper or plastic wrap. When oven stops, turn patties over or stir meat in casserole to break up large pieces. Re-cover and touch START . After cooking, let stand, covered, for 2 to 3 minutes.
3. Hamburgers**	1 - 8 pieces 0.25 lb each	Use this setting to broil hamburger patties. Place on low rack.
4. Pork	2 - 3.5 lb	Boneless pork loin is recommended because it cooks evenly. Place on a low rack. After cooking, remove from oven, cover with foil and allow to stand 5-10 minutes. Internal temperature should be 160°F.
5. Steaks*	0.5 - 2 lb	Use this setting to broil steaks from 3/4" to 1" thick. Individual boneless steaks broil evenly. Place steak on low rack. For well done, touch power level once; for rare, touch power level twice.

Poultry chart

* Microwave menu ** With preheat

Setting/Food	Amount	Procedure
1. Chicken** Pieces	0.5 - 3.5 lb	Arrange pieces on low rack. After cooking, let stand, 3-5 minutes. Dark meat should be 180°F, and white meat should be 170°F.
2. Chicken Breast*	0.5 - 2.0 lb	Cover with vented plastic wrap. When oven stops, turn over. Shield with small, flat pieces of aluminum foil any areas that are cooking too rapidly. Re-cover and press START . After cooking, let stand, covered 3 to 5 minutes. Chicken should be 160°F.
3. Chicken Nuggets*	0.3 - 1.0 lb	Place frozen chicken nuggets on a flat plate allowing space between each, cover foods with paper towel. Press poultry pad and the number 3. Enter weight and press START . After cooking, open door, rearrange, close door and press START . Let stand, covered, for 1 to 3 minutes.
4. Roast Chicken	3.0 - 6.0 lb	After the cycle ends, cover with foil and let stand for 5-10 minutes.
5. Roast Turkey	6.5 - 16 lb	Season, as desired. Place on low rack. After the cycle ends, cover with foil and let stand 10 minutes. Internal temperature of white meat should be 170°F and of dark meat, 180°F.
6. Roast Turkey breast	3 - 6 lb	Season, as desired. Place on low rack. After the cycle ends, cover with foil and let stand 10 minutes. Internal temperature of white meat should be 170°F.

Fish chart

* Microwave menu

Setting/Food	Amount	Procedure
1. Fish/Seafood*	0.25 - 2.0 lb	Arrange in ring around shallow glass dish (roll fillet with edges underneath). Cover with plastic wrap. After cooking, let stand, covered, 3 minutes.
2. Salmon Fillet	0.5 - 2.0 lb	Place salmon on low rack. No preheat is required.

Casserole chart

* Microwave menu

Setting/Food	Amount	Procedure
1. Pasta*	1 - 6 cups	Use this pad to reheat refrigerated canned or homemade pasta with sauce. For room temperature pastas, use Less option. Pasta without sauce double the quantity per setting. For example, measure 2 cups of cooked noodles and program for 1 cup. Cover with lid or plastic wrap. Press reheat pasta to select number of cups. After cooking, let stand, covered, 2 to 3 minutes.
2. Caramelized Onion, Green Bean, and Tomato Gratin	11 x 17 - inch dish	Follow recipe instructions.
3. Spring Vegetable Lasagna	8 - inch square dish	Follow recipe instructions.

CARAMELIZED ONION, GREEN BEAN, AND TOMATO GRATIN

Yield: 6 servings

5 cups cut fresh green beans (about 1 pound)	¼ teaspoon black pepper
Cooking spray	2 tablespoons balsamic vinegar
3 cups thinly sliced onion	1 teaspoon dried basil
6 garlic cloves, minced	½ teaspoon dried oregano
2 teaspoons sugar	4 Roma tomatoes, sliced
½ teaspoon salt	¼ cup grated fresh Parmesan cheese

Cook beans in boiling water 3 minutes. Drain and rinse with cold water; set aside.

Heat a skillet coated with cooking spray over medium-high heat. Add onion and next 4 ingredients; sauté 8 minutes or until lightly browned, stirring frequently. Stir in vinegar, basil, and oregano; cook 2 minutes. Remove from heat.

Arrange beans in an 11 x 7 inch baking dish coated with cooking spray. Top with onion mixture. Arrange tomato slices on top of onion mixture, and sprinkle with cheese. Convection bake at 375°F for 25 minutes or until cheese is lightly browned.

SPRING VEGETABLE LASAGNA

Yield: 6 servings

Cooking spray	2 tablespoons all-purpose flour
8 cups fresh baby spinach	1 ½ cups milk
2 cups thinly sliced yellow squash	¼ cup grated fresh Parmesan cheese
1 ½ cups chopped onion	1 cup ricotta cheese
1 cup julienned red pepper strips	1 cup cottage cheese
1 cup shredded carrot	1 cup grated Asiago cheese, divided
½ teaspoon salt	½ teaspoon dried oregano
1 tablespoon butter	4 no-boil lasagna noodles
4 garlic cloves, crushed	2 tablespoons grated fresh Parmesan cheese

Heat a Dutch oven coated with cooking spray over medium high heat. Add spinach, squash, onion, pepper, carrot, and salt; sauté 10 minutes or until tender.

Melt butter in a saucepan over medium heat. Add garlic; sauté 30 seconds. Add flour; cook 1 minute, stirring constantly with a whisk. Gradually add milk, stirring with a whisk until blended. Cook until thick. Remove from heat; add ¼ cup Parmesan cheese and stir until cheese melts.

Combine ricotta, cottage cheese, ½ cup Asiago, and oregano in a bowl.

Spread 2 tablespoons milk mixture in bottom of an 8-inch square baking dish coated with cooking spray. Arrange 2 noodles over milk mixture; top with half of ricotta mixture, half of vegetable mixture, and half of milk mixture. Repeat layers. Sprinkle with ½ cup Asiago and 2 tablespoons Parmesan. Convection bake at 350°F for 35 to 40 minutes or until cheese is lightly browned. Let stand 15 minutes before serving.

Breads, Grains chart

* Microwave menu

Setting/Food	Amount	Rack	Procedure
1. Crescent Rolls	1 or 2 pizza pan	1 pizza pan Low rack 2 pizza pans High rack and turntable	Ideal for refrigerated crescent rolls. Prepare according to package and place on a 12-inch pizza pan. No preheat is required.
2. Fresh Rolls/ Muffins*	1 - 10		Use this pad to warm rolls, muffins, biscuits, bagels etc. Large items should be considered as 2 or 3 regular size. Arrange on plate; cover with paper towel. For refrigerated rolls or muffins, it may be necessary to double the entered amount to ensure the proper serving temperature. For example, enter quantity of 2 for 1 refrigerated muffin. Touch number pad(s) to enter quantity and press START .
3. Frozen Rolls/ Muffins*	1 - 10		Use this pad to warm frozen rolls, muffins, biscuits, bagels, etc. Large items should be considered as 2 or 3 regular size. Arrange on plate, cover with paper towel. Touch number pad(s) to enter quantity and press START .
4. Muffins	6 - 12 cups 1 or 2 muffin pans	1 pan No rack 2 pans High	Ideal for packaged muffin mix or your own recipe for 6-12 medium size muffins. Prepare according to package or recipe directions and place in muffin pan. After the preheat is over, place pan in oven.
5. Rice*	0.5 - 2.0 cups		Place rice into a deep casserole dish and add double quantity of water. Cover with lid or plastic wrap. After cooking, stir, cover and let stand 3 to 5 minutes or until all liquid has been absorbed.

Rice	Water	Size of casserole dish
.5 cup	1 cup	1.5 quart
1 cup	2 cups	2 quart
1.5 cups	3 cups	2.5 or 3 quart
2 cups	4 cups	3 quart or larger

Dessert chart

** With preheat

Setting/Food	Amount	Rack	Procedure
1. Bundt cake	1 cake	No rack	Ideal for packaged cake mix or your own recipe. Prepare according to package or recipe directions and place in a greased and floured bundt pan. Place pan in oven. Cool before frosting and serving.
2. Cookies**	1 or 2 pizza pan	1 pizza pan No rack 2 pizza pans High	Ideal for refrigerated cookie dough. Prepare according to package or recipe directions and place on a greased and floured 12-inch pizza pan. Cookies should be approximately 1/3-inch thick and 2-inches in diameter for best results. After the preheat is over, place pan in oven. Cool before serving.

Snacks chart

* Microwave menu

Setting/Food	Amount	Procedure
1. Frozen Kid's Meal*	6 - 8 oz	Use this pad for frozen, convenience foods. It will give satisfactory results for most brands. You may wish to try several and choose your favorite. Remove package from outer wrapping and follow package directions for covering. Touch snacks pad and the number 1 . Touch START . After cooking, let stand, covered for 1 to 3 minutes.
2. Hand-held Snacks*	3 - 4 oz	Use for frozen French fries, cheese sticks, appetizers etc. Remove from outer package. Follow package directions for how to wrap or cover. Be careful when removing from the oven as snack may be very hot. Touch snacks pad and the number 2 . Touch START .
3. Hand-held Snacks*	5 - 6 oz	Use for frozen French fries, cheese sticks, appetizers etc. Remove from outer package. Follow package directions for how to wrap or cover. Be careful when removing from the oven as snack may be very hot. Touch snacks pad and the number 3 . Touch START .
4. Pizza Frozen*	1 (6 - 8 oz)	Use for frozen microwave pizza. Remove from package and unwrap. Follow package directions for use of package and/or silver crisping disc. Touch snacks pad and the number 4 . Touch START .
5. Pizza slice*	1 - 6 slices (6 - 8 oz)	Use this setting to reheat refrigerated leftover pizza. 1 slice is approximately 1/8th of a 12-inch pizza or 1/12th of a 16-inch pizza. If possible, place on paper towel on a microwave-safe rack. Touch snacks pad, the number 5 and enter number of slices. Touch START .

Fast Bake, Fast Roast

This oven has two pre-programmed settings that make it easy to cook with both convection heat and microwave automatically (Mix).

Setting	Oven temperature	Microwave power
Fast Roast	300°F	30%
Fast Bake	325°F	10%

With the exception of those foods that cook best by convection heating alone, most foods are well suited to mix cooking using either **fast bake** or **fast roast**.

The marriage of these two cooking methods produces juicy meats, moist and tender cakes and fine textured breads, all with just the right amount of browning and crispness.

The temperatures can be changed; however, the microwave power cannot.

The oven temperature can be changed from 100°F to 450°F. To change the temperature, first touch **fast roast** or **fast bake** then touch the same pad again. When the display says *SELECT TEMP*, touch desired temperature pad. Ex: **fast roast**, **fast roast** pad, **7**. The mix temperature will change to 375°F automatically.

- Suppose you want to bake a cake for 25 minutes

on fast bake.

Procedure

- | Step | Touch/Display | | | | | | |
|--|--|------|-------|---------|------|-------|-------------|
| 1. Touch fast bake . |  | | | | | | |
| 2. Enter cooking time by touching the number pads 2 5 0 0. | <table border="1"> <tr> <td>350F</td> <td>ENTER</td> </tr> <tr> <td>COOKING</td> <td>TIME</td> </tr> </table>
<table border="1"> <tr> <td>25:00</td> </tr> <tr> <td>TOUCH START</td> </tr> </table> | 350F | ENTER | COOKING | TIME | 25:00 | TOUCH START |
| 350F | ENTER | | | | | | |
| COOKING | TIME | | | | | | |
| 25:00 | | | | | | | |
| TOUCH START | | | | | | | |
| 3. Touch START . |  | | | | | | |

NOTE

To cook mix setting, use the procedure above, touch either **fast bake** or **fast roast**.

Helpful hints for convection fast bake and fast roast cooking

Your Convection Microwave Oven can cook any food perfectly because of the number of ways it can cook: microwave only, fast bake, fast roast or convection only. This Use & Care Guide tells you how to program the oven.

The oven cannot be used without the turntable in place. Never restrict the movement of the turntable.

CONVECTION COOKING:

1. When preheating, the turntable can be left in or removed. When using the high rack for 2 shelf baking in a preheated oven, it is easier to remove the turntable for preheat.

Place high rack on turntable along with foods. When preheat is over, open oven door and quickly place turntable, high rack and foods to be baked inside.

2. Do not cover turntable, low rack or high rack with aluminum foil. It interferes with air flow that cooks food.
3. Round pizza pans are excellent cooking utensils for many convection-only items. Choose pans that do not have extended handles.
4. Using a preheated low rack can give a grilled appearance to steaks, hot dogs etc.

FAST BAKE, FAST ROAST COOKING:

1. Meats are best when roasted directly on the low rack. A dish can be placed below the meat if gravy is to be made from the drippings.
2. Less tender cuts of meat can be roasted and tenderized using oven cooking bags.
3. When baking, check for doneness after time has elapsed. If not completely done, let stand in oven a few minutes to complete cooking.

NOTE

1. During fast baking some metal baking utensils may cause arcing when they come in contact with the turntable, oven walls or accessory racks. Arcing is a discharge of electricity that occurs when microwaves come in contact with metal.
2. If arcing occurs, place a heat resistant dish (Pyrex® pie plate, glass pizza dish or dinner plate) between the pan and the turntable or rack. If arcing occurs with other metal baking utensils, discontinue their use for **fast bake** or **fast roast** cooking.

Fast Bake chart

Item	Procedure
Cakes: Your recipe or mix	
Tube or Bundt Cakes	Fast Bake, 350°F for three-fourths the recommended time.*
Angel Food	Fast Bake, 350°F for 25 to 30 minutes.
Loaf Cakes or Quick Breads	Fast Bake, 350°F for three-fourths the recommended time.
Bar Cookies: Your recipe or mix	Fast Bake, 350°F for three-fourths the recommended time or until wooden pick inserted in center comes out clean.
Pies	
Single Crust: Baked before filling, your recipe, mix or frozen prepared	Prick crust with fork. Preheat oven to 425°F. Bake on broiling trivet 8 to 10 minutes or until lightly browned. Let cool before filling.
Double Crust	Preheat oven to 400°F. Bake on broiling trivet 25 to 35 minutes on Fast Roast, 400°F.
Crumb Top	Preheat oven to 400°F. Bake on broiling trivet 20 to 25 minutes on Fast Roast, 400°F.
Custard Pie	Prebake, following directions for single crust; cool. Fill with desired uncooked custard. Bake on pizza pan on broiling trivet 35 minutes on Fast Bake, 325°F. If custard is not set, let stand in oven a few minutes.
Pecan Pie	Bake on broiling trivet 25 to 30 minutes on Fast Bake, 350°F.
Frozen Prepared Fruit Pies	Place on pizza pan on broiling trivet and bake 30 to 40 minutes using Fast Roast, 375°F.
Frozen Prepared Custard Pies	Preheat oven to package temperature. Place on broiling trivet and bake three-fourths of package time using Fast Bake, and package temperature. If not set, let stand in oven a few minutes.
Breads	
Loaf: Your recipe or frozen, thawed and proofed	Fast Bake, 350°F. 1 to 2 loaves, 25 to 30 minutes.
Braid or other shape	Remove metal turntable from oven. Place bread directly on metal turntable. Fast Bake, 350°F for three-fourths the conventional time.

* If arcing occurs while using a fluted tube pan, place a heat-resistant dish (Pyrex® pie plate, glass pizza tray or dinner plate) between the pan and the turntable.

Fast Roast chart

Cut		Time
Beef		
Roasts (tender cuts)	Rare	12-14 min. / lb at Fast Roast, 325°F
	Medium	13-15 min. / lb at Fast Roast, 325°F
	Well Done	14-17 min. / lb at Fast Roast, 325°F
Roasts (less tender cuts)	Rare	12-15 min. / lb at Fast Roast, 325°F
	Medium	13-17 min. / lb at Fast Roast, 325°F
	Well Done	14-18 min. / lb at Fast Roast, 325°F
Veal		
Roasts (boned, rolled, tied)	Well Done	14-16 min. / lb at Fast Roast, 325°F
Breast (stuffed)	Well Done	11-13 min. / lb at Fast Roast, 325°F
Pork		
Roasts (boned, rolled, tied or bone-in)	Well Done	14-16 min. / lb at Fast Roast, 325°F
Smoked Ham		7-9 min. / lb at Fast Roast, 325°F
Lamb		
Leg, Roasts	Rare	10-12 min. / lb at Fast Roast, 325°F
	Medium	12-14 min. / lb at Fast Roast, 325°F
	Well Done	14-16 min. / lb at Fast Roast, 325°F
Poultry		
Chicken, whole		9-13 min. / lb at Fast Roast, 325°F
Chicken, pieces		10-12 min. / lb at Fast Roast, 375°F
Turkey (unstuffed)		7-10 min. / lb at Fast Roast, 325°F
Turkey Breast		13-16 min. / lb at Fast Roast, 325°F



Convection (Conv)

During convection heating, hot air is circulated throughout the oven cavity to brown and crisp foods quickly and evenly. This oven can be programmed for ten different convection cooking temperatures for up to 99 minutes, 99 seconds.

The oven should not be used without the turntable in place, and it should never be restricted so that it cannot rotate. You may remove the turntable when preheating the oven and when preparing food to be cooked directly on the turntable.

- Suppose you want to cook at 350°F for 20 minutes.

Procedure

Step	Touch/Display
1. Touch conv once.*	 SELECT TEMP
2. Select temperature by touching number pad 6.	 350F ENTER COOKING TIME
3. Enter cooking time by touching the number pads 2000.	20:00 TOUCH START
4. Touch START .	



* If Conv. was touched twice, preheat will be selected.

TO PREHEAT AND COOK WITH CONVECTION

Your oven can be programmed to combine preheating and convection cooking operations. You can preheat to the same temperature as the convection temperature or change to a higher or lower temperature.

- Suppose you want to preheat to 350°F, and then cook 20 minutes at 350°F convection.

Procedure

Step	Touch/Display
1. Touch conv twice.	 SELECT PREHEAT TEMP
2. Select preheat temperature by touching number pad 6.	 350F ENTER COOKING TIME
3. Enter cooking time by touching the number pads 2000.	20:00 TOUCH START

When the oven reaches the programmed temperature, a signal will sound 1 time. The oven will stop, and directions will be displayed. Follow the indicated message.

4. Open the door. Place food in the oven. Close the door. Touch START .	PREHEAT OVER PLACE FOOD IN OVEN 
--	--

If the oven door is not opened, the oven will automatically hold at the preheat temperature for 30 minutes. After this time has elapsed, an audible signal will sound, and the oven will turn off.

CAUTION

The oven cabinet, cavity, door, turntable, turntable support, racks and dishes will become hot. To PREVENT BURNS, use thick oven gloves when removing the food or turntable from the oven.

Broil

Preheating is automatic when the **broil** setting is used. Only actual cooking time is entered; the oven signals when it is preheated to 450°F. Oven temperature cannot be changed. Use Broil setting for steaks, chops, chicken pieces and many other foods.

- Suppose you want to broil a steak for 15 minutes.

Procedure

Step	Touch/Display
------	---------------

1. Touch **broil**.



450F	ENTER
COOKING	TIME

2. Enter cooking time by touching the number pads **1500**.

15:00
TOUCH START

3. Touch **START**.



PREHEAT

When the oven reaches the programmed temperature, a signal will sound 1 time.

4. Open the door. Place food in the oven. Close the door. Touch **START**.

PREHEAT	OVER
PLACE	FOOD
IN OVEN	



If the oven door is not opened, the oven will automatically hold at the preheat temperature for 30 minutes. After this time has elapsed, an audible signal will sound, and the oven will turn off.

CAUTION

The oven cabinet, cavity, door, turntable, turntable support, racks and dishes will become hot. To **PREVENT BURNS**, use thick oven gloves when removing the food or turntable from the oven.

NOTE

1. Preheating for broil may take from 7 to 10 minutes depending on temperature of room and available power.
2. Although time is usually set for the maximum broiling time, always check food at the minimum time recommended in the chart of cookbook. This will eliminate the need to completely reprogram the oven if additional cooking time is needed. Simply close the oven door and touch **START** to continue.
3. Should you need more broiling time, reprogram within 1 minute of the end to eliminate preheating.

Frozen Meals

Frozen Meals automatically heats foods 6-17 oz. Use this pad for frozen, convenience foods. It will give satisfactory results for most brands. You may wish to try several and choose your favorite. Remove package from outer wrapping and follow package directions for covering. After cooking, let stand, covered for 1 to 3 minutes.

- Suppose you want to heat a 9 oz frozen meal.

Procedure

Step Touch/Display



1. Touch **frozen meals**.

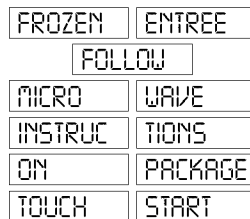

2. Touch **START**.



When the sensor detects the vapor emitted from the food, remainder of cooking time will appear.

NOTE

Frozen Meals setting can be programmed with More or less time adjustment. See page 34.

Reheat

Reheat automatically heats foods 4-36 oz. Place in dish or casserole slightly larger than amount to be reheated. Flatten, if possible. Cover with lid, plastic wrap or wax paper. Use covers such as plastic wrap or lids with larger quantities of more dense foods such as stews. After reheating, stir well, if possible. Re-cover and allow to stand 2 to 3 minutes. Foods should be very hot. If not, continue to heat with variable power and time.

- Suppose you want to reheat a bowl of soup.

Procedure

Step Touch/Display



- Touch **reheat**.



Microwave starts automatically. When the sensor detects the vapor emitted from the food, remainder of cooking time will appear.

NOTE

1. Use microwave-safe dish.
2. Reheat setting can be programmed with More or less time adjustment. See page 34.

User pref

user pref provides 4 features that make using your oven easy because specific instructions are provided in the interactive display.

1. CHILD LOCK

The Child Lock prevents unwanted oven operation such as by small children. The oven can be set so that the control panel is deactivated or locked. To set, touch **user pref**, the number **1** and then touch the **START** pad. Should a pad be touched, **LOCK ON** will appear in the display.

To cancel, touch **user pref** and **START** pad.

2. AUDIBLE SIGNAL ELIMINATION











If you wish to have the oven operate with no audible signals, touch **user pref**, the number **2** and **STOP/CLEAR**.



To cancel and restore the audible signal, touch **user pref**, the number **2** and **START**.

3. AUTO START

If you wish to program your oven to begin cooking automatically at a designated time of day, follow this procedure:

- Suppose you want to start cooking a stew for 20 minutes on 50% at 4:30. Before setting, check to make sure the clock is showing the correct time of day.

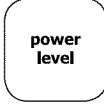
Procedure	
Step	Touch
1. Touch user pref pad.	
2. Touch number 3 .	
3. Enter the start time.	  
4. Touch set clock pad.	
5. Enter cooking time.	   

Procedure	
Step	Touch
6. Touch power level pad.	
7. Touch number 5 for 50% power.	
8. Touch START pad.	

NOTE

- Auto Start can be used for manual cooking if clock is set.
- If the oven door is opened after programming Auto Start, it is necessary to touch the **START** pad for Auto Start time to appear in the readout so that the oven will automatically begin programmed cooking at the chosen Auto Start time.
- Be sure to choose foods that can be left in the oven safely until the Auto Start time. Acorn or butternut squash are often a good choice.

4. LANGUAGE SELECTION

The oven comes set for English and U.S. Customary Unit-pounds. To change, touch **user pref** and the number **4**. Continue to touch the number **4** until your choice is selected from the table below. Then, touch **START** pad.

Number	Language	Standard of weight
Once	English	LB
Twice	English	KG
3 times	Spanish	LB
4 times	Spanish	KG
5 times	French	LB
6 times	French	KG













34 Convenient Features

Multiple sequence cooking

Your oven can be programmed for up to 4 automatic cooking sequences, switching from one power level setting to another automatically.

Sometimes cooking directions tell you to start on one power level and then change to a different power level. Your oven can do this automatically.

- Suppose you want to cook a roast 10 minutes at 30% and then continue to fast roast for 20 minutes.

Procedure	
Step	Touch
1. Touch power level pad and number pad 3 for 30% power.	 
2. Enter cooking time by touching the number pads.	   
3. Touch fast roast .	
4. Enter cooking time by touching the number pads.	   
5. Touch START pad.	

NOTE

1. If **power level** is touched once, *HIGH* will be displayed.
2. If you wish to know power level, simply touch **power level**. As long as your finger is touching **power level**, the power will be displayed.

More or less time adjustment

Should you discover that you like any of the Auto Cook, Fast Recipe*, Frozen Meals or Reheat slightly more done, touch the **power level** pad once after touching your choice of pads or before touching **START** pad. The display will show *MORE* or *WELL DONE*.

Should you discover that you like any of the the Auto Cook, Fast Recipe*, Frozen Meals or Reheat slightly less done, touch the **power level** pad twice after touching your choice of pads or before touching **START** pad. The display will show *LESS* or *RARE*.

* Except for veggies: Fresh Veggies and French Fries.

Quick Start

quick start is a short-cut method to set time for 1-6 minutes at power level 100.

- Suppose you want to heat a cup of soup for two minutes.

Procedure	
Step	Touch
Touch number 2 .	

The oven will start immediately and will signal then turn off automatically when finished.

Add 30 Seconds



add 30 seconds provides a convenient way to extend cooking time by 30 seconds while the oven timer is counting down. It will add 30 seconds to the time shown each time the pad is touched.

This pad may also be used as a quick start for 30 seconds of cooking. No need to touch **START**, the oven will start immediately.

Timer on-off

- Suppose you want to time a 3-minute long distance phone call.

Procedure

Step	Touch
1. Touch timer on-off .	
2. Enter time.	
3. Touch timer on-off . The timer will count down. To cancel the timer, touch the STOP/CLEAR pad once.	

NOTE

timer on-off operates as a kitchen timer and cannot be used when the oven is operating.

Demonstration mode

To demonstrate, touch **set clock**, the number **0** and then touch the **START** pad and hold for three seconds. *DEMO ON* will appear in the display. Cooking operations and specific special features can now be demonstrated with no power in the oven. For example, touch **add 30 seconds** pad and the display will show *:30* and count down quickly to *END*.

To cancel, touch **set clock**, the number **0** and **STOP/CLEAR** pads. If easier, unplug the oven from the electrical outlet and replug.

Help

Each setting has a cooking hint. If you wish to check, touch **user pref** whenever *HELP* is lighted in the Interactive Display for these and other manual operation hints.

Disconnect the power cord before cleaning or leave the door open to inactivate the oven during cleaning.

EXTERIOR

Clean the outside with mild soap and water; rinse and dry with a soft cloth. Do not use any type of household or abrasive cleaner.

DOOR

Wipe the window on both sides with a damp cloth to remove any spills or splatters. Metal parts will be easier to maintain if wiped frequently with a damp cloth. Avoid the use of spray and other harsh cleaners as they may stain, streak or dull the door surface.

TOUCH CONTROL PANEL

Care should be taken in cleaning the touch control panel. If the control panel becomes soiled, open the Convection Microwave Oven door before cleaning. Wipe the panel with a cloth dampened slightly with water only. Dry with a soft cloth. Do not scrub or use any sort of chemical cleaners. Close door and touch **STOP/CLEAR**.

INTERIOR – AFTER MICROWAVE COOKING

Cleaning is easy because no heat is generated to the interior surfaces; therefore, there is no baking and setting of spills or spattering. To clean the interior surfaces, wipe with a soft cloth and warm water. **DO NOT USE ABRASIVE OR HARSH CLEANERS OR SCOURING PADS.** For heavier soil, use baking soda or a mild soap; rinse thoroughly with hot water.

INTERIOR – AFTER CONVECTION, MIX OR BROIL COOKING

Spatters may occur because of moisture and grease. Wash immediately after use with hot, soapy water. Rinse and polish dry. Harder to remove spatters may occur if oven is not thoroughly cleaned or if there is long time/high temperature cooking. If so, you may wish to purchase an oven cleaner pad with liquid cleaner within it — not a soap filled steel pad for use on stainless steel or porcelain surfaces.

Follow manufacturer's directions carefully and be especially cautious not to get any of the liquid cleaner in the perforations on the wall or ceiling or any door surfaces.

Rinse thoroughly and polish dry.

After cleaning the interior thoroughly, residual grease may be removed from the interior ducts and heater by simply operating the oven on 450°F for 20 minutes without food. Ventilate the room if necessary.

WAVEGUIDE COVER

The waveguide cover is made from mica so requires special care. Keep the waveguide cover clean to assure good oven performance. Carefully wipe with a damp cloth any food splatters from the surface of the cover immediately after they occur. Built-up splashes may overheat and cause smoke or possibly catch fire. Do not remove the waveguide cover.

ODOR REMOVAL

Occasionally, a cooking odor may remain in the oven. To remove, combine 1 cup water, grated peel and juice of 1 lemon and several whole cloves in a 2-cup glass measuring cup. Boil for several minutes using 100% power. Allow to set in oven until cool. Wipe interior with a soft cloth.

TURNTABLE/TURNTABLE SUPPORT/RACKS

The turntable, turntable support and racks can be removed for easy cleaning. Wash them in mild, sudsy water; for stubborn stains use a mild cleanser and a non-abrasive scouring sponge. They are also dishwasher-proof. Use top rack of dishwasher for turntable support.

Foods with high acidity, such as tomatoes or lemons, will cause the porcelain enamel turntable to discolor. Do not cook highly acidic foods directly on the turntable; if spills occur, wipe up immediately.

The turntable motor shaft is not sealed, so excess water or spills should not be allowed to stand in this area.

Please check the following before calling for service:

1. Place one cup of water in a glass measuring cup in the oven and close the door securely.
Operate the oven for one minute at HIGH 100%.
 - A Does the oven light come on? YES _____ NO _____
 - B Does the cooling fan work?
(Put you hand over the front ventilation openings) YES _____ NO _____
 - C Does the turntable rotate?
(It is normal for the turntable to turn in either direction.) YES _____ NO _____
 - D Is the water in the oven warm? YES _____ NO _____

2. Remove water from the oven and operate the oven for 5 minutes at CONVECTION 450°F.
 - A Do **CONVEC** and **COOK** indicators light? YES _____ NO _____
 - B After the oven shuts off, is inside of the oven hot? YES _____ NO _____

If “NO” is the answer to any of the above questions, please check electrical outlet, fuse and/or circuit breaker. If they are functioning properly, CONTACT YOUR NEAREST ELECTROLUX AUTHORIZED SERVICER.

A Convection Microwave Oven should never be serviced by a “do-it-yourself” repair person.



NOTE

If time appearing in the display is counting down very rapidly, check Demonstration mode on page 35 and cancel.

EW30SO60QS

AC Line Voltage:	UL Rating: CSA Rating:	Single phase 120V, 60Hz, Ac only Single phase 117V, 60Hz, Ac only
AC Power Required:	UL Rating: CSA Rating:	1.55 Kw, 13.0 amps 1.5 Kw, 13.0 amps
Output Power:*	Microwave Convection	900 watts 1450 watts
Frequency:	2450 MHz	
Outside Dimensions:	30" (W) x 20-7/8" (H) x 23-1/4" (D)	
Cavity Dimensions:**	16-5/32" (W) x 9-21/32" (H) x 16-5/32" (D)	
Oven Capacity:	1.5 Cu. Ft.	
Weight:	Approx. 83.5 lbs	

* The International Electrotechnical Commission's standardized method for measuring output wattage. This test method is widely recognized.

** Internal capacity is calculated by measuring maximum width, depth and height. Actual capacity for holding food is less.

In compliance with standards set by:

FCC - Federal Communications Commission Authorized.

DHHS - Complies with Department of Health and Human Services (DHHS) rule, CFR, Title 21, Chapter I, Subchapter J.



- This symbol on the nameplate means the product is listed by Underwriters Laboratories, Inc. for use in USA or Canada.

MAJOR APPLIANCE WARRANTY INFORMATION

Your appliance is covered by a one year limited warranty. For one year from your original date of purchase, Electrolux will repair or replace any parts of this appliance that prove to be defective in materials or workmanship when such appliance is installed, used, and maintained in accordance with the provided instructions. In addition, the magnetron tube of your appliance is covered by a two through five year limited warranty. During the 2nd through 5th years from your original date of purchase, Electrolux will provide a replacement magnetron tube for your appliance which has proven to be defective in materials or workmanship when your appliance is installed, used, and maintained in accordance with the provided instructions.

Exclusions

This warranty does not cover the following:

1. Products with original serial numbers that have been removed, altered or cannot be readily determined.
2. Product that has been transferred from its original owner to another party or removed outside the USA or Canada.
3. Rust on the interior or exterior of the unit.
4. Products purchased "as-is" are not covered by this warranty.
5. Food loss due to any refrigerator or freezer failures.
6. Products used in a commercial setting.
7. Service calls which do not involve malfunction or defects in materials or workmanship, or for appliances not in ordinary household use or used other than in accordance with the provided instructions.
8. Service calls to correct the installation of your appliance or to instruct you how to use your appliance.
9. Expenses for making the appliance accessible for servicing, such as removal of trim, cupboards, shelves, etc., which are not a part of the appliance when it is shipped from the factory.
10. Service calls to repair or replace appliance light bulbs, air filters, water filters, other consumables, or knobs, handles, or other cosmetic parts.
11. Labor or in-home service costs during the additional limited warranty periods beyond the first year from your original date of purchase.
12. Pickup and delivery costs; your appliance is designed to be repaired in the home.
13. Surcharges including, but not limited to, any after hour, weekend, or holiday service calls, tolls, ferry trip charges, or mileage expense for service calls to remote areas, including the state of Alaska.
14. Damages to the finish of appliance or home incurred during transportation or installation, including but not limited to floors, cabinets, walls, etc.
15. Damages caused by: services performed by unauthorized service companies; use of parts other than genuine Electrolux parts or parts obtained from persons other than authorized service companies; or external causes such as abuse, misuse, inadequate power supply, accidents, fires, or acts of God.

DISCLAIMER OF IMPLIED WARRANTIES; LIMITATION OF REMEDIES

CUSTOMER'S SOLE AND EXCLUSIVE REMEDY UNDER THIS LIMITED WARRANTY SHALL BE REPAIR OR REPLACEMENT AS PROVIDED HEREIN. **CLAIMS BASED ON IMPLIED WARRANTIES, INCLUDING WARRANTIES OF MERCHANTABILITY OR FITNESS FOR A PARTICULAR PURPOSE, ARE LIMITED TO ONE YEAR OR THE SHORTEST PERIOD ALLOWED BY LAW, BUT NOT LESS THAN ONE YEAR.** ELECTROLUX SHALL NOT BE LIABLE FOR CONSEQUENTIAL OR INCIDENTAL DAMAGES SUCH AS PROPERTY DAMAGE AND INCIDENTAL EXPENSES RESULTING FROM ANY BREACH OF THIS WRITTEN LIMITED WARRANTY OR ANY IMPLIED WARRANTY. SOME STATES AND PROVINCES DO NOT ALLOW THE EXCLUSION OR LIMITATION OF INCIDENTAL OR CONSEQUENTIAL DAMAGES, OR LIMITATIONS ON THE DURATION OF IMPLIED WARRANTIES, SO THESE LIMITATIONS OR EXCLUSIONS MAY NOT APPLY TO YOU. THIS WRITTEN WARRANTY GIVES YOU SPECIFIC LEGAL RIGHTS. YOU MAY ALSO HAVE OTHER RIGHTS THAT VARY FROM STATE TO STATE.

If You Need Service

Keep your receipt, delivery slip, or some other appropriate payment record to establish the warranty period should service be required. If service is performed, it is in your best interest to obtain and keep all receipts. Service under this warranty must be obtained by contacting Electrolux at the addresses or phone numbers below.

This warranty only applies in the USA, Puerto Rico and Canada. In the USA and Puerto Rico, your appliance is warranted by Electrolux Major Appliances North America, a division of Electrolux Home Products, Inc. In Canada, your appliance is warranted by Electrolux Canada Corp. Electrolux authorizes no person to change or add to any obligations under this warranty. Obligations for service and parts under this warranty must be performed by Electrolux or an authorized service company. Product features or specifications as described or illustrated are subject to change without notice.

USA

1-877-435-3287
Electrolux Home Products, Inc.
10200 David Taylor Drive
Charlotte, NC 28262

Canada

1-800-265-8352
Electrolux Canada Corp.
5855 Terry Fox Way
Mississauga, Ontario, Canada L5V 3E4