

OWNER'S MANUAL

Operating and Servicing Instructions

Español - página E1



hoover.com

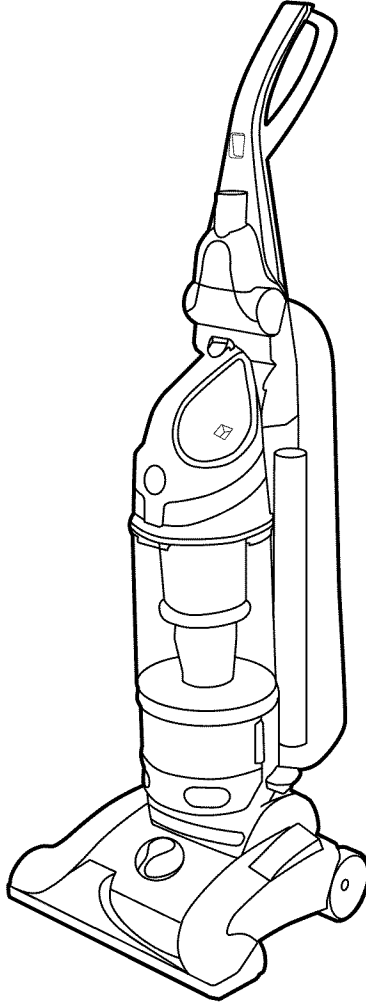

IMPORTANT: READ CAREFULLY BEFORE ASSEMBLY AND USE.

Questions or concerns? For assistance, please call Customer Service at 1-800-944-9200
Mon-Fri 8am-7pm EST. **PLEASE DO NOT RETURN THIS PRODUCT TO THE STORE.**

**THIS PRODUCT IS INTENDED FOR HOUSEHOLD USE ONLY.
IF USED COMMERCIALY WARRANTY IS VOID.**

Thank you for choosing a HOOVER® product.

Please enter the complete model and Manufacturing Code in the spaces provided.

MODEL _____

MFG. CODE _____

Hint: Attach your sales receipt to this owner's manual. Verification of date of purchase may be required for warranty service of your HOOVER® product.

Be sure to register your product online at Hoover.com or call 1-800-944-9200 to register by phone. Visit Hoover.com for additional video instructions for assembly and maintenance.

www.hoover.com
1-800-944-9200
(USA and Canada)

x XXXXX XXXXX x

Technronic Floor Care Technology Limited
VACUUM CLEANER/ASPIRATEUR/ASPIRADORA
MODEL/MODELE/MODELO XXXXXXXX
MFG. CODE XXXX

120 v. 60Hz. 1.0 A
SERIES/SERIE/SERIE XXXXXX
HOUSEHOLD TYPE/TYPE MENAJERO/TIPO DOMESTICO
Distributed by HOOVER, Inc., Greenlawn OH 44139
Made in China/Hecho en China/Fabrigué en Chine

MANUFACTURING CODE
(Label located on back of vacuum)

CONTENTS

Important Safety Instructions	3
Vacuum Assembly	5
Carton Contents	5
Attach Handle	5
Attach Dirt Cup	5
Position Tools	5
How To Use	6
Vacuum Description	6
On-Off Switch	6
Suction Only Mode/ Brushroll Shut-Off.....	6
Cord Release.....	6
Transporting Cleaner.....	7
Handle Positions.....	7
Carpet Height Adjustment	7
Tools	8
Select Proper Tool.....	8
Removing Hose	8
Attach Wand And Tools.....	8
How To Clean Tools.....	8
Stair Cleaning	9
Cord Rewind and Storage	9
Maintenance	10
Dirt Cup	10
Filters.....	11
Brushroll	12
Hose	13
Air-Powered Hand Tool	13
Headlight	13
Belt	14
Troubleshooting	15
Service	16
Warranty	17

If you need assistance:

Visit our website at hoover.com. Follow the authorized dealer locator link to find the Hoover® authorized dealer nearest you or call 1-800-944-9200 for an automated referral of Hoover® authorized dealer locations (U.S. only) or to speak with a customer service representative; Mon- Fri 8am- 7pm EST.

PLEASE DO NOT RETURN THIS PRODUCT TO THE STORE.

IMPORTANT SAFETY INSTRUCTIONS

SAVE THESE INSTRUCTIONS

When using an electrical appliance, basic precautions should always be followed, including the following:

READ ALL INSTRUCTIONS BEFORE USING THIS APPLIANCE.

WARNING: TO REDUCE THE RISK OF FIRE, ELECTRIC SHOCK OR INJURY:

- Fully assemble before operating.
- Operate cleaner only at voltage specified on data label on back of cleaner.
- Do not leave appliance when plugged in. Unplug from outlet when not in use and before cleaning or servicing.
- Do not use outdoors or on wet surfaces.
- Do not allow to be used as a toy. Not intended for use by children age 12 and under. Close supervision is necessary when used near children. To avoid injury or damage, keep children away from product, and do not allow children to place fingers or other objects into any openings.
- Use only as described in this manual. Use only manufacturer's recommended attachments and products.
- Do not use with damaged cord or plug. If appliance is not working as it should, has been dropped, damaged, left outdoors, or dropped into water, take it to a service center prior to continuing use.
- Do not pull or carry by cord, use cord as a handle, close a door on cord, or pull cord around sharp edges or corners. Do not place product on cord. Do not run appliance over cord. Keep cord away from heated surfaces.
- Do not unplug by pulling on cord. To unplug, grasp the plug, not the cord.
- Do not handle plug or appliance with wet hands.
- Do not put any object into openings. Do not use with any opening blocked; keep free of dust, lint, hair, and anything that may reduce air flow.
- Keep hair, loose clothing, fingers, and all parts of body away from openings and moving parts.
- Turn off all controls before unplugging.
- Use extra care when cleaning on stairs. To avoid personal injury or damage, and to prevent the cleaner from falling, always place cleaner at bottom of stairs on floor. Do not place cleaner on stairs or furniture, as it may result in injury or damage.
- Do not use to pick up flammable or combustible liquids, such as gasoline, or fine wood sandings, or use in areas where they may be present.
- Hold plug when rewinding onto cord reel. Do not allow plug to whip when rewinding.
- Unplug before connecting Air-Powered Hand Tool.
- Do not pick up anything that is burning or smoking, such as cigarettes, matches, or hot ashes.
- Do not use without Dirt Cup and/or Filters in place.
- **WARNING:** This product contains chemicals known to the State of California to cause cancer, birth defects or reproductive harm. **WASH HANDS AFTER HANDLING.**

CAUTION: TO REDUCE THE RISK OF DAMAGE:

- Avoid picking up hard, sharp objects with this product, as they may cause damage.
- Store appropriately indoors in a dry place. Do not expose machine to freezing temperatures.
- Do not use sharp objects to clean out hose as they can cause damage.
- With brushroll on, do not allow cleaner to sit in one location for an extended period of time, as damage to floor can result.

WARNING:

- To reduce the risk of electric shock, this appliance has a polarized plug (one blade is wider than the other). This plug will fit in a polarized outlet only one way. If the plug does not fit fully in the outlet, reverse the plug. If it still does not fit, contact a qualified electrician to install the proper outlet. Do not change the plug in any way.

1. VACUUM ASSEMBLY

CARTON CONTENTS

- A. Handle
- B. Vacuum Base
- C. Air-Powered Hand Tool*
- D. Crevice Tool
- E. Telescoping Wand
- F. Screw (for assembly)
- G. Dirt Cup
- H. Dusting/Upholstery Tool*

*Varies per model

Remove all parts from carton and identify each item shown.

Make sure all parts are located before disposing of packing materials.

Additional parts may be ordered at Hoover.com or call 1-800-944-9200.

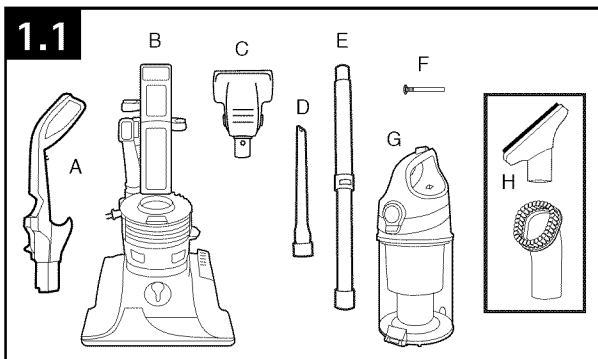

ATTACH HANDLE

Note: Remove the screw located in the vacuum base and set aside until instruction 1.3

1.2 Insert handle section into vacuum base. Push down firmly.

1.3 Using a Phillips screwdriver, fasten (1) screw behind handle into vacuum base.

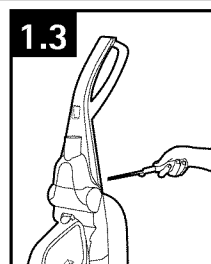
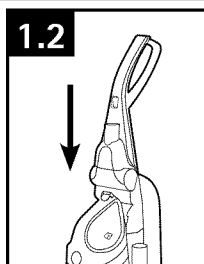

ATTACH DIRT CUP

1.4 Place bottom of dirt cup into vacuum body first. Pivot cup into vacuum. Dirt cup is secure when you hear a click.

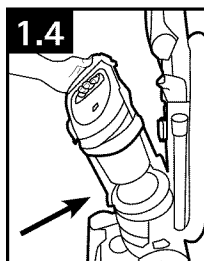

POSITION TOOLS (varies per model)

1.5 Attach bottom of Air-Powered Hand Tool (A) and pivot into handle until secure.

1.6 Place Crevice Tool into Wand and slide into tool storage area on left back side (B) of vacuum and place Upholstery Tool on right back side (C) of vacuum as shown.

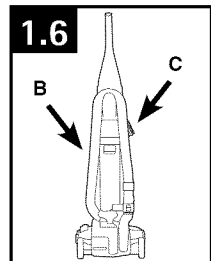
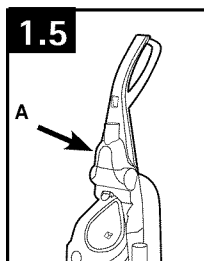

2. HOW TO USE

VACUUM DESCRIPTION

1. Handle
2. ON/OFF Switch
3. Air-Powered Hand Tool **
4. Dirt Cup Release Button
5. Carry Handle
6. Rinsable Filter Access
7. Dirt Cup
8. Cord Rewind
9. Filter made with HEPA media and Carbon Filter* Access
10. Stair Cleaning Handle
11. Headlight*
12. Height Adjustment
13. System Check Indicator
14. Crevice Tool (inside wand)
15. Telescoping Wand
16. Hose
17. Cord Rewind Pedal
18. Brushroll On/Off Pedal (Suction Only Mode)
19. Furniture Guard
20. Dusting/ Upholstery Tool**
21. Hose Release Button
22. Hose Tube
23. Handle Release Pedal

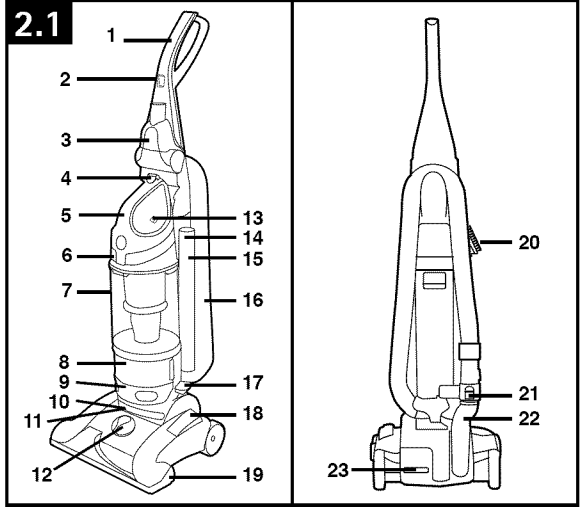

*Available on select models only

**Varies per model

ON-OFF SWITCH

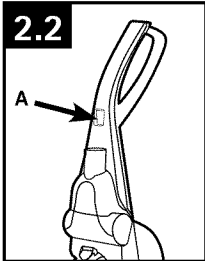

2.2 Plug cord into electrical outlet.

To turn vacuum ON, push ON/OFF button (A) once.

To turn vacuum OFF, push switch again.

SUCTION ONLY MODE/ BRUSHROLL SHUT-OFF

for bare floors and very high pile carpet

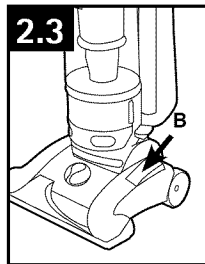

2.3 For optimal cleaning performance on bare floors and carpet with pile deeper than 1", brushroll should be turned off.

The vacuum is shipped with the brushroll in the ON position. To turn brushroll OFF for Suction Only Mode, step on pedal (B).

• IMPORTANT •

Pedal (B) is inactive when the cleaner is in the upright position.

▲ CAUTION ▲

Brushroll should be in off position for cleaning of high pile carpet deeper than 1".

▲ CAUTION ▲

Not to be used for grooming a pet.

CORD RELEASE

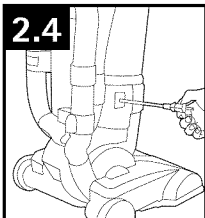

2.4 Grasp the end of the plug and pull to release cord from cord reel.

• IMPORTANT •

When pulling on the cord, yellow tape will identify when the cord is almost fully extended. When red tape is visible on the cord, the cord has reached its full length. Do not pull the cord past the red tape.

TRANSPORTING CLEANER

2.5 To move your cleaner from room to room, put handle in upright position, tilt cleaner back on rear wheels and push forward.

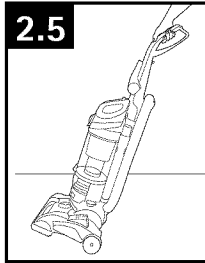

HANDLE POSITIONS

2.6 The handle of your cleaner has two positions: 1) Upright for storage and when using cleaning tools. 2) Operating position for general operation on carpets and floors.

Step on handle release pedal to lower handle.

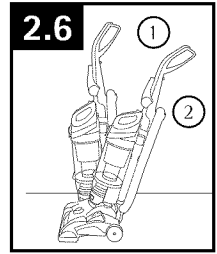

CARPET HEIGHT ADJUSTMENT

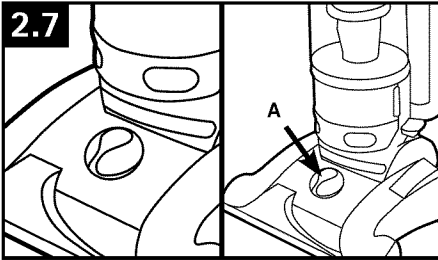

2.7 To adjust height setting, TURN knob (A) to desired height setting.

For maximum cleaning performance, the following carpet height settings are recommended:

- Lowest setting (1): for bare floors.
- Low setting (2): for all types of carpet.
- Higher settings: for very deep pile carpet, where easier pushing effort is desired, while maintaining good cleaning performance.

• IMPORTANT •

If the vacuum is difficult to push, turn knob to the next higher setting.

3. TOOLS

Tools allow for cleaning surfaces above the floor and for reaching hard to clean areas. The vacuum is ready for tool use when handle is in upright position.

SELECT PROPER TOOL

(Tools may vary per model)

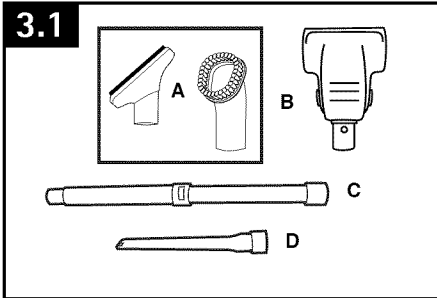

A. Use Dusting/ Upholstery Tool to clean upholstered furniture, draperies, mattresses, clothing, and carpeted stairs. (Tool varies per model)

B. Air-Powered Hand Tool may be used for upholstered furniture, draperies, mattresses, clothing, and carpeted stairs. (Tool varies per model)

C. Telescoping Wand is used to give extra length to your hose. Use it with any of the above tools.

D. Crevice Tool may be used in tight spaces, corners and along edges in such places as dresser drawers, upholstered furniture, stairs and baseboards.

REMOVING HOSE

⚠ WARNING ⚠

To reduce the risk of personal injury - Unplug before cleaning or servicing.

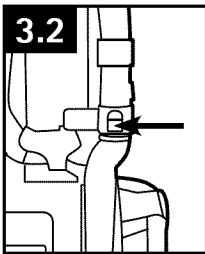

3.2 When using cleaning tools, place cleaner handle in the upright position. The agitator brushroll will not rotate when the cleaner is in the upright position.

To remove hose for tool use, press the hose release button and pull hose end out.

To lock back into place, push hose into hose tube until you hear a click.

ATTACH WAND AND TOOLS

(Tools may vary per model)

⚠ WARNING ⚠

Unplug vacuum before connecting Air-Powered Hand Tool.

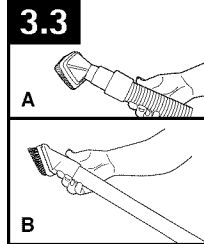

3.3 Attach tool or wand to the hose (A).

Attach tool to wand (B) by pushing it firmly onto the wand.

Twist wand or tool slightly to tighten or loosen the connection.

To extend wand, twist counter-clockwise to the unlocked position, extend wand & twist clockwise until tight. Reverse to collapse.

⚠ CAUTION ⚠

Not to be used for grooming a pet.

HOW TO CLEAN TOOLS

To clean Hose and Air-Powered Hand Tool, wipe with a damp cloth. DO NOT submerge in water.

Other cleaning tools may be washed in warm water with a mild detergent. Rinse and air dry 24 hours before using.

STAIR CLEANING

3.4 Lift vacuum by Stair Cleaning Handle and position on stairs. Clean forward to back. Never leave the vacuum standing on stairs when not cleaning.

3.5 Use the Hose and Air-Powered Hand Tool (Tool varies per model) for stair cleaning. When using tools, always ensure handle is in upright position.

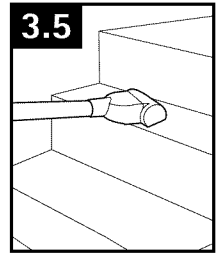
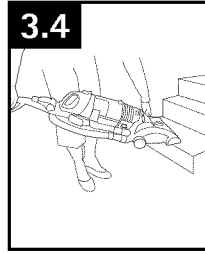

⚠ CAUTION ⚠

Use extra care when cleaning on stairs. To avoid personal injury or damage, and to prevent the cleaner from falling, always place cleaner at bottom of stairs on floor. Do not place cleaner on stairs or furniture, as it may result in injury or damage. When using tools, always ensure handle is in upright position.

CORD REWIND AND STORAGE

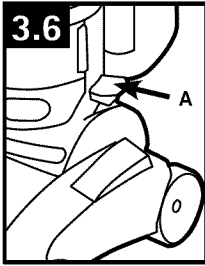

3.6 To return cord for storage, unplug from wall.

To return cord for storage, hold plug and press down Cord Release Pedal (A) on side of cord reel.

⚠ WARNING ⚠

Hold plug when rewinding onto cord reel. Do not allow plug to whip when rewinding.

4. MAINTENANCE

Familiarize yourself with these home maintenance tasks as proper use and care of your vacuum will ensure continued cleaning effectiveness.

If appliance is not working as it should, has been dropped, damaged, left outdoors, or dropped into water, take it to a service center prior to continuing use.

4.1 The System Check Indicator located at (A), alerts you to possible system performance issues.

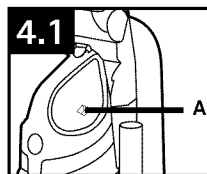

PROBLEM	POSSIBLE CAUSE	POSSIBLE SOLUTION
If System Check Indicator is red:	1. Rinsable filter and/or filter made with HEPA media is dirty.	1. Clean rinsable filter and/or filter made with HEPA media - reference pg. 11
	2. Dirt cup is full and/or clogged.	2. Empty dirt cup - reference pg. 10
	3. Brushroll and/or hose is clogged.	3. Check hose for clogging - reference pg 13. Check brushroll for clogging - reference pg. 12.

Any other servicing should be done by an authorized service representative.

⚠ NOTICE ⚠

A Thermal Protector has been designed into your cleaner to protect it from overheating. When the thermal protector activates the cleaner will stop running.

If this happens proceed as follows:

1. Turn cleaner OFF and unplug it from the electrical outlet.
2. Empty dirt cup.
3. Inspect the nozzle inlet, hose connector, hose, dirt cup inlet, cyclonic filter, rinsable filter, and HEPA filter for any obstructions. Clear obstructions if present.

When cleaner is unplugged and motor has cooled for 30 minutes, the thermal protector will deactivate and cleaning may continue.

If the thermal protector continues to activate after following the above steps, your cleaner needs servicing.

DIRT CUP

When to Empty

4.2 To maintain optimal performance, empty the dirt cup before the dirt cup reaches the max line (A). Place the vacuum in the upright position before removing the dirt cup.

⚠ WARNING ⚠

To reduce the risk of personal injury - Unplug before cleaning or servicing. Do not use vacuum without dirt cup or filters in place.

Very fine materials, such as face powder or cornstarch, may seal the filter and cause a reduction in performance. When using the vacuum for this type of dust, empty the cup and clean the filters often.

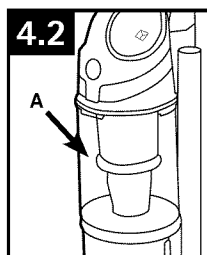

How to Empty

4.3 Press dirt cup release button (A) and pivot cup out.

4.4 Hold dirt cup over trash receptacle, push dirt cup door release lever (B) to open dirt cup door (C).

Close dirt cup door (C). Press firmly to secure lever.

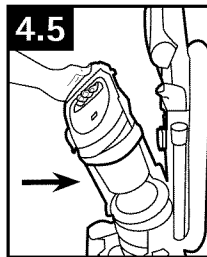
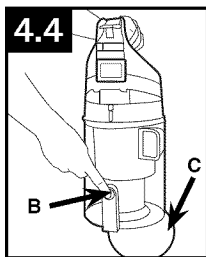
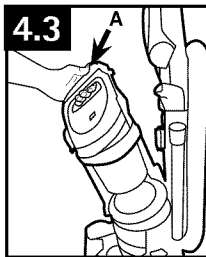

4.5 Place bottom of dirt cup into vacuum body first. Pivot dirt cup into vacuum body and press firmly until it locks into place.

FILTERS: When to Clean

To maintain optimal performance, filters should be cleaned at least every two months under normal use.

Rinsable Filter: How to Clean

Remove dirt cup as described in Fig. 4.3.

4.6 Pull up on dirt cup latch to open.

4.7 Pull on filter by the pocket to remove rinsable filter.

Hold filter under running water for at least two minutes to remove dirt and debris. Squeeze filter twice while underwater. Remove from water and squeeze a final time to remove excess water.

⚠ WARNING ⚠

To reduce the risk of personal injury - Unplug before cleaning or servicing. Do not use vacuum without dirt cup or filters in place.

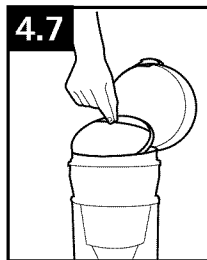
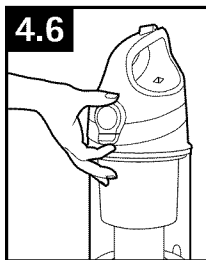

• IMPORTANT •

Allow filter to dry completely before replacing. Dry filter on edge so air circulates on both sides of filter. This may take up to 48 hours.

Replace filter with pocket facing up.

Close lid securely by pushing until it clicks.

Replace dirt cup as described in Fig 4.5.

What to Buy: Rinsable Filter

When used and maintained properly, your Rinsable Filter should not need replacement within the warranty period. If desired, additional filter is available at Hoover.com or call 1-800-944-9200. Ask for Hoover® Part No. 303903001.

Filter Made With HEPA Media: How to Clean

4.8 With fingers in slots, pull filter frame (A) straight out. Hold filter over a trash receptacle and tap out dirt and debris.

Slide back into position on vacuum and press firmly.

⚠ WARNING ⚠

To reduce the risk of personal injury - Unplug before cleaning or servicing. Do not use vacuum without dirt cup or filters in place.

• IMPORTANT •

DO NOT RINSE OR WASH THE FILTER MADE WITH HEPA MEDIA.

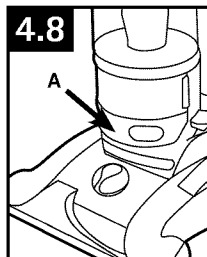

What to Buy: Filter Made With HEPA Media

When used and maintained properly, your Filter should not need replacement within the warranty period. If desired, additional filter is available at Hoover.com or call 1-800-944-9200. Ask for Hoover® Part No. 305687001.

Carbon Filter : How to Clean

(Available on select models only).

Your Carbon Filter is located on the underside of the Filter made with HEPA media.

• IMPORTANT •

DO NOT RINSE OR WASH the Carbon Filter.

What to Buy: Carbon Filter

Carbon Filter may need to be replaced more often to maintain optimal odor absorbing effectiveness. Additional filter is available at Hoover.com or call 1-800-944-9200. Ask for Hoover® Part **902404001**.

Cyclonic Filter Assembly: How to Clean

▲ WARNING ▲

To reduce the risk of personal injury - Unplug before cleaning or servicing. Do not use vacuum without dirt cup or filters in place.

Remove dirt cup as described in Fig. 4.3.

4.9 Twist filter assembly (B) counter-clockwise. Remove assembly from dirt cup (A).

4.10 Dirt and debris can be cleaned from the filter assembly with the Dusting/ Upholstery Tool.

Place the filter assembly (4.9, B) on the dirt cup, aligning (3) tabs on filter with (3) slots on dirt cup (A) and twist it clockwise to secure into position.

Replace dirt cup as described in Fig. 4.5.

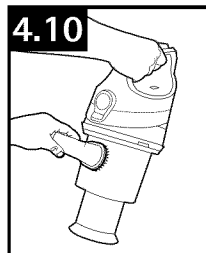
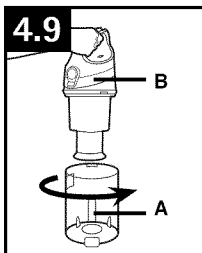

• IMPORTANT •

Filter assembly must be properly aligned to dirt cup to function properly.

BRUSHROLL: How to Clean

▲ CAUTION ▲

To reduce the risk of injury from moving parts - Unplug before servicing.

4.11 Turn vacuum over so bottom side is facing up and remove the (6) screws (A).

4.12 Pivot out bottom plate away from hidden latch (B) and remove any debris and/or hair from the brushroll.

4.13 Reposition bottom plate, aligning latch (B) and fastening all (6) screws (A). Press firmly at latch (B) area to ensure that it is properly latched.

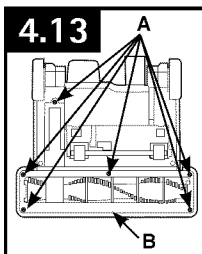
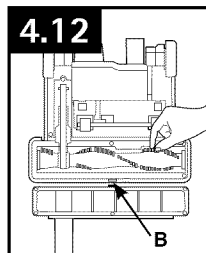
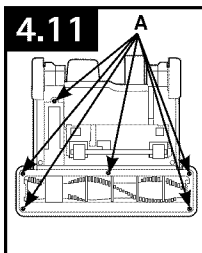

HOSE: How to Clean

⚠ WARNING ⚠

To reduce the risk of personal injury - Unplug before cleaning or servicing.

4.14 To remove hose for tool use, press the hose release button (A) and pull hose end out.

Clear away debris or obstructions from hose. Do not use sharp objects to clean out hose as they can cause damage. To lock back into place, push hose into hose tube until you hear a click.

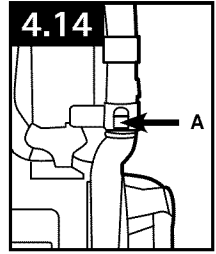

AIR-POWERED HAND TOOL:

How to Clean

(Tool varies per model)

⚠ CAUTION ⚠

To reduce the risk of injury from moving parts - Unplug before servicing.

4.15 Turn tool so bottom faces up. Rotate the latches (A) on either side of tool.

4.16 Remove bottom plate (B).

4.17 Remove any debris and/ or hair from brushroll. Replace bottom plate by aligning tabs along front edge of tool. Rotate latches back into locked position.

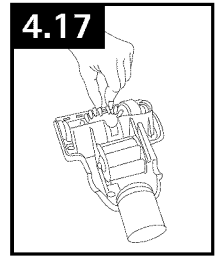
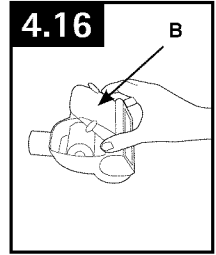
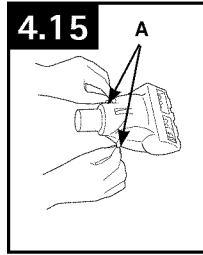

HEADLIGHT: How to Replace

(available on select models only)

⚠ WARNING ⚠

To reduce the risk of electric shock - Unplug before cleaning or servicing.

Removing Lens

Press Handle Release Pedal and place handle in low position.

4.18 Using a Phillips screwdriver, remove (2) screws as shown and lift off lens.

Installing Bulb

4.19 Pull old bulb straight out of socket. Push new bulb straight into socket until locked in place.

Do not use excessive force when installing bulb.

Do not twist or turn bulb when installing bulb.

Replacing Lens

4.20 Reposition lens and secure with screws.

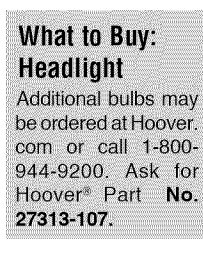
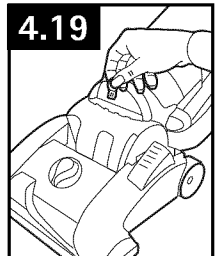
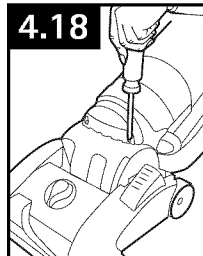

What to Buy: Headlight

Additional bulbs may be ordered at Hoover.com or call 1-800-944-9200. Ask for Hoover® Part No. 27313-107.

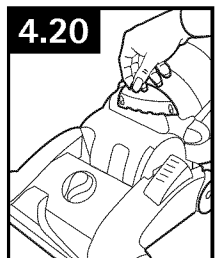

BELT



To reduce the risk of injury from moving parts -
Unplug before servicing.

The belt is located under the bottom plate of the vacuum and should be checked from time to time to be sure it is in good condition.

When To Replace

Replace belt if it is stretched, cut or broken.
To check the belt, refer to Fig. 4.24 - 4.26.

How To Replace

4.21 Turn vacuum over so bottom side is facing up and remove the (6) screws (A).

4.22 Pivot out bottom plate away from hidden latch (B).

4.23 Remove used belt from brushroll (C) then from motor shaft (metal rod) (D) and discard.

What to Buy: Belt

Use only genuine HOOVER® belts with your vacuum.

When purchasing a new belt for models **with** Brushroll On/Off (Suction Only Mode), ask for Flat Belt - HOOVER® part No. **562289001** or **AH20065**.

If desired, additional belts can be purchased at Hoover.com or 1-800-944-9200

4.24 With lettering on outside of belt, slide new belt over motor shaft (metal rod) (E).

4.25 Then slip other end of belt around area of brushroll without bristles (F).

With belt in place, pull and slide brushroll into nozzle making sure that the brushroll end caps are in the correct orientation.

4.26 Reposition bottom plate, aligning latch (B) and fastening all (6) screws (A).

Press firmly at latch (B) area to ensure that it is properly latched.

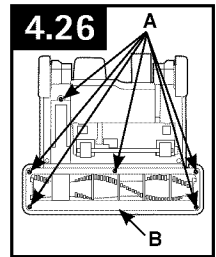
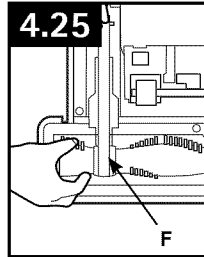
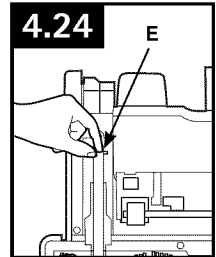
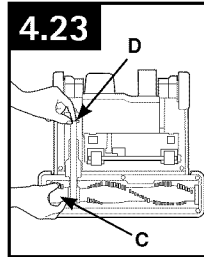
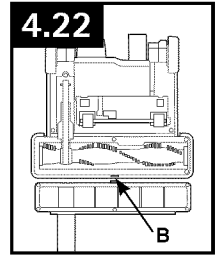
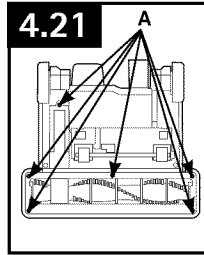

• IMPORTANT •

Rotate brushroll manually to make sure belt is not twisted.

LUBRICATION

The motor and brushroll are equipped with bearings which contain sufficient lubrication for their lifetime.

The addition of lubricant could cause damage. Do not add lubricant to motor or brushroll.

5. TROUBLESHOOTING

If a minor problem occurs, it usually can be solved quite easily when the cause is found by using the checklist below.

Any other servicing should be done by an authorized service representative.

If appliance is not working as it should, has been dropped, damaged, left outdoors, or dropped into water, take it to a service center prior to continuing use.

⚠ **WARNING** ⚠

To reduce the risk of personal injury - Unplug before cleaning or servicing.

PROBLEM	POSSIBLE CAUSE	POSSIBLE SOLUTION
Vacuum won't run	<ol style="list-style-type: none"> 1. Power cord not firmly plugged into outlet. 2. Blown fuse or tripped breaker. 3. Thermal Protector activated. 	<ol style="list-style-type: none"> 1. Plug unit in firmly. 2. Check fuse or breaker in home. Replace fuse/reset breaker in home. 3. Unplug and allow vacuum to cool for 30min. (This will reset the thermal protector)
System Check Indicator has turned red or Vacuum won't pick up or Low suction	<ol style="list-style-type: none"> 1. Rinsable Filter and/ or Filter made with HEPA media is dirty. 2. Dirt cup full and/ or clogged. 3. Broken or worn belt. 4. Brushroll and/ or Hose clogged. 5. Carpet height setting is incorrect. 6. Suction Only Mode is ON. 	<ol style="list-style-type: none"> 1. Clean Rinsable Filter and or Filter made with HEPA media - Pg. 11. 2. Empty dirt cup - Pg. 10. 3. Replace belt - Pg.14. 4. Check Hose - Pg.13. Check Brushroll - Pg. 12. 5. Set Carpet Height Adjustment to appropriate setting for carpet being cleaned - Pg.7. 6. Step on Brushroll ON/OFF Pedal to turn Suction Only Mode OFF - Pg. 6.
Cord Rewind does not work	<ol style="list-style-type: none"> 1. Cord reel does not retract. 	<ol style="list-style-type: none"> 1. Call 1-800-944-9200 for the nearest authorized service representative.
Dust escaping from vacuum	<ol style="list-style-type: none"> 1. Dirt cup full. 2. Dirt cup not installed correctly. 3. Hose not installed correctly. 4. Rinsable and/ or Filter made with HEPA media not installed completely. 	<ol style="list-style-type: none"> 1. Empty dirt cup - Pg. 10. 2. Review Dirt Cup removal & replacement - Pg. 10. 3. Review Hose installation - Pg. 8. 4. Review Filter Removal and Cleaning - Pg. 11.
Headlight not working	<ol style="list-style-type: none"> 1. Bulb burnt out. 2. Loose electrical wires. 	<ol style="list-style-type: none"> 1. Replace bulb - Pg. 13. 2. Call 1-800-944-9200 for nearest authorized Hoover® dealer.
Vacuum is difficult to push or won't move forward	<ol style="list-style-type: none"> 1. Carpet height setting is incorrect. 2. Brushroll is activated. 	<ol style="list-style-type: none"> 1. Set Carpet Height Adjustment knob to appropriate setting for carpet being cleaned - Pg. 7. 2. For very high pile carpet deeper than 1", turn brushroll off.
Air-Powered Hand Tool brushroll won't turn	<ol style="list-style-type: none"> 1. Too much pressure being applied to tool. 2. Blockage. 3. Low vacuum suction. 	<ol style="list-style-type: none"> 1. Continue using tool applying light pressure. 2. Remove blockage. 3. Check items under "Vacuum won't pick up or Low suction."
Smoky/burning smell detected	<ol style="list-style-type: none"> 1. Belt broken or stretched. 2. Brushroll is clogged. 	<ol style="list-style-type: none"> 1. Replace brushroll belt - Pg. 14. 2. Clear/ remove debris from brushroll - Pg.12.

6. SERVICE

To obtain approved Hoover® service and genuine Hoover® parts, locate the nearest Authorized Hoover® Warranty Service Dealer (Depot) by:

- Checking the Yellow Pages under “Vacuum Cleaners” or “Household”.
- Visit our website at hoover.com (U.S. Customers) or hoover.ca (Canadian customers). Follow the service center link to find the service outlet nearest you.
- For an automated referral of authorized service outlet locations call 1-800-944-9200.

Do not send your vacuum to Hoover®, Inc., Company in Glenwillow for service. This will only result in delay.

If you need further assistance:

To speak with a customer service representative call 1-800-944-9200; Mon-Fri 8am-7pm EST. Always identify your vacuum by the complete model number when requesting information or ordering parts. (The model number appears on the bottom of the vacuum.)

PLEASE DO NOT RETURN THIS PRODUCT TO THE STORE.

7. WARRANTY

LIMITED TWO YEAR WARRANTY

(Domestic Use)

WHAT THIS WARRANTY COVERS

When used and maintained in normal household use and in accordance with the Owner's Manual, your HOOVER® product is warranted against original defects in material and workmanship for a full two years from date of purchase (the "Warranty Period"). During the Warranty Period, Hoover® will provide labor and parts, at no cost to you, to correct any such defect in products purchased in the United States, U.S. Military Exchanges and Canada.

HOW TO MAKE A WARRANTY CLAIM

If this product is not as warranted, take or send the product to either a Hoover® Authorized Warranty Service Dealer along with proof of purchase. For an automated referral to authorized service outlets in the U.S.A., phone: 1-800-944-9200 OR visit Hoover® online at www.hoover.com. For additional assistance or information concerning this Warranty or the availability of warranty service outlets, phone the Hoover® Consumer Response Center, Phone 1-800-944-9200, Mon-Fri 8am-7pm EST.

WHAT THIS WARRANTY DOES NOT COVER

This Warranty does not cover: use of the product in a commercial operation (such as maid, janitorial and equipment rental services), brushroll, belt, improper maintenance of the product, damage due to misuse, acts of God, nature, vandalism or other acts beyond the control of Hoover®, owner's acts or omissions, use outside the country in which the product was initially purchased and resales of the product by the original owner. This warranty does not cover pick up, delivery, transportation or house calls. However, if you mail your product to a Hoover® Authorized Warranty Service Dealer, cost of shipping will be paid one way.

This warranty does not apply to products purchased outside the United States, including its territories and possessions, outside a U.S. Military Exchange and outside of Canada. This warranty does not cover products purchased from a party that is not an authorized retailer, dealer, or distributor of Hoover® products.

OTHER IMPORTANT TERMS

This Warranty is not transferable and may not be assigned. This Warranty shall be governed and construed under the laws of the state of Ohio. The Warranty Period will not be extended by any replacement or repair performed under this Warranty.

THIS WARRANTY IS THE EXCLUSIVE WARRANTY AND REMEDY PROVIDED BY HOOVER®. ALL OTHER WARRANTIES, EXPRESSED OR IMPLIED, INCLUDING WARRANTIES OF MERCHANTABILITY OR FITNESS FOR PARTICULAR PURPOSE, ARE DISCLAIMED. IN NO EVENT WILL HOOVER BE LIABLE FOR ANY SPECIAL, INDIRECT, INCIDENTAL OR CONSEQUENTIAL DAMAGES OF ANY KIND OR NATURE TO OWNER OR ANY PARTY CLAIMING THROUGH OWNER, WHETHER BASED IN CONTRACT, NEGLIGENCE, TORT OR STRICT PRODUCTS LIABILITY OR ARISING FROM ANY CAUSE WHATSOEVER. Some states do not allow the exclusion of consequential damages, so the above exclusion may not apply to you. This warranty gives you specific rights; you may also have others that vary from state to state.