

**BH**

# S1Ui



# OWNER'S MANUAL

*Important: Read all instructions carefully before using this product. Retain this owner's manual for future reference.*

**FOR SERVICE PLEASE CONTACT BH FITNESS  
TOLL FREE: 866-325-2339**



## TABLE OF CONTENTS

<b>Title</b>	<b>Page</b>
Introduction	03
Safety Information	04
Exercise Instruction	05
Training Guidelines	06
Suggested Stretches	10
Assembly Instructions	12
Exploded View Drawing	18
Parts List	20
Console Operations	22
Maintenance and Cleaning	29
Warranty	30

## CONGRATULATIONS

Congratulations on your purchase of BH Fitness equipment. We hope you appreciate the style, quality, and value that exercisers around the world have come to expect from BH Fitness.

If you have any questions, concerns or product issues please call our Customer Service Team at 1-866-325-2339 or email us at [CustomerSupport@BHNorthAmerica.com](mailto:CustomerSupport@BHNorthAmerica.com).

Carefully read through the instructions contained in this manual. They provide you with important information about assembly, safety, fitness and use of the machine. Please read ALL the safety information contained on the following page.

# SAFETY INFORMATION

## PRECAUTIONS

This equipment has been designed and constructed to provide maximum safety. Nevertheless, certain precautions should be taken when using exercise equipment. Read the whole manual before assembling and using the machine. Please observe the following safety precautions:

1. Keep children and pets away from this equipment at all times. DO NOT leave them unsupervised in the room where the machine is kept.
2. If you experience dizziness, nausea, chest pains or any other symptom while using this machine STOP exercising and SEEK IMMEDIATE MEDICAL ATTENTION!
3. Use the machine on a level and solid surface. Adjust the feet for stability.
4. Keep your hands away from any of the joints and moving parts.
5. Wear clothing suitable for doing exercise. Do not wear baggy clothing that might get caught in the machine. Always wear athletic shoes when using the machine and tie the laces securely.
6. This machine must only be used for the purposes described in this manual. DO NOT use accessories that are not recommended by BH Fitness. Read manual prior to use and follow all warnings and instructions.
7. Do not place sharp objects near the machine.
8. Any person with physical or coordination limitations should not use the machine without the assistance of a qualified person or doctor. Misuse of this machine may result in serious injury.
9. Do warm-up stretching exercises before using the equipment.
10. Do not use the machine if it is not working correctly.
11. Before using the machine, thoroughly inspect the equipment for proper assembly.
12. Keep a perimeter of 3 feet (1 meter) around the machine before operating the equipment.
13. Use only authorized and trained technicians if a repair is needed.
14. Please follow the advice for correct training, as detailed in the Training Guidelines.
15. Use only the tools provided to assemble this machine.
16. Replace warning labels if damaged, illegible or removed.
17. This machine was designed for a maximum user weight of 300 lbs (136 kgs)
18. The machine can only be used by one person at a time.

**Caution:** Consult your doctor before beginning to use the machine or any exercise program. Read all of the instructions before using any exercise equipment.

KEEP THESE INSTRUCTIONS SAFE FOR FUTURE USE.

## EXERCISE INSTRUCTION

Use of the machine offers various benefits; it can improve fitness, muscle tone and when used in conjunction with a calorie controlled diet, it can help you lose weight.

1. Consult your doctor before starting any exercise program. It is advisable to undergo a complete physical examination.
2. Work at the recommended exercise level. Do not over exert yourself.
3. If you feel any pain or discomfort, stop exercising immediately and consult your doctor.
4. Wear appropriate clothing and footwear for the exercise; do not wear loose clothing; do not wear leather soled shoes or footwear with high heels.
5. It is advised that you do warm-up stretches before working out.
6. Get on the equipment slowly and securely.
7. Select the program or workout option that is most closely aligned with your workout interests.
8. Start slowly and work your way up to a comfortable pace.
9. Be sure to cool down after your workout.

## TRAINING GUIDELINES

Exercise is one of the most important factors in the overall health of an individual. Listed among its benefits are:

- Increased capacity for physical work (strength endurance)
- Increased cardiovascular (heart and arteries/veins) and respiratory efficiency
- Decreased risk of coronary heart disease
- Changes in body metabolism, e.g. losing weight
- Delaying the physiological effects of age
- Reduction in stress, increase in self-confidence, etc.

There are several components of physical fitness and each is defined below.

### *STRENGTH*

The capacity of a muscle to exert a force against resistance. Strength contributes to power and speed.

### *MUSCULAR ENDURANCE*

The capacity to exert a force repeatedly over a period of time, e.g. it is the muscular endurance of your legs to carry you 10 km without stopping.

### *FLEXIBILITY*

The range of motion of your joints. Improving flexibility involves the stretching of muscles and tendons to maintain or increase suppleness, and it provides increased resistance to muscle injury or soreness.

### *CARDIO-RESPIRATORY ENDURANCE*

The most essential component of physical fitness, is the efficient functioning of the heart and lungs.

### *AEROBIC FITNESS*

Is an exercise of relatively low intensity and long duration, which depends primarily on the aerobic energy system. Aerobic means "with oxygen", and refers to the use of oxygen in the body's metabolic or energy-generating process. Many types of exercise are aerobic, and by definition are performed at moderate levels of intensity for extended periods of time.

### *ANAEROBIC TRAINING*

Is an exercise intense enough to trigger anaerobic metabolism. This means "without oxygen" and is the output of energy when the oxygen supply is insufficient to meet the body's long term energy demands. (For example, a 100 meter sprint.)

### *OXYGEN UPTAKE*

The effort that you can exert over a prolonged period of time is limited by your ability to deliver oxygen to the working muscles. Regular vigorous exercise produces a training effect that can increase your aerobic capacity by as much as 20 to 30%. An increased VO<sub>2</sub> Max indicates an increased ability of the heart to pump blood, of the lungs to ventilate oxygen, and of the muscles to take up oxygen.

### *THE TRAINING THRESHOLD*

This is the minimum level of exercise which is required to produce significant improvements in any physical fitness parameter.

### *OVERLOAD*

This is where you exercise above your comfort level. The intensity, duration and frequency of exercise should be above the training threshold and should be gradually increased as the body adapts to the increasing demands. As your fitness level improves, the training threshold should rise. Working through your program and gradually increasing the overload factor is important.

### *PROGRESSION*

As you become more fit, a higher intensity of exercise is required to create an overload and therefore provide continued improvement.

### *SPECIFICS*

Different forms of exercise produce different results. The type of exercise that is carried out is specific to the muscle groups being used and to the energy source involved. There is little transfer of the effects of exercise, i.e. from strength training to cardiovascular fitness. That is why it is important to have an exercise program tailored to your specific needs.

### *REVERSIBILITY*

If you stop exercising or do not do your program often enough, you will lose the benefits you have gained. Regular workouts are the key to success.

### *WARM-UP*

Every exercise program should start with a warm-up where the body is prepared for the effort to come. It should be gentle and preferably use the muscles group to be involved later. Stretching should be included in both your warm-up and cool down, and should be performed after 3-5 minutes of low intensity aerobic activity or calisthenic type exercise.

### *WARM DOWN OR COOL DOWN*

This involves a gradual decrease in the intensity of the exercise session. Following exercise, a large supply of blood remains in the working muscles. If it is not returned promptly to the central circulation, pooling of blood may occur in the muscles.

### *HEART RATE*

As you exercise, your heart beat increases. This is often used as a measure of the required intensity of an exercise. You need to exercise hard enough to condition your circulatory system, and increase your pulse rate, but not enough to strain your heart.

Your initial level of fitness is important when developing an exercise program for you. When starting, you can get a good training effect with a heart rate of 110-120 beats per minute (BPM). If you are more fit, you will need a higher threshold of stimulation.

To begin with, you should exercise at a level that elevates your heart rate to about 65 to 70% of your maximum. If you find this is too easy, you may want to increase it, but it is better to lean on the conservative side.

As a rule of thumb, the maximum heart rate is 220 minus your age. As you increase in age, your heart, like other muscles, loses some of its efficiency. Some of its natural loss is won back as fitness improves. The following table is a guide to those who are “starting fitness.”

Age Target Heart Rate	25	30	35	40	45	50	55	60	65
10 Second Count	23	22	22	21	20	19	19	18	18
Beats per Minute	138	132	132	126	120	114	114	108	108

### *PULSE COUNT*

The pulse count (on your wrist or carotid artery in the neck, taken with two index fingers) is done for ten seconds, taken a few seconds after you stop exercising. This is for two reasons: (a) 10 seconds is long enough for accuracy, (b) the pulse count is to approximate your BPM rate at the time you are exercising. Since heart rate slows as you recover, a longer count isn't as accurate.

The target is not a magic number, but a general guide. If you're above average with your fitness, you may work comfortably a little above that suggested for your age group. The following table is a guide.

Age Target Heart Rate	25	30	35	40	45	50	55	60	65
10 Second Count	26	26	25	24	23	22	22	21	20
Beats per Minute	156	156	150	144	138	132	132	126	120

Don't push yourself too hard to reach the figures on this table. It can be very uncomfortable if you over exercise. Let it happen naturally as you work through your program. Remember, the target is a guide, not a rule, a little above or below is just fine.

Two final comments: (1) don't be concerned with day to day variations in your pulse rate, being under pressure or not enough sleep can affect it; (2) your pulse rate is a guide, don't become a slave to it.



### *MUSCLE SORENESS*

For the first week or so, muscle soreness may be the only indication you have that you are on an exercise program. This, of course, does depend on your overall fitness level. A confirmation that you are on the correct program is a very slight soreness in most major muscle groups. This is quite normal and will disappear in a matter of days.

If you experience major discomfort, you may be on a program that is too advanced, or you have increased your program too rapidly.

If you experience PAIN during or after exercise, your body is telling you something. Stop exercising and consult your doctor.

### *WHAT TO WEAR*

Wear clothing that will not restrict your movement in any way while exercising. Clothes should be light enough to allow the body to cool. Excessive clothing that causes you to perspire more than you normally would gives you no advantage. The extra weight you lose is body fluid and will be replaced with the next glass of water you drink. Always wear a pair of athletic shoes.

### *BREATHING DURING EXERCISE*

Do not hold your breath while exercising. Breathe normally as much as possible. Remember, breathing involves the intake and distribution of oxygen, which feeds the working muscles.

### *REST PERIODS*

Once you start your exercise program, you should continue through to the end. Do not break off halfway through and then restart at the same place later on without going through the warm-up stage again. The rest period required between exercises may vary from person to person.

## SUGGESTED STRETCHES

### *Head Rolls*

Rotate your head to the right for one count while feeling the stretch up the left side of your neck. Next, rotate your head back for one count, stretching your chin to the ceiling. Rotate your head to the left for one count, and finally, drop your head to your chest for one count.

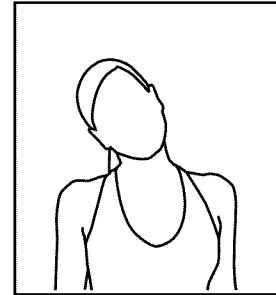

### *Shoulder Lifts*

Lift your left shoulder up toward your ear for one count. Then lift your right shoulder up for one count as you lower your left shoulder.

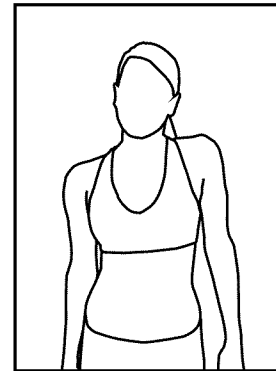

### *Side Stretches*

Open your arms to the side and continue lifting them until they are over your head. Reach your left arm as far upward as you can for one count. Feel the stretch up your left side. Repeat this action with your right arm.

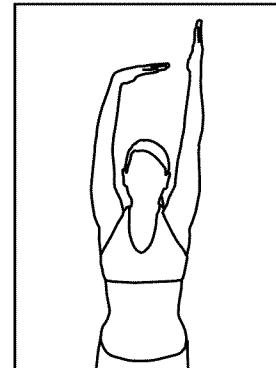

### *Quadriceps Stretch*

With one hand against a wall for balance, reach behind you and pull your left foot up. Bring your heel as close to your buttocks as possible. Hold for 15 counts and repeat with right foot up.

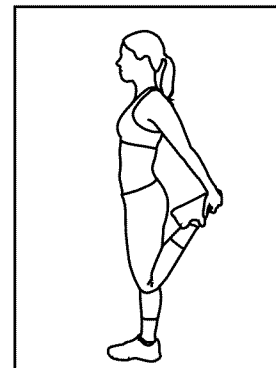

## SUGGESTED STRETCHES

### *Inner Thigh Stretch*

Sit with the soles of your feet together with your knees pointing outward. Pull your feet as close into your groin as possible. Gently push your knees towards the floor. Hold for 15 counts.

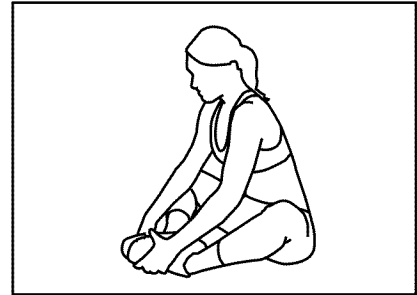

### *Toe Touches*

Slowly bend forward from your waist, letting your back and shoulders relax as you stretch toward your toes. Reach down as far as you can and hold for 15 counts.

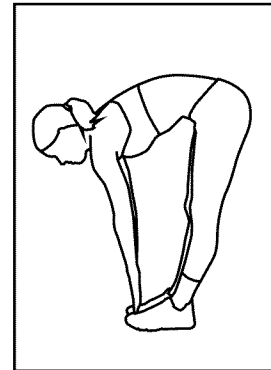

### *Hamstring Stretches*

Sit with your right leg extended. Rest the soles of your left foot against your right inner thigh. Stretch toward your toes as far as possible. Hold for 15 counts. Relax and then repeat with left leg extended.

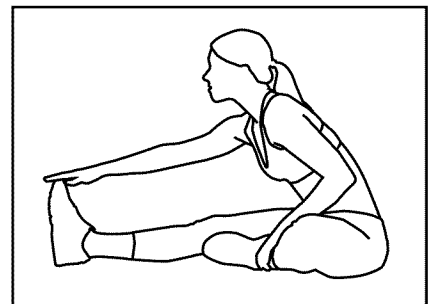

### *Calf/Achilles Stretches*

Lean against a wall with your right leg in front of the left and your arms forward. Keep your left leg straight and the right foot on the floor; then bend the right leg and lean forward by moving your hip toward the wall. Hold, then repeat on the other side for 15 counts.

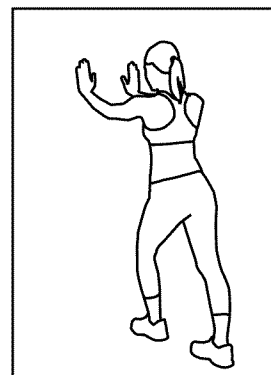

# ASSEMBLY INSTRUCTIONS & WARNING LABELS

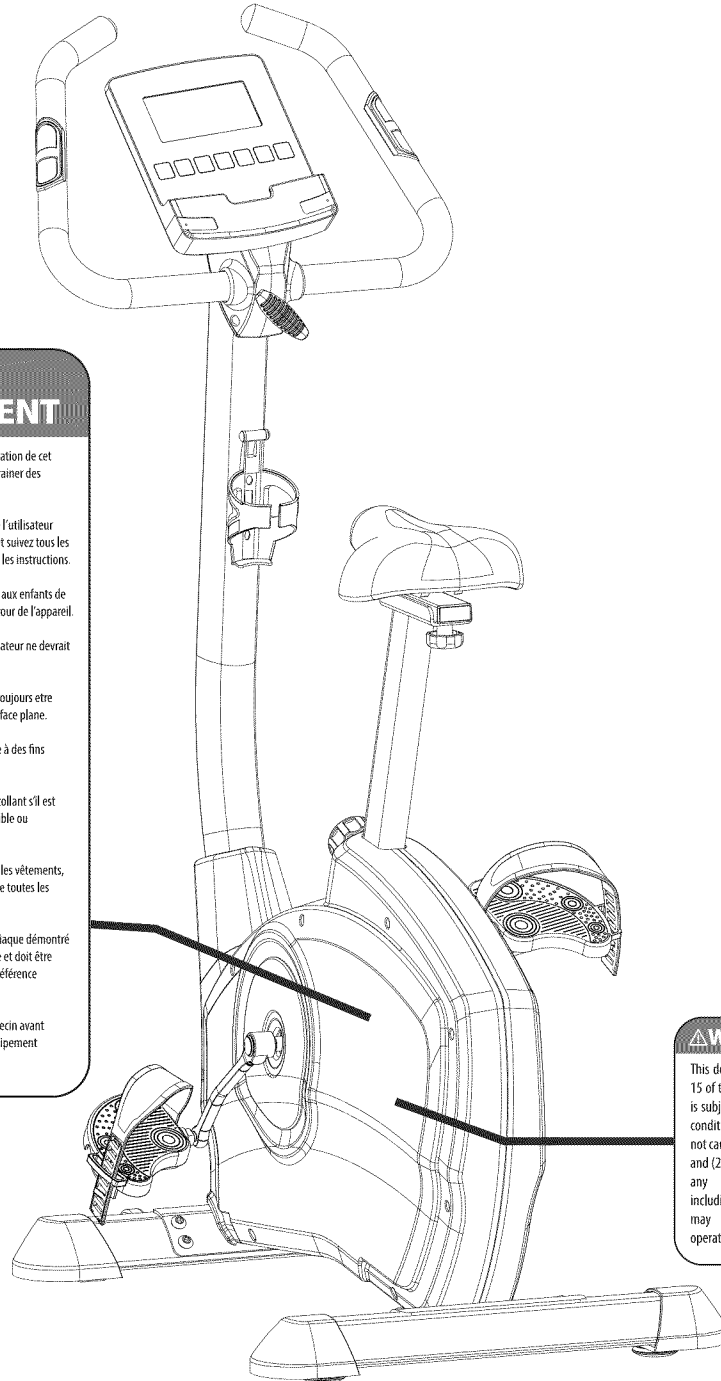

## ⚠ WARNING ⚠ AVERTISSEMENT

- Misuse of this machine may result in serious injury.
- Read user's manual prior to use and follow all warnings and instructions.
- Do not allow children on or around machine.
- User weight must not exceed 300lbs/136kgs.
- This products should always be used on a level surface.
- This product is not intended for therapeutic use.
- Replace label if damaged, illegible or removed.
- Keep body and clothing free and clear of all moving parts.
- The heart rate displayed may be inaccurate and should be used for reference only.
- Consult a physician prior to using any exercise equipment.
- La mauvaise utilisation de cet appareil peut entraîner des blessures graves.
- lisez le manuel de l'utilisateur avant utilisation et suivez tous les avertissements et les instructions.
- Ne permettez pas aux enfants de se tenir sur ou autour de l'appareil.
- Le poids de l'utilisateur ne devrait pas excéder 136.
- Cet appareil doit toujours être utilisé sur une surface plane.
- Ne pas faire usage à des fins thérapeutiques.
- Remplacez l'autocollant s'il est endommagé, illisible ou manquant.
- Garder le corps et les vêtements, libre et éloigner de toutes les pièces mobiles.
- La fréquence cardiaque démontré peut être inexacte et doit être utilisé à titre de référence seulement.
- Consulter un médecin avant d'utiliser tout équipement d'exercice.

## ⚠ WARNING ⚠ AVERTISSEMENT

This device complies with Part 15 of the FCC Rules. Operation is subject to the following two conditions: (1) This device may not cause harmful interference, and (2) this device must accept any interference received, including interference that may cause undesired operation.

Cet appareil conforme avec Article 15 des règlements de FCC. Le fonctionnement est soumis au 2 conditions suivantes: (1) Cet appareil ne peut pas causer des interférences nuisible, et (2) cet appareil doit accepter toutes les interférences reçues, y compris les interférences qui peuvent causer l'opération indésirable.

## STEP 1

Attach the Front Stabilizer (J) to the Main Frame (G-26) using two Bolts (N-8) and Flat Washers (N-7). Attach the Rear Stabilizer (I) to the Main Frame (G-26) using two Bolts (N-8) and Flat Washers (N-9). Tighten the bolts with the Allen Key (N-11).

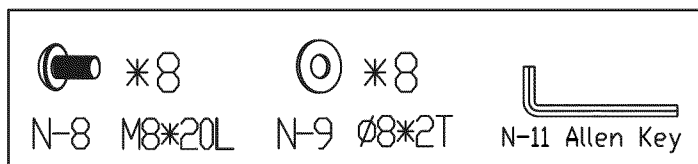
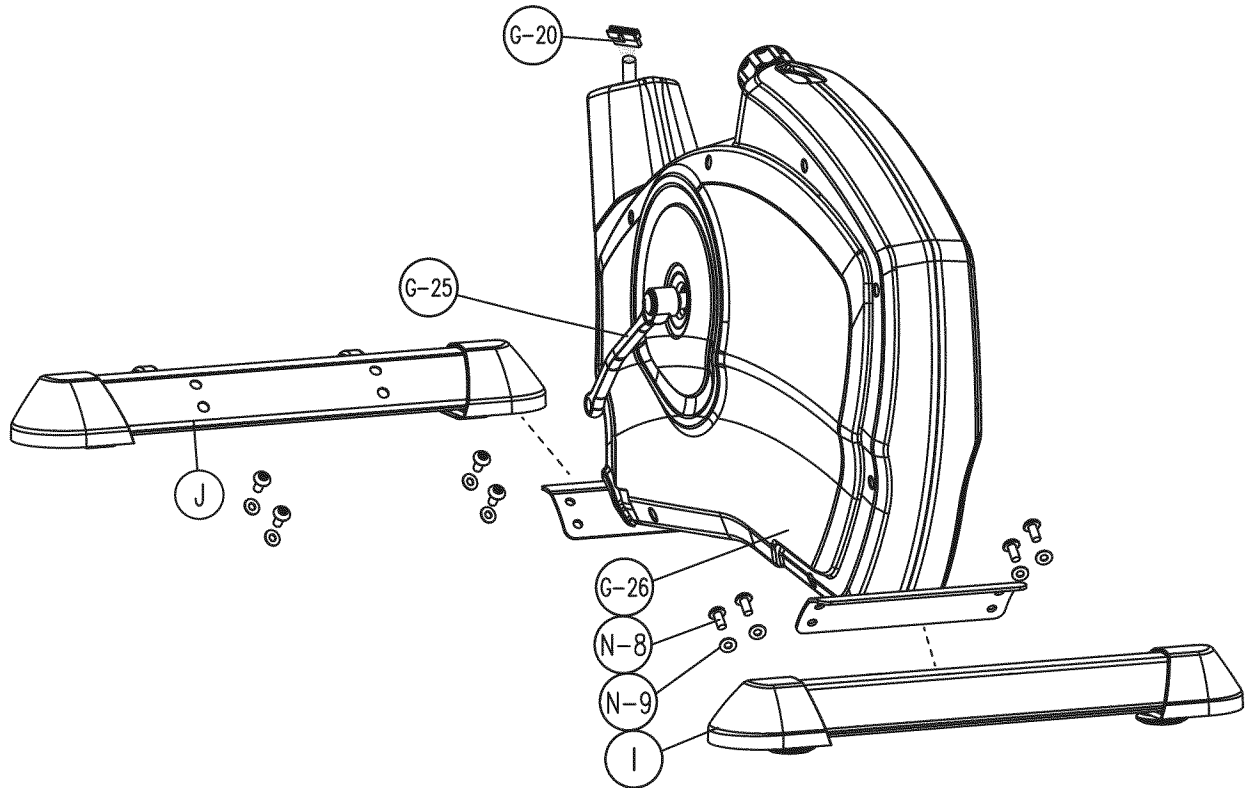

## STEP 2

1. Install the Right Pedal (G-4R) onto the right crank by turning clockwise. Install the Left Pedal (G-4L) onto the left crank by turning counter-clockwise. Use N-10 Screw Driver provided to tighten pedals securely.
2. Make sure Knob (C-9) is loosened, then pull the knob out and insert Seat Post (K) into the Main Frame (G-26). Choose the desired position and released the knob, adjust up or down until you hear a "click", then tighten the knob to secure the position.
3. Slide the Seat (G-12) onto the Seat slider (L). The seat can be adjusted to different angles. Tighten the two Nuts under the Seat using the box spanner (N-12). In addition, the Slider can be adjusted horizontally by loosening the knob below the Seat Slider and slide the Seat Slider to the desired position. Tighten the knob after setting the desired position.

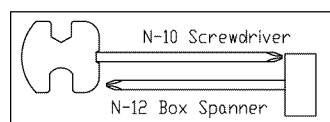
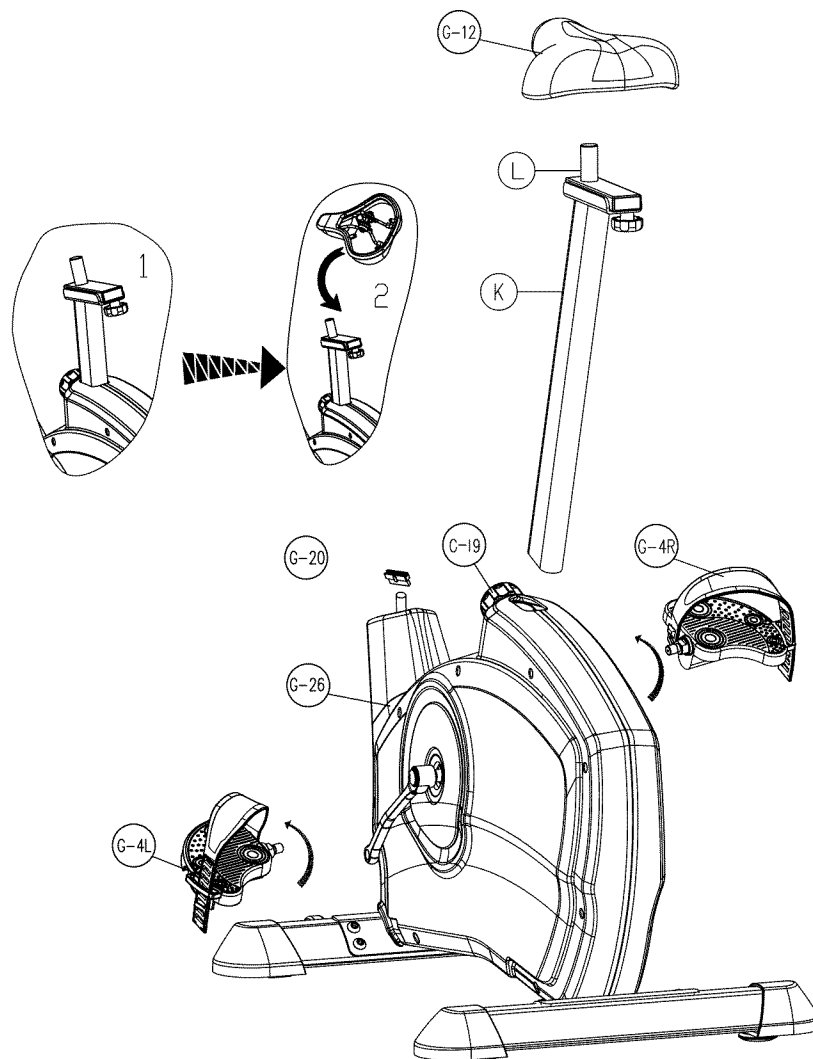

### STEP 3



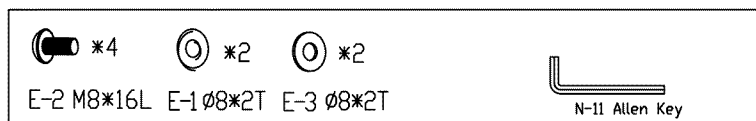
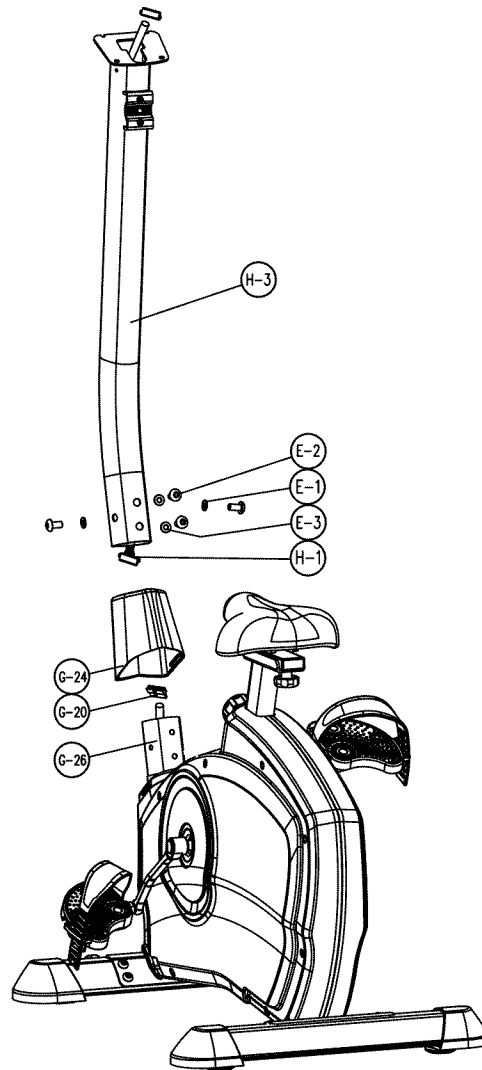

1. Remove the Bolts (E-2) and Flat Washers (E-1) from the Main Frame (G-26)
2. Take the Handlebar Post Cover (G-24) and slide it onto Handlebar Post (H)
3. Hold the Handlebar post (H-3) and connect the Lower computer cable (G-20) to the Upper Computer Cable (H-1)
4. Slide the Handlebar Post (H-3) into the Main frame (G-26) - align the holes then insert Bolts (E-2), Flat Washers (E-1) and Curved Washers (E-3). Tighten the screws to secure the Handlebar Post (H-3) with Allen key (N-11). Slide the Handlebar Post Cover (G-24) down to cover the screws.

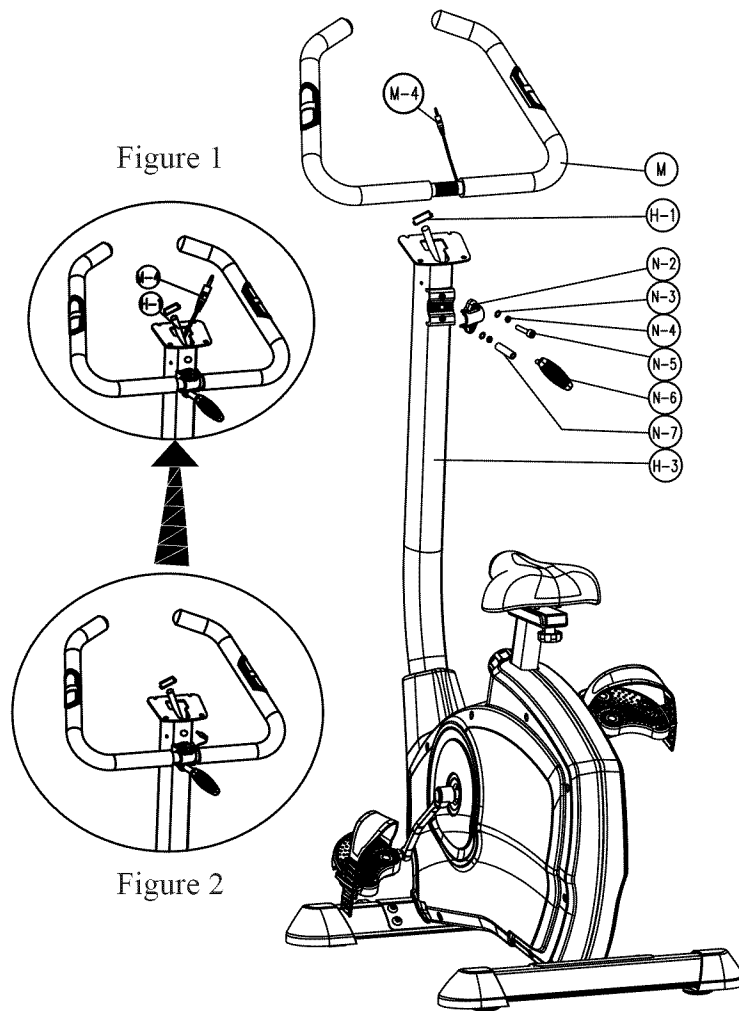

### STEP 4

1. Attach the Handlebar (M) to the Handlebar Post (H-3) using the Main Clamp (N-2). Attach firmly with one Flat Washer (N-3), one Spring Washer (N-4) and one Fixing Bolt (N-5).
2. Attach the Handlebar T-Knob (N-6) using one set of Flat Washer (N-3), Spring Washer (N-4) and one Bushing (N-7).
3. Pass the Hand-Pulse Wire (M-4) through the hole in the Handlebar Post (H-3) - See Figure 1 & 2.

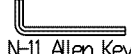
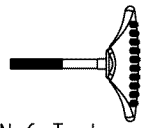

 *2	 *2		
N-3 $\varnothing 7 * \varnothing 12 * 1T$	N-4 $\varnothing 7 * 2T$		
 *1	 *1	 *1	 N-11 Allen Key
N-7 $\varnothing 7 * \varnothing 12 * 40$	N-5 M7	N-2	 N-6 T-shape knob M7*65L(1)



## STEP 5

1. Connect the Computer Cables (H-1) and hand pulse wire (M-4) to computer (A). Then attach the Computer (A) to the Computer bracket with the enclosed Screws (A-1).
2. Remove the pre-installed Screws (H-2) on the handlebar post and set aside.
3. Pass the R/L Cover (M-6 & M-7) through the Handlebar (M).
4. Attach the Right and Left cover (M-6 & M-7) using Screws (H-2) and Screws (H-1).
5. Take the pre-installed Screws (H-2) from the handlebar post, and then assemble the Bottle cage (H-4) with Screws (H-2).

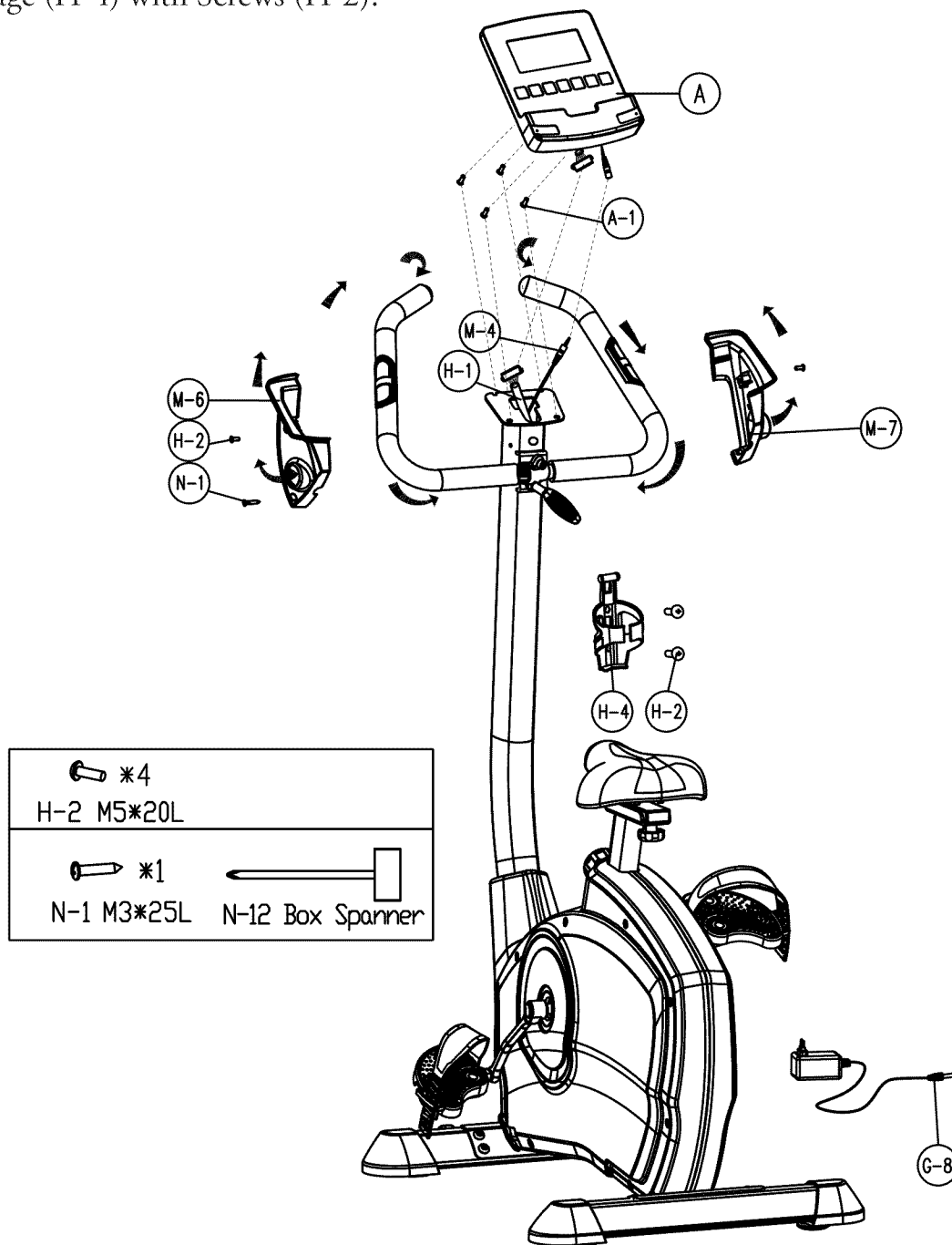

# EXPLODED VIEW DRAWING

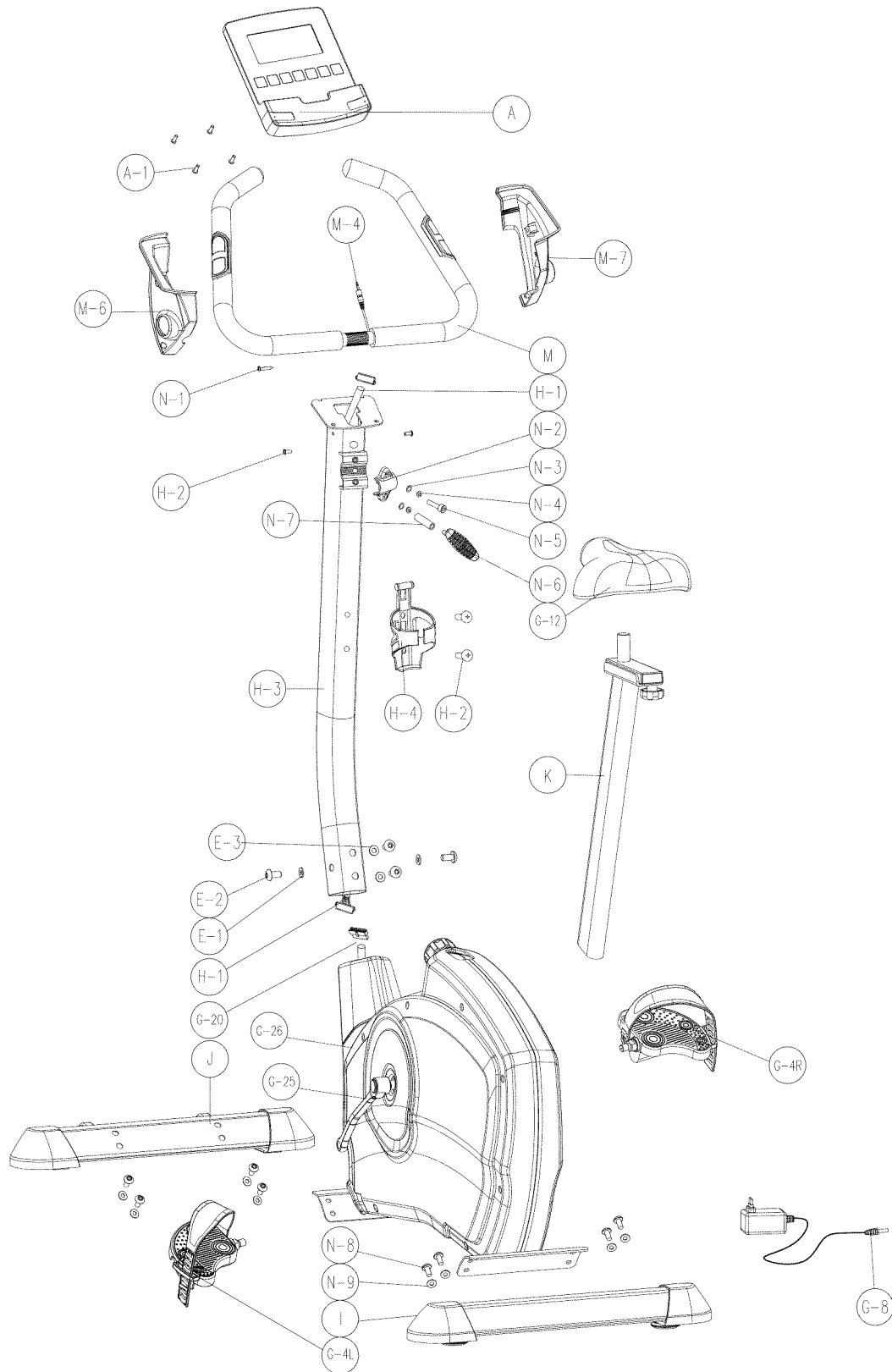

# EXPLODED VIEW DRAWING

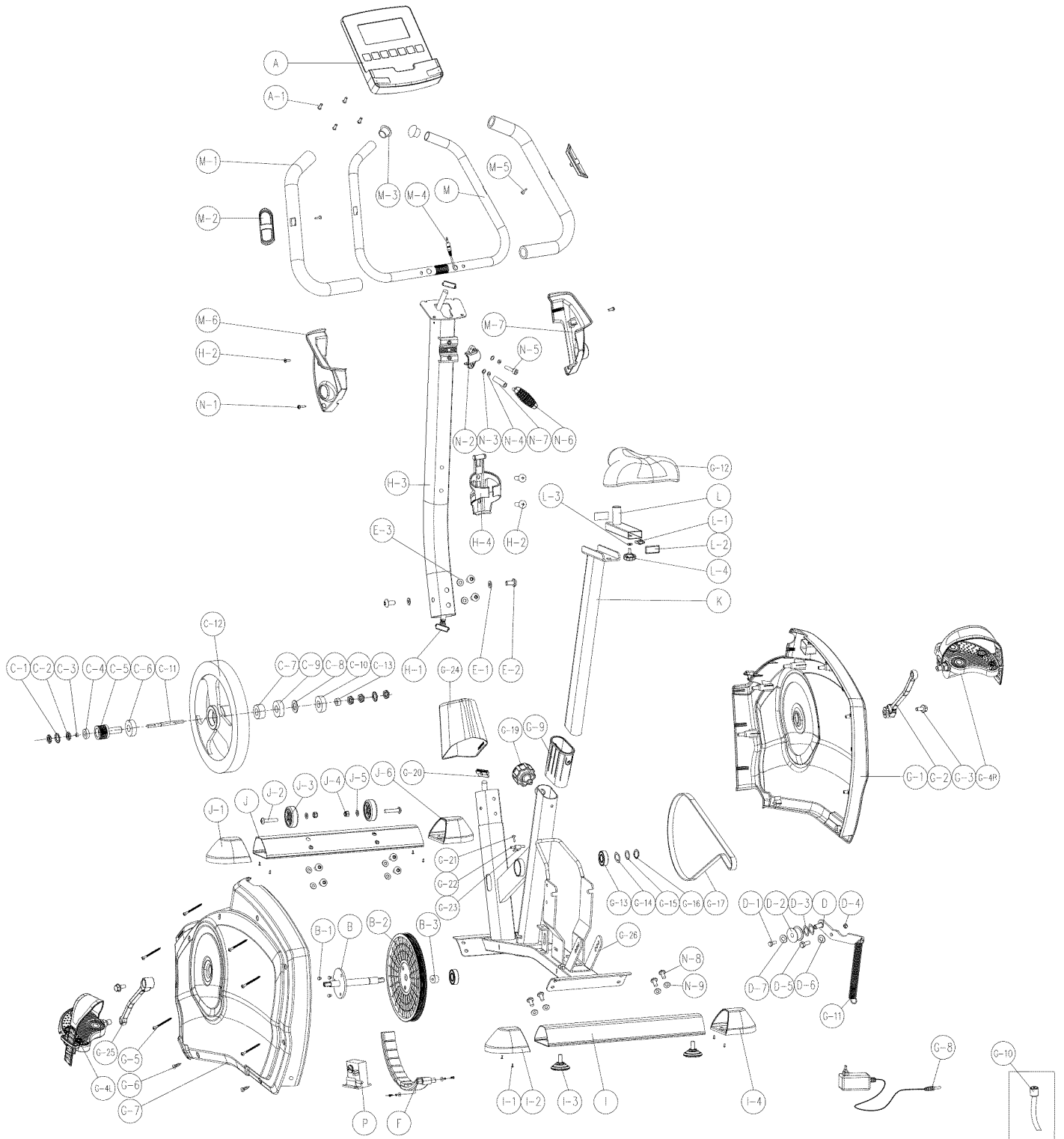

## PARTS LIST

**To order replacement parts: provide your customer service representative with the product model number and the part number located on the Parts List below, along with the quantity you require.**

No	Description	Qty
S1Ui-A	Computer and screw	1
S1Ui-A-1	Screw for fixing computer	4
S1Ui-B	Shaft	1
S1Ui-B-1	Screw M8xP1.25x12L	3
S1Ui-B-2	Big Pulley	1
S1Ui-B-3	Bushing	1
S1Ui-C	Flywheel assembly set	1
S1Ui-C-1	Star washer	2
S1Ui-C-2	Nut	5
S1Ui-C-3	Bushing	1
S1Ui-C-4	Bearing 6900RS	1
S1Ui-C-5	Small pulley	1
S1Ui-C-6	Bearing 6203RS	1
S1Ui-C-7	One way bearing	1
S1Ui-C-8	Flat washer	1
S1Ui-C-9	Bearing 6003RS	1
S1Ui-C-10	Bearing 6300RS	1
S1Ui-C-11	Axle for flywheel	1
S1Ui-C-12	Flywheel	1
S1Ui-C-13	Bushing	1
S1Ui-D	Idler wheel assembly set	1
S1Ui-D-1	Hex. Bolt	1
S1Ui-D-2	Idler wheel	1
S1Ui-D-3	Wave washer $\phi 10.5 \times \phi 15 \times 0.3t$	2
S1Ui-D-4	Nylon nut M8	1
S1Ui-D-5	Hex. Bolt	1
S1Ui-D-6	Flat washer	1
S1Ui-D-7	Flat washer	1
S1Ui-E-1	Flat washer $\phi 8 * \phi 19 * 2T$ for handlebar post	2
S1Ui-E-2	Allen bolt M8*P1.25*16L for handlebar post	4
S1Ui-E-3	Curve washer, $\phi 8 \times \phi 19 \times 2t$	2
S1Ui-F	Magnet Brake assembly	1
S1Ui-G-1	Right chain cover	1
S1Ui-G-2	Crank ( R )	1
S1Ui-G-3	Nylon screw M8xP1.0x20L	2
S1Ui-G-4	Pedal	1
S1Ui-G-5	Screw M4x40L	6

No.	Description	Qty
S1Ui-G-21	Screw, M4*10L	1
S1Ui-G-22	Sensor box	1
S1Ui-G-23	Sensor holder	1
S1Ui-G-24	Cover for handlebar post	1
S1Ui-G-25	Crank ( L )	1
S1Ui-G-26	Mainframe	1
S1Ui-H	Handlebar post	1
S1Ui-H-1	Upper cable	1
S1Ui-H-2	Screw M5x20	4
S1Ui-H-3	Handlebar post	1
S1Ui-H-4	Bottle cage	1
S1Ui-I	Rear stabilizer	1
S1Ui-I-1	Screw 3/8"	4
S1Ui-I-2	End cap ( R ) for rear stabilizer	1
S1Ui-I-3	Adjusting pads for stabilizer	2
S1Ui-I-4	End cap ( L ) for rear stabilizer	1
S1Ui-J	Front stabilizer	1
S1Ui-J-1	End cap ( L ) for front stabilizer	1
S1Ui-J-2	Allen bolt M8xP1.25x40L for front stabilizer	2
S1Ui-J-3	Transport wheel for front stabilizer	2
S1Ui-J-4	Nylon nut M8 for front stabilizer	2
S1Ui-J-5	Flat washer $\phi 8 * \phi 19 * 2T$ for front stabilizer	2
S1Ui-J-6	End cap ( R ) for front stabilizer	1
S1Ui-K	Seat post	1
S1Ui-L	Seat slider	1
S1Ui-L-1	Bolt 7/16" for seat slider	1
S1Ui-L-2	Cap for seat slider	2
S1Ui-L-3	Flat washer $\phi 14.3 \times \phi 25 \times 2.0t$	1
S1Ui-L-4	Knob for seat slider	1
S1Ui-M	Handlebar	1
S1Ui-M-1	Form grip	2
S1Ui-M-2	Hand pulse	2
S1Ui-M-3	Cap $\phi 7/8$ " for4 handlebar	2
S1Ui-M-4	Pulse cable for hand pulse	1
S1Ui-M-5	Screw M4x20L	2
S1Ui-M-6	Left cover for computer	1
S1Ui-M-7	Right cover for computer	1

## PARTS LIST CONTINUED

No.	Description	Qty
S1Ui-G-6	Screw M5x16L	4
S1Ui-G-7	Left chain cove	1
S1Ui-G-8	Adaptor	1
S1Ui-G-9	Seat post sleeve, black, EB600	1
S1Ui-G-10	DC cable	1
S1Ui-G-11	Spring for idler	1
S1Ui-G-12	Seat	1
S1Ui-G-13	Bearing for Frame	2
S1Ui-G-14	Wave washer $\phi 17.5 \times \phi 25 \times 0.3t$	1
S1Ui-G-15	Flat washer $\phi 17.5 \times \phi 25 \times 0.3t$	1
S1Ui-G-16	C type ring $\phi 17$	1
S1Ui-G-17	Belt	1
S1Ui-G-19	Seat knob	1
S1Ui-G-20	Computer cable, lower section	1

No.	Description	Qty
S1Ui-N	Bolts & nuts pack	1
S1Ui-N-1	Screw	1
S1Ui-N-2	Metal clamp	1
S1Ui-N-3	Flat washer	2
S1Ui-N-4	Spring washer	2
S1Ui-N-5	Screw	1
S1Ui-N-6	T knob	1
S1Ui-N-7	Bushing	1
S1Ui-N-8	Allen bolt M8xP1.25x20L	8
S1Ui-N-9	Flat washer	8
S1Ui-N-10	Wrench	1
S1Ui-N-11	Hex wrench	1
S1Ui-N-12	Bushing wrench	1
S1Ui-P	Gear box	1
	$\phi$ =Diameter	

# CONSOLE OPERATIONS

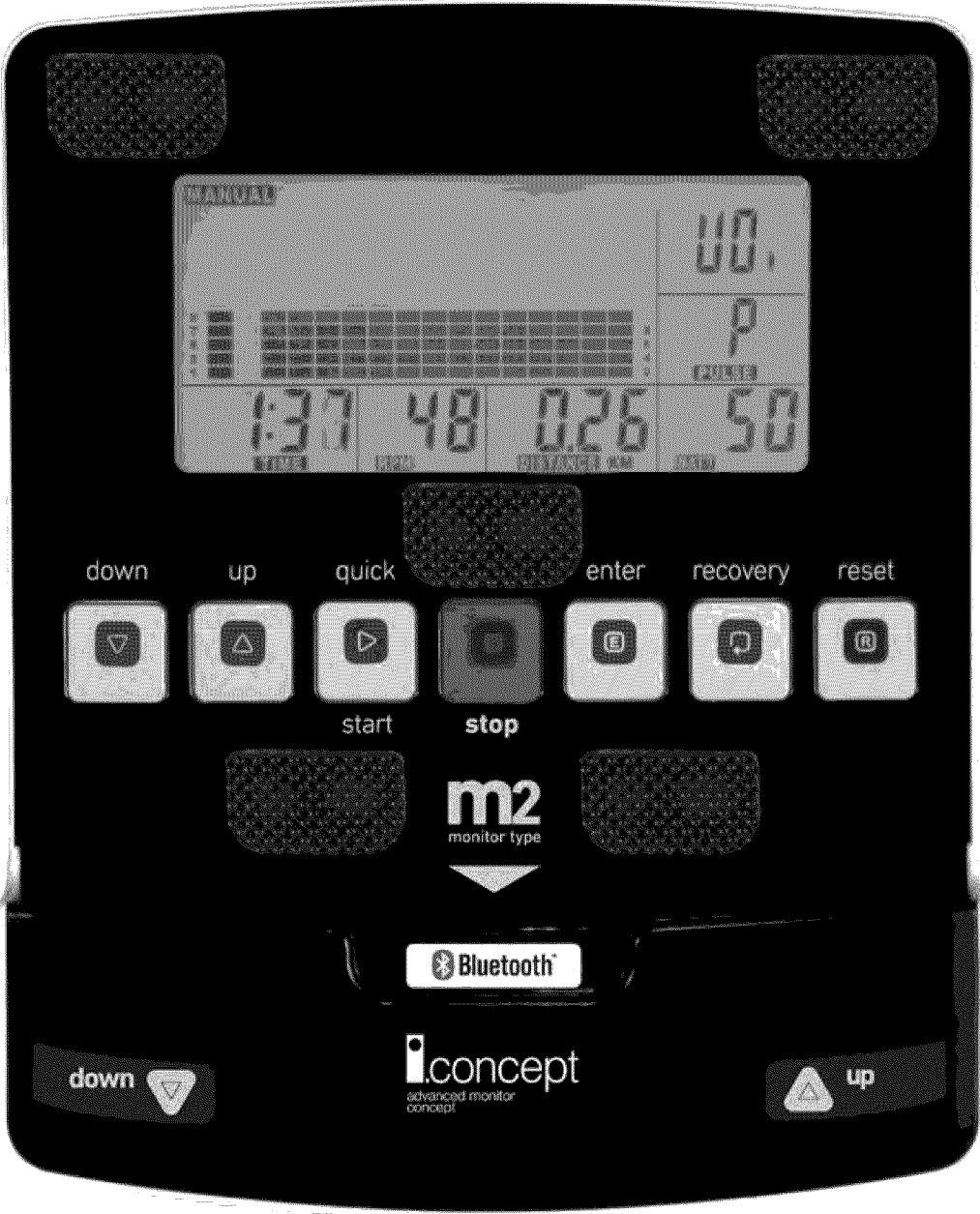

## **SPECIFICATIONS:**

ENTER	To confirm all setting values
RESET	To reset all parameters to default value
START/STOP	To start or stop training
UP	To make upward setting change
DOWN	To make downward setting change
RECOVERY	In stop or start mode, pressing this button will start Heart Rate recovery status measurement. Time will count down from 60 seconds
QUICK START	Starts the machine without any preset program or data from user

## **FUNCTION:**

TIME	Displays the workout time while exercising
SPEED	Displays the current speed
DISTANCE	Accumulated distance while exercising
PULSE	30-240 BPM
CALORIES	Counts calories while exercising
RPM	Displaying crank speed in revolutions per minute

## **GETTING STARTED - OPERATING PROCEDURE:**

Start pedaling and the console will turn on. Use the UP/DOWN buttons to set up your user data by selecting any user U0-U4. Press the ENTER button to accept user selection. Press UP/DOWN buttons to toggle between genders. Press ENTER to accept. Use the UP/DOWN to set AGE then press ENTER. Use the UP/DOWN buttons to enter height in inches and press ENTER to accept. Use the UP/DOWN buttons to input weight then press ENTER to select.

## **1. MANUAL MODE**

User may preset their own resistance level from 1 to 24 by pressing the UP/DOWN buttons. The default resistance level is 1. Press ENTER to confirm. Using the UP/DOWN buttons enter values for TIME, DISTANCE, CALORIES, PULSE, and then press START to begin your workout.

## **2. PROGRAM MODE**

There are 12 preset programs. Use the UP/DOWN buttons to select the desired program profile, then press the ENTER button to confirm. Use the UP/DOWN buttons to adjust the resistance level. Press ENTER to confirm. Enter values for TIME, DISTANCE, CALORIES, PULSE, and then press START/STOP to begin your workout.

## **3. FITNESS TEST**

Use the UP/DOWN buttons to select FITNESS and press ENTER. Press START/STOP to start the test. The user has to achieve the greatest distance possible in 8 minutes. When the time is up, the electronic device will work out the difference and your fitness rating will be displayed up on the screen: «F1, F2,..., F5, F6»; where «F1» is the best «Excellent» and «F6» the worst «Very Poor».

## **4. PERSONAL MODE**

Users may create their own profile in this mode. The first segment of the profile will start blinking. Use the UP/DOWN buttons to adjust resistance level for each segment. Once all 16 segments have been entered press the ENTER button to confirm. Press START/STOP to begin your workout.

## **5. WATT CONTROL MODE**

Enter values for TIME, DISTANCE, CALORIES, PULSE, and then press START/STOP to begin your workout. User may set the Watt value by pressing the UP/DOWN buttons to change in 10 Watt increments.

## **6. HRC MODE**

Input personal data: SEX, AGE, HEIGHT and WEIGHT.

User may select different target Heart Rate from 55%, 75%, 90% and TARGET by using the UP/DOWN buttons. Press ENTER to confirm. Then, enter values for TIME, DISTANCE, CALORIES, and then press START/STOP to begin your workout.

## **7. RANDOM MODE**

Use the UP/DOWN buttons to select the RANDOM function and press ENTER. Input



values for TIME, DISTANCE, and CALORIES. You will see a random program profile. Press START/STOP to start the exercise. The duration of the program graph is 16 minutes, divided into sixteen segments. To program time, distance and/or calories, go through the following procedure: Once the program has been selected and before pressing the START/STOP button, press the ENTER button to program the time using the UP/DOWN buttons. In this case the time will be divided into sixteen segments. Press the ENTER button to program the distance. Press ENTER again to program the calories. Press START/STOP to start the exercise. You can vary the exertion level during the exercise by pressing the UP/DOWN buttons. NOTE: The monitor will shut off if the machine is without use for more than 90 seconds.

### **HAND-GRIP PULSE MEASUREMENT INSTRUCTIONS**

On this model the pulse rate is measured by placing both hands on the hand grip sensors, located on the handlebar. When both hands are placed on the hand grip sensors the heart symbol on the righthand side of the screen, marked PULSE, will begin to flash and after 10-15 seconds a heart rate reading will be displayed. If both hands are not placed correctly then the pulse function will not work. If a «P» appears on the screen or the heart symbol does not flash, make sure that both hands completely touch the metal portions of the grips.

### **TEST MEASUREMENTS:**

This monitor is equipped with a recovery test function. This offers you the advantage of being able to measure how long it takes your heart rate to recover after having finished the exercise. Upon finishing the exercise leave your hands on the pulse sensors and press the «Recovery» button, this will start a one minute countdown. Only the Time and Pulse rate function read-outs will remain displayed. The electronic device will measure your pulse rate during this minute. The heart rate recovery time will be displayed on the heart rate line. If, at any time during this minute, you decide to abandon this test then press the «Recovery» button and this will take you back to the main screen. When the minute is up, the monitor will work out the difference and your fitness rating will be displayed on the screen: «F1, F2,..., F5, F6»; where «F1» is the best (fitness «Excellent») and «F6» the worst (fitness «Very Poor»). Pressing the RECOVERY button will take you back to the main screen, where the functions will be in the same mode as when the test began. The comparison between the exercised heart rate and the recovery heart rate provides a fast, simple method of gauging how fit you are. Your fitness rating is a guideline that shows you how fast your heart recovers after physical exertion. If you exercise regularly then you will see your fitness rating improve. The test does not work unless you continuously hold the grips for 1 minute.

# CONSOLE PROGRAMS

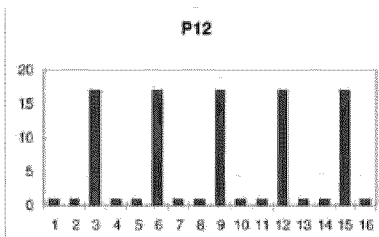
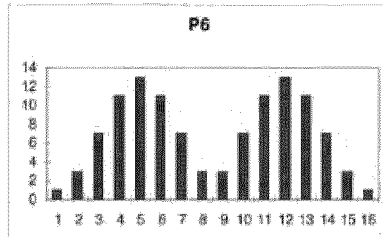
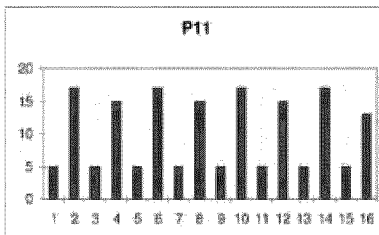
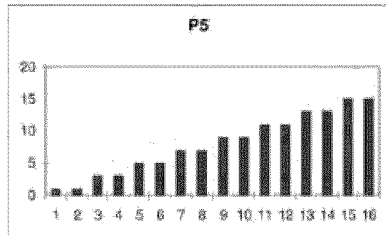
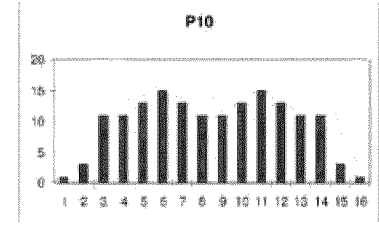
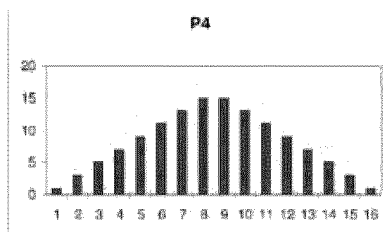
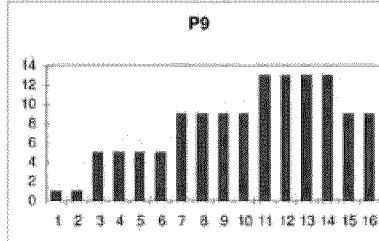
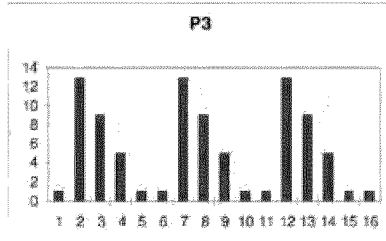
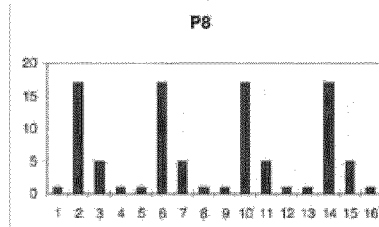
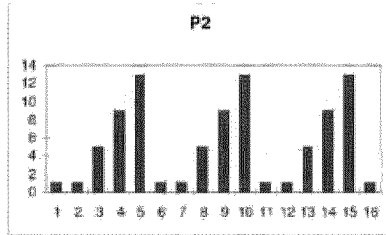
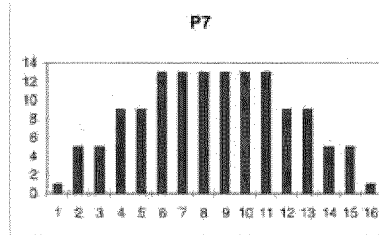
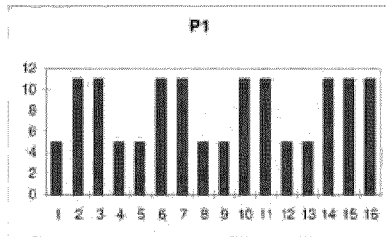

## DOWNLOADING APPS AND PAIRING YOUR DEVICE WITH YOUR EQUIPMENT

### DOWNLOADING THE SOFTWARE

Connect the Apple device with the App Store (iTunes) or your Android Device with Google Play, search for "Pafers", then read the APP introductions and Download the APPs with bicycle/elliptical machine functions to your device, for example Pedal Monitor or other applicable apps. *Note: if you download an APP for a treadmill and pair it with an Elliptical it will not work.*

- The App uses bluetooth mode, so please make sure the recumbent and device you are using has bluetooth function.
- The App contains the following functions, the user must open the 3G network or wi-fi network:

(a) Managing Data - After completing the registration in the "Pafers" App, log on to your personal account. Now that you have registered you can record all of your workout data and save it to your device.

(b) Some APPs need connection to Google maps in order to function correctly.

### PAIRING THE BLUETOOTH DEVICE WITH AN APPLE DEVICE

1. Place the Apple Device on the area in front of the LCD screen.
2. Enter into settings and turn Bluetooth on.
3. Your Apple Device will detect all Bluetooth devices within range (following on screen instructions), click on the appropriate bluetooth device name and confirm your connection.
4. After paired successfully, please start the APP within 2 minutes, if you do not, Bluetooth will automatically cancel the pairing. Please keep the Apple Device within a range of 2 meters for best quality connection. If you see "not connected," please perform the above steps again.
5. Press the Apple Device home button, the screen will return to the desktop.
6. Start the APP you downloaded. When the APP connects with the equipment successfully, the APP screen buttons will unlocked. Start from APP interface using a variety of modes to control the exercise equipment. Pay attention to the APP instructions and function introduction. If you have need help with the APP, please browse the APPs download page description or contact Pafers for instructions.
7. When you are done using the APP, please press the HOME button on the Apple Device twice to close the APP.

## PAIRING THE BLUETOOTH DEVICE WITH AN ANDROID DEVICE

1. Place the Android Device on the area in front of the LCD screen.
2. Enter into settings and turn Bluetooth on.
3. Your Android Device will detect all Bluetooth devices within range (following on screen instructions), click on the appropriate bluetooth device name and confirm your connection.
4. After paired successfully, please start the APP within 2 minutes, if you do not, Bluetooth will automatically cancel the pairing. Please keep the Android Device within a range of 2 meters for best quality connection. If you see “not connected,” please perform the above steps again.
5. Press the Device home button, the screen will return to the desktop.
6. Start the APP you downloaded. When the APP connects with the equipment successfully, the APP screen buttons will unlocked. Start from APP interface using a variety of modes to control the exercise equipment. Pay attention to the APP instructions and function introduction. If you have need help with the APP, please browse the APPs download page description or contact Pafers for instructions.
7. When you are done using the APP, please press main screen button on the Android Device twice to close the APP.

## COMPATIBLE DEVICES

### **Android**

Bluetooth & App Enabled Android Device

### **Apple Products**

iPod touch (4th generation)	iPod touch (3rd generation)
iPhone 5	iPhone 4S
iPhone 4	Mini iPad
iPad	iPad 2

BH Fitness i.Concept Bluetooth products are compatible with Apple devices with iOS 5.1 or later. It is recommended to update iOS to latest version to obtain the best user experience.

iPad, iPhone, iPod, iPod classic, iPod nano, iPod shuffle, and iPod touch, is a registered trademark of Apple, Inc., in the United States and other countries.

“Made for iPod,” “Made for iPhone,” and “Made for iPad” mean that an electronic accessory

has been designed to connect specifically to iPod, iPhone, or iPad, respectively, and has been certified by the developer to meet Apple performance standards. Apple is not responsible for the operation of this device or its compliance with safety and regulatory standards. Please note that the use of this accessory with iPod, iPhone, or iPad may affect wireless performance. iPad, iPhone, iPod, iPod classic, iPod nano, iPod shuffle, and iPod touch are trademarks of Apple Inc., registered in the U.S. and other countries.

## **MAINTENANCE AND CLEANING**

Care has been taken to assure that your equipment has been properly adjusted and lubricated at the factory. It is not recommended that the user attempt service on the internal components. Instead, seek service from an authorized service center. However, you may clean the outer surface. Use a soft cloth, dampened with warm water. Do not use aerosol sprays or pump bottles as they may deposit sediments upon the console surface. The use of harsh chemicals will destroy the protective coating and cause a static build-up that may damage the some of the components.

## WARRANTY

### LIMITED RESIDENTIAL WARRANTY

BH Fitness will repair or replace, free of charge, at its option, parts that are defective as a result of material or workmanship. Lifetime replacement warranty coverage on frame and motor. Three (3) year on other parts. Labor warranty coverage is one (1) year. Warranty covers the original consumer purchaser only.

### THIS WARRANTY DOES NOT COVER

- Pre-delivery set-up.
- Components that require replacement due to dirt or lack of regular maintenance.
- Expendable items which become worn during normal use.
- Repairs necessary because of operator abuse or negligence or the failure to operate and maintain the equipment according to the instructions contained in the Owner's Manual.

Register your product warranty easily online at: [www.BHfitnessusa.com](http://www.BHfitnessusa.com)

**FOR WARRANTY REPAIRS, PLEASE DO NOT TAKE YOUR MACHINE  
BACK TO THE RETAIL STORE. CONTACT BH FITNESS FIRST.**

BH Fitness/BH North America Corporation

20155 Ellipse

Foothill Ranch, CA 92610

Phone: 949.206.0330; Toll Free: 866.325.2339; Fax: 949.206.0013

Email: [fitness@bhnorthamerica.com](mailto:fitness@bhnorthamerica.com)

Web: [www.BHfitnessusa.com](http://www.BHfitnessusa.com)

Mon - Fri 8am - 5pm PST