

BLADEZ[®]

T500i



OWNER'S MANUAL

Important: Read all instructions carefully before using this product. Retain this owner's manual for future reference.

**FOR SERVICE PLEASE CONTACT BLADEZ FITNESS
TOLL FREE: 866-325-2339**

BLADEZ[®]

TABLE OF CONTENTS

Title	Page
Introduction	03
Safety Information	04
Exercise Instruction	05
Training Guidelines	06
Suggested Stretches	10
Assembly Instructions	12
Maintenance and Cleaning	16
Exploded View Drawing	17
Parts List	19
Console Operations	20
Warranty	34

CONGRATULATIONS

Congratulations on your purchase of Bladez Fitness equipment. We hope you appreciate the style, quality, and value that exercisers around the world have come to expect from Bladez Fitness.

If you have any questions, concerns or product issues please call our Customer Service Team at 1-866-325-2339 or email us at CustomerSupport@BHNorthAmerica.com.

Carefully read through the instructions contained in this manual. They provide you with important information about assembly, safety, fitness and use of the machine. Please read ALL the safety information contained on the following page.

SAFETY INFORMATION

PRECAUTIONS

This equipment has been designed and constructed to provide maximum safety. Nevertheless, certain precautions should be taken when using exercise equipment. Read the whole manual before assembling and using the machine. Please observe the following safety precautions:

1. Keep children and pets away from this equipment at all times. DO NOT leave them unsupervised in the room where the machine is kept.
2. If you experience dizziness, nausea, chest pains or any other symptoms while using this machine STOP EXERCISING AND SEEK IMMEDIATE MEDICAL ATTENTION!
3. Use the machine on a level and solid surface. Adjust the feet for stability.
4. Keep your hands away from any of the joints and moving parts.
5. Wear clothing suitable for doing exercise. Do not wear baggy clothing that might get caught in the machine. Always wear athletic shoes when using the machine and tie the laces securely.
6. This machine must only be used for the purposes described in this manual. DO NOT use accessories that are not recommended by Bladez Fitness. Read the manual prior to use and follow all warnings and instructions.
7. Do not place sharp objects near the machine.
8. Any person with physical or coordination limitations should not use the machine without the assistance of a qualified person or doctor. Misuse of this machine may result in serious injury.
9. Do warm-up stretching exercises before using the equipment.
10. Do not use the machine if it is not working correctly.
11. Before using the machine, thoroughly inspect the equipment for proper assembly.
12. Keep a perimeter of 3 feet (1 meter) around the machine before operating the equipment.
13. Use only authorized and trained technicians if a repair is needed.
14. Please follow the advice for correct training, as detailed in the Training Guidelines.
15. Use only the tools provided to assemble this machine.
16. Replace warning labels if damaged, illegible or removed.
17. This machine was designed for a maximum user weight of 350 lbs (158.7 kg)
18. The machine can only be used by one person at a time.
19. WARNING! The heart rate monitoring systems may be inaccurate. Over exercising may result in serious injury or death. If you feel faint stop exercising immediately.

Caution: Consult your doctor before beginning to use the machine or any exercise program. Read all of the instructions before using any exercise equipment.

KEEP THESE INSTRUCTIONS SAFE FOR FUTURE USE.

EXERCISE INSTRUCTION

Use of the machine offers various benefits; it can improve fitness, muscle tone and when used in conjunction with a calorie controlled diet, it can help you lose weight.

1. Consult your doctor before starting any exercise program. It is advisable to undergo a complete physical examination.
2. Work at the recommended exercise level. Do not over exert yourself.
3. If you feel any pain or discomfort, stop exercising immediately and consult your doctor.
4. Wear appropriate clothing and footwear for the exercise; do not wear loose clothing; do not wear leather soled shoes or footwear with high heels.
5. It is advised that you do warm-up stretches before working out.
6. Get on the equipment slowly and securely.
7. Select the program or workout option that is most closely aligned with your workout interests.
8. Start slowly and work your way up to a comfortable pace.
9. Be sure to cool down after your workout.

TRAINING GUIDELINES

Exercise is one of the most important factors in the overall health of an individual. Listed among its benefits are:

- Increased capacity for physical work (strength endurance)
- Increased cardiovascular (heart and arteries/veins) and respiratory efficiency
- Decreased risk of coronary heart disease
- Changes in body metabolism, e.g. losing weight
- Delaying the physiological effects of age
- Reduction in stress, increase in self-confidence, etc.

There are several components of physical fitness and each is defined below.

STRENGTH

The capacity of a muscle to exert a force against resistance. Strength contributes to power and speed.

MUSCULAR ENDURANCE

The capacity to exert a force repeatedly over a period of time, e.g. it is the muscular endurance of your legs to carry you 10 km without stopping.

FLEXIBILITY

The range of motion of your joints. Improving flexibility involves the stretching of muscles and tendons to maintain or increase suppleness, and it provides increased resistance to muscle injury or soreness.

CARDIO-RESPIRATORY ENDURANCE

The most essential component of physical fitness. It is the efficient functioning of the heart and lungs.

AEROBIC FITNESS

Is an exercise of relatively low intensity and long duration, which depends primarily on the aerobic energy system. Aerobic means "with oxygen", and refers to the use of oxygen in the body's metabolic or energy-generating process. Many types of exercise are aerobic, and by definition are performed at moderate levels of intensity for extended periods of time.

ANAEROBIC TRAINING

Is an exercise intense enough to trigger anaerobic metabolism. This means "without oxygen" and is the output of energy when the oxygen supply is insufficient to meet the body's long term energy demands. (For example, a 100 meter sprint.)

OXYGEN UPTAKE

The effort that you can exert over a prolonged period of time is limited by your ability to deliver oxygen to the working muscles. Regular vigorous exercise produces a training effect that can increase your aerobic capacity by as much as 20 to 30%. An increased VO₂ Max indicates an increased ability of the heart to pump blood, of the lungs to ventilate oxygen, and of the muscles to take up oxygen.

THE TRAINING THRESHOLD

This is the minimum level of exercise which is required to produce significant improvements in any physical fitness parameter.

OVERLOAD

This is where you exercise above your comfort level. The intensity, duration and frequency of exercise should be above the training threshold and should be gradually increased as the body adapts to the increasing demands. As your fitness level improves, the training threshold should rise. Working through your program and gradually increasing the overload factor is important.

PROGRESSION

As you become more fit, a higher intensity of exercise is required to create an overload and therefore provide continued improvement.

SPECIFICS

Different forms of exercise produce different results. The type of exercise that is carried out is specific to the muscle groups being used and to the energy source involved. There is little transfer of the effects of exercise, i.e. from strength training to cardiovascular fitness. That is why it is important to have an exercise program tailored to your specific needs.

REVERSIBILITY

If you stop exercising or do not do your program often enough, you will lose the benefits you have gained. Regular workouts are the key to success.

WARM-UP

Every exercise program should start with a warm-up where the body is prepared for the effort to come. It should be gentle and preferably use the muscles group to be involved later. Stretching should be included in both your warm-up and cool down, and should be performed after 3-5 minutes of low intensity aerobic activity or calisthenic type exercise.

WARM DOWN OR COOL DOWN

This involves a gradual decrease in the intensity of the exercise session. Following exercise, a large supply of blood remains in the working muscles. If it is not returned promptly to the central circulation, pooling of blood may occur in the muscles.

HEART RATE

As you exercise, your heart beat increases. This is often used as a measure of the required intensity of an exercise. You need to exercise hard enough to condition your circulatory system, and increase your pulse rate, but not enough to strain your heart.

Your initial level of fitness is important when developing an exercise program for you. When starting, you can get a good training effect with a heart rate of 110-120 beats per minute (BPM). If you are more fit, you will need a higher threshold of stimulation.

To begin with, you should exercise at a level that elevates your heart rate to about 65 to 70% of your maximum. If you find this is too easy, you may want to increase it, but it is better to lean on the conservative side.

As a rule of thumb, the maximum heart rate is 220 minus your age. As you increase in age, your heart, like other muscles, loses some of its efficiency. Some of its natural loss is won back as fitness improves. The following table is a guide to those who are “starting fitness.”

Age Target Heart Rate	25	30	35	40	45	50	55	60	65
10 Second Count	23	22	22	21	20	19	19	18	18
Beats per Minute	138	132	132	126	120	114	114	108	108

PULSE COUNT

The pulse count (on your wrist or carotid artery in the neck, taken with two index fingers) is done for ten seconds, taken a few seconds after you stop exercising. This is for two reasons: (a) 10 seconds is long enough for accuracy, (b) the pulse count is to approximate your BPM rate at the time you are exercising. Since heart rate slows as you recover, a longer count isn't as accurate.

The target is not a magic number, but a general guide. If you're above average with your fitness, you may work comfortably a little above that suggested for your age group. The following table is a guide.

Age Target Heart Rate	25	30	35	40	45	50	55	60	65
10 Second Count	26	26	25	24	23	22	22	21	20
Beats per Minute	156	156	150	144	138	132	132	126	120

Don't push yourself too hard to reach the figures on this table. It can be very uncomfortable if you over exercise. Let it happen naturally as you work through your program. Remember, the target is a guide, not a rule, a little above or below is just fine.

Two final comments: (1) don't be concerned with day to day variations in your pulse rate, being under pressure or not enough sleep can affect it; (2) your pulse rate is a guide, don't become a slave to it.

MUSCLE SORENESS

For the first week or so, muscle soreness may be the only indication you have that you are on an exercise program. This, of course, does depend on your overall fitness level. A confirmation that you are on the correct program is a very slight soreness in most major muscle groups. This is quite normal and will disappear in a matter of days.

If you experience major discomfort, you may be on a program that is too advanced, or you have increased your program too rapidly.

If you experience PAIN during or after exercise, your body is telling you something. Stop exercising and consult your doctor.

WHAT TO WEAR

Wear clothing that will not restrict your movement in any way while exercising. Clothes should be light enough to allow the body to cool. Excessive clothing that causes you to perspire more than you normally would gives you no advantage. The extra weight you lose is body fluid and will be replaced with the next glass of water you drink. Always wear athletic shoes.

BREATHING DURING EXERCISE

Do not hold your breath while exercising. Breathe normally as much as possible. Remember, breathing involves the intake and distribution of oxygen, which feeds the working muscles.

REST PERIODS

Once you start your exercise program, you should continue through to the end. Do not break off halfway through and then restart at the same place later on without going through the warm-up stage again. The rest period required between exercises may vary from person to person.

SUGGESTED STRETCHES

Head Rolls

Rotate your head to the right for one count while feeling the stretch up the left side of your neck. Next, rotate your head back for one count, stretching your chin to the ceiling. Rotate your head to the left for one count, and finally, drop your head to your chest for one count.

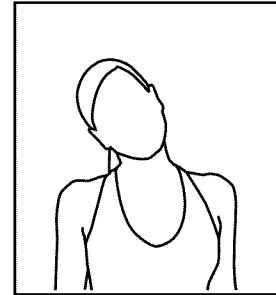

Shoulder Lifts

Lift your left shoulder up toward your ear for one count. Then lift your right shoulder up for one count as you lower your left shoulder.

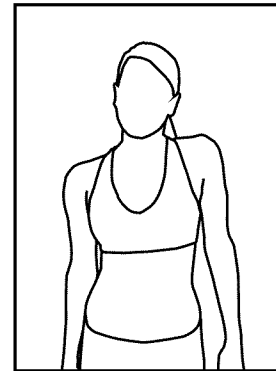

Side Stretches

Open your arms to the side and continue lifting them until they are over your head. Reach your left arm as far upward as you can for one count. Feel the stretch up your left side. Repeat this action with your right arm.

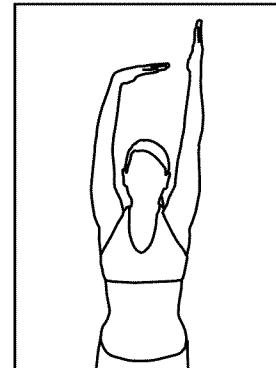

Quadriceps Stretch

With one hand against a wall for balance, reach behind you and pull your left foot up. Bring your heel as close to your buttocks as possible. Hold for 15 counts and repeat with right foot up.

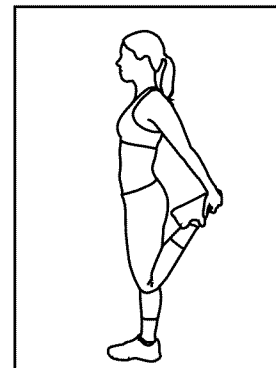

SUGGESTED STRETCHES

Inner Thigh Stretch

Sit with the soles of your feet together with your knees pointing outward. Pull your feet as close into your groin as possible. Gently push your knees towards the floor. Hold for 15 counts.

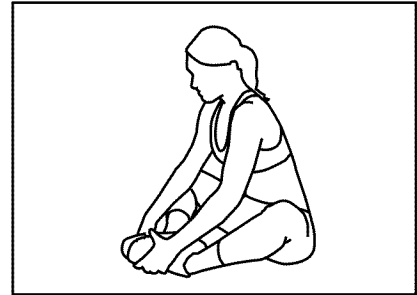

Toe Touches

Slowly bend forward from your waist, letting your back and shoulders relax as you stretch toward your toes. Reach down as far as you can and hold for 15 counts.

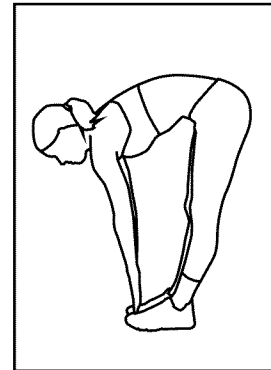

Hamstring Stretches

Sit with your right leg extended. Rest the soles of your left foot against your right inner thigh. Stretch toward your toes as far as possible. Hold for 15 counts. Relax and then repeat with left leg extended.

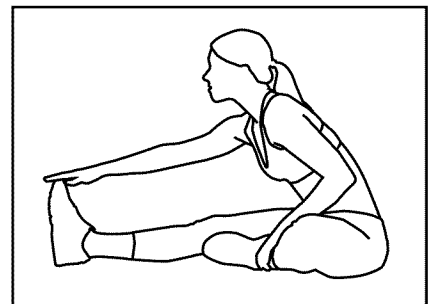

Calf/Achilles Stretches

Lean against a wall with your right leg in front of the left and your arms forward. Keep your left leg straight and the right foot on the floor; then bend the right leg and lean forward by moving your hip toward the wall. Hold, then repeat on the other side for 15 counts.

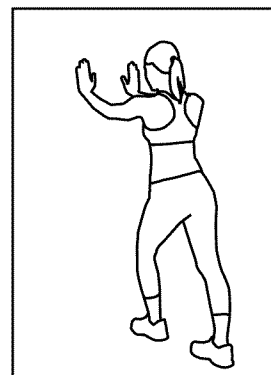

ASSEMBLY INSTRUCTIONS & WARNING LABELS

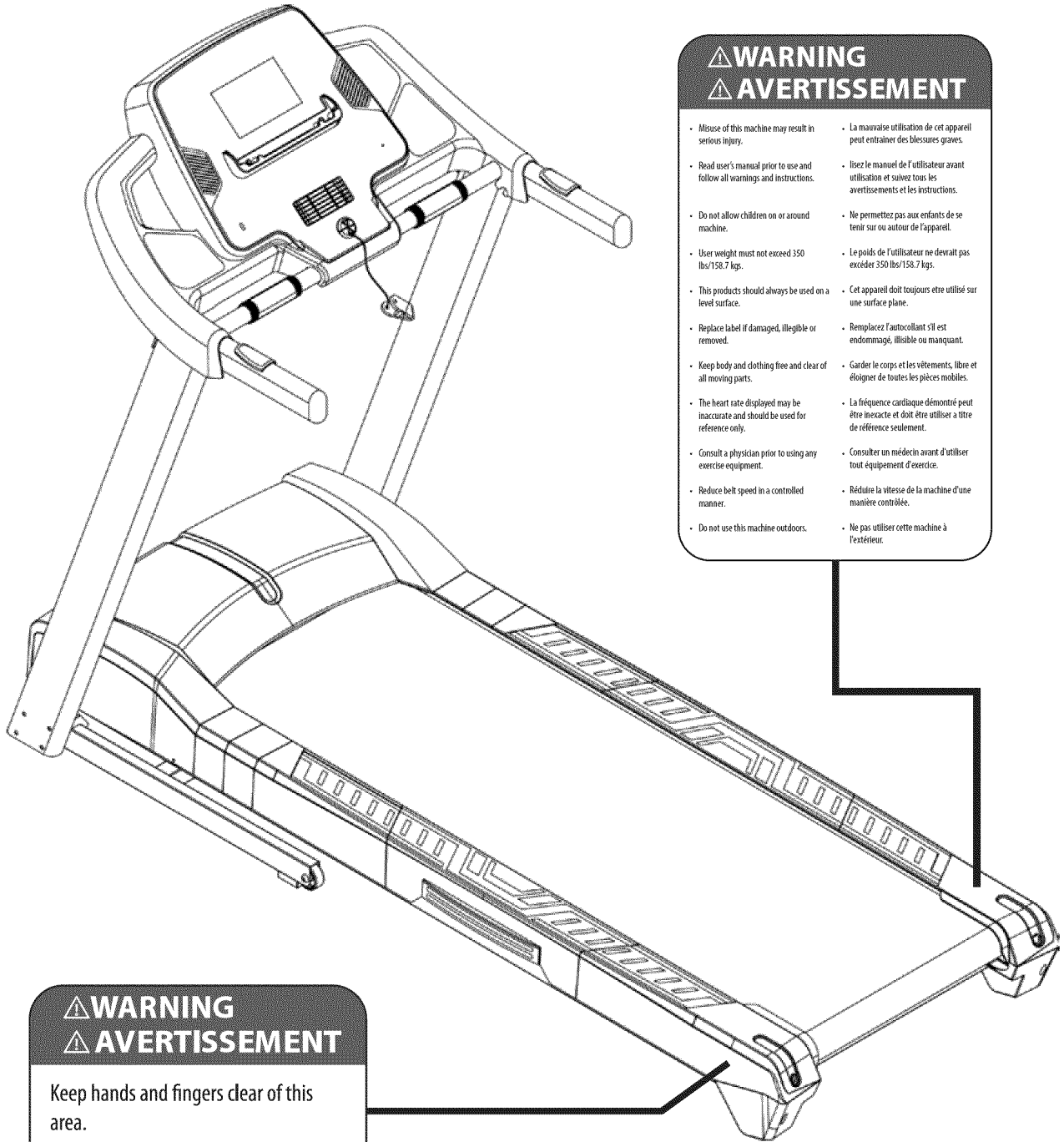

⚠ WARNING ⚠ AVERTISSEMENT

- Misuse of this machine may result in serious injury.
- Read user's manual prior to use and follow all warnings and instructions.
- Do not allow children on or around machine.
- User weight must not exceed 350 lbs/158.7 kgs.
- This product should always be used on a level surface.
- Replace label if damaged, illegible or removed.
- Keep body and clothing free and clear of all moving parts.
- The heart rate displayed may be inaccurate and should be used for reference only.
- Consult a physician prior to using any exercise equipment.
- Reduce belt speed in a controlled manner.
- Do not use this machine outdoors.
- La mauvaise utilisation de cet appareil peut entraîner des blessures graves.
- lisez le manuel de l'utilisateur avant utilisation et suivez tous les avertissements et les instructions.
- Ne permettez pas aux enfants de se tenir sur ou autour de l'appareil.
- Le poids de l'utilisateur ne devrait pas excéder 350 lbs/158.7 kgs.
- Cet appareil doit toujours être utilisé sur une surface plane.
- Remplacez l'autocollant s'il est endommagé, illisible ou manquant.
- Garder le corps et les vêtements, libre et éloigner de toutes les pièces mobiles.
- La fréquence cardiaque démontré peut être inexacte et doit être utilisé à titre de référence seulement.
- Consulter un médecin avant d'utiliser tout équipement d'exercice.
- Réduire la vitesse de la machine d'une manière contrôlée.
- Ne pas utiliser cette machine à l'extérieur.

⚠ WARNING ⚠ AVERTISSEMENT

Keep hands and fingers clear of this area.

Gardez vos mains et doigts éloignés de cet endroit

STEP 1

Attach the control wire to the guide wire (looks like a long twist tie) and then pull the control wire through the small hole in the bottom of Upright (D) and then up and out the top of the right Upright Tube (D) with the guide wire. Attached the Left & Right Upright tube (C,D) on frame (B) with screws (b), but do not tighten.

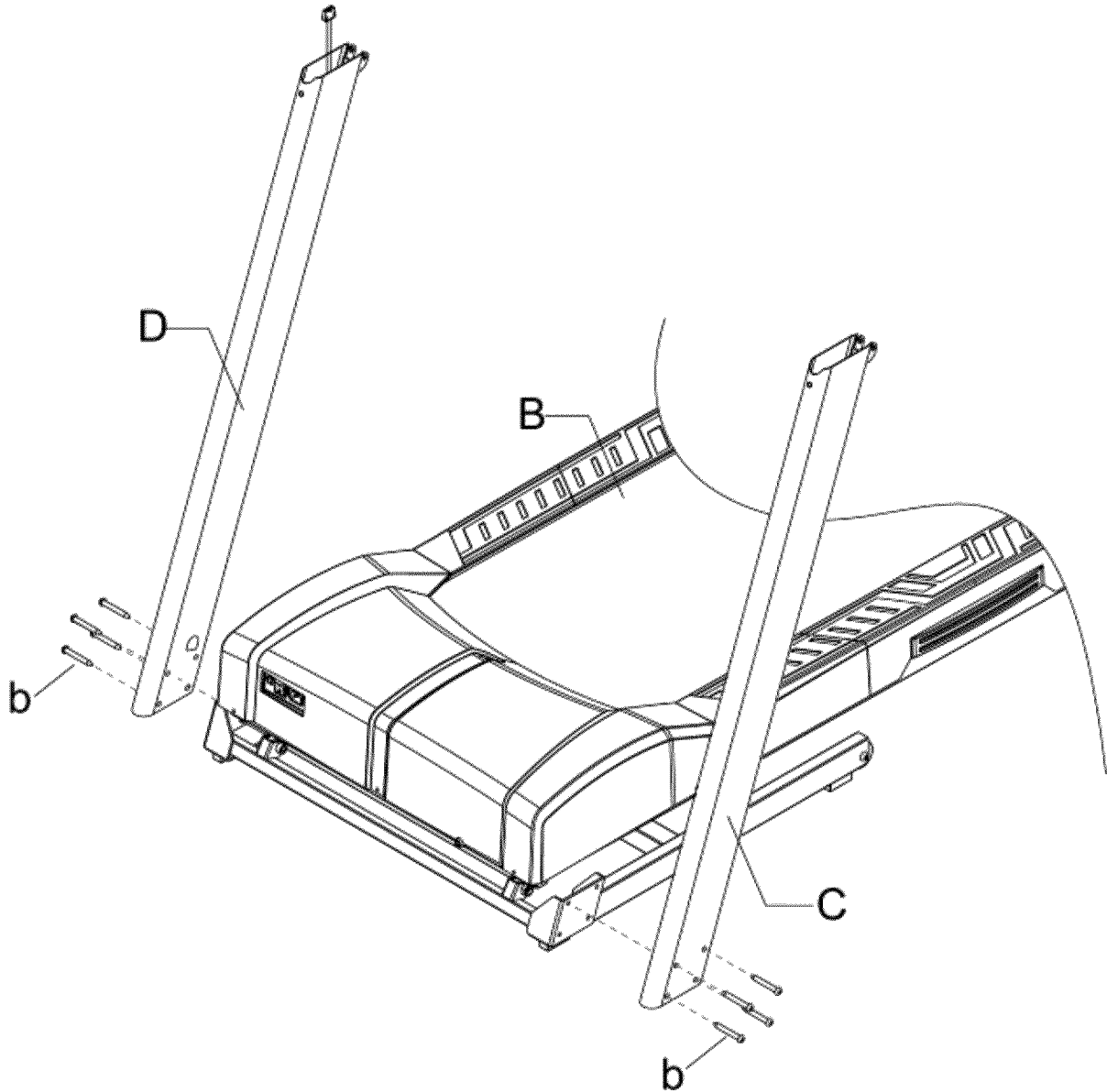

STEP 2

Connect the control wire of the computer console (i) with the control wire (j) that you pulled through the top of the right Upright Tube (D). Slide the computer console onto the left & right Upright Tubes (C, D). There are brackets on the bottom of console (A) that fit into Upright Tubes (C, D). Then attach the left & right Upright Tube (C, D) onto the frame (B) with screws (a) nuts (d) screws (c) and washers (e).

NOTE: Two people are required to complete this step.

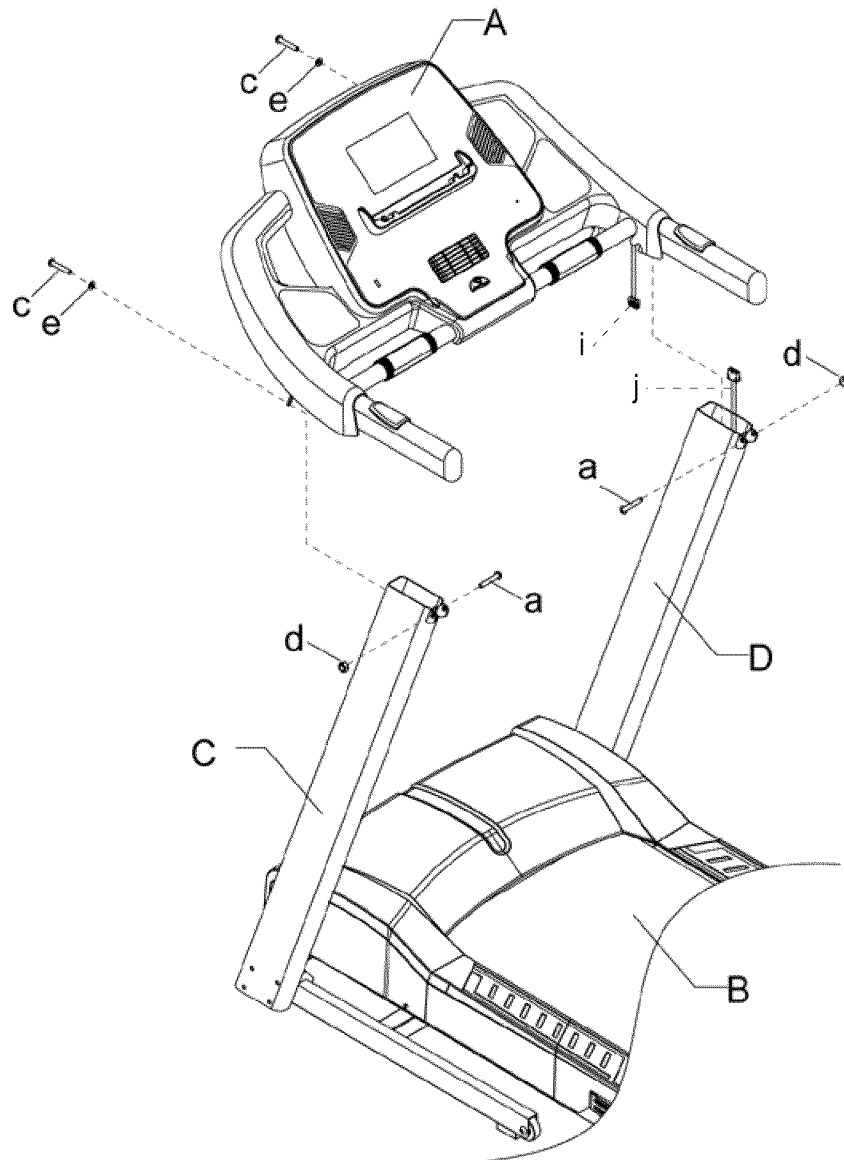

CAUTION

This treadmill is foldable for easy storage. To fold the treadmill, stop all movement, making sure the machine is turned off, the belt is no longer moving and the power cord is detached, before storing the treadmill. To fold the treadmill place both hands on the back of the treadmill and lift up until you hear a "Click" sound which means the unit is locked in place. If you want to lower the treadmill, push the lock with your foot (pictured below) and let it fall on its own. It will fall slowly and gently into the proper position. If it does not, then the hydraulic cylinder could be damaged. The hydraulic cylinder that controls the slow drop function of this treadmill uses pressure to function, please take extra care not to damage it. If the cylinder is damaged or bent, it may cause the folding action to malfunction or become less smooth.

- Please keep children away from the machine to prevent unnecessary injury.
- If you want to move the treadmill, fold the treadmill until it locks, hold the end caps with your hands, then lean the treadmill towards you. Only move the treadmills when the wheels move freely.
- Do not move the treadmill on uneven ground.

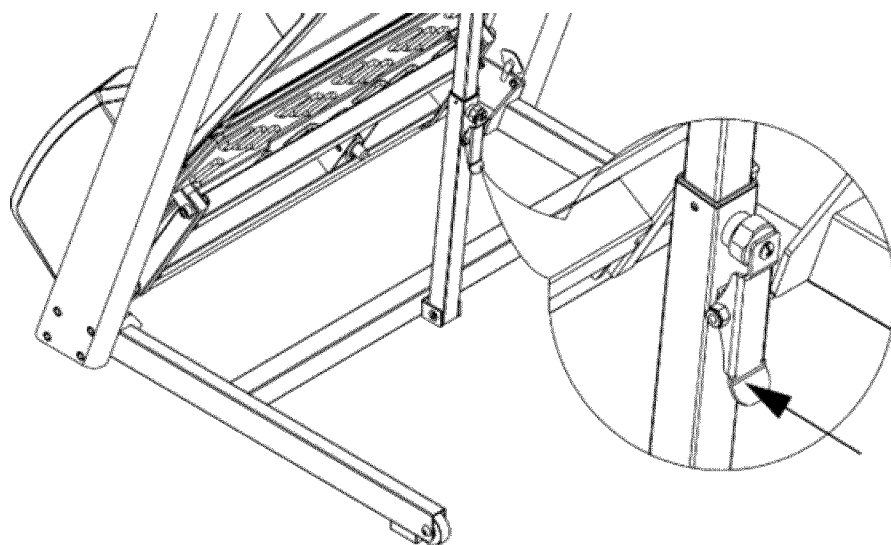
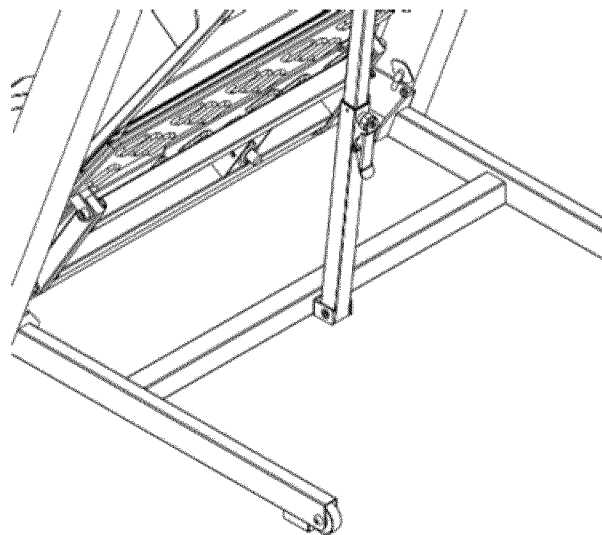

MAINTENANCE

To adjust the running belt, stop the treadmill, then use the 6mm hex wrench and adjust the hex screw located in the rear end cap. If the running belt is moving towards the left side, tighten the left hex screw with a 1/4 turn (clockwise); if the running belt is moving towards the right side, tighten the right hex screw with a 1/4 turn (clockwise); Turn the treadmill on after it has been adjusted. If you find that the belt has not moved to the proper position, please repeat the steps above. Don't use the treadmill until the running belt returns to the center position.

The position of running belt might not stay precisely in the center, it can and will shift slightly towards the left and right sides, however, you do not need to adjust the belt if it is not rubbing against the side rails.

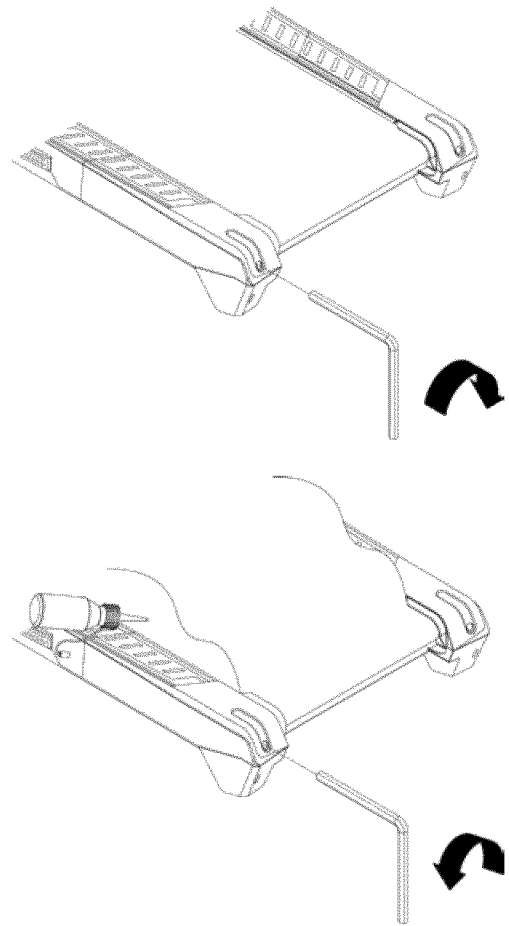

Depending on the usage of the product, please apply silicon according to the chart to the right. Use the hex wrench to unscrew the bolt inside the rear roller. Then pull the belt up and put some silicon on the center of the board. After that, adjust the belt to the center of the deck, then tighten all screws back into place.

When the belt is sliding, please follow the above method to lubricate the running board.

Silicon Chart

KGS/LBS	Speed	Interval
KGS	6KM/hr Below	1 year
	6~12KM/hr	6 months
	12KM/hr Above	3 months
LBS	4mile/hr Below	1 year
	4~8mile/hr	6 months
	8mile/hr Above	3 months

Note: This maintenance is intended for household use. If used for business, it is suggested to examine the product every other month.

EXPLODED VIEW DRAWING

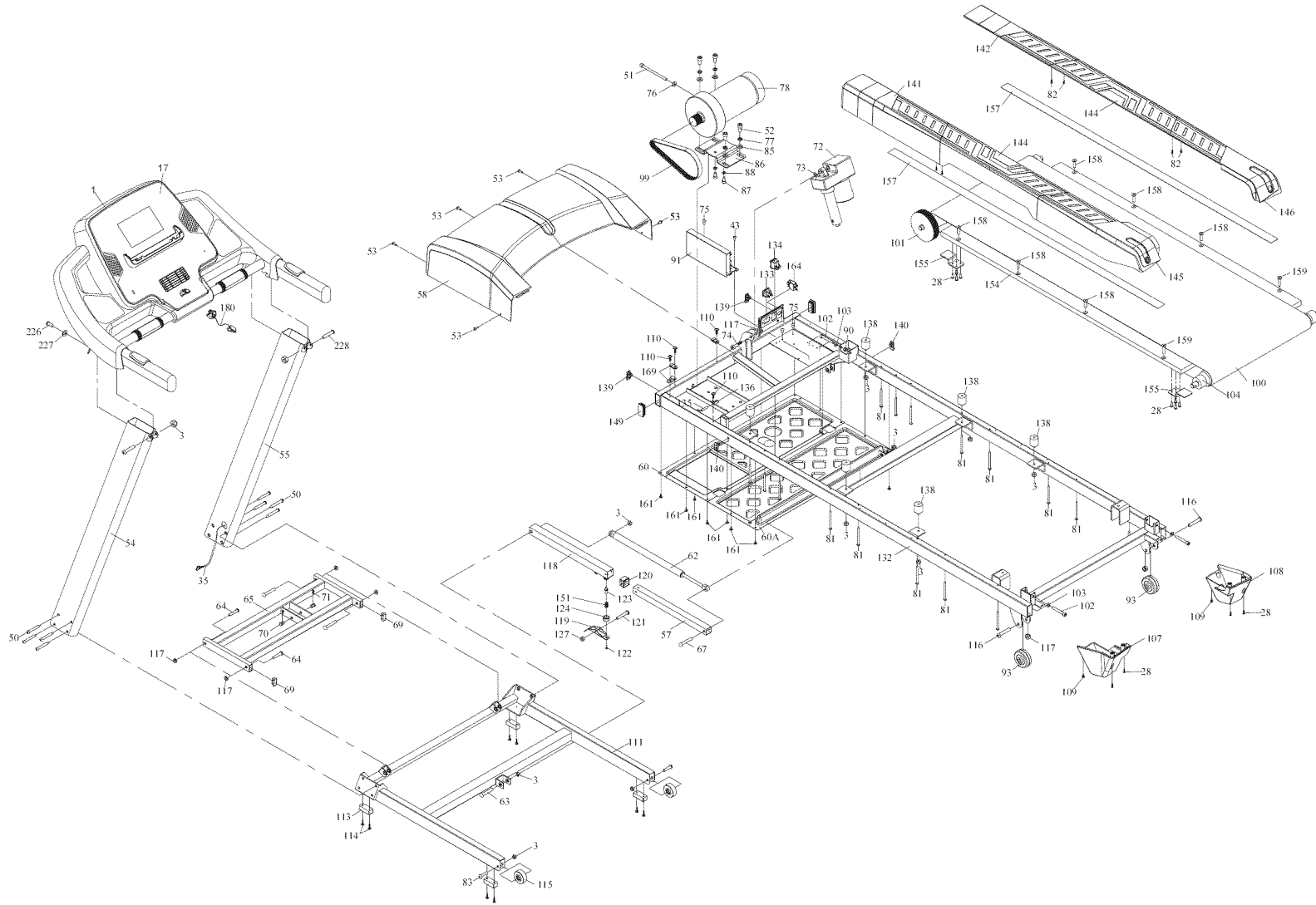

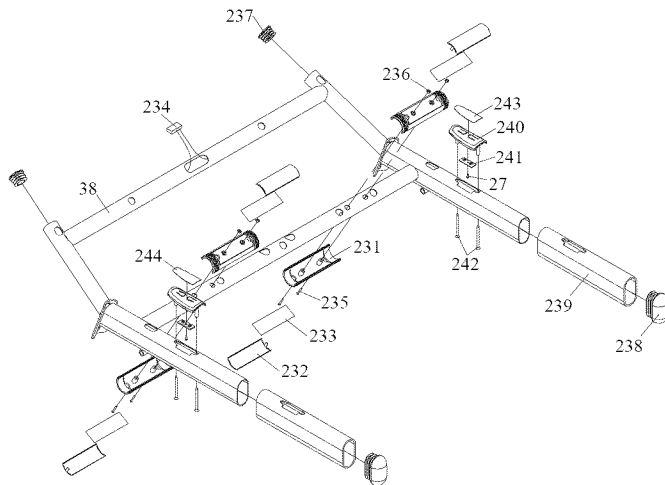
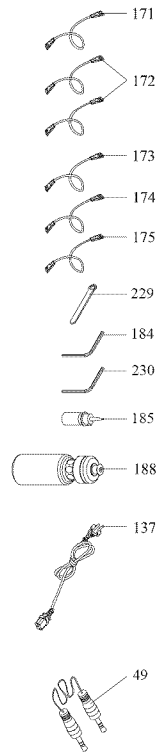
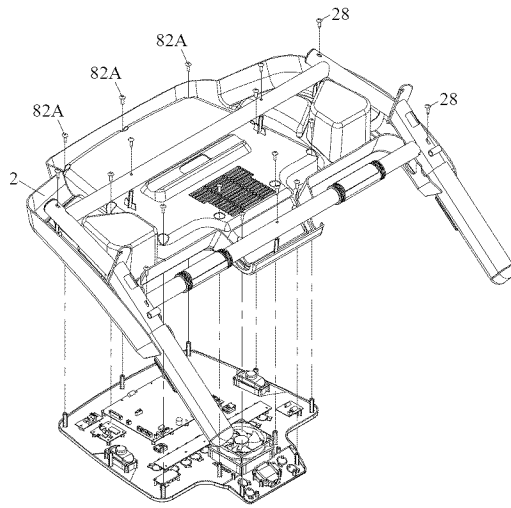
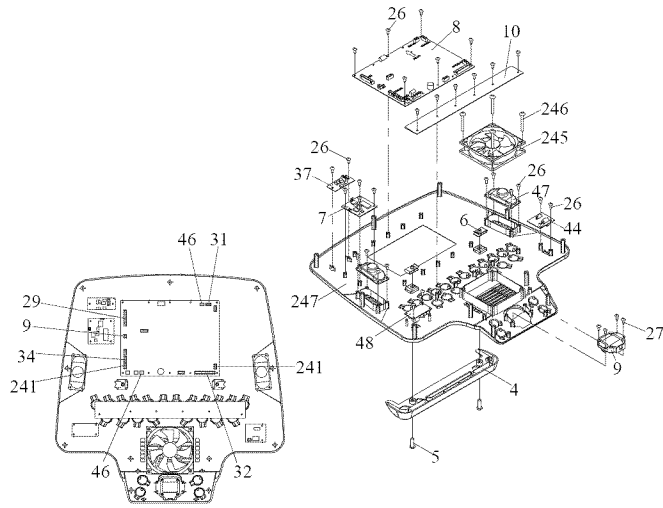

PARTS LIST

To order replacement parts: provide your customer service representative with the product model number and the part number located on the Parts List below, along with the quantity you require.

No.	Description	Qty	No.	Description	Qty
1	Computer assembly	1	109	Round head phillips screw M4xP0.7x20	2
2	Computer upper cover	1	110	Washer drilling phillips screw M4xP0.7x16	4
3	Nut M8xP1.25	14	111	Base welding H-GK	1
4	Tablet Shelf	1	113	Foot pad (black)	4
5	Round head phillips screw M5xP0.8x15	2	114	Washer drilling phillips self tapping screw	8
6	Nut (black)	2	115	Wheel 50	2
7	Wireless Bluetooth	1	116	Truss hex screw K-288	2
8	Computer (7"LCD show contain iron board+BT function)	1	117	Nut M10xP1.5	8
9	Safety switch set (haili) wire length 650mm	1	118	Flex tube welding	1
10	Keyboard 20 key	1	119	Pedal	1
17	Computer panel sticker	1	120	Inner cap	1
26	Round head self tapping screw 3x8	30	121	Truss phillips screw	1
27	Round head self tapping screw 3x8	6	122	Fixed position screw M4xP0.7x10	1
28	Round head self tapping screw 4x16	29	123	Flex tube	1
29	Control wire (up)	1	124	Flex outer cover	1
31	Heartbeat receiver wire 400mm	1	127	Nut M5xP0.8	1
32	Keyboard connector wire	1	132	Frame GH20"x60"	1
34	BT connector wire	1	133	Power wire socket SC-8-3C	1
35	Control wire (lower)	1	134	Power switch R595KDT-T2FS	1
37	Handle pulse board (wire length 260mm)	1	135	Sensor round pillar (6.5x30) wire length 1050mm	1
38	Computer shelf welding FA-GH (with handrail switch)	1	136	Sensor fixed base	1
43	Truss phillips screw	1	137	Power wire (for theadmail)	1
44	USB charging board	1	138	Fixed pad -30 mm (black)	6
46	MP3 USB power wire	2	139	Motor cover front fixed piece	2
47	Single square trumpet (2X3W)+wire	2	140	Motor cover side fixed piece	2
48	Sound source board	1	141	Front pedal(left) GL	1
49	MP3 sound source wire (M to M)	1	142	Front pedal(right) GL	1
50	Truss hex screw K-299	8	144	Middle pedal GH	2
51	CKS hex screw M8XP1.25X120	1	145	Rear pedal(left) 5T-GH	1
52	CKS hex screw M10xP1.5x20	4	146	Rear pedal(right) 5T-GH	1
53	Truss phillips screw M5xP0.8x15	5	149	Flat cap	2
54	Handlebar set up tube welding (left) FA-GH	1	151	Compression spring	1
55	Handlebar set up tube welding (right) FA-GH	1	154	Running board	1
57	25x25x0.9x369 Flex inner tube	1	155	Running bracket	4
58	Motor cover	1	157	Foam grip 1210mmx35mmx1.5t single side sticker black	2
60	Motor lower cover (front) 5T-GH	1	158	Counter sunk hex screw M8xP1.25x30	6
60A	Motor lower cover (rear) 5T-GH	1	159	Counter sunk hex screw M8xP1.25x35	2
61	Girding 3.6x163mm black	2	161	Washer phillips screw 4x12	16
62	Air pressure stick	1	164	Overload protector switch 88-13-SR13	1
63	Truss hex screw M8xP1.25x45	1	169	Wire fixed knob UC-0.5	3
64	CKS hex screw SK-439A	4	171	Terminal wire (white) 14AWGx90x2T	1
65	Incline base welding	1	172	Terminal wire (black) 14AWGx90x2T	2
67	Truss hex screw M8xP1.25x50	1	173	Terminal wire (white) 14AWGx170x2T	1
69	Flat cap 15x30x2.0t	2	174	Terminal wire (black) 14AWGx170x2T	1
70	Incline base stretch iron pin	2	175	Terminal wire (yellow green)-14AWGx130mmx1T1R	1
71	R PIN 10x2.0	2	179	Belt (1500mm)	1
72	Incline motor	1	180	Safety pin	1
73	Plastic washer	2	184	L shaped hex wrench 6x80x80mm	1
74	CKS hex screw SK-439	1	185	Silicon DC-1000 30C.C.	1
75	Round phillips screw	3	188	Bolt	1
76	Washer 8x19x3.0t	1	226	Truss hex screw M8xP1.25x15	2
77	Spring washer M10	4	227	Washer Φ8xΦ19x2.0t	2
78	D.C Motor (1.75HP-110V)	1	228	Truss hex screw M8xP1.25x40	2
81	Truss phillips screw 4x64	16	229	Plum blossom wrench	1
82	Truss phillips screw 4x10	8	230	L shaped hex wrench 5x30x120mm	1
82A	Truss phillips screw 4x12	11	231	Handle pulse plastic base	4
83	Truss hex screw M8xP1.25x35	2	232	Handle pulse sensor slice	4
85	Flat washer 10x20x3.0t	4	233	Two side sticker 25mmx75mmx0.3t	4
86	Motor fixed slice	1	234	Handle pulse sensor wire	1
87	CKS hex screw M8xP1.25x10	2	235	Round phillips screw M3xP0.5x30	4
88	Spring washer M8	2	236	Hex nut M3xP0.5	4
90	Hex nut M8xP1.25	1	237	Flat cap φ1-1/4"	2
91	Controller 1.75-2.0HP_110V	1	238	Oval cap 36x66	2
93	Wheel (black)	2	239	HDR grip	2
99	Belt 230J8	1	240	Handle switch plastic 1-1/4"	2
100	Running belt 500x3210x1.4t	1	241	Handle switch +wire	2
101	Front roller (60) TMT bearing	1	242	Counter sunk phillips screw 3x45	4
102	CKS hex screw M8xP1.25x55	3	243	Handle switch sticker-speed	1
103	Washer 8x16x1.5t	3	244	Handle switch sticker-angle	1
104	Rear roller (60) TMT bearing	1	245	Fan	1
107	Rear decorative cover (left) 5T-GH	1	246	Truss phillips self tapping screw Φ4x32	4
108	Rear decorative cover (right) 5T-GH	1	247	Computer inner box 7"	1

CONSOLE OPERATIONS

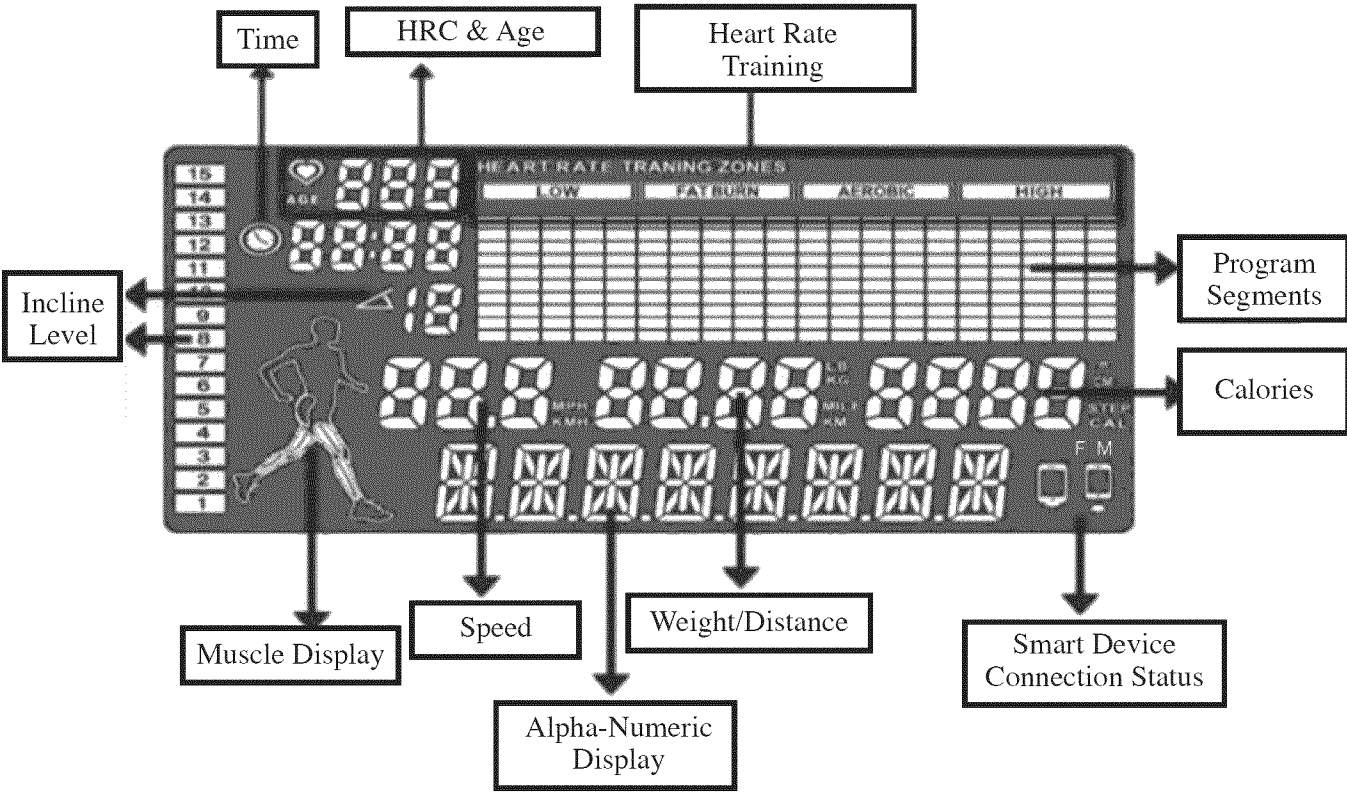

SPECIFICATIONS:

ENTER: To confirm all setting values

MODE: To switch Program Mode

START: To start training

STOP: 1) In training stage, pressing stop will pause the program. 2) In pause stage, pressing stop for "4" seconds puts the program into idle status. 3) In general, pressing stop will take you back to the previous function

INSTANT INCLINE: Adjusts Incline to levels 1/2/4/6/8/10

INSTANT SPEED: Adjusts Speed levels to 2/4/6/8/10/12 (by MPH)

FUNCTION:

TIME	Displays the workout time while exercising
SPEED	Displays the current speed
DISTANCE	Displays distance while exercising
PULSE	30-240 BPM
CALORIES	Counts calories while exercising

USB POWER CHARGING INSTRUCTION

This product can be used to connect to a Bluetooth enabled smart phone or tablet. The user must download a compatible application to interact with the treadmill. This port is used to charge the IOS or Andriod device. A compatible USB cord must be used, cord not included with purchase of treadmill. The electric output is 1A.



HANDRAIL KEYBOARD INSTRUCTION

SPEED +/-: Pressing either button can adjust the treadmill's speed 0.1 at a time. If you press and hold, the value will change faster.

INCLINE \uparrow/\downarrow : Pressing either button can adjust the treadmill's incline 1 Level at a time. If you press and hold, the value will change faster.

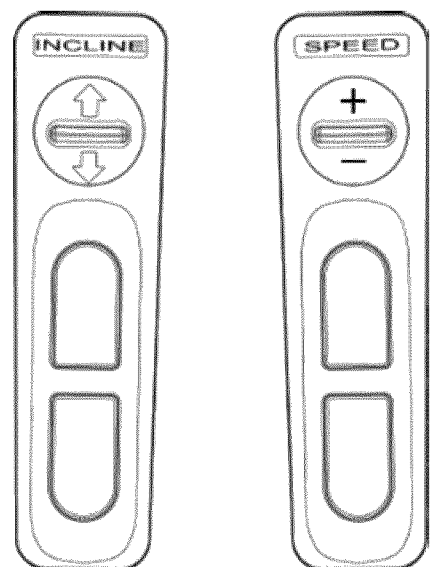

HEART RATE TRAINING ZONE INSTRUCTION

HEART RATE TRAINING ZONES

LOW

FATBURN

AEROBIC

HIGH

To calculate your heart rate use the following HRC formula: Max. heart rate = $(220 - \text{age})$

Low: 0-64%

Fatburn: 65%-74%

Aerobic: 75%-84%

High: 85% above

Example: If a user is 30 years old, the max heart rate is 190 ($220-30=190$). In the HRC training mode, if a users HRC is 120, the machine will calculate based on your max HRC: $120/190 = 63\%$ and will show low as an exertion level.

HEART RATE INSTRUCTION

- Hand grip pulse: During fitness, if a user grips the detector, you will see the heart rate windows' pulse picture flash, it means a pulse is detected. It will show the actual heart rate within 20 seconds.
- Wireless pulse receiver: For safety and sensor accuracy, when the speed is over 7.2KPH (4.5MPH), it is recommended to use a wireless chest belt instead of hand grip sensor. The chest belt is wireless and provides pulse information directly to the machine. Secure the chest belt under the chest muscles (as shown below). The fit should be snug, but you should be able to breath easily.
- A Polar® compatible wireless chest belt is not included with the machine, but can be purchased separately.
- HRC normal range is 40-220 BPM, when a user has the option of using a hand grips or a wireless pulse emitter, please use the wireless pulse emitter's value first.

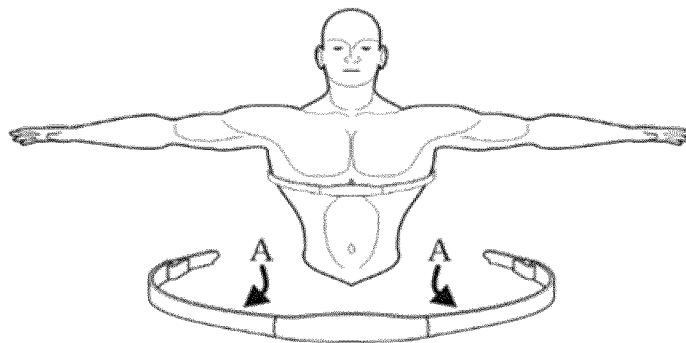

Age	BPM			Age	BPM			Age	BPM			Age	BPM		
	H	Preset	L		H	Preset	L		H	Preset	L		H	Preset	L
13	197	124	124	31	180	113	113	49	162	103	103	67	145	92	92
14	196	124	124	32	179	113	113	50	162	102	102	68	144	91	91
15	195	123	123	33	178	112	112	51	161	101	101	69	143	91	91
16	194	122	122	34	177	112	112	52	160	101	101	70	143	90	90
17	193	122	122	35	176	111	111	53	159	100	100	71	142	90	89
18	192	121	121	36	175	110	110	54	158	100	100	72	141	90	89
19	191	121	121	37	174	110	110	55	157	99	99	73	140	90	88
20	190	120	120	38	173	109	109	56	156	98	98	74	139	90	88
21	189	119	119	39	172	109	109	57	155	98	98	75	138	90	87
22	188	119	119	40	171	108	108	58	154	97	97	76	137	90	86
23	187	118	118	41	170	107	107	59	153	97	97	77	136	90	86
24	186	118	118	42	169	107	107	60	152	96	96	78	135	90	85
25	185	117	117	43	168	106	106	61	151	95	95	79	134	90	85
26	184	116	116	44	167	106	106	62	150	95	95	80	133	90	84
27	183	116	116	45	166	105	105	63	149	94	94				
28	182	115	115	46	165	104	104	64	148	94	94				
29	181	115	115	47	164	104	104	65	147	93	93				
30	181	114	114	48	163	103	103	66	146	92	92				

ABOUT THE MUSCLE DISPLAY

When the USER changes the incline level it will display on the screen and highlight which muscles are being used.

Level 0

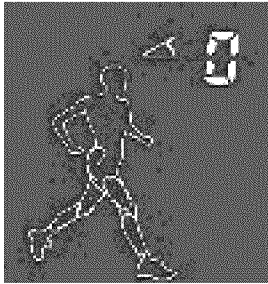

Levels 1-3

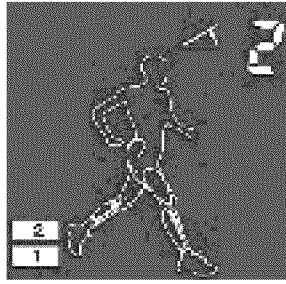

Levels 4-6

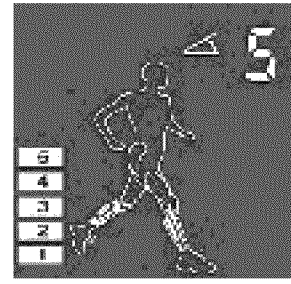

Levels 7-9

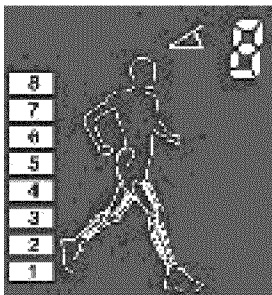

Levels 10-12

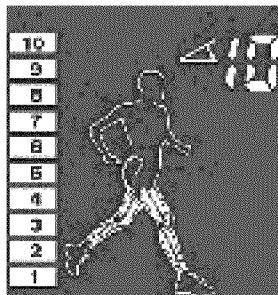

Levels 13-15

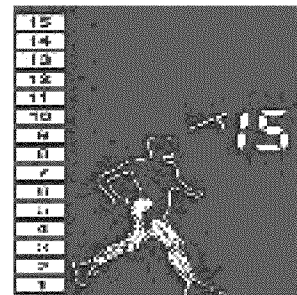

GETTING STARTED

STAND BY MODE

- Start-up: Unfold and plug in the machine, a beep will sound and the screen will light up. (Figure 1, 2).
- Setup Weight: SPEED+ or SPEED- input Weight, the default is 70kg/154lbs.
- Sleep: When the machine is left in pause for 2 minutes, the computer will go back to Idle Mode. After a total of 5 minutes the screen will dim and the machine goes into sleep mode.

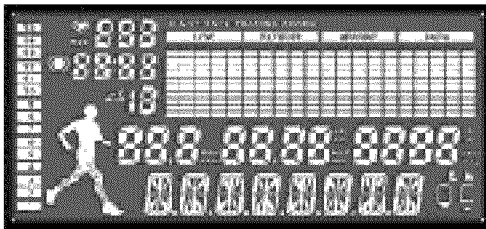

Figure 1

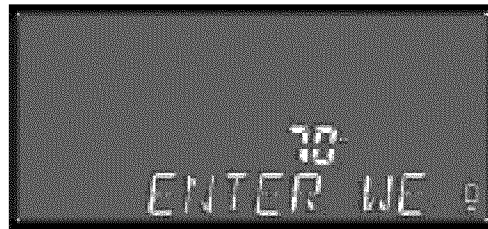

Figure 2

START TRAINING

Quick Start

Press the QUICK START (after you have entered your weight in the instructions above). The Screen will show "Ready" and count down 3 seconds.

While training:

1. Press Instant Incline button or INCLINE+ or INCLINE- to adjust the Incline Level.
2. Press Instant Speed button or SPEED+ or SPEED- to adjust the Speed.

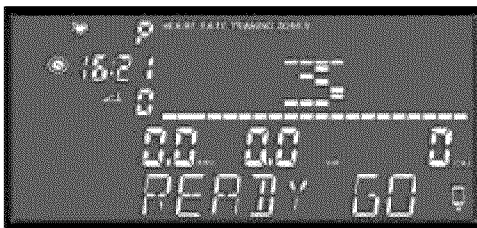

Figure 3

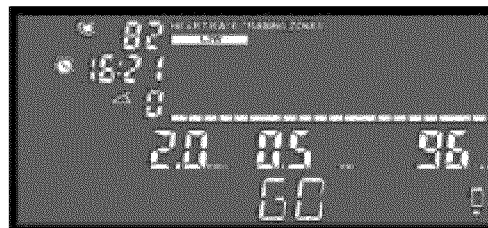
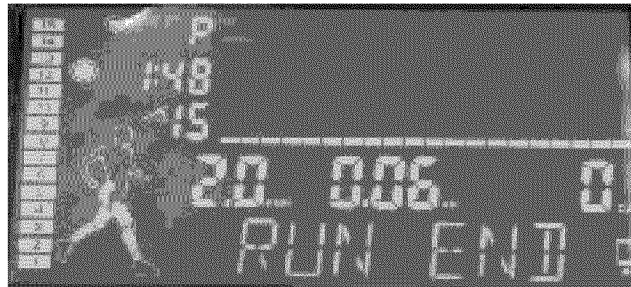

Figure 4

How to Pause / Stop

1. When the belt is moving, press STOP to pause the program.
2. When you have finished your current program, the motor will stop and show "RUN END" on the screen.
3. While paused or at RUN END, user can press and hold STOP button for 4 seconds to put the treadmill back to Idle Mode.



PROGRAM

1. Select your weight while in the STAND BY mode and press ENTER to confirm.
2. User can browse programs by pressing the mode or SPEED+/SPEED- buttons. (MANUAL, P1, P2, P3, P4, P5, P6, RANDOM, USER, H.R.C.1-3.)
3. Pressing the STOP button will bring you can back to the previous function page.

MANUAL

1. Press ENTER to select Manual and enter the Target Time Setup. Press SPEED+ or SPEED- to setup target time. (Time Scale: 0:00, 20:00~99:00).
2. Press ENTER to confirm your target time and enter into the Target Distance Setup. Press SPEED+ or SPEED- to setup target distance. (Distance Scale: 0.00~99.00).
3. Press ENTER to confirm your target distance and enter into the Target Calories Setup. Press SPEED+ or SPEED- to setup target calories. (Calories Scale: 0~9990).
4. When you have finished your set up, press START to enter Training.

P1 (9 HOLE): INCLINE & SPEED

1. Press ENTER to select MANUAL and press SPEED+ or SPEED- to select P1. Press ENTER and Press SPEED+ to setup Level (Level 1 ~ Level 10).
2. Press ENTER to get into the Target Distance Setup. Although the display will show "Enter Distance", the distance is fixed and cannot be changed. Press SPEED+ or SPEED- to setup Distance (Distance Scale: 0.5~99.5 KM/Mile).
3. Press ENTER to input the default target distance. The Screen will show "Ready Go" and count down 3 seconds to enter the training mode.

P2 (HILL CLIMB): INCLINE & SPEED

1. Press ENTER to select MANUAL and press SPEED+ or SPEED- to select P2. Press ENTER and Press SPEED+ to setup the Level (Level 1 ~ Level 10).
2. Press ENTER to input the level and to enter into the Target Time Setup. Press SPEED+ or SPEED- to setup Target Time. (Time Scale: 20:00~99:00).
3. Press ENTER to confirm the target time. The Screen will show "Ready Go" and count down 3 seconds to enter the training mode.

NOTE: P3-P6 OPERATION IS THE SAME AS P2.

RANDOM (Random Speed)

1. Press ENTER to select MANUAL and press SPEED+ or SPEED- to select RANDOM. Press ENTER to get into Target Time Setup. Press SPEED+ or SPEED- to setup the target time. (Time Scale: 0:00, 20:00~99:00).
2. Press ENTER to confirm the target time and enter into the Target Distance Setup. Press SPEED+ or SPEED- to select target distance. (Distance Scale: 0.00~99.00 KM/Mile).
3. Press ENTER to confirm the target distance and enter into the Target Calories Setup. Press SPEED+ or SPEED- to select target calories. (Calories Scale: 0~9990).
4. When you have finished your training setup, please press START to enter into Training.

USER (USER CAN EDIT SPEED & INCLINE PROFILE)

1. Press ENTER to select MANUAL and press SPEED+ or SPEED- to select USER. Press ENTER to get into the User Program and selection status.
 - (1) Press SPEED+ or SPEED- to choose U1, U2, U3, U4.
 - (2) Press ENTER for 3 seconds, enter into edit profile status. Press SPEED+ or SPEED- to edit Speed profile shape.

Press INCLINE+ or INCLINE- to edit the Incline profile shape.

Press ENTER to select the next stage.

Press ENTER for 3 seconds to finish edit.

2. Press ENTER to Select U1 and enter into Target Time Setup.

Press SPEED+ or SPEED- to setup target time. (Time Scale: 0:00, 20:00~99:00).

3. Press ENTER to confirm the target time and enter into the Target Distance Setup.

Press SPEED+ or SPEED- to select target distance. (Distance Scale: 0.00~99.00 KM/Mile).

4. Press ENTER to confirm the target distance and enter into the Target Calories Setup.

Press SPEED+ or SPEED- to setup the target calories. (Calories Scale: 0~9990).

5. When you have finished the setup, please press START to enter into Training.

Note: Only one target (Time, Distance, Calories) can be setup for each U1-U4 training.

H.R.C (Heart Rate Control) 1-3

Press ENTER to select H.R.C 1-3.

Press SPEED+ or SPEED- to select 60%, 75%, THR (Target Heart Rate).

Note: In HRC Program, the computer will only accept the "Wireless Heart Rate Signal" (we suggest using a wireless heart belt). If no pulse signal is detected for 45 seconds, the computer will stop and show "No Pulse" automatically.

1. 60%, 75%

(1). Press ENTER to select 60% (or 75%) and enter into the Target Time Setup. Press SPEED+ or SPEED- to select the target time. (Time Scale: 0:00, 20:00~99:00).

(2). Press ENTER to confirm the target time and enter into the Age Setup. Press SPEED+ or SPEED- to select User Age. (Default 30 years old).

(3). Press ENTER to confirm your age and enter into the Target Heart Rate Setup. Press SPEED+ or SPEED- to adjust.

(4). Press ENTER to input the target heart rate. The screen will show "Ready Go" and count down 3 seconds to enter into the training mode.

2. THR (Target Heart Rate)

(1). Press ENTER to select your THR and enter into the Target Time Setup. Press SPEED+ or SPEED- to select the target target time. (Time Scale: 0:00, 20:00~99:00).

(2). Press ENTER to confirm the target time and enter into the Target Heart Rate Setup. Press SPEED+ or SPEED- to setup target heart rate (Default 72).

(3). Press ENTER to confirm your target heart rate. The screen will display "Ready Go" and count down 3 seconds to enter Training.

BODY FAT MODE

Press ENTER to select BODY FAT and the treadmill will ask for the following information:

(1) Age - Preset value is 30, range:13-80, Step 1, press SPEED+/- for adjustment. After user selects the right value, press ENTER to move to the next parameter setting.

(2) Height - Preset value is 170 cm, range: 120-200 cm, increments are in 1 cm, press SPEED+/- for adjustment. After selecting the right value, press ENTER to move to the next parameter setting.

(3) Sex - preset is male, press speed+/- to change, male(1) or female(0). After selecting the right value, press ENTER to move to the next setting.

(4) Weight - Preset value is 70 kg (150LB), range:23-130kg (50-286LB), increments are in 1 kg, press speed+/- for adjustment. After selecting the right value, press ENTER.

Please use both hands to hold the pulse detector for 15 seconds and after 15 seconds, windows will show body fat value (refer to below list for your result). After the value is displayed, press stop or 1 minute later, it will return to start/steady windows.

Sex	Under		Normal		Over		Obesity	
M. (male)	0.0~4.9	5.0~9.9	10.0~14.9	15.0~19.9	20.0~24.9	25.0~29.9	30.0~34.9	Over 35.0
F. (female)	0.0~14.9	15.0~19.9	20.0~24.9	25.0~29.9	30.0~34.9	35.0~39.9	40.0~44.9	Over 45.0

PROGRAM REVIEW

MANUAL

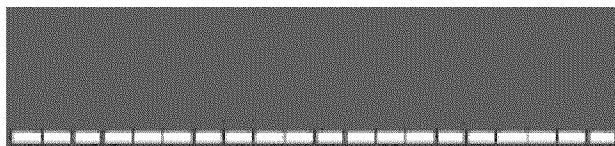

P1 9 Hole



Hidden Area

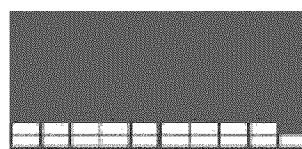

P2 Hill Climb

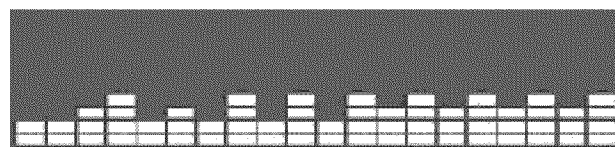

Hidden Area

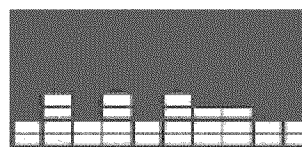

P3 Hill Run

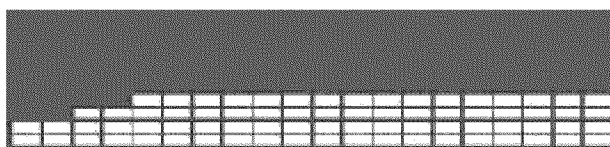

Hidden Area

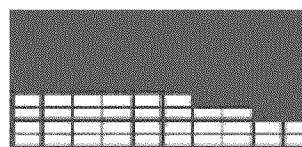

P4 Interval

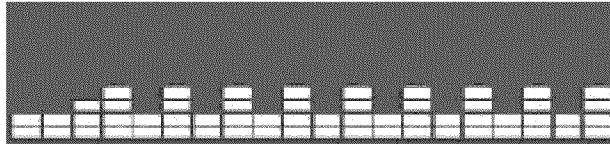

Hidden Area

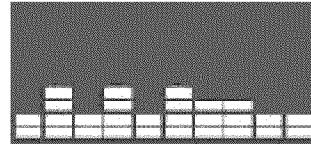

P5 Rolling

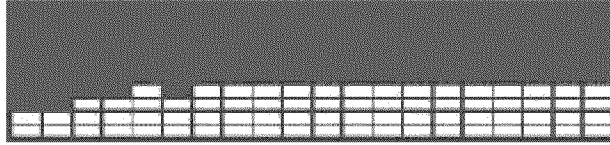

Hidden Area

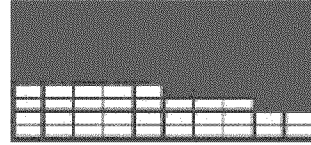

P6 Weight Loss

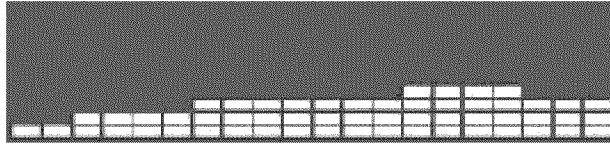

Hidden Area

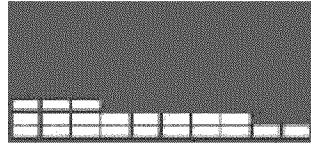

RANDOM

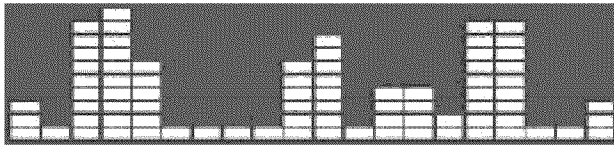

HRC 75%

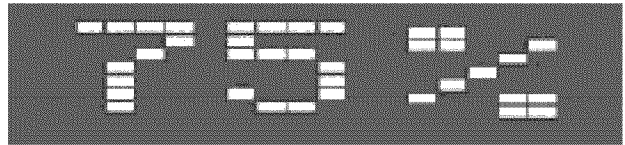

USER

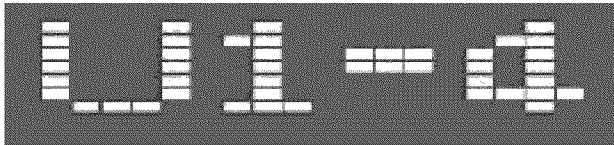

HRC THR

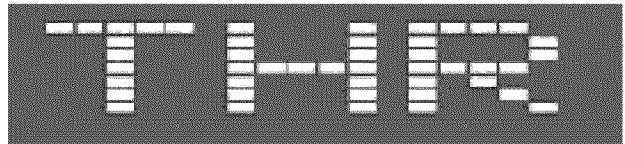

HRC 1-3

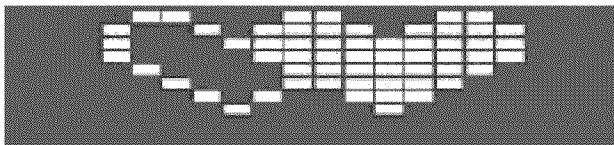

BODY FAT (BDF)

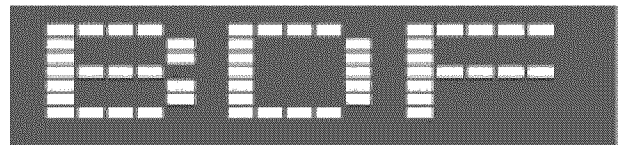

HRC 60%

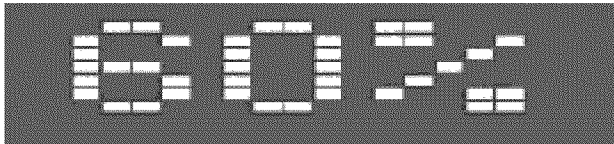

SAFETY KEY & ERROR WARNING

Safety Key Unplug:

1. When the safety key is unplugged, the machine will stop automatically and display “SAFETY OFF” on the Screen.
2. If the user plugs the safety key back in, the machine will re-start and enter into Idle Mode.

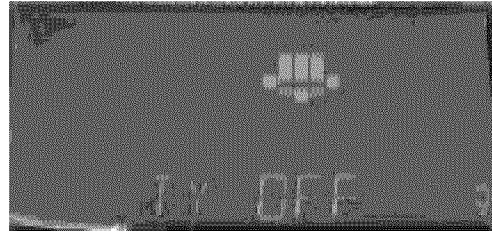
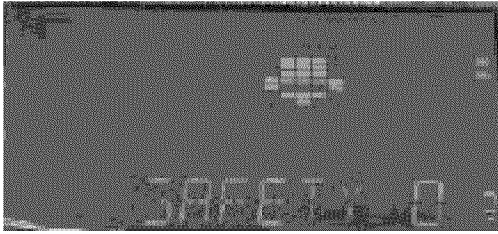

ERROR WARNING

When there is an error, the machine will stop automatically and display an “Error Message” on the screen.

- E1-COMMUNICATION FAILURE - communication is abnormal
- E2-SPEED FEEDBACK ERROR - speed is abnormal
- E6-INCLINE ERROR - incline motor is not functioning properly.
- E8-EEPROM - software error.

DOWNLOADING APPS AND PAIRING YOUR DEVICE WITH YOUR EQUIPMENT

DOWNLOADING THE SOFTWARE

Connect the Apple device with the App Store (iTunes) or your Android Device with Google Play, search for "Pafers", then read the APP introductions and Download the APPs with bicycle/elliptical machine functions to your device, for example Pedal Monitor or other applicable apps. *Note: if you download an APP for a treadmill and pair it with an Elliptical it will not work.*

- The App uses bluetooth mode, so please make sure the recumbent and device you are using has bluetooth function.
- The App contains the following functions, the user must open a 3G network or wi-fi network:

(a) Managing Data - After completing the registration in the "Pafers" App, log on to your personal account. Now that you have registered you can record all of your workout data and save it to your device.

(b) Some APPs need connection to Google maps in order to function correctly.

PAIRING THE BLUETOOTH DEVICE WITH AN APPLE DEVICE

1. Place the Apple Device on the area in front of the LCD screen.
2. Enter into settings and turn Bluetooth on.
3. Your Apple Device will detect all Bluetooth devices within range (following on screen instructions), click on the appropriate bluetooth device name and confirm your connection.
4. After pairing successfully, please start the APP within 2 minutes, if you do not, Bluetooth will automatically cancel the pairing. Please keep the Apple Device within a range of 2 meters for best quality connection. If you see "not connected," please perform the above steps again.
5. Press the Apple Device home button, the screen will return to the desktop.
6. Start the APP you downloaded. When the APP connects with the equipment successfully, the APP screen buttons will unlock. Start from APP interface using a variety of modes to control the exercise equipment. Pay attention to the APP instructions and function introduction. If you need help with the APP, please browse the APPs download page description or contact Pafers for instructions.
7. When you are done using the APP, please press the HOME button on the Apple Device twice to close the APP.

PAIRING THE BLUETOOTH DEVICE WITH AN ANDROID DEVICE

1. Place the Android Device on the area in front of the LCD screen.
2. Enter into settings and turn Bluetooth on.
3. Your Android Device will detect all Bluetooth devices within range (following on screen instructions), click on the appropriate bluetooth device name and confirm your connection.
4. After pairing successfully, please start the APP within 2 minutes, if you do not, Bluetooth will automatically cancel the pairing. Please keep the Android Device within a range of 2 meters for best quality connection. If you see “not connected,” please perform the above steps again.
5. Press the home button, the screen will return to the desktop.
6. Start the APP you downloaded. When the APP connects with the equipment successfully, the APP screen buttons will unlock. Start from APP interface using a variety of modes to control the exercise equipment. Pay attention to the APP instructions and function introduction. If you need help with the APP, please browse the APPs download page description or contact the third party for instructions.
7. When you are done using the APP, please press main screen button on the Android Device twice to close the APP.

COMPATIBLE DEVICES

Android

Bluetooth & App Enabled Android Device

Apple Products

iPod touch (4th generation)	iPod touch (3rd generation)
iPhone 5	iPhone 4S
iPhone 4	Mini iPad
iPad	iPad 2

Bladez Fitness i.Concept Bluetooth products are compatible with Apple devices with iOS 5.1 or later. It is recommended to update iOS to the latest version to obtain the best user experience.

iPad, iPhone, iPod, iPod classic, iPod nano, iPod shuffle, and iPod touch, is a registered trademark of Apple, Inc., in the United States and other countries.

“Made for iPod,” “Made for iPhone,” and “Made for iPad” mean that an electronic accessory has been designed to connect specifically to iPod, iPhone, or iPad, respectively, and has been certified by the developer to meet Apple performance standards. Apple is not responsible for the operation of this device or its compliance with safety and regulatory standards. Please note that the use of this accessory with iPod, iPhone, or iPad may affect wireless performance. iPad, iPhone, iPod, iPod classic, iPod nano, iPod shuffle, and iPod touch are trademarks of Apple Inc., registered in the U.S. and other countries.

MAINTENANCE AND CLEANING

Care has been taken to assure that your equipment has been properly adjusted and lubricated at the factory. It is not recommended that the user attempt service on the internal components. Instead, seek service from an authorized service center. However, you may clean the outer surface. Use a soft cloth, dampened with warm water. Do not use aerosol sprays or pump bottles as they may deposit sediments upon the console surface. The use of harsh chemicals will destroy the protective coating and cause a static build-up that may damage the some of the components.

WARRANTY

RESIDENTIAL WARRANTY

Bladez Fitness will repair or replace, free of charge, at its option, parts that are defective as a result of material or workmanship. Lifetime replacement warranty coverage on frame and Three (3) year on other parts. Labor warranty coverage is one (1) year. Warranty covers the original consumer purchaser only.

THIS WARRANTY DOES NOT COVER

- Pre-delivery set-up.
- Components that require replacement due to dirt or lack of regular maintenance.
- Expendable items which become worn during normal use.
- Repairs necessary because of operator abuse or negligence or the failure to operate and maintain the equipment according to the instructions contained in the Owner's Manual.

For more detailed warranty information or to register your product warranty easily online, visit our website at: <http://www.BladezFitness.com>

* Applies to defects from the manufacturer only.

**FOR WARRANTY REPAIRS, PLEASE DO NOT TAKE YOUR MACHINE
BACK TO THE RETAIL STORE. CONTACT BLADEZ FITNESS FIRST.**

Bladez Fitness/BH North America Corporation
20155 Ellipse
Foothill Ranch, CA 92610
Phone: 949.206.0330; Toll Free: 866.325.2339; Fax: 949.206.0013
Email: fitness@bhnorthamerica.com
Web: www.bladezfitness.com
Mon - Fri 8am - 5pm PST