

COMMERCIAL CHEST FREEZER

TABLE OF CONTENTS

Product Registration.....	2
Important Safety Instructions.....	2
First Steps.....	3
Appliance Start-up.....	5
Features.....	6
Care and Cleaning.....	6
Energy-Saving Tips.....	8
Power Failure.....	8
Before You Call.....	9
Wiring Diagram.....	11
Warranty.....	12

Product Registration

Important Safety Instructions

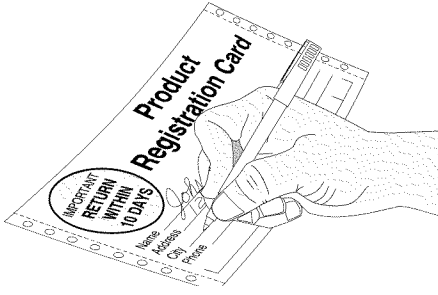

Read and Save These Instructions

These instructions include information which is intended to assure the operator of correct installation, operation and service. Before attempting installation, adjustment or maintenance, be certain of the following:

- That you have read and fully understand the instructions.
- That you have all the tools required and are trained to use them.
- That you have met all installation and usage restrictions and are familiar with the functions and operations of the unit.
- That you follow all instructions exactly as given.

All the fittings, measurements, recommendations and procedures are significant. Substitutions and approximations must be avoided. Improper handling, maintenance, installation and adjustment, or service attempted by anyone other than a qualified technician, may void the future warranty claims and cause damage to the unit and/or result in injury to the operator and/or bystanders.

Record your Model and Serial Numbers

Record the model number and serial number of this appliance in the space provided below (the serial plate is located inside the cabinet compartment).

Model Number: _____

Serial Number: _____

Purchase Date: _____

Register Your Product

The self-addressed **PRODUCT REGISTRATION CARD** (shown above) should be filled in completely, signed and returned to the address provided.

Read all instructions before using this appliance.



WARNING

For Your Safety

Do not store or use gasoline or other flammable vapors and liquids in the vicinity of this unit or any other appliance. Read product labels for flammability and other warnings.



WARNING

Child Safety

- Destroy carton, plastic bags, and any exterior wrapping material immediately after the appliance is unpacked. Children should never use these items for play. Cartons covered with rugs, bedspreads, plastic sheets or stretch wrap may become airtight chambers and can quickly cause suffocation.
- Remove all staples from the carton. Staples can cause severe cuts, and destroy finishes if they come in contact with other appliances or furniture.
- An empty, discarded ice box, refrigerator, or freezer is a very dangerous attraction to children.
- Remove and discard any spacers used to secure the shelves during shipping. Small objects are a choke hazard to children.

Proper Disposal of Appliance



WARNING

Risk of Child Entrapment

Child entrapment and suffocation are not problems of the past. Junked or abandoned refrigerators or freezers are still dangerous – even if they will sit for “just a few days”. If you are getting rid of your old refrigerator or freezer, please follow the instructions below to help prevent accidents:

- Remove the lid.
- Have the refrigerator removed by a qualified technician.

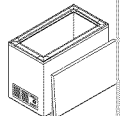

Important Safety Instructions

Electrical Information



WARNING

These guidelines must be followed to ensure that safety mechanisms in the design of this appliance will operate properly.



WARNING

Avoid fire hazard or electric shock. Do not use an extension cord or an adapter plug. Do not remove any prong from the power cord.

Grounding type wall receptacle

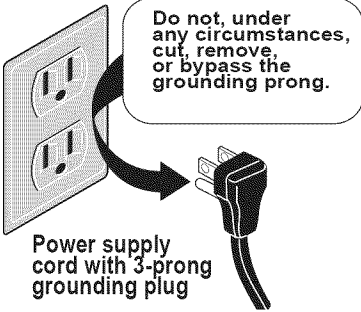

- Refer to the serial plate for correct electrical rating. The power cord of the appliance is equipped with a three-prong grounding plug for protection against shock hazards. It must be plugged directly into its own properly grounded three-prong receptacle, protected with a 15-amp time delay fuse or circuit breaker. The receptacle must be installed in accordance with the local codes and ordinances. Consult a qualified electrician. Receptacles with Ground Fault Circuit Interrupters (GFCI) are NOT RECOMMENDED. DO NOT USE AN EXTENSION CORD OR AN ADAPTER PLUG.
- If the voltage varies by 10 percent or more, appliance performance may be affected. Operating the appliance with insufficient power can damage the compressor. Such damage is not covered under the warranty. If you suspect your voltage is high or low, consult your power company for testing.
- To prevent the appliance from being turned off accidentally, do not plug the unit into an outlet controlled by a wall switch or pull cord.
- DO NOT pinch, knot, or bend the power cord in any manner.

Other Precautions



WARNING

- **NEVER** unplug the appliance by pulling on the power cord. Always grip the plug firmly and pull straight out from the receptacle.
- To avoid electrical shock, unplug the appliance before cleaning.



NOTE

Turning the control to "OFF" turns off the compressor but does not disconnect power to other electrical components.

First Steps

Inspection for Damage

Inspect the underside of the cabinet and packaging for damage, similar to what can be caused with a forklift. If hidden damage is found after uncrating, immediately call the delivery carrier and request an inspection. Retain all packaging and crating materials until the inspection is complete.

Parts and Accessories

- Using a utility knife with a sharp, short blade, cut along the perimeter of the carton as indicated.
- Lift the carton off the product.
- Remove the package containing the casters from the unit.

First Steps

The following tools are required to assemble and install the casters to the unit:

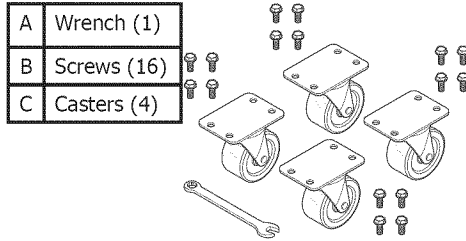

Caster Set-up

1. With an assistant, tilt the unit until it is resting on its back. Take care to protect the back from being scratched during this process.
2. Using the wrench provided and the sixteen (16) screws, install all four (4) casters in the tapped holes in the bottom of the unit. Tighten the screws securely.
3. With an assistant, tilt the unit back up onto its casters.
4. To prevent unintended movement, block casters once the unit is in place.

Appliance Placement

Leave a three (3) inch space on all sides and the back of the cabinet for ease of installation, proper air circulation and electrical connections. Choose a place that is near a grounded electrical outlet. For the most efficient operation, the appliance should be located where surrounding temperatures will not drop below 40°F (5°C) or exceed 110°F (43°C). Additional compressor heaters are not recommended.

Insulation

The insulated space of this cabinet is sealed to maintain peak efficiency. DO NOT drill holes in the cabinet. Holes drilled in the cabinet may destroy that seal and damage electrical wiring located in the insulated space. It may also pierce and damage the sealed refrigeration system in the insulated space.

DAMAGED ELECTRICAL WIRING OR WET INSULATION CAUSED BY DRILLING WILL VOID THE WARRANTY.

Glass Lid Models

- There are two (2) glass lids, a smaller one that fits in the lower track of the ice cream freezer and a larger one that fits in the upper track. The lower track has two (2) round retaining studs and the upper has four (4) round retaining studs.
- Install the lower glass first. Again, the lower glass is the smaller of the two. It has a flexible vinyl seal and a lock plate. The flexible seal should be facing up and positioned on the end away from the two round retaining studs. Place the panel in the center and slide along the lower track until it is secure under the two retaining studs.
- Place the upper glass panel over the lower glass panel already in place. Slide it over the lower lid past the flexible seal. You will notice a slight resistance with the lower lid gasket. Slide the upper panel under the four studs on the upper track of the frame.
- When properly installed, there is a seal formed by the flexible vinyl seal between the two glass lids.

First Steps

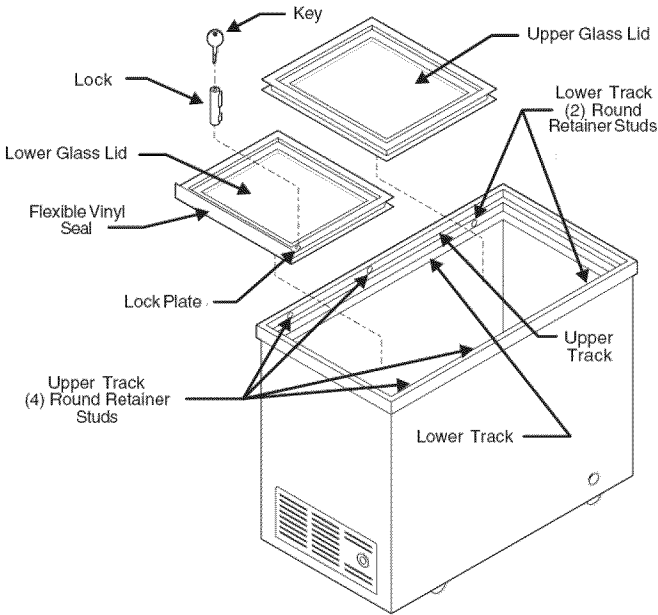

Appliance Start-up

Once the appliance has been located in its permanent location and the proper power and grounding has been provided, the following items must be checked or completed:

Cool Down Period

For safe food storage, allow 24 hours for the appliance to cool down completely before loading with food. The appliance will run continuously for the first several hours. Do not place any food in the appliance until after the first 24 hours of operation.

Thermostat Setting

The appliance is shipped from the factory with the thermostat set at about the mid-point of the operating range. Adjustments colder or warmer can be made after the appliance has been running for at least 8 hours. Allow at least 8 hours for temperature stabilization before re-adjusting the thermostat.

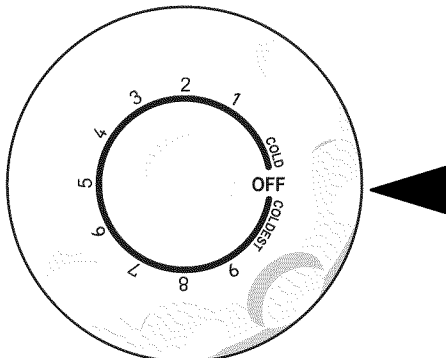

Features

Interior Lighting (some chest models)

The light comes on automatically when the lid is opened. To replace the light bulb, turn the temperature control to "OFF" and **UNPLUG THE ELECTRICAL CORD**. Replace the old bulb with a bulb of the same type and wattage.

Four (4) Swivel Casters

The freezer comes with four (4) swivel casters. The casters allow the appliance to be moved with ease. Refer to the First Steps section for caster installation instructions.

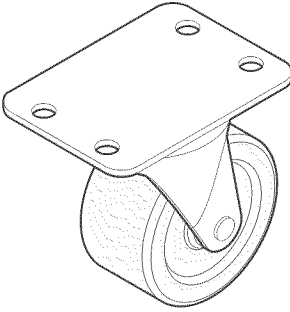

Commercial Grade Basket

The **NSF** certified basket helps organize odd-shaped items. To reach other packages in the freezer, slide the basket aside or lift out.

Security Lock

This security lock fastens the lid snugly, ensuring that stored food is secure. To lock or unlock the freezer, slide the key into the lock and turn. The key pops out of the lock after it has been turned.

Adjustable Temperature Control

The adjustable thermostat control is located on the left outside wall of the unit.

Interior Thermometer

The appliance comes with an **NSF** certified thermometer to show internal temperatures. The thermometer is attached to the plastic interior lid panel on commercial chest freezers and on the wire basket on ice cream freezers.

MaxFreeze Switch (some chest models)

When the Max Freeze setting is activated, the LED on the rocker switch will light up. This setting puts the compressor in a fulltime run mode and overrides the thermostatic control. This in turn results in constant cooling of the

freezer and provides the fastest freezer cool down period.

In most conditions the MaxFreeze setting will maintain lower freezer compartment temperatures than would the Normal setting. The Normal setting can be used to save energy when rapid cool down times aren't needed or when constantly maintaining the lowest temperature is not required.

To return the freezer back to normal operating mode, push the switch to the normal position.

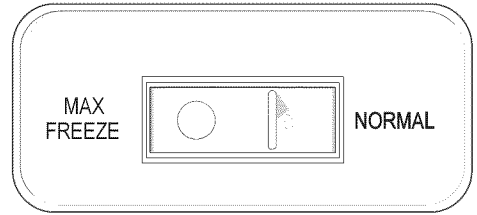

Care and Cleaning

Between Defrosting

To avoid frequent defrosting, occasionally use a plastic scraper to remove frost. Scrape with pulling motion. **NEVER** use a metal instrument to remove frost.

Defrosting

It is important to defrost and clean the freezer when $\frac{1}{4}$ to $\frac{1}{2}$ inch of frost has accumulated. Frost may tend to accumulate faster on the upper part of the freezer due to warm, moist air entering the freezer when the lid is opened. Remove food and leave the lid open when defrosting the freezer.

To use the defrost drain, place a shallow pan beneath the drain outlet (Figure 1). Pull out the drain plug inside the freezer, and pull off the outside defrost drain plug (Figure 2). Defrost water will drain out. Check pan occasionally so water does not overflow. Replace the drain plugs when defrosting is completed.

Care and Cleaning

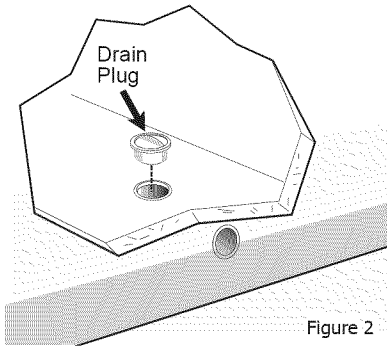
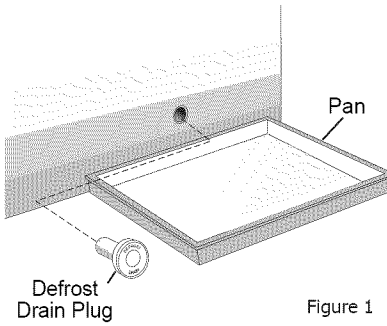

If the frost is soft, remove it by using a plastic scraper. If the frost is glazed and hard, fill deep pans with hot water and place them on the freezer bottom. Close the freezer lid. Frost should soften in about 15 minutes. Repeat this procedure if necessary.

Cleaning

After defrosting, wash inside and outside surfaces of the freezer with a solution of two (2) tablespoons of baking soda in one (1) quart (1.136 liters) warm water. Rinse and dry. Wring excess water out of the sponge or cloth when cleaning in the area of the controls, or any electrical parts.

Wash the removable parts with the baking soda solution mentioned above, or mild detergent and warm water. Rinse and dry. **NEVER** use metallic scouring pads, brushes, abrasive cleaners, or alkaline solutions on any surface. **DO NOT** wash removable parts in a dishwasher. Replace parts and food.

Periods of Non-use and Moving Tips

Leave the appliance operating during periods of non-use of less than three (3) weeks.

Long Periods of Non-use

If the appliance will not be used for several months:

- Remove all food and unplug the power cord.
- Clean and dry the interior thoroughly.
- Leave the appliance door open slightly, blocking it open if necessary, to prevent odor and mold growth.

Moving

When moving the appliance, follow these guidelines to prevent damage:

- Disconnect the power cord plug from the wall outlet.
- Remove foods, then defrost, and clean the appliance.
- Secure all loose items such as base panel, baskets, and shelves by taping them securely in place to prevent damage.
- In the moving vehicle, secure appliance in an upright position to prevent movement. Also, protect outside of appliance with a blanket or similar item.

Energy-Saving Tips

This appliance is designed for efficiency with heavy foam insulation. However, there are things that the user can do to maintain the appliance in operating condition.

- Do not operate the appliance any colder than necessary to maintain safe, product storage temperatures.
- Make sure the appliance is located to prevent direct exposure to sunlight, air ducts, etc.
- Keep the lid closed except for normal use. Inspect the door often to see that it self-closes and the gaskets are in good condition.
- Do not overstock the product in the cabinet because it will block the normal air flow. See illustration below:

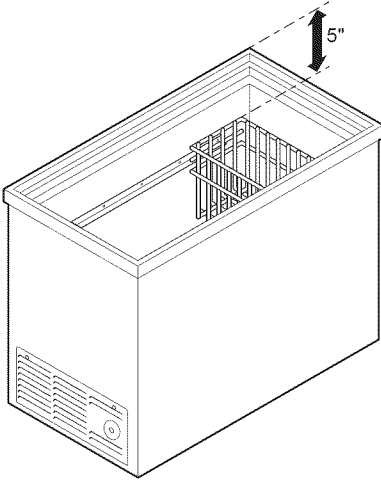

- Have at least annual inspections by a qualified service company to see that the refrigerant charge is correct.
- This appliance operates more efficiently in a cooler ambient temperature than in a hot ambient temperature. Try to maintain an ambient temperature below 80°F (27°C) and 65% RH (Relative Humidity) for maximum efficiency.

Power Failure



WARNING

Do not open freezer door unnecessarily if freezer is off for several hours.

If a power failure occurs, pack seven or eight pounds of dry ice into the freezer every 24 hours. Look in the Yellow Pages under "Dry Ice", "Dairies", or "Ice Cream Manufacturers" for local dry ice suppliers. Always wear gloves and use caution when handling dry ice.

Before You Call

TROUBLESHOOTING GUIDE	Before calling for service, review this list. It may save you time and expense. This list includes common occurrences that are not the result of defective workmanship or materials in this appliance.	
PROBLEM	CAUSE	CORRECTION
APPLIANCE OPERATION		
Appliance does not run.	<ul style="list-style-type: none"> • Appliance is plugged into a circuit that has a ground fault interrupt. • Temperature control is in the "OFF" position. • Appliance may not be plugged in, or plug may be loose. • House fuse blown or tripped circuit breaker. • Power outage. 	<ul style="list-style-type: none"> • Use another circuit. If you are unsure about the outlet, have it checked by a certified technician. • See Thermostat Setting. • Ensure plug is tightly pushed into outlet. • Check/replace fuse with a 15-amp time delay fuse. Rest circuit breaker. • Check house lights. Call local electric company.
Appliance runs too much or too long.	<ul style="list-style-type: none"> • Room or outside weather is hot. • Appliance has recently been disconnected for a period of time. • Large amount of warm or hot food have been stored recently. • Door is opened too frequently or kept open too long. • Appliance door may be slightly ajar. • Temperature control is set too low. • Appliance gaskets are dirty, worn, cracked or poorly fitted. • MaxFreeze switch is "ON". 	<ul style="list-style-type: none"> • It's normal for the appliance to work harder under these conditions. • It takes 24 hours for the appliance to cool down completely. • Warm food will cause appliance to run more until the desired temperature is reached. • Warm air entering the appliance causes it to run more. Open the door less often. • See "Door Problems". • Turn control knob to a warmer setting. Allow several hours for the temperature to stabilize. • Clean or change gasket. Leaks in the lid seal will cause appliance to run longer in order to maintain desired temperature. • Deactivate Maxfreeze switch.
Interior appliance temperature is too cold.	<ul style="list-style-type: none"> • Temperature control is set too low. • MaxFreeze switch is "ON". 	<ul style="list-style-type: none"> • Turn control knob to a warmer setting. Allow several hours for the temperature to stabilize. • Deactivate Maxfreeze switch.
Interior appliance temperature is too warm.	<ul style="list-style-type: none"> • Temperature control is set too warm. • Lid is open too frequently or kept open too long. • Large amount of warm or hot food have been stored recently. • Appliance has recently been disconnected for a period of time. 	<ul style="list-style-type: none"> • Turn control knob to a colder setting. Allow several hours for the temperature to stabilize. • Warm air entering the appliance causes it to run more. Open the door less often. • Wait until the appliance has had a chance to reach its selected temperature. • Appliance requires 24 hours to cool down completely.
Appliance external surface temperature is warm.	<ul style="list-style-type: none"> • The external appliance walls can be as much as 30°F warmer than room temperature. 	<ul style="list-style-type: none"> • This is normal while the compressor works to transfer heat from inside the appliance cabinet.

Before You Call

PROBLEM	CAUSE	CORRECTION
SOUND AND NOISE		
Louder sound levels whenever appliance is on.	<ul style="list-style-type: none"> Modern appliances have increased storage capacity and more stable temperatures. They require heavy-duty compressors. 	<ul style="list-style-type: none"> This is normal. When the surrounding noise level is low, you may hear the compressor running while it cools the interior.
Louder sound levels when compressor comes on.	<ul style="list-style-type: none"> Appliance operates at higher pressures during the start of the ON cycle. 	<ul style="list-style-type: none"> This is normal. Sound will level off or disappear as appliance continues to run.
Popping or cracking sound when compressor comes on.	<ul style="list-style-type: none"> Metal parts undergo expansion and contraction, as in hot water pipes. 	<ul style="list-style-type: none"> This is normal. Sound will level off or disappear as appliance continues to run.
Bubbling or gurgling sound.	<ul style="list-style-type: none"> Refrigerant (used to cool appliance) is circulating throughout the system. 	<ul style="list-style-type: none"> This is normal.
Vibrating or rattling noise.	<ul style="list-style-type: none"> Appliance is not level. It rocks on the floor when it is moved slightly. Floor is uneven or weak. Appliance is touching the wall. 	<ul style="list-style-type: none"> Level the appliance by putting wood or metal shims under part of the appliance. Ensure floor can adequately support appliance. Level the appliance. Re-level appliance or move appliance slightly.
WATER/MOISTURE/FROST INSIDE APPLIANCE		
Moisture forms on inside appliance walls.	<ul style="list-style-type: none"> Weather is hot and humid, which increases internal rate of frost build-up. 	<ul style="list-style-type: none"> This is normal.
ODOR IN APPLIANCE		
Odors in appliance.	<ul style="list-style-type: none"> Interior needs to be cleaned. Food with strong odors are in the appliance. 	<ul style="list-style-type: none"> Clean interior with sponge, warm water, and baking soda. Cover the food tightly.
DOOR PROBLEMS		
Door will not close.	<ul style="list-style-type: none"> Appliance is not level. It rocks on the floor when it is moved slightly. Floor is uneven or weak. 	<ul style="list-style-type: none"> Level the appliance by putting wood or metal shims under part of the appliance. Ensure floor can adequately support appliance. Level the appliance by putting wood or metal shims under part of the appliance.
LIGHTING PROBLEMS		
Light bulb is not on.	<ul style="list-style-type: none"> The fluorescent lamp or light bulb is burned out. No electric current is reaching the appliance. 	<ul style="list-style-type: none"> See "Fluorescent Lamp" or "Interior Light" in Features section. See "Appliance does not run".

IMPORTANT

SAFETY NOTICE

The information provided herein is designed to assist qualified repair personnel only. Untrained persons should not attempt to make repairs due to the possibility of electrical shock. Disconnect the power cord before servicing.

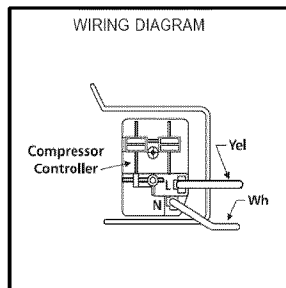
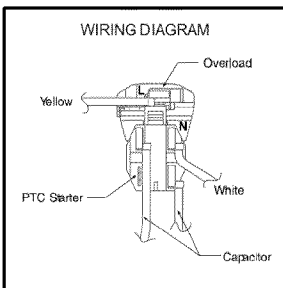
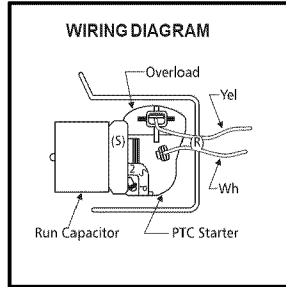
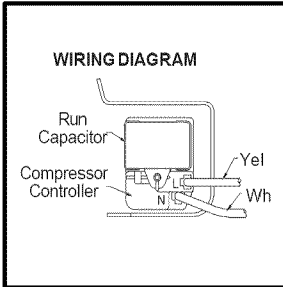
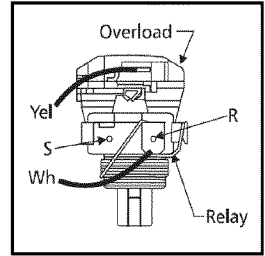
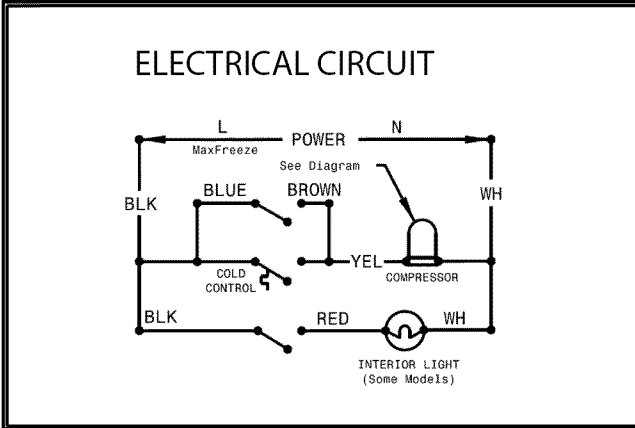

IMPORTANT

IF ANY GREEN GROUNDING WIRES ARE REMOVED DURING SERVICING, THEY MUST BE RETURNED TO THEIR ORIGINAL POSITION AND PROPERLY SECURED.

Kelvinator Commercial Appliance Warranty Information

Your appliance is covered by a **three (3) year limited warranty**. For three (3) years from your original date of purchase, Electrolux will pay all costs, except as set forth below, for repairing or replacing any parts of this appliance that prove to be defective in materials or workmanship when such appliance is installed, used, and maintained in accordance with the provided instructions. For appliances that are manufactured with a compressor, an additional two (2) year part warranty is provided for the compressor only.

Exclusions

This warranty does not cover the following:

1. Products where the original serial number has been removed, altered or cannot be readily determined.
2. Normal wear and tear and gradual deterioration.
3. Product that has been transferred from its original owner to another party or moved outside the USA or Canada.
4. Rust on the interior or exterior of the unit.
5. Products purchased "as-is".
6. Food loss due to any refrigerator or freezer failures.
7. Damage caused at any time during shipment.
8. Service calls which do not involve malfunction or defects in materials or workmanship, or for appliances used other than in accordance with the provided instructions.
9. Service calls to correct the installation of your appliance or to instruct you how to use your appliance.
10. Expenses for making the appliance accessible for servicing, such as removal of trim, cupboards, shelves, etc., which are not a part of the appliance when it is shipped from the factory.
11. Service calls to replace appliance light bulbs, air filters, water filters, and other consumables, or knobs, handles, and other cosmetic parts.
12. Surcharges including, but not limited to, any after hours, weekend, or holiday service calls, tolls, ferry trip charges, or mileage expense for service calls to remote areas, including the state of Alaska.
13. Damages to the finish of the appliance and/or the appliance location that are incurred during installation, including but not limited to floors, cabinets, walls, etc.
14. Damages caused by: services performed by unauthorized service companies; use of parts other than genuine Electrolux parts or parts obtained from persons other than authorized service companies; or external causes such as abuse, misuse, inadequate power supply, accidents, fires, or acts of God.
15. For appliances operated by a concessionaire or vendor in a trailer or other motorized vehicle, or at varying locations, your appliance is covered by a one (1) year, limited parts and labor warranty. For appliances that are manufactured with a compressor, an additional four (4) year part warranty is provided for the compressor only.

DISCLAIMER OF IMPLIED WARRANTIES; LIMITATION OF REMEDIES

CUSTOMER'S SOLE AND EXCLUSIVE REMEDY UNDER THIS LIMITED WARRANTY SHALL BE PRODUCT REPAIR OR REPLACEMENT AS PROVIDED HEREIN. CLAIMS BASED ON IMPLIED WARRANTIES, INCLUDING WARRANTIES OF MERCHANTABILITY OR FITNESS FOR A PARTICULAR PURPOSE, ARE LIMITED TO ONE (1) YEAR OR THE SHORTEST PERIOD ALLOWED BY LAW, BUT NOT LESS THAN ONE (1) YEAR. ELECTROLUX SHALL NOT BE LIABLE FOR CONSEQUENTIAL OR INCIDENTAL DAMAGES SUCH AS PROPERTY DAMAGE AND INCIDENTAL EXPENSES RESULTING FROM ANY BREACH OF THIS WRITTEN LIMITED WARRANTY OR ANY IMPLIED WARRANTY. SOME STATES AND PROVINCES DO NOT ALLOW THE EXCLUSION OR LIMITATION OF INCIDENTAL OR CONSEQUENTIAL DAMAGES, OR LIMITATIONS ON THE DURATION OF IMPLIED WARRANTIES, SO THESE LIMITATIONS OR EXCLUSIONS MAY NOT APPLY TO YOU. THIS WRITTEN WARRANTY GIVES YOU SPECIFIC LEGAL RIGHTS. YOU MAY ALSO HAVE OTHER RIGHTS THAT VARY FROM STATE TO STATE.

If You Need Service Keep your receipt, delivery slip, or some other appropriate payment record to establish the warranty period should service be required. If service is performed, it is in your best interest to obtain and keep all receipts. Service under this warranty must be obtained by contacting Electrolux at the addresses or phone numbers below.

This warranty only applies in the USA and Canada. In the USA, your appliance is warranted by **Electrolux Major Appliances North America, a division of Electrolux Home Products, Inc.** In Canada, your appliance is warranted by **Electrolux Canada Corp.** Electrolux authorizes no person to change or add to any obligations under this warranty. Obligations for service and parts under this warranty must be performed by Electrolux or an authorized service company. Product features or specifications as described or illustrated are subject to change without notice.

A00915201/A (January 2014)

USA
1.866.738.1640
Electrolux Major Appliances
North America
10200 David Taylor Drive
Charlotte, NC 28262



Canada
1.800.265.8352
Electrolux Canada Corp.
5855 Terry Fox Way
Mississauga, Ontario, Canada
L5V 3E4