



Earn BISSELL Rewards!

Register your product today!

See details on back page

TOTAL FLOORS®
MULTI SURFACE | MULTI CYCLONIC
pet
USER'S GUIDE
61C5-G

- 2 Thank You
- 3 Safety Instructions
- 4 Product View
- 5-7 Assembly
- 7-9 Operations
- 10-15 Maintenance and Care
- 16 Troubleshooting
- 17 Replacement Parts
- 18 Accessories
- 19 Warranty
- 20 Product Registration
- 20 Consumer Care

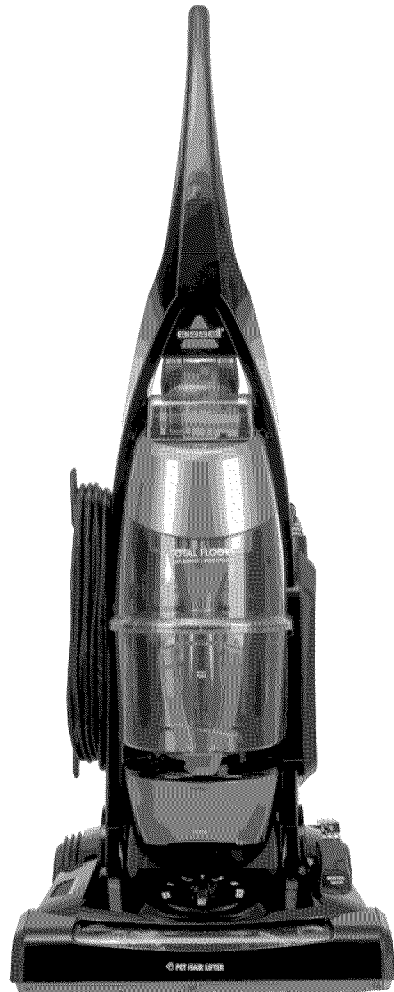



Thanks for buying a BISSELL Total Floors® Vacuum

We're glad you purchased a BISSELL Total Floors® vacuum. Everything we know about floor care went into the design and construction of this complete, high-tech home cleaning system.

Your BISSELL Total Floors® vacuum is well made, and we back it with a limited four-year warranty. We also stand behind it with a knowledgeable, dedicated Consumer Care department, so, should you ever have a problem, you'll receive fast, considerate assistance.

My great-grandfather invented the floor sweeper in 1876. Today, BISSELL is a global leader in the design, manufacture, and service of high quality homecare products like your Total Floors® vacuum.

Thanks again, from all of us at BISSELL.

Mark J. Bissell
Chairman & CEO



IMPORTANT SAFETY INSTRUCTIONS

When using an electrical appliance, basic precautions should be observed, including the following:

READ ALL INSTRUCTIONS BEFORE USING YOUR UPRIGHT VACUUM.

⚠ WARNING:

To reduce the risk of fire, electric shock, or injury:

- Always connect to a polarized outlet (left slot is wider than right). Unplug from outlet when not in use and before conducting maintenance.
- Do not modify the polarized plug to fit a non-polarized outlet or extension cord.
- Do not leave vacuum cleaner unattended when it is plugged in.
- Unplug from outlet when not in use and before servicing.
- Unplug before attaching the TurboBrush Tool.
- Do not use outdoors or on wet surfaces.
- Do not allow children to operate vacuum cleaner or use as a toy.
- Close attention is necessary when used by or near children.
- Do not use for any purpose other than described in this user's guide.
- Use only manufacturer's recommended attachments.
- Do not use with damaged cord or plug.
- If appliance is not working as it should, has been dropped, damaged, left outdoors, or dropped into water, have it repaired at an authorized service center.
- Do not pull or carry by cord, use cord as a handle, close a door on cord, or pull cord around sharp edges or corners. Do not run appliance over cord. Keep cord away from heated surfaces.
- Do not unplug by pulling on cord. To unplug, grasp the plug, not the cord.
- Do not handle vacuum cleaner or plug with wet hands.
- Do not put any object into openings. Do not use with any opening blocked; keep openings free of dust, lint, hair, and anything that may reduce air flow.
- Keep hair, loose clothing, fingers, and all parts of body away from openings and moving parts.
- Turn off all controls before plugging or unplugging vacuum cleaner.
- Use extra care when cleaning stairs.

- Do not pick up flammable materials (lighter fluid, gasoline, kerosene, etc.) or use in the presence of explosive liquids or vapors.
- Do not pick up toxic material (chlorine bleach, ammonia, drain cleaner, etc.).
- Do not use vacuum cleaner in an enclosed space filled with vapors given off by oil base paint, paint thinner, some moth proofing substances, flammable dust, or other explosive or toxic vapors.
- Do not pick up hard or sharp objects such as glass, nails, screws, coins, etc.
- Do not pick up anything that is burning or smoking, such as cigarettes, matches, or hot ashes.
- Do not use without filters in place.
- Use only on dry, indoor surfaces.
- Keep appliance on a level surface.
- Do not carry the vacuum cleaner while it is running.

SAVE THESE INSTRUCTIONS.

THIS MODEL IS FOR HOUSEHOLD USE ONLY. Commercial use of this unit voids the manufacturer's warranty.

THIS APPLIANCE HAS A POLARIZED PLUG.

To reduce the risk of electric shock, this appliance has a polarized plug (one blade is wider than the other). This plug will fit in a polarized outlet only one way. If the plug does not fit fully in the outlet, reverse the plug. If it still does not fit, contact a qualified electrician to install a proper outlet. Do not change the plug in any way.

Product view

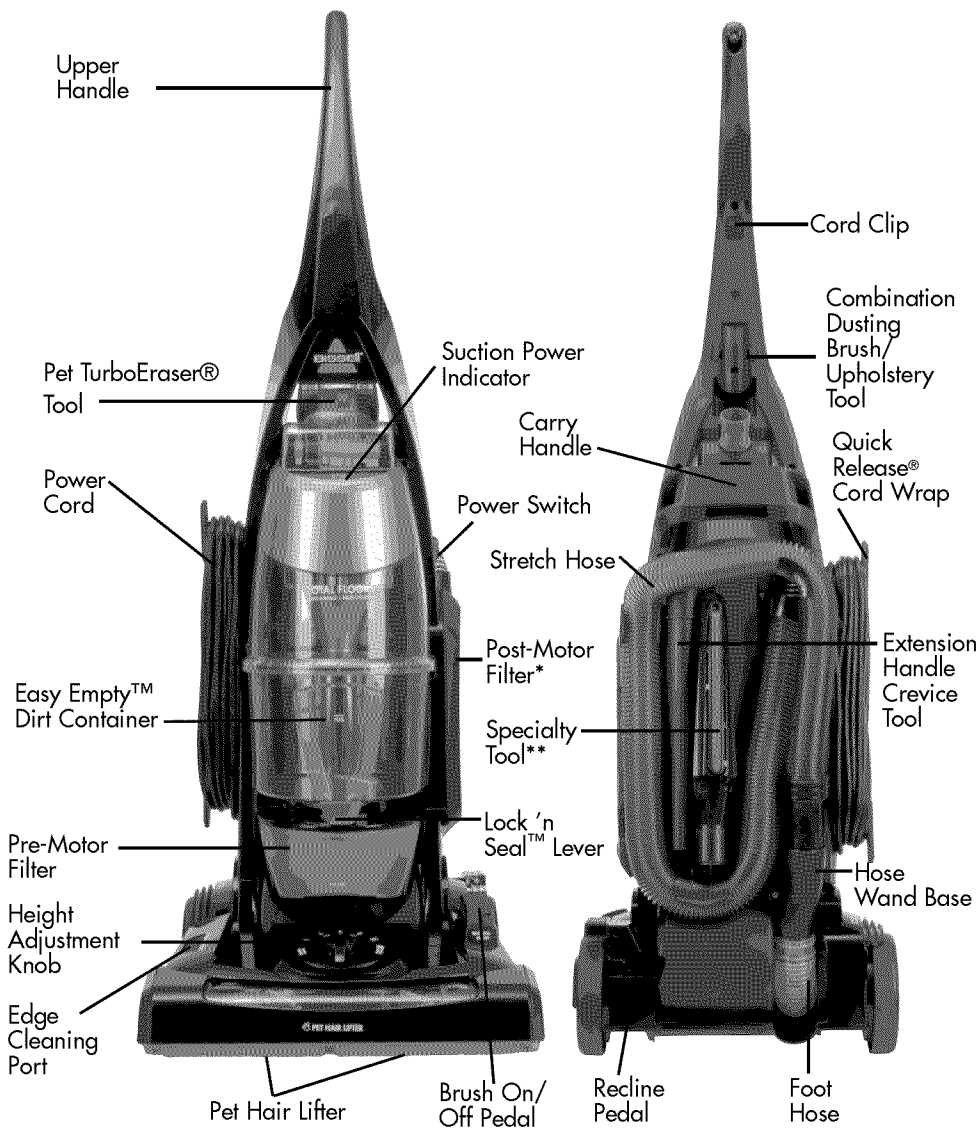

⚠ WARNING:

Do not plug in your vacuum cleaner until you are familiar with all instructions and operating procedures.

*Select models include a Febreze® post-motor filter. For ordering information, turn to page 17.

**Select models may include Pet Hair Fabric Tool or Long Reach Dusting Tool

Febreze® and related trademarks are owned by The Procter & Gamble Company, Cincinnati, Ohio and used under license by BISSELL, Inc.

Assembly

The only tool you'll need to assemble your vacuum cleaner is a Phillips screwdriver.
Locate and install filters

IMPORTANT: Before using your vacuum, make sure that all filters (pre-motor and post-motor) are in place. Do not operate your vacuum without these filters. Your Total Floors vacuum comes pre-loaded with a post-motor foam filter. If you wish to use the post-motor Febreze® filter instead, locate the Febreze® filter in the vacuum carton and remove the filter from its packaging. Next, remove the post-motor foam filter from the filter door and insert the Febreze® filter in its place as is shown to the right (A). Do not use your vacuum without one of these filters in place. Do not use both filters together.

Attach handle to vacuum

1. Locate the carry handle. Remove the screw packet taped to the carry handle. There are three screws in this screw packet. Two screws are used to attach the upper handle and carrying handle to the vacuum base. One screw is used to attach the hose guide/tool caddy.
2. Stand the vacuum upright. From the back of the vacuum body, slide the base of the upper handle firmly into the grooves at the top of the vacuum body. Continue to push so that there are no gaps and the front of the handle is flush with the vacuum body.
3. With the upper handle firmly placed on the vacuum body, guide the carrying handle into place onto the back of the upper handle and insert two of the screws into the existing holes. (Reference the rear-facing product view on page 4 to see how the carry handle should look). Tighten screws securely with a Phillips screwdriver to anchor the carry handle to the upper handle and the upper handle to the vacuum body.

Attach the vacuum hose & tools

1. Attach the 3 hose/tool storage pieces to the back of the unit.
 - a. Attach the tool storage clip to the back of the handle by snapping the piece into the unit as shown. Push piece straight in until it snaps into place.
 - b. Attach the hose guide clip to the left side of the back of the vacuum. Insert tab at a 45 degree angle and turn clockwise so it snaps into place.

WARNING:

Plastic film can be dangerous. To avoid danger or suffocation, keep away from babies and children.

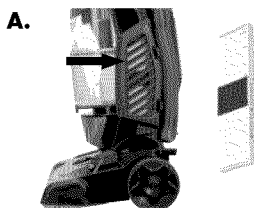

1.



2.

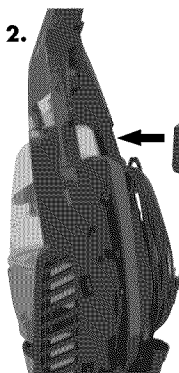

3.

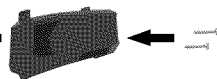

a.

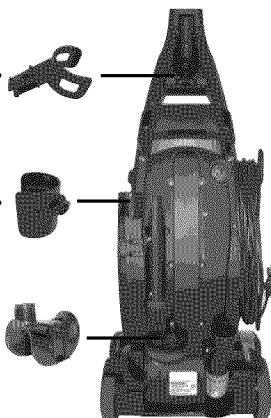

b.



c.



Attach the vacuum hose & tools continued

- c. The hose guide/tool caddy should be attached at the bottom of the back of the vacuum. Slide into place and insert screw into the existing hole. Tighten securely with a Phillips screwdriver.
2. Line up the tabs of the Twist n' Snap hose with the corresponding notches and turn clockwise. Slide the end of the hose into the hose wand base. Hose wraps on back of unit as shown on page 4.
3. Place the Pet TurboEraser Tool into its holder from the front of the vacuum.

Power cord

To store the power cord, wrap cord around the upper and lower cord wrap on the side of the vacuum. To release the power cord, rotate the upper cord wrap down and gently pull off cord.

Power switch

The power switch is located just below the carrying handle on the side of the vacuum. Push the rocker switch **"ON" (I)** to vacuum, and **"OFF" (O)** when cleaning is complete.

Brush Roll Power

The rotating brush ON/OFF pedal is located on the foot of the vacuum. You can use your foot to engage or disengage this pedal (A). When the brush roll pedal has been engaged, the brush will start rotating. The brush roll should be turned on for most carpeted floors. To turn the brush roll off, disengage the pedal by pressing on it with your foot. We recommend turning off the brush roll for bare floor cleaning to prevent scatter or for other delicate surfaces.

Edge Suction

To make edge cleaning more convenient, remove the hose from the hose wand base and attach the crevice tool. Insert the crevice tool into the port on the foot of the vacuum (B). Suction is now diverted to the front corner of the vacuum and you can clean along edges and into corners. It is recommended you turn off the brush roll when using this feature.

NOTICE:

The brush roll continues to rotate while using your vacuum for above floor cleaning. To prevent carpet damage, turn the brush roll off and do not lean on vacuum or tilt forward.

CAUTION:

Before using your vacuum, make sure that the dirt container is in the locked position and that all filters (pre-motor and post-motor) are in place. Do not operate your vacuum without these filters.

Tip:

Your vacuum features a quick-release cord wrap. To remove the power cord quickly and easily, rotate the upper cord wrap towards the floor, and slip the cord off.

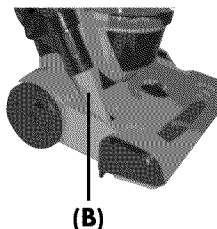
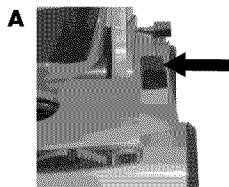

Tip:

Do not use extension wand when using the Edge Suction Feature.

Assembly

Handle Positions

Using your foot, press the handle release pedal, located on the lower left side of the vacuum to recline to a cleaning position.

1. **Upright** – For storage and above floor cleaning with tools.
2. **Normal Cleaning** – Press handle release pedal once. This position is used for most household floor cleaning tasks.

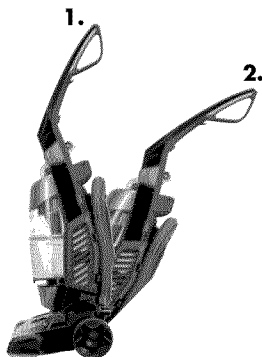

Operations

Transporting your cleaner

1. To move your vacuum cleaner from room to room, put the handle in the upright position, tilt the cleaner back on its rear wheels and push forward.
2. The vacuum cleaner can also be moved by using the carry handle on the back.

Height Adjustments

There are seven height settings available for various floor surfaces. Turn the dial on the foot of the cleaner to the desired setting.

Lowest setting – for low pile carpeting or bare floors. To pick up debris it may be necessary to move up one setting.

Medium settings – for medium pile carpet.

High setting – for high pile and most shag/frieze carpet.

Note: For optimal carpet cleaning performance, adjust to the lowest practical setting. If your cleaner is difficult to push, adjust to the next higher setting.

If the dial is difficult to turn, tilt the cleaner back slightly to take the weight off of the foot while turning.

ATTENTION:

Some frieze carpets have long, delicate fibers or threads that may be damaged by the rotating brush during vacuuming. It is recommended the rotating brush be turned OFF when cleaning this type of carpet.

Tip:

Before cleaning under low furniture, check area first for objects that might harm the unit or block the vacuum hose

Clean filter indicator

The clean filter indicator tells you when the air flow in your vacuum is reduced due to dirty filters or a clog in the hose. The clean filter indicator will remain green until the airflow is reduced. At that time, it begins to change to red. When the indicator is fully red, the airflow is significantly reduced or clogged by a dirty filter. Follow the steps on page 11 to clean your filters or there is a clog in the hose. All filters in the vacuum should be cleaned or replaced when the clean filter indicator turns red. To check and remove the clog, follow the steps on page 12 to check for and clear clogs.

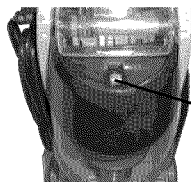

clean filter indicator

NOTE: When your vacuum is turned off, the clean filter indicator will go to the red color setting. The clean filter indicator only detects reductions in airflow when the vacuum power is on.

On-board Tools

Your vacuum is not only a powerful carpet and rug cleaner; it is also a versatile above floor vacuum cleaner when you select one of the special tools.

1. Raise the handle to the upright position.
2. Remove the hose wand from the hose wand base. This automatically diverts the suction to the hose.
3. Use the hose alone or attach any tool by firmly pushing onto the vacuum hose, hose wand, or extension wand. They are a friction fit, so be sure the hose and tool fit snugly together

Dusting brush / upholstery tool:

Two types of cleaning tools are included in one attachment. Slide the tool out to use with or without bristles and switch between the two uses.

- a. Use the dusting brush to dust furniture, blinds, books, lamps, shelves and baseboards.
- b. Slide the brush off to use the upholstery tool on cushions, draperies and fabrics.



NOTICE:

While vacuuming, certain types of carpets and low humidity conditions may generate small static discharges. The discharges are entirely harmless and are not associated in any way with the main power supply

Tip:

It is recommended to turn off the brush roll when the hose is removed and you are using the on-board tools

CAUTION:

Always place the vacuum cleaner on the floor in its fully upright position and make sure it is locked in place when using tools. It is recommended to turn off the brush roll when using tools.

Operations

Pet Hair Fabric Tool **(select models):**

Use this tool on fabrics such as drapes, beds or anywhere else pet hair may collect.



Long Reach Dusting Tool **(select models):**

Use this tool for dusting large surfaces.



Pet TurboEraser Tool:

Use for removing dirt and pet hair from stairs, upholstery, area rugs, and other small areas. Pull the tool towards you in a raking motion.

Note: The Pet TurboEraser Tool is designed to remove pet hair from upholstered or carpeted surfaces. It should not be used on pets.



Emptying the dirt container

Empty the dirt container as soon as the dirt reaches the "fill" line on the front of the cup.

1. Unplug the vacuum from the electrical outlet.
2. Slide the Lock 'n Seal lever to the left.
3. Grasp the handle and pull the dirt cup straight out to remove from the vacuum.
4. Empty dirt into garbage container.

NOTE: Emptying the dirt container after every use will help prevent overfilling, and ensure that the vacuum is ready to go the next time you clean.

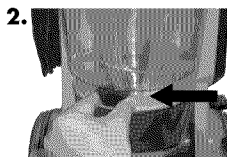

Maintenance and Care

To maximize your cleaning performance and extend the life of your vacuum, it is very important that you empty your dirt container and check and clean your filters frequently. Follow the instructions on the following pages, and perform these simple maintenance steps:

1. Empty the dirt container when the dirt reaches the "Full" line on the container, or more frequently, to prevent overfills.
2. Check the pre-motor and post-motor filter regularly. Clean or replace as needed.

NOTE: Use of moist parts/components in your unit will damage the motor and void your warranty

NOTE: Be sure to clean or replace your filters anytime the clean filter indicator begins to turn red. More frequent filter cleaning may be necessary if you are vacuuming new carpet, fine dust, or have allergy concerns.

Cleaning the dirt container

1. Ensure that the dirt cup has been emptied.
2. While the dirt cup is still out of the unit, grasp the inner cyclone screen and twist to the right until the locking tab stops the rotation. Pull down the inner cyclone screen to remove it.
3. Clean the inner cyclone with a cloth or soft brush to remove dust or debris.
4. Wipe out the inside of the upper tank and the inner cyclone with a damp cloth moistened with water or a mild cleaning detergent.



WARNING:

To reduce the risk of electric shock, turn power switch OFF and disconnect polarized plug from electrical outlet before performing maintenance or troubleshooting checks.

Tip:

For maximum cleaning performance, check and clean or replace all filters as suggested

inner cyclone

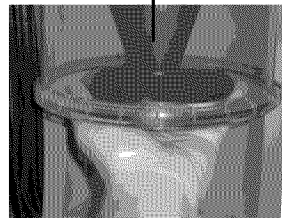

Maintenance and Care

Cleaning the dirt container continued

5. If desired, the lower dirt cup may be washed in warm water. Make sure it is completely dry before reassembling.

NOTE: Do not put in the dishwasher.

NOTE: Use of moist parts/components in your unit will damage the motor and void your warranty

6. To reassemble, replace the inner cyclone screen by sliding it into the upper tank and rotating it to the left until the locking tabs stop the rotation.

Cleaning the pre-motor filter & replacing the post-motor filter

1. Unplug the vacuum from electrical outlet.
2. The pre-motor filter protects the motor from dirt particles. It is located in the slide out tray underneath the dirt container. If the filter becomes dirty, pull out the tray, lift out the foam filter pad and clean it.

NOTE: The pre-motor filter may be hand washed in water with mild detergent. Rinse well and air dry thoroughly before replacing.

NOTE: Use of moist parts/components in your unit will damage the motor and void your warranty

3. The post-motor filter assists in the filtration process to return clean air to the room. It is located behind the door on the side of the vacuum. If the filter becomes dirty, open the door, remove the filter and replace.
4. The Febreze® filter (select models only) is designed to eliminate odors during the regular life of the filter. Depending on usage, the post-motor filter should be changed every 3-6 months.

NOTE: The post-motor filter is a white, pleated filter. This filter is not washable and must be replaced when it becomes dirty.

NOTICE:

Select models feature a Febreze® post-motor filter. For purchasing information, turn to page 17.

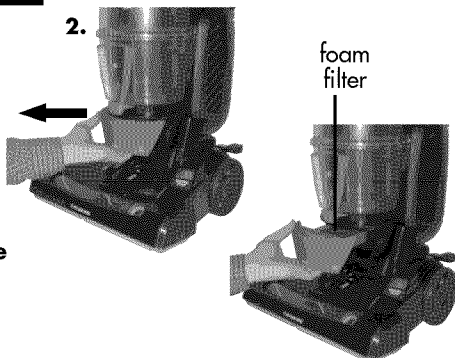

WARNING:

Do not operate vacuum with damp or wet filters, or without all filters in place.

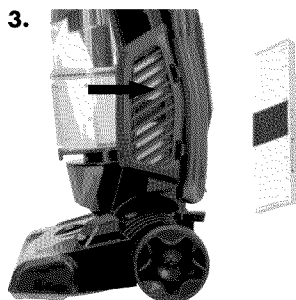

Maintenance and Care

Clearing Clogs

1. Turn the power switch off and unplug the vacuum from the electrical outlet.
2. Check the upper tank for build up or clogs.
3. If you notice dirt build up in the inner cyclone, follow instruction on how to clean the inner cyclone in page 10.
4. Check for a clog in the foot hose & edge cleaning port, the wand or in the hose.

NOTE: When the indicator reads Red, there is a clog in the hose which is diminishing suction power. Remove the clog in the hose to restore full suction power.

5. Remove the Twist 'n Snap hose from the vacuum by turning to the right. Straighten the hose and unclog with a long, narrow object.
6. If you notice debris or dirt clogged in the foot hose, remove it by pulling it out.
7. If the clog persists, follow the instructions for checking the rotating floor brush and drive belt on page 14 and inspect the air passageway for obstructions.

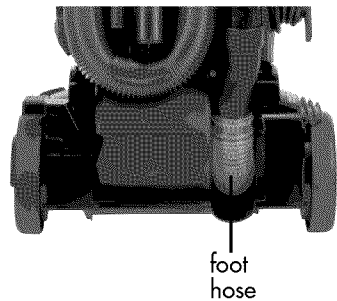

Maintenance and Care

Maintaining the Pet TurboEraser Tool

The Pet TurboEraser Tool should be checked regularly for clogs and debris wrapping around the paddles.

1. Unplug unit from outlet.
2. Remove tool from hose or vacuum.
3. If clog is present or debris is visible, unscrew the two screws on the back of the Pet TurboEraser Tool to remove the faceplate and clear any obstructions.
4. To clean debris remove the paddles from the drive belt and clean debris.
5. Reposition the drive belt on the paddle roll. Place ends of roll in the slots on sides as shown. Reposition faceplate and secure with two screws.

NOTE: The Pet TurboEraser Tool is designed to remove pet hair from upholstered or carpeted surfaces. It should not be used on pets.

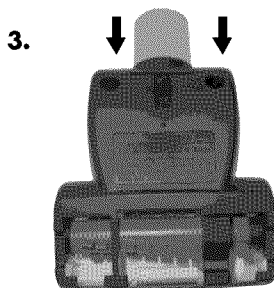

Check rotating floor brush and drive belt

You should check your vacuum cleaner's rotating floor brush and drive belt regularly for wear or damage. You should also clean the brush and the brush ends of strings, hair and carpet fibers. This type of debris can wrap around the brush and hamper its ability to effectively clean your carpet. Also remove any debris that has accumulated under the brush cover.

1. Turn the power switch off and unplug the vacuum from the electrical outlet.
2. Place handle in low position and turn the vacuum cleaner over so the bottom side is facing up.
3. Unscrew and lift off the brush cover.
4. Remove the rotating floor brush.
5. Clean strings, hair and other debris from the rotating floor brush, paying particular attention to brush ends.
6. Clean strings, hair and other debris from the motor pulley, drive belt areas, and the brush ON/OFF power switch mechanism.
7. Check the drive belt carefully for wear, cuts, or stressed areas.
8. Check air passageway for obstructions. Remove debris from this area.
9. Replace belt and brush. Rotate brush toward motor pulley to seat the belt properly.
10. Place the brush cover back and secure with its screws.

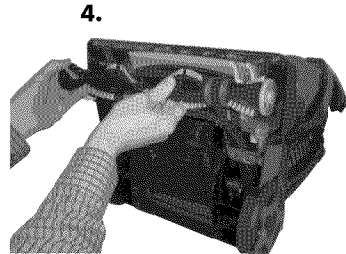
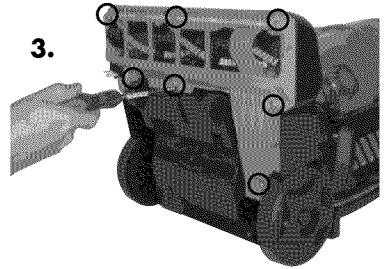

Replace drive belt

1. Turn the power switch off and unplug the vacuum from the electrical outlet. Remove floor brush following steps 2-4 on page 14.
2. With the rotating floor brush removed from the vacuum cleaner, grasp the old drive belt and remove from the motor pulley. Discard the old drive belt.
3. Place the new drive belt over the motor pulley, pass the belt through the opening of the belt ON/OFF mechanism and loop the belt over the rotating floor brush in the space between the bristles.

NOTE: It is important that you use only genuine BISSELL replacement belts. Generic belts may not meet the exact specifications required to keep your vacuum operating at its peak performance. The use of unbranded belts could lead to early failure of the vacuum and could void your warranty.

4. Place ends of the rotating floor brush down into the slots on the sides. Alignment of brush ends is necessary to ensure the brush is fully inserted.
5. Turn the rotating floor brush by hand several times. If properly installed, the drive belt will center itself on the rotating floor brush crown.
6. Place the brush cover back and secure with its screws.

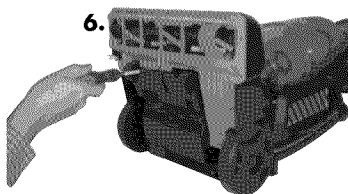
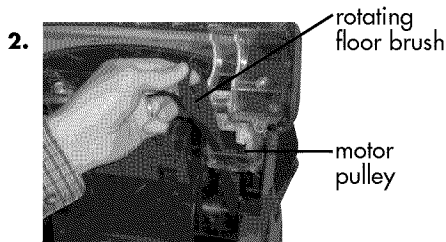

Troubleshooting - Total Floors®

Vacuum cleaner won't turn on

Possible causes

1. Power cord not plugged in
2. Blown fuse/tripped breaker

Remedies

1. Check electrical plug
2. Check/replace fuse or reset breaker

Vacuum cleaner won't pick up dirt

Possible causes

1. Incorrect height adjustment
2. Hose not attached to suction opening
3. Crack or hole in hose
4. Broken or worn drive belt
5. Rotating floor brush bristles worn
6. Rotating floor brush jammed
7. Clog in vacuum- hose/ foot/ body
8. Dirt container full
9. Dirt container or upper tank not installed properly
10. Filters are dirty

Remedies

1. Adjust powerfoot to correct height setting
2. Grasp quick reach handle and firmly push hose wand onto the suction opening
3. Check hose and replace if needed
4. Replace drive belt, see page 15
5. Replace brush
6. Remove brush and clean debris from brush ends
7. Follow instructions on page 12 for clearing dogs
8. Empty dirt container
9. Position correctly and lock in place
10. Check and clean pre-motor and post-motor filters

Tools won't pick up dirt

Possible causes

1. Crack or hole in hose
2. Clog in vacuum
3. Dirt container full
4. Dirt container or upper tank not installed properly
5. Filters are dirty

Remedies

1. Check hose and replace if needed
2. Follow instructions on page 12 for clearing dogs
3. Empty dirt container
4. Position correctly and lock in place
5. Check and clean pre-motor and post-motor filters

Vacuum cleaner is difficult to push

Possible causes

1. Incorrect height adjustment

Remedies

1. Adjust powerfoot to correct height setting

Visible dirt escaping from cleaner

Possible causes

1. Dirt container full
2. Filters missing or installed incorrectly

Remedies

1. Empty dirt container
2. Check pre-motor and post-motor filters for correct installation

Other maintenance or service not included in the manual should be performed by an authorized service representative.

Thank you for selecting a BISSELL product.

Please do not return this product to the store.

For any questions or concerns, BISSELL is happy to be of service. Contact us directly at 1-800-237-7691.

Replacement parts - Total Floors®

Below please find a list of common replacement parts. While not all of these parts may have come with your specific machine, all are available to you for purchase, if desired.

Item	Part No.	Part Name
1	203-1730	Drive Belt
2	203-1739	Twist 'n Snap Hose
3	203-1751	Brush Roll
4	3290	Style 14 Pre-Motor Foam Filter
5	32076	Style 7 & 9 Post-Motor HEPA Media Filter*
6	27W8	Style 7 & 9 Post-Motor Febreze® Filter
7	203-1729	Inner Cyclone Assembly
8	203-1733	Pet Strip Left and Right

Not all parts are included with every model.

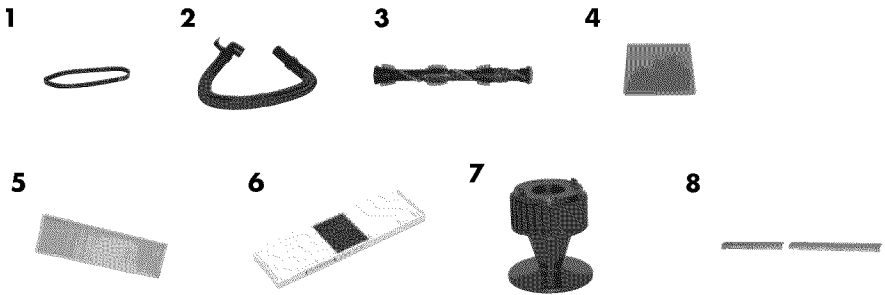

*The filter media, not the vacuum as a whole, complies with IEST-RP-CC001.5 HEPA standard.

Accessories - Total Floors®

Item	Part No.	Part Name
1	203-1740	Crevice Tool
2	203-7529	Pet TurboEraser® Tool
3	203-1741	Pet Hair Fabric Tool
4	203-1228	Dusting Brush/Upholstery Tool
5	203-1368	Pet Contour Tool®
6	98Q1-A	Shedaway® Pet Groom Attachment
7	203-2447	TurboBrush® Tool
8	203-1787	Long Reach Dusting Tool
9	203-8296	Furniture Tool
10	203-1768	Extension Wand

Not all parts are included with every model.

Long Reach Dusting Tool and Furniture Tool available in Fall 2012

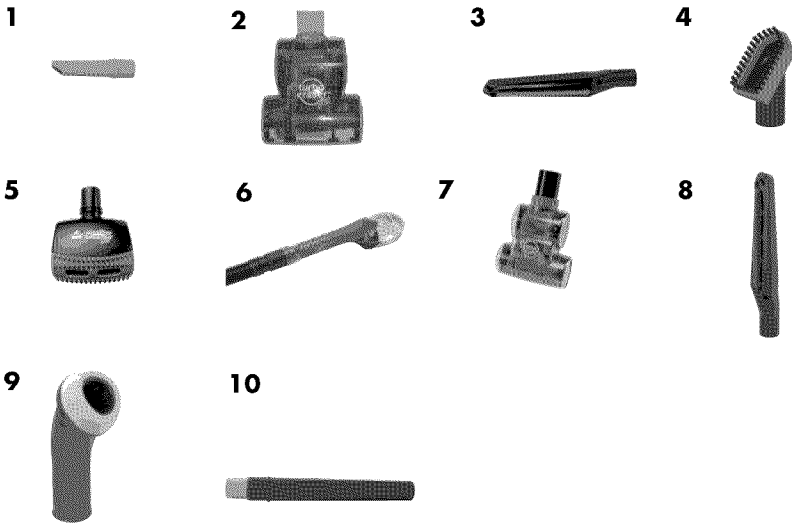



Warranty – BISSELL Total Floors® Vacuum

This warranty gives you specific legal rights, and you may also have other rights which may vary from state to state. If you need additional instruction regarding this warranty or have questions regarding what it may cover, please contact BISSELL Consumer Care by E-mail, telephone, or regular mail as described below.

Limited Four Year Warranty

Subject to the *EXCEPTIONS AND EXCLUSIONS identified below, upon receipt of the product BISSELL will repair or replace (with new or remanufactured components or products), at BISSELL's option, free of charge from the date of purchase by the original purchaser, for four years any defective or malfunctioning part.

See information below on "If your BISSELL product should require service".

This warranty applies to product used for personal, and not commercial or rental service. This warranty does not apply to fans or routine maintenance components such as filters, belts, or brushes. Damage or malfunction caused by negligence, abuse, neglect, unauthorized repair, or any other use not in accordance with the user's guide is not covered.

If your BISSELL product should require service:

Contact BISSELL Consumer Care to locate a BISSELL Authorized Service Center in your area. If you need information about repairs or replacement parts, or if you have questions about your warranty, contact BISSELL Consumer Care.

Website or E-mail:

www.bissell.com

Or Call:

BISSELL Consumer Care

1-800-237-7691

Monday – Friday 8 am - 10 pm ET

Saturday 9 am - 8 pm ET

Or Write:

BISSELL Homecare, Inc.

PO Box 1888

Grand Rapids, MI 49501

ATTN: Consumer Care

BISSELL IS NOT LIABLE FOR INCIDENTAL OR CONSEQUENTIAL DAMAGES OF ANY NATURE ASSOCIATED WITH THE USE OF THIS PRODUCT. BISSELL'S LIABILITY WILL NOT EXCEED THE PURCHASE PRICE OF THE PRODUCT.

Some states do not allow the exclusion or limitation of incidental or consequential damages, so the above limitation or exclusion may not apply to you.

*EXCEPTIONS AND EXCLUSIONS FROM THE TERMS OF THE LIMITED WARRANTY

THIS WARRANTY IS EXCLUSIVE AND IN LIEU OF ANY OTHER WARRANTIES EITHER ORAL OR WRITTEN. ANY IMPLIED WARRANTIES WHICH MAY ARISE BY OPERATION OF LAW, INCLUDING THE IMPLIED WARRANTIES OF MERCHANTABILITY AND FITNESS FOR A PARTICULAR PURPOSE, ARE LIMITED TO THE FOUR YEAR DURATION FROM THE DATE OF PURCHASE AS DESCRIBED ABOVE.

Some states do not allow warranty limitations on how long an implied warranty last so the above limitation may not apply to you.

Don't forget to register your product!

Registering is quick, easy and allows us to serve you better over the lifetime of your product. You'll receive:

BISSELL Reward Points

Automatically earn points for discounts and free shipping on future purchases.

Efficient Service

Supplying your information now saves you time should you need to contact us with questions regarding your product.

Product Support Alerts

We'll contact you with any important product alerts.

Special Promotions

Optional: Register your email to receive notice of offers, contests, cleaning tips and more!

Visit bissell.com/registration now!

BISSELL consumer care

For information about repairs or replacement parts, or questions about your warranty, call:

BISSELL Consumer Care
1-800-237-7691

Monday - Friday 8 am — 10 pm ET

Saturday 9 am — 8 pm ET

Or write:

BISSELL Homecare, Inc.

PO Box 3606

Grand Rapids MI 49501

ATTN: Consumer Care

Or visit the BISSELL website - **www.bissell.com**

When contacting BISSELL, have model number of cleaner available.

Please record your Model Number: _____

Please record your Purchase Date: _____

NOTE: Please keep your original sales receipt. It provides proof of purchase date in the event of a warranty claim. See Warranty on page 19 for details.



©2012 BISSELL Homecare, Inc.
Grand Rapids, Michigan
All rights reserved. Printed in Vietnam
Part Number 110-4591
Rev 5/12
Visit our website at:
www.bissell.com