



Top-Freezer Refrigerators

Safety Instructions 2-4

Operating Instructions

Temperature Controls 5
Shelves 5, 6
Storage Drawers 6, 7
Automatic Icemaker 7
Care and Cleaning 8

Installation Instructions

Preparing to Install
the Refrigerator 9
Water Line Installation 10-12
Reversing the Door Swing 13-16

Troubleshooting Tips

Normal Operating Sounds 17
Before You Call For Service 18, 19

Consumer Support

Refrigerator Warranty 23
Consumer Support Back Cover

**Owner's Manual and
Installation Instructions**

Models 16, 17, 18

Write the model and serial
numbers here:

Model # _____

Serial # _____

You can find them on a label on
the upper left side of the fresh food
compartment.

IMPORTANT SAFETY INFORMATION. READ ALL INSTRUCTIONS BEFORE USING.

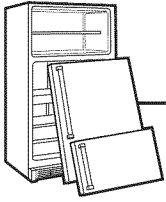

⚠️ DANGER! RISK OF CHILD ENTRAPMENT PROPER DISPOSAL OF THE REFRIGERATOR

Child entrapment and suffocation are not problems of the past. Junked or abandoned refrigerators are still dangerous...even if they will sit for "just a few days." If you are getting rid of your old refrigerator, please follow the instructions below to help prevent accidents.

Before You Throw Away Your Old Refrigerator or Freezer:

- Take off the doors.
- Leave the shelves in place so that children may not easily climb inside.
- If the refrigerator has a lock make it unusable

Refrigerants

All refrigeration products contain refrigerants, which under federal law must be removed prior to product disposal. If you are getting rid of an old refrigeration product, check with the company handling the disposal about what to do.

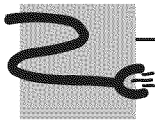

USE OF EXTENSION CORDS

Because of potential safety hazards under certain conditions, we strongly recommend against the use of an extension cord.

However, if you must use an extension cord, it is absolutely necessary that it be a UL-listed, 3-wire grounding type appliance extension cord having a grounding type plug and outlet and that the electrical rating of the cord be 15 amperes (minimum) and 120 volts.

IMPORTANTE INFORMACIÓN DE SEGURIDAD. LEA TODAS LAS INSTRUCCIONES ANTES DE SU USO.

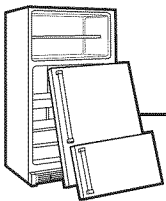

⚠️ ¡PELIGRO! RIESGO DE ENCIERRO DE NIÑOS DESECHE EL REFRIGERADOR CORRECTAMENTE

El encierro o sofocación de niños no es un problema del pasado. Los refrigeradores desechados o abandonados son todavía peligros, incluso si sólo van a permanecer "unos pocos días". Si va a desechar su refrigerador, por favor siga las siguientes instrucciones para ayudar a evitar accidentes.

Antes de desechar su viejo refrigerador o congelador:

- Retire las puertas y deséchelas de forma separada.

- Deje los estantes en su lugar de manera que los niños no puedan subir fácilmente.
- Si el refrigerador tiene una llave, póngala en uso.

Refrigerantes

Todos los aparatos de refrigeración contienen refrigerantes, los cuales se deben retirar antes de la eliminación del producto de acuerdo con la ley federal. Si va a desechar algún aparato antiguo de refrigeración, consulte con la compañía a cargo de desechar el aparato para saber qué hacer.



USO DE CABLES DE EXTENSIÓN

Debido a peligros potenciales de seguridad bajo ciertas condiciones, nos oponemos al uso de cables de extensión.

Sin embargo, si debe usar un cable de extensión, es absolutamente necesario que sea un tipo de cable de extensión para aparatos con conexión a tierra de tres cables, que esté en la lista de UL (en los Estados Unidos) o en la lista CSA (en Canadá), que tenga un enchufe de tipo conexión a tierra y salida y que el grado eléctrico del cable sea de 15 amperios (mínimo) y 120 voltios.

IMPORTANT SAFETY INFORMATION. READ ALL INSTRUCTIONS BEFORE USING.

GEAppliances.com

⚠ WARNING!



Use this appliance only for its intended purpose as described in this Owner's Manual.

SAFETY PRECAUTIONS

When using electrical appliances, basic safety precautions should be followed, including the following:

- This refrigerator must be properly installed and located in accordance with the Installation Instructions before it is used.
 - Do not attempt to or allow children to climb, stand or hang on the shelves in the refrigerator. They could damage the refrigerator and seriously injure themselves.
 - Do not touch the cold surfaces in the freezer compartment when hands are damp or wet. Skin may stick to these extremely cold surfaces.
 - Do not store or use gasoline or other flammable vapors and liquids in the vicinity of this or any other appliance.
 - Keep fingers out of the "pinch point" areas; clearances between the doors and between the doors and cabinet are necessarily small. Be careful closing doors when children are in the area.
 - Unplug the refrigerator before cleaning and making repairs.
- NOTE:** We strongly recommend that any servicing be performed by a qualified individual.
- In refrigerators with automatic icemakers, avoid contact with the moving parts of the ejector mechanism, or with the heating element (located on the bottom of the icemaker) that releases the cubes. Do not place fingers or hands on the automatic icemaking mechanism while the refrigerator is plugged in.
 - Turning the temperature control to the **OFF** position does not remove power to the light circuit.
 - Do not refreeze frozen foods which have thawed completely.
 - **Before replacing a burned-out light bulb, the refrigerator should be unplugged** in order to avoid contact with a live wire filament. (A burned-out light may break when being replaced.)

IMPORTANTE INFORMACIÓN DE SEGURIDAD. LEA TODAS LAS INSTRUCCIONES ANTES DE SU USO.

⚠ ¡ADVERTENCIA!



Use este aparato sólo con el fin para el cual fue diseñado como se describe en este Manual del propietario.

MESURES DE SÉCURITÉ

Al usar aparatos eléctricos, se deben seguir precauciones básicas de seguridad, incluyendo las siguientes:

- No intente ni permita que los niños se trepen, paren o cuelguen de los estantes del refrigerador. Este refrigerador debe instalarse y ubicarse correctamente según las Instrucciones de instalación antes de su uso.
- No intente ni permita que los niños se trepen, paren o cuelguen de los estantes del refrigerador. Podrían dañar el refrigerador y sufrir graves daños.
- No toque las superficies frías en el compartimiento del congelador con las manos húmedas o mojadas. La piel se puede pegar a estas superficies extremadamente frías.
- No almacene o use gasolina u otros vapores y líquidos inflamables en las áreas cercanas a este o a cualquier otro aparato.
- Mantenga los dedos alejados de las áreas estrechas; los espacios entre las puertas y entre las puertas y los gabinetes son necesariamente pequeños. Tenga cuidado al cerrar las puertas cuando haya niños en el área.
- Desconecte el refrigerador antes de limpiar y hacer reparaciones.
NOTA: Recomendamos enfáticamente que cualquier servicio sea realizado por un individuo calificado.
- En los refrigeradores con máquinas de hielo automáticas, evite el contacto con las partes en movimiento del mecanismo eyector, o con el elemento de calefacción (ubicado en la parte inferior de la máquina de hielos) que expulsa los cubos. No coloque los dedos o las manos en el mecanismo de la máquina de hielos mientras el refrigerador esté conectado.
- Girar el control de temperatura a la posición apagado no retira la corriente del circuito de luz.
- No vuelva a congelar alimentos que se han descongelado por completo.
- **Antes de reemplazar una lámpara de luz quemada, se deberá desenchufar** el refrigerador a fin de evitar el contacto con el filamento que aún tiene corriente. (Una lámpara de luz quemada se puede quebrar al ser reemplazada).

IMPORTANT SAFETY INFORMATION. READ ALL INSTRUCTIONS BEFORE USING.

⚠ WARNING!

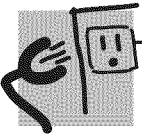

HOW TO CONNECT ELECTRICITY

Do not, under any circumstances, cut or remove the third (ground) prong from the power cord. For personal safety, this appliance must be properly grounded.

The power cord of this appliance is equipped with a 3-prong (grounding) plug which mates with a standard 3-prong (grounding) wall outlet to minimize the possibility of electric shock hazard from this appliance.

Have the wall outlet and circuit checked by a qualified electrician to make sure the outlet is properly grounded.

Where a ungrounded 2-prong wall outlet is encountered, it is your personal responsibility and obligation to have it replaced with a properly grounded 3-prong wall outlet.

The refrigerator should always be plugged into its own individual electrical outlet which has a voltage, wattage and frequency that match the rating plate.

This provides the best performance and also prevents overloading house wiring circuits which could cause a fire hazard from overheated wires.

Never unplug your refrigerator by pulling on the power cord. Always grip plug firmly and pull straight out from the outlet.

Repair or replace immediately all power cords that have become frayed or otherwise damaged. Do not use a cord that shows cracks or abrasion damage along its length or at either end.

When moving the refrigerator away from the wall, be careful not to roll over or damage the power cord.

READ AND FOLLOW THIS SAFETY INFORMATION CAREFULLY.

SAVE THESE INSTRUCTIONS

IMPORTANTE INFORMACIÓN DE SEGURIDAD. LEA TODAS LAS INSTRUCCIONES ANTES DE SU USO.

⚠ ¡ADVERTENCIA!

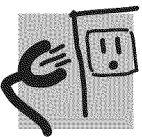

CÓMO CONECTAR LA ELECTRICIDAD

Bajo ninguna circunstancia, no corte ni retire la tercera pata (conexión a tierra) del cable de electricidad. Por seguridad personal, este aparato debe estar correctamente conectado a tierra.

El cable eléctrico de este aparato está provisto de un enchufe de tres patas (conexión a tierra) que encaja en un tomacorriente estándar de 3 orificios (conexión a tierra) para minimizar la posibilidad de peligro de un choque eléctrico de este aparato.

Haga que el tomacorriente de la pared y el circuito sean revisados por un electricista calificado para asegurar que el tomacorriente tiene la conexión a tierra apropiada.

En caso de contar con un tomacorriente de pared de 2 clavijas, es su responsabilidad y obligación reemplazarlo por un tomacorriente de pared de 3 clavijas correctamente conectado a tierra.

El refrigerador debería estar siempre conectado a un enchufe específico con un índice de voltaje, vataje y frecuencia equivalentes los que figuran en su etiqueta de características técnicas.

Esto ofrece el mejor desempeño y también evita sobrecargar los circuitos eléctricos de la casa que podrían causar un incendio a partir de los cables recalentados.

Nunca desconecte su refrigerador halando del cable eléctrico. Siempre tome el enchufe firmemente y hágalo directamente del tomacorriente.

Repáre o reemplace de inmediato todos los cables eléctricos que se hayan desgastado o dañado. No use un cable que tenga grietas o daños de abrasión en su longitud o en cualquier extremo.

Al retirar el refrigerador de la pared, tenga cuidado de no enrollar o dañar el cable eléctrico.

LEA Y SIGA CUIDADOSAMENTE ESTA INFORMACIÓN DE SEGURIDAD.

CONSERVE ESTAS INSTRUCCIONES

About the temperature control dial.

Turning the dial to **OFF** stops cooling in both compartments—fresh food and freezer. It does not shut off power to the refrigerator.

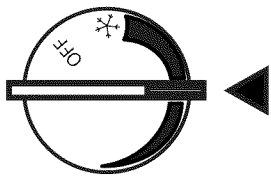

Temperature Control Dial (on some models)

The temperature control dial adjust refrigerator from warmest to coldest. The recommended factory setting is shown in illustration to the left. For colder temperature turn dial clockwise toward snowflake. For warmer temperature turn dial counter clockwise away from snowflake. allow 24 hours for adjustment.

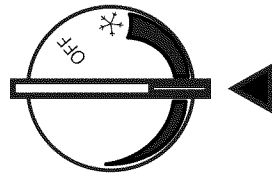

Recommended factory setting

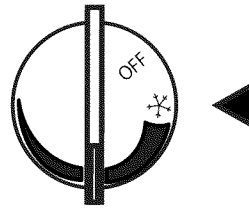

Coldest setting

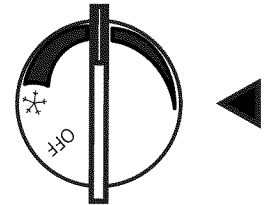

Warmest setting

About the fresh food compartment shelves.

Shelf supports at various levels allow you to custom-space your shelves. Not all features are on all models.

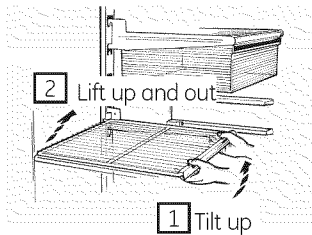

Half-Width Shelves

One end of the shelf rests on a molded side-wall support; a bracket on the other end hooks into a track on the rear cabinet wall.

To remove, lift the shelf up at front, then off the support and out of the track.

To replace, select desired shelf height. With shelf front raised slightly, hook the bracket's top lug into the track, then lower the shelf onto the support.

NOTE: The shelf to the right of the track is designed to hook into the right-hand slot; the shelf to the left is designed to hook into the left-hand slot.

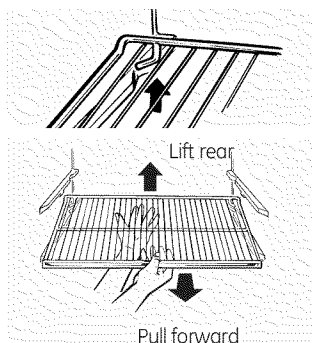
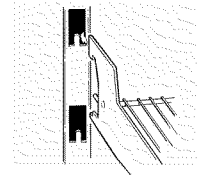

Full-Width Shelves

Some models have a stationary tempered glass shelf, a spillproof shelf, or two steel wire stationary shelves. These shelves can be moved to another place in the fresh food compartment.

When placed correctly on the shelf supports, the shelf will stop before coming completely out of the refrigerator and will not tilt when you place food on it or remove food from it.

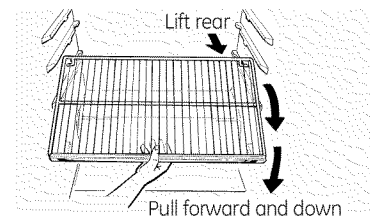

To remove a full-width shelf when the fresh food compartment door cannot be opened fully

To remove the full-width shelves

About the freezer compartment shelves.

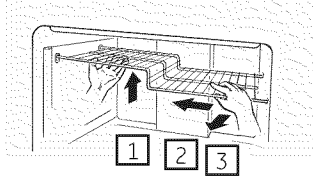

Step Shelf (on some models)

To remove the step shelf:

- 1 Lift left side of shelf slightly.
- 2 Move shelf to the left to free its right ends from holes in the cabinet wall.
- 3 Lower right side of shelf, move shelf to the right and take it out.

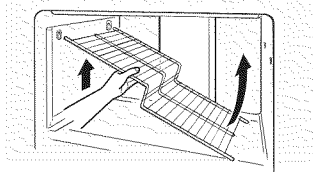

To replace the step shelf:

- 1 With shelf tilted as shown, fit left ends of shelf into holes in cabinet wall.
- 2 Lift left side of shelf slightly, swing shelf up, fit right ends of shelf into holes in cabinet wall, and lower shelf into place.

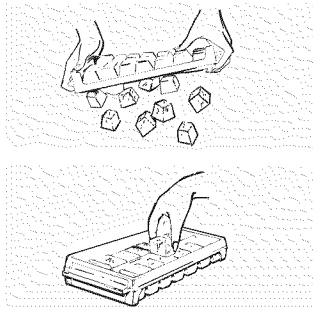

Ice Trays (on some models)

Ice trays are designed to release ice cubes easily. Hold tray upside-down over a container and twist both ends to release cubes.

For only one or two ice cubes, leave the tray right-side up, twist both ends slightly and remove desired number of cubes. **Wash ice trays and storage bin in lukewarm water only.** Do not put them in an automatic dishwasher.

About the storage drawers.

Not all features are on all models.

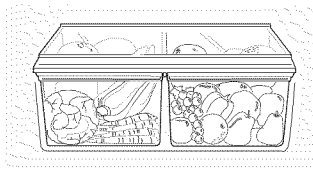

Fruit and Vegetable Drawers

Excess water that may accumulate in the bottom of the drawers should be emptied and the drawers wiped dry.

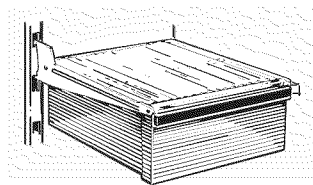

Snacks Drawer

The snacks drawer can be moved to the most useful location for your family's needs.

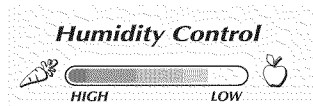

Adjustable Humidity Drawer (on some models)

Slide the control all the way to the HIGH setting to provide high humidity recommended for most vegetables.

Slide the control all the way to the LOW setting to provide lower humidity levels recommended for most fruits.

About storage drawer and cover removal.

Not all features are on all models.

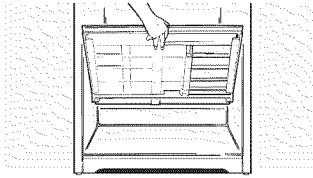

Drawer and Cover Removal

Drawers can be removed easily by grasping the sides and lifting up slightly while pulling drawers past the **stop** location.

To remove the cover, lift it off its supports, pull it forward, tilt it and take it out.

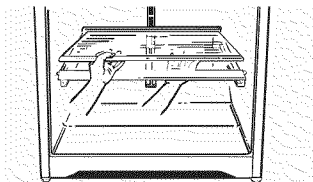

Twin Drawer Shelf

To remove:

- 1 Remove the drawers.
- 2 Reach in, push the front of glass cover up, and at the same time, pull it forward as far as it will come. Tilt it and take it out. Avoid cleaning the cold glass cover with hot water because the extreme temperature difference may cause it to break.
- 3 Remove the drawer frame. (Always remove the glass cover before you take out the drawer frame.)

Lift the frame off the supports at each side and back, pull it forward, tilt it and take it out.

To replace:

- 1 Lower the frame until it rests on the supports at each side and back.
- 2 Replace the glass cover, pushing its rear edge firmly into the rear frame channel and gently lowering the front into place.
- 3 Replace the drawers.

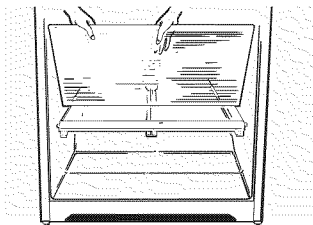

About the automatic icemaker.

A newly-installed refrigerator may take 12 to 24 hours to begin making ice.

There are 2 types of icemakers:

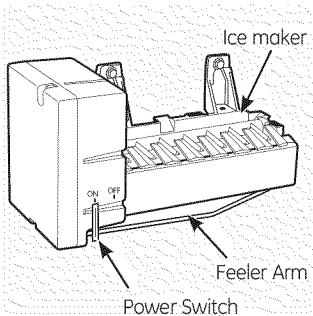

Power switch model

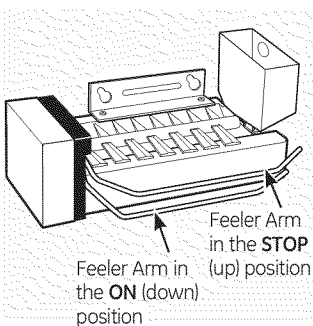

Feeler arm model

Automatic Icemaker (on some models)

The icemaker will produce approximately 70-100 cubes in a 24-hour period, depending on the freezer compartment temperature, room temperature, number of door openings and other use conditions.

If the refrigerator is operated before the water connection is made to the icemaker, set the switch to **OFF** or move the feeler arm to the **STOP** (up) position.

When the refrigerator has been connected to the water supply, set the switch to the **ON** position or move the feeler arm to the **ON** (down) position.

The icemaker will fill with water when it cools to 15°F. A newly-installed refrigerator may take 12 to 24 hours to begin making ice cubes.

Once the icemaker starts to make ice, it may take up to 48 hours to fill the bin, depending on the temperature settings and number of door openings.

You will hear a buzzing sound each time the icemaker fills with water.

Throw away the first few batches of ice to allow the water line to clear.

Be sure nothing interferes with the sweep of the feeler arm.

When the bin fills to the level of the feeler arm, the icemaker will stop producing ice.

It is normal for several cubes to be joined together.

If ice is not used frequently, old ice cubes will become cloudy, taste stale, shrink or fuse together.

Icemaker Accessory Kit

If your refrigerator did not already come equipped with an automatic icemaker, an icemaker accessory kit is available at extra cost.

Check the back of the refrigerator for the specific icemaker kit needed for your model.

Care and cleaning of the refrigerator.

Cleaning the Outside

The door handles and trim (on some models). Clean with a cloth dampened with soapy water. Dry with a soft cloth.

Keep the outside clean. Wipe with a clean cloth lightly dampened with kitchen appliance wax or mild liquid dish detergent. Dry and polish with a clean, soft cloth.

The stainless steel panels and door handles (on some models) can be cleaned with a commercially available stainless steel cleaner. Cleaners with oxalic acid such as Bar Keepers Friend® Soft Cleanser will remove rust, tarnish and small blemishes. Use only a liquid cleanser free of grit and rub in the direction of the brush lines with a damp soft sponge. Do not use appliance wax or polish on the stainless steel.

Do not wipe the refrigerator with a soiled dish cloth or wet towel. These may leave a residue that can erode the paint. Do not use scouring pads, powdered cleaners, bleach or cleaners containing either bleach or ammonia because these products can scratch and weaken the paint finish.

Cleaning the Inside

To help prevent odors, leave an open box of baking soda in the fresh food and freezer compartments.

Unplug the refrigerator before cleaning.

If this is not practical, wring excess moisture out of sponge or cloth when cleaning around switches, lights or controls.

Use warm water and baking soda solution—about a tablespoon (15 ml) of baking soda to a quart (1 liter) of water. This both cleans and neutralizes odors. Rinse and wipe dry.

After cleaning the door gaskets, apply a thin layer of petroleum jelly to the door gaskets at the hinge side. This helps keep the gaskets from sticking and bending out of shape.

Avoid cleaning cold glass shelves (on some models) with hot water because the extreme temperature difference may cause them to break. Handle glass shelves carefully. Bumping tempered glass can cause it to shatter.

Do not wash any plastic refrigerator parts in the dishwasher.

Condenser

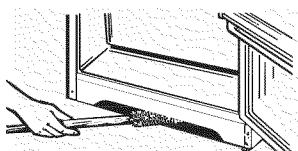

Cleaning the condenser coils.

There is no need for routine condenser cleaning in normal home operating environments. However, in environments that may be particularly dusty or greasy, the condenser should be cleaned periodically for efficient refrigerator operation.

To clean the condenser, turn the temperature control dial to **OFF**. Sweep away or vacuum up dust.

For best results, use a brush specially designed for this purpose. It is available at most appliance parts stores.

Moving the Refrigerator

Be careful when moving the refrigerator away from the wall. All types of floor coverings can be damaged, particularly cushioned coverings and those with embossed surfaces.

Turn the leveling legs at each front corner of the refrigerator counterclockwise until the rollers support the refrigerator. Pull the refrigerator straight out and return it to position by pushing it straight in. **Moving the refrigerator in a side direction may result in damage to the floor covering or refrigerator.**

When pushing the refrigerator back, make sure you don't roll over the power cord or icemaker supply line (on some models).

After rolling the refrigerator back into place, turn the legs clockwise until the legs again bear the weight of the refrigerator.

Light Bulb Replacement

To replace a burned-out bulb, unplug the refrigerator from its electrical outlet, unscrew the bulb when cool and replace it with an appliance bulb of the same or lower wattage.

*Turning the control to the **OFF** position does not remove power to the light circuit.*

Preparing for Vacation

For long vacations or absences, remove food and unplug the refrigerator. Move the temperature control dial to the **OFF** position, and clean the interior with a baking soda solution of one tablespoon (15 ml) of baking soda to one quart (1 liter) of water. Leave the doors open.

Move the feeler arm to the **STOP** (up) position, or move the switch to the **OFF** position on the slide switch model and shut off the water supply to the refrigerator.

If the temperature can drop below freezing, have a qualified servicer drain the water supply system (on some models) to prevent serious property damage due to flooding.

Preparing to Move

Secure all loose items such as grille, shelves and drawers by taping them securely in place to prevent damage. *Be sure the refrigerator stays in an upright position during moving.*

Installation Instructions *Models 16, 17, 18*

If you have questions, call 1.800.GE.CARES or visit our Website at: GEAppliances.com

BEFORE YOU BEGIN

Read these instructions completely and carefully.

- **IMPORTANT** – Save these instructions for local inspector's use.
- **IMPORTANT** – Observe all governing codes and ordinances.
- **Note to Installer** – Be sure to leave these instructions with the Consumer.
- **Note to Consumer** – Keep these instructions for future reference.
- **Skill level** – Installation of this appliance requires basic mechanical skills.
- **Completion time** – Refrigerator Installation
15 minutes
Reversing the Door Swing
1 hour
- Proper installation is the responsibility of the installer.
- Product failure due to improper installation is not covered under the Warranty.

WATER SUPPLY TO THE ICEMAKER (on some models)

If the refrigerator has an icemaker, it will have to be connected to a cold water line. A water supply kit (containing copper tubing, shutoff valve, fittings and instructions) is available at extra cost from your dealer, by visiting our Website at GEAppliances.com or from Parts and Accessories, 1.877.959.8688.

REFRIGERATOR LOCATION

- Do not install the refrigerator where the temperature will go below 60°F (16°C) because it will not run often enough to maintain proper temperatures.
- Install it on a floor strong enough to support it fully loaded.

CLEARANCES

Allow the following clearances for ease of installation, proper air circulation and plumbing and electrical connections.

- Sides 3/4" (19 mm)
- Top 1" (25 mm)
- Back 2" (50 mm)

ROLLERS AND LEVELING LEGS

Leveling legs near each front corner of the refrigerator are adjustable. They firmly position the refrigerator and prevent it from moving when the doors are opened. Leveling legs should be set so the front of the refrigerator is raised just enough that the doors close easily when opened about halfway.

Turn the leveling legs **clockwise to raise** the refrigerator, **counterclockwise to lower it**.

Rollers next to the leveling legs allow you to move the refrigerator away from the wall for cleaning.

Turn the legs counterclockwise until the weight of the refrigerator is transferred from them to the rollers. After rolling the refrigerator back into place, turn the legs clockwise until the legs again bear the weight of the refrigerator.

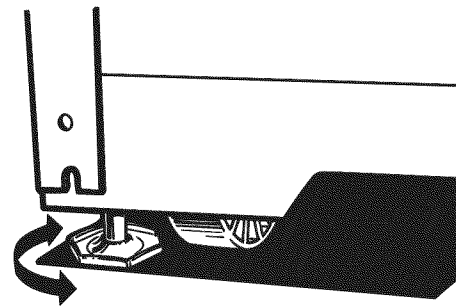

Installation Instructions

1 INSTALLING THE WATER LINE (ON SOME MODELS)

BEFORE YOU BEGIN

Recommended copper water supply kits are WX8X2, WX8X3 or WX8X4, depending on the amount of tubing you need. Approved plastic water supply lines are GE SmartConnect™ Refrigerator Tubing (WX08X10006, WX08X10015 and WX08X10025).

When connecting your refrigerator to a GE Reverse Osmosis Water System, the only approved installation is with a GE RVKit. For other reverse osmosis water systems, follow the manufacturer's recommendations.

This water line installation is not warranted by the refrigerator or icemaker manufacturer. Follow these instructions carefully to minimize the risk of expensive water damage.

Water hammer (water banging in the pipes) in house plumbing can cause damage to refrigerator parts and lead to water leakage or flooding. Call a qualified plumber to correct water hammer before installing the water supply line to the refrigerator.

To prevent burns and product damage, do not hook up the water line to the hot water line.

If you use your refrigerator before connecting the water line, make sure the ice maker power switch is in the **OFF** position (on power switch models) or the feeler arm in the **STOP** (up) position (on feeler arm models).

Do not install the icemaker tubing in areas where temperatures fall below freezing.

When using any electrical device (such as a power drill) during installation, be sure the device is double insulated or grounded in a manner to prevent the hazard of electric shock, or is battery powered.

All installations must be in accordance with local plumbing code requirements.

⚠ WARNING! Connect to potable water supply only.

⚠ ¡ADVERTENCIA! Conecte al suministro de agua potable solamente.

WHAT YOU WILL NEED

- **Copper or GE SmartConnect™ Refrigerator Tubing kit**, 1/4" outer diameter to connect the refrigerator to the water supply. If using copper, be sure both ends of the tubing are cut square.

To determine how much tubing you need: measure the distance from the water valve on the back of the refrigerator to the water supply pipe. Then add 8' (2.4 m). Be sure there is sufficient extra tubing (about 8' [2.4 m] coiled into 3 turns of about 10" [25 cm] diameter) to allow the refrigerator to move out from the wall after installation.

WHAT YOU WILL NEED (Cont.)

GE SmartConnect™ Refrigerator Tubing Kits are available in the following lengths:

- 6' (1.8 m) – WX08X10006
- 15' (4.6 m) – WX08X10015
- 25' (7.6 m) – WX08X10025

Be sure that the kit you select allows at least 8' (2.4 m) as described above.

NOTE: The only GE approved plastic tubing is that supplied in GE SmartConnect™ Refrigerator Tubing kits. Do not use any other plastic water supply line because the line is under pressure at all times. Certain types of plastic will crack or rupture with age and cause water damage to your home.

- **A GE water supply kit** (containing tubing, shutoff valve and fittings listed below) is available at extra cost from your dealer or from Parts and Accessories.

- **A cold water supply.** The water pressure must be between 20 and 120 p.s.i. (1.4–8.1 bar).

- **Power drill.**

- **1/2" or adjustable wrench.**

- **Straight and Phillips blade screwdriver.**

- **Two 1/4" outer diameter compression nuts and 2 ferrules (sleeves)**—to connect the copper tubing to the shutoff valve and the refrigerator water valve.

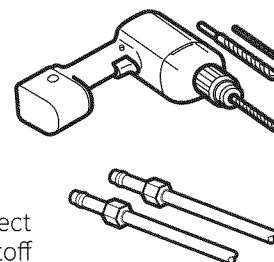

OR

- If you are using a GE SmartConnect™ Refrigerator Tubing kit, the necessary fittings are preassembled to the tubing.
- If your existing copper water line has a flared fitting at the end, you will need an **adapter** (available at plumbing supply stores) to connect the water line to the refrigerator **OR** you can cut off the flared fitting with a **tube cutter** and then use a compression fitting. Do not cut formed end from GE SmartConnect™ Refrigerator tubing.

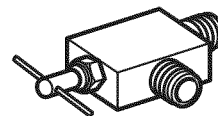

- **Shutoff valve** to connect to the cold water line. The shutoff valve should have a water inlet with a minimum inside diameter of 5/32" at the point of connection to the **COLD WATER LINE**. Saddle-type shutoff valves are included in many water supply kits. Before purchasing, make sure a saddle-type valve complies with your local plumbing codes.

Installation Instructions

Install the shutoff valve on the nearest frequently used drinking water line.

1 SHUT OFF THE MAIN WATER SUPPLY AND UNPLUG REFRIGERATOR

Turn on the nearest faucet (counterclockwise) long enough to clear the line of water.

2 DRILL THE HOLE FOR THE VALVE

Choose a location for the valve that is easily accessible. It is best to connect into the side of a vertical water pipe. When it is necessary to connect into a horizontal water pipe, make the connection to the top or side, rather than at the bottom, to avoid drawing off any sediment from the water pipe.

Drill a 1/4" hole in the water pipe (even if using a self-piercing valve), using a sharp bit. Remove any burrs resulting from drilling the hole in the pipe. **Take care not to allow water to drain into the drill.** Failure to drill a 1/4" hole may result in reduced ice production or smaller cubes.

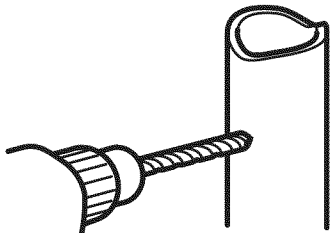

3 FASTEN THE SHUTOFF VALVE

Fasten the shutoff valve to the cold water pipe with the pipe clamp.

Tighten the clamp screws until the sealing washer begins to swell.

NOTE: Do not overtighten or you may crush the tubing.

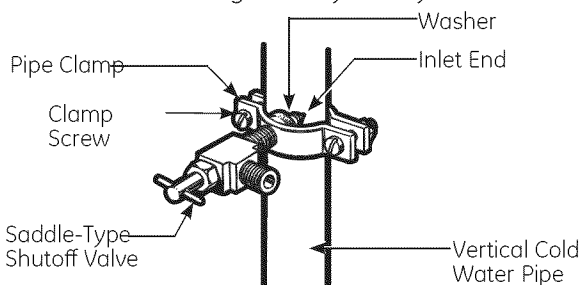

NOTE: Commonwealth of Massachusetts Plumbing Codes 248CMR shall be adhered to. Saddle valves are illegal and use is not permitted in Massachusetts. Consult with your licensed plumber.

4 ROUTE THE TUBING

Route the tubing between the cold water line and the refrigerator.

Route the tubing through a hole drilled in the wall or floor (behind the refrigerator or adjacent base cabinet) as close to the wall as possible.

NOTE: Be sure there is sufficient extra tubing (about 8 feet [244 cm] coiled into 3 turns of about 10" [25 cm] diameter) to allow the refrigerator to move out from the wall after installation.

5 CONNECT THE TUBING TO THE VALVE

Place the compression nut and ferrule (sleeve) for copper tubing onto the end of the tubing and connect it to the shutoff valve.

Make sure the tubing is fully inserted into the valve. Tighten the compression nut securely.

For plastic tubing from a GE SmartConnect™ Refrigerator Tubing kit, insert the molded end of the tubing into the shutoff valve and tighten compression nut until it is hand tight, then tighten one additional turn with a wrench. Overtightening may cause leaks.

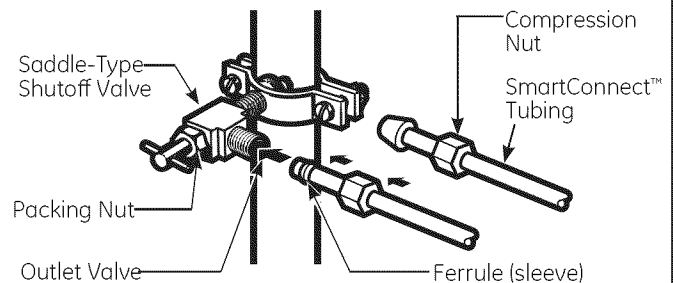

NOTE: Commonwealth of Massachusetts Plumbing Codes 248CMR shall be adhered to. Saddle valves are illegal and use is not permitted in Massachusetts. Consult with your licensed plumber.

6 FLUSH OUT THE TUBING

Turn the main water supply on (counterclockwise) and flush out the tubing until the water is clear.

Shut the water off at the water valve after about one quart (1 liter) of water has been flushed through the tubing.

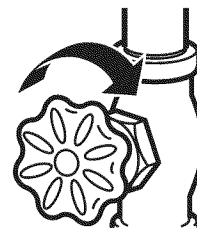

Installation Instructions

1 INSTALLING THE WATER LINE (CONT.)

7 CONNECT THE TUBING TO THE REFRIGERATOR

NOTES:

- Before making the connection to the refrigerator, be sure the refrigerator power cord is not plugged into the wall outlet.
- We recommend installing a water filter if your water supply has sand or particles that could clog the screen of the refrigerator's water valve. Install it in the water line near the refrigerator. If using GE SmartConnect™ Refrigerator Tubing kit, you will need an additional tube (WX08X10002) to connect the filter. Do not cut plastic tube to install filter.

Remove the access cover.

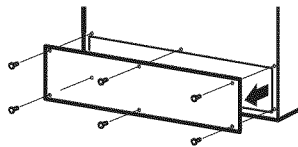

Remove the plastic flexible cap from the water valve (refrigerator connection).

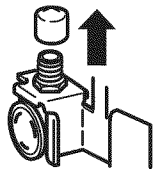

Place the compression nut and ferrule (sleeve) onto the end of the tubing as shown. On GE SmartConnect™ Refrigerator Tubing kit, the nuts are already assembled to the tubing.

Insert the end of the tubing into the water valve connection as far as possible. While holding the tubing, tighten the fitting.

For plastic tubing from a GE SmartConnect™ Refrigerator Tubing kit, insert the molded end of the tubing into the shutoff valve and tighten compression nut until it is hand tight, then tighten one additional turn with a wrench. Overtightening may cause leaks.

Fasten the tubing into the clamp provided to hold it in a vertical position. You may need to pry open the clamp.

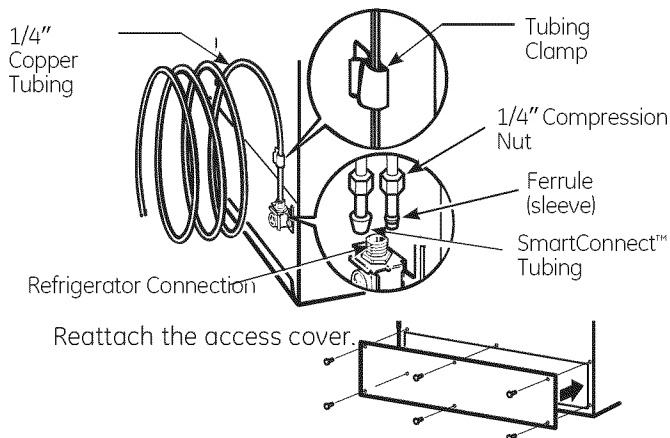

8 TURN THE WATER ON AT THE SHUTOFF VALVE

Tighten any connections that leak.

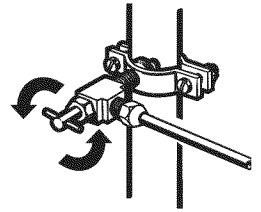

9 INSTALLING THE REFRIGERATOR

Plug in the refrigerator.

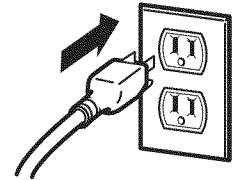

Arrange the coil of tubing so that it does not vibrate against the back of the refrigerator or against the wall. Push the refrigerator back to the wall.

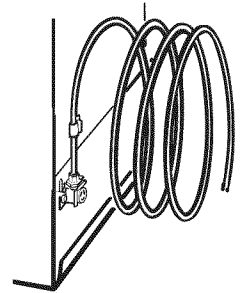

10 START THE ICEMAKER

On power switch models, set the icemaker power switch to the **ON** position. On feeler arm models, move the feeler arm to the **ON** (down) position. The icemaker will not begin to operate until it reaches its operating temperature of 15°F (-9°C) or below. It will then begin operation automatically.

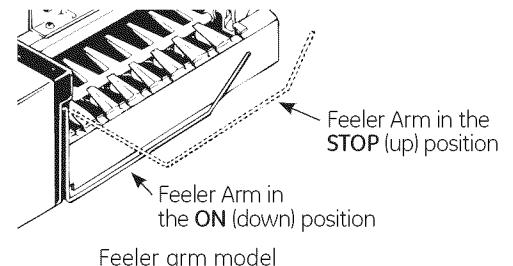
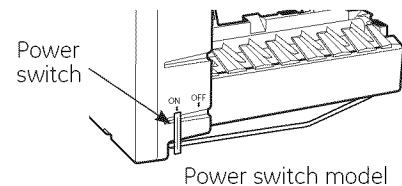

NOTE: In lower water pressure conditions, the water valve may turn on up to 3 times to deliver enough water to the icemaker.

Installation Instructions

2 REVERSING THE DOOR SWING

IMPORTANT NOTES

When reversing the door swing:

- Read the instructions all the way through before starting.
- Handle parts carefully to avoid scratching paint.
- Set screws down by their related parts to avoid using them in the wrong places.
- Provide a non-scratching work surface for the doors.

IMPORTANT: Once you begin, do not move the cabinet until door-swing reversal is completed.

These instructions are for changing the hinges from the right side to the left side—if you ever want to change the hinges back to the right side, follow these same instructions and reverse all references to left and right.

TOOLS REQUIRED

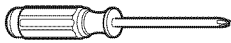

Phillips screwdriver



Masking tape



5/16" hex-head socket driver



T20 or T25 Torxdriver (needed for some models)

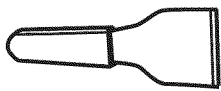

Putty knife or thin-blade screwdriver



5/16" open-end wrench

1 BEFORE YOU START

- 1.1 Unplug the refrigerator from its electrical outlet.
- 1.2 Empty all door shelves, including the dairy compartment.

CAUTION: Do not let either door drop to the floor. To do so could damage the door stop.

2 REMOVE THE FREEZER DOOR

2.1 Tape the door shut with masking tape.

2.2 With a 5/16" hex-head socket driver, remove the screws that hold the top hinge to the cabinet.

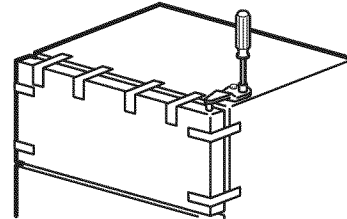

2.3 Lift the hinge straight up to free the hinge pin from the socket in the top of the door and set it aside, along with its screws.

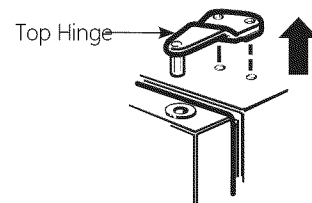

2.4 Remove the tape and tilt the door away from the cabinet. Lift it off the center hinge pin.

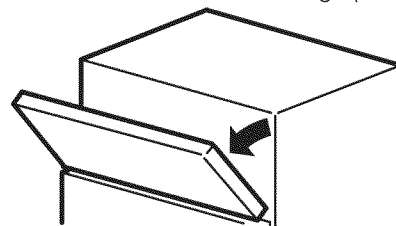

2.5 Set the door on a non-scratching surface with the outside up.

2.6 Transfer the 2 screws from the opposite side of the cabinet to the screw holes vacated by the top hinge removal.

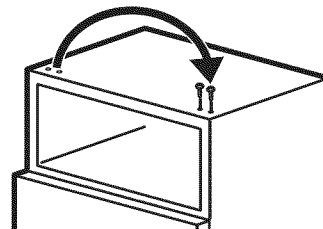

Installation Instructions

2 REVERSING THE DOOR SWING (CONT.)

3 REMOVE THE FRESH FOOD DOOR

3.1 Tape the door shut with masking tape.

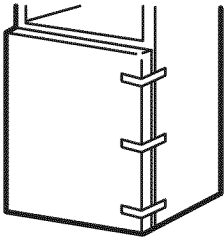

3.2 Using a 5/16" hex-head socket screwdriver and a 5/16" open-end wrench, remove the two screws holding the center hinge to the cabinet. Lift the center hinge to free its pin from the socket in the top of the door, and set hinge and screws aside. **Be careful not to lose the center hinge spacer and washer.**

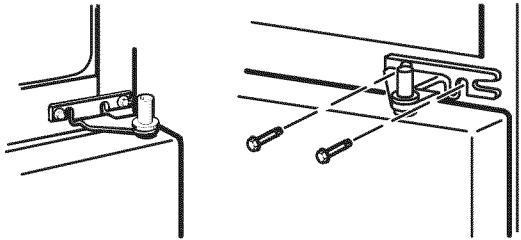

3 REMOVE THE FRESH FOOD DOOR (CONT.)

3.5 Transfer the two screws from the opposite side of the cabinet to the screw holes vacated by the center hinge removal.

3.6 Transfer the washer (if your model has one) to the opposite side.

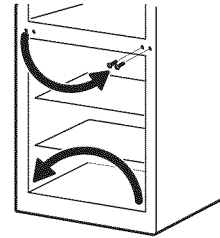

3.7 Take one of the screws removed in step 2 and start it in the outermost screw hole on the opposite side. Do not drive it all the way down—leave enough space under the screw head for thickness of the bracket.

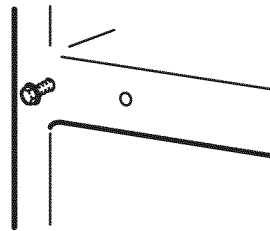

3.3 Remove the tape and tilt the door away from the cabinet. Lift the door from the pin in the bottom hinge bracket. (If the plastic washer sticks to the door bottom, put it back on the hinge.)

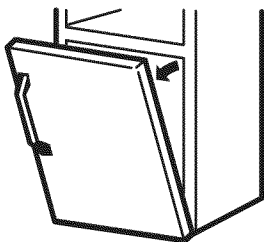

3.4 Set the door outside-up on a non-scratching surface.

4 REVERSING THE HARDWARE

4.1 Move the bottom hinge bracket and plastic washer from the right side to the left side.

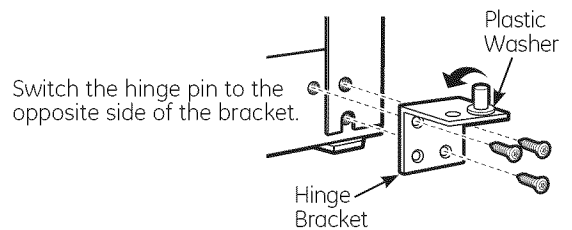

Installation Instructions

4 REVERSING THE HARDWARE (CONT.)

4.2 Interchange hinge and screws at top right with screws at top left of cabinet. **Do not tighten screws on hinge side at this time.**

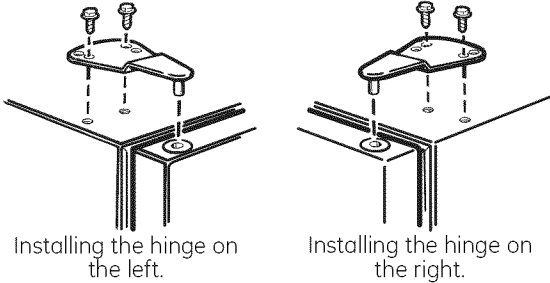

NOTES:

- Some hinges have four holes. Which holes you use for installing the hinge depends on which side you install the hinge.
- The outer edge of the hinge should be parallel to the edge of the case for correct installation.

5 REVERSING THE DOOR HANDLES (CONT.)

5.1.3 Remove plug button from the top hinge hole on the left side of the door and insert it into the hole on the opposite side that was vacated by removal of the top hinge.

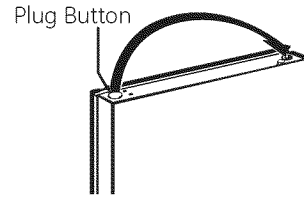

5.1.4 Pull the plug button from the front of the door and transfer it to the opposite side.

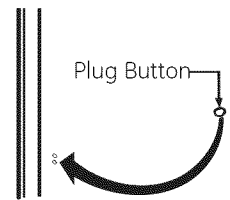

To reattach the handle on the opposite side.

5 REVERSING THE DOOR HANDLES

5.1 Transfer fresh food door handle

5.1.1 Remove the handle plug using a tape-tipped putty knife under the edge, and remove the screw underneath. Remove the two screws holding the handle to the top of the door.

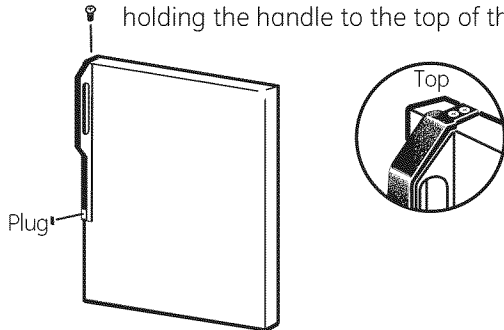

5.1.2 Remove the handle.

5.2 Transfer door stop

5.2.1 Move the plastic door stop and screws from the right side to the left side.

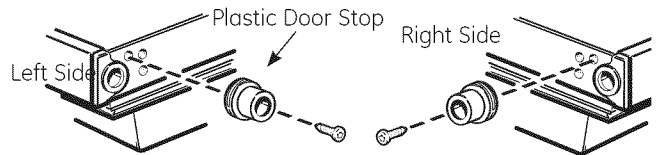

5.3 Reinstall the fresh food door handle

5.3.1 Attach the handle to the right side of the door with screws at the top and under the handle plug.

5.3.2 Reinstall the handle plug.

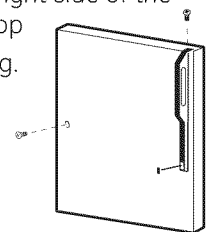

Installation Instructions

2 REVERSING THE DOOR SWING (CONT.)

5 REVERSING THE DOOR HANDLES (CONT.)

5.4 Transfer Freezer Door Handle

5.4.1 Remove the screw holding the handle to the top of the door and the two screws holding the handle to the bottom of the door.

5.4.2 Remove the handle.

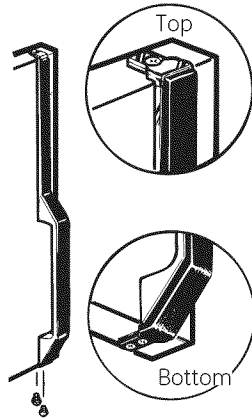

5.4.3 Remove the screw from the right top edge of the door and insert it into the handle screw hole on the left side.

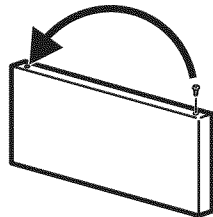

5.4.4 Transfer the door stop as shown in preceding section 5.2.

5.4.5 Attach the handle to the right edge of the door with screws at top and bottom, using bottom holes vacated by removal of the door stop screws.

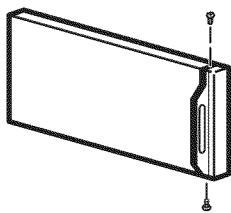

6 RE-HANGING THE DOORS

6.1 Re-hang the fresh food door

6.1.1 Lower the fresh food door onto the bottom hinge pin. **Be sure the washer is in place on the pin.**

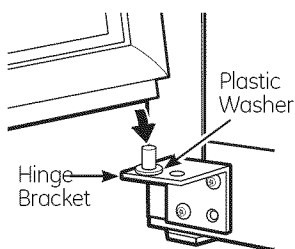

6 RE-HANGING THE DOORS (CONT.)

6.1.2 Insert the pin on the center hinge into the socket in the top of the door. Place the spacer, then the washer, on the hinge pin.

NOTE: The center hinge must be turned over as shown when mounted on the left side.

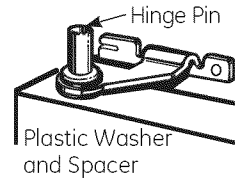

6.1.3 Tilt the door toward the cabinet. As the door is brought into position, slide the hinge under the head of the screw which earlier had been partly driven into the outermost hole. Insert the remaining screw, then tighten both screws securely.

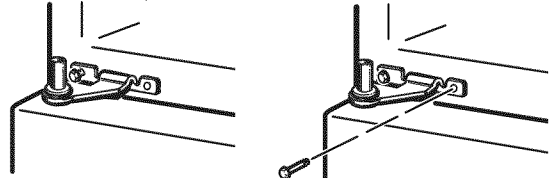

6.2 Re-hang the freezer door

6.2.1 Lower the freezer door onto the center hinge pin. **Be sure the washer and spacer are in place on the pin.**

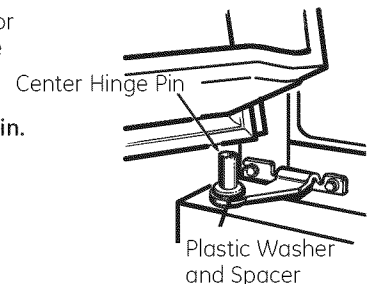

6.2.2 Tilt the door toward the cabinet, lifting the top hinge so the pin fits into the socket on the top of the door.

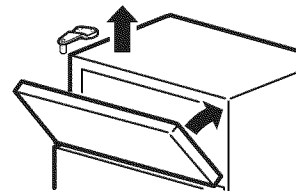

6.2.3. Make sure the door is slightly above the top of the cabinet and the gap between the doors is even across the front. Tighten the top hinge screws. Do not overtighten these screws-tighten them until they are just snug, then turn them another one-half turn.

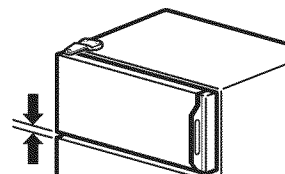



Newer refrigerators sound different from older refrigerators. Modern refrigerators have more features and use newer technology.

Do you hear what I hear? These sounds are normal.

- The new high efficiency compressor may run faster and longer than your old refrigerator and you may hear a high-pitched hum or pulsating sound while it is operating.
- You may hear a whooshing sound when the doors close. This is due to pressure equalizing within the refrigerator.

HUMMM...
WHOOSH...

WHIR!



- You may hear the fans spinning at high speeds. This happens when the refrigerator is first plugged in, when the doors are opened frequently or when

a large amount of food is added to the refrigerator or freezer compartments. The fans are helping to maintain the correct temperatures.

CLICKS, POPS, CRACKS and CHIRPS

- You may hear cracking or popping sounds when the refrigerator is first plugged in. This happens as the refrigerator cools to the correct temperature.
- The compressor may cause a clicking or chirping sound when attempting to restart (this could take up to 5 minutes).
- Expansion and contraction of cooling coils during and after defrost can cause a cracking or popping sound.
- On models with an icemaker, after an icemaking cycle, you may hear the ice cubes dropping into the ice bucket.



WATER SOUNDS

- The flow of refrigerant through the freezer cooling coils may make a gurgling noise like boiling water.
- Water dropping on the defrost heater can cause a sizzling, popping or buzzing sound during the defrost cycle.
- A water dripping noise may occur during the defrost cycle as ice melts from the evaporator and flows into the drain pan.
- Closing the door may cause a gurgling sound due to pressure equalization.



For additional information on normal icemaker operating sounds, see the **About the automatic icemaker** section.

Before you call for service...



Troubleshooting Tips
 Save time and money! Review the charts on the following pages first and you may not need to call for service.

Problem	Possible Causes	What To Do
Refrigerator does not operate	Refrigerator in defrost cycle.	Wait about 30 minutes for defrost cycle to end.
	Temperature control dial in OFF position.	Move the temperature control dial to a temperature setting.
	Refrigerator is unplugged.	Push the plug completely into the outlet.
	The fuse is blown/circuit breaker is tripped.	Replace fuse or reset the breaker.
Vibration or rattling (slight vibration is normal)	Roller screws or leveling legs need adjusting.	See <i>Rollers and Leveling Legs</i> .
Fresh food or freezer compartment too warm	Temperature control dial not set cold enough.	See <i>About the temperature control dial</i> .
	Warm weather or frequent door openings.	Set the temperature control dial one step colder. See <i>About the temperature control dial</i> .
	Door left open.	Check to see if package is holding door open.
	Package blocking air duct in freezer compartment.	Check to see if package is blocking air duct in freezer compartment.
Motor operates for long periods or cycles on and off frequently. (Modern refrigerators with more storage space and a larger space and a larger freezer require more operating time. They start and stop often to maintain even temperatures.)	Normal when refrigerator is first plugged in.	Wait 24 hours for the refrigerator to completely cool down.
	Often occurs when large amounts of food are placed in refrigerator.	This is normal.
	Door left open.	Check to see if package is holding door open.
	Hot weather or frequent door openings.	This is normal.
	Temperature control dial set at the coldest setting.	See <i>About the temperature control dial</i> .
	Grille and condenser need cleaning.	See <i>Care and cleaning</i> .
Frost or ice crystals on frozen food (frost within package is normal)	Door left open.	Check to see if package is holding door open.
	Too frequent or too long door openings.	
Automatic icemaker does not work (on some models)	Icemaker is not on.	Move the feeler arm to the ON (down) position, or move the power switch to the ON position
	Water supply turned off or not connected.	See <i>Installing the water line</i> .
	Freezer compartment too warm.	Wait 24 hours for the refrigerator to completely cool down.
	Piled up cubes in the storage bin cause the icemaker to shut off.	Level cubes by hand.
Frequent "buzzing" sound supply to the refrigerator has not been connected	Icemaker is on but the water	Move the feeler arm to the STOP (up) position, or move the power switch to the OFF position, Keeping it on will damage the water valve.
Cubes too small	Water shutoff valve connecting refrigerator to water line may be clogged.	Call the plumber to clear the valve.
Slow ice cube freezing	Door left open.	Check to see if package is holding door open.
	Temperature control dial not set cold enough.	See <i>About the temperature control dial</i> .



Troubleshooting Tips

Problem	Possible Causes	What To Do
Ice cubes have odor/taste	Ice storage bin needs cleaning.	Empty and wash bin. Discard old cubes.
	Food transmitting odor/taste to ice cubes.	Wrap foods well.
	Interior of refrigerator needs cleaning	See <i>Care and cleaning</i> .
Moisture forms on cabinet surface between the doors	Not unusual during periods of high humidity.	Wipe surface dry and reset temperature control dial one setting colder.
Moisture collects inside (in humid weather, air carries moisture into refrigerator when doors reopened)	Too frequent or too long door openings.	
Refrigerator has odor	Foods transmitting odor to refrigerator.	Foods with strong odors should be tightly wrapped.
		Keep an open box of baking soda in the refrigerator; replace every three months.
	Interior needs cleaning.	See <i>Care and cleaning</i> .

Notes.

Notes.

Refrigerator Warranty.

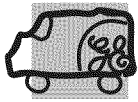

For US Customers, all warranty service provided by our Factory Service Centers, or an authorized Customer Care® technician. To schedule service, on-line, 24 hours a day, visit us at GEAppliances.com, or call 800.GE.CARES (800.432.2737). Please have serial number and model number available when calling for service.

In Canada, call 800.561.3344.

Staple your receipt here. Proof of the original purchase date is needed to obtain service under the warranty.

For the Period of:	GE Will Replace
One Year From the date of the original purchase	Any part of the refrigerator which fails due to a defect in materials or workmanship. During the limited one-year warranty , GE will also provide, free of charge , all labor and related service to replace the defective part.

What GE Will Not Cover:

- Service trips to your home to teach you how to use the product.
- Improper installation, delivery or maintenance.
- Failure of the product if it is abused, misused, or used for other than the intended purpose or used commercially.
- Loss of food due to spoilage.
- Replacement of house fuses or resetting of circuit breakers.
- Damage to the finish must be reported within 48 hours following delivery of the appliance.
- Damage to finish including rust, tarnish, or small blemishes, after delivery.
- Products which are not defective, broken, or which are working as described in the Owner's Manual.
- Replacement of the water filter cartridge, if included, due to water pressure that is outside the specified operating range or due to excessive sediment in the water supply.
- Replacement of the light bulbs, if included, or water filter cartridge, if included, other than as noted above.
- Damage to the product caused by accident, fire, floods or acts of God.
- Incidental or consequential damage caused by possible defects with this appliance.
- Product not accessible to provide required service.

EXCLUSION OF IMPLIED WARRANTIES—Your sole and exclusive remedy is product repair as provided in this Limited Warranty. Any implied warranties, including the implied warranties of merchantability or fitness for a particular purpose, are limited to one year or the shortest period allowed by law.

For US Customers: This warranty is extended to the original purchaser and any succeeding owner for products purchased for home use within the USA. If the product is located in an area where service by a GE Authorized Servicer is not available, you may be responsible for a trip charge or you may be required to bring the product to an Authorized GE Service location for service. In Alaska, the warranty excludes the cost of shipping or service calls to your home.

Some states do not allow the exclusion or limitation of incidental or consequential damages. This warranty gives you specific legal rights, and you may also have other rights which vary from state to state. To know what your legal rights are, consult your local or state consumer affairs office or your state's Attorney General.

Warrantor US: General Electric Company, Louisville, KY 40225

For Customers in Canada: This warranty is extended to the original purchaser and any succeeding owner for products purchased in Canada for home use within Canada. In-home warrant service will be provided in areas where it is available and deemed reasonable by Mabe to provide.

Warrantor Canada: MC Commercial, Burlington, Ontario, L7R 5B6

Consumer Support.



GE Appliances Website

GEAppliances.com
www.Hotpoint.com

Have a question or need assistance with your appliance? Try the GE Appliances Website 24 hours a day, any day of the year! For greater convenience and faster service, you can now download Owner's Manuals, order parts, or even schedule service on-line.

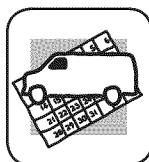

Schedule Service

GEAppliances.com
www.Hotpoint.com

Expert GE repair service is only one step away from your door. Get on-line and schedule your service at your convenience 24 hours any day of the year! Or call 800.GE.CARES (800.432.2737) during normal business hours.

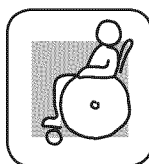

Real Life Design Studio

GEAppliances.com

GE supports the Universal Design concept—products, services and environments that can be used by people of all ages, sizes and capabilities. We recognize the need to design for a wide range of physical and mental abilities and impairments. For details of GE's Universal Design applications, including kitchen design ideas for people with disabilities, check out our Website today. For the hearing impaired, please call 800.TDD.GEAC (800.833.4322).



Extended Warranties

GEAppliances.com

Purchase a GE extended warranty and learn about special discounts that are available while your warranty is still in effect. You can purchase it on-line anytime, or call 1.888.261.2133 during normal business hours. GE Consumer Home Services will still be there after your warranty expires.

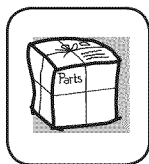

Parts and Accessories

GEAppliancesParts.com

Individuals qualified to service their own appliances can have parts or accessories sent directly to their homes (VISA, MasterCard and Discover cards are accepted). Order on-line today, 24 hours every day or by phone at 1.877.959.8688 during normal business hours.

Instructions contained in this manual cover procedures to be performed by any user. Other servicing generally should be referred to qualified service personnel. Caution must be exercised, since improper servicing may cause unsafe operation.



Contact Us

GEAppliances.com
www.Hotpoint.com

If you are not satisfied with the service you receive from GE, contact us on our Website with all the details including your phone number, or write to:
General Manager, Customer Relations
GE Appliances, Appliance Park
Louisville, KY 40225



Register Your Appliance

GEAppliances.com
www.Hotpoint.com

Register your new appliance on-line—at your convenience! Timely product registration will allow for enhanced communication and prompt service under the terms of your warranty, should the need arise. You may also mail in the pre-printed registration card included in the packing material.

