

**SAMSUNG**

**HW-H450**

User manual

# Wireless Audio - Soundbar

Imagine the possibilities

Thank you for purchasing this Samsung product.  
To receive more complete service, please register your product at  
[www.samsung.com/register](http://www.samsung.com/register)

'This Nanum Gothic Eco font is provided by NAVER'

# FEATURES

## TV SoundConnect

TV SoundConnect lets you listen to audio from your TV on your Soundbar via a Bluetooth connection and lets you control the sound.

## HDMI

HDMI transmits video and audio signals simultaneously, and provides a clearer picture. The unit is also equipped with the ARC function which lets you listen to sound from your TV through the Soundbar via an HDMI cable. This function is only available if you connect the unit to an ARC compliant TV.

## 3D SOUND

The 3D SOUND feature adds depth and spaciousness to your listening experience.

## Wireless Subwoofer

Samsung's wireless module does away with cables running between the main unit and the subwoofer. Instead, the subwoofer connects to a compact wireless module that communicates with the main unit.

## Special Sound Effects

You can select different Sound Effects - MUSIC / VOICE / SPORTS / CINEMA / STANDARD (Original Sound) - depending on the type of content you want to enjoy.

## Multi-function Remote Control

You can use the supplied remote control to control various operations with the simple press of a button.

## USB Host Support

You can connect and play music files from external USB storage devices such as MP3 players, USB flash memory, etc. using the Soundbar's USB HOST function.

## Bluetooth Function

You can connect a Bluetooth device to the Soundbar and enjoy music with high quality stereo sound, all without wires!

# LICENSES



Manufactured under license from Dolby Laboratories. Dolby and the double-D symbol are trademarks of Dolby Laboratories.



For DTS patents, see <http://patents.dts.com>. Manufactured under license from DTS Licensing Limited. DTS, the Symbol, & DTS and the Symbol together are registered trademarks, and DTS 2.0 Channel is a trademark of DTS, Inc. © DTS, Inc. All Rights Reserved.



## HDMI

The terms HDMI and HDMI High-Definition Multimedia Interface, and the HDMI Logo are trademarks or registered trademarks of HDMI Licensing LLC in the United States and other countries.

# SAFETY INFORMATION

## SAFETY WARNINGS

TO REDUCE THE RISK OF ELECTRIC SHOCK, DO NOT REMOVE THE COVER (OR BACK).  
NO USER-SERVICEABLE PARTS ARE INSIDE. REFER SERVICING TO QUALIFIED SERVICE PERSONNEL.

<p style="text-align: center;"><b>CAUTION</b> RISK OF ELECTRIC SHOCK DO NOT OPEN</p>		<p>The lightning flash and arrowhead within the triangle indicates that there is dangerous voltage inside the product.</p>
<p><b>CAUTION:</b> TO REDUCE THE RISK OF ELECTRIC SHOCK, DO NOT REMOVE THE COVER (OR BACK). NO USER SERVICEABLE PARTS INSIDE. REFER SERVICING TO QUALIFIED SERVICE PERSONNEL.</p>		<p>The explanation point within the triangle indicates that there are important instructions accompanying the product.</p>

### WARNING

- To reduce the risk of fire or electric shock, do not expose this appliance to rain or moisture.
- To prevent injury, this apparatus must be securely attached to the floor/wall in accordance with the installation instructions.
- This product contains chemicals known to the State of California to cause cancer and reproductive toxicity.
- To reduce the risk of fire or electric shock, do not expose this appliance to rain or moisture.

### CAUTION

- Do not expose this apparatus to dripping or splashing. Do not put objects filled with liquids, such as vases on the apparatus.
- To turn this apparatus off completely, you must pull the power plug out of the wall socket. Consequently, the power plug must be easily and readily accessible at all times.

This product satisfies FCC regulations when shielded cables and connectors are used to connect the unit to other equipment. To prevent electromagnetic interference with electric appliances, such as radios and televisions, use shielded cables and connectors for connections.

### FCC NOTE (for U.S.A):

This equipment has been tested and found to comply with the limits for a Class B digital device, pursuant to Part 15 of the FCC Rules. These limits are designed to provide reasonable protection against harmful interference in a residential installation.

This equipment generates, uses and can radiate radio frequency energy and, if not installed and used in accordance with the instructions, may cause harmful interference to radio communications. However, there is no guarantee that interference will not occur in a particular installation.

If this equipment does cause harmful interference to radio or television reception, which can be determined by turning the equipment off and on, the user is encouraged to try to correct the interference by one or more of the following measures:

- Reorient or relocate the receiving antenna.
- Increase the separation between the equipment and receiver.
- Connect the equipment to an outlet that is on a different circuit than the radio or TV.
- Consult the dealer or an experienced radio/TV technician for help.

Caution : FCC regulations state that any unauthorized changes or modifications to this equipment may void the user's authority to operate it.

## Important Safety Instructions

Read these operating instructions carefully before using the unit. Follow all the safety instructions listed below. Keep these operating instructions handy for future reference.

- 1) Read these instructions.
- 2) Keep these instructions.
- 3) Heed all warnings.
- 4) Follow all instructions.
- 5) Do not use this apparatus near water.
- 6) Clean only with dry cloth.
- 7) Do not block any ventilation openings. Install in accordance with the manufacturer's instructions.
- 8) Do not install near any heat sources such as radiators, heat registers, stoves, or other apparatus (including amplifiers) that produce heat.
- 9) Do not defeat the safety purpose of the polarized or grounding-type plug. A polarized plug has two blades with one wider than the other. A grounding type plug has two blades and a third grounding prong. The wide blade or the third prong are provided for your safety. If the provided plug does not fit into your outlet, consult an electrician for replacement of the obsolete outlet.
- 10) Protect the power cord from being walked on or pinched particularly at plugs, convenience receptacles, and the point where they exit from the apparatus.
- 11) Only use attachment/accessories specified by the manufacturer.
- 12) Use only with the cart, stand, tripod, bracket, or table specified by the manufacturer, or sold with the apparatus. When a cart is used, use caution when moving the cart/apparatus combination to avoid injury from tip-over.
- 13) Unplug this apparatus during lightning storms or when unused for long periods of time.
- 14) Refer all servicing to qualified service personnel. Servicing is required when the apparatus has been damaged in any way, such as power-supply cord or plug is damaged, liquid has been spilled or objects have fallen into the apparatus, the apparatus has been exposed to rain or moisture, does not operate normally, or has been dropped.



## PRECAUTIONS

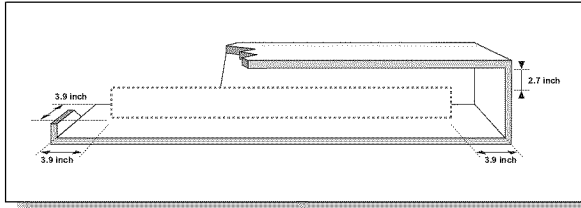

Ensure that the AC power supply in your house complies with the power requirements listed on the identification sticker located on the back of your product. Install your product horizontally, on a suitable base (furniture), with enough space around it for ventilation (3–4 inches). Make sure the ventilation slots are not covered. Do not place the unit on amplifiers or other equipment which may become hot. This unit is designed for continuous use. To fully turn off the unit, disconnect the AC plug from the wall outlet. Unplug the unit if you intend to leave it unused for a long period of time.

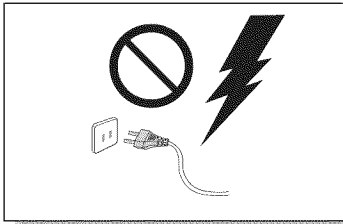

During thunderstorms, disconnect the AC plug from the wall outlet. Voltage peaks due to lightning could damage the unit.

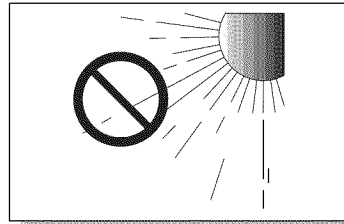

Do not expose the unit to direct sunlight or other heat sources. This could lead to overheating and cause the unit to malfunction.

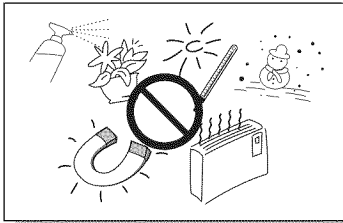

Protect the product from moisture (i.e. vases), and excess heat (e.g. a fireplace) or equipment creating strong magnetic or electric fields. Disconnect the power cable from the AC supply if the unit malfunctions. Your product is not intended for industrial use. It is for personal use only. Condensation may occur if your product has been stored in cold temperatures. If transporting the unit during the winter, wait approximately 2 hours until the unit has reached room temperature before using.

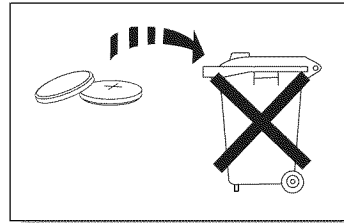

The batteries used with this product contain chemicals that are harmful to the environment. Do not dispose of batteries in the general household trash. Do not dispose of batteries in a fire. Do not short circuit, disassemble, or overheat the batteries. Danger of explosion if battery is incorrectly replaced. Replace only with the same or equivalent type.



**WARNING, DO NOT INGEST BATTERY, CHEMICAL BURN HAZARD**, The remote control supplied with this product contains a coin/button cell battery. If the coin/button cell battery is swallowed, it can cause severe internal burns in just 2 hours and can lead to death. Keep new and used batteries away from children. If the battery compartment does not close securely, stop using the product and keep it away from children. If you think batteries might have been swallowed or placed inside any part of the body, seek immediate medical attention.

# CONTENTS

## 2 FEATURES

- 2 Licenses

## 3 SAFETY INFORMATION

- 3 Safety Warnings
- 4 Precautions

## 6 GETTING STARTED

- 6 Before reading the User's Manual
- 6 What's Included

## 7 DESCRIPTIONS

- 7 Top/Front Panel
- 8 Rear Panel

## 9 REMOTE CONTROL

- 9 Remote Control Buttons and Functions

## 11 CONNECTIONS

- 11 Installing the Wall Mount
- 12 Detaching the Wall Mount
- 13 Connecting the Wireless Subwoofer
- 14 Attaching the Toroidal Ferrite Core to the Power Cord of the Subwoofer
- 15 Connecting an External Device using an HDMI cable
- 16 Connecting an External Device using Audio (analog) cable or Optical (digital) cable

## 17 FUNCTIONS

- 17 Input mode
- 17 ARC (HDMI OUT)
- 18 Bluetooth
- 20 TV SoundConnect
- 21 USB
- 22 Software Update

## 23 TROUBLESHOOTING

## 24 APPENDIX



- 24 Specifications

# GETTING STARTED

## BEFORE READING THE USER'S MANUAL

Note the following terms before reading the user manual.

### ► Icons used in this manual

Icon	Term	Definition
	Caution	Indicates a situation where a function does not operate or settings may be canceled.
	Note	Indicates tips or instructions on the page that help you operate a function.

### ► Safety Instructions and Troubleshooting

- 1) Be sure to familiarize yourself with the Safety Instructions before using this product. (See page 3)
- 2) If a problem occurs, check Troubleshooting. (See page 23)







### ► Copyright

©2014 Samsung Electronics Co.,Ltd.

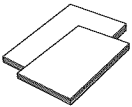
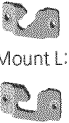
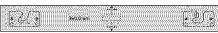
All rights reserved; no part of this user's manual may be reproduced or copied without the prior written permission of Samsung Electronics Co.,Ltd.

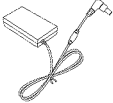
## WHAT'S INCLUDED

Check for the supplied accessories shown below.

			
<b>Remote Control / Lithium Battery (3V : CR2032)</b> (AH59-02631A / 4301-001042)	<b>User Manual / Quick Guide</b> (AH68-02732A) / (AH68-02707P)	(Wall Mount L: 1EA) (Wall Mount R: 1EA)	<b>Wall Mount Guide</b> AH63-03710A
(Holder-screw1: 2EA)			
(Holder-screw2: 2EA)	<b>Power Cord</b> (3903-000598)	<b>DC Adapter</b> (BN44-00722A)	(For Subwoofer power cable 1EA)
<b>Holder-screw</b> (AH61-03342A / 6001-001961)			<b>Toroidal ferrite core</b> (3301-000144)
	<b>USB Cable</b> (AH39-01270A)		
<b>AUX Cable</b> (BN39-01286A)			



- The appearance of the accessories may differ slightly from the illustrations above.
- Use the dedicated USB cable to connect external USB devices to the unit.

# DESCRIPTIONS

## TOP/FRONT PANEL

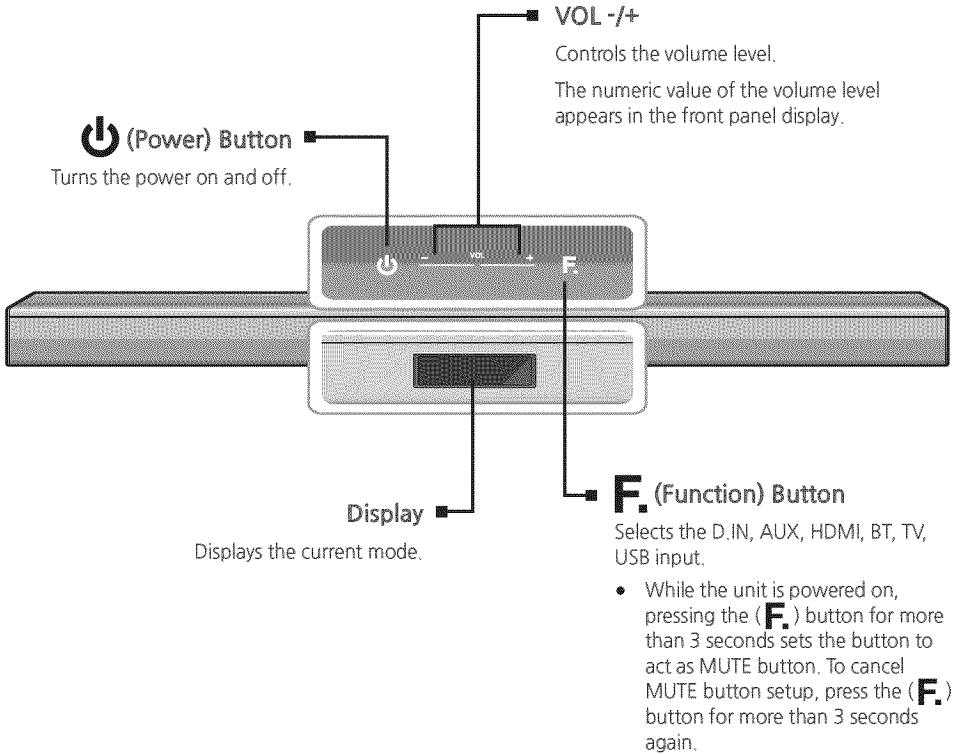

- When you turn on this unit, there will be a 4 to 5 second delay before it produces sound.
- If you want to enjoy the sound only from the Soundbar, you must turn off the TV's speakers in the Audio Setup menu of your TV. Refer to the owner's manual supplied with your TV.

## REAR PANEL

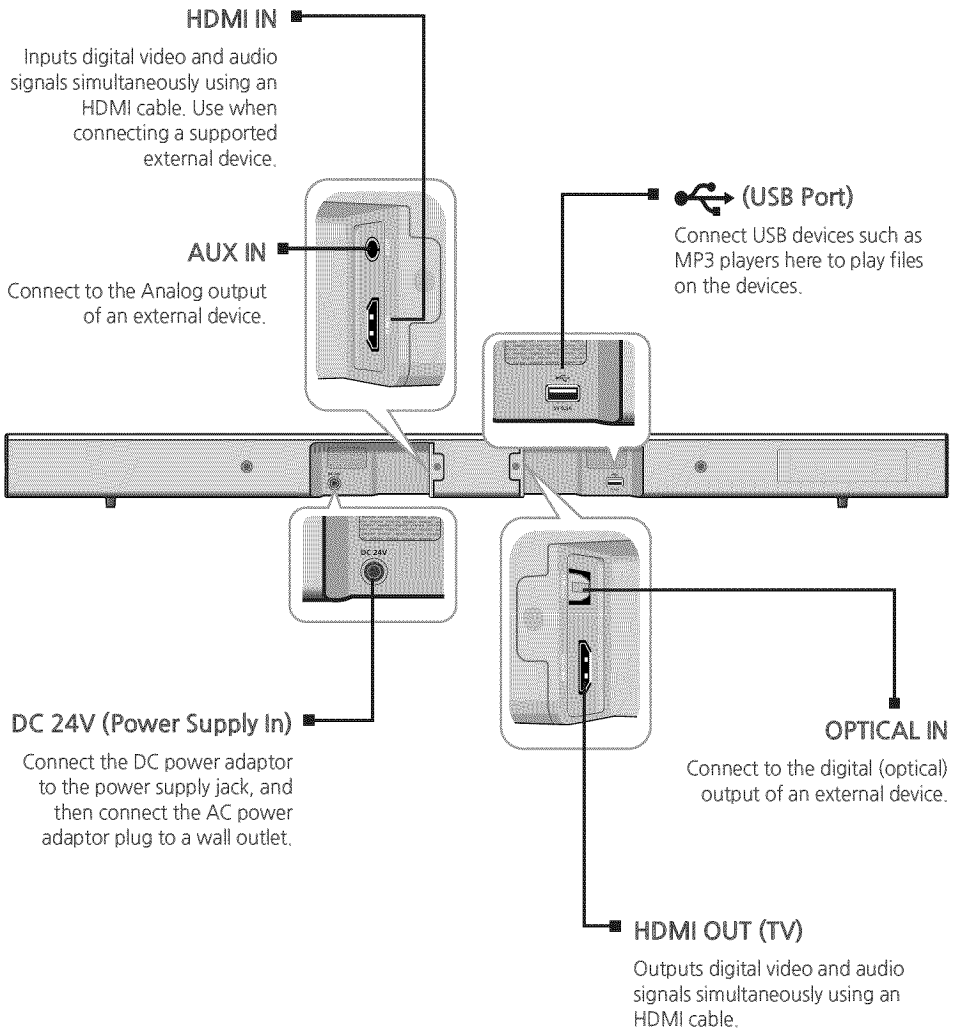

- When disconnecting the power cable of the AC power adaptor from the wall outlet, pull the plug. Do not pull the cable.
- Do not connect this unit or other components to an AC outlet until all connections between components are complete.



# REMOTE CONTROL

## REMOTE CONTROL BUTTONS AND FUNCTIONS

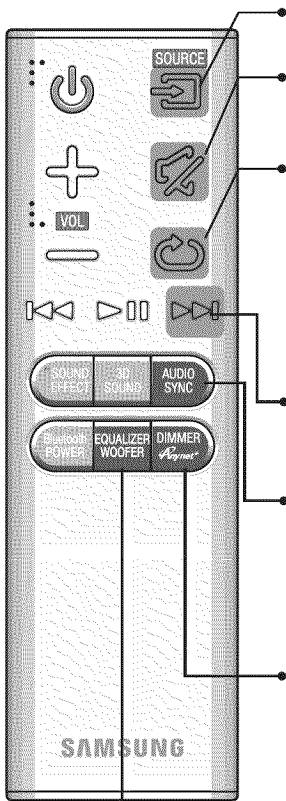

**SOURCE**

Press to select a source connected to the Soundbar.

**MUTE**

You can turn the volume down to 0 with the push of a button. Press again to restore the sound to the previous volume level.

**REPEAT**

Press to set the REPEAT function during music playback from a USB device.

**REPEAT OFF** : Cancels Repeat Playback.

**REPEAT FILE** : Repeatedly play a track.

**REPEAT ALL** : Repeatedly play all tracks.

**REPEAT RANDOM** : Plays tracks in random order.

(A track that has already been played may be played again.)

**Skip Forward**

If there is more than one file on the device you are playing, and you press the ►► button, the next file is selected.

**AUDIO SYNC**

If the Soundbar is connected to a digital TV and the video appears out of sync with the audio, press the **AUDIO SYNC** buttons to sync the audio with the video. Use the ◀◀, ▶▶ buttons to set the audio delay between 0 ms and 300 ms. In USB mode, TV mode, and BT mode, the Audio Sync function may not work.

**DIMMER/Anynet+**

**DIMMER** : Press the **DIMMER/Anynet+** button to control the brightness of the display.

**Anynet+** : Press and hold the **DIMMER/Anynet+** button for more than 3 seconds to turn the Anynet+ function on or off.

(Auto Power Link : Default OFF, Anynet+ ON / Power Link Off or Anynet+ OFF / Power Link ON ). The Anynet+ function lets you control the Soundbar with the remote from an Anynet+ compatible Samsung TV. The Soundbar must be connected to the TV via an HDMI cable.

\* Auto Power Link

Synchronizes the Soundbar to a connected Optical source via the Optical jack so it turns on automatically when you turn on your TV.

**EQUALIZER WOOFER**

Press to select Treble or Bass. Then, use the ◀◀, ▶▶ button to adjust the Treble or Bass volume from -3 to +3.

You can control the subwoofer volume. Press the ◀◀, ▶▶ button to increase or decrease the subwoofer volume. You can set it from SW -6 to SW +6.



- Soundbar is a Samsung proprietary name.
- Operate the TV using the TV's remote control.

## REMOTE CONTROL

**POWER**  
Turns the Soundbar on and off.

**VOLUME**  
Adjusts the volume level of the unit.

**Play/Pause**  
Press the ►|| button to pause playing the file temporarily.  
Press the ►|| button again to play the selected file.

**Skip Back**  
If there is more than one file on the device you are playing, and you press the ◀◀ button, the previous file is selected.

**SOUND EFFECT**  
You can select from 5 different sound modes - **MUSIC, VOICE, SPORTS, CINEMA, and STANDARD** - depending on the type of sources you want to enjoy.  
Press the **SOUND EFFECT** button on the remote control. Select the **STANDARD** mode if you want to enjoy the original sound. Press the **SOUND EFFECT** button for more than 5 seconds to turn on or off Smart Volume.  
\* Smart Volume  
This will regulate and stabilize the volume level against a drastic volume change caused by a channel change or scene transition.

**Bluetooth POWER**  
Press the **Bluetooth POWER** button on the remote to turn the Bluetooth POWER on function on and off. See pages 19 and 20 for details.

**3D SOUND (3D Sound Plus)**  
Press the **3D SOUND** button on the remote to add depth and spaciousness to the sound.  
Press the **3D SOUND** on the remote control.  
Each time the button is pressed, the selection changes as follows :  
3D SOUND PLUS OFF → 3D SOUND PLUS MUSIC → 3D SOUND PLUS MOVIE

## ► Installing the Battery in the Remote Control

1. Use a suitable coin to turn the remote control's battery cover counterclockwise to remove it as shown in the figure above.
2. Insert a 3V lithium battery. Keep the positive (+) pole facing up when inserting the battery. Put the battery cover on and align the '●' marks side by side as shown in the figure above.
3. Use a suitable coin to turn the remote control battery cover clockwise as far as it will go to fix it in place.

# CONNECTIONS

## INSTALLING THE WALL MOUNT

You can use the wall mount bracket to mount this unit on a wall.

### ► Installation Precautions

- Install on a vertical wall only.
- For the installation, avoid a location with high temperature or humidity, or a wall that cannot sustain the weight of the set.
- Check the strength of the wall. If the wall is not strong enough to support the unit, reinforce the wall or install the unit on a different wall that can support the unit's weight.
- Purchase and use the fixing screws or anchors appropriate for the kind of wall you have (plaster board, iron board, wood, etc.). If possible, fix the support screws into wall studs.
- Purchase wall mounting screws according to the type and thickness of the wall you will mount the Soundbar on.
  - Diameter : M5
  - Length: 1 3/8 in (35 mm) or longer recommended.
- Connect cables from the unit to external devices before you install it on the wall.
- Make sure the unit is turned off and unplugged before you install it. Otherwise, it may cause an electric shock.

1. Place the installation guide against the wall surface.
  - The installation guide must be level.
  - Install at least 2 inches (5 cm) below the TV, if the TV is mounted on the wall.
2. Mark the location where the screws will go through on the wall using a pen, and then remove the installation guide.
3. Fasten the wall mounts and screws to the marked locations.
  - The left and right mounts are different shapes.
4. Secure the two holder screws to the screw holes on the back of the Soundbar's main body, one on the left and one on the right.
5. Insert the USB cable into the back of the Soundbar before installing it on the wall.
6. Set the holder screws on the back of the Soundbar into the grooves of the wall mount. For safe installation, make sure to push the holder screws all the way to the bottom of the grooves.

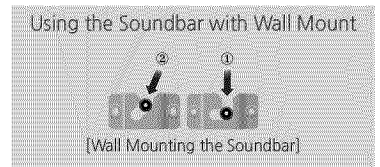
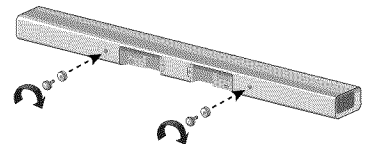
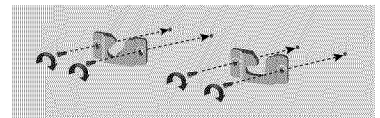
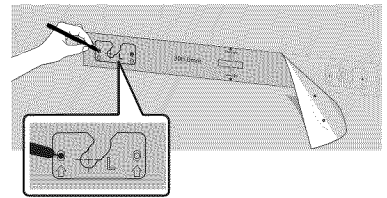
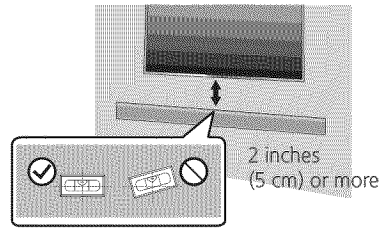

## DETACHING THE WALL MOUNT

1. Pull the Soundbar upwards as shown in the figure to separate it from the wall mount.

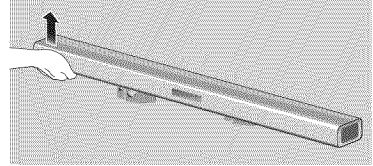

Using the Soundbar with Wall Mount

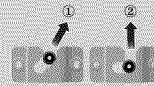

[Detaching the Soundbar from the Wall Mount]



- Do not hang onto the installed unit and avoid striking or dropping the unit.
- Secure the unit firmly to the wall so that it does not fall off. If the unit falls off, it may cause an injury or damage the product.
- When the unit is installed on a wall, please make sure that children do not pull any of the connecting cables, as it may cause it to fall.
- For the optimal performance of a wall mount installation, install the speaker system at least 2 inches (5 cm) below the TV, if the TV is mounted on the wall.
- For your safety, if you do not mount the unit on the wall, install it on a secure, flat surface where it is unlikely to fall.

## CONNECTING THE WIRELESS SUBWOOFER

The Subwoofer's linking ID is preset at the factory and the main unit and subwoofer should link (connect wirelessly) automatically when the main unit and subwoofer are turned on. If the Link indicator (📶) does not light when the main unit and subwoofer are turned on, please set the ID by following the procedure below.

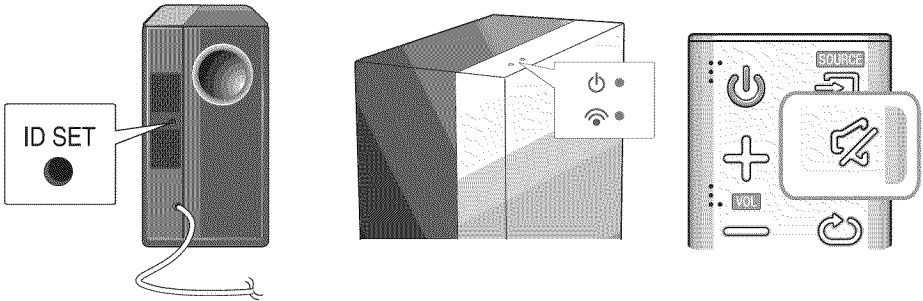

1. Plug the power cords of the main unit and subwoofer into an AC wall outlet.
2. Press the **ID SET** button on the back of the subwoofer with a small, pointed object for 5 seconds.
  - The **STANDBY** indicator is turned off and the **LINK** indicator (Blue LED) blinks quickly.
3. While the main unit is powered off (in **STANDBY** mode), press and hold the **MUTE** (🔇) on the remote control for 5 seconds.
4. The **ID SET** message appears on the Soundbar's display.
5. To finalize the link, turn the main unit's power on while the subwoofer's Blue LED blinks.
  - The main unit and the subwoofer should now be linked (connected).
  - The Link indicator (Blue LED) on the subwoofer should be on.
  - If the Link indicator is not solid blue, the linking process has failed. Turn off the main unit and start again from Step 2.
  - You can enjoy better sound from the wireless subwoofer by selecting a Sound Effect. (See page 10)



- Before moving or installing the product, be sure to turn off the power and disconnect the power cord.
- If the main unit is powered off, the wireless subwoofer will be in standby mode and the **STANDBY** LED on the upper side will come on after the Link indicator (Blue LED) blinks for 30 seconds.
- If you use a device that uses the same frequency (2.4GHz) as the Soundbar near the Soundbar, interference may cause some sound interruption.
- The transmission distance of the wireless signal between the main unit and subwoofer is about 33 ft., but may vary depending on your operating environment. If a steel-concrete or metallic wall is between the main unit and the wireless subwoofer, the system may not operate at all, because the wireless signal cannot penetrate metal.
- If the main unit doesn't make a wireless connection, follow steps 1-5 in the left hand column to re-set the connection between the main unit and wireless subwoofer.



- The wireless receiving antenna is built into the wireless subwoofer. Keep the unit away from water and moisture.
- For optimal listening performance, make sure that the area around the wireless subwoofer location is clear of any obstructions.

## ATTACHING THE TOROIDAL FERRITE CORE TO THE POWER CORD OF THE SUBWOOFER

You can reduce noise caused by electromagnetic radiation by fitting the ferrite core to the power cord of your subwoofer.

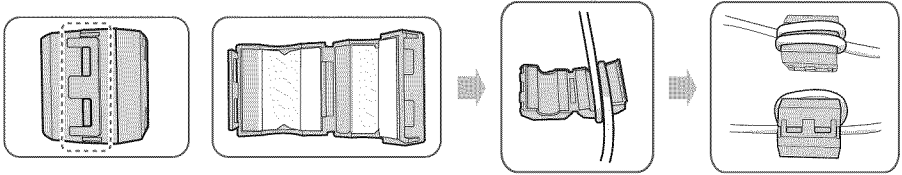

1. Unlock and open the ferrite core.
2. Wind the power cable of your subwoofer around the ferrite core twice.  
(Start winding 2 to 4 inches away from the core).
3. Close the ferrite core by pressing it until it clicks.

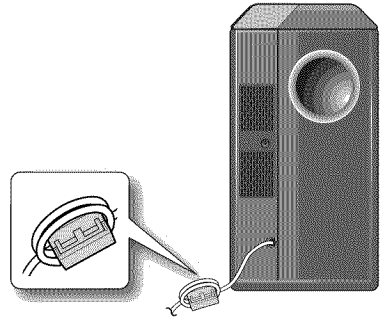

## CONNECTING AN EXTERNAL DEVICE USING AN HDMI CABLE

HDMI is the standard digital interface for connecting to TVs, projectors, DVD players, Blu-ray players, set top boxes, and more.

HDMI prevents any degradation to the signal due to conversion to analog and maintains the video and audio quality of the original digital source.

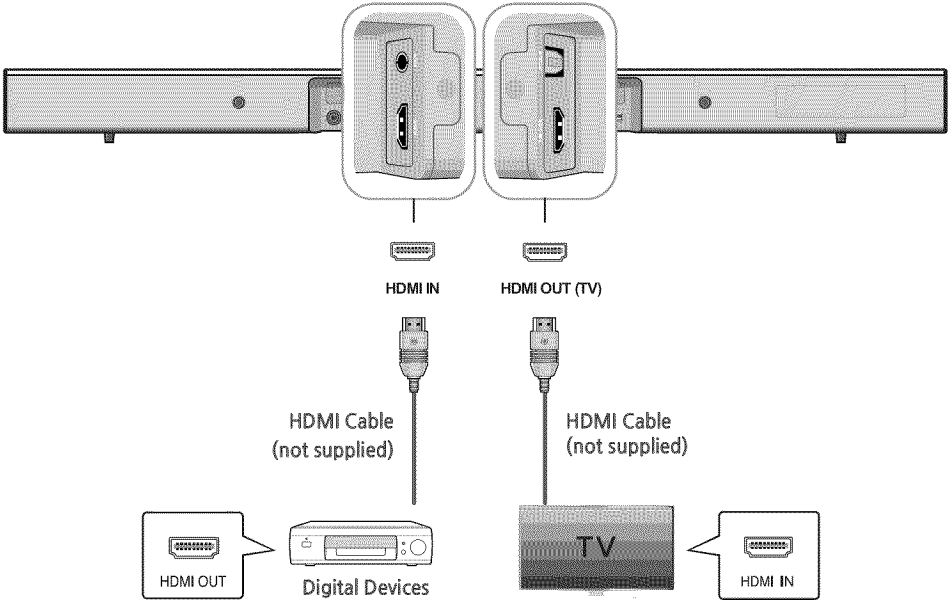

### HDMI IN

Connect an HDMI cable (not supplied) from the **HDMI IN** jack on the back of the product to the **HDMI OUT** jack on your digital device.

and,

### HDMI OUT (TV)

Connect an HDMI cable (not supplied) from the **HDMI OUT (TV)** jack on the back of the product to the **HDMI IN** jack on your TV.

### HDMI OUT (ARC)

The ARC function allows digital audio to output via the **HDMI OUT (ARC)** port.

It can be enabled only when the Soundbar is connected to a TV that supports the ARC function



- Anynet+ must be turned on.
- This function is not available if the HDMI cable does not support ARC.



- HDMI is an interface that enables the digital transmission of video and audio data with just a single connector.

## CONNECTING AN EXTERNAL DEVICE USING AUDIO (ANALOG) CABLE OR OPTICAL (DIGITAL) CABLE

This unit comes equipped with one optical in digital jack and one audio analog in jack, giving you two ways to connect it to a TV.

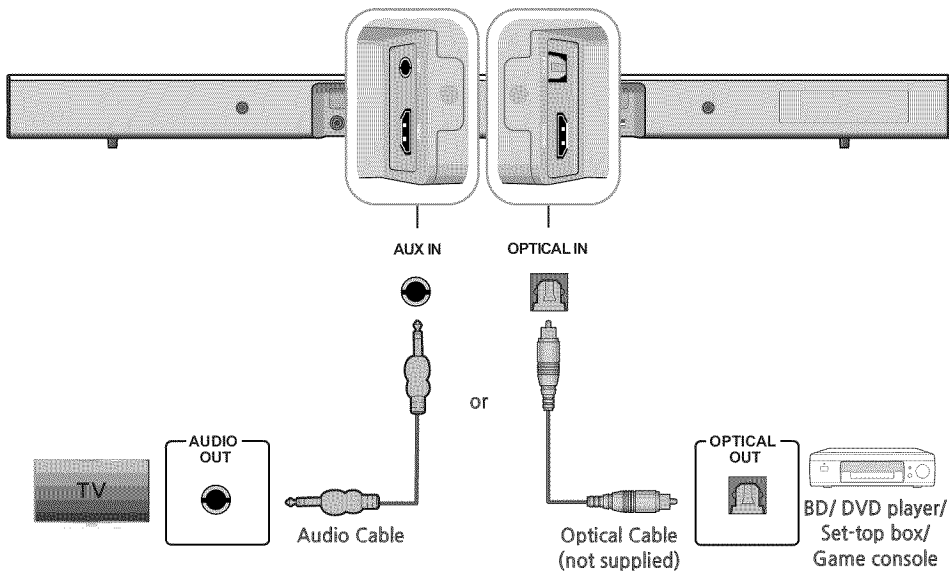

### AUX IN

Connect **AUX IN** (Audio) on the main unit to the **AUDIO OUT** jack of the TV or Source Device. Be sure to match connector colors.

or,

### OPTICAL IN

Connect **OPTICAL IN** on the main unit to the **OPTICAL OUT** jack of the TV or Source Device.



- Do not connect the power cord of this product or your TV to the wall outlet until all connections between components are complete.
- Before moving or installing this product, be sure to turn off the power and disconnect the power cord.



# FUNCTIONS

## INPUT MODE

Press the (**F.**) button on the main unit's top panel or the  (SOURCE) button on the remote control to select the mode you want.

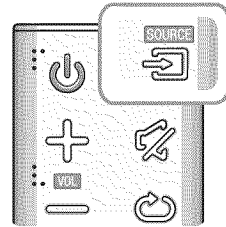
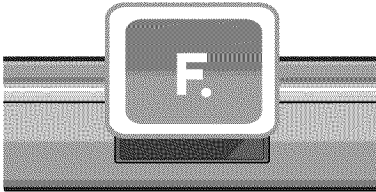

Input mode	Display
Optical Digital input	<b>D.IN</b>
AUX input	<b>AUX</b>
HDMI input	<b>HDMI</b>
BLUETOOTH mode	<b>BT</b>
TV mode	<b>TV</b>
USB mode	<b>USB</b>

The unit turns off automatically in the following situations.

- D.IN/HDMI/BT/TV/USB/ARC Mode
  - If there is no audio signal for 25 minutes.
- AUX Mode
  - If the AUX cable is disconnected for 25 minutes.
  - If there is no KEY input for 8 hours when the AUX cable is connected.
  - To turn the Auto Power Down function ON or OFF, press and hold the  button for 5 seconds. AUTO POWER DOWN ON / OFF appears on the display.

## ARC (HDMI OUT)

ARC (Audio Return Channel) transfers digital audio signal to the HDMI OUT (ARC) port.

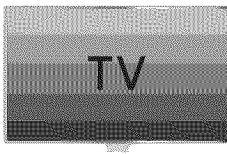

HDMI Cable



1. Connect the TV supporting ARC to the Soundbar with an HDMI cable.
2. Turn on the TV, and turn on the Soundbar's Anynet+.
3. Press the (**F.**) button on the main unit's top panel or the  (SOURCE) button on the remote control to select the **D.IN** mode.



- If the HDMI cable does not support ARC feature, ARC may not work properly.
- To turn off the ARC function, turn Anynet+ off.

## BLUETOOTH

You can connect a Bluetooth device to the Soundbar and enjoy music with high quality stereo sound, all without wires!

### ► To connect the Soundbar to a Bluetooth device

Check if the Bluetooth device supports the Bluetooth compliant stereo headset function.

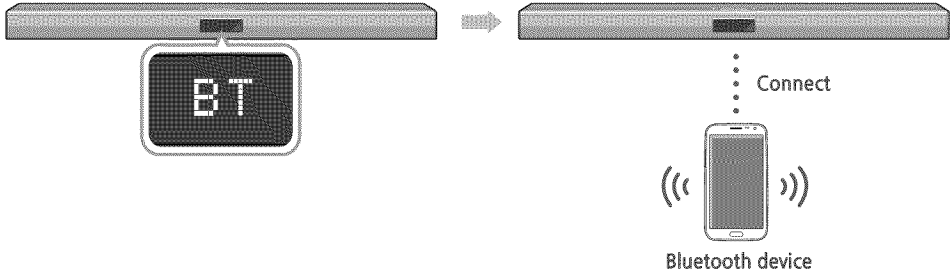

1. Press the **(F.)** button on the main unit's top panel or the **(SOURCE)** button on the remote control to select the **BT** mode.
  - You will see **BT READY** on the front display of the Soundbar.
2. Select the Bluetooth menu on the Bluetooth device you want to connect. (Refer to the Bluetooth device's user manual.)
3. Select the Stereo headset menu on the Bluetooth device.
  - You will see a list of scanned devices.
4. Select **"[Samsung] Soundbar"** from the list.
  - When the Soundbar is connected to the Bluetooth device, it will display **[Bluetooth device name] → BT** on the front display.
  - The device name can only be displayed in English. An underline " \_ " will be displayed if the name is not in English.
  - If the Bluetooth device has failed to pair with the Soundbar, delete the previous **"[Samsung] Soundbar"** found by the Bluetooth device and have it search for the Soundbar again.
5. Play music on the connected device.
  - You can listen to the music playing on the connected Bluetooth device over the Soundbar.
  - In BT mode, the Play/Pause/Next/Prev functions are not available. However, these functions are available in Bluetooth devices supporting AVRCP.



- If asked for PIN code when connecting a Bluetooth device, enter <0000>.
- Only one Bluetooth device can be paired at a time.
- The Bluetooth connection will be terminated when you turn the Soundbar off.
- The Soundbar may not perform Bluetooth search or connection correctly under the following circumstances:
  - If there is a strong electrical field around the Soundbar.
  - If several Bluetooth devices are simultaneously paired with the Soundbar.
  - If the Bluetooth device is turned off, not in place, or malfunctions.
  - Note that such devices as microwave ovens, wireless LAN adaptors, fluorescent lights, and gas stoves use the same frequency range as the Bluetooth device, which can cause electric interference.
- The Soundbar supports SBC data (44.1kHz, 48kHz).
- Connect only to a Bluetooth device that supports the A2DP (AV) function.
- You cannot connect the Soundbar to a Bluetooth device that supports only the HF (Hands Free) function.
- Once paired the device, on D.IN/AUX/HDMI/USB/ARC mode, select **"[Samsung] Soundbar"** from the list will automatically change to **BT** mode.

## ► Bluetooth POWER on (Bluetooth POWER)

When the Bluetooth Power On function is on and the Soundbar is turned off, if a previously paired Bluetooth device tries to pair with the Soundbar, the Soundbar turns on automatically.

1. If the Soundbar is turned off, press and hold ( **F** ) button on the top panel for 5 seconds.  
Or press the **Bluetooth POWER** on the remote while the Soundbar is turned on.
2. Bluetooth POWER on appears on the Soundbar's display.



- Available only if the Soundbar is listed among the Bluetooth device's paired devices. (The Bluetooth device and the Soundbar must have been previously paired at least once.)
- Soundbar will appear in the Bluetooth device's searched devices list only when the Soundbar is displaying [BT READY].
- In the TV SoundConnect mode, the Soundbar cannot be paired to another Bluetooth device.
- If the Soundbar is connected to a TV through TV SoundConnect, and you turn the Soundbar off by turning off the TV, the Bluetooth Power On function will not turn the Soundbar on.

## ► To disconnect the Bluetooth device from the Soundbar

You can disconnect the Bluetooth device from the Soundbar. For instructions, see the Bluetooth device's user manual.

- The Soundbar will be disconnected.
- When the Soundbar is disconnected from the Bluetooth device, the Soundbar will display **BT DISCONNECTED** on the front display.

## ► To disconnect the Soundbar from the Bluetooth device

Press the  (SOURCE) button on the remote control or the ( **F** ) button on the product's top panel to switch from BT to another mode or turn off the Soundbar.

- The connected Bluetooth device will wait a certain amount of time for a response from the Soundbar before terminating the connection. (Disconnection time may differ, depending on the Bluetooth device)



- In Bluetooth connection mode, the Bluetooth connection will be lost if the distance between the Soundbar and the Bluetooth device exceeds 16.25 ft. (5m).
- The Soundbar automatically turns off after 25 minutes in the Ready state.

## More About Bluetooth

Bluetooth is a technology that enables Bluetooth-compliant devices to interconnect easily with each other using a short wireless connection.

- A Bluetooth device may cause noise or malfunction, depending on usage, when:
  - A part of your body is in contact with the receiving/transmitting system of the Bluetooth device or the Soundbar.
  - It is subject to electrical variation from obstructions caused by a wall, corner, or office partition.
  - It is exposed to electrical interference from same frequency-band devices including medical equipment, microwave ovens, and wireless LANs.
- Pair the Soundbar with the Bluetooth device while they are close together.
- The further the distance between the Soundbar and Bluetooth device, the worse the quality is.  
If the distance exceeds the Bluetooth operational range, the connection is lost.
- In poor reception areas, the Bluetooth connection may not work properly.
- The Bluetooth connection only works when it is close to the unit. The connection will be automatically cut off if the Bluetooth device is out of range. Even within range, the sound quality may be degraded by obstacles such as walls or doors.
- This wireless device may cause electric interference during its operation.

## TV SOUNDCONNECT

You can enjoy TV sound through your Soundbar when it is connected to a Samsung TV that supports the TV SoundConnect function.

### ▶ Connecting a TV to the Soundbar



1. Turn on the TV and Soundbar.
  - Set the "Add New Device" menu of the TV to "On".
2. Press the **(F<sub>2</sub>)** button on the main unit's top panel or the **(SOURCE)** button on the remote control to select the **TV** mode.
3. On the TV, a message asking whether to enable the TV SoundConnect function. "[Samsung] Soundbar" is displayed on the TV screen.
4. Select **<Yes>** to finish connecting the TV and Soundbar by TV remote control.



- Switching the Soundbar's mode from TV to another mode automatically terminates TV SoundConnect.
- To connect the Soundbar to another TV, the existing connection must be terminated.
- Terminate the connection to the existing TV, and then press the **▶||** button on the remote control for 5 seconds to connect to another TV.



- The TV SoundConnect (SoundShare) function is supported by some Samsung TVs released from 2012 on. Check whether your TV supports the TV SoundConnect (SoundShare) function before you begin. (For further information, refer to the TV's user manual.)
- If your Samsung TV was released before 2014, check the SoundShare setting menu.
- If the distance between the TV and Soundbar exceeds 16.25 ft. (5m), the connection may not be stable or the audio may stutter. If this occurs, relocate the TV or Soundbar so that they are within operational range, and then re-establish the TV SoundConnect connection.

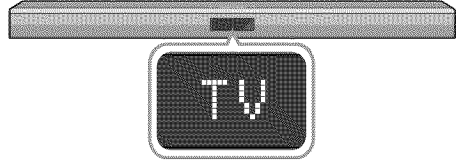

- TV SoundConnect Operational Ranges:
  - Recommended pairing range: within 20 inches (within 50cm)
  - Recommended operational range: within 16.25 ft. (5m)
- The **Play/Pause**, **Next**, **Prev** buttons are not operable in TV SoundConnect mode.

### ▶ Using the Bluetooth POWER On function

The Bluetooth POWER On function is available after you have successfully connected the Soundbar to a Bluetooth compatible TV using TV SoundConnect. When the Bluetooth POWER On function is ON, turning the connected TV on or off will turn the Soundbar's power on and off as well.

1. Connect the TV to your Soundbar using the TV SoundConnect function.
2. Press the **Bluetooth POWER** button on the Soundbar remote. "BLUETOOTH POWER ON" appears on the Soundbar's display.
  - **BLUETOOTH POWER ON** : The Soundbar turns on and off when you turn the TV on or off.
  - **BLUETOOTH POWER OFF** : The Soundbar only turns off when you turn the TV off.



- This function is supported by some Samsung TVs released from 2013 on.
- If the Soundbar is connected to a TV through TV SoundConnect, and you turn the Soundbar off by turning off the TV, the Bluetooth POWER On function will not turn the Soundbar on, even if you connect another Bluetooth device to it.

## USB

You can play music files located on USB storage devices through the Soundbar.

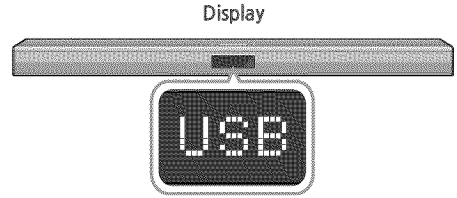
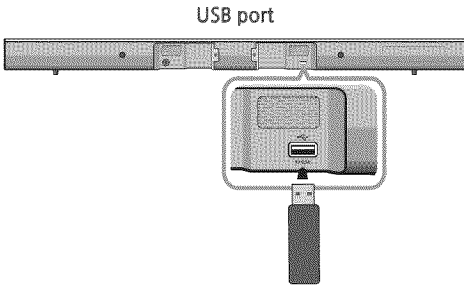

ENG

1. Connect the USB device to the USB port on the back of the product.
  2. Press the ( **F** ) button on the main unit's top panel or the **SOURCE** button on the remote control to select the **USB** mode.
  3. **USB** appears on the display screen.
    - The Soundbar connection to the USB device is complete.
    - The Soundbar automatically turns off (Auto Power Off) if no USB device has been connected for more than 25 minutes.
- Do not remove the USB device while it is transferring files.
  - DRM-protected music files (MP3, WMA) from commercial web sites cannot be played.
  - External HDDs are not supported.
  - Mobile phone devices are not supported.
  - File Format Type Compatibility list:

Format	Codec
*.mp3	MPEG 1 Layer2
	MPEG 1 Layer3
	MPEG 2 Layer3
	MPEG 2.5 Layer3
*.wma	Wave_Format_MSAudio1
	Wave_Format_MSAudio2
*.aac	AAC
	AAC-LC
	HE-AAC
*.wav	-
*.ogg	OGG 1.1.0
*.flac	FLAC 1.1.0, FLAC 1.2.1

※ Supported Sampling Rate above 16KHz.

### ► Before you connect a USB device

Be aware of the following:

- If the file name of a file or folder on a USB device exceeds 10 characters, it is not displayed on the Soundbar's display.
- This product may not be compatible with certain types of USB storage media.
- The Soundbar supports the FAT16 and FAT32 file systems.
  - The NTFS file system is not supported.
- Connect USB devices directly to the USB port of the product. Otherwise, you may encounter a USB compatibility problem.
- Do not connect multiple storage devices to the product via a multi-card reader. It may not operate properly.
- Digital camera PTP protocols are not supported.

## SOFTWARE UPDATE

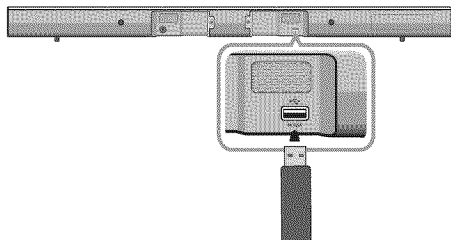

Samsung may offer updates for the Soundbar's system firmware in the future.

If an update is offered, you can update the firmware by connecting a USB device with the firmware update stored on it to the USB port on your Soundbar.

Note that if there are multiple update files, you must load them onto the USB device singly and use them to update the firmware one file at a time.

Please visit [samsung.com](http://samsung.com) or contact the Samsung call center to receive more information about downloading updates files.



- 
- Insert a USB device containing the firmware update into the USB port on the main unit.
  - Updating firmware may not work properly if audio files supported by the Soundbar are stored in the USB storage device.
  - Do not disconnect the power or remove the USB device while updates are being applied. The main unit will turn off automatically after completing the firmware update.
  - After reset, all settings are reset to their factory default settings. We recommend you write down your settings so that you can easily reset them after the update. Note that updating firmware resets subwoofer connection too. If connection to the subwoofer is not established automatically after resetting, refer to page 13.
- If the firmware fails to update, we recommend formatting the USB device in FAT16 and trying again.
- Once the software update is completed, turn off the product and then press and hold the (▶||) button on the remote control for more than 5 seconds. "INIT" appears on the display and the unit is powered off. The upgrade is complete.
  - Do not format the USB device in the NTFS format. The Soundbar does not support the NTFS file system.
  - Depending on the manufacturer, some USB devices may not be supported.
-

# TROUBLESHOOTING

Before requesting service, please check the following.

<b>The unit will not turn on.</b>	
• Is the power cord plugged into the outlet?	→ Connect the power plug to the outlet.
<b>A function does not work when the button is pressed.</b>	
• Is there static electricity in the air?	→ Disconnect the power plug and connect it again.
<b>Sound is not produced.</b>	
• Is the Mute function on?	→ Press the Mute button to cancel the function.
• Is the volume set to minimum?	→ Adjust the Volume.
<b>The remote control does not work.</b>	
• Are the batteries drained?	→ Replace with new batteries.
• Is the distance between the remote control and main unit too far?	→ Move closer to the unit.
<b>The TV SoundConnect (TV pairing) failed.</b>	
• Does your TV support TV SoundConnect?	→ TV SoundConnect is supported by some Samsung TVs released from 2012 on. Check your TV to see if it supports TV SoundConnect.
• Is your TV firmware the latest version?	→ Update your TV with the latest firmware.
• Does an error occur when connecting?	→ Contact the Samsung call center.
• Reset the TV MODE and connect again.	→ Press and hold the ►   button for 5 seconds to reset the TV SoundConnect connection.
<b>The red LED on the subwoofer blinks and the subwoofer is not producing sound.</b>	
• Your subwoofer may not be connected to the main body of the product.	→ Try to connect your subwoofer again. (See Page 13)
<b>The subwoofer drones and vibrates noticeably.</b>	
• Try to adjust the vibration of your subwoofer.	→ Press the EQUALIZER WOOFER button on your remote control to adjust its value (between SW-6 and SW+6).

## APPENDIX

## SPECIFICATIONS

<b>Model name</b>	HW-H450		
<b>GENERAL</b>	<b>Power Supply</b>	<b>Main Unit</b>	DC 24V
		<b>Subwoofer (PS-WH450)</b>	AC 120V~60Hz
	<b>Standby Power Consumption</b>		0.45W
	<b>Power Consumption</b>	<b>Main Unit</b>	30W
		<b>Subwoofer (PS-WH450)</b>	20W
	<b>USB</b>		5V/0.5A
	<b>Weight</b>	<b>Main Unit</b>	4.63 lbs
		<b>Subwoofer (PS-WH450)</b>	11.27 lbs
	<b>Dimensions (W x H x D)</b>	<b>Main Unit</b>	37.7 x 2.34 x 2.62 inches
		<b>Subwoofer (PS-WH450)</b>	7.06 x 14.29 x 11.65 inches
<b>Operating Temperature Range</b>		+41°F to +95°F	
<b>Operating Humidity Range</b>		10 % to 75 %	
<b>AMPLIFIER</b>	<b>Rated Output Power</b>	<b>Main Unit</b>	80W/CH, 3 OHM, THD = 10%, 1kHz
		<b>Subwoofer (PS-WH450)</b>	130W, 4 OHM, THD = 10%, 70Hz
	<b>S/N Ratio (Analog Input)</b>		65 dB
	<b>Separation (1 kHz)</b>		65 dB

\* S/N ratio, distortion, separation, and usable sensitivity are based on measurements using AES (Audio Engineering Society) guidelines.

\* Nominal specification

- Samsung Electronics Co., Ltd reserves the right to change the specifications without notice.
- Weight and dimensions are approximate.

※ **Open Source License Notice**

- For further information on Open Sources used in this product, please visit the website: <http://opensource.samsung.com>
- To send inquiries and requests regarding open sources, contact Samsung via Email ([oss.request@samsung.com](mailto:oss.request@samsung.com)).



# WARRANTY

## LIMITED WARRANTY TO ORIGINAL PURCHASER

This SAMSUNG brand product, as supplied and distributed by Samsung Electronics America, Inc. (SAMSUNG) and delivered new, in the original carton to the original consumer purchaser, is warranted by SAMSUNG against manufacturing defects in materials and workmanship for a limited warranty period of:

**One (1) Year Parts and Labor\***  
**(\*90 Days Parts and Labor for Commercial Use)**

This limited warranty begins on the original date of purchase, and is valid only on products purchased and used in the United States. To receive warranty service, the purchaser must contact SAMSUNG for problem determination and service procedures. Warranty service can only be performed by a SAMSUNG authorized service center. The original dated bill of sale must be presented upon request as proof of purchase to SAMSUNG or SAMSUNG's authorized service center. Transportation of the product to and from the service center is the responsibility of the purchaser.

SAMSUNG will repair or replace this product, at our option and at no charge as stipulated herein, with new or reconditioned parts or products if found to be defective during the limited warranty period specified above. All replaced parts and products become the property of SAMSUNG and must be returned to SAMSUNG. Replacement parts and products assume the remaining original warranty, or ninety (90) days, whichever is longer.

SAMSUNG's obligations with respect to software products distributed by SAMSUNG under the SAMSUNG brand name are set forth in the applicable end user license agreement. Non-SAMSUNG hardware and software products, if provided, are on an "AS IS" basis. Non-SAMSUNG manufacturers, suppliers, publishers, and service providers may provide their own warranties.

This limited warranty covers manufacturing defects in materials and workmanship encountered in normal, and except to the extent otherwise expressly provided for in this statement, noncommercial use of this product, and shall not apply to the following, including, but not limited to: damage which occurs in shipment; delivery and installation; applications and uses for which this product was not intended; altered product or serial numbers; cosmetic damage or exterior finish; accidents, abuse, neglect, fire, water, lightning or other acts of nature; use of products, equipment, systems, utilities, services, parts, supplies, accessories, applications, installations, repairs, external wiring or connectors not supplied and authorized by SAMSUNG, or which damage this product or result in service problems; incorrect electrical line voltage, fluctuations and surges; customer adjustments and failure to follow operating instructions, cleaning, maintenance and environmental instructions that are covered and prescribed in the instruction book; product removal or reinstallation; reception problems and distortion related to noise, echo, interference or other signal transmission and delivery problems. SAMSUNG does not warrant uninterrupted or error-free operation of the product.

THERE ARE NO EXPRESS WARRANTIES OTHER THAN THOSE LISTED AND DESCRIBED ABOVE, AND NO WARRANTIES WHETHER EXPRESS OR IMPLIED, INCLUDING, BUT NOT LIMITED TO, ANY IMPLIED WARRANTIES OF MERCHANTABILITY OR FITNESS FOR A PARTICULAR PURPOSE, SHALL APPLY AFTER THE EXPRESS WARRANTY PERIODS STATED ABOVE, AND NO OTHER EXPRESS WARRANTY OR GUARANTY GIVEN BY ANY PERSON, FIRM OR CORPORATION WITH RESPECT TO THIS PRODUCT SHALL BE BINDING ON SAMSUNG. SAMSUNG SHALL NOT BE LIABLE FOR LOSS OF REVENUE OR PROFITS, FAILURE TO REALIZE SAVINGS OR OTHER BENEFITS, OR ANY OTHER SPECIAL, INCIDENTAL OR CONSEQUENTIAL DAMAGES CAUSED BY THE USE, MISUSE OR INABILITY TO USE THIS PRODUCT, REGARDLESS OF THE LEGAL THEORY ON WHICH THE CLAIM IS BASED, AND EVEN IF SAMSUNG HAS BEEN ADVISED OF THE POSSIBILITY OF SUCH DAMAGES. NOR SHALL RECOVERY OF ANY KIND AGAINST SAMSUNG BE GREATER IN AMOUNT THAN THE PURCHASE PRICE OF THE PRODUCT SOLD BY SAMSUNG AND CAUSING THE ALLEGED DAMAGE. WITHOUT LIMITING THE FOREGOING, PURCHASER ASSUMES ALL RISK AND LIABILITY FOR LOSS, DAMAGE OR INJURY TO PURCHASER AND PURCHASER'S PROPERTY AND TO OTHERS AND THEIR PROPERTY ARISING OUT OF THE USE, MISUSE OR INABILITY TO USE THIS PRODUCT SOLD BY SAMSUNG NOT CAUSED DIRECTLY BY THE NEGLIGENCE OF SAMSUNG. THIS LIMITED WARRANTY SHALL NOT EXTEND TO ANYONE OTHER THAN THE ORIGINAL PURCHASER OF THIS PRODUCT, IS NONTRANSFERABLE AND STATES YOUR EXCLUSIVE REMEDY.

The benefits of this Limited Warranty extend only to the original purchaser of Samsung products from an authorized Samsung reseller. THIS LIMITED WARRANTY SHALL NOT APPLY TO ANY SAMSUNG PRODUCTS PURCHASED FROM UNAUTHORIZED RESELLERS OR RETAILERS, EXCEPT IN STATES WHERE SUCH RESTRICTION MAY BE PROHIBITED. For a list of Samsung authorized retailers, please go to: [http://www.samsung.com/us/peaceofmind/authorized\\_resellers.html](http://www.samsung.com/us/peaceofmind/authorized_resellers.html)

Some states do not allow limitations on how long an implied warranty lasts, or the exclusion or limitation of incidental or consequential damages, so the above limitations or exclusions may not apply to you. This warranty gives you specific legal rights, and you may also have other rights which vary from state to state.

To obtain warranty hardware service, please contact SAMSUNG customer care center.



As an ENERGY STAR Partner, Samsung has determined that this product or product models meets the ENERGY STAR guidelines for energy efficiency.



## QUESTIONS OR COMMENTS?

COUNTRY	CALL	OR VISIT US ONLINE AT	WRITE
U.S.A	1-800-SAMSUNG (726-7864)	<a href="http://www.samsung.com/us/support">www.samsung.com/us/ support</a>	Samsung Electronics America, Inc. 85 Challenger Road Ridgefield Park, NJ 07660