

SONY®

Television Téléviseur

Operating Instructions (Setup Guide)	US
---	----

Mode d'emploi (Guide d'installation)	FR
---	----

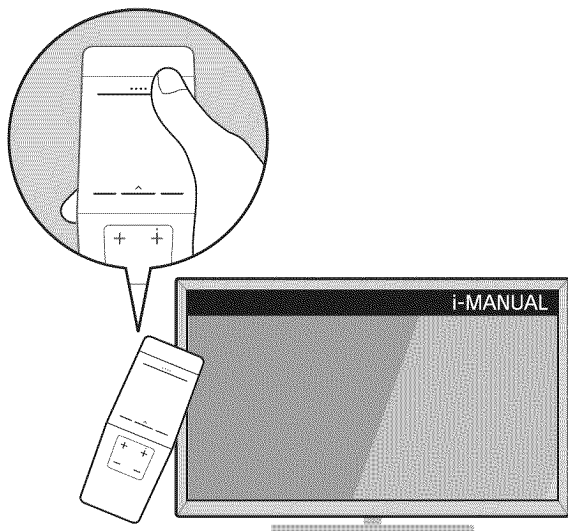

Sony Customer Support

U.S.A.:

<http://www.sony.com/tvsupport>

Canada:

<http://www.sony.ca/support>

United States

Canada

1.800.222.SONY

1.877.899.SONY

Please Do Not Return
the Product to the Store

Service à la clientèle Sony

Canada :

<http://support.sony.ca/fr>

États-Unis :

<http://www.sony.com/tvsupport>

Canada

États-Unis

1.877.899.SONY

1.800.222.SONY

Ne retournez pas le produit au magasin

BRAVIA

KDL-55W950B

Owner's Record

The model and serial numbers are located at the side and rear of the TV. Record these numbers in the spaces provided below. Refer to them whenever you call upon your Sony dealer regarding this TV.

Model Name

Serial No.

CAUTION

To prevent electric shock and blade exposure, do not use this AC plug with an extension cord, receptacle or other outlet unless the blades can be fully inserted.

- Operate the TV only on 110-240 V AC (U.S.A./Canada 120 V AC)
- Some people may experience discomfort (such as eye strain, fatigue, or nausea) while watching 3D video images or playing stereoscopic 3D games. Sony recommends that all viewers take regular breaks while watching 3D video images or playing stereoscopic 3D games. The length and frequency of necessary breaks will vary from person to person. You must decide what works best. If you experience any discomfort, you should stop watching the 3D video images or playing stereoscopic 3D games until the discomfort ends; consult a doctor if you believe necessary. You should also review (i) the instruction manual of any other device or media used with this television and (ii) our website (<http://www.sony.com/tvsupport>) for the latest information. The vision of young children (especially those under six years old) is still under development. Consult your doctor (such as a pediatrician or eye doctor) before allowing young children to watch 3D video images or play stereoscopic 3D games. Adults should supervise young children to ensure they follow the recommendations listed above.
- Do not use, store, or leave the 3D Glasses or battery near a fire, or in places with a high temperature, e.g., in direct sunlight, or in sun-heated cars.

- When using the simulated 3D function, please note that the displayed image is modified from the original due to the conversion done by this television.

Licensing Information

The terms HDMI and HDMI High-Definition Multimedia Interface, and the HDMI Logo are trademarks or registered trademarks of HDMI Licensing LLC in the United States and other countries.

Ferguson Patent Properties, LLC:
U.S. Patent No. 5,717,422
U.S. Patent No. 6,816,141

Manufactured under license from Dolby Laboratories. Dolby and the double-D symbol are trademarks of Dolby Laboratories.

"Blu-ray Disc", "Blu-ray" and "Blu-ray Disc" logo are trademarks of Blu-ray Disc Association.

"BRAVIA" and BRAVIA, S-Force, Motionflow, BRAVIA Sync, and  are trademarks or registered marks of Sony Corporation.

DLNA[®], the DLNA Logo and DLNA CERTIFIED[®] are trademarks, service marks, or certification marks of the Digital Living Network Alliance.

TrackID is a trademark or registered trademark of Sony Mobile Communications AB.

Music and video recognition technology and related data are provided by Gracenote[®]. Gracenote is the industry standard in music recognition technology and related content delivery. For more information, please visit www.gracenote.com.

CD, DVD, Blu-ray Disc, and music and video-related data from Gracenote, Inc., copyright © 2000-present Gracenote. Gracenote Software, copyright © 2000-present Gracenote. One or more patents owned by Gracenote apply to this product and service. See the Gracenote website for a non-exhaustive list of applicable Gracenote patents.

Gracenote, Gracenote eyeQ, Gracenote VideoID, Gracenote Video Explore, Gracenote MusicID, the Gracenote logo and logotype, and the "Powered by Gracenote" logo are either registered trademarks or trademarks of Gracenote in the United States and/or other countries.

Opera[®] Devices SDK from Opera Software ASA. Copyright 1995-2014 Opera Software ASA. All rights reserved.

Wi-Fi, Wi-Fi Direct and Miracast are trademarks or registered trademarks of Wi-Fi Alliance.

"Sony Entertainment Network logo" and "Sony Entertainment Network" are trademarks of Sony Corporation.

MHL, Mobile High-Definition Link and the MHL Logo are trademarks or registered trademarks of MHL Licensing, LLC.

For DTS patents, see <http://patents.dts.com>. Manufactured under license from DTS Licensing Limited. DTS, the Symbol, & DTS and the Symbol together are registered trademarks, and DTS Digital Surround is a trademark of DTS, Inc. © DTS, Inc. All Rights Reserved.

Designed with UEI Technology[™] Under License from Universal Electronics Inc. Portions © UEI 2000-2013

The Bluetooth[®] word mark and logos are owned by the Bluetooth SIG, Inc. and any use of such marks by Sony Corporation is under license. Other trademarks and trade names are those of their respective owners.

The N Mark is a trademark or registered trademark of NFC Forum, Inc. in the United States and in other countries.





Your BRAVIA TV is ENERGY STAR® qualified in the default mode. It meets strict energy efficiency guidelines

set by the U.S. Environmental Protection Agency and Department of Energy. ENERGY STAR is a joint program of these government agencies, designed to promote energy efficient products and practices.

Changes to certain features, settings, and functionalities (when available) of this TV (i.e. Picture/Sound, Light Sensor, Power Savings, Picture Scene/Mode, Auto Display, Shop Front Display Settings) can increase or change the power consumption.

The "Auto" and "General" picture scenes are default settings optimized for the input signal selected. Your BRAVIA TV is tested in these settings for ENERGY STAR qualification.

Depending upon such changed settings, the power consumption may exceed the limits required for the ENERGY STAR qualification in the default mode.

The 55 class has a 54.6 inch viewable image size (measured diagonally).

Location of the identification label

Labels for the Model No., Power Supply rating (in accordance with applicable safety regulation) and Manufacturing date are located on the rear of the TV.



- The illustrations of the remote control used in this manual are of the RMF-YD003 (Touchpad Remote Control) and RM-YD102 (IR (infrared) Remote Control) unless otherwise stated.
- The illustrations used in this manual may differ depending on your TV model.
- Retain this manual for future reference.

The BRAVIA® Full HDTV Experience

Thank you for choosing Sony! Your new BRAVIA® TV opens the door to the "Full HDTV Experience." This document will help you get the most out of your TV.

Please take a moment to register your TV at:

U.S.A.: <http://productregistration.sony.com>

Canada: <http://www.sony.ca/registration>

Four Steps to a Full HD Experience

Set, Source, Sound, and Setup.

1 Set

Now that you have made the best selection in LED backlit LCD TV technology, be sure to remove all accessory contents from the packaging before setting up your TV.

2 Source

To experience the stunning detail of your BRAVIA TV, you need access to HD programming.

- Upgrade your signal or content source to high-definition (HD) by contacting your HD service provider.

- Receive over-the-air HD broadcasts with an HD-quality antenna connected directly to the back of your TV.

Visit <http://www.antennaweb.org> for more information on antenna selection and setup.

- Discover the wealth of entertainment now available on super-high resolution Blu-ray Disc™ player and other Sony HD equipment.

3 Sound

Complete the high-definition experience with a BRAVIA Sync™ surround sound system or A/V receiver from Sony.

4 Setup

Install your TV and connect your sources. See page 12 for sample connection diagrams. To help assure the highest quality for your HD experience, use Sony HDMI (High-Definition Multimedia Interface) cables.



To learn more about HDTV, visit:

U.S.A.: <http://www.sony.com/HDTV>

Canada: <http://www.sony.ca/hdtv>

This TV displays all video input signals in a resolution of 1,920 dots × 1,080 lines.

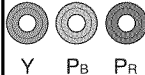
The following chart shows the high-definition (HD) and standard-definition (SD) video formats supported by your BRAVIA TV inputs.

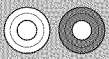
	INPUT	VIDEO	AUDIO	SUPPORTED FORMATS								
				1080i/24p/30p	1080p* ¹	1080i	720i/24p/30p	720p* ¹	480p	480i	PC* ²	
HD	HDMI			✓	✓	✓	✓	✓	✓	✓	✓	✓
	COMPONENT	 Y Pb Pr	 Audio L/R		✓	✓		✓	✓	✓		
SD	VIDEO	 Composite video connection	 Audio L/R								✓	

*¹ For details of supported formats, refer to the "Specifications" in this manual.

*² For supported PC formats refer to the i-Manual.

About this manual (Operating Instructions)

This manual explains how to setup your TV. For more information on how to use your BRAVIA TV, refer to the "Electronic manual".

Operating Instructions

Explains how to setup your TV such as connections, initial setup, and basic operations.

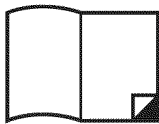

For more information, see the i-Manual



Electronic manual (i-Manual)

Explains how to use all the features. See page 30 on how to use the i-Manual.

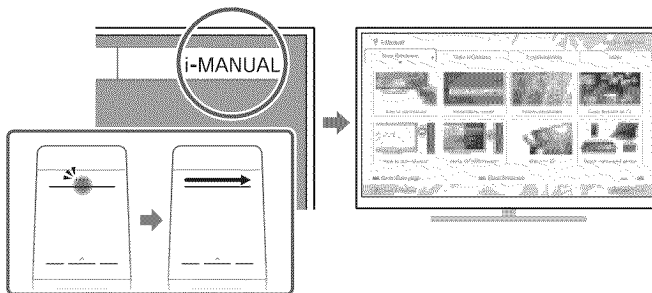

Images and illustrations used in this manual may differ from the actual screen.

Table of Contents

Getting Started

Checking the accessories.....	8
Inserting batteries into the remote control.....	8
Before setting up your TV.....	9
1: Attaching the Table-Top Stand	10
2: Connecting the TV.....	12
3: Securing the TV.....	18
4: Bundling the cables	20
5: Connecting the TV to the Internet.....	20
6: Running initial setup.....	21
Watching TV	23
Using the remote control.....	24

US

Using Your BRAVIA TV

Discovering the contents you like (Discover).....	26
Enjoying social networking while watching TV (Social Viewing).....	27
Selecting various contents and tools (Home Menu)	27

Looking for Instructions

Looking for instructions in the electronic manual (i-Manual) ▶ ... 30

Additional Information

Troubleshooting.....	33
How to care for your BRAVIA TV.....	35
Specifications	36
Installing the TV to the Wall	38
Installing the TV against a wall or enclosed area.....	40
Safety Information.....	41

Checking the accessories

- IR Remote Control (1)*
- Touchpad Remote Control (1)*
- Size AAA batteries (4)
- Cable clammer (2)
- Table-Top Stand (2)
- Fixing screws for Table-Top Stand (M5 × 16) (4)
- Wall-Mount Attachment (M6) (2)
- Wall-Mount Attachment (M5) (2)
- Passive 3D Glasses (2)
- IR Blaster (1)
- Operating Instructions (this manual) and other documents

* Refer to the model name printed on the remote control.

Inserting batteries into the remote control

Touchpad Remote Control

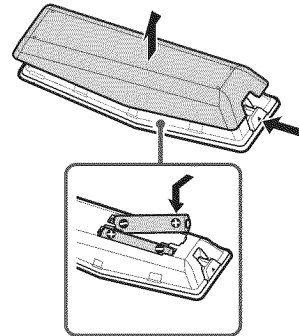

- 1 Remove the protection sheet.
- 2 Press the latch and lift the cover to open.

IR Remote Control

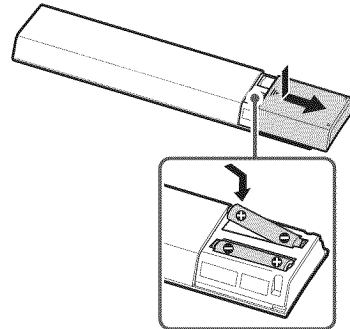

- 1 Remove the protection sheet.
- 2 Push and slide the cover to open.

■ Guidelines for IR Remote Control

- Point your remote control directly at the IR sensor located on your TV.
- Make sure that no objects are blocking the path between the remote control and the IR sensor on your TV.

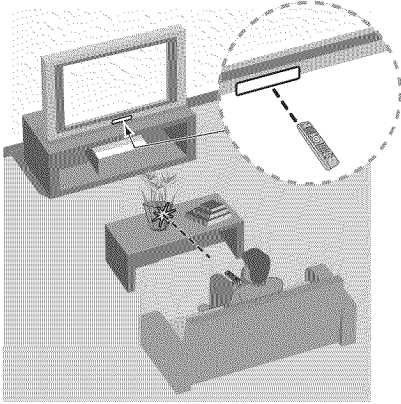

- Fluorescent lamps can interfere with your remote control; try turning off the fluorescent lamps.
- If you are having problems with the remote control, reinsert or replace your batteries and make sure that they are correctly inserted.

Before setting up your TV

Some TV models are packaged with a detached Table-Top Stand so you can mount your TV to a wall right away. See page 38 (Installing the TV to the Wall) if you want to mount the TV to a wall. If you are not mounting the TV to a wall, you will need to attach the Table-Top Stand. You will need a Phillips screwdriver (not supplied) and the supplied screws to complete the task. Look for the supplied Table-Top Stand instruction leaflet.

Be sure to consider the following while setting up your TV:

- Disconnect all cables when carrying the TV.
- Carry the TV with the adequate number of people; larger size TVs require two or more people.
- Correct hand placement while carrying the TV is very important for safety and to avoid damage.

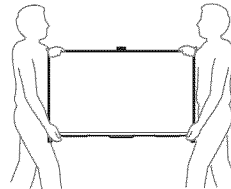

- Ensure your TV has adequate ventilation, see page 40.
- For best picture quality, do not expose the screen to direct illumination or sunlight.
- Avoid installing the TV in a room with reflective wall and floor materials.
- Avoid moving the TV from a cold area to a warm area. Sudden room temperature changes may cause moisture condensation. This may cause the TV to show poor picture and/or poor color. Should this occur, allow moisture to evaporate completely before powering the TV on.

- Ensure that there are no objects in front of the TV.

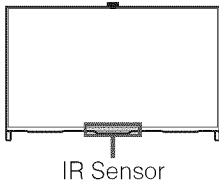

1: Attaching the Table-Top Stand

■ Recommended (edge position)

Refer to the supplied Table-Top Stand leaflet for proper attachment.



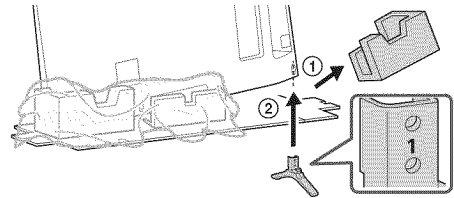

- Do not put stress on the LCD panel or the frame around the screen.
- Be careful to not pinch your hands or the AC power cord when you install the TV set to the Table-Top Stand.
- Two or more people are needed to carry out this installation.

- 1 Remove the cushion of the right side ①, and attach the Table-Top Stand to the TV ②.

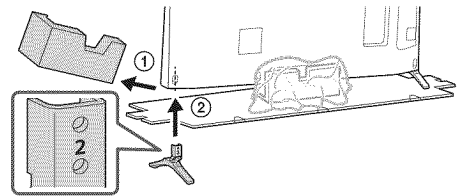

- 2 Repeat step 1 for the left side.



- 3** Fix the TV to the Table-Top Stand using the supplied screws. The arrow marks  indicate the location of the screw holes used for securing the Table-Top Stand.

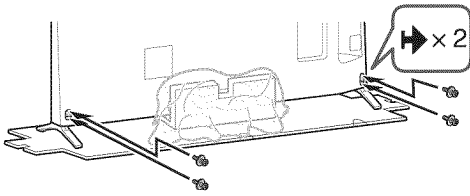

- If using an electric screwdriver, set the torque at approximately 1.5 N·m {15 kgf·cm}.

Alternative (middle position)

You can change the Table-Top Stand from the edge to the middle position by referring to the instructions below.

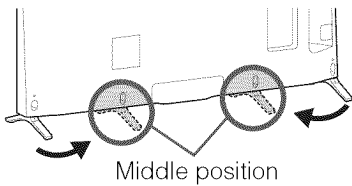

1

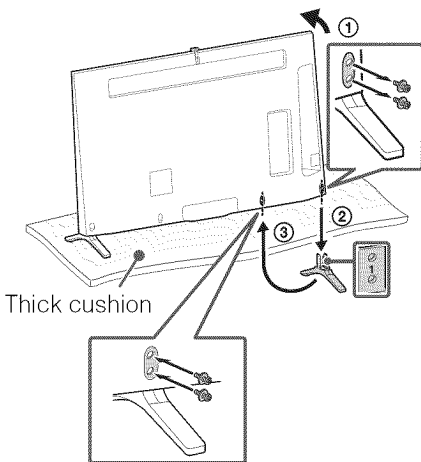

2

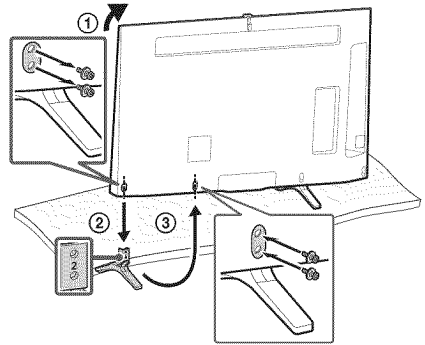

US

Detaching the Table-Top Stand from the TV

To detach the Table-Top Stand from the TV, remove the screws  fixed in step 3 (edge position).



- Do not remove the Table-Top Stand for any reason other than to install corresponding accessories on the TV.
- Be sure the TV is vertical before turning on. To avoid uneven picture uniformity do not power on the TV with the LCD panel facing down.
- When attaching the Table-Top Stand again, be sure to fasten the screws (previously removed) to the original holes on the rear of the TV.

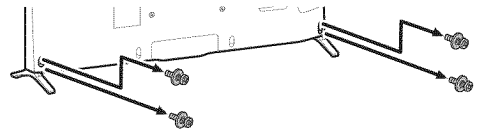

2: Connecting the TV



- Use an antenna cable connector no greater than 14 mm thick.
- When connecting the cable to the Cable/ Antenna, input finger tighten only, over tightening the connection can damage the TV.
- Before moving the TV, disconnect all of the cables connected to the TV to prevent damaging the TV when it is moved.
- Use an HDMI cable connector within 12 mm (thickness) × 21 mm (width).
- For more information on connections, refer to the i-Manual.

■ Shown with a Set Top Box with HDMI connection

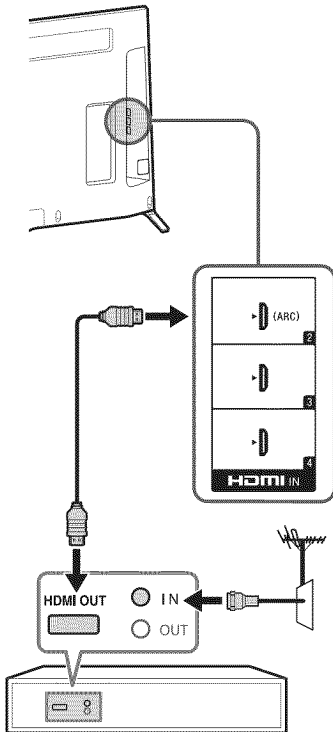

Recommendation of the F type plug

Projection of the inner wire from the connection part must be less than 1.5 mm.

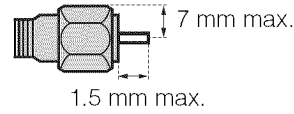

(Reference drawing of the F type plug)

■ Shown with a Set Top Box with COMPONENT connection

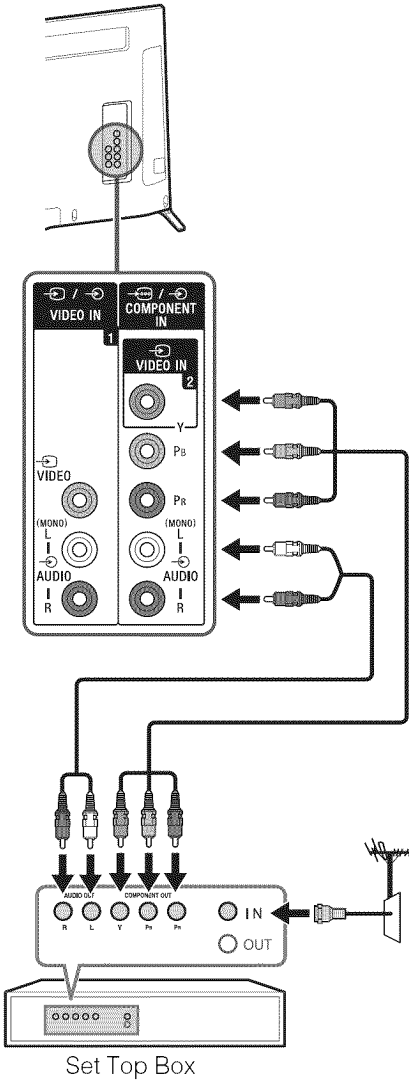

■ Cable System or VHF/UHF Antenna System

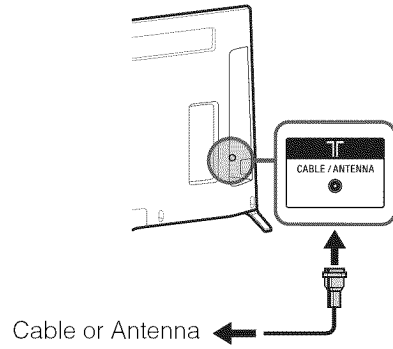

US

■ Shown with MHL device with MHL connection

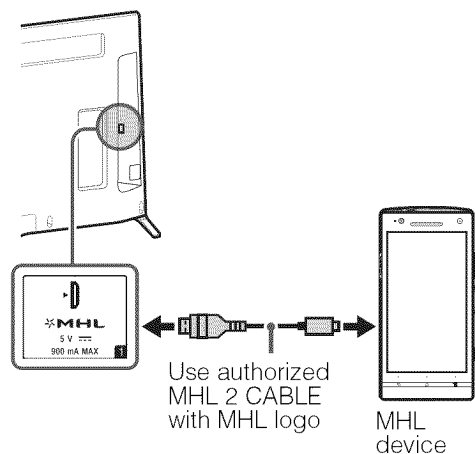

The TV simultaneously charges the MHL-compatible connected device while playing photo/music/video files. You can use the TV remote control to control the connected MHL-compatible device.



- If **Auto Input Change (MHL)** is set to **On**, the TV automatically switches to HDMI IN 1/MHL from other input when MHL-compatible device is connected to HDMI IN 1/MHL jack. The availability of **Auto Input Change (MHL)** depends on whether the MHL-compatible device can support this feature.
- If **Charge MHL during Power Off** is set to **On**, you can continue charging the MHL-compatible device even when the TV is in standby mode.

■ Shown with HD BRAVIA® Sync™ Basic Connection

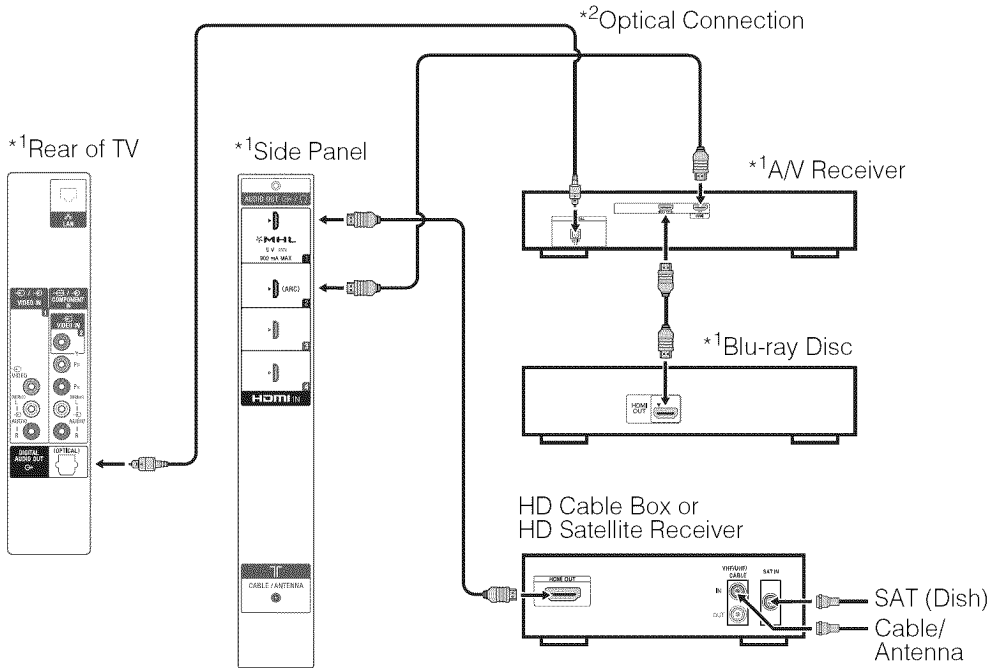

US

*1 Signifies a BRAVIA Sync capable device.

*2 The optical connection is only needed for A/V receivers that do not support ARC (Audio Return Channel).

Set the speaker settings to audio out, press **HOME**, then select **Settings** → **Sound** → **Speakers** → **Audio System**.

Set the HDMI CEC settings on the TV and AV receiver to allow for system audio control for ARC connections.

■ Shown with HD Basic Connection with Home Theater System

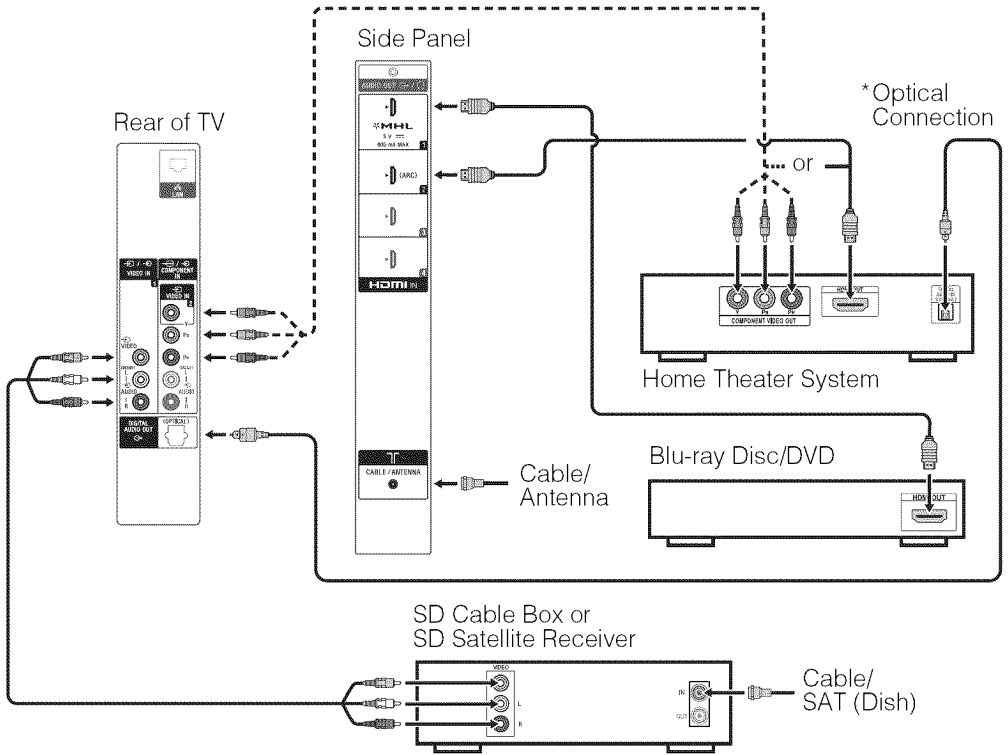

* The optical connection is only needed for home theater system that do not support ARC (Audio Return Channel) when connecting with HDMI.
 Set the speaker settings to audio out, press **HOME**, then select **Settings** → **Sound** → **Speakers** → **Audio System**.
 Set the HDMI CEC settings on the TV and AV receiver to allow for system audio control for ARC connections.

■ Shown with PC Connection with SD VCR/DVD

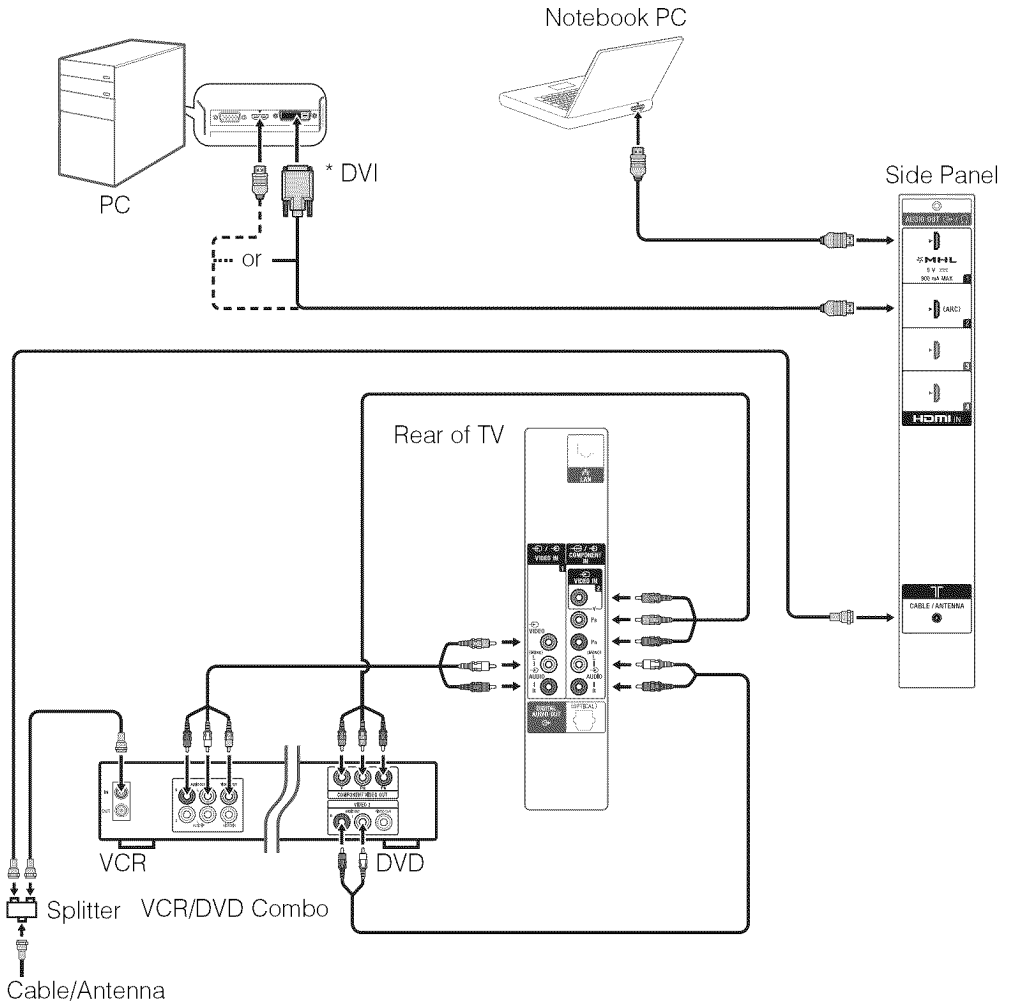

US

* DVI does not support audio signals. Connect the audio output of the PC to the PC speakers or an A/V receiver to listen to sound from the PC.

3: Securing the TV



Sony strongly recommends taking measures to prevent the TV from toppling over. Unsecured TVs may topple and result in property damage, serious bodily injury or even death.

Preventing the TV from Toppling

- Secure the TV to a wall and/or stand.
- Do not allow children to play or climb on furniture and TV sets.
- Avoid placing or hanging items on the TV.
- Never install the TV on:
 - slippery, unstable and/or uneven surfaces.
 - furniture that can easily be used as steps, such as a chest of drawers.
- Install the TV where it cannot be pulled, pushed, or knocked over.
- Route all AC power cords and connecting cables so that they are not accessible to curious children.

Recommended Measures to Secure the TV

Consider the following measures when securing your TV to a Stand (not supplied).

- 1** Secure the Stand for the TV.
Make sure the Stand can adequately support the weight of the TV. Use two angle braces (not supplied) to secure the stand. For each angle brace use the appropriate hardware to:
 - Attach one side of the angle brace to the wall stud.
 - Attach the other side to the Stand.

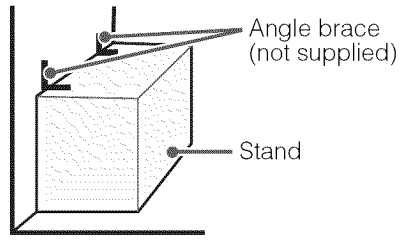

- 2** Secure the TV to the Stand.
Use the optional hardware listed as follows (not supplied):
 - M4 machine screw (screwed into the TV's Table-Top Stand)
 - A screw or similar (attach it to the Stand)
 - Rope or chain (strong enough to support the weight of the TV). Make sure that there is no excess slack in the rope or chain.

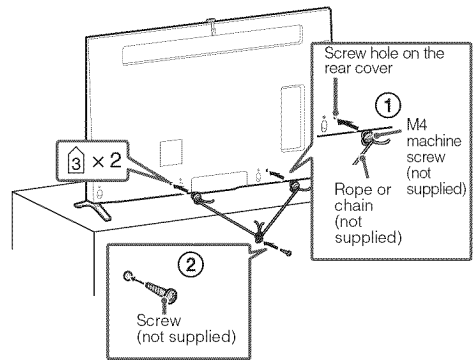

The length of the M4 machine screw differs depending on the rope or chain diameter. Please see below illustration.

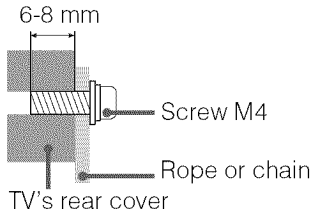

- Your TV is shipped with screws attached to the rear of the TV depending on the TV model. (They are fastened in the screw holes for wall mounting.) Be sure to remove the upper two screws prior to anchoring the TV to a wall.
- Securing the TV to the stand without securing the TV and the stand to the wall provides minimum protection against the TV toppling over. For further protection, be sure to follow the three measures recommended.

US

3 Anchor the TV to the wall by using bolts, wall anchor and chain (or rope).

Anchor bolts (M6) (not supplied)

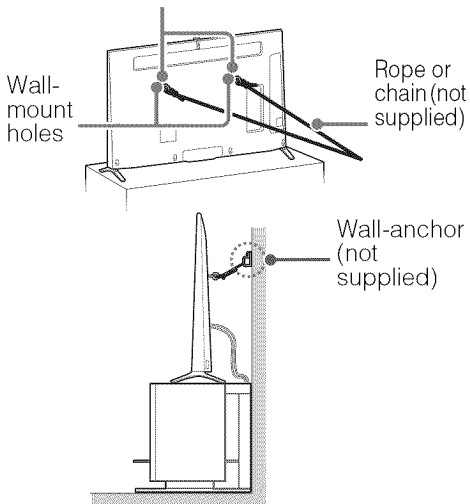

4: Bundling the cables



- Do not bundle the AC power cord together with other cables.

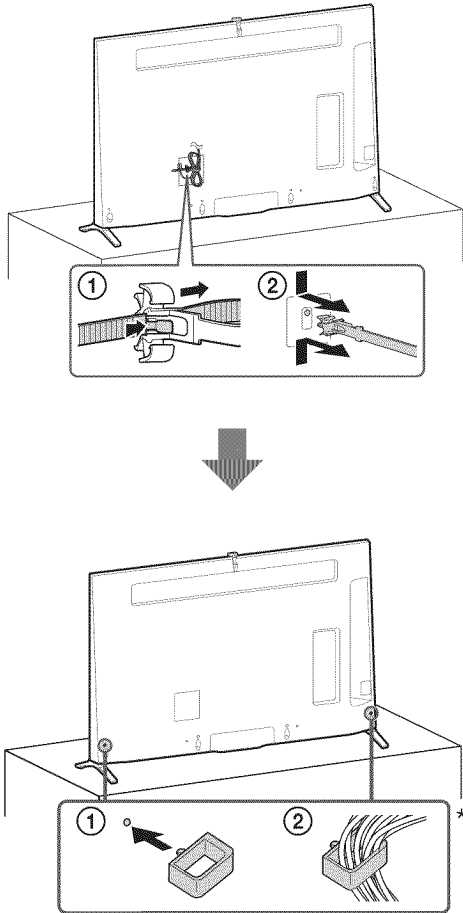

* You do not need to perform this step for Super Slim mounting (see page 39).

5: Connecting the TV to the Internet

When you connect this TV to the Internet, you can enjoy multiple functions. For details on the functions, refer to the i-Manual.



- You will need to contract with an Internet service provider to connect to the Internet.

Preparing a wired network

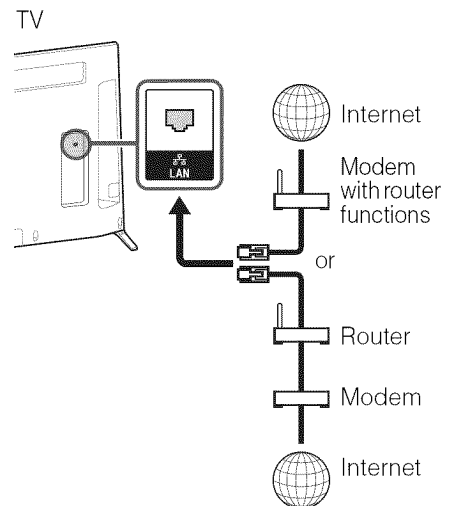

- For LAN connections, use a Category 7 cable (not supplied).

Preparing a Wi-Fi connection

The built-in Wi-Fi device allows you to access the Internet and your home network. With this feature, you can connect to a wireless network and enjoy the benefits of networking in a cable-free environment. Before setting up the Wi-Fi function of the TV, be sure to set up a wireless router (access point).

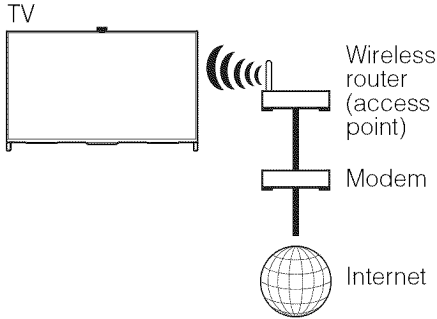

6: Running initial setup

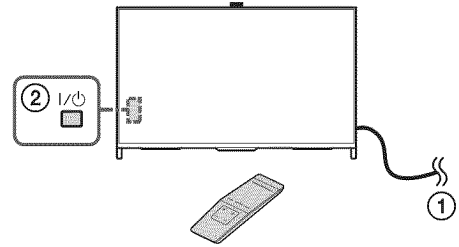

US

- 1 Complete your cable connections before proceeding with the **Initial Setup**. Connect the TV to your AC power outlet.
- 2 Press **I/⏻** on the TV. The illumination LED will light up in white. When you switch on the TV for the first time, the Language menu appears on the screen.



- The illumination LED lights up in different colors according to the status of the TV. If you do not wish to light up the illumination LED, you can turn it off later. Press **HOME**, then select **Settings** → **Preferences** → **Front Panel Illumination** → **Illumination LED** → **Off**. You can also press **OPTIONS**, then select **Illumination LED** → **Off**.

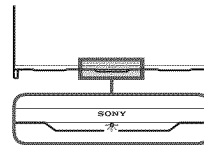

- 3** Slide up/down/left/right to select an item, then press the touchpad (press **↑/↓/←/→**, then press **⊕** if using IR Remote Control).
Follow the instructions on the screen.

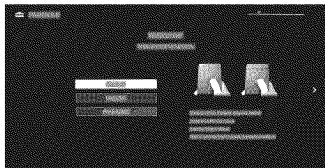

- 4** Set up the Internet connection by selecting **Wi-Fi** or **Wired LAN**. If you will not be using the network features of the TV, or to set up later, select **Skip**.



- The TV will automatically detect and setup the network when a wired connection is made before the initial setup.
- For customers who need to setup their network connection with a Static IP address and/or a Proxy server, select **Skip**. After completing the initial setup, press **HOME**, then select **Settings** → **Network** → **Network Setup** → **Set up network connection** → **Expert**.
- If you use WEP security, select **Wi-Fi** → **Connect by scan list**. Then, select the network name (SSID) you want to connect to. If you cannot find the required network name, select **[Manual Entry]** and press the touchpad (press **⊕** if using IR Remote Control) to enter network name.
- To perform **Network Setup** later, press **HOME**, then select **Settings** → **Network** → **Network Setup**.
- The TV will automatically search for a software update after the network is setup and will try to automatically detect your region.

- 5** Scan for available channels using the TV's built-in tuner by selecting **Built-in Tuner** → **Auto**. If you will be using a cable box or satellite receiver and do not wish to use the TV's built-in tuner select **Set Top Box**. If you do not wish to use the TV's built-in tuner or a set top box, select **Skip**.

Watching TV

1 Turn on the TV.

Press **I/⏻** on the TV or **POWER** on the Touchpad Remote Control to turn on the TV.

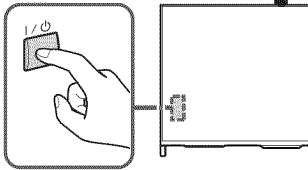

or

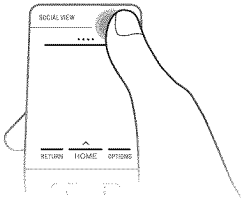

2 Press Control Bar (...).

The Screen Key Pad is displayed on the screen.

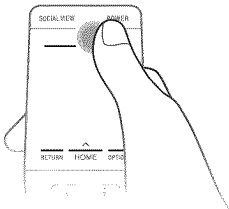

3 Slide left/right to select a TV channel or input, then press the touchpad.

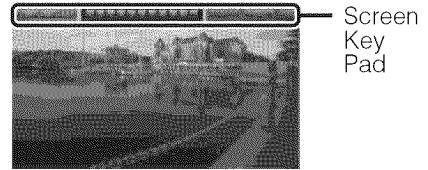

US

■ To select digital channels

Use **0-9** and point (.) on the Screen Key Pad. For example, to enter channel 2.1: Press **2**, point (.) and **1**, then press the touchpad.

📶 When using IR Remote Control

1 Press **I/⏻** on the TV or **POWER** on the remote control to turn on the TV.

2 Press **CH +/-**, **0-9** or **INPUT** to select a TV channel or input.

Use **0-9** and point (.) to select digital channels. For example, to enter channel 2.1: Press **2**, point (.) and **1**, then press ⊕.

Using the remote control

You can operate the TV by using the supplied Touchpad Remote Control or IR Remote Control.

Touchpad Remote Control

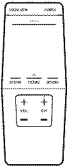

IR Remote Control

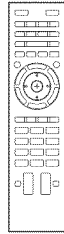

- Touchpad Remote Control can only be used after registration with the TV. You can register the Touchpad Remote Control by pressing **HOME**, then select **Settings** → **Preferences** → **Touchpad Remote Control Setup**.

Frequently used buttons

IR Remote Control

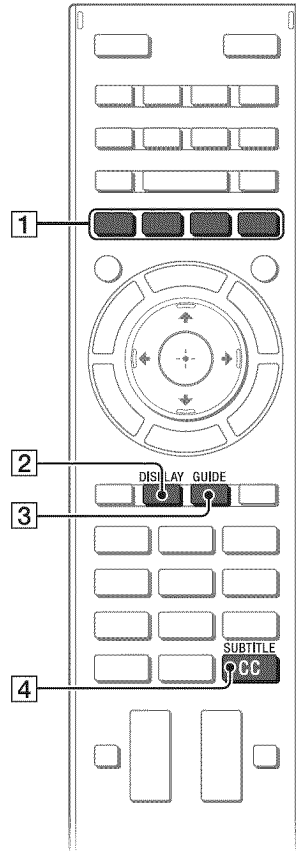

1 Color buttons

When the color buttons are available, an operation guide appears on the screen.

2 DISPLAY

Displays channel number, program details, and the clock.

3 GUIDE

Displays the digital program guide.
(For an Antenna signal only and availability depends on your TV model/region/country)

4 SUBTITLE/CC

You can turn closed captions/subtitles on/off.

Displaying the Touchpad Operation Guide

Touchpad Operation Guide allows you to see the main gesture commands that are available.

- 1 Touch and hold the centre of the Touchpad Remote Control to display the Touchpad operation guide.

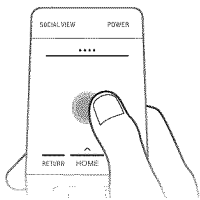

Launching the Touchpad Tutorial

- 1 Press **HOME**.

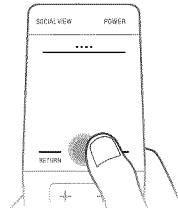

- 2 Slide to select **? Help**, then press the touchpad.



- 3 Slide up/down to select **Touchpad Tutorial**, then press the touchpad. Follow the instructions on the screen.

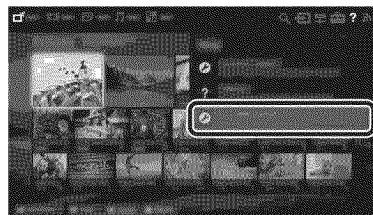

- You can also launch the Touchpad Tutorial by pressing **HOME**, then select **Settings** → **Preferences** → **Touchpad configurations** → **Start Tutorial**.

Discovering the contents you like (Discover)

You can use Discover to search for content (such as TV programs, Internet contents, etc.). Contents that appear in Discover vary depending on your TV model/region/country.

1 Slide up from the bottom area.

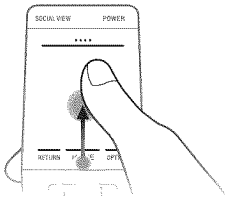

2 Slide up/down to select the desired category.

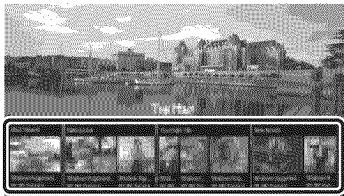

3 Slide left/right to select the desired item, then press the touchpad.

The selected content is displayed.

When using IR Remote Control

- 1 Press **DISCOVER**.
- 2 Press **↑/↓** to select the desired category.
- 3 Press **←/→** to select the desired item, then press **⊕**. The selected content is displayed.

Enjoying social networking while watching TV (Social Viewing)

Social Viewing brings the benefits of social networking to your TV viewing experience. Press **SOCIAL VIEW** to enjoy chatting with friends while watching TV. The available features in Social Viewing may vary depending on your TV model/region/country. You will need a broadband Internet connection. For details, see page 20 (5: Connecting the TV to the Internet). Then, go to **Network Setup** and follow the on-screen instructions to connect your TV to the Internet.

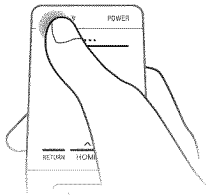

- You may need to update the TV's software to use this function. Press **HOME**, select **? Help** → **Customer Support** → **Software Update**.

Selecting various contents and tools (Home Menu)

Select the desired category at the top of the Home Menu. You can play back content by selecting its thumbnail in a subcategory. You can also use functions (such as setting change) by selecting its icon.

US

1 Press HOME.

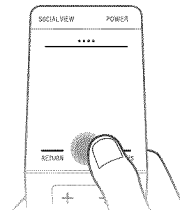

2 Slide left/right to select the desired category.



3 Slide down, then slide left/right to select the desired subcategory.

When the cursor is moved beyond the left/right edge of the subcategory, the next subcategory is displayed (if there is more than one subcategory).



4 Select the thumbnail of the desired content.

The content is played back.



When using IR Remote Control

- 1 Press **HOME**.
- 2 Press **←/→** to select the desired category.
- 3 Press **↓**, then press **←/→** to select the desired subcategory. When the cursor is moved beyond the left/right edge of the subcategory, the next subcategory is displayed (if there is more than one subcategory).
- 4 Select the thumbnail of the desired content. The content is played back.

Selecting various contents

The categories are available depending on your TV model/region/country.



Channel

You can view the list of digital broadcast contents and thumbnails of live and future broadcasts. You can also change the broadcast system by using **Channel List** at the bottom of the Home Menu.



Movies

You can watch movies from online movie service providers, connected USB devices, or your home network.



Album

You can view photos from online service providers, connected USB devices, or your home network.



Music

You can play back music content from online music service providers, connected USB devices, or your home network.









Apps

You can launch applications. Thumbnails of featured applications (**Featured**) and your favorite applications (**My Apps**) are displayed. To view all applications, select **All Apps** at the bottom of the Home Menu.

Selecting a Tool

The tools are available depending on your TV model/region/country.

 Search	You can input a keyword to search for content. You can also select keywords searched in the past.
 Inputs	You can select an input device connected to the TV.
 Media Server	You can select a media server (e.g. USB flash drive, home network) to browse its content using the Media Browser.
 Settings	You can change TV settings (e.g. Picture & Display, Sound, Channel).
 Help	You can view information about self diagnostics and customer support. You can also access the i-Manual.
 Network Status	You can view the network connection status.

US

Looking for instructions in the electronic manual (i-Manual)

Operating instructions are built into your BRAVIA TV and can be displayed on the screen.

To learn more about your TV features, access your i-Manual with the remote control.

1 Press HOME.

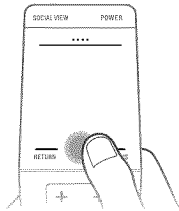

2 Slide to select ? Help, then press the touchpad.



3 Slide up/down to select i-Manual, then press the touchpad.

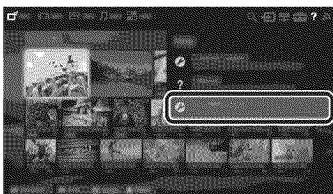

4 Select an item.

1 Slide left/right to select an item.

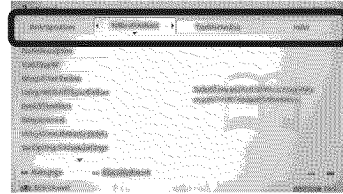

2 Slide up/down/left/right to select an item, then press the touchpad.

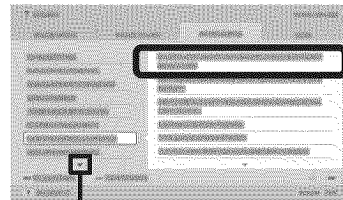

Arrow mark*

* If an arrow mark appears, slide down repeatedly to display more items.

The page of the selected item appears.

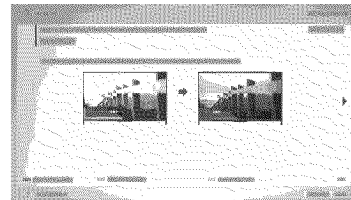

- You can step through pages by sliding left/right. Press **RETURN** to return to the previous page.



When using IR Remote Control

- 1 Press **i-MANUAL**.
- 2 Press **↑/↓/←/→** to select an item. To display the page of the selected item, press **+**. You can step through pages using **←/→**.

Saving frequently viewed pages (Bookmark)

You can save frequently viewed pages for easy access anytime.

■ To save a page

When displaying the page to bookmark, press the Control Bar (...). Slide to select the red button, then press the touchpad.

US

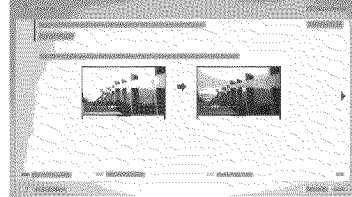

■ To access the bookmarked page

When displaying the i-Manual, press the Control Bar (...). Slide to select the blue button, then press the touchpad to display the bookmark list. Slide up/down to select the desired item, then press the touchpad.

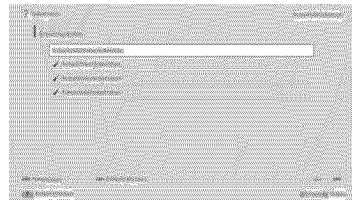

- To return to the previous screen, press **RETURN**.

■ To remove a bookmark

When the bookmarked page is displayed, press the Control Bar (...). Slide to select red button, then press the touchpad.



When using IR Remote Control

When displaying the page to bookmark, press the red button to save the desired page.

When displaying the i-Manual, press the blue button to display the bookmark list. Press **▲/▼** to select the desired item, then press **⊕**.

When the bookmarked page is displayed, press the red button to remove the bookmark.

Troubleshooting

When the illumination LED is flashing red, count how many times it flashes (interval time is three seconds).

If the illumination LED flashes red, reset the TV by disconnecting the AC power cord from the TV for two minutes, then turn on the TV.

If the problem persists, contact Sony Customer Support (information provided on the front cover) with the number of times the illumination LED flashes red (interval time is three seconds). Press **I/⏻** on the TV to turn it off, disconnect the AC power cord, and contact Sony Customer Support.

When the illumination LED is not flashing, check the items as follows.

You can also refer to “Troubleshooting” in the i-Manual or perform self-diagnosis by selecting **? Help** → **Customer Support** → **Self Diagnostics**. If the problem persists, contact Sony Customer Support (information provided on the front cover).

Condition	Explanation/Solution
There is no picture (screen is dark) and no sound.	<ul style="list-style-type: none">• Check the cable/antenna connection.• Connect the TV to AC power, and press I/⏻ on the TV or POWER on the remote control.
Some programs cannot be tuned.	<ul style="list-style-type: none">• Check the antenna.
The remote control does not function.	<ul style="list-style-type: none">• Replace the batteries.• Your TV may be in SYNC mode. Press SYNC MENU, select TV Control and then select Home (Menu) or Options to control the TV.
The Parental Lock password has been forgotten.	<ul style="list-style-type: none">• Enter 4357 for the PIN code. (PIN code 4357 is always accepted.)
The TV and its surroundings become warm.	<ul style="list-style-type: none">• When the TV is used for an extended period of time, the TV and its surroundings may become warm to the touch. This is not a malfunction of the TV.
How to reset the TV to factory settings	<ul style="list-style-type: none">• Turn on the TV. While holding down ▲ on the remote control, press I/⏻ on the TV. (The TV will turn itself off, then back on again.) Release ▲. WARNING: The reset will clear all of your customized settings including the Parental Lock setting.• For security purposes, be sure to remove all personal and account information before discarding, selling or passing your TV to someone else by: unlinking/unregistering, signing out of and deactivating all network services as well as factory reset the TV.

Condition	Explanation/Solution
-----------	----------------------

Frozen audio or video, a blank screen, or the TV does not respond to TV or remote control buttons.

- Perform a simple reset of the TV by unplugging the AC power cord for two minutes, then plug it in again.

The **I/⏻**, **CH+/-**, **⏪ +/-**, **⏩ +/-**, **⏮**, **⏭** and **HOME** buttons cannot be located on the TV.

- See below illustration for location of the buttons on the TV.

Rear of TV

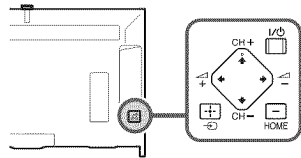

How to care for your BRAVIA TV

Safety is very important. Please read and follow the safety documentation (Safety Booklet) separately provided.

Unplug the TV and other connected equipment from the wall outlet before you begin cleaning your TV.





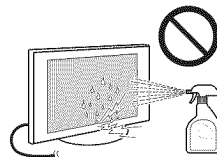



- Wipe the LCD screen gently with a soft cloth.
- Stubborn stains may be removed with a cloth slightly moistened with a solution of mild soap and warm water.
- If using a chemically pretreated cloth, please follow the instruction provided on the package.
- Never spray water or detergent directly on the TV set. It may drip to the bottom of the screen or exterior parts and enter the TV set, and may cause damage to the TV set.
- Never use strong solvents such as a thinner, alcohol or benzine for cleaning.
- Do not plug in the TV into the wall outlet until the moisture from cleaning has evaporated.

The TV should also be placed on a stable surface to prevent it from toppling over (see page 18). If you have young children or pets at home, check regularly to ensure the TV is securely fastened.



US

Specifications

System	
Television system	NTSC: American TV standard ATSC (8VSB terrestrial): ATSC compliant 8VSB QAM on cable: ANSI/SCTE 07 2000 (Does not include CableCARD functionality)
Channel coverage	Analog terrestrial: 2 - 69 / Digital terrestrial: 2 - 69 Analog Cable: 1 - 135 / Digital Cable: 1 - 135
Panel system	LCD (Liquid Crystal Display) Panel, LED Backlight
Speaker output	10 W + 10 W
Wireless technology	Protocol IEEE802.11a/b/g/n
Input/Output jacks	
CABLE/ANTENNA	75-ohm external terminal for RF inputs
 VIDEO IN 1	Video / Audio input (phono jacks)
 COMPONENT IN	YPbPr (Component Video): 1080p (60 Hz), 1080i (60 Hz), 720p (60 Hz), 480p, 480i Audio input (phono jacks)
 VIDEO IN 2	Video input (common phono pin with Y input)
HDMI IN 1/2/3/4	Video (2D): 1080p (30, 60 Hz), 1080/24p, 1080i (60 Hz), 720p (30, 60 Hz), 720/24p, 480p, 480i, PC Formats Video (3D): Frame Packing 1080p (30 Hz), 1080/24p, 1080i (60 Hz), 720p (30, 60 Hz), 720/24p Side-by-Side 1080p (60 Hz), 1080/24p, 1080i (60 Hz), 720p (60 Hz) Over-Under 1080p (30, 60 Hz), 1080/24p, 1080i (60 Hz), 720p (60 Hz) Audio: 5.1 channel linear PCM: 32, 44.1 and 48 kHz, 16, 20 and 24 bits, Dolby Digital ARC (Audio Return Channel) (HDMI IN 2 only)
MHL (common with HDMI IN 1)	Video (2D): 1080p (30 Hz), 1080/24p, 1080i (60 Hz), 720p (30, 60 Hz), 720/24p, 480p, 480i Video (3D): Side-by-Side 1080/24p, 1080i (60 Hz), 720p (60 Hz) Over-Under 1080p (30 Hz), 1080/24p, 1080i (60 Hz), 720p (60 Hz) Audio: 5.1 channel linear PCM: 32, 44.1 and 48 kHz, 16, 20 and 24 bits, Dolby Digital
 AUDIO OUT/ 	Audio output (stereo mini jack) Headphone jack (supports Subwoofer out)
 DIGITAL AUDIO OUT (OPTICAL)	Digital optical jack (Two channel linear PCM, Dolby Digital)
 LAN	10BASE-T/100BASE-TX connector (Connection speed may differ depending on the network environment. 10BASE-T/100BASE-TX communication rate and communication quality are not guaranteed for this TV.)
USB/DLNA	Refer to the i-Manual for supported formats.
REMOTE	RS232C, Serial Control mini jack; IR IN mini jack. These jacks are for receiving the external control signal.
Others	
Supplied accessories	See page 8 (Checking the accessories).
Optional accessories	Wireless Subwoofer: SWF-BR100 MHL Cable: DLC-MB10/DLC-MB20/DLC-MC20 Passive 3D Glasses: TDG-500P SimulView™ Passive Glasses: TDG-SV5P  
Operating temperature	32 °F – 104 °F (0 °C – 40 °C)

Model name KDL-		55W950B
Power and others		
Power requirement		110-240 V AC, 50/60 Hz (U.S.A./Canada 120 V AC, 60 Hz)
Power consumption	in use	134 W
	in standby	Less than 0.2 W with 120 V AC and less than 0.3 W with 240 V AC
Screen size* (inches measured diagonally)		54.6 inches (55 class)
Display resolution		1,920 dots (horizontal) × 1,080 lines (vertical)
Dimensions*	with stand (mm) (inches)	1239 × 791 × 251 48 ⁷ / ₈ × 31 ¹ / ₄ × 10
	without stand (mm) (inches)	1239 × 753 × 92 48 ⁷ / ₈ × 29 ³ / ₄ × 3 ⁵ / ₆
	wall-mount hole pattern (mm)	300 × 300
	wall-mount screw size (mm)	M6 (length: see diagram on page 38.)
Mass*	with stand (kg)/(lb.)	20.2 / 44.5
	without stand (kg)/(lb.)	19.5 / 43

* Screen size, dimensions and mass are approximate values.

- Optional accessories availability depends on countries/region/TV model/stock.
- Design and specifications are subject to change without notice.
- This TV set incorporates MHL 2.

Installing the TV to the Wall

This TV's instruction manual only shows the steps on preparing the installation of the TV before installing to the wall.

Your TV can be mounted on a wall using a Wall-Mount Bracket (not supplied) out of the box as packaged. If the Table-Top Stand is attached to the TV, the TV may require detaching the Table-Top Stand; see page 11 (Detaching the Table-Top Stand from the TV). Prepare the TV for the Wall-Mount Bracket before making cable connections.

Sony does not supply the Wall-Mount Bracket or the installation service. For product protection and safety reasons, Sony strongly recommends that installation of your TV on the wall be performed by qualified professionals. Do not attempt to install it yourself.

- Follow the instruction guide provided with the Wall-Mount Bracket for your model. Sufficient expertise is required in installing this TV, especially to determine the strength of the wall for withstanding the TV's weight.
- The length of the screw for Wall-Mount Bracket differs depending on the Wall-Mount Bracket thickness. Please see below illustration.

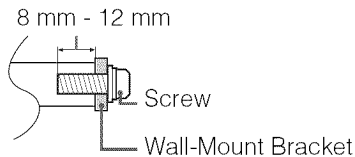

- Be sure to store the unused screws and Table-Top Stand in a safe place until you are ready to attach the Table-Top Stand. Keep the screws away from small children.



- Read the supplied Safety Booklet for additional safety information.

1 Remove the screws from the rear of the TV.

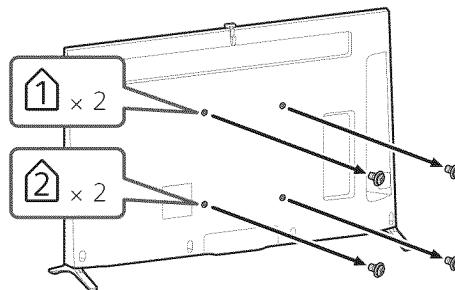

- 2** Before installing the Wall-Mount Bracket, attach the Wall-Mount Attachment (supplied with the TV) to the rear of the TV (to make it parallel with the wall). You do not need to perform this step for Super Slim mounting.

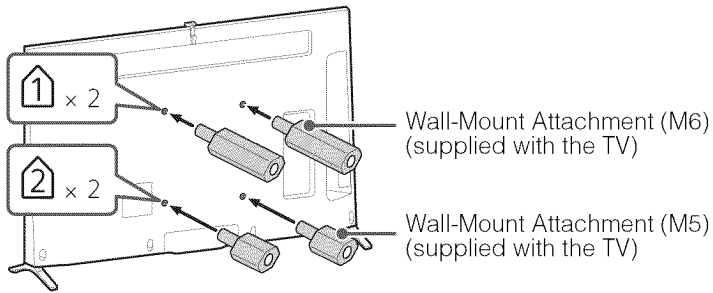

Standard mounting



Super Slim mounting*

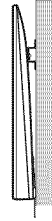

US

- * You cannot use some of the terminals on the rear of the TV when using Super Slim mounting style.

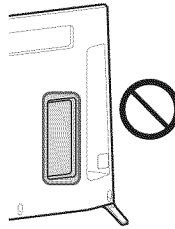

- If using an electric screwdriver, set the torque at approximately 1.5 N·m {15 kgf·cm}.

Installing the TV against a wall or enclosed area

Make sure that your TV has adequate ventilation. Allow enough space around the TV as shown in the illustration.

Installed with stand

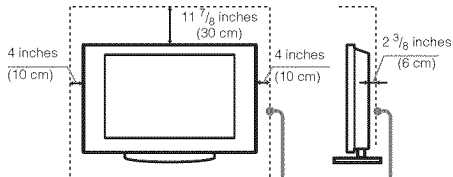

Installed on the wall

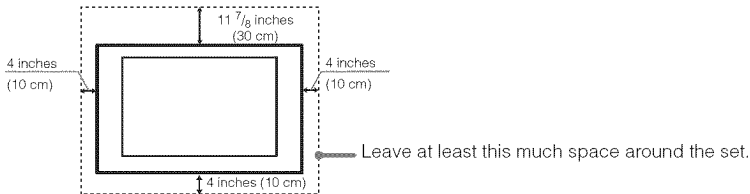

Never install the TV set as follows:

Air circulation is blocked. Air circulation is blocked.

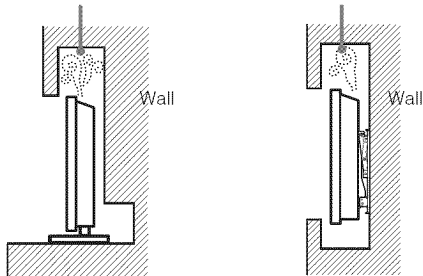

- Inadequate ventilation can lead to overheating of the TV and may cause damage to your TV or cause a fire.

Safety Information

Declaration of Conformity

Trade Name: SONY
Model: KDL-55W950B
Responsible Party: Sony Electronics Inc.
Address: 16530 Via Esprillo,
San Diego, CA 92127 U.S.A.
Telephone Number: 858-942-2230

This device complies with part 15 of the FCC rules. Operation is subject to the following two conditions:

(1) This device may not cause harmful interference, and (2) this device must accept any interference received, including interference that may cause undesired operation.

FCC Related Information

This equipment has been tested and found to comply with the limits for a Class B digital device, pursuant to Part 15 of the FCC Rules. These limits are designed to provide reasonable protection against harmful interference in a residential installation. This equipment generates, uses and can radiate radio frequency energy and, if not installed and used in accordance with the instructions, may cause harmful interference to radio communications. However, there is no guarantee that interference will not occur in a particular installation. If this equipment does cause harmful interference to radio or television reception, which can be determined by turning the equipment off and on, the user is encouraged to try to correct the interference by one or more of the following measures:

- Reorient or relocate the receiving antenna.
- Increase the separation between the equipment and receiver.
- Connect the equipment into an outlet on a circuit different from that to which the receiver is connected.
- Consult the dealer or an experienced radio/TV technician for help.

Pursuant to FCC regulations, you are cautioned that any changes or modifications not expressly approved in this manual could void your authority to operate this equipment.

Safety and Regulatory

To prevent radio interference to the licensed service, this device is intended to be operated indoors and away from windows to provide maximum shielding. Equipment (or its transmit antenna) that is installed outdoors is subject to licensing.

Only use Wireless LAN indoors when using it with IEEE 802.11a (5 GHz).

This equipment complies with FCC/IC radiation exposure limits set forth for uncontrolled equipment and meets the FCC radio frequency (RF) Exposure Guidelines in Supplement C to OET65 and RSS-102 of the IC radio frequency (RF) Exposure rules. This equipment has very low levels of RF energy that it deemed to comply without maximum permissive exposure evaluation (MPE). But it is desirable that it should be installed and operated with at least 20 cm and more between the radiator and person's body (excluding extremities: hands, wrists, feet and ankles).

This device and its antenna(s) must not be co-located or operating with any other antenna or transmitter except Grant condition.

Note

This television includes a QAM demodulator which should allow you to receive unscrambled digital cable television programming via subscription service to a cable service provider. Availability of digital cable television programming in your area depends on the type of programming and signal provided by your cable service provider.

US

For Your Convenience

Online Registration:

Be sure to register your TV.

United States <http://productregistration.sony.com>

Canada <http://www.sony.ca/registration>

Software Updates:

Your TV is capable of receiving software updates. For the latest information about software updates for your TV, visit:

United States <http://www.sony.com/tvsupport>

Canada <http://www.sony.ca/support>

NOTE: If your TV is connected to the Internet, you can check for software updates by selecting **? Help**,  **Customer Support** and then **Software Update**.