

OPERATOR'S MANUAL

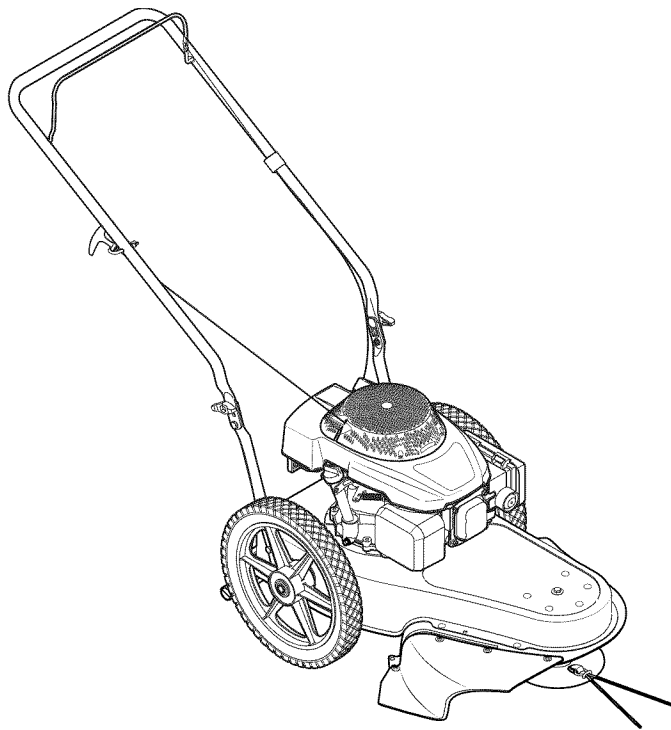

22-inch String Trimmer — Model Series 260

▲ WARNING

**READ AND FOLLOW ALL SAFETY RULES AND INSTRUCTIONS IN THIS MANUAL
BEFORE ATTEMPTING TO OPERATE THIS MACHINE.
FAILURE TO COMPLY WITH THESE INSTRUCTIONS MAY RESULT IN PERSONAL INJURY.**

MTD LLC, P.O. BOX 361131 CLEVELAND, OHIO 44136-0019

Thank You

Thank you for purchasing an MTD String Trimmer. It was carefully engineered to provide excellent performance when properly operated and maintained.

Please read this entire manual prior to operating the equipment. It instructs you how to safely and easily set up, operate and maintain your machine. Please be sure that you, and any other persons who will operate the machine, carefully follow the recommended safety practices at all times. Failure to do so could result in personal injury or property damage.

All information in this manual is relative to the most recent product information available at the time of printing. Review this manual frequently to familiarize yourself with the machine, its features and operation. Please be aware that this Operator's Manual may cover a range of product specifications for various models. Characteristics and features discussed and/or illustrated in this manual may not be applicable to all models.

We reserve the right to change product specifications, designs and equipment without notice and without incurring obligation.

If applicable, the power testing information used to establish the power rating of the engine equipped on this machine can be found at www.opei.org or the engine manufacturer's web site.

If you have any problems or questions concerning the machine, phone your local authorized MTD service dealer or contact us directly. MTD's Customer Support telephone numbers, website address and mailing address can be found on this page. We want to ensure your complete satisfaction at all times.

Throughout this manual, all references to *right* and *left* side of the machine are observed from the operating position

Table of Contents

<i>Important Safe Operation Practices</i>	3	<i>Maintenance & Adjustments</i>	13
<i>Assembly & Set-Up</i>	9	<i>Troubleshooting</i>	14
<i>Controls & Features</i>	11	<i>Replacement Parts</i>	15
<i>Operation</i>	12	<i>Warranty</i>	Back Cover

Record Product Information

Before setting up and operating your new equipment, please locate the model plate on the equipment and record the information in the provided area to the right. You can locate the model plate by standing at the operator's position and looking down at the rear of the deck. This information will be necessary, should you seek technical support via our web site, Customer Support Department, or with a local authorized service dealer.

MODEL NUMBER

--	--	--	--	--	--	--	--	--	--	--

SERIAL NUMBER

--	--	--	--	--	--	--	--	--	--	--

Customer Support

Please do NOT return the machine to the retailer or dealer without first contacting the Customer Support Department.

If you have difficulty assembling this product or have any questions regarding the controls, operation, or maintenance of this machine, you can seek help from the experts. Choose from the options below:

- ◇ Visit us on the web at www.mtdproducts.com



See How-to Maintenance and Parts Installation Videos at www.mtdparts.com/KnowledgeCenter

- ◇ Call a Customer Support Representative at (800) 800-7310 or (330) 220-4683
- ◇ Write to MTD LLC • P.O. Box 361131 • Cleveland, OH • 44136-0019



WARNING: This symbol points out important safety instructions which, if not followed, could endanger the personal safety and/or property of yourself and others. Read and follow all instructions in this manual before attempting to operate this machine. Failure to comply with these instructions may result in personal injury.

When you see this symbol. **HEED ITS WARNING!**

CALIFORNIA PROPOSITION 65



WARNING: Engine Exhaust, some of its constituents, and certain vehicle components contain or emit chemicals known to State of California to cause cancer and birth defects or other reproductive harm.



WARNING: Battery posts, terminals, and related accessories contain lead and lead compounds, chemicals known to the State of California to cause cancer and reproductive harm. *Wash hands after handling.*



DANGER: This machine was built to be operated according to the safe operation practices in this manual. As with any type of power equipment, carelessness or error on the part of the operator can result in serious injury. This machine is capable of amputating fingers, hands, toes and feet and throwing objects. Failure to observe the following safety instructions could result in serious injury or death.

General Operation

1. Read this operator's manual carefully in its entirety before attempting to assemble this machine. Read, understand, and follow all instructions on the machine and in the manual(s) before operation. Keep this manual in a safe place for future and regular reference and for ordering replacement parts.
2. Be completely familiar with the controls and the proper use of this machine before operating it.
3. This machine is a precision piece of power equipment, not a plaything. Therefore, exercise extreme caution at all times. This machine has been designed to perform one job: to cut vegetation and grass. Do not use it for any other purpose.
4. Never allow children under 14 years of age to operate this machine. Children 14 and over should read and understand the instructions and safe operation practices in this manual and on the machine and should be trained and supervised by an adult.
5. Only responsible individuals who are familiar with these rules of safe operation should be allowed to use this machine.
6. Thoroughly inspect the area where the equipment is to be used. Remove all stones, sticks, wire, bones, toys and other foreign objects, which could be tripped over or picked up and thrown by the string trimmer. Thrown objects can cause serious personal injury.
7. Plan your trimming pattern to avoid discharge of material toward roads, sidewalks, bystanders and the like. Also, avoid discharging material against a wall or obstruction, which may cause discharged material to ricochet back toward the operator.
8. To help avoid trimmer line contact or a thrown object injury, stay in operator zone behind handles and keep children, bystanders, helpers and pets at least 75 feet from string trimmer while it is in operation. Stop machine if anyone enters area.
9. Always wear safety glasses or safety goggles during operation and while performing an adjustment or repair to protect your eyes. Thrown objects which ricochet can cause serious injury to the eyes.
10. Wear sturdy, rough-soled work shoes and close-fitting slacks and shirts. Shirts and pants that cover the arms and legs and steel-toed shoes are recommended. Never operate this machine in bare feet, sandals, slippery or light-weight (e.g. canvas) shoes.

11. Do not put hands or feet near or under rotating parts. Keep clear of discharge area at all times as the rotating spindle and trimmer lines can cause injury.
12. Never operate the string trimmer without proper shields, guards, control lever or other safety protective devices in place and working.
13. Never operate the string trimmer with damaged safety devices. Failure to do so, can result in personal injury.
14. Many injuries occur as a result of the string trimmer being pulled over the foot during a fall caused by slipping or tripping. Do not hold on to the string trimmer if you are falling; release the handle immediately.
15. Never pull the string trimmer back toward you while you are walking. If you must back the string trimmer away from a wall or obstruction first look down and behind to avoid tripping and then follow these steps:
 - a. Step back from string trimmer to fully extend your arms.
 - b. Be sure you are well balanced with sure footing.
 - c. Pull the string trimmer back slowly, no more than half way toward you.
 - d. Repeat these steps as needed.
16. Do not operate the string trimmer while under the influence of alcohol or drugs.
17. Do not engage the self-propelled mechanism on machines so equipped while starting engine.
18. The control lever is a safety device. Never attempt to bypass its operation. Doing so makes the safety device inoperative and may result in personal injury through contact with the rotating trimmer line. The control lever must operate easily in both directions and automatically return to the disengaged position when released.
19. Never operate the string trimmer in wet grass. Always be sure of your footing. A slip and fall can cause serious personal injury. If you feel you are losing your footing, release the control lever immediately and the spindle will stop rotating within three seconds.
20. Operate only in daylight or good artificial light. Walk, never run.
21. Stop the spindle when crossing gravel drives, walks or roads.
22. If the equipment should start to vibrate abnormally, stop the engine and check immediately for the cause. Vibration is generally a warning of trouble.
23. Shut the engine off and wait until the spindle comes to a complete stop before cleaning the discharge area. The spindle continues to rotate for a few seconds after the control lever is released. Never place any part of the body in the trimmer line area until you are sure the spindle has stopped rotating.
24. Never operate string trimmer without proper trail shield, discharge cover, control lever or other safety protective devices in place and working. Never operate string trimmer with damaged safety devices. Failure to do so can result in personal injury.
25. Muffler and engine become hot and can cause a burn. Do not touch.
26. Only use parts and accessories made for this machine by the manufacturer. Failure to do so can result in personal injury.
27. When starting engine, pull cord slowly until resistance is felt, then pull rapidly. Rapid retraction of starter cord (kickback) will pull hand and arm toward engine faster than you can let go. Broken bones, fractures, bruises or sprains could result.
28. If situations occur which are not covered in this manual, use care and good judgement. Contact Customer Support for assistance or the name of the nearest service dealer.

Slope Operation

Slopes are a major factor related to slip and fall accidents, which can result in severe injury. Operation on slopes requires extra caution. If you feel uneasy on a slope, do not trim on it. For your safety, use the slope gauge included as part of this manual to measure slopes before operating this machine on a sloped or hilly area. If the slope is greater than 15 degrees, do not trim on it.

Do:

1. Trim across the face of slopes; never up and down. Exercise extreme caution when changing direction on slopes.
2. Watch for holes, ruts, rocks, hidden objects, or bumps which can cause you to slip or trip. Tall grass can hide obstacles.
3. Always be sure of your footing. A slip and fall can cause serious personal injury. If you feel you are losing your balance, release the control lever immediately and the spindle will stop rotating within three (3) seconds.

Do Not:

1. Do not trim near drop-offs, ditches or embankments, you could lose your footing or balance.
2. Do not trim slopes greater than 15 degrees as shown on the slope gauge.
3. Do not trim on wet grass. Unstable footing could cause slipping.

Children

Tragic accidents can occur if the operator is not alert to the presence of children. Children are often attracted to the string trimmer and the trimming activity. They do not understand the dangers. Never assume that children will remain where you last saw them.

1. Keep children out of the trimming area and under watchful care of a responsible adult other than the operator.
2. Be alert and turn string trimmer off if a child enters the area.
3. Before and while moving backwards, look behind and down for small children.

4. Use extreme care when approaching blind corners, doorways, shrubs, trees, or other objects that may obscure your vision of a child who may run into the string trimmer.
5. Keep children away from hot or running engines. They can suffer burns from a hot muffler.
6. Never allow children under 14 years of age to operate this machine. Children 14 and over should read and understand the instructions and safe operation practices in this manual and on the machine and be trained and supervised by an adult.

Service

Safe Handling Of Gasoline:

1. To avoid personal injury or property damage use extreme care in handling gasoline. Gasoline is extremely flammable and the vapors are explosive. Serious personal injury can occur when gasoline is spilled on yourself or your clothes, which can ignite. Wash your skin and change clothes immediately.
2. Use only an approved gasoline container.
3. Never fill containers inside a vehicle or on a truck or trailer bed with a plastic liner. Always place containers on the ground away from your vehicle before filling.
4. Remove gas-powered equipment from the truck or trailer and refuel it on the ground. If this is not possible, then refuel such equipment on a trailer with a portable container, rather than from a gasoline dispenser nozzle.
5. Keep the nozzle in contact with the rim of the fuel tank or container opening at all times until fueling is complete. Do not use a nozzle lock-open device.
6. Extinguish all cigarettes, cigars, pipes and other sources of ignition.
7. Never fuel machine indoors because flammable vapors will accumulate in the area.
8. Never remove gas cap or add fuel while engine is hot or running. Allow engine to cool at least two minutes before refueling.
9. Never over fill fuel tank. Fill tank to no more than 1 inch below bottom of filler neck to provide for fuel expansion.
10. Replace gasoline cap and tighten securely.
11. If gasoline is spilled, wipe it off the engine and equipment. Move machine to another area. Wait 5 minutes before starting engine.
12. Never store the machine or fuel container near an open flame, spark or pilot light as on a water heater, space heater, furnace, clothes dryer or other gas appliances.
13. To reduce fire hazard, keep machine free of grass, leaves, or other debris build-up. Clean up oil or fuel spillage and remove any fuel soaked debris.
14. Allow machine to cool at least 5 minutes before storing.
2. Before cleaning, repairing, or inspecting, make certain the spindle and all moving parts have stopped. Disconnect the spark plug wire and ground against the engine to prevent unintended starting.
3. Check the spindle and engine mounting bolts at frequent intervals for proper tightness. Also, visually inspect spindle for damage. Replace with the original equipment manufacture's (O.E.M.) parts only, listed in this manual. "Use of parts which do not meet the original equipment specifications may lead to improper performance and compromise safety!"
4. Keep all nuts, bolts, and screws tight to be sure the equipment is in safe working condition.
5. Never tamper with safety devices. Check their proper operation regularly.
6. After striking a foreign object, stop the engine, disconnect the spark plug wire and ground against the engine. Thoroughly inspect the string trimmer for any damage. Repair the damage before starting and operating the string trimmer.
7. Trimmer components, guards and shields are subject to wear and damage which could expose moving parts or allow objects to be thrown. For safety protection, frequently check components and replace immediately with original equipment manufacturer's (O.E.M.) parts only, listed in this manual. "Use of parts which do not meet the original equipment specifications may lead to improper performance and compromise safety!"
8. Do not change the engine's governor setting or over-speed the engine. The governor controls the maximum safe operating speed of the engine.
9. Check fuel line, tank, cap, and fittings frequently for cracks or leaks. Replace if necessary.
10. Do not crank engine with spark plug removed.
11. Maintain or replace safety and instruction labels, as necessary.
12. Observe proper disposal laws and regulations. Improper disposal of fluids and materials can harm the environment.
13. According to the Consumer Products Safety Commission (CPSC) and the U.S. Environmental Protection Agency (EPA), this product has an *Average Useful Life* of seven (7) years, or 140 hours of operation. At the end of the *Average Useful Life* have the machine inspected annually by an authorized service dealer to ensure that all mechanical and safety systems are working properly and not worn excessively. Failure to do so can result in accidents, injuries or death.

Do not modify engine

To avoid serious injury or death, do not modify engine in any way. Tampering with the governor setting can lead to a runaway engine and cause it to operate at unsafe speeds. Never tamper with factory setting of engine governor.

General Service:

1. Never run an engine indoors or in a poorly ventilated area. Engine exhaust contains carbon monoxide, an odorless and deadly gas.

Notice Regarding Emissions

Engines which are certified to comply with California and federal EPA emission regulations for SORE (Small Off Road Equipment) are certified to operate on regular unleaded gasoline, and may include the following emission control systems: Engine Modification (EM), Oxidizing Catalyst (OC), Secondary Air Injection (SAI) and Three Way Catalyst (TWC) if so equipped.

Spark Arrestor









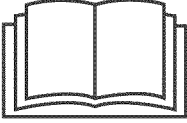

WARNING: This machine is equipped with an internal combustion engine and should not be used on or near any unimproved forest-covered, brush covered or grass-covered land unless the engine's exhaust system is equipped with a spark arrestor meeting applicable local or state laws (if any).

If a spark arrestor is used, it should be maintained in effective working order by the operator. In the State of California the above is required by law (Section 4442 of the California Public Resources Code). Other states may have similar laws. Federal laws apply on federal lands.

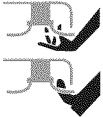
A spark arrestor for the muffler is available through your nearest engine authorized service dealer or contact the service department, P.O. Box 361131 Cleveland, Ohio 44136-0019.

Safety Symbols

This page depicts and describes safety symbols that may appear on this product. Read, understand, and follow all instructions on the machine before attempting to assemble and operate.

Symbol	Description
	READ THE OPERATOR'S MANUAL(S) Read, understand, and follow all instructions in the manual(s) before attempting to assemble and operate.
	EYE PROTECTION Always wear safety glasses or safety goggles when operating this machine.
	DANGER — BYSTANDERS Do not trim when children or others are around.
	DANGER — HAND/ FOOT CUT Keep hands and feet away from rotating parts.
	DANGER — THROWN DEBRIS Remove objects that can be thrown by the machine in any direction. Wear safety glasses.
	DANGER — SLOPES Use extra caution on slopes. Do not trim on slopes greater than 15°.
	WARNING—GASOLINE IS FLAMMABLE Allow the engine to cool at least two minutes before refueling.
	WARNING— CARBON MONOXIDE Never run an engine indoors or in a poorly ventilated area. Engine exhaust contains carbon monoxide, an odorless and deadly gas.
	WARNING— HOT SURFACE Engine parts, especially the muffler, become extremely hot during operation. Allow engine and muffler to cool before touching.



WARNING: Your Responsibility—Restrict the use of this power machine to persons who read, understand and follow the warnings and instructions in this manual and on the machine.

SAVE THESE INSTRUCTIONS!

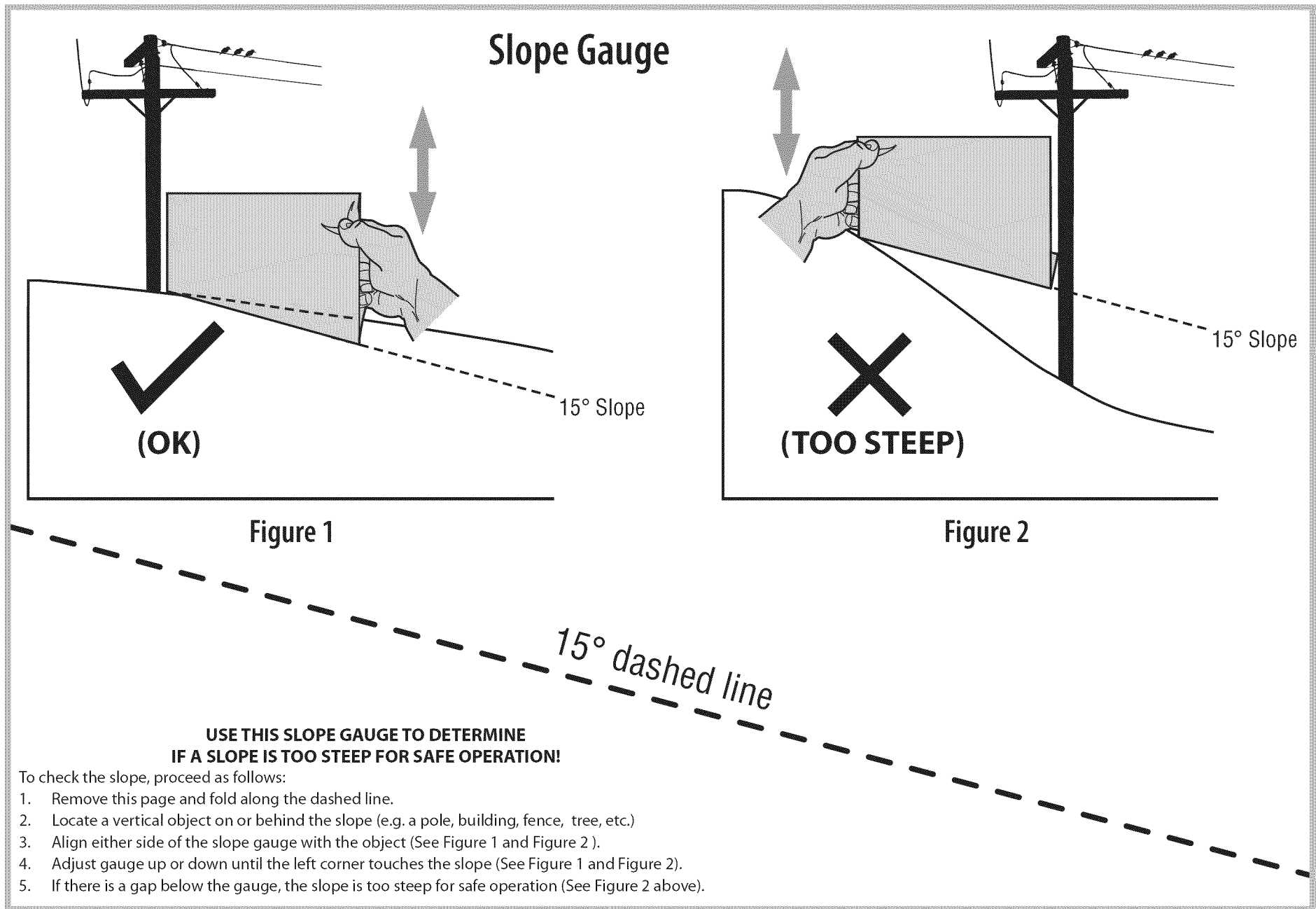

WARNING! Slopes are a major factor related to tip-over and roll-over accidents which can result in severe injury or death. Do not operate machine on slopes in excess of 15 degrees. All slopes require extra caution. Always mow across the face of slopes, never up and down slopes.

Contents of Carton

- One String Trimmer
- One String Trimmer Operator's Manual
- One Bottle of Oil
- One Engine Operator's Manual
- One Pack of Trimmer Line

Assembly

NOTE: This string trimmer is shipped without gasoline or oil in the engine. Fill up the gasoline and oil as instructed in the accompanying engine manual BEFORE operating your machine.

Upper Handle

1. Remove the wing knob and carriage bolt from the left lower handle and the right lower handle. See Figure 3-1.
2. Pivot the upper handle into the operating position. See Figure 3-1.

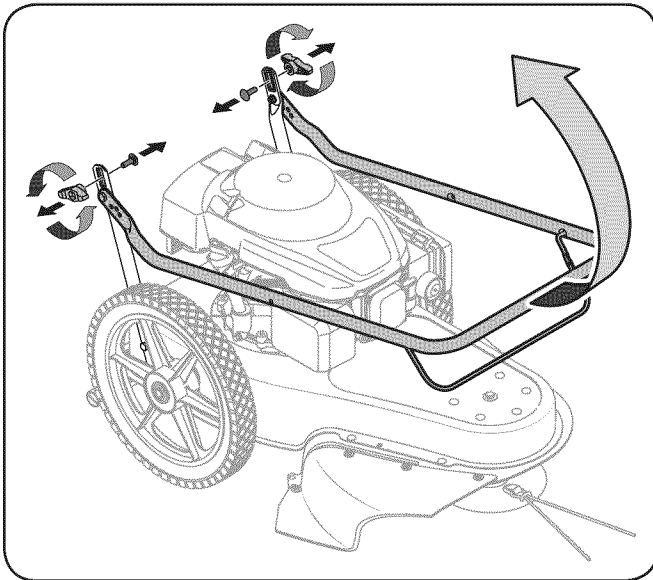

Figure 3-1

3. Move the upper handle into one of three positions by pivoting it forward or rearward. Secure the upper handle to the lower handle using the carriage bolts and wing knobs removed in Step 1. See Figure 3-2.

Note: Make sure to use the corresponding hole on the left side as on the right side of the upper handle.

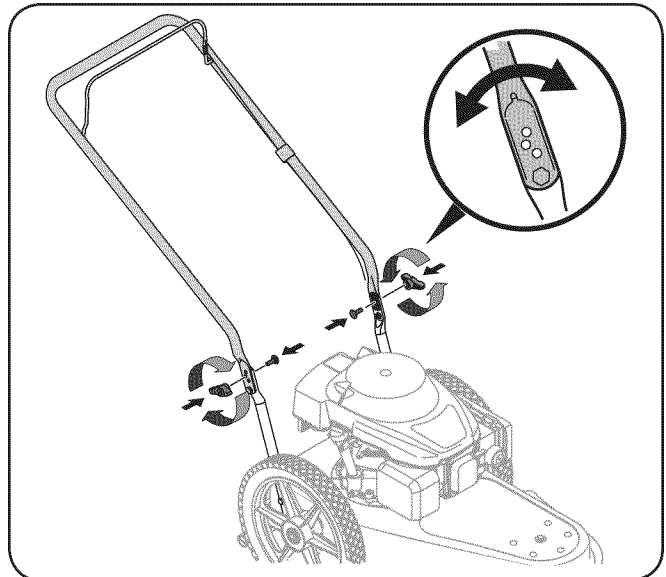

Figure 3-2

Starter Rope

1. Disconnect the spark plug boot from the spark plug (refer to the separate Engine Manual).
2. Pivot the control handle against the upper handle and pull the rope out of the engine.
3. Loop the rope through the eye bolt. See Figure 3-3.
4. Tighten the eye bolt to the handle using the lock nut. DO NOT overtighten.

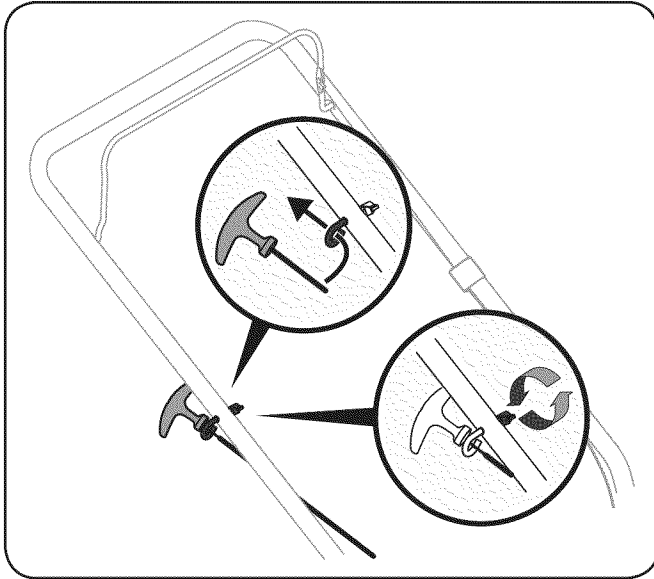

Figure 3-3

Set-Up

Gas and Oil Fill-Up

Refer to the separate engine owner's manual for additional engine information.

1. Add oil provided before starting unit for the first time out of the box.
2. Service the engine with gasoline as instructed in the separate engine owner's manual.



WARNING: Use extreme care when handling gasoline. Gasoline is extremely flammable and the vapors are explosive. Never fuel the machine indoors or while the engine is hot or running. Extinguish cigarettes, cigars, pipes and any other sources of ignition.

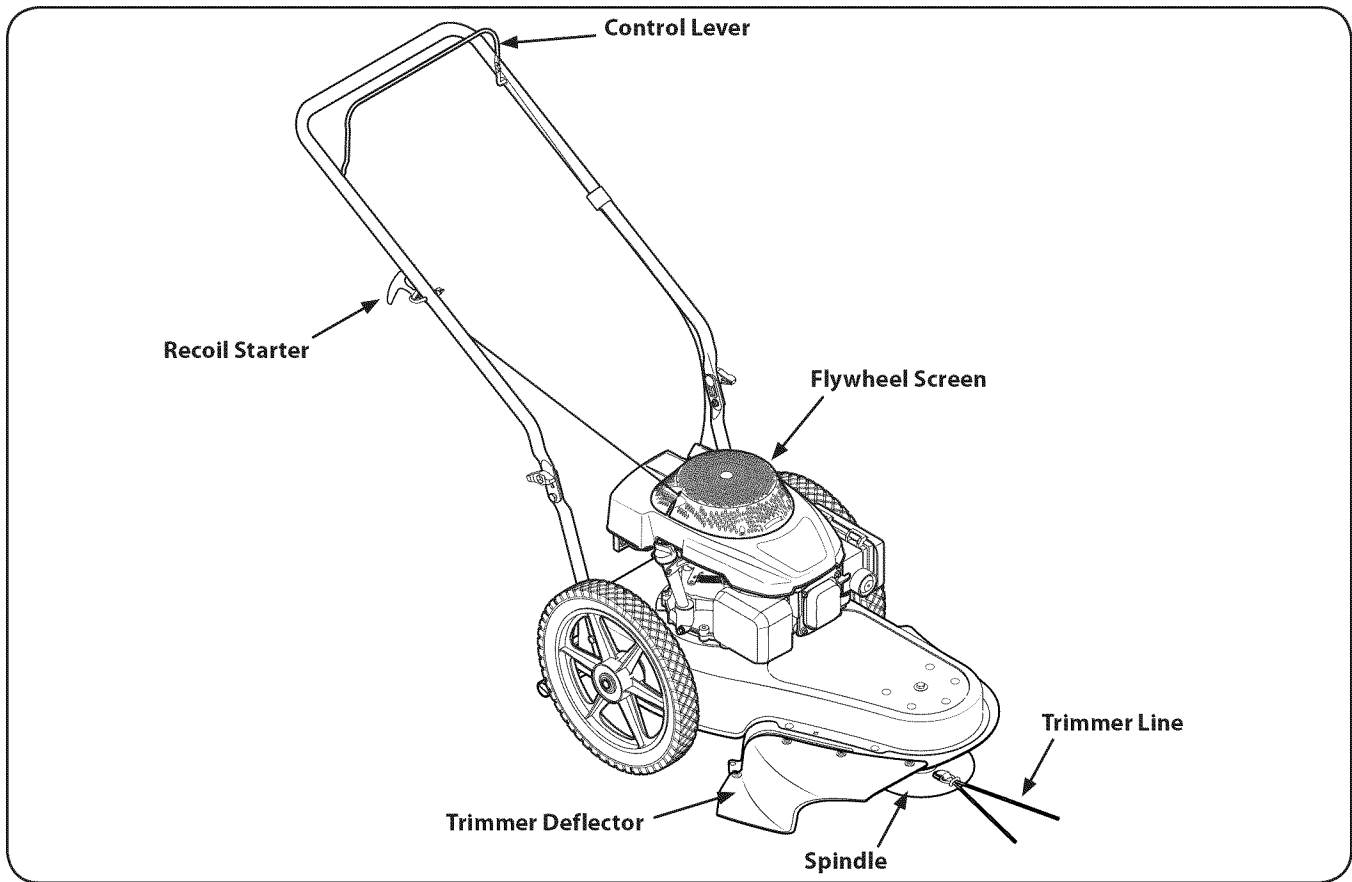

Figure 4-6

Recoil Starter

The recoil starter is attached to the right side of the upper handle. Stand behind the unit and pull the recoil starter rope to start the unit.

Trimmer Deflector

The trimmer deflector is connected to the trimmer base and it is used to prevent debris from being thrown.

Control Lever

The control lever must be depressed to start the engine and rotation of trimmer spindle assembly. Releasing the control lever stops the engine and trimmer spindle assembly.



WARNING: This control lever is a safety device. Never attempt to bypass its operations.

Spindle

The spindle rotates the trimmer line.

Trimmer Line

The trimmer line is attached to the spindle assembly and it is used to trim grass, vegetation, undergrowth and weeds.

Flywheel Screen

Keep the flywheel screen free of grass clippings and debris at all times.

Engine Controls

See the separate engine manual for the location and function of the controls on the engine.

Adjusting the Spindle Height

The spindle height can be adjusted for various applications. To do so, proceed as follows:

1. Loosen the wing nut found on each side of the spindle shaft.
Note: The wing nuts are designed so that they cannot be removed from the spindle shaft.
2. Slide the spindle upward or downward to the desired position before retightening the wing nuts. See Figure 5-1.

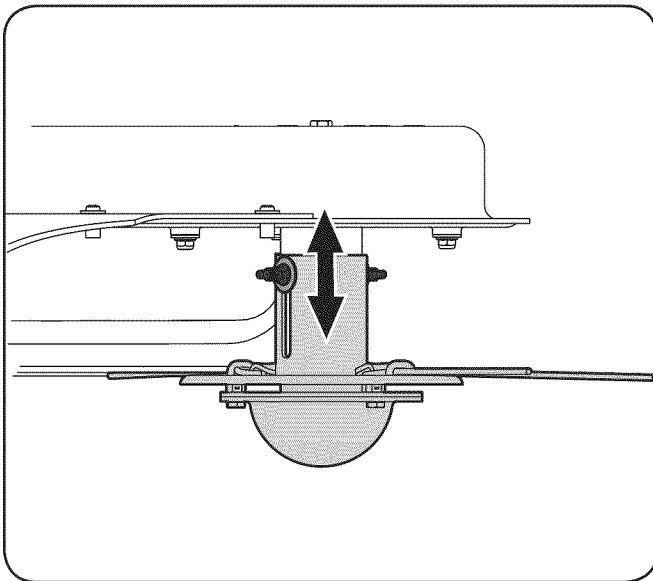

Figure 5-1

Starting and Stopping Engine

Refer to the Engine Operator's manual packed with your string trimmer for instructions on starting and stopping the engine.

Using Your String Trimmer

Be sure trimming area is clear of stones, sticks, wire, or other objects which could damage the string trimmer or engine. Such objects could be accidentally thrown by the trimmer in any direction and cause serious personal injury to the operator and others.



WARNING: The operation of any string trimmer can result in foreign objects being thrown into the eyes, which can damage your eyes severely. Always wear safety glasses while operating the string trimmer, or while performing any adjustments or repairs on it.

- The string trimmer is designed with the spindle offset to the left side, allowing the operator to trim along a fence, landscaping, or a house to his or her's right side without having to make any adjustments to the machine.

- Operate the string trimmer at a slower walking speed when trimming tall, thick weeds or grass.
- Clean the underside of the trimmer after each use to remove any debris build up.



WARNING: Shut the engine off and wait until the trimmer head comes to a complete stop before cleaning the discharge area. The trimmer head continues to rotate for a few seconds after the trimmer head control is released.

- Do not trim on excessively steep slopes. If a slope is difficult to stand on, do not trim. Do not trim on slopes when the ground is slippery or wet. Trim across the face of a slope, not up and down.

CAUTION: While operating the string trimmer, do not allow the spindle to contact a concrete, asphalt, or gravel surface. Doing so will result in premature wear.

Changing the Trimmer Line

To ease in removing worn trimmer line, change the trimmer line before it becomes too short (i.e. approximately half its original length).

1. Remove the worn trimmer line from the spindle.
2. Fold the replacement trimmer line in half and insert both ends through the loop near the edge of the spindle.
3. Pull the ends of the trimmer line through the loop until the line is securely beneath the metal tab.
4. Cross the line ends and pull each tightly to secure the trimmer line in place. See Figure 5-2.

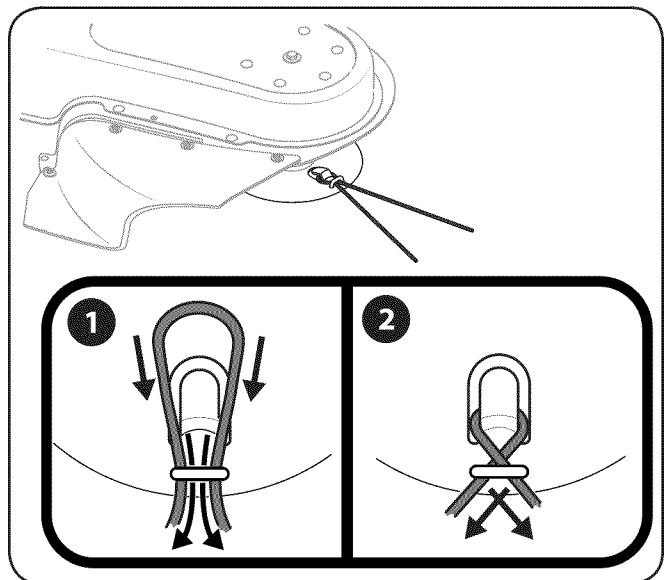

Figure 5-2

Note: Always use 490-040-M035 trimmer line. Refer to Replacement Parts on page 15 for information on ordering.

Maintenance

General Recommendations

- Always observe safety rules when performing any maintenance.
- The warranty on this string trimmer does not cover items that have been subjected to operator abuse or negligence. To receive full value from warranty, operator must maintain the string trimmer as instructed here.
- Changing of engine-governed speed will void engine warranty.
- All adjustments should be checked at least once each season.
- Periodically check all fasteners and make sure these are tight.



WARNING: Always stop engine, disconnect spark plug, and ground against engine before performing any type of maintenance on your machine.

Lubrication

1. Lubricate pivot points on the control lever at least once a season with light oil. This control must operate freely in both directions. See Figure 6-1.

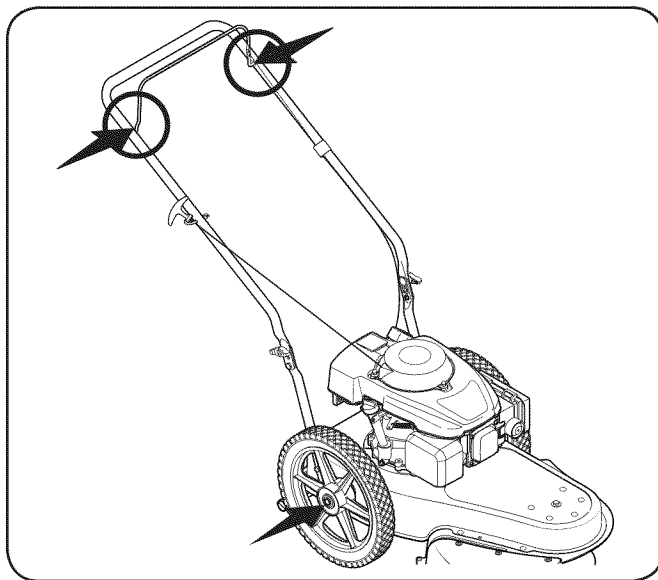

Figure 6-1

2. Lubricate the wheels at least once a season with light oil (or motor oil). If wheels are removed for any reason, lubricate surface of the axle bolt and inner surface of the wheel with light oil. See Figure 6-1.
3. Follow the accompanying engine manual for lubrication schedule and instruction for engine lubrication.

Deck Care

Clean underside of the machine after each use to prevent build-up of grass clippings or other debris. Follow steps below:

1. Disconnect spark plug wire. Drain gasoline from string trimmer or place a piece of plastic under the gas cap.
2. Tip trimmer so that it rests on its side. Keep the side with the air cleaner facing up. Hold trimmer firmly.



WARNING: Never tip the trimmer more than 90° in any direction and do not leave the trimmer tipped for any length of time. Oil can drain into the upper part of the engine causing a starting problem.

3. Scrape and clean the underside of the machine with a suitable tool. Do not spray with water.

IMPORTANT: Do not use a pressure washer or garden hose to clean the machine. These may cause damage to the engine. The use of water will result in shortened life and reduce serviceability.

4. Put the trimmer back on its wheels on the ground. If you had put plastic under the gas cap earlier, make sure to remove it now.

Engine Care

A list of key engine maintenance jobs required for good performance by the trimmer is given below. Follow the accompanying engine manual for a detailed list and instructions.





- Maintain oil level as instructed in engine manual.
- Service air cleaner every 25 hours under normal conditions. Clean every few hours under extremely dusty conditions. Poor engine performance and flooding usually indicates that the air cleaner should be serviced. To service the air cleaner, refer to the engine manual.
- Clean spark plug and reset the gap once a season. Spark plug replacement is recommended at the start of each mowing season. Check engine manual for correct plug type and gap specifications.
- Clean engine regularly with a cloth or brush. Keep the top of the engine clean to permit proper air circulation. Remove all grass, dirt and debris from muffler area.
- Engines stored between 30 and 90 days need to be treated with a gasoline stabilizer such as **STA-BIL**® to prevent deterioration and gum from forming in fuel system or on essential carburetor parts.

Off-Season Storage

Take the following steps to prepare your trimmer for storage. Refer to engine manual for specific engine storage instructions

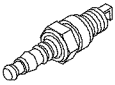
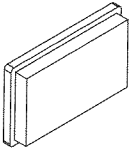
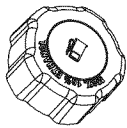
- Clean and lubricate trimmer.
- Store trimmer in a dry, clean area. Do not store next to corrosive materials, such as fertilizer.
- Using a light oil or silicone, coat the equipment, especially cables and all moving parts of your string trimmer.

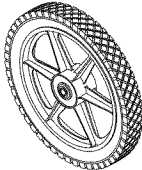
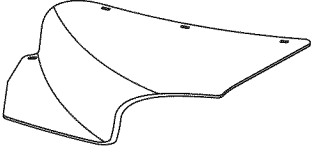
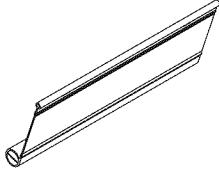
Problem	Cause	Remedy
Engine Fails to start	<ol style="list-style-type: none"> 1. Control lever disengaged. 2. Spark plug boot disconnected. 3. Fuel tank empty or stale fuel. 4. Engine not primed (if equipped with primer). 5. Faulty spark plug. 6. Blocked fuel line. 7. Engine flooded. 8. Fuel valve (if equipped) closed. 9. Engine not choked (if equipped with choke). 	<ol style="list-style-type: none"> 1. Engage control lever. 2. Connect wire to spark boot. 3. Fill tank with clean, fresh gasoline. 4. Prime engine as instructed in the Operation section. 5. Clean, adjust gap, or replace. 6. Clean fuel line. 7. Wait a few minutes to restart, but do not prime. 8. Open fuel valve. See engine manual. 9. Choke engine. See engine manual.
Engine runs erratic	<ol style="list-style-type: none"> 1. Spark plug boot loose. 2. Blocked fuel line or stale fuel. 3. Vent in gas cap plugged. 4. Water or dirt in fuel system. 5. Dirty air cleaner. 6. Unit running with CHOKE (if equipped) applied. 	<ol style="list-style-type: none"> 1. Connect and tighten spark plug boot. 2. Clean fuel line; fill tank with clean, fresh gasoline. 3. Clear vent. 4. Drain fuel tank. Refill with fresh fuel. 5. Refer to engine manual. 6. Push CHOKE knob in.
Engine overheats	<ol style="list-style-type: none"> 1. Engine oil level low. 2. Air flow restricted. 	<ol style="list-style-type: none"> 1. Fill crankcase with proper oil. 2. Clean area around and on top of engine.
Occasional skips (hesitates) at high speed	<ol style="list-style-type: none"> 1. Spark plug gap too close. 	<ol style="list-style-type: none"> 1. Adjust gap to .030".
Idles poorly	<ol style="list-style-type: none"> 1. Spark plug fouled, faulty, or gap too wide. 2. Dirty air cleaner. 	<ol style="list-style-type: none"> 1. Reset gap to .030" or replace spark plug. 2. Refer to engine manual.
Excessive Vibration	<ol style="list-style-type: none"> 1. Spindle wing nuts loose. 2. Spindle damaged. 	<ol style="list-style-type: none"> 1. Tighten wing nuts. 2. See an authorized service dealer.
Poor Trimming Performance	<ol style="list-style-type: none"> 1. Trimmer line too short or worn. 2. Worn or damaged spindle belt. 	<ol style="list-style-type: none"> 1. Replace trimmer line. 2. Replace spindle belt.

Component	Part Number and Description
	951-14437 Spark Plug
	951-10298 Air Cleaner Kit
	951-14407 Fuel Cap Assembly
	951-10358A Fuel Filter
	746-05141 Control Cable, 48"
	734-04030 Wheel
	731-2315 Deflector Flap
	731-2329 Trail Shield
	490-040-M035 .155" Trimmer Line (Ten-pack)

Phone (800) 800-7310 or (330) 220-4683 to order replacement parts or a complete Parts Manual (have your full model number and serial number ready). Parts Manual downloads are also available free of charge at www.mtdproducts.com

MANUFACTURER'S LIMITED WARRANTY FOR



The limited warranty set forth below is given by MTD LLC with respect to new merchandise purchased and used in the United States and/or its territories and possessions, and by MTD Products Limited with respect to new merchandise purchased and used in Canada and/or its territories and possessions (either entity respectively, "MTD").

This warranty is in addition to any applicable emissions warranty provided with your product.

"MTD" warrants this product (excluding its *Normal Wear Parts* and *Attachments* as described below) against defects in material and workmanship for a period of two (2) years commencing on the date of original purchase and will, at its option, repair or replace, free of charge, any part found to be defective in materials or workmanship. This limited warranty shall only apply if this product has been operated and maintained in accordance with the Operator's Manual furnished with the product, and has not been subject to misuse, abuse, commercial use, neglect, accident, improper maintenance, alteration, vandalism, theft, fire, water, or damage because of other peril or natural disaster. Damage resulting from the installation or use of any part, accessory or attachment not approved by MTD for use with the product(s) covered by this manual will void your warranty as to any resulting damage.

Normal Wear Parts are warranted to be free from defects in material and workmanship for a period of thirty (30) days from the date of purchase. Normal wear parts include, but are not limited to items such as: batteries, belts, blades, blade adapters, tines, grass bags, wheels, rider deck wheels, seats, snow thrower skid shoes, friction wheels, shave plates, auger spiral rubber, engine oil, air filters, spark plugs and tires.

Attachments — MTD warrants attachments for this product against defects in material and workmanship for a period of one (1) year, commencing on the date of the attachment's original purchase or lease. Attachments include, but are not limited to items such as: grass collectors and mulch kits.

HOW TO OBTAIN PARTS AND SERVICE: Warranty service is available, WITH PROOF OF PURCHASE, through your local authorized service dealer. To locate the dealer in your area:

In the U.S.A.

Check your Yellow Pages, or contact MTD LLC at P.O. Box 361131, Cleveland, Ohio 44136-0019, or call 1-800-800-7310, 1-330-220-4683 or log on to our Web site at www.mtdproducts.com.

In Canada

Contact MTD Products Limited, Kitchener, ON N2G 4J1, or call 1-800-668-1238 or log on to our Web site at www.mtdcanada.com.

This limited warranty does **not** provide coverage in the following cases:

- a. Log splitter pumps, valves, and cylinders have a separate one-year warranty.

- b. Routine maintenance items such as lubricants, filters, blade sharpening, tune-ups, brake adjustments, clutch adjustments, deck adjustments, and normal deterioration of the exterior finish due to use or exposure.
- c. Service completed by someone other than an authorized service dealer.
- d. MTD does not extend any warranty for products sold or exported outside of the United States and/or Canada, and their respective possessions and territories, except those sold through MTD's authorized channels of export distribution.
- e. Replacement parts that are not genuine MTD parts.
- f. Transportation charges and service calls.
- g. MTD does not warrant this product for commercial use.

No implied warranty, including any implied warranty of merchantability or fitness for a particular purpose, applies after the applicable period of express written warranty above as to the parts as identified. No other express warranty, whether written or oral, except as mentioned above, given by any person or entity, including a dealer or retailer, with respect to any product, shall bind MTD. During the period of the warranty, the exclusive remedy is repair or replacement of the product as set forth above.

The provisions as set forth in this warranty provide the sole and exclusive remedy arising from the sale. MTD shall not be liable for incidental or consequential loss or damage including, without limitation, expenses incurred for substitute or replacement lawn care services or for rental expenses to temporarily replace a warranted product.

Some states do not allow the exclusion or limitation of incidental or consequential damages, or limitations on how long an implied warranty lasts, so the above exclusions or limitations may not apply to you.

In no event shall recovery of any kind be greater than the amount of the purchase price of the product sold. **Alteration of safety features of the product shall void this warranty.** You assume the risk and liability for loss, damage, or injury to you and your property and/or to others and their property arising out of the misuse or inability to use the product.

This limited warranty shall not extend to anyone other than the original purchaser or to the person for whom it was purchased as a gift.

HOW STATE LAW RELATES TO THIS WARRANTY: This limited warranty gives you specific legal rights, and you may also have other rights which vary from state to state.

IMPORTANT: Owner must present Original Proof of Purchase to obtain warranty coverage.

**MTD LLC, P.O. BOX 361131 CLEVELAND, OHIO 44136-0019; Phone: 1-800-800-7310, 1-330-220-4683
MTD Canada Limited - KITCHENER, ON N2G 4J1; Phone 1-800-668-1238**