

SHARP®

AQUOS

LIQUID CRYSTAL TELEVISION
TÉLÉVISEUR À CRISTAUX
LIQUIDES

TELEVISOR DE CRISTAL
LÍQUIDO

OPERATION MANUAL
MODE D'EMPLOI
MANUAL DEL USUARIO

- Please choose your favorite page from the content.
If you want to close the operation manual, press the **EXIT** button.
Also, if you want to return to the previously displayed page, press the **RETURN** button.
- Veuillez choisir votre page favorite dans le contenu.
Appuyez sur le bouton **EXIT** pour refermer le mode d'emploi. Par ailleurs, appuyez sur le bouton **RETURN** si vous souhaitez revenir à la page précédemment affichée.
- Elija su página favorita entre los contenidos.
Si desea cerrar el manual de instrucciones, pulse el botón **EXIT**. Además, si desea volver a la página mostrada anteriormente, pulse el botón **RETURN**.



(Except for LC-90LE657U)
(Hormis LC-90LE657U)
(Excepción para LC-90LE657U)



(for UQ17U models)
(Pour les modèles UQ17U)
(Para los modelos UQ17U)



(For UQ17U, TQ15U, SQ17U, SQ15U, SQ10U and LE657U models)
(Pour les modèles UQ17U, TQ15U, SQ17U, SQ15U, SQ10U LE657U)
(Para los modelos UQ17U, TQ15U, SQ17U, SQ15U, SQ10U y LE657U)

- 1. Part Names**
 - 1-1. TV
 - 1-2. Remote Control Unit
- 2. Watching TV**
 - 2-1. Displaying an External Equipment Image
 - 2-2. Initial Installation
- 3. Direct Button Operation**
 - 3-1. Changing Channels
 - 3-2. Changing Volume
 - 3-3. MUTE
 - 3-4. FREEZE
 - 3-5. FLASHBACK
 - 3-6. SmartCentral
 - 3-7. NETFLIX
 - 3-8. AUDIO
 - 3-9. Sleep Timer
 - 3-10. AV MODE
 - 3-12. Closed Captions and Digital Closed Captions
 - 3-14. VIEW MODE
- 4. On-Screen Display Menu**
 - 4-1. Introduction
 - 4-3. On-Screen Display Menu Operation
 - 4-4. Menu Operation Buttons
 - 4-5. Picture Settings
 - 4-11. Audio Settings
 - 4-13. Setup
 - 4-22. Smart TV
 - 4-27. System Options
 - 4-32. Information
- 5. Enjoying 3D Image Viewing (For the UQ17U, TQ15U, SQ17U, SQ15U and LE657U models)**
 - 5-1. Information
 - 5-2. Preparing for the 3D glasses
 - 5-3. Using the 3D glasses
 - 5-5. Specifications - 3D glasses (sold separately)
 - 5-6. Troubleshooting - 3D Images
 - 5-7. Display Methods for 3D and 2D Images
 - 5-8. Viewing 3D Images
 - 5-11. Configuring the TV Setting to Enhance 3D Image Viewing
- 6. Enjoying Photo/Music/Video Playback**
 - 6-1. Preparation
 - 6-2. Selecting the Folders to Play Back
 - 6-4. Playing Back Files on a USB Memory Device/Home Network Server
 - 6-13. Playing Back Files from a Portable Device or PC
 - 6-14. Presetting Remote Control Function
 - 6-17. Operating the Connected Equipment
- 7. Using AQUOS LINK**
 - 7-1. Controlling HDMI Equipment Using AQUOS LINK
 - 7-4. Link Operation Menu
 - 7-6. Using a Smartphone with the TV
- 8. Using a PC**
 - 8-1. Adjusting the PC Image
 - 8-2. Setting Audio Input
 - 8-3. Control of the TV
 - 8-9. PC Compatibility Chart
- 9. Using the Internet**
 - 9-1. Connecting to the Internet
 - 9-2. Internet Setup
 - 9-5. Entering Text (Software Keyboard)
 - 9-7. Using the Browser
 - 9-11. Using Keyboard and Mouse
 - 9-12. Using Applications via the Internet
 - 9-15. Notes
- 10. Using the Bluetooth (For the UQ17U, TQ15U, SQ17U, SQ15U, SQ10U and LE657U models)/Miracast devices(For the UQ17U, TQ15U, SQ17U, SQ15U, SQ10U and EQ10U models)**
 - 10-1. Using the Bluetooth/Miracast devices
- 11. Appendix**
 - 11-1. Removing the Stand
 - 11-2. Setting the TV on the Wall
 - 11-6. Troubleshooting
 - 11-8. Troubleshooting - 3D Images
 - 11-9. Troubleshooting - Error Message
 - 11-10. Information on the Software License for This Product
- 12. Specifications**
 - 12-1. TV (For the UQ17U models)
 - 12-2. TV (For the TQ15U models)
 - 12-3. TV (For the SQ17U, SQ15U and SQ10U models)
 - 12-4. TV (For the EQ10U models)
 - 12-5. TV (For the LE650U and C6500U models)
 - 12-6. TV (For the LE657U model)
 - 12-7. Wireless LAN
 - 12-8. Bluetooth (For the UQ17U, TQ15U, SQ17U, SQ15U, SQ10U and LE657U models)
- 13-1. Trademarks**
- 14-1. Dimensional Drawings**
 - The dimensional drawings for the LCD TV set are shown on the inside back cover.

Part Names

TV

(Front)

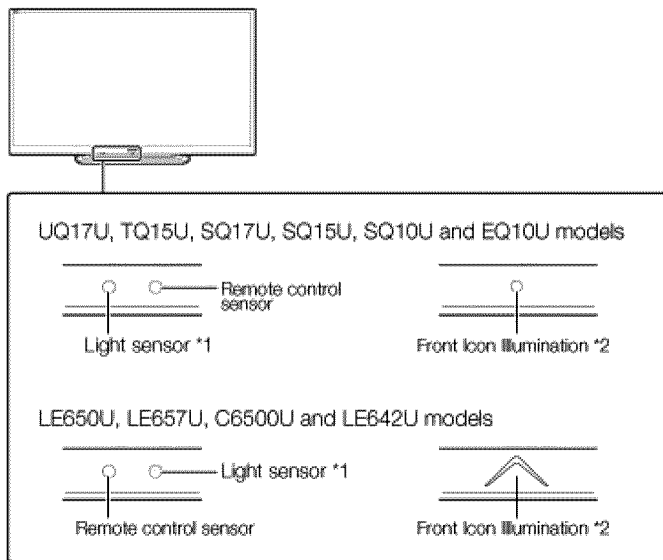

*1 See page 4-6.
*2 See page 4-31.

(Side)

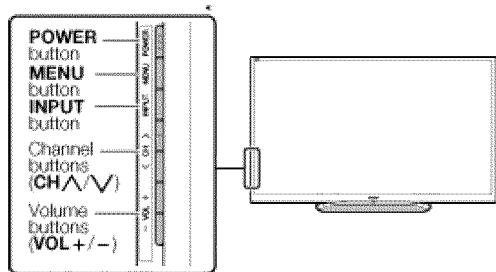

* See pages 2-1, 4-4 and 4-31 for button operations.

(Rear)

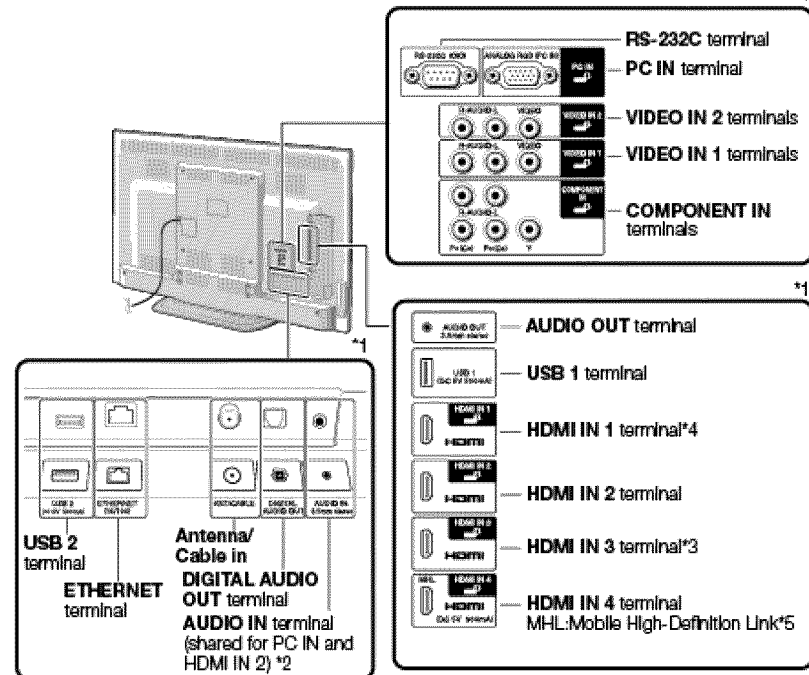

- *1 See the Setup Guide.
And see page 7-1 for external equipment connection.
*2 See page 8-2 for details on the Audio Select function.
*3 For EQ10U, LE650U, C6500U and LE642U models:
Use HDMI IN 1 to connect ARC-compatible equipment.
For UQ17U, TQ15U, SQ17U, SQ15U, SQ10U and LE657U models:
Use HDMI IN 3 to connect ARC-compatible equipment.
*4 For UQ17U, TQ15U, SQ17U, SQ15U and SQ10U models:
Connect 4K signals (HDCP2.2) to the HDMI IN 1 terminal.
(4K60P is not supported.)
*5 See page 7-6.

- The illustrations and on-screen displays in this operation manual are for explanation purposes and may vary slightly from the actual operations.
- The examples used throughout this manual are based on the LC-60LE650U model.

Part Names

Remote Control Unit

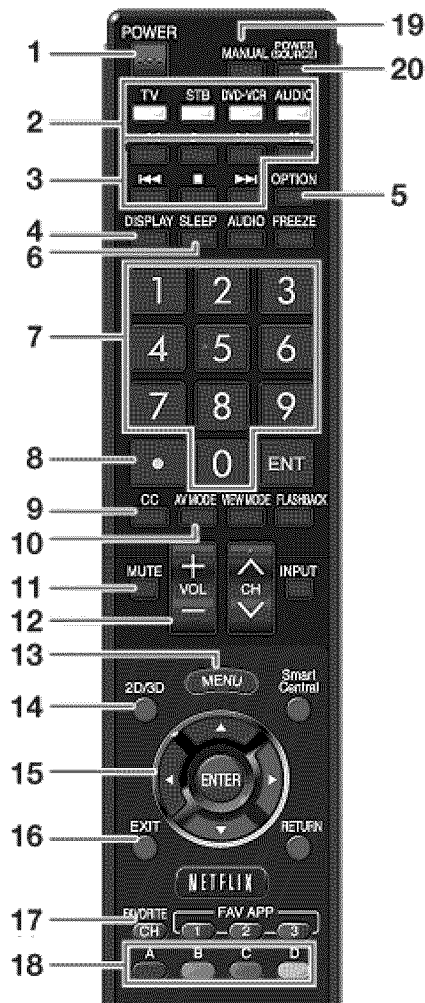

NOTE

- When using the remote control unit, point it at the TV.

1 POWER: Switch the TV power on or enter standby.

2 TV, STB, DVD-VCR, AUDIO: Switches the remote control for TV, STB, BD, DVD, VCR and AUDIO operation.

(See pages 6-14 to 6-17 for details.)

* To enter the code registration mode, you need to press an appropriate button (**STB, DVD-VCR** or **AUDIO**) and **DISPLAY** at the same time.

3 External equipment operational buttons: Operate the external equipment.

4 DISPLAY: Display the channel information.

5 OPTION: Display the Link Operation Menu screen. This button will function only when AQUOS LINK is used.

(See pages 7-1 to 7-5 for details.)

6 SLEEP: Set the sleep timer.

(See page 3-9.)

7 0-9: Set the channel.

(See page 3-1.)

8 • (DOT): Set the channel.

(See pages 3-1 and 6-17.)

9 CC: Display captions from a closed-caption source.

(See page 3-12 to 3-13.)

10 AV MODE: Select an audio or video setting.

(See page 3-10.)

11 MUTE: Mute the sound.

(See page 3-3.)

12 VOL +/-: Set the volume.

(See page 3-2.)

13 MENU: Display the menu screen.

(See page 4-1.)

14 2D/3D: UQ17U, TQ15U, SQ17U, SQ15U and LE657U models:

Select between 3D and 2D image viewing.

(See pages 5-8 to 5-10 for details.)

SQ10U, EQ10U, LE650U C6500U and LE642U models:

This can only be used for some functions.

(See pages 5-9 to 5-10 for details.)

15 ▲▼◀▶, ENTER: Select a desired item on the screen.

16 EXIT: Turn off the menu screen.

17 FAVORITE CH: Set the favorite channels.

(See page 4-15.)

18 A, B, C, D: Select 4 preset favorite channels in 4 different categories.

(See page 4-15.)

While watching, you can toggle the selected channels by pressing **A**, **B**, **C** and **D**.

19 MANUAL: Display the operation manual.

20 POWER (SOURCE): Turns the power of the external equipment on and off.

Part Names

Remote Control Unit (Continue)

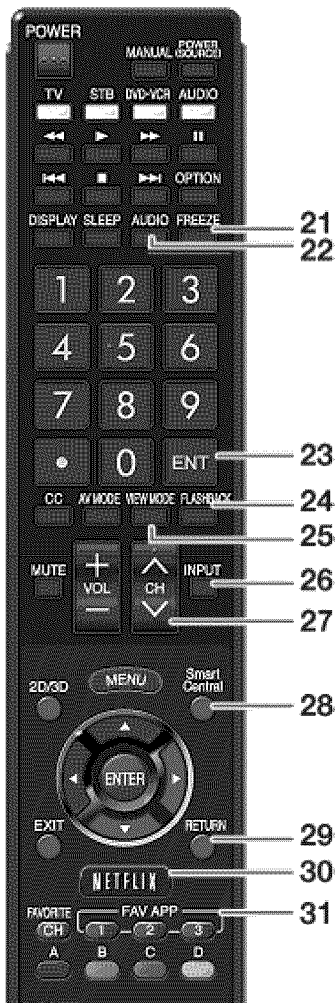

NOTE

- When using the remote control unit, point it at the TV.

21 FREEZE: Set the still image. Press again to return to normal screen.
(See page 3-4.)

22 AUDIO: Selects the MTS/SAP or the audio mode during multichannel audio broadcasts.
(See page 3-8.)

23 ENT: Jumps to a channel after selecting with the **0-9** buttons.

24 FLASHBACK: Return to the previous channel or external input mode.
(See page 3-5.)

25 VIEW MODE: Select the screen size.
(See pages 3-14 to 3-16.)

26 INPUT: Select a TV input source.
(See page 2-1.)

27 CH/V: Select the channel.
(See page 3-1.)

28 SmartCentral: Display the application window.
(See page 3-6.)

29 RETURN: Return to the previous menu screen.

30 NETFLIX: Display the Netflix screen.
If you press the NETFLIX button when the TV is turned off, the TV turns on and the NETFLIX screen is displayed.
(See page 3-7.)

31 FAV APP 1, 2, 3: You can assign your favorite applications to these buttons.
(See pages 9-7, 9-12.)

Watching TV

Displaying an External Equipment Image

To view external source images, select the input source by pressing **INPUT** on the remote control unit or on the TV.

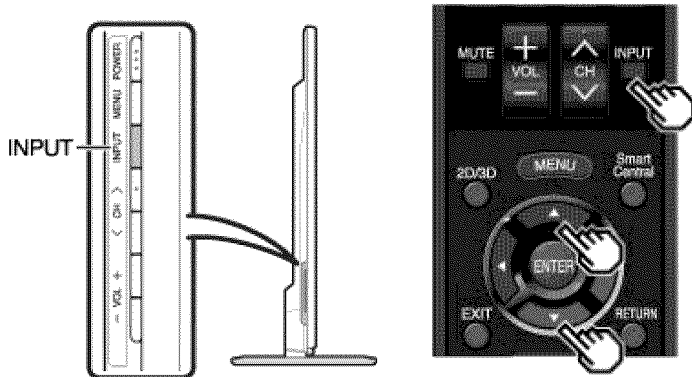

Example

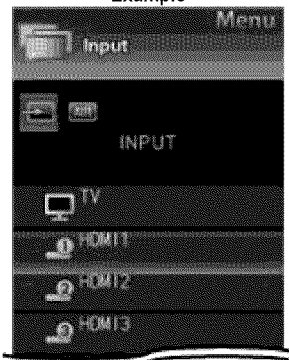

- 1 Press **INPUT**.
 - The INPUT list screen displays.
- 2 Press **▲▼** to select the input source.
 - An image from the selected source automatically displays.
 - If the corresponding input is not plugged in, you cannot change the input. Be sure to connect the equipment beforehand.

- You can also select the input source by pressing **INPUT**.
- Each time **INPUT** is pressed, the input source toggles.

UQ, TQ, SQ series

TV → HDMI1 → Home Network → USB → Screen Sharing → Bluetooth

EQ series

TV → HDMI1 → Home Network → USB → Screen Sharing

LE650U, LE657U, C6500U, LE642U

TV → HDMI1 → Home Network → USB

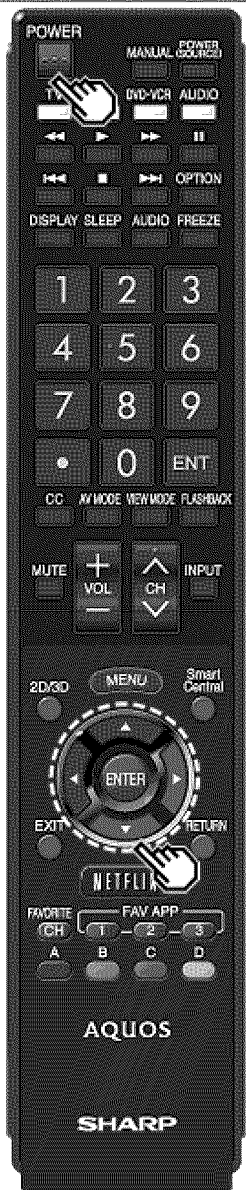

Initial Installation

When you turn on the TV for the first time, it will automatically memorize the broadcasting channels available in the region where you live. Perform the following steps before you press **POWER** on the remote control unit.

1. Insert the batteries into the remote control unit.
2. Connect the antenna cable to the TV.
3. Plug in the AC cord to the AC outlet.

Language (Language setting)

Select from among 3 languages: English, French and Spanish.

- 1 Press **▲▼** to select the desired language listed on the screen, and then press **ENTER**.

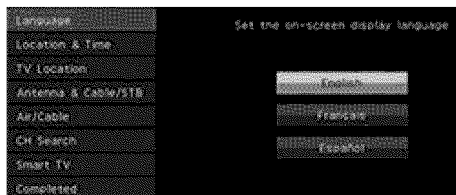

Location & Time

Make settings for the country, area and time zone where you use the TV.

- 2 Press **▲▼** to select "United States", "Canada" or "Mexico", and then press **ENTER**.



- 3 Press **▲▼** to select the time zone where you are using the TV, and then press **ENTER**.

Example



- The time zone differs depending on the selected country.
- The factory preset value is the time zone for the capital of the selected country.



Initial Installation (Continue)

4 Press ▲/▼ to select the Daylight Savings Time, and then press **ENTER**.



- "Auto" is the default selection.

TV Location

Select "Home" or "Store" for the location where you plan to install the TV. This product qualifies for ENERGY STAR*1 in Home mode default setting.

5 Press ◀▶ to select "Home" or "Store". Press **ENTER** to enter the setting.

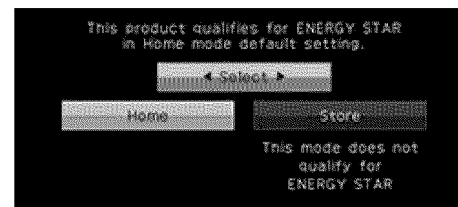

Home: "Power Saving" is set to "Advanced", and AV MODE is set to "STANDARD (ENERGY STAR)*1".

Store: "Power Saving" is set to "Off" and AV MODE is set to "DYNAMIC (Fixed)". Picture Reset and Feature Demo can be set.

Picture Reset: AV MODE will be set to "DYNAMIC (Fixed)" regardless of whether Picture Reset is "On" or "Off".

- If you select "On" and there is no operation for 30 minutes:
 - AV MODE will be reset to "DYNAMIC (Fixed)".
 - When a 3D signal is detected, 3D images will switch to 2D images. (For the UQ17U, TQ15U, SQ17U, SQ15U and LE657U models.)
- When "Off" is selected:
 - AV MODE will be set to "DYNAMIC (Fixed)".

Feature Demo: When "On" is selected, after all the settings are completed, the Feature Demo screen is displayed if there is no operation for several minutes.

NOTE

- ENERGY STAR qualification is based on AV MODE "STANDARD (ENERGY STAR)*1".

*1: Except for LC-90LE657U



Initial Installation (Continue)

Antenna & Cable/STB

Select the type of connection you will use to watch TV.

6 Press to select "Antenna & Cable" or "Set-top box", and then press **ENTER**.



To watch TV via an antenna or cable connection (without using a set-top box):

Select "Antenna & Cable", and then go to step 7.

To watch TV via a set-top box:

① Select "Set-top box", and then press **ENTER**.

② Check that the set-top box connected to the TV is on.

③ Press to select the input to which the set-top box has been connected.

- If your Set-top box is turned off, "Disconnected" might be shown.

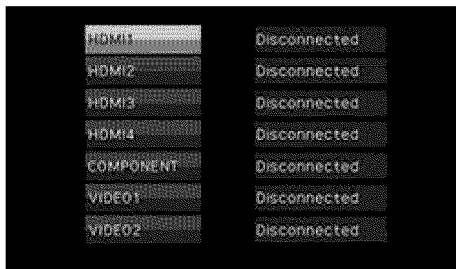

④ To watch TV, select the input source corresponding to the terminal connected to the set-top box. When doing so, you must make the setting to skip "TV". Press to select "On", and then press **ENTER**.

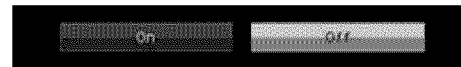

- When this is set to "On", the channel on the TV cannot be changed using the remote control unit or menu. (e.g. CH , Favorite CH, etc.)
- See page 4-20 for details on the Input Skip function.
- ⑤ Press **INPUT** to select the input source corresponding to the terminal connected to the set-top box. Make the necessary settings on the connected external equipment.
- See the operation manual of the connected equipment for setting up the equipment.

Air/Cable (Antenna setting)

Make sure what kind of connection is made with your TV when selecting "Air" or "Cable".

7 Press to select "Air" or "Cable".

Press **ENTER** to enter the setting.



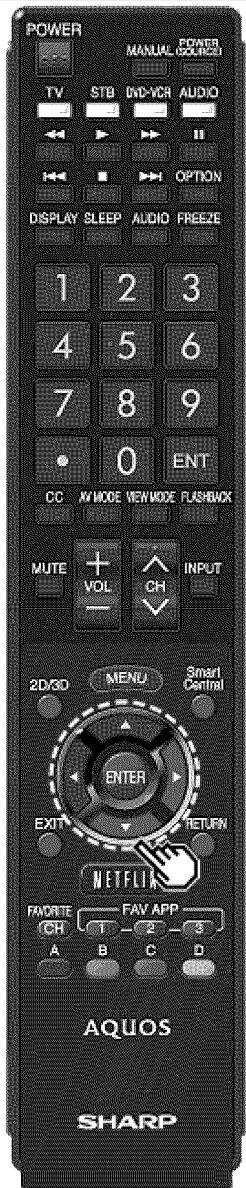

Initial Installation (Continue)

CH Search (Channel search)

Channel auto search makes the TV look for all channels viewable in the set area.

8 When "Air" is selected in Antenna setting:

Press **▶** to select "Start", and then press **ENTER**.

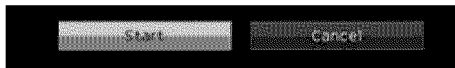

When "Cable" is selected in Antenna setting:

① Press **▲▼** to select "Analog & Digital Search Start" to search both analog and digital broadcasts, or to select "Analog Search Start" to search only analog broadcasts, and then press **ENTER**.



- The Channel search will start automatically.
- To exit the Channel search screen, select "Cancel", and then press **ENTER**.

② The Channel search results may include scrambled channels or channels that are not viewable in the set area. Press **◀▶** to select "Yes", and then press **ENTER** to remove scrambled channels.

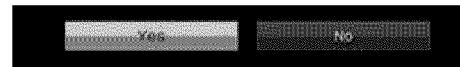

Smart TV

When you connect to the Internet on the TV, select the desired connection method and follow the instructions shown on the display.

- Wireless LAN connection is possible only when the WPS (push button) method is used. If any other method is used, make settings by Smart TV > Internet Setup > Internet Connection. (See pages 9-2 to 9-4.)

9 Press **▶** to select "Yes", and then press **ENTER**.



10 Press **▲▼** to select "Wired" or "Wireless", and then press **ENTER**.

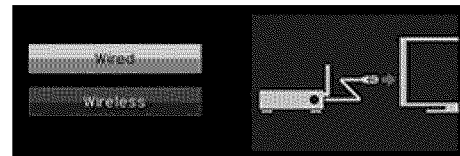

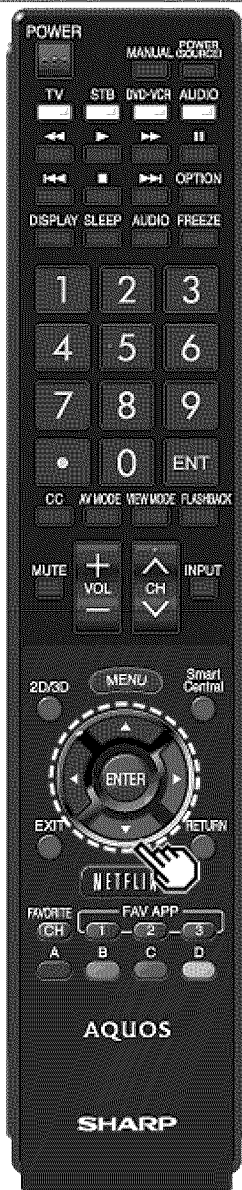

Initial Installation (Continue)

Connection using an ETHERNET cable:

- ① Select "Wired" and press **ENTER**.
- ② Confirm that the TV is properly connected with the router, and then press "Next". Follow the instructions on the display to perform the connection test.

Wireless LAN connection by the WPS method:

- ① Select "Wireless" and press **ENTER**.
- ② Follow the instructions on the display, and finalize the connection after testing its viability.

NOTE

- After you finish configuring the network settings, configure the "TV Name Setting", "Remote Control App", and "Samba TV" settings. (See page 4-26, 8-3.)
- The product that you have purchased may not be equipped with "Samba TV". In this case, this feature will be added by way of a planned future software version update.
- When you change the network settings, refer to Smart TV > Internet Setup > Internet Connection. (See pages 9-2 to 9-4.)

Completed

- 11 The settings confirmation screen is displayed. Confirm the information displayed on the screen, and then press **ENTER**.

Examples of the settings confirmation screen

When one or more channel is received after "Antenna & Cable" was selected in step 6 and a search was carried out.

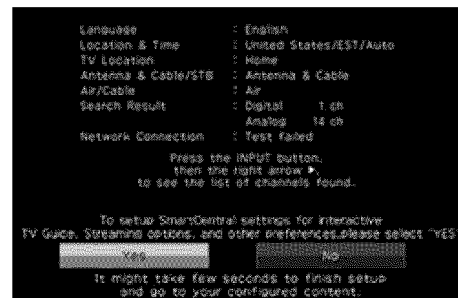

When no channel is received after "Antenna & Cable" was selected in step 6 and a search was carried out.





Initial Installation (Continue)

NOTE

- If no channel is found, confirm the type of connection made with your TV and try "Easy Setup" again. (See page 4-13.)
- To see the list of channels found during Channel search, press **INPUT**, and then press **▶**.

When "Set-top box" was selected in step 6.



- Click "OK" to display the confirmation screen for input source switching.

Show the input list: You can check the current connection status of external equipment. Confirm which input terminal is connected to the set-top box.

OK: Clicking "OK" will complete the Easy Setup procedure.

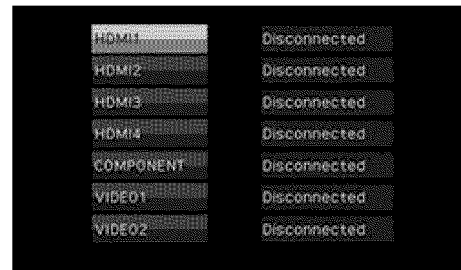

- This may not display correctly depending on the connected equipment.
- This is not displayed correctly when the connected equipment is off.
- To watch TV using a set-top box, press **INPUT** after completing the initial settings, and select the input to which the set-top box is connected.

NOTE

- For changing the settings of the Initial Installation, perform "Easy Setup" on the Setup menu on page 4-13.



Changing Channels

You can change channels in several ways.

Method 1

Using **CHAN** on the remote control unit or on the TV.

Method 2

Using remote control buttons **0-9**, **• (DOT)**.

Examples:

To select a 1 or 2-digit channel number (e. g., Channel 5):

Press **5** → **ENTER**

To select a 3-digit channel number (e. g., Channel 115):

Press **1** → **1** → **5** → **ENTER**

To select a 4-digit channel number (e. g., Channel 22.1):

Press **2** → **2** → **• (DOT)** → **1** → **ENTER**

Method 3

Selecting the program from the Channel list.

1 Press **INPUT** on the remote control unit.

- The INPUT list displays.

2 Press **◀▶** to select "AIR" or "CABLE".

- The Channel list displays.

3 Press **▲▼** to select the desired channel, and then press **ENTER**.

NOTE

- When selecting a 1-digit channel number, it is not necessary to press **0** before the number.
- When you enter **0-9** only, channel selection will be made if there is no operation within a few seconds.
- If you push "0" by itself, nothing will happen.
- Complete the above steps within a few seconds.
- When you enter **0-9** and **• (DOT)**, channel selection will be made if there is no operation within a few seconds.



Changing Volume

You can change the volume by pressing **VOL+/-** on the TV or on the remote control unit.

- To increase the volume, press **VOL +**.
- To decrease the volume, press **VOL -**.



Audio status

Output device	Output Select	
	Fixed	Variable
Speaker	Variable sound	Mute

- When "Output Select" is set to "Variable", the indicator on the screen changes as shown below.



NOTE

- [See page 4-20](#) for details on the Output Select function.

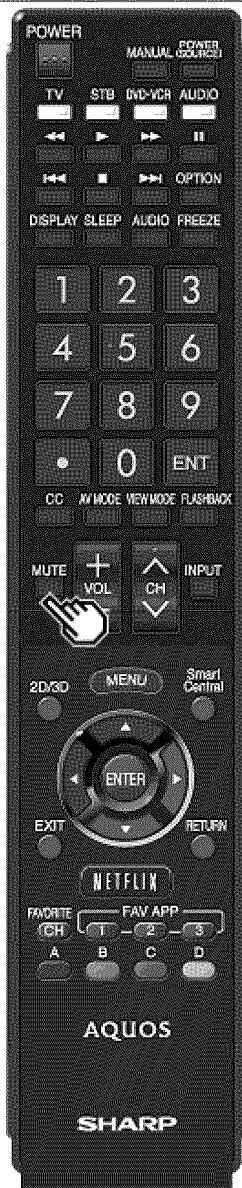

MUTE

Mutes the current sound output.

Press **MUTE**.

- "M" will be displayed on the screen for 30 minutes, and the sound is silenced.

NOTE

- Within 30 minutes of pressing **MUTE**, mute can be canceled by pressing **VOL+/-** or **MUTE**.
- Mute will be canceled after 30 minutes have passed. However, the TV will not suddenly output a loud sound as the volume level is set to 0 automatically.



FREEZE

Allows you to capture and freeze a moving image that you are watching.

Press **FREEZE**.

- A moving image is captured.
- Press **FREEZE** again to cancel the function.

NOTE

- When this function is not available, "No displaying still image available." will display.
- The still image automatically goes out after 30 minutes.
- If you are using the freeze function and a broadcast activates the V-CHIP BLOCK, the freeze function will be canceled and a V-CHIP BLOCK message will appear.
- You can have the same settings by choosing "Freeze" on the menu items.
(See page 4-28.)



FLASHBACK

Press **FLASHBACK** to switch to the previously tuned channel or previous input mode.

- Press **FLASHBACK** again to switch back to the currently tuned channel.

NOTE

- **FLASHBACK** will not work if no channel has been changed after the TV is turned on.



SmartCentral

Allows you to directly activate various types of applications.

- 1 Press **SmartCentral** to display the application window.
 - Press **SmartCentral** again to display a list of applications by category.
- 2 Press **Left/Right** (or **Up/Down**) to select the desired application, and then press **ENTER**.
 - If you changed the display to the list of applications in step 1, select a category and then an application. See pages 9-12 to 9-13 for details.
 - If "E" is displayed after you switch to USB mode, check the USB connection.
 - If "X" or "X" is displayed after you switch to Home Network mode or after you connect to the Internet, check your TV's network settings and connection.

NOTE

- See page 6-2, 9-7 to 9-12 for details of viewable applications.
- You can display the application window by choosing "App Dock" on the menu items. (See page 4-28.)
- When this function is not available, "Can not operate this function now" will display.

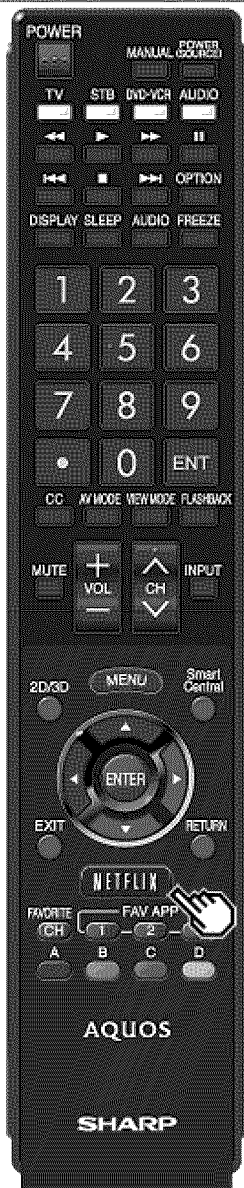

NETFLIX

Displays the Netflix screen.

Press **NETFLIX**.

NOTE

If you press the NETFLIX button when the TV is turned off, the TV turns on and the NETFLIX screen is displayed.

- To enjoy Netflix, you need to make:

—a broadband Internet connection

(See page 9-1.)

—settings of Internet Setup

(See pages 9-2 to 9-4.)

—adjustments for Netflix

(See page 9-13.)

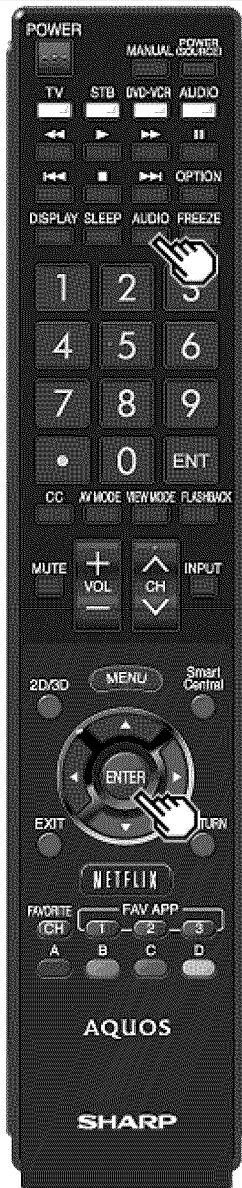

AUDIO

MTS/SAP stereo mode

The TV has a feature that allows reception of sound other than the main audio for the program. This feature is called Multi-channel Television Sound (MTS). The TV with MTS can receive mono sound, stereo sound and Secondary Audio Programs (SAP). The SAP feature allows a TV station to broadcast other information, which could be audio in another language or something completely different like weather information.

You can enjoy Hi-Fi stereo sound or SAP broadcasts where available.

- **Stereo broadcasts:** View programs like live sporting events, shows and concerts in dynamic stereo sound.
- **SAP broadcasts:** Receive TV broadcasts in either MAIN or SAP sound.
 MAIN sound: The normal program soundtrack (either in mono or stereo).
 SAP sound: Listen to a second language, supplementary commentary or other information. (SAP is mono sound.)

If stereo sound is difficult to hear.

- Obtain a clearer sound by manually switching to fixed mono-sound mode.

You can change MTS as shown below to match the television broadcast signal.

Press **AUDIO** to toggle between audio modes.

Examples: when receiving MTS and SAP

STEREO mode: ST(SAP) → SAP(ST) → MONO

STEREO + SAP mode: STEREO ↔ MONO

MAIN + SAP mode: MAIN ↔ SAP

MONO mode: MONO

Digital broadcasting audio mode

The types of audio transmitted in a digital broadcast include SURROUND as well as MONO and STEREO. In addition, it is possible for multiple audio tracks to accompany a single video track.

Press **ENTER** to toggle between audio modes.

Example: when receiving Digital broadcasting

STEREO (Audio1) → STEREO (Audio2)
 ← SURROUND (Audio3) ←

NOTE

- MTS only operates while in TV mode.
- You can have the same settings by choosing "Change Audio" on the menu items.
 (See page 4-29.)

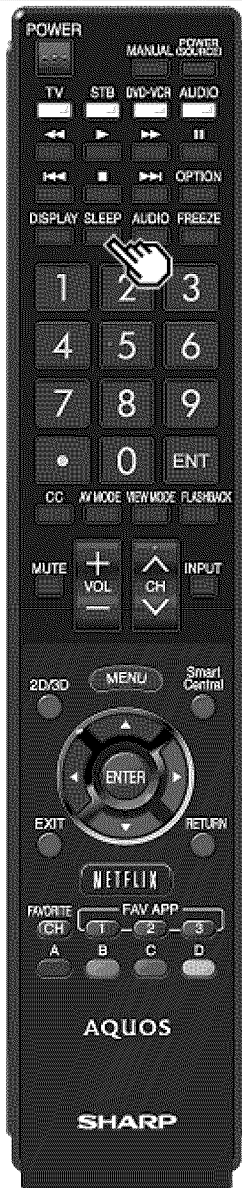

Sleep Timer

Allows you to set a time when the TV automatically switches to standby.

Press **SLEEP**.

- The remaining time displays when the sleep timer has been set.
- Each time you press **SLEEP**, the remaining time switches as shown below.

Off → 30 → 60 → 90 → 120

- When set, the time automatically starts counting down.
- If you want to adjust the sleep timer, you can press **SLEEP** twice then change the time setting.
- When it is 5 minutes before the time expires, the remaining time will start to keep appearing every minute.

NOTE

- Select "Off" by pressing **SLEEP** to cancel the sleep timer.
- The TV will enter standby when the remaining time reaches 0.

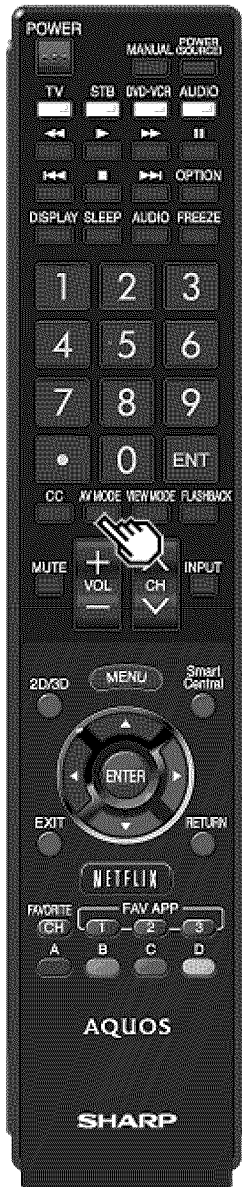

AV MODE

AV MODE gives you several viewing options to choose from to best match the surrounding environment of the TV, which can vary due to factors like room brightness, type of program watched or the type of device connected.

You can use USER Mode to create customized settings for each TV input. These settings will be automatically saved on each input for convenience.

Press **AV MODE**. Current AV MODE displays.

- Press **AV MODE** again before the mode displayed on the screen disappears.
- The mode changes as shown below:

Example:
When using the **COMPONENT IN, VIDEO IN 1 or 2** terminals

UQ17U, TQ15U, SQ17U, SQ15U, SQ10U and EQ10U models

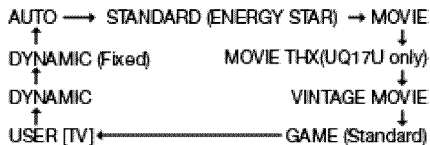

LE650U, LE657U, C6500U and LE642U models



• Example:

When using the **PC IN** or **HDMI IN 1 to 4** terminals

UQ17U, TQ15U, SQ17U, SQ15U, SQ10U and EQ10U models

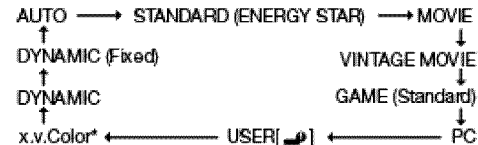

*"x.v.Color" can only be selected when an x.v.Color signal is input using **HDMI IN 1 to 4** terminals.

LE650U, LE657U, C6500U and LE642U models

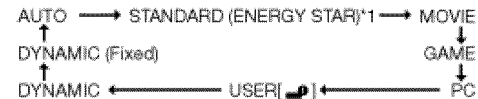

NOTE

- *1: Except for LC-90LE657U

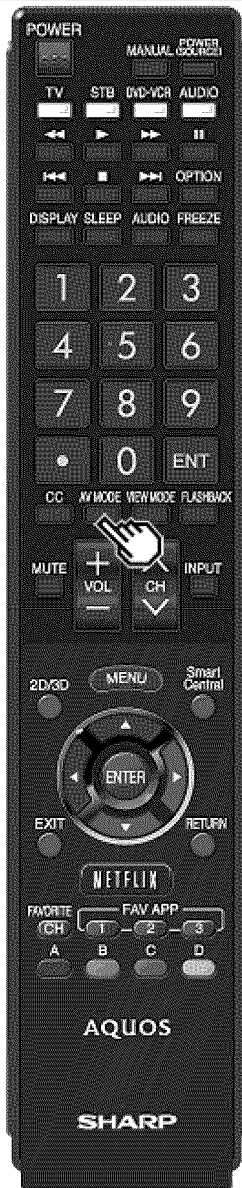

AV MODE (Continue)

AUTO: Optimizes the image quality automatically based on the room brightness and image signal.

STANDARD (ENERGY STAR)*1: For a highly defined image in a normal lighting.

MOVIE: For a movie.

MOVIE THX: Changes the image quality so that it conforms to the THX display standard. (For the UQ17U models.)

VINTAGE MOVIE: Allows you to enjoy old-time films in a good old-fashioned way, where the images look as if they were projected in real time in those days.

GAME (Standard/High Motion): Suitable for game playing. You can configure the settings according to the type of the game. Refer to "Picture Setting" > "Advanced" > "Game Type".) (For the UQ17U, TQ15U, SQ17U, SQ15U, SQ10U and EQ10U models)
(See page 4-10.)

GAME: Lowers image brightness for easier viewing. (For the LE650U, LE657U, C6500U and LE642U models)

PC: For PC.

USER: Allows the user to customize settings as desired. You can set the mode for each input source.

x.v.Color: Supports the x.v.Color international standard for wide color space. The x.v.Color signal allows you to experience colors that conventional color signals cannot reproduce.

DYNAMIC: For a clear-cut image emphasizing high contrast, useful for sports viewing.

DYNAMIC (Fixed): Changes the image and sound settings to the factory preset values. No adjustments are allowed.

NOTE

- You can select a different AV MODE item for each input mode. (For example, select STANDARD (ENERGY STAR) *1 for TV input and DYNAMIC for COMPONENT.)
- "MOVIE THX" MODE is not available when 4K signal input.
- When you play games, "GAME" is recommended for AV MODE.
- You cannot set "PC" when the TV is connected to the Internet.
- You cannot set "GAME" or "PC" when the input source is "Home Network" or "USB".
- You can have the same settings by choosing "AV MODE" on the menu items.

(See page 4-5.)

*1: Except for LC-90LE657U

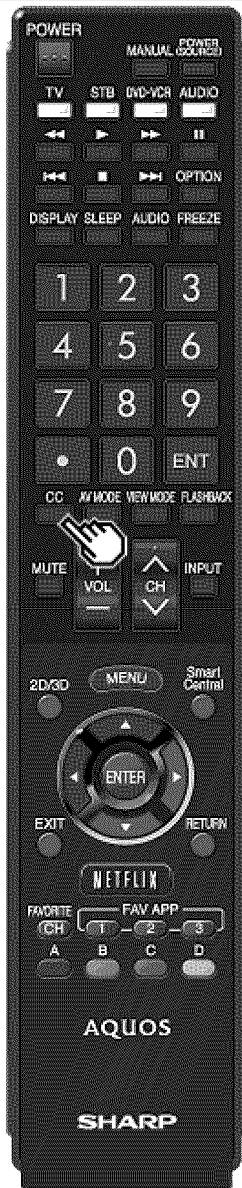

Closed Captions and Digital Closed Captions

Your TV is equipped with an internal Closed Caption decoder. It allows you to view conversations, narration and sound effects as subtitles on your TV. Closed Captions are available on some TV programs and on some VHS home video tapes at the discretion of the program provider. Digital Closed Caption service is a new caption service available only on digital TV programs (also at the discretion of the service provider). It is a more flexible system than the original Closed Caption system, because it allows for a variety of caption sizes and font styles. When the Digital Closed Caption service is in use, it will be indicated by the appearance of a 3-letter abbreviation that also indicates the language of the Digital Closed Captions: ENG (English), SPA (Spanish), FRA (French) or other language codes. Not all programs and VHS videotapes offer closed captions. Please look for the "CC" symbol to ensure that captions will be shown.

In the Closed Caption system, there can be more than one caption service provided. Each is identified by its own number. The "CC1" and "CC2" services display subtitles of TV programs superimposed over the program's picture. In the Closed Caption system, the "Text1" or "Text2" services display text that is unrelated to the program being viewed (e.g., weather or news). These services are also superimposed over the program currently being viewed.

- 1 Press **CC**.
 - This will present the Closed Caption information display.
- 2 Press **CC** while the Closed Caption information is still on the screen.
 - Press repeatedly until you select the desired closed caption service.



Closed Caption information

Closed Caption information

- Depending on the number of caption services in the signal being received, you will see information such as 1/2 or 1/4 displayed. 1/2 means "the first of two services".
- Example:**
If a program has three services (Digital CC(ENG), CC1 and Text1), the closed caption display will toggle in this sequence:



- The **CC** button keeps a record of the last service selected in its memory. If the last closed caption mode (e.g. 1/3 ENG) you selected is not available for the next program, or on another channel, the closed caption service that is available is automatically selected, and this service appears in parentheses, e.g. "1/3(CC1)". Closed Caption services that appear in parentheses will not be stored in the **CC** button's memory as your last selected service. Only services that you have selected with the **CC** button are stored.

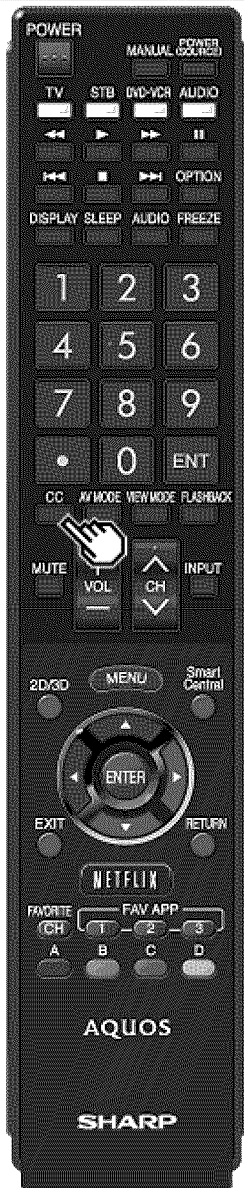

Closed Captions and Digital Closed Captions (Continue)

Examples:

In a case where there are two closed caption services provided (for instance, Digital CC(ENG) and CC1), and Digital CC(ENG) is displayed as your current selection, if Digital CC(ENG) is not broadcast for the next program, the other closed caption service, CC1, will be displayed in parentheses.

A closed caption service appears in parentheses because the service you selected is not available and a different service is displayed on your screen. "1/1(CC1)" is displayed instead of "1/2/ENG".

NOTE

- When "Power Saving" is set to "Standard" or "Advanced", the Power Saving leaf icon appears on the channel information window.
[See page 4-27](#) for details of Power Saving settings.
- [See page 4-30](#) for detailed closed caption settings.
- When the program contains no closed caption, "--" displays in the closed caption information.
- If the language code, e.g. "ENG", is not found on Digital TV programs, "--" will be shown.
- Four kinds of closed caption service (CC1, CC2, Text1, Text2) are potentially available, but a broadcast may contain none or only some of these services at the discretion of the program provider.
- When a web page is displayed, Closed Captions are not available.
- You can have the same settings by choosing "Change CC" on the menu items.
[\(See page 4-29.\)](#)

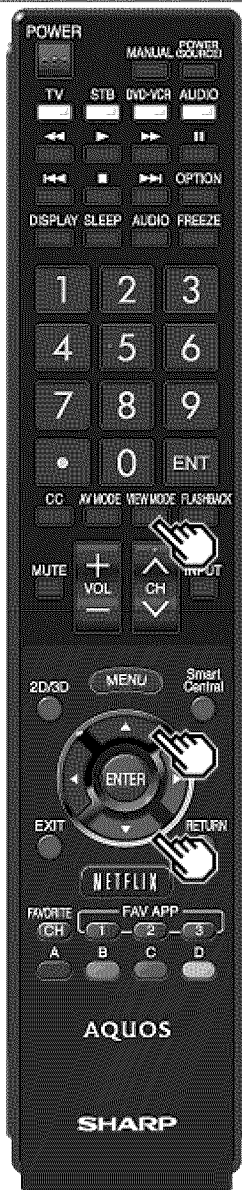

VIEW MODE

You can select the screen size.

1 Press **VIEW MODE**.

- The View Mode menu displays.
- The menu lists the View Mode options selectable for the type of video signal currently being received.





2 Press **VIEW MODE** or **▲/▼** while the View Mode menu is displayed to select a desired item on the menu.

- You can sequentially select a View Mode that has its own aspect ratio.

NOTE

- You can have the same settings by choosing "View Mode" on the menu items. (See page 4-28.)
- Each time you press **VIEW MODE** when a browser screen is shown, the display pattern toggles between a website-only screen and a TV+Web screen.
- You may not be able to change the View Mode while in 3D mode. (For the UQ17U, TQ15U, SQ17U, SQ15U and LE657U models)

For HD programs

Stretch	Dot by Dot (Full Screen)	S.Stretch (Smart stretch)	Zoom
 <p>Suitable for viewing wide-screen 1.78:1 aspect ratio program, stretch mode will still show very thin black bands at the top and bottom of the screen.</p>	 <p>Dot by Dot (1080i/p only): Detects the resolution of the signal and displays an image with the same number of pixels on the screen.</p> <p>Full Screen (720p only): You can select "Full Screen" only when receiving a 720p signal.</p>	 <p>Suitable for stretching 4:3 programs to fill the screen.</p>	 <p>Suitable for viewing wide-screen 2.35:1 aspect-ratio programs in full screen.</p>



NOTE

- When using Dot by Dot or Full Screen, it is possible to see noise or bars around different outer portions of the screen. Please change view mode to correct this.



VIEW MODE (Continue)

For 4:3 programs
Example: Screen size images

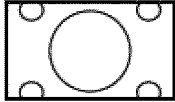
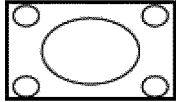
Side Bar	S.Stretch (Smart stretch)	Zoom	Stretch
			
Suitable for viewing conventional 4:3 programs in their normal format.	Suitable for stretching 4:3 programs to fill the screen.	Suitable for viewing wide-screen 2.35:1 anamorphic DVDs in full screen.	This mode is useful for 1.78:1 DVDs. When viewing 1.85:1 DVDs, stretch mode will still show very thin black bands at the top and bottom of the screen.

For USB-Video, Home Network Video or Internet applications
Example: Screen size images

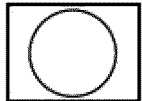
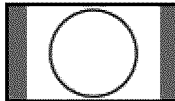
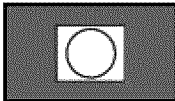
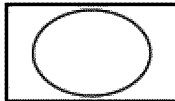
Input signal	Auto	Original	Stretch
			
	Keeps the original aspect ratio in a full screen display.	Displays an image by an original size.	An image fully fills the screen.



VIEW MODE (Continue)

For PC
Example: Screen size images

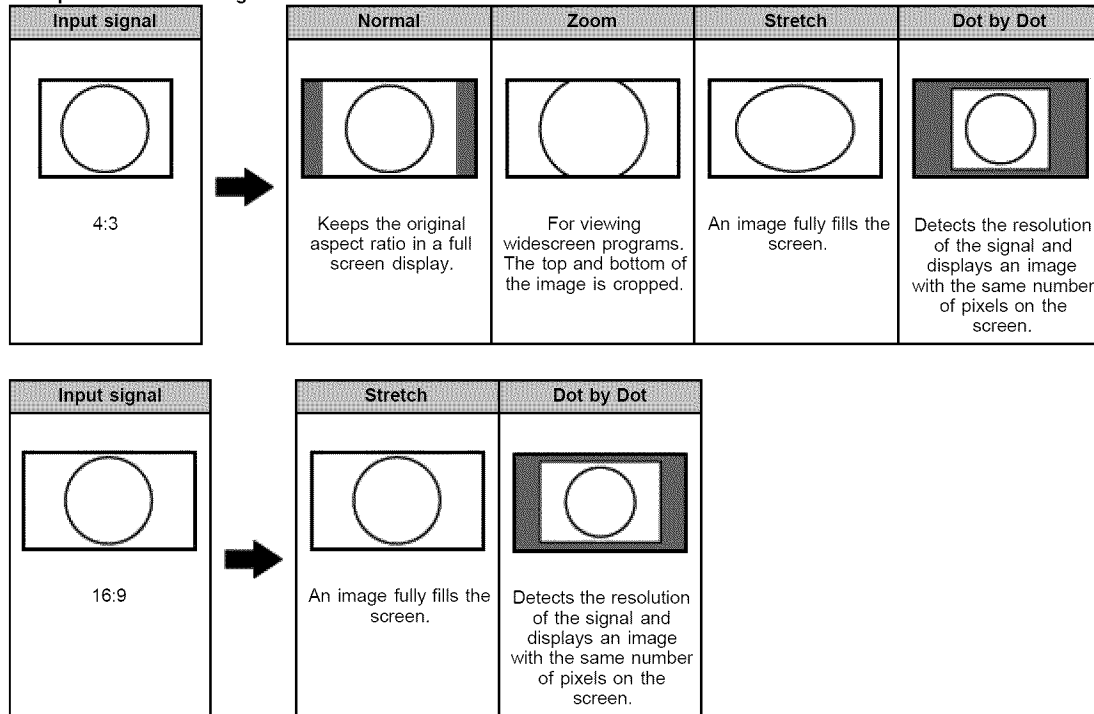

NOTE

- Connect the PC before making adjustments. See the Setup Guide.
- Selectable screen size may vary with input signal type.

On-Screen Display Menu



Introduction



① Guide display

- This indicates the buttons that can be operated on the displayed screen. The guide display varies depending on the menu setting screen.
- The operations for some selected items may be displayed in the operational guide bar at the bottom of the screen.

② Item displayed in blue

- This indicates the item currently selected.
- Press **ENTER** to go to the adjustment screen for this item.

③ Item in brackets

- This indicates the current setting for the item.

④ Item displayed in white

- This indicates that the item can be selected.

⑤ Item displayed in gray

- This indicates that the item cannot be selected. There are various reasons why the items cannot be selected, but the main reasons are as follows:

- Nothing is connected to the selected input terminal.
- The function is not compatible with the current input signal.
- When this conflicts with other functions, you must change the settings for the other functions.



Introduction(Continue)

About Menu Items

- When AV MODE is set to "AUTO", part of the menu may not be displayed correctly or the setting range of the menu may be changed.
- Some menu items may not be displayed depending on the selected input source.

NOTE

- The screens in the operation manual are for explanation purposes (some are enlarged, others cropped) and may vary slightly from the actual screens.
- The order of explanations for each menu item in the following pages is not necessarily in accordance with the alignment of the items on the screen.



LCFONT:

- This product is embedded with LC Font technology, which was developed by SHARP Corporation for clearly displaying easy-to-read characters on LCD screens.



Menu Operation Buttons

Using the remote control

Use the following buttons on the remote control to operate the menu.

MENU: Press to open or close the menu screen.

▲/▼/◀/▶: Press to select a desired item on the screen or adjust a selected item.

ENTER: Press to go to the next step or complete the setting.

RETURN: Press to return to the previous step.

Using the control panel of the TV

You can also operate the menu with the control panel of the TV.

Button operations on the control panel correspond to the ones on the remote control as shown below.

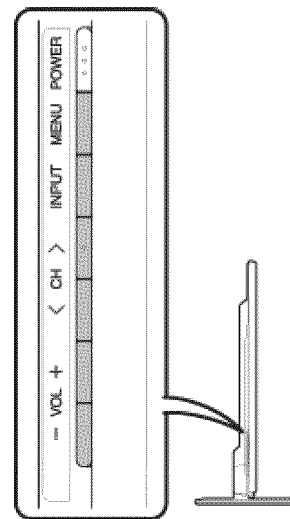

MENU: MENU on the remote control.

INPUT: ENTER on the remote control.

CH▲/▼: Cursor ▲/▼ on the remote control.

VOL+/-: Cursor ◀/▶ on the remote control.

Example



(ENERGY STAR: Except for LC-90LE667U)

(For the UQ, TQ and SQ models.)



Picture Settings

Adjusts the picture to your preference with the following picture settings.

NOTE

- For operating the on-screen display menu, [see page 4-3](#).

Selected item	◀ button	▶ button
Backlight	The screen dims	The screen brightens
3D Brightness Boost	High/Middle/Low: Select a desired level of 3D Brightness Boost.	
Contrast	For less contrast	For more contrast
Brightness	For less brightness	For more brightness
Color	For less color intensity	For more color intensity
Tint	Skin tones become reddish	Skin tones become greenish
Sharpness	For less sharpness	For more sharpness

- You can select "3D Brightness Boost" while in 3D mode.
- For resetting all Picture adjustment items to the factory preset values, press ▲/▼ to select "Reset", press ENTER, press ▲/▼ to select "Yes", and then press ENTER.

AV MODE (Changing Pic. Quality)

The audio and video settings can be changed to suit the program or input content being watched.

NOTE

- The selectable items vary depending on the input source and on the model of your TV.
- For details of the selectable items in 3D mode, [see page 5-11](#). (For the UQ17U, TQ15U, SQ17U, SQ15U and LE657U models)
- You can select AV MODE by pressing AV MODE on the remote control unit. [See page 3-10](#) for details of AV MODE settings.

Example



(ENERGY STAR: Except for LC-90LE667U)

(For the UQ, TQ and SQ models.)



Picture Settings (Continue)

THX Setup (For the UQ17U models)

Adjust the picture to room illumination or ambient brightness. This function is available only when AV MODE is set to "MOVIE THX".

Bright room: Select this item for a bright room.

Dark room: Select this item for a dark room.

Automatic Light Sensor (Light Sensor)

Automatically adjusts the brightness of the screen.

Off: The brightness is fixed at the value set in "Backlight".

On: Automatically adjusts.

On:Display: Displays the Light Sensor effect on the screen while adjusting the brightness of the screen.

NOTE

- When set to "On", the Light Sensor senses the surrounding light and automatically adjusts the backlight brightness. Make sure nothing obstructs the Light Sensor, which could affect its ability to sense surrounding light.
- When set to "On:Display", Light Sensor effect displays on the screen while the Light Sensor adjusts the screen brightness.

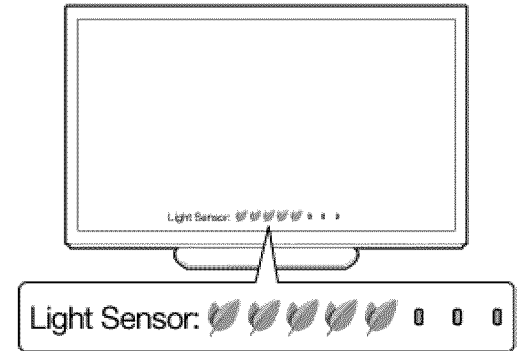

Example

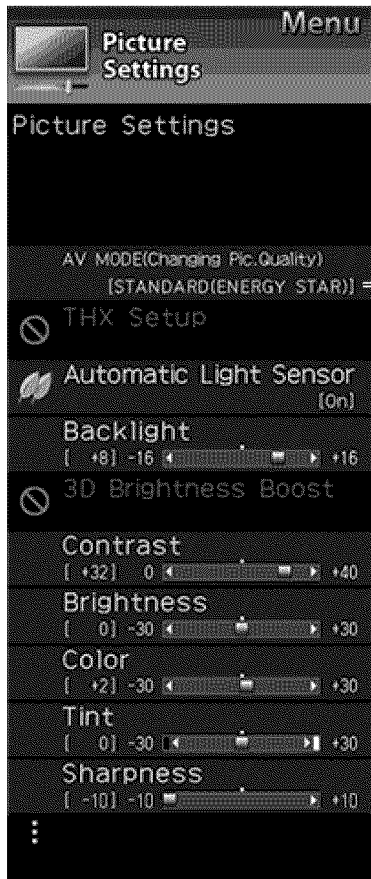

(ENERGY STAR: Except for LC-90LE667U)

(For the UQ, TQ and SQ models.)



Picture Settings (Continue)

Advanced

Resolution Enhanced (for the UQ17U, TQ15U, SQ17U, SQ15U and SQ10U models)

Configures Resolution Enhanced Mode settings.

NOTE

- When Resolution Enhanced Mode is set to "Mode 1" or "Mode 2", the following modes do not work.
 - Motion enhancement (AquoMotion 960 and 240 Hz)
 - Game Type
 If you want to use these modes, set Resolution Enhanced to "Off".
- Resolution Enhanced is not available when:
 - The A/M960 or 240 Hz mode is selected.
 - "Game Type" is set to "High Motion".
 - 3D mode is on.

Quad Pixel Plus 2 (for the EQ10U models)

Smooths diagonal lines by detailed dot control.

Advanced: Produces smoother diagonal lines by jaggy removal process.

Standard: Produces smooth diagonal lines.

Off: No adjustment.

NOTE

- When AV MODE is set to "VINTAGE MOVIE" MODE, "Quad Pixel Plus2" is not available.

Motion Enhancement

Use Motion Enhancement to view fast-action video more clearly.

Selected item	Description
AquoMotion960	Turn the LED backlight on or off for 240Hz drive display.
240Hz	For obtaining a clearer image.
AquoMotion240	Turn the LED backlight on or off for 120Hz drive display.
120Hz High	For obtaining a clearer image.
120Hz Low	
Off	Original image.

UQ17U models

AquoMotion960/240Hz/AquoMotion240/
120Hz High/120Hz Low/Off

TQ15U, SQ17U, SQ15U, SQ10U, EQ10U models

240Hz/AquoMotion240/120Hz High/120Hz Low/Off

LE657U model

AquoMotion240/120Hz High/120Hz Low/Off

LE650U, C6500U and LE642U models

120Hz High/120Hz Low/Off

NOTE

- "Motion Enhancement" may cause image noise. If this occurs, turn the function "Off".
- When AV MODE is set to "VINTAGE MOVIE" MODE, "GAME" or "PC", or PC format is being input, "Motion Enhancement" is not available.

Example



(ENERGY STAR: Except for LC-90LE667U)

(For the UQ, TQ and SQ models.)



Picture Settings (Continue)

Clear Picture Processing (for the UQ17U, TQ15U, SQ17U, SQ15U and SQ10U models)

Reduces jaggies and noise and displays a clear picture. Processes noise included in broadcast signals to improve picture quality.

High:Improves picture quality through Clear Picture Processing at a level above "Standard".

Middle:Improves picture quality through Clear Picture Processing.

Off:No adjustment.

C.M.S. (Color Management System)

Color tone is managed using the six-color adjustment setting.

C.M.S.-Hue: This is a standard to adjust the color either more reddish or more bluish in tone.

C.M.S.-Saturation: Increases or decreases the saturation of a selected color.

C.M.S.-Value: A higher value makes the image brighter. A lower value makes the image darker.

NOTE

- For resetting all adjustment items to the factory preset values, press ▲/▼ to select "Reset", and then press ENTER.

Color Temp. (Color Temperature)

For a better white balance, use color temperature correction.

High: White with bluish tone

Mid-High:

Middle:

Mid-Low:

Low: White with reddish tone

Low (Xenon), Low (Carbon arc): Available only when AV MODE is set to "VINTAGE MOVIE" MODE. Use one of these items to make picture color become more reddish. White balance can be adjusted between a maximum of +30 and a minimum of -30 for each color temperature.

R Gain (LO/HI)/G Gain (LO/HI)/B Gain (LO/HI)

Fine tuning the color temperature

To fine tune the color temperature, set "10 Point Setting" to "On".

You can adjust the "Position" setting. Adjust the set color temperature from +1 to +10.

White balance can be adjusted between a maximum of +30 and a minimum of -30 for each color temperature.

NOTE

- When "Position" is set to "10", you can adjust the white balance between -30 and 0.
- For resetting all adjustment items to the factory preset values, press ▲/▼ to select "Reset", and then press ENTER.

Example



(ENERGY STAR: Except for LC-90LE667U)

(For the UQ, TQ and SQ models.)



Picture Settings (Continue)

Active Contrast

Automatically adjusts the image contrast according to the scene.

Advanced: Produces higher contrast image especially in dark scene.

Standard: Produces high contrast image.

Off: No adjustment.

Gamma Adjustment

Adjusts the differences of picture tones between bright parts and dark parts. The adjustment range of the gamma can be set to a maximum of +2 and a minimum of -2 by pressing ◀ or ▶.

Film Mode (3:2 pull-down)

This function provides high-quality playback of images originally encoded at 24 frames/second, such as films.

Advanced: Adjusts effect to reduce judder from film contents. You can select a desired level of judder reduction from 0 to +10.

Standard: Plays back images with equal display time for each frame, reproducing movie theater experience.

Off: Normal viewing mode.

NOTE

- "Film Mode" does not function depending on input signal type.
- "Film Mode" does not function when you set AV MODE to "VINTAGE MOVIE" MODE, "GAME" or "PC".
- "Standard" does not function depending on input signal type.

Digital Noise Reduction

Produces a clearer video image.

Auto: Automatically adjusts the level of noise reduction.

High/Middle/Low: You can select a desired level for viewing a clearer video image.

Off: No adjustment.

NOTE

- "Digital Noise Reduction" is not available when you set AV MODE to "PC" or PC format is being input.
- When AV MODE is set to "GAME", "AUTO" is not available.

Color Gamut Range (for the UQ17U, TQ15U, SQ17U, SQ15U, SQ10U and EQ10U models)

You can set the color gamut range.

Standard: Standard color gamut.

Expanded: More vivid colors with expanded color gamut.

NOTE

- "Color Gamut Range" is only available when AV MODE is set to "MOVIE" or "MOVIE (3D)".

Example



(ENERGY STAR: Except for LC-90LE667U)

(For the UQ, TQ and SQ models.)



Picture Settings (Continue)

Lamp Swing Effect (for the UQ17U, TQ15U, SQ17U, SQ15U, SQ10U and EQ10U models)

Available only when AV MODE is set to "VINTAGE MOVIE" MODE. When this function is enabled, the lamp light looks like it is swinging. You can adjust the effect level between 0 and +3.

Monochrome

For viewing a video in monochrome.

Game Type (for the UQ17U, TQ15U, SQ17U, SQ15U, SQ10U and EQ10U models)

You can adjust picture quality according to the type of the game you are playing.

Standard: Optimizes picture quality for standard video games.

High Motion: Optimizes picture quality for high motion video games.

NOTE

- "Game Type" is not available depending on the input signal type.
- "Game Type" is only available when AV MODE is set to "GAME" and "Resolution Enhanced" is set to "OFF".

Black Level

Adjusts on-screen black level to your preferred level.

High: The black level gets brighter.

Low: The black level gets darker.

NOTE

- "Black Level" is available for input signal from Composite Video, Component 480i and analog broadcasts (air and cable).

Light Sensor Adjustment

The brightness level range of the Light Sensor's automatic adjustments can be set according to your preferences. The adjustment range of the Light Sensor can be set to a maximum of +16 and a minimum of -16.

Max.: -15 through +16

Min.: -16 through +15

NOTE

- The "Light Sensor Adjustment" settings are active only when "Automatic Light Sensor" is set to "On".
- The maximum setting cannot be set to a smaller number than the minimum setting.
- The minimum setting cannot be set to a bigger number than the maximum setting.
- Depending on the brightness of the surrounding light, the Light Sensor might not operate if the adjustment range is small.

Reset

Returns Picture Settings to their factory preset values. To reset, select "YES" and then press **ENTER**.

Example

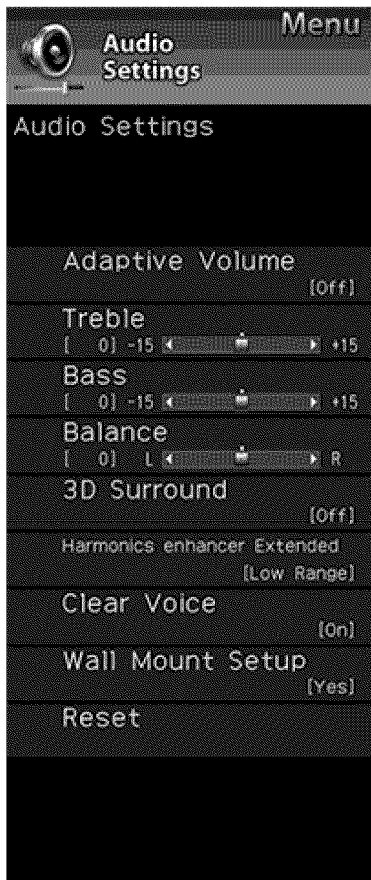

Audio Settings

You can adjust the sound quality to your preference with the following settings.

NOTE

- For operating the on-screen display menu, see page 4-3.

Selected item	◀ button	▶ button
Treble	For weaker treble	For stronger treble
Bass	For weaker bass	For stronger bass
Balance	Decrease audio from the right speaker	Decrease audio from the left speaker

NOTE

- The Audio menu is grayed out when "Output Select" is set to "Variable". (See page 4-20.)
- For resetting Audio adjustment items to the factory preset values, press ▲/▼ to select "Reset", press **ENTER**, press ▲/▼ to select "Yes", and then press **ENTER**.

Adaptive Volume

Different sound sources sometimes do not have the same loudness level, such as a program and its commercial breaks. The Automatic Volume Control(Auto Volume) reduces this problem by equalizing.

ON: Reduces the loudness gaps among different sound source. The result is automatically adjusted according to the sound sources.

OFF: No adjustment.

Surround (For SQ10U, EQ10U, LE650U, C6500U and LE642U models)

The surround function produces Surround effect from the speakers.

NOTE

- The Audio Settings menu is grayed out when "Output Select" is set to "Variable". (See page 4-20.)
- For some discs, setup may be required on your BD/DVD player. In this case, please refer to the operation manual of your BD/DVD player.

Example

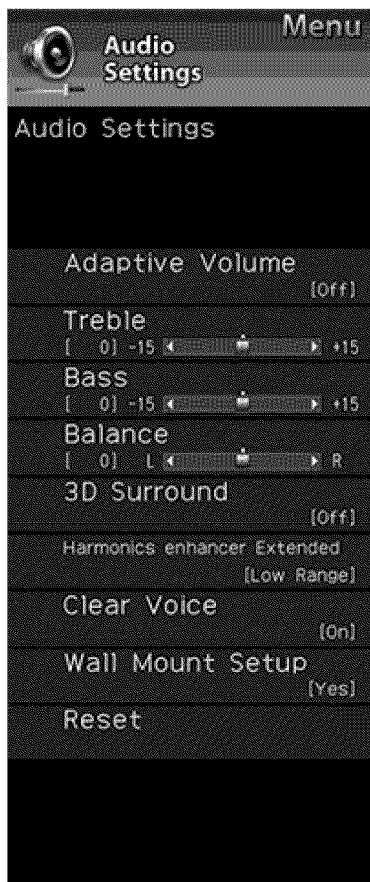

Audio Settings (Continue)

3D Surround (for the UQ17U, TQ15U, SQ17U, SQ15U and LE657U models)

The surround function produces Surround effect from the speakers.

3D Stadium: Reproduces lifelike experience of excitements such that live sports or concert performances in a stadium create.

3D Hall: Reproduces concert hall experience with realistic live surround sound using measured reverberant sound in the concert hall.

3D Movie: Reproduces movie theater experience with realistic live surround sound using measured reverberant sound in the movie theater.

3D Standard: Creates 3 dimensional surround sound with detailed control of the signal phase.

Normal: Provides mild surround sound.

Off: Outputs the normal sound.

NOTE

- The Audio Settings menu is grayed out when "Output Select" is set to "Variable". (See page 4-20.)
- For some discs, setup may be required on your BD/DVD player. In this case, please refer to the operation manual of your BD/DVD player.

Harmonics Enhancer Extended

This function improves the sound quality by extending the selected range.

All Range: The low range will be extended and the sounds in the medium and high ranges, which have been lost due to the data being compressed, will be restored.

This setting is effective when playing back audio through a wireless interface such as when using Bluetooth playback.

Low Range: The low range will be extended.

Off: No adjustment.

Clear Voice

This function emphasizes speech against background noise for greater clarity.

NOTE

- The Audio Settings menu is grayed out when "Output Select" is set to "Variable". (See page 4-20.)

Wall Mount Setup

This selects the optimal audio for the program you are currently watching even when the TV is mounted to a wall.

Reset

Returns Audio Settings to their factory preset values. To reset, select "YES" and then press **ENTER**.

Example



Setup

NOTE

- For operating the on-screen display menu, [see page 4-3](#).
- When you select "Easy Setup", "CH Setup", "Parental Control" or "Reset", you can enter the 4-digit secret number here. [See page 4-21](#) for setting a secret number.

Language

You can also select a language from the Setup menu. Select from among 3 languages: English, French and Spanish.

NOTE

- To change the language of the manual, select "MENU" > "Setup" > "Language" to change the language. Then, press **MANUAL** again.

Easy Setup

You can run Easy Setup again, even after setting up the preset channels.

Language: Select from among 3 languages (English, French and Spanish).

Location & Time: Make settings for the country, area and time zone where you use the TV.

Select your country: Select either "United States", "Canada" or "Mexico".

Select your time zone: Select your time zone. The available settings differ depending on the selected country.

Select DST (Daylight Savings Time): Select "Auto", "Manual" or "Off".

TV Location: Select "Home" or "Store" for the location where you plan to install the TV. This product qualifies for ENERGY STAR*1 in Home mode default setting.

Home: "Power Saving" is set to "Advanced", and AV MODE is set to "STANDARD (ENERGY STAR)*1".

Store: "Power Saving" is set to "Off" and AV MODE is set to "DYNAMIC (Fixed)". Picture Reset and Feature Demo can be set.

Picture Reset: AV MODE will be set to "DYNAMIC (Fixed)" regardless of whether Picture Reset is "On" or "Off". If you select "On", AV MODE will be reset to "DYNAMIC (Fixed)" if there is no operation for 30 minutes. When "Off" is selected, AV MODE will be set to "DYNAMIC (Fixed)".

*1: Except for LC-90LE657U

Example



Setup (Continue)

Feature Demo: When "On" is selected, after all the settings are completed, the Feature Demo screen is displayed if there is no operation for several minutes.

- ENERGY STAR qualification is based on AV MODE "STANDARD (ENERGY STAR)*1".

Antenna & Cable/STB: Select the type of connection you will use to watch TV.

Air/Cable: Make sure what kind of connection is made with your TV when selecting "Air" or "Cable".

CH Search: Channel auto search makes the TV look for all channels viewable in the set area.

- If "Cable" is selected for Antenna setting, scrambled channels are removed after the Channel search has been completed.

Smart TV: When you connect to the Internet on the TV, confirm the connection method and make adjustments.

- Wireless LAN connection is possible only when the WPS (push button) method is used. If any other method is used, make settings by Smart TV > Internet Setup > Internet Connection.
(See pages 9-2 to 9-4.)

Completed: The settings confirmation screen is displayed. Confirm the information displayed on the screen.

NOTE

- *1: Except for LC-90LE657U
- See Initial Installation on pages 2-2 to 2-7 for setting each item.
- If no channel is found, confirm the type of connection made with your TV and try "Easy Setup" again.
- If you select "Analog Search Start" and initiate the channel search, the CH Memory for Cable Digital will be deleted.

TV Channel Setup

CH Setup

If Initial Installation does not memorize all the channels in your region, follow the instructions below to manually memorize the channels.

Air/Cable: Make sure what kind of connection is made with your TV when selecting "Air" or "Cable".

CH Search: Channel auto search makes the TV look for all channels viewable in the set area.

CH Memory: You can select the channels to skip in each ANALOG (Air), ANALOG (Cable), DIGITAL (Air) and DIGITAL (Cable).

On: Skips channels. (Channel selection disabled using CH )

Off: Does not skip channels. (Channel selection enabled using CH )

Remove Scrambled CH: This function makes the TV look for and then delete digital cable channels that are scrambled and so unavailable in the set area. The process may take more than 20 minutes.

Yes: Starts to remove scrambled channels.

No: This function does not work.

NOTE

- See Initial Installation on pages 2-2 to 2-7 for setting each item.
- If no channel is found, confirm the type of connection made with your TV and try channel search again.
- If you select "Analog Search Start" and initiate the channel search, the CH Memory for Cable Digital will be deleted.

Example



Setup (Continue)

Favorite CH (Favorite Channel Setting)

This function allows you to program 4 favorite channels, in 4 different categories. By setting the favorite channels in advance, you can select your favorite channels easily.

To register your favorite channel:

Select "Register" and then press **ENTER**. Press ▲/▼/◀/▶ to select the position in the category, and then press **ENTER** to register.

To delete your favorite channel:

Select "1 Data Clear" and then press **ENTER**. Press ▲/▼/◀/▶ to select the channel you want to delete, and then press **ENTER**. Select "Yes" and then press **ENTER**.

To delete all the favorite channels, select "All Data Clear".

NOTE

- Before setting the channel, select the channel you want to register as a favorite channel.
- You can display the "Favorite CH" screen by pressing **FAVORITE CH** on the remote control.

Antenna Setup-DIGITAL

In order to receive digital air broadcasts, you need a digital broadcast antenna. You can confirm the antenna configuration through the "Antenna Setup-DIGITAL" screen. If necessary, adjust the direction of the antenna to obtain the maximum signal strength.

Signal Strength: The signal strength of DIGITAL channel is displayed. The signal information is based on the current channel.

Channel Strength: Input the 2-digit channel number to check the signal strength of the selected channel. Make sure the signal is strong enough for each channel.

- This function is available for DIGITAL (Air) only.

Example



Setup (Continue)

Parental Control
(Parental Control Setting)

V-Chip

V-CHIP is an electronic filtering device built into your TV. This tool gives parents a great degree of control over broadcasts accessed by their children. It allows parents to select programs judged suitable for child viewing while blocking ones judged not suitable. It does so automatically once you activate the V-CHIP feature in your TV. "V-Chip" and "Status" will not be selectable from the menu if you do not first configure your secret number.

- The U.S. has two rating systems for viewing content: TV Parental Guidelines and movie ratings.
- The TV Parental Guidelines work in conjunction with the V-CHIP to help parents screen out inappropriate television shows from their children.
- Movie ratings are used for original movies rated by the Motion Picture Association of America (MPAA) as watched on cable TV and not edited for television. The V-CHIP can also be set to block MPAA-rated movies.

NOTE

- The setting automatically enters "Block" for any ratings below your selection.
- If Status is not set to "On", the configuration settings will not work.

MPAA (Voluntary movie rating system) Example

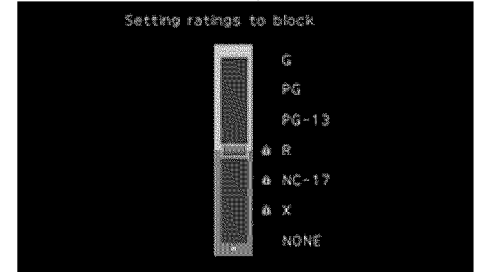

Press ▲/▼ to adjust the item to your desired position. "■" indicates the item is blocked. Press **MENU** to exit.

G: General audiences. All ages admitted.

PG: Parental guidance suggested. Some material may not be suitable for children.

PG-13: Parents strongly cautioned. Some material may be inappropriate for children under 13.

R: Restricted. Under 17 requires accompanying parent or adult guardian (age varies in some jurisdictions).

NC-17: No one 17 and under admitted.

X: X is an older rating that is unified with NC-17 but may be encoded in the data of older movies.

NOTE

- Voluntary movie rating system only uses an age-based rating.

Example



Setup (Continue)

TV Parental Guidelines

Example

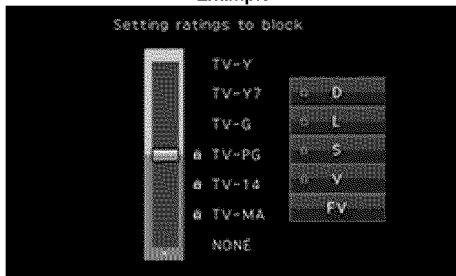

Suggested age

TV-Y: All children.

TV-Y7: Directed to older children.

TV-G: General audience.

TV-PG: Parental Guidance suggested.

TV-14: Parents strongly cautioned.

TV-MA: Mature audience only.

When setting an individual content-based rating item:

- 1 Press **▶** or **ENTER** to access blocked content items from the currently selected age-based rating item.
- 2 Press **▲/▼** to select an individual item, and then press **ENTER** to unblock it ("Ⓜ" is removed). Repeat the same steps for the other items.
- 3 Press **◀** or **RETURN** to register after all individual content rating items are set.

Content

FV: Fantasy violence.

V: Violence.

S: Sexual situation.

L: Adult language.

D: Sexually suggestive dialog.

Rating	Content					
	FV	V	S	L	D	
Suggested age	TV-Y	Ⓜ	Ⓜ	Ⓜ	Ⓜ	Ⓜ
	TV-Y7	×	Ⓜ	Ⓜ	Ⓜ	Ⓜ
	TV-G		Ⓜ	Ⓜ	Ⓜ	Ⓜ
	TV-PG		×	×	×	×
	TV-14		×	×	×	×
TV-MA		×	×	×		

Ⓜ : The content rating can be set, but this rating is not normally broadcast by TV stations.

× : Content rating can be set.

Canadian Rating Systems (Canadian English ratings and Canadian French ratings)

- The TV rating systems in Canada are based on the Canadian Radio-Television and Telecommunications Commission (CRTC) policy on violence in television programming.
- While violence is the most important content element to be rated, the structure developed takes into consideration other program content like language, nudity, sexuality and mature themes.
- When setting the V-CHIP on the Canadian system you can choose either the Canadian English ratings or the Canadian French ratings.

Example



Setup (Continue)

Canadian English Ratings

- E:** Exempt: Includes news, sports, documentaries and other information programming; talk shows, music videos, and variety programming.
- C:** Children: Intended for younger children under the age of 8 years. Pays careful attention to themes that could threaten their sense of security and well-being.
- C8+:** Children over 8 years old: Contains no portrayal of violence as the preferred, acceptable, or only way to resolve conflict; nor encourage children to imitate dangerous acts which they may see on the screen.
- G:** General: Considered acceptable for all age groups. Appropriate viewing for the entire family, contains very little violence, physical, verbal or emotional.
- PG:** Parental Guidance: Intended for a general audience, but may not be suitable for younger children (under the age of 8) because it could contain controversial themes or issues.
- 14+:** Over 14 years: Could contain themes where violence is one of the dominant elements of the storyline, but it must be integral to the development of plot or character. Language usage could be profane and nudity present within the context of the theme.
- 18+:** Adults: Intended for viewers 18 years and older and might contain depictions of violence, which while related to the development of plot, character or themes, are intended for adult viewing. Could contain graphic language and portrayals of sex and nudity.

Canadian French Ratings

- E:** Exempt programming.
- G:** General: All ages and children, contains minimal direct violence, but may be integrated into the plot in a humorous or unrealistic manner.
- 8ans+:** General but inadvisable for young children: May be viewed by a wide public audience, but could contain scenes disturbing to children under 8 who cannot distinguish between imaginary and real situations. Recommended for viewing with parent.
- 13ans+:** Over 13 years: Could contain scenes of frequent violent scenes and therefore recommended for viewing with parent.
- 16ans+:** Over 16 years: Could contain frequent violent scenes and intense violence.
- 18ans+:** Over 18 years: Only for adult viewing. Could contain frequent violent scenes and extreme violence.

How to temporarily release the V-CHIP BLOCK

When the V-CHIP BLOCK is working and censors a broadcast, "V-CHIP HAS BEEN ACTIVATED." displays.

- 1 Press **ENTER** while the V-CHIP is working, and then the secret number setting menu displays.
- 2 Input the 4-digit secret number by using **0-9**. At this time V-CHIP BLOCK temporarily releases.

Example

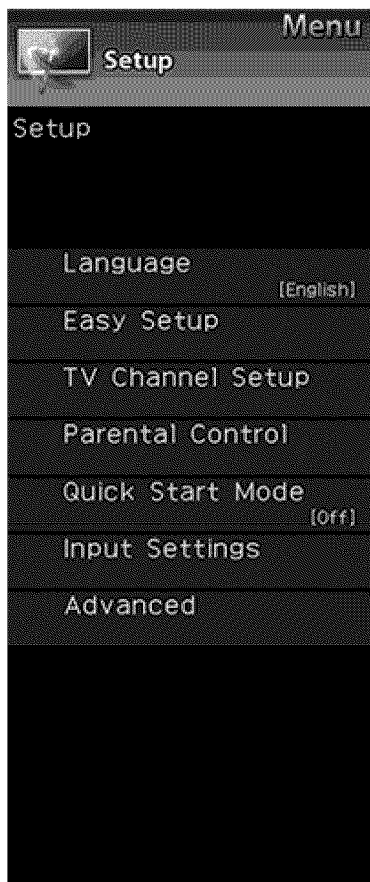

Setup (Continue)

Reactivating the temporarily released V-CHIP BLOCK
You can reactivate the temporarily released V-CHIP BLOCK as shown below.

- Select "Status" setting from the Parental Control menu to reactivate BLOCK.
- Select "V-Chip" setting ("MPAA", "TV Guidelines", "Can. English Ratings" or "Can. French Ratings") from the Parental Control to reactivate BLOCK. [\(See pages 4-16 to 4-18.\)](#)
- Switch off the TV power.

NOTE

- Performing any of the three above will activate the V-CHIP BLOCK.

Status

Used to enable or disable the parental control function. This function will not be selectable from the menu if you do not first configure your secret number.

Quick Start Mode

When this function is activated, you can reduce the TV's start-up time or even let the TV in standby mode start displaying images and so on via the connected equipment on the network.

NOTE

- Setting "Quick Start Mode" to "On" consumes more power.

Input Settings

HDMI Setup - Auto View

When you view images sent from external equipment in an HDMI connection, this function allows the image size on the TV to automatically switch to an appropriate one.

NOTE

- Refer to your external equipment operation manual for the signal type.
- When connecting a DVI-HDMI conversion adapter/cable to the HDMI IN terminal, the image may not come in clearly.

PC input

You can adjust the position of the image input from a PC the settings with "Setup" > "Advanced" > "PC input". [\(See page 8-1.\)](#)

Custom Input Label

Lets you set the input terminal displayed when using the INPUT list or channel display. Press **▲/▼/◀/▶** to select the new name for the input mode.

- Using the software keyboard, you can enter up to 10 characters for text.

[\(See page 9-5.\)](#)

NOTE

- You cannot change labels if the input source is TV, Home Network, USB, Screen Sharing or Bluetooth.

Example



Setup (Continue)

Input Skip

This setting allows you to skip the TV, HDMI or PC IN Input ("TV", "PC IN", "HDMI 1", "HDMI 2", "HDMI 3" and "HDMI 4") on the Input Selection operation.

NOTE

- If you connect external equipment to an HDMI IN terminal which you have set to be skipped, a notification message appears on the display when a signal is received from the connected external equipment. Press "Yes" to reset the related skipping setting so that the input terminal becomes available.

Advanced

3D Setup

You can make various settings to enhance 3D image viewing.

(See page 5-11, 5-12.)

Audio Setup

You can output digital audio to an AV amplifier or similar device whose DIGITAL AUDIO INPUT terminal is connected to the DIGITAL AUDIO OUT terminal on the TV. Please select an audio output format compatible with the audio format of the program you are watching and the equipment connected.

PCM: For connecting to equipment that does not support Dolby Digital and DTS. The same audio (main, sub, or main/sub) as the audio of the program being viewed is output.

2-channel audio with a sampling rate of 48 kHz or less is output as linear PCM audio.

Bitstream: For connecting to an audio system that supports Dolby Digital and DTS. Audio is output through both the main and sub channels.

NOTE

- Analog channel audio and video input audio are output in PCM mode even when "Bitstream" is selected.
- PCM digital input signals are output in PCM mode even when "Bitstream" is selected.

Audio Select

This function sets the terminal to output the computer audio. The adjustment items vary depending on the input source. Select the input source corresponding to the terminal connected to the PC and then adjust the desired item. To perform the operation, refer to "Setup" > "Advanced" > "Audio Select".

(See page 8-2.)

Output Select

Allows you to select what controls the audio output.

Fixed: Sound via speaker is adjusted with **VOL+/-** on the remote control unit or on the TV.

Sound via the AUDIO OUT terminal is not adjustable and outputs at a consistent level.

Variable: Sound via the AUDIO OUT terminal is adjusted with **VOL+/-** on the remote control unit or on the TV.

Sound via speaker is muted.

Example



Setup (Continue)

Color System

Select the video signal system compatible with your equipment from the list below:

Auto/NTSC/PAL-M/PAL-N

NOTE

- "Color System" can only be set for the VIDEO IN 1 or 2.
- If you have already set the Secret No., input the 4-digit secret number here.

AQUOS LINK Setup

Make the settings to use AQUOS LINK.

Set the settings with "Setup" > "Advanced" > "AQUOS LINK Setup".

(See page 7-2.)

DivX® Setup

This is the function to confirm your registration code.

You need to register the code at <http://www.divx.com>.

(See page 6-12.)

Secret No.

Allows you to use a secret number to protect certain settings from being accidentally changed.

IMPORTANT:

Three conditions must be met to enable the V-Chip

(see pages 4-16 to 4-19):

1. Secret No. is registered.
2. V-Chip/V-Chip (DTV Only) settings have been made.
 - The "V-Chip (DTV Only)" will only be selectable when a new rating system can be downloaded via digital broadcasting in the U.S.
3. "Status" is set to "On".

Setting Secret No.

You can set and change the secret number by using 0-9.

Yes: Changes or sets the Secret No.

No: The confirmation screen to clear the Secret No. appears when the Secret No. has been set. When the Secret No. has not been set, the previous screen will be displayed.

Delete Secret No.

You can clear your secret number.

Yes: Your secret number is cleared.

No: Your secret number is not cleared.

NOTE

- As a precautionary measure, make a note of your secret number and keep it in a familiar place.
- If the secret number is cleared, the Status setting automatically sets to "Off". "V-Chip" and "Status" will not be selectable from the menu.

Reset

If complex adjustments are made and the settings cannot be restored to normal, you can reset the settings to the factory preset values.

- If you have already set the Secret No., input the 4-digit secret number here.

NOTE

- The Channel Setup settings will not be changed.
- The Language settings will not be changed.
- The Secret number settings will not be changed.
- The TV Location settings will not be changed.

Example

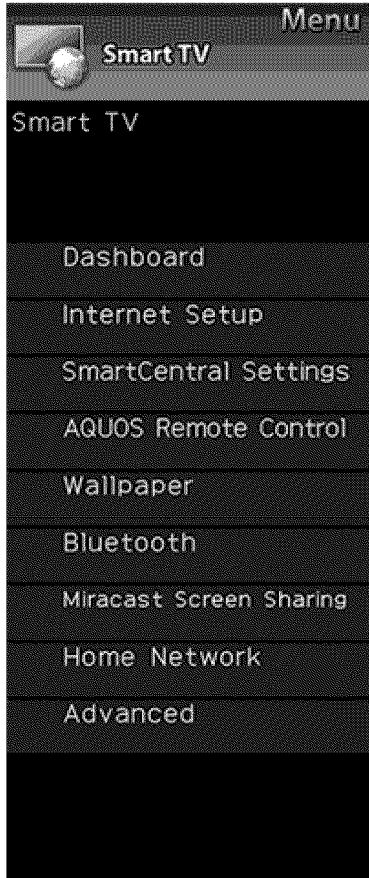

Smart TV

Dashboard

You can display a list of the main Smart TV settings.

Internet Setup

Configures LAN and Internet settings.

Internet Connection

You can connect your TV to the Internet using the setting item "Internet Connection".
(See page 9-2 to 9-4.)

Interactive Service

If you do not want other people to connect to the Internet in your absence, you can make settings to keep the TV away from the Internet.
(See page 9-4.)

SmartCentral Settings

Switch to the SmartCentral Settings screen.

AQUOS Remote Control

Set this function when operating the TV from equipment connected by LAN or wireless LAN.
(See page 8-3.)

Example

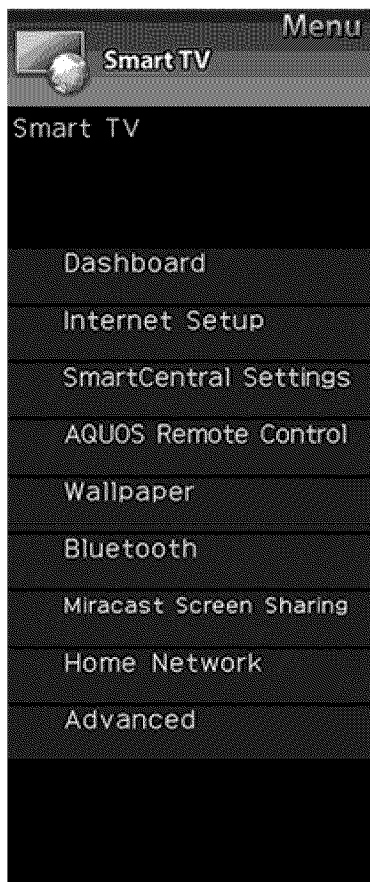

Smart TV (Continue)

Wallpaper

Activating the function will display still images when the TV is in standby mode.

Wallpaper Mode

Configures Wallpaper Mode settings.

Off: Nothing will be displayed.

Picture: Still images will be displayed when the TV is in standby mode.

Clock: The clock will be displayed when the TV is in standby mode.
Configure the clock settings. (For the UQ17U, TQ15U, SQ17U, SQ15U, SQ10U and EQ10U models)
(See page 4-24.)

NOTE

- The clock mode can only be used when a network connection has been established.
Finish configuring the network settings.
- After you set the time once, the clock will continue to operate even if you disconnect from the network.
However, you cannot switch the daylight saving time setting when disconnected from the network.

Data Source

For the wallpaper, you can select either the still images pre-installed in the TV or your favorite still images stored in the USB memory device.

Pre-Installed: The images pre-installed in the TV will be displayed in a slideshow.

USB: Your favorite images stored for the wallpaper will appear.
If only a single still image is stored in the USB memory device, that image will be displayed as the wallpaper.
When there are multiple still images in the memory, all the images will be displayed in a slideshow.

NOTE

- Images are displayed in 3-minute intervals as a slideshow.
- When the TV is in Wallpaper mode, you can turn off the TV by pressing and holding **POWER** on the TV for 5 seconds.
 - Just before the TV turns off, the last image shown when the TV was turned off appears briefly.
 - Your settings may not be saved in some cases.

When you display images by using the USB memory device:

- Create a folder named "WP" in the root directory of the USB memory device (the first directory when the USB memory device is opened), and store into the folder the still images you want to display for the wallpaper.
- You must insert the USB memory device into the USB terminal before turning off the TV.
- If there are images on the USB memory device but they do not appear on the screen, switch to USB mode and check whether the image files on the USB memory device are shown correctly.

Timer Setting

You can set the length of time the TV will remain in the Wallpaper Mode.

3 hours/6 hours/12 hours/24 hours

NOTE

- No buttons except for **POWER** work even while the still images are being displayed.
- If the ready-for-use USB memory device is not inserted, the still images pre-installed in the TV will be displayed in a slideshow even when "Data Source" is set to "USB".
- Because the USB memory device cannot be detected immediately after the TV is turned on from standby mode, the wallpaper pre-installed in the TV may be displayed even when "Data Source" is set to "USB".
- The still images will be displayed until the set time has elapsed.

Example



Smart TV (Continue)

Clock

Configures clock settings.

Set the type of clock to use in wallpaper mode.

Spring/Summer/Fall/Winter:A clock that represents the corresponding season will be displayed.

Random:A randomly selected clock from among the four types will be displayed.

Bluetooth (For the UQ17U, TQ15U, SQ17U, SQ15U, SQ10U and LE637U models)

Set this function when using the bluetooth devices with your TV.

See [page 9-11,10-1](#) for how to use the devices.

NOTE

- When you use the Bluetooth device with your TV for the first time, you must make pairing between the device and the TV. Once the pairing is correctly carried out, the Bluetooth device will be registered on the TV.

Keyboard Setting/Mouse Setting/Other devices Setting

You can add, delete or select Bluetooth devices in the registration.

Other devices Setting can only be used with the UQ17U, TQ15U, SQ17U, SQ15U, and SQ10U.

Addition of a Bluetooth Device

Before making the settings, press the Connect button on the Bluetooth device you want to connect.

- 1 Press **↩** to select "Search", and then press **ENTER**.
- 2 Model names of the detected devices will be displayed. Select the device with the message "New" attached, and then press **ENTER**.
 - When a keyboard is being paired with the TV, a PIN code will be displayed. Enter the PIN code using the keyboard, and then press "Enter" key on the keyboard.
 - When you perform pairing operation on a mouse, select "Yes", and then press **ENTER**.
- 3 After the message indicating the pairing is complete has been displayed, click "OK".

Example



Smart TV (Continue)

Deletion of a Bluetooth Device

- 1 Press ▲/▼ to select the device to delete, and then press **ENTER**.
- 2 Press ▲/▼ to select "Delete", and then press **ENTER**.

Selection of a Bluetooth Device

- 1 Press ▲/▼ to select the device to use, and then press **ENTER**.
- 2 Press ▲/▼ to select "Select", and then press **ENTER**.

NOTE

- See also the instruction manual supplied with the Bluetooth device.
- You can register up to 6 devices to the TV, but only one keyboard and mouse can be used at a time.
- If a device for which "Selected" is displayed does not operate properly, try searching and selecting the device again.
- The keyboard or mouse may not operate properly depending on the application being used.
- The Bluetooth device may not operate properly depending on the device being used.

Other Devices Setting

- Though up to six devices (smartphones) can be registered, only one can be used at a time.
- Repairing is required whenever you change the device being used.
- To have TV power turn on automatically when a playback signal is received from a paired device while TV power is off, set "Quick Start Mode" to "ON".

Miracast Screen Sharing (For the UQ17U, TQ15U, SQ17U, SQ15U, SQ10U and EQ10U models)

Connection Mode Setting

Configures Connection Mode settings.

PUSH Button Mode:The push button method will be used to establish connections.

PIN Code Mode:the PIN code method will be used to establish connections.

Wireless Channel Setting

Set preferred wireless channel for Miracast Connection

NOTE

- Depending on the connected device, different channels may be assigned.
- You can use the Wireless Channel setting to specify the preferred channel. Select "Auto" to select the optimum channel for the usage conditions.

Example



Smart TV (Continue)

Home Network

Make the settings for remote playback.
(See page 6-13.)

Advanced

SmartCentral Sounds

You can setting the volume of the SmartCentral sounds.
High/Medium/Low/Off: Setting the volume of SmartCentral sounds

NOTE

- If an external speaker is used, the operation sound will not be heard.
- This setting is only valid in SmartCentral.

TV Name Setting

Set this function when operating the TV from equipment connected by LAN or wireless LAN.
(See page 8-3.)

Netflix Help

You can deactivate the Netflix function. Refer to "Information" > "Netflix Help" and select "Deactivate".
(See page 9-13.)

VUDU Help

To deactivate the VUDU function, refer to "Information" > "VUDU Help" and select "Yes".
(See page 9-13.)

Example

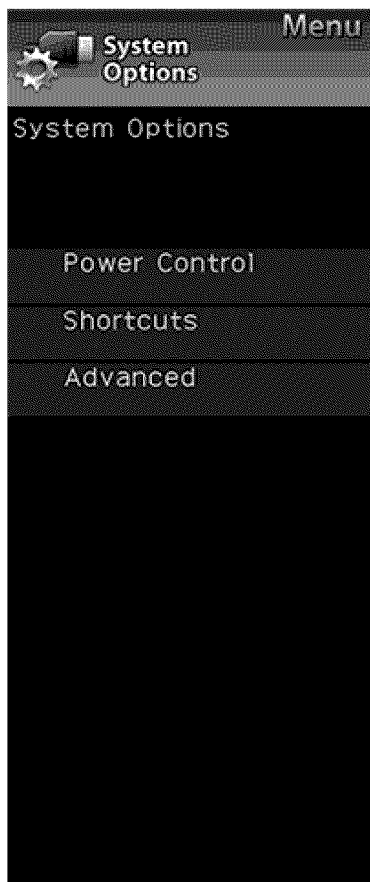

System Options

NOTE

- For operating the on-screen display menu, [see page 4-3](#).

Power Control

Power control setting allows you to save energy.

Audio Only

When listening to music from a music program, you can turn the screen off and enjoy audio only.

NOTE

- The screen image will return to normal when a button (except those for audio adjustment, such as **VOL**, **MUTE**) is pressed.

Power Saving

This function allows you to set the Power Saving level in order to decrease the power consumption and increase the backlight lifespan.

Standard: Optimizes power reduction based upon video content. When set to "Standard", "🔋" appears on the screen.

Advanced: Optimizes power reduction based upon video content and engages Light Sensor. When set to "Advanced",

"🔋" appears on the screen.

Off: This function does not work.

NOTE

- "Power Saving" does not function when you set AV MODE to "AUTO" or "DYNAMIC (Fixed)".

- You cannot select a different Power Saving item for each AV MODE.

When "Power Saving" is set, the "Automatic Light Sensor" settings for all AV Modes will automatically change.

- If you set "Automatic Light Sensor" to "On" when "Power Saving" is set to "Standard", then the "Power Saving" setting will change to "Advanced".

- When you change the "Power Saving" setting from "Advanced" to "Off" or to "Standard", "Automatic Light Sensor" will be set to "Off".

- "AUTO" and "DYNAMIC (Fixed)" will remain set to "Off".

- When "Power Saving" is set to "Standard" or "Advanced", the Power Saving leaf icon appears to the left of "Automatic Light Sensor" in the Picture Settings menu screen.

- "Power Saving" is not available when the TV is in 3D mode. (For the UQ17U, TQ15U, SQ17U, SQ15U and LE657U models)

No Signal Off

When this function is enabled, the TV automatically shuts down if no signal is received for more than 15 minutes.

NOTE

- When it is 5 minutes before the power shuts down, the remaining time will start to keep appearing every minute.
- When a TV program finishes, this function may not operate.

No Operation Off

When you enable this function, the TV automatically shuts down if no operation is performed for more than 3 hours.

NOTE

- When it is 5 minutes before the power shuts down, the remaining time will start to keep appearing every minute.

Example

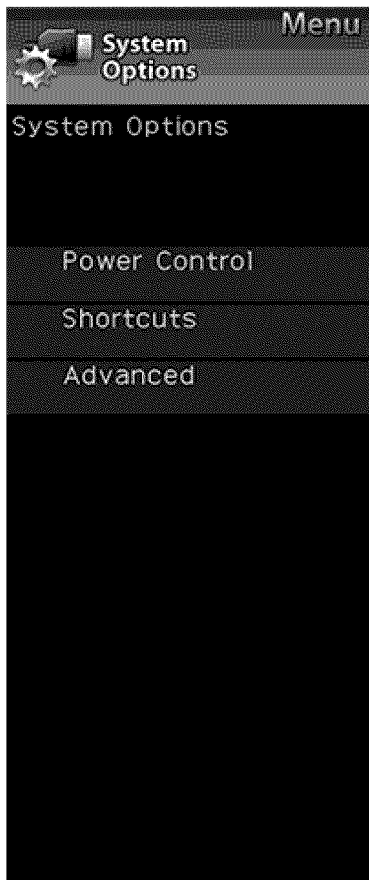

System Options (Continue)

Shortcuts

These functions are useful for adjusting the audio and video settings. The Shortcuts functions can be operated with the remote control unit.

SmartCentral Home

Displays the SmartCentral home screen.

App Dock

The application window can be displayed by selecting "App Dock" on the MENU screen.

NOTE

- You can display the application window by pressing **SmartCentral** on the remote control unit. (See page 3-6.)

USB Operation Panel

Displays the USB Operation Panel.

Home Network Operation Panel

Displays the Home Network Panel.

View Mode

This function changes the screen size. Select "Shortcuts" on the menu to display the View Mode menu screen. The View Mode menu varies depending on the input source.

NOTE

- You can select View Mode by pressing **VIEW MODE** on the remote control unit.
 - See pages 3-14 and 3-15 for adjusting the video being input from a TV, other audiovisual equipment, USB-Video, Home Network Video or Internet applications.
 - See page 3-16 for adjusting the video being input from a PC.

Freeze

Allows you to capture and freeze a moving image that you are watching.

NOTE

- You can select Freeze by pressing **FREEZE** on the remote control unit.
 - See page 3-4 for details of Freeze function.

Example

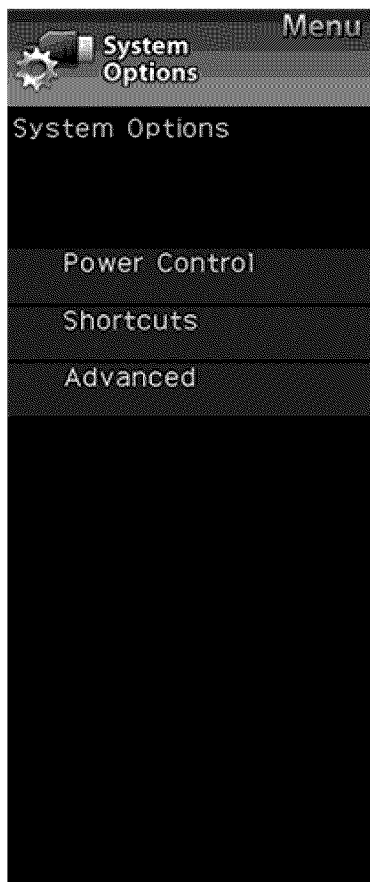

System Options (Continue)

Change Audio

Allows you to change the audio when multiple audio is available for the program you are watching.

NOTE

- You can change Audio by pressing **AUDIO** on the remote control unit.
[See page 3-8](#) for details of Audio function.

Change CC

Allows you to change the Closed Caption display. Select "Change CC" on the menu to display the Closed Caption information.

- The information displayed varies depending on the program you are watching.

NOTE

- You can change Closed Caption by pressing **CC** on the remote control unit.
[See pages 3-12 to 3-13](#) for details of Closed Caption function.

Advanced

Menu Design

Configures Letter and Caption screen display settings.

Channel Changing Effect

You can select whether to use transition effects when changing channels.

NOTE

- In some cases, "Channel Changing Effect" does not work.

Program Title Display

Select the CH display when changing channels for digital broadcasting.

Position

For adjusting a picture's horizontal and vertical position.

H-Pos.: Centers the image by moving it to the left or right.

V-Pos.: Centers the image by moving it up or down.

NOTE

- For resetting adjustments to the factory preset values, press **▲/▼** to select "Reset", and then press **ENTER**.
- When connecting a PC to the HDMI IN terminal, the image position will be automatically adjusted. It cannot be manually adjusted.
- The screen position variable ranges depend on the View Mode or the signal type. The ranges can be seen on the position-setting screen.
- Adjustments are stored separately according to input source.
- "Position" does not work when USB mode, Home Network mode or an Internet application is used.
- You may not be able to adjust the position while in 3D mode. (For the UQ17U, TQ15U, SQ17U, SQ15U and LE657U models)

Example

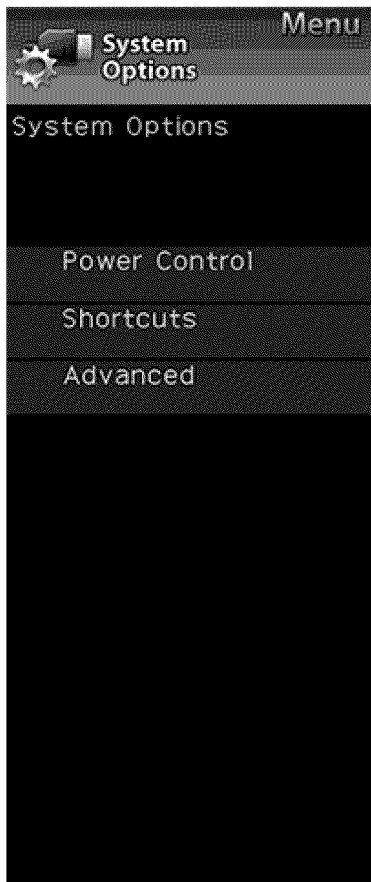

System Options (Continue)

Caption Setup

This function allows you to adjust the closed caption screen appearance to suit your preference.

Caption Size/Font Style/Foreground Color/Foreground Opacity/Background Color/Background Opacity/Character Edge

NOTE

- For resetting adjustments to the factory preset values, press ▲/▼ to select "Reset", and then press **ENTER**.
- The default value depends on the broadcasting station.

Startup Screen

With this function activated, the SHARP logo will be displayed when you turn on the TV.

NOTE

- This function is not available when the TV is set to "Quick Start Mode".

Demo Mode

You can select the image from several types of demo mode.

NOTE

- What kinds of setting item are available depends on the model of your TV.
- This function will be canceled when you press **EXIT** on the remote control unit.
- "Demo Mode" may not be selected depending on input signal type or application status.
- "Demo Mode" may be automatically canceled depending on input signal type.

Example

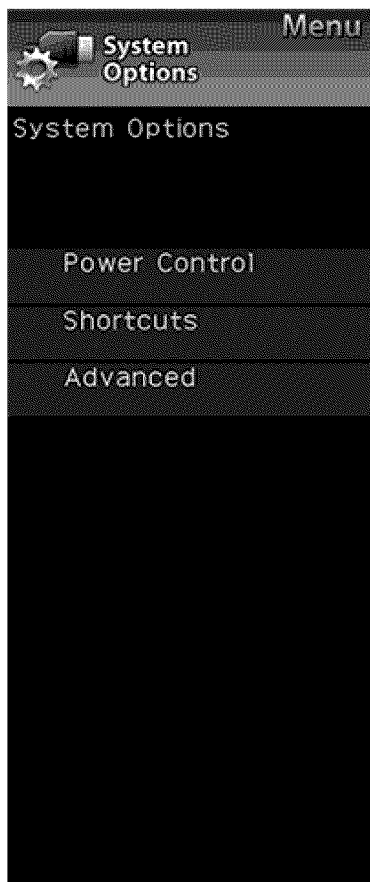

System Options (Continue)

Front Indicator Light

When this function is set to "On", the LED on the front of the TV turns on.

UQ17U, TQ15U, SQ17U, SQ15U and LE657U models

- The LED lights white in 2D mode.
- The LED lights blue in 3D mode.

NOTE

- "On" is the factory preset value. If you want to turn off the LED, set the function to "Off".

Game Play Time

This function will enable the TV to display the elapsed time every 30 minutes, so that you do not become too absorbed in game playing to keep track of time.

Switch AV MODE to "GAME" to activate the function.

Operation Lock-Out

This function locks the operation buttons on the TV and the remote control.

Off: No adjustment.

RC Control Lock: All buttons on the remote control are locked.

Button Control Lock: All buttons on the TV, except **POWER**, are locked.

When "RC Control Lock" or "Button Control Lock" is selected, a confirmation screen appears.

Yes: Locks the operation buttons.

No: No adjustment.

NOTE

- To unlock the buttons on the remote control by using the control panel of the TV (see page 4-4):
 - ① Press **MENU** to display the MENU screen, press **VOL+/-** to select "System Options", and then press **INPUT**.
 - ② Press **CH/VW** to select "Operation Lock Out", and then press **INPUT**.
 - ③ Press **CH/VW** to select "Off", and then press **INPUT**.
 - ④ Press **MENU** to exit.
- To unlock the buttons on the TV, press **MENU** on the remote control, and then select "Off" in "Operation Lock Out".

Example

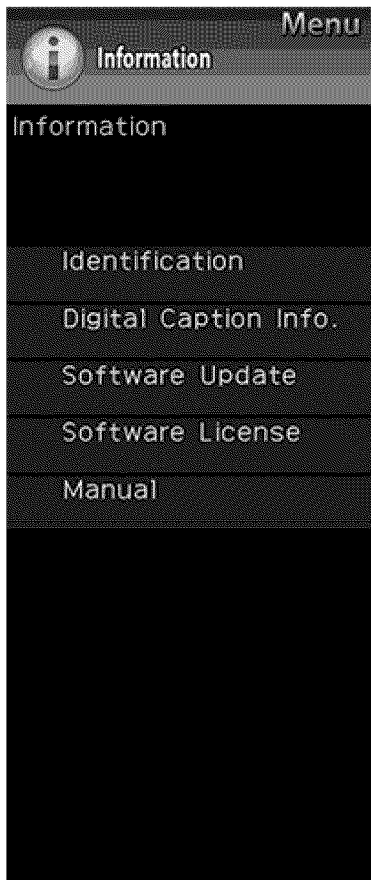

Information

NOTE

- For operating the on-screen display menu, [see page 4-3.](#)

Identification

The current version of the TV software is displayed.

Digital Caption Info. (Digital Caption Information)

This function allows viewing of digital closed caption information for the digital broadcast program being viewed.

NOTE

- This list is not displayed for analog broadcasts or external input audio/video.
- This information is not included in CC1, CC2, Text1, or Text2, and is not displayed in a list.

Software Update

This is used to upgrade the system software to enhance the TV functions.

- 1 Press **MENU** to display the MENU screen, and then press **◀▶** to select "Information".
- 2 Press **▲/▼** to select "Software Update", and then press **ENTER**.
 - If you have already set the Secret No., go to step 3.
- 3 Input the 4-digit secret number by using **0-9**.
- 4 Press **▲/▼** to select "Manual Update" or "Auto Update Setting", and then press **ENTER**.
 - The operations thereafter vary depending on the setting.

Auto Update Setting

When the TV is on, or when an Internet application is being accessed, this function enables the TV to connect to the network and check for updates automatically. When an update is available, a message is displayed. Press **◀▶** to select "Yes", and then press **ENTER** to display the download screen. ([See page 4-34.](#))

NOTE

- This function does not work when a broadband connection or Internet Setup is not available.
- A message may also be displayed when an application is running. The message varies depending on the application.

Manual Update

Select the method for manually updating the software.

USB Update: Updates the software using a USB memory device containing the update file. (See "Updating the Software with a USB Memory Device".)

Network Update: Downloads the update file via the network and then updates the software. ([See page 4-34.](#))

NOTE

- A broadband connection and Internet Setup are required to update the software using the network. ([See pages 9-2 to 9-4.](#))
- It may take time to access and download the update depending on the Internet connection and other factors.

Updating the Software with a USB Memory Device

To check for the availability of a software update, visit <http://www.sharpusa.com/products/support/>. If you have any questions, please call 1-800-BE-SHARP (800-237-4277).

Example

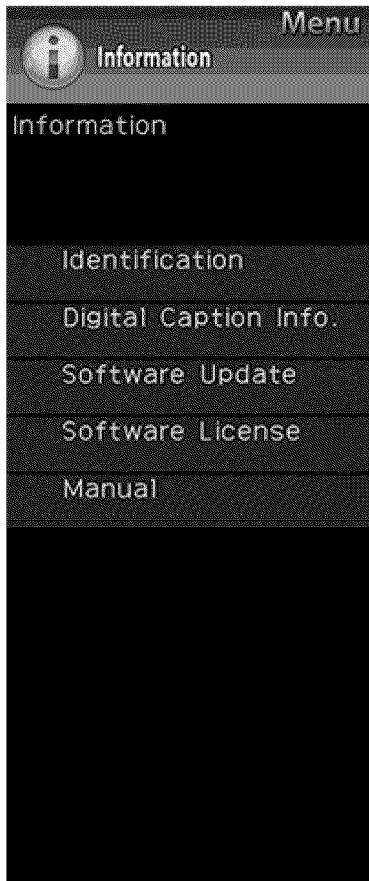

Information (Continue)

CAUTION

- Do not remove the USB memory device or unplug the AC cord while the software is being updated.
- Be sure to properly follow the whole procedure described below, step by step. Otherwise, for example, the TV cannot read the data in the USB memory device and software updating will fail.

1 Insert the USB memory device with the update file into the USB 1 or USB 2 terminal on the TV.

- When you update the software, use only one USB terminal. Either USB 1 or USB 2 is usable.

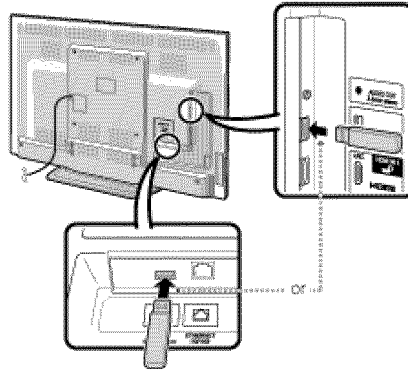

- 2 Press ▲/▼ on the Manual Update screen to select "USB Update", and then press **ENTER**.
- 3 Press **ENTER** to start checking the data in the USB memory device.



- 4 During the data checking, "Checking" blinks.
 - The current version of the TV software and the version of the update file on the USB memory device are displayed.
 - If the USB memory device is not properly installed or the correct update file cannot be found on the USB memory device, an error message is displayed. Check the file on the USB memory device, and then reinsert the USB memory device correctly.

Example

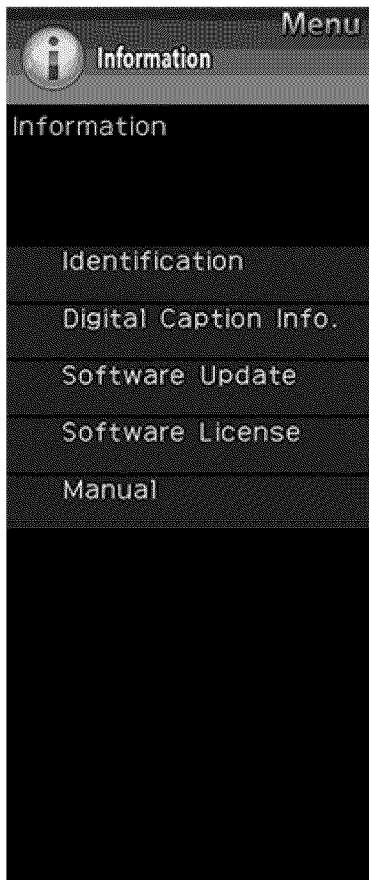

Information (Continue)

5 To update the TV software with the update file, select "Yes", and then press **ENTER**.

CAUTION

- Do not remove the USB memory device or unplug the AC cord while the software is being updated.

6 When the software is successfully updated, a screen is displayed indicating that the update process is completed.

After this screen is displayed, the TV automatically turns off and then turns on again.

- If the update has failed, check the file in the USB memory device and try Software Update again.

7 After the screen shown below is displayed, press **ENTER**.



8 Remove the USB memory device.

Updating the Software via the Network

1 Press **▲/▼** on the Manual Update screen to select "Network Update", and then press **ENTER**.

- The TV connects to the network and checks for updates.
- To cancel, press **ENTER**.

2 The current version of the TV and the latest version of software are displayed. To update the TV software, select "Yes", and then press **ENTER**.

- When a server connection cannot be established or an update is not available, a message is displayed. If a server connection cannot be established, check the broadband connection and Internet Setup.

3 After the update file is downloaded, the software update process begins.

CAUTION

- Do not unplug the AC cord while the software is being updated.

4 When the software is successfully updated, a screen is displayed indicating that the update process is completed.

A screen indicating that the update is completed is displayed. 4 seconds later, the TV restarts automatically.

- If the software was not updated successfully, check the broadband connection and Internet Setup, and then try updating the software again.

Software License

Displays software version information.

Manual

Displays the built-in operation manual on the screen. You can read information about how to use this device.

Enjoying 3D Image Viewing (For the UQ17U, TQ15U, SQ17U, SQ15U and LE657U models)

Information

You can use special 3D Glasses to watch 3D-supported images on this TV.

- You can enjoy 3D movies on this TV by viewing the movie through SHARP 3D Glasses supplied with the TV or through optional 3D Glasses sold separately.
- To produce 3D images, liquid crystal shutters in the 3D Glasses alternately open and close imperceptibly fast to exactly match alternating left and right video images displayed by the TV.
- Not all consumers can experience and enjoy 3DTV. Some people suffer from stereo blindness which prevents them from perceiving the intended depth of 3D entertainment. Also, some people who watch 3D programming may experience initial feelings of motion sickness as they adjust to the picture. Others may experience headaches, eye fatigue or motion sickness. Some viewers might also experience epileptic seizures. Like a roller coaster, the experience is not for everyone.

CAUTION

- The 3D Glasses are precision equipment. Handle them with care.
- Improper use of the 3D Glasses or failure to follow these instructions can result in eye strain.
- If you experience dizziness, nausea, or other discomfort while viewing 3D images, immediately discontinue use of the 3D Glasses. Using the 3DTV with incompatible 3D broadcasts or software can make images appear blurry or create overlapping images.
- When viewing 3D images continuously, be sure to take a break periodically to prevent eye strain.
- If you are nearsighted or farsighted or have astigmatism or a different level of eyesight between the left and right eyes, you should take the necessary steps, such as wearing eyeglasses, to correct your eyesight before viewing 3D images. The 3D Glasses can be worn over eyeglasses.
- When viewing 3D images, keep the 3D Glasses horizontally level with the TV screen. If you tilt the 3D Glasses with respect to the TV screen, the images viewed by the left and right eyes may appear significantly different or images may appear overlapping.
- View 3D images at the appropriate distance from the TV screen. The recommended distance is three times the effective height of the TV screen.
Examples of recommended distances
90-inch screen: Approx. 11.2 ft (3.4 m)
80-inch screen: Approx. 9.8 ft (3.0 m)
70-inch screen: Approx. 8.5 ft (2.6 m)
60-inch screen: Approx. 7.2 ft (2.2 m)
Viewing should not be done closer than the recommended distance.

- Be careful of your surroundings when viewing 3D images. When you view 3D images, objects may appear closer or farther than they are. This may cause you to misjudge the distance and possibly result in injury if you accidentally hit the screen or surrounding objects.
- The 3D Glasses are not recommended for people aged less than 6.
- When children are viewing 3D images, be sure a parent or guardian is present. Monitor children viewing 3D images, and if they show signs of discomfort, immediately discontinue use of the 3D Glasses.
- People with a known history of photosensitivity and people with heart problems or poor health should not use the 3D Glasses. This can worsen existing health conditions.
- Do not use the 3D Glasses for other purposes (such as general eyeglasses, sunglasses, or protective goggles).
- Do not use the 3D function or 3D Glasses while walking or moving around. This may result in injuries due to running into objects, tripping, and/or falling.
- When using the 3D Glasses, take care not to accidentally strike the TV screen or other people. Viewing 3D images may cause you to misjudge the distance to the TV screen and accidentally strike the screen, resulting in possible injury.
- It is recommended that you do not view 3D images if you are sleep deprived or if you have been drinking alcohol.

Enjoying 3D Image Viewing (For the UQ17U, TQ15U, SQ17U, SQ15U and LE657U models)

Preparing for the 3D glasses

Supplied accessories (For the UQ17U, SQ17U and LE657U models)

Make sure the following accessories are provided with the 3D glasses.

3D glasses x 2



Cleaning cloth x 1

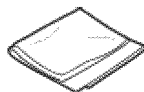

NOTE

- The illustrations above are for explanation purposes and may vary slightly from the actual accessories.

Part Names

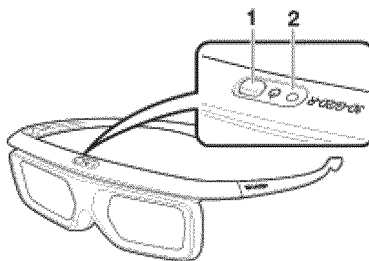

- 1 Power button
- 2 LED indicator

NOTE

- The power turns off automatically in the following cases:
 - When pairing fails
 - When the 3D glasses are not operated in standby for 15 seconds

1 Power button:

- When the power button is pressed for 2 or more seconds with the power off, pairing with the TV starts.
- When the power button is pressed for 2 or more seconds with the power on, the power turns off.
- When paired, the power will turn off if the power button is pressed for 2 or more seconds.
- When the power button is pressed for less than 2 seconds with the power off, the 3D glasses will turn to standby.
- When the 3D glasses are in 3D mode with the power on, pressing the power button for less than 2 seconds will turn the 3D glasses to 2D mode.
- When the 3D glasses are in 2D mode with the power on, pressing the power button for less than two seconds will turn the 3D glasses to 3D mode.
- When paired, the 3D glasses will be non-reactive if the power button is pressed for less than 2 seconds.

2 LED light

- When paired with the TV, the LED light blinks in red and green.
- When pairing is completed successfully, the LED blinks in green for 3 seconds.
- When the power is turned on, the LED lights up in green for 3 seconds.
- When in 3D mode, the LED blinks in green in 3-second intervals.
- When in 2D mode, the LED blinks in red in 3-second intervals.
- When the power is turned off, the LED blinks in green 3 times.

NOTE

- When in low voltage mode:
 - When in 3D mode, the LED blinks in green in 3-second intervals.
 - When in 2D mode, the LED blinks in red in 3-second intervals.

Enjoying 3D Image Viewing (For the UQ17U, TQ15U, SQ17U, SQ15U and LE657U models)

Using the 3D glasses

Before using the 3D Glasses

Before using the 3D glasses for the first time, remove the insulating sheet attached to them.

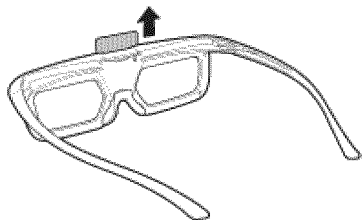

Using the 3D glasses

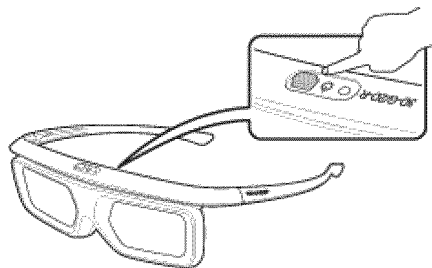

Pairing the 3D glasses

To view 3D images, it is necessary to pair the 3D glasses and TV.

- To confirm pairing of the 3D glasses and TV, make sure that 3D images are displayed on the TV screen.
- When the power button is pressed for 2 or more seconds with the power off, pairing with the TV starts. When pairing is completed successfully, the LED blinks in green for 3 seconds.
- To switch between 2D and 3D modes, briefly press the power button.

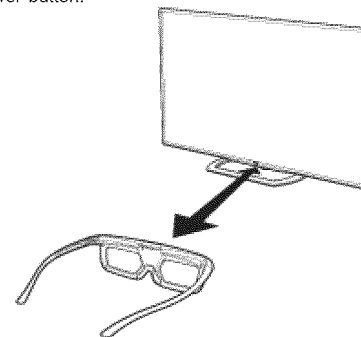

NOTE

- When paired, make sure that the 3D glasses are kept at a distance of 1.64-6.56 ft (50 cm-2 m) from the TV. If too close, pairing cannot be performed.

Enjoying 3D Image Viewing (For the UQ17U, TQ15U, SQ17U, SQ15U and LE657U models)

Using the 3D glasses (Continue)

Switching to 3D and 2D Mode

When viewing 3D images, you can press the power button to switch between 2D and 3D modes. This is useful when several people are viewing 3D images on the same TV with some people wanting to watch in 3D and some people wanting to watch in 2D.

Viewing 2D Images

When you press and hold for less than 2 seconds while viewing 3D images, the LED light blinks in red and the 3D images switch to 2D images.

Viewing 3D Images

When you press and hold for less than 2 seconds while viewing 2D images, the LED light blinks in green and the 2D images switch to 3D images.

Usage Range of the 3D Glasses

The 3D glasses can be used by receiving a signal sent from the TV.

The 3D glasses turn off automatically after 15 seconds if no signal is received from the TV.

Operating range

From directly the TV: approx. 5 m (within approx. 30° horizontally and 20° vertically)

Replacing the Battery

The battery has an expected service life of approximately 75 hours.

- When replacing the button battery, use only the designated battery (Maxell branded CR2025 lithium button battery).

1 Use the tip of a ballpoint pen or similar object to press in on the lock.

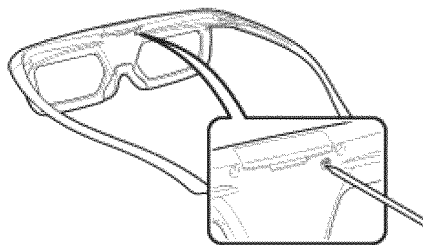

2 While pressing in on the lock, place your fingertip in the groove and pull out the battery holder.

- Pull the battery holder all the way out.

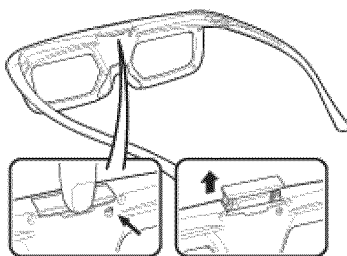

3 Replace the battery.

- Use the tip of a ballpoint pen or similar object to remove the battery.
- Insert a new battery.
 - Insert the battery with the negative side (-) facing up.

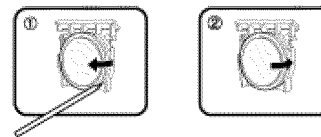

4 Align the battery holder with the battery slot on the 3D glasses and slide it back into place.

- Press it in until it locks.

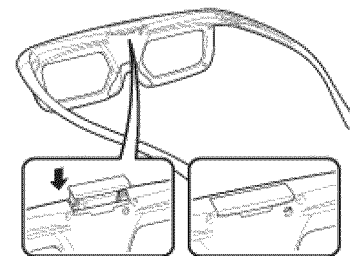

NOTE

- Take care not to reverse the battery poles (+) and (-) when loading the battery.
- Used batteries should be disposed of strictly in accordance with the applicable local laws and regulations.

Enjoying 3D Image Viewing (For the UQ17U, TQ15U, SQ17U, SQ15U and LE657U models)

Specifications - 3D glasses (sold separately)

Product	3D Glasses
Model number	AN-3DG40
Lens type	Liquid crystal shutter
Power supply	DC3V
Battery	Lithium button battery (CR2025 x 1)
Battery life	Approx. 100 hours of continuous use
Dimension (W x H x D)	171.2 × 46.0 × 162.4 mm
Weight	Approx. 31.0 g (including the lithium ion polymer rechargeable battery)
Operating temperature	10°C to 40°C (The 3D glasses cannot operate fully at extreme high or low temperatures. Please use them within the specified usage temperature range.)



The product serial number is displayed on the 3D glasses as indicated in the illustration on the left. The first three digits represent the date of manufacture.

Example: Manufactured on February 23, 2013

S/N : 8 2 P 000000

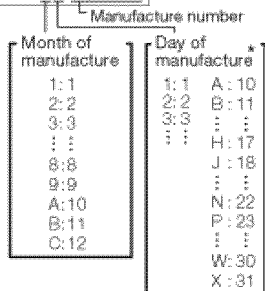



*"I", "O", "Y" and "Z" are not used.

NOTE

- Please contact your local authority for the correct method of disposal of this product and/or packing.





Troubleshooting - 3D Images

Problem	Possible solution
<p>3D images are not displayed.</p>	<p>Is "3D auto change" set to "Off"? Press 2D/3D to switch to 3D mode (Page 5-11).</p> <p>If "3D auto change" is set to "Mode1" or "Mode2" but no 3D images are displayed, check the display format of the content being viewed. Some 3D image signals may not be recognized as 3D images automatically. Press 2D/3D to select the appropriate display format for the 3D image (Page 5-9).</p> <p>Is the power of the 3D glasses turned on? Press the power button for at least 2 seconds to turn on the 3D glasses.</p> <p>Are the 3D glasses set to 2D mode? Press the power button for an amount of time that is less than 2 seconds to switch the 3D glasses to 3D mode.</p> <p>Is there an obstacle between the 3D glasses and the TV, or is something covering the receiver on the 3D glasses? The 3D glasses operate by receiving a signal from the TV. Do not place anything between the 3D emitter on the TV and the receiver on the 3D glasses.</p>
<p>Images displayed in 3D mode appear doubled while you are wearing the 3D glasses.</p> 	<p>Is the power of the 3D glasses turned on? Press the power button for at least 2 seconds to turn on the 3D glasses.</p>
<p>Images displayed in 3D mode appear 2D while you are wearing the 3D glasses.</p> 	<p>Are the 3D glasses set to 2D mode? Press the power button while viewing 2D images, the LED light blinks in green and the 2D images switch to 3D images.</p>

- For further details, refer to the operation manual of the 3D glasses.

Enjoying 3D Image Viewing (For the UQ17U, TQ15U, SQ17U, SQ15U and LE657U models)

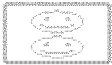
Display Methods for 3D and 2D Images

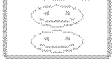
	Display method	Example display	Description
3D mode (using the 3D Glasses)	2D → 3D		<ul style="list-style-type: none"> Converts normal 2D images into 3D images.
	Side by Side		<ul style="list-style-type: none"> Creates 3D images from 3D images displayed side by side. The image is split into a left and right image, and then the images are stretched and displayed sequentially to create a 3D image.
	Top and Bottom		<ul style="list-style-type: none"> Creates 3D images from 3D images displayed on the top and bottom. The image is split into a top and bottom image, and then the images are stretched and displayed sequentially to create a 3D image.
2D mode (without using the 3D Glasses)	Side by Side → 2D		<ul style="list-style-type: none"> Creates 2D images from 3D images displayed side by side. Only the left image is stretched and displayed. The image does not appear in 3D.
	Top and Bottom → 2D		<ul style="list-style-type: none"> Creates 2D images from 3D images displayed on the top and bottom. Only the top image is stretched and displayed. The image does not appear in 3D.

* These functions can also be used by the SQ10U, EQ10U, LE650U, C6500U and LE642U.

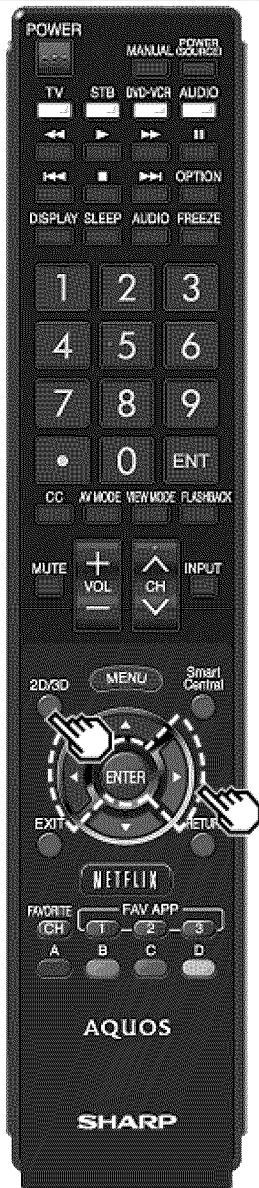

Viewing 3D Images

NOTE

- The TV screen may temporarily become black when the TV is trying to detect a 3D image signal and when switching from 3D to 2D mode.

Receiving a 3D Image Signal That Can Be Detected Automatically

The image signal may contain a 3D identification signal. You can enable the TV to automatically detect the 3D image type by selecting "Setup" > "3D Setup" > "3D Auto Change" on the TV.

(See page 5-11.)

1 When "3D Auto Change" is set to "Mode 1" or "Mode 2"

- The 3D image type is detected automatically and the appropriate 3D image is displayed.

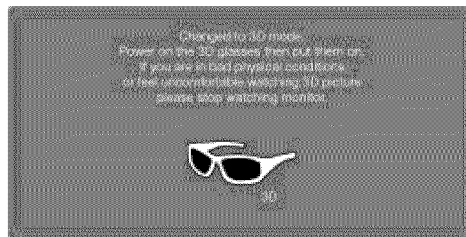

When "3D Auto Change" is set to "Off"

- The following message is displayed. Press 2D/3D.



- Press  to select the "Yes", and then press ENTER.

- Turn on the 3D Glasses and place them on your head.
- You can now view 3D images.

Switching from 3D to 2D Mode

4 Press 2D/3D during the 3D mode.

Select "Yes" and press ENTER to switch to 2D mode.

- Take off the 3D Glasses and turn off the power.

Ending 3D Image Viewing

5 Take off the 3D Glasses and turn off the power.

NOTE

- If the input signal switches to 2D, 2D images are displayed automatically.
- 3D mode is canceled automatically when the setting is changed, input selection is changed, or the power is turned off.



Viewing 3D Images (Continue)

Receiving a 3D Image Signal That Cannot Be Detected Automatically

- 1 Press **2D/3D**.
 - A screen appears prompting you to select between 3D and 2D image viewing.
- 2 Press **◀▶** to select "3D" or "2D", and then press **ENTER**.
 - **To view in 3D mode:** Select "3D", and then go to step 3.
 - **To view in 2D mode:** Select "2D", and then go to step 6.
- 3 Press **◀▶** to select the 3D signal type ("2D→3D", "Side by Side" or "Top and Bottom") and then press **ENTER**.

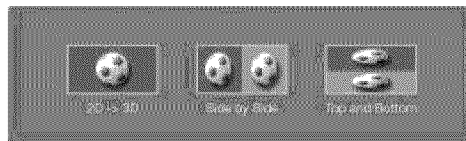

- If you select the same system as that of the input signal, 3D images are displayed.
- 4 Turn on the 3D Glasses and place them on your head.
 - 5 You can now view 3D images.

Switching from 3D to 2D Mode

- 6 Press **◀▶** to select the 2D signal type ("Side by Side" or "Top and Bottom") and then press **ENTER**.

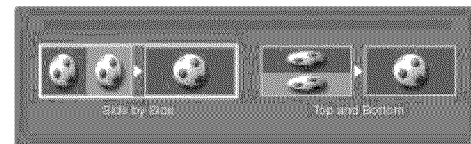

- If you select the same system as that of the input signal, 2D images are displayed.
- Take off the 3D Glasses and turn off the power. This function can also be used by the SQ10U, EQ10U, LE650U, C6500U and LE642U.

Ending 3D Image Viewing

- 7 Take off the 3D Glasses and turn off the power.

Watching 2D images in 3D

You can convert normal 2D images into 3D images.

- 1 Press **2D/3D**.
- 2 Press **◀▶** to select "2D→3D", and then press **ENTER**.
- 3 Turn on the 3D Glasses and place them on your head.

NOTE

- The TV returns to 2D mode after 1 hour has passed.



Viewing 3D Images (Continue)

Switching to the Previous Mode

You can switch back to the previous mode by pressing **2D/3D**.

- 1 Press **2D/3D**.
 - A confirmation screen is displayed.
- 2 Select "Yes" and then press **ENTER**.
 - The TV returns to the previous mode.

This function can also be used by the SQ10U, EQ10U, LE650U, C6500U and LE642U.

3D Menu

Pressing **2D/3D** in 3D mode displays the 3D menu. Press the colored buttons to make the necessary settings.

- A:** 3D Brightness Boost
- B:** 3D Surround
(See page 4-12.)
The surround mode changes each time you press **B**.
- C:** 2D→3D Convert Effect
- D:** 3D Setup

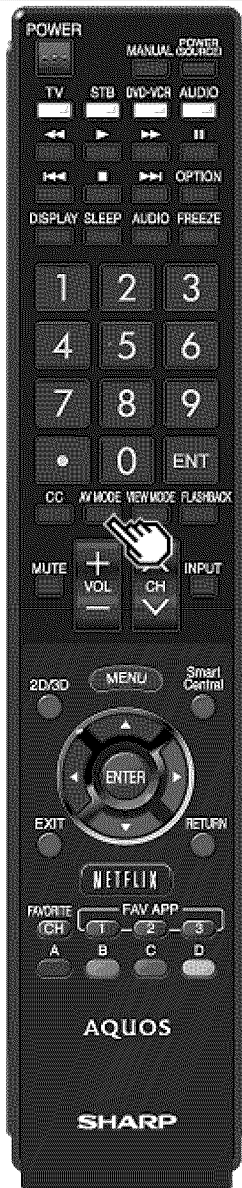

Configuring the TV Setting to Enhance 3D Image Viewing

You can adjust the 3D image to the desired image quality and make various settings for 3D image viewing.

- Set AV MODE and "3D Brightness Boost" with "Picture Settings".
- Set the 3D viewing settings with "Setup" > "3D Setup".

NOTE

- Which items can be selected/adjusted differs depending on whether the TV is in 2D mode or in 3D mode.

AV MODE

The audio and video settings can be changed to suit the program or input content being watched.

3D: For a highly defined image in a normal lighting.

GAME (3D): Lowers image brightness for easier viewing.

For the LE657U model

STANDARD (3D): For a highly defined image in a normal lighting.

MOVIE (3D): For a movie.

GAME (3D): Lowers image brightness for easier viewing.

NOTE

- You can select AV MODE by pressing **AV MODE** on the remote control unit.

3D Brightness Boost

You can adjust the backlight of the TV for 3D image viewing.

High/Middle/Low: Select a desired level of 3D Brightness Boost.

NOTE

- When "High" or "Low" is selected, "Automatic Light Sensor", "Backlight" and "Light Sensor Adjustment" are not available.

3D Setup

You can make various settings to enhance 3D image viewing.

3D Auto Change

This setting can be used to switch to 3D mode automatically when a 3D identification signal is detected.

Set the desired mode according to the type of media you are viewing, such as video from a connected device or video from an internet application.

Mode 1: 3D mode is selected automatically when a 3D signal is detected while viewing video from a VOD service or HDMI-connected equipment.

Mode 2: 3D mode is selected automatically when, in addition to detecting a 3D signal while viewing video from a VOD service or HDMI-connected equipment, a video pattern with "Side by Side" or "Top and Bottom" format is also detected.

Off: Auto change is not performed.

NOTE

- This function does not work when the input source is Composite, Component, RGB or Analog/Digital tuner.

3D Depth Control

Select the method for adjusting the 3D depth.

Auto: The depth is adjusted automatically.

Manual: You can manually adjust the depth using the function "Depth Change".

NOTE

- This function is only available when the input signal is 3D.
- This function may not be displayed depending on the type of 3D signal.



Configuring the TV Setting to Enhance 3D Image Viewing (Continue)

Depth Change

Adjusts the depth manually. "0" is the level where no adjustment is made.

NOTE

- This function is only available when "3D Depth Control" is "Manual".

2D→3D Convert Effect

You can adjust the 3D effect when converting images from 2D mode to 3D mode. Select a desired level of convert effect from +1 to +16.

NOTE

- This function is only available when converting 2D images to 3D images.
- When you use this function, image conversion on the TV will result in some differences in the original images and how they appear.
- 2D images that have been converted to 3D images may be viewed only for personal use.

Viewing Time Info

This displays the elapsed time of 3D image viewing.

Yes: Displays the elapsed viewing time on the screen every hour.

No: Does not display the elapsed viewing time.

3D Test

This displays 3D images for testing the 3D operation. Clicking "Start" on the screen plays back 3D test images.

- If you press **RETURN** during playback, the previous screen will be displayed.

3D Glasses Control

To enable this function, set "TV Location" to "Store".

On: Switch on signals to the 3D glasses. When watching 3D images, switch this setting to "On".

Off: Switch off signals to the 3D glasses. This will stop the TV from influencing 3D glasses that may be in that area of the store.

NOTE

- Appropriate 3D Glasses are required to view 3D images. Purchase 3D Glasses for use with Sharp brand 3D LCD TVs.

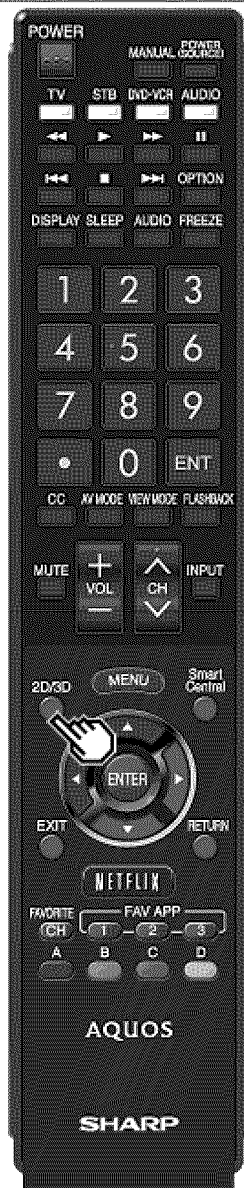

Configuring the TV Setting to Enhance 3D Image Viewing (Continue)

3D Glasses lenses

- Do not apply pressure to the lenses of the 3D Glasses. Also, do not drop or bend the 3D Glasses.
- Do not scratch the surface of the lenses of the 3D Glasses with a pointed instrument or other object. Doing so may damage the 3D Glasses and reduce the quality of the 3D image.
- Use only the cloth provided with the optional 3D Glasses to clean the lenses.

Caution during viewing

- Do not use devices that emit strong electromagnetic waves (such as cellular phones or wireless transceivers) near the 3D Glasses. Doing so may cause the 3D Glasses to malfunction.
- The 3D Glasses cannot operate fully at extreme high or low temperatures. Please use them within the specified usage temperature range.
- If the 3D Glasses are used in a room with fluorescent lighting (60 Hz), the light within the room may appear to flicker. In this case, either darken or turn off the fluorescent lights when using the 3D Glasses.
- Wear the 3D Glasses correctly. 3D images will not be correctly visible if the 3D Glasses are worn upside down or back-to-front.
- Other displays (such as computer screens, digital clocks, and calculators) may appear dark and difficult to view while wearing the 3D Glasses. Do not wear the 3D Glasses when watching anything other than 3D images.

- If you lie on your side while watching the TV with 3D Glasses, the picture may look dark or may not be visible.
- Be sure to stay within the viewing angle and optimum TV viewing distance when watching 3D images. Otherwise, you may not be able to enjoy the full 3D effect.
- The 3D Glasses may not work properly if there is any other 3D product or electronic devices turned on near the glasses or TV. If this occurs, turn off the other 3D product or electronic devices or keep the devices as far away as possible from the 3D Glasses.
- Stop using the 3D Glasses in any of the following situations:
 - When images consistently appear doubled while you are wearing the 3D Glasses
 - When you have difficulty perceiving the 3D effect
- If the 3D Glasses are faulty or damaged, stop using them immediately. Continued use of the 3D Glasses may cause eye fatigue, headaches and illness.
- If you have any abnormal skin reaction, stop using the 3D Glasses. In very rare instances, such reactions may be due to an allergic reaction to the coating or materials used.
- If your nose or temples become red or you experience any pain or itchiness, stop using the 3D Glasses. Pressure caused by long periods of use may lead to such reactions and may result in skin irritation.

Usage range of the 3D Glasses

- The 3D Glasses can be used by receiving a signal sent from the TV.
The 3D Glasses turn off automatically after 15 seconds if no signal is received from the TV.
Operating range:
From directly in front of the 3D emitter on the TV:
approx. 17 ft (5 m)
(within approx. 30° horizontally and 20° vertically)
- For further details, refer to the operation manual of your 3D Glasses.

Enjoying Photo/Music/Video Playback

Preparation

You can connect the TV to a USB memory device, USB hard drive or Home Network server to enjoy viewing pictures, listening to music, and watching videos.

NOTE

- Depending on the USB memory device/USB hard drive/Home Network server, the TV may not be able to recognize the recorded data.
- It may take time to read the recorded data if the USB memory device/USB hard drive/Home Network server contains many files or folders.
- Use only alphanumeric characters for naming files.
- File names over 80 characters (may vary depending on character set) may not be displayed.

Connecting a USB Memory Device/USB Hard Drive

Insert the USB memory device with recorded photos, music or videos into the USB 1 or USB 2 terminal on the TV.

- If USB memory devices are inserted into both terminals, the USB 1 terminal has priority.

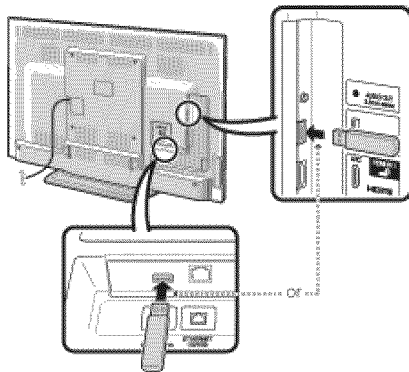

- When connecting a USB hard drive, be sure to use a hard drive with an AC adapter.
- Do not remove a USB memory device or memory card from the TV while transferring files, using the slide show function, or switching screens, or before you exit "USB" from the INPUT list.
- Do not insert and remove a USB memory device/USB hard drive to and from the TV repeatedly.
- When using a card reader, be sure to insert a USB memory device first.

CAUTION

- Do not use a USB extension cable when connecting a USB memory device to the USB terminal on the TV.
- Using a USB extension cable with the USB memory device may prevent the TV from performing correctly.

Connecting a Home Network Server

Connect the TV to the Home Network server using an ETHERNET cable.

- You can also connect a Home Network server by using a wireless LAN.

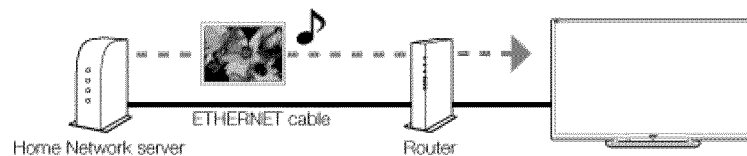

NOTE

- Do not disconnect a Home Network server from the TV while transferring files, when a screen is switching to another or before you exit "Home Network" from the INPUT list.
- Do not connect and disconnect a Home Network server from the TV repeatedly.

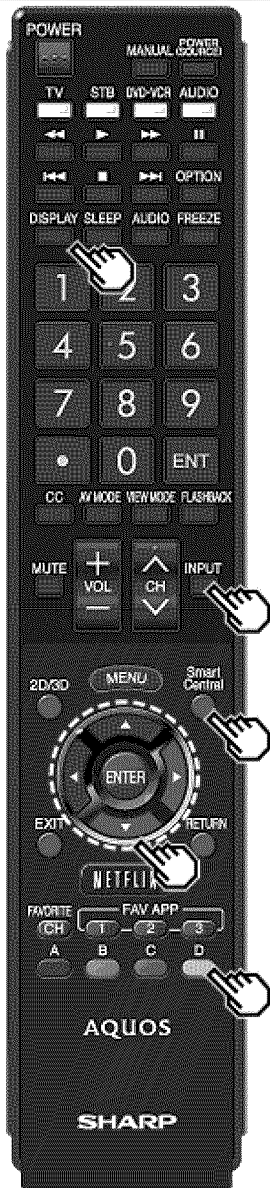

Selecting the Folders to Play Back

- To play back data on a USB memory device, insert the USB memory device on the TV. USB mode is selected automatically. (Go to step 2)
- Use the following procedure to switch back to USB mode after switching from USB mode to another mode.
 - 1 Select "USB" or "Home Network" from INPUT list screen.
 - 2 Press D.
 - 3 Press ▲▼ (or ◀▶) to select the drive/server where you want to find your files, and then press **ENTER**.
 - For USB mode, select the drive.
 - When in Home Network mode, select the server.
 - 4 Press ◀▶ to select "Photo", "Music" or "Video", and then press **ENTER**.

Example

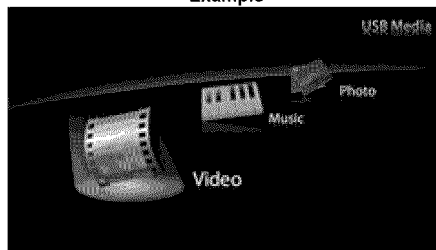

- 5 Press ◀▶ to select the desired folder, and then press **ENTER**.

NOTE

- The Media screen can be displayed even by using the application window. To display the application window, press **SmartCentral**. (See page 3-6.)
- You cannot switch the input mode if a USB memory device is not connected.
- You do not need to select the drive/server in step 3 when there is only one drive in the connected USB memory device or there is only one Home Network server connected to the TV.
- 16 is the maximum number of USB drives and 10 is the maximum number of Home Network servers that can be displayed.
- If the TV is turned off and then on again, the number assigned to the USB drive may change.
- "VIEW MODE" is fixed during the Photo or Music mode. During "Video mode", you can select "Auto" or "Original".
- The key guide display disappears automatically after a particular time has elapsed. To display the key guide display again, press **DISPLAY**.

USB Device Compatibility

USB device	USB Memory, USB card reader (Mass Storage class), USB hard drive
File system	FAT/FAT32/NTFS (USB hard drive only)
Photo file format	JPEG (.jpg) (DCF2.0 compliant) Multi-Picture Format (.mpo) (CIPA DC-007 Compliant) MP Type : Multi view individually image (stereoscopic view)
Music file format	MP3 (.mp3) Bitrate: 32k, 40k, 48k, 56k, 64k, 80k, 96k, 112k, 128k, 160k, 192k, 224k, 256k, 320kbps Sampling frequency: 32k, 44.1k, 48kHz



Selecting the Folders to Play Back (Continue)

Video file format			
File extension	Container	Video	Audio
.avi	AVI	DivX 3.11/4.x/5.1/6.0 XviD H.264 MPEG4 Motion Jpeg	MP3 Dolby Digital LPCM ADPCM DTS
.mkv	MKV	DivX 3.11/4.x/5.1/6.0 XviD H.264 MPEG4	MP3 Dolby Digital LPCM ADPCM DTS
.asf .wmv	ASF	DivX 3.11/4.x/5.1/6.0 XviD MPEG4 VC-1 Windows Media Video v9	MP3 Dolby Digital LPCM WMA
.mp4 .mov	MP4 (SMP4)	H.264 MPEG4 Motion Jpeg	MP3 Dolby Digital Dolby Digital Plus AAC
.mpg .mpeg	PS	MPEG2 MPEG1	Dolby Digital MPEG LPCM

NOTE

- Progressive format jpeg files are not supported.
- USB 1.1 devices may not be played properly.
- Operation using USB hubs is not guaranteed.
- Some video file formats may not be played depending on the file.
- Some images may not be displayed in the appropriate aspect ratio depending on the file format.

Home Network Server Compatibility

Photo file format	JPEG
Music file format	LPCM, MP3
Video file format	MPEG2-PS, MPEG2-TS, WMV, ASF, MP4, MOV, AVI

NOTE

- Progressive format jpeg files are not supported.
- Some video file formats may not be played depending on the file or the server.
- WMV, ASF, MP4, MOV and AVI are not Home Network contents.

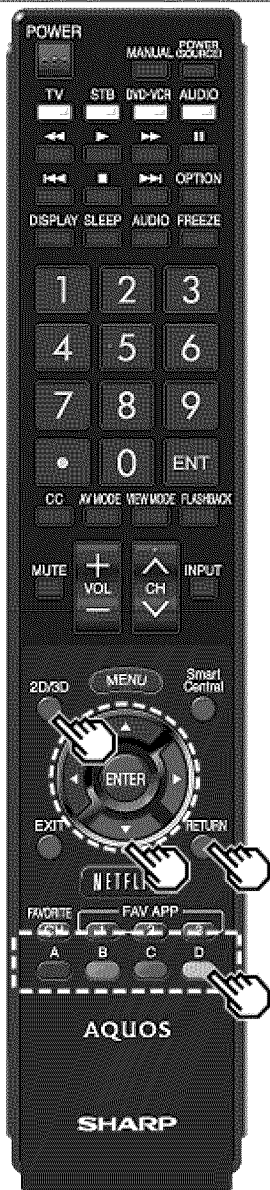

Playing Back Files on a USB Memory Device/Home Network Server

NOTE

- The screen images in this section are for the USB mode. It may be slightly different in the Home Network mode.

Photo Mode

Viewing Thumbnails

Example

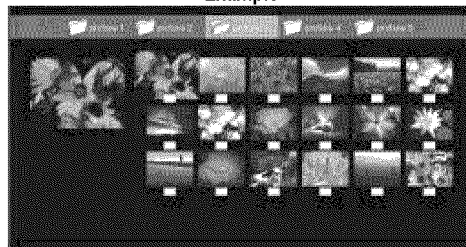

Buttons for thumbnail operations

Buttons	Description
▲/▼/◀/▶	Select a desired item.
ENTER	When selecting a folder icon: Enter this directory. When selecting a photo thumbnail: Enlarge the photo.
RETURN	Return to the previous process.
A (red)	USB mode: Select the images to be displayed. Press this button to add or remove a checkmark. Home Network mode: Display the Media screen.
B (green)*	Display the music list screen. You can select the background music to be played for the slide show.
C (blue)	Start the slide show.
D (yellow)	Display the USB MENU/Home Network Menu screen.

*This function is available only for the USB mode.

NOTE

- When there are invalid photo files, the **X** mark will be displayed for the file. (USB mode only.)
- The icon "3D" appears on the thumbnails of 3D images. (USB mode only.)
 - For the UQ17U, TQ15U, SQ17U, SQ15U and LE657U models
If you do not switch to 3D mode for the 3D images, they will be displayed in 2D.
 - For the SQ10U, EQ10U, LE650U, C6500U and LE642U models 3D images are always displayed in 2D mode.
- You can see the file name, shooting date, file size and pixel size of the selected photo in the lower-left corner of the screen (shooting date is only available in the EXIF file format).

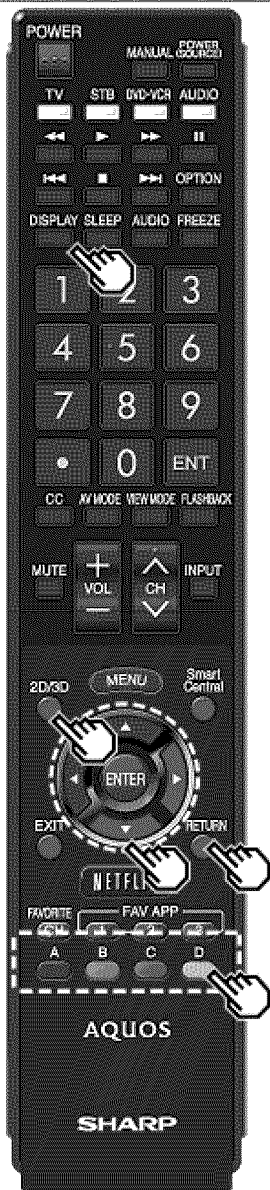

Playing Back Files on a USB Memory Device/Home Network Server (Continue)

Viewing Individual Photos

The photo selected on the thumbnail selection screen is displayed.

Buttons for individual display operation

Buttons	Description
◀▶	Go to the previous/next photo in the same directory.
RETURN	Return to the thumbnail selection screen.
2D/3D*	Switches between 2D and 3D modes.
A (red)	Rotate the photo by 90 degrees to the left.
B (green)	Rotate the photo by 90 degrees to the right.

* This function is available for the UQ17U, TQ15U, SQ17U, SQ15U and LE657U models.

NOTE

- Rotating photos only applies to the temporarily selected item and this setting is not saved.
- In 3D mode, you cannot rotate the photos. (For the UQ17U, TQ15U, SQ17U, SQ15U and LE657U models)
- The key guide display disappears automatically after a particular time has elapsed. To display the key guide display again, press **DISPLAY**.

Slide Show

The photos displayed on the thumbnail selection screen are displayed as a slide show.

Buttons for slide show operation

Buttons	Description
RETURN	Return to the thumbnail selection screen.
2D/3D*	Switches between 2D and 3D modes.
D (yellow)	Display the USB MENU/Home Network Menu screen.

* This function is available for the UQ17U, TQ15U, SQ17U, SQ15U and LE657U models.

NOTE

- The selected BGM is played repeatedly.
- The slide show continues until you press **RETURN**.
- For setting the slide show speed, select "Select Slide Show Interval" on the USB MENU/Home Network Menu screen.
- The key guide display disappears automatically after a particular time has elapsed. To display the key guide display again, press **DISPLAY**.

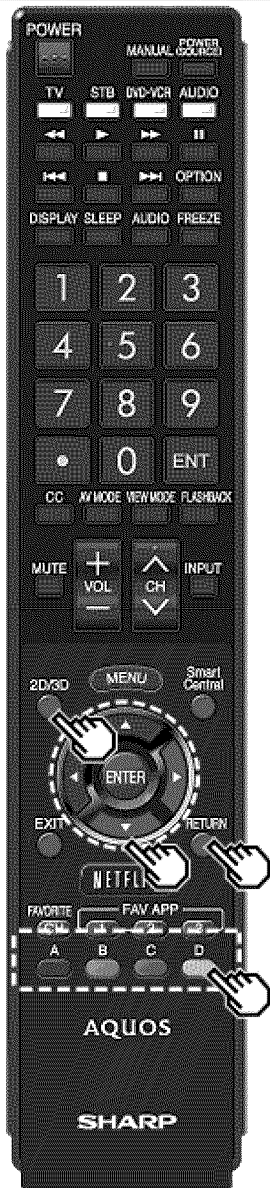

Playing Back Files on a USB Memory Device/Home Network Server (Continue)

USB Menu

On the menu to be displayed in USB mode, use ▲/▼ to select an item and make settings to your preferences.

Example



3D Display (for the UQ17U, TQ15U, SQ17U, SQ15U and LE657U models)

You can view photos in 3D.

NOTE

- You can select "3D display" from "USB MENU" only when the thumbnails screen for the photo mode in USB mode is displayed on the screen.
- Depending on the file, the photos may not be displayed in 3D.

Select Slide Show Interval

Specify the length of time before the next image appears. Press ▲/▼ to select the desired length of the time, and then press ENTER.

5sec/10sec/30sec/60sec

NOTE

- For Home Network mode, follow the same procedure.
- Depending on the photo files, the length of the slide show interval may differ from the selected interval time.

Select Slide Show BGM

The music list screen appears when you select "Select Slide Show BGM".

You can select the music to be played in the background while the slide show is being displayed.

- Select the music you want to play from the music list.
 - For operations on the music list screen, see "Music Mode".

- Press RETURN to display the thumbnail selection screen, and then press C to start the slide show and the background music.

NOTE

- All of the music files are selected by default.

Set/Reset All Slide Show Image

Selecting "Set All Slide Show Image" or "Reset All Slide Show Image" will display the thumbnail selection screen. On the screen, set or reset the images to be displayed in the slide show.

Set All Slide Show Image: Checkmarks are added to all the images.

Reset All Slide Show Image: Removes all the checkmarks from all the images.

Sort

You can change the way in which files are ordered. Press ▲/▼ to select "new→old", "old→new", or "File name order", and then press ENTER.

Remove USB Media Device

To remove the USB device properly, use ◀▶ to select "Yes" and then press ENTER.

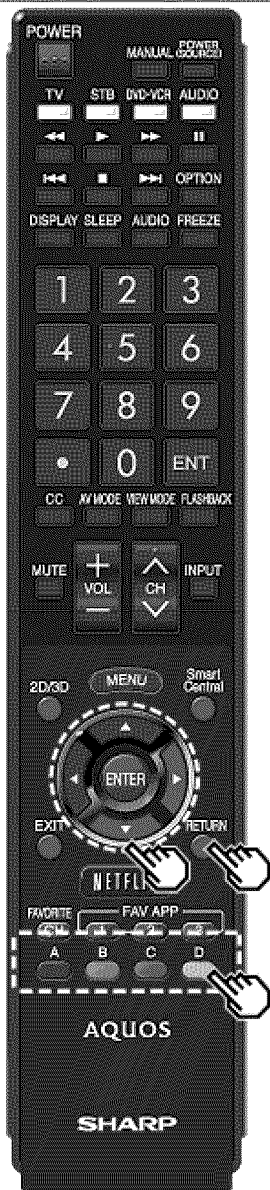

Playing Back Files on a USB Memory Device/Home Network Server (Continue)

Music Mode

Example



Buttons for music mode

Buttons	Description
▲▼/◀▶	Select a desired item.
ENTER	When selecting a folder icon: Enter this directory. When selecting a music file: Play music.
RETURN	Return to the previous process.
A (red)	USB mode: Select the music to be played back. Press this button to add or remove a checkmark. Home Network mode: Display the Media screen.
B (green)	Stop music.
C (blue)	Play/(Pause)* music.
D (yellow)*	Display the USB MENU screen.

* This function is available only for the USB mode.

NOTE

- When there are invalid music files, the X mark will be displayed for the file. (USB mode only.)
- The displayed play time may differ slightly from the actual play time depending on the files.

USB Menu

On the menu to be displayed in USB mode, use ▲▼ to select an item and make settings to your preferences.

Example



* See page 6-6 for details on the Remove USB Media Device function.

Set/Reset All Auto Play

Selecting "Set All Auto Play" or "Reset All Auto Play" will display the music list screen. On the screen, set or reset the music to be played back in the slide show.

Set All Auto Play: Checkmarks are added to all the music files.

Reset All Auto Play: Removes all the checkmarks from all the music files.

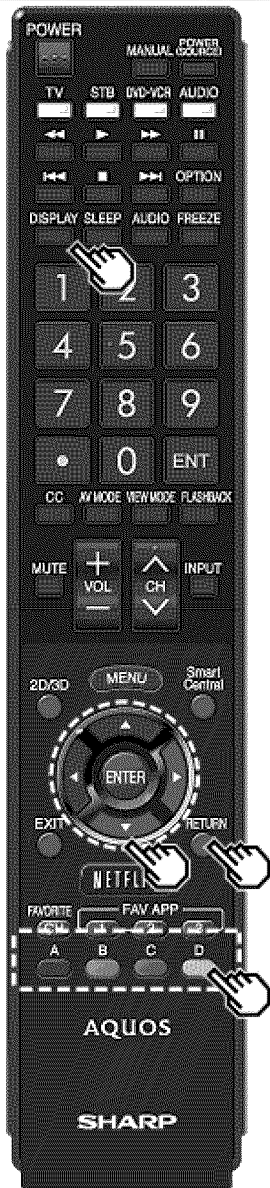

Playing Back Files on a USB Memory Device/Home Network Server (Continue)

Video Mode

Example

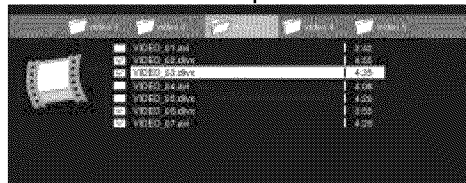

Buttons for file selecting operations

Buttons	Description
▲▼/◀▶	Select a desired item.
ENTER	When selecting a folder icon: Enter this directory. When selecting a video file: Play the video.
RETURN	Return to the previous process.
A (red)	USB mode: Select/deselect items (checkmarks are added to the selected items). Home Network mode: Display the Media screen.
D (yellow)*	Display the USB MENU screen.

* This function is available only for the USB mode.

NOTE

- The key guide display disappears automatically after a particular time has elapsed. To display the key guide display again, press **DISPLAY**.



Playing Back Files on a USB Memory Device/Home Network Server (Continue)

Buttons for playing mode

Buttons	Description
▲	Go to the beginning of a file by pressing once or to the previous file by pressing twice.
▼	Go to the next file.
▶	USB mode: The fast forward speed changes every time you press ▶. After playing to the end, the TV goes to the next file and starts to play. Home Network mode: Jump forward in a video. *3
◀	USB mode: The reverse speed changes every time you press ◀. After going back to the beginning, the TV starts to play the same file. Home Network mode: Jump back in a video. *3
ENTER	USB mode: Pause the video. Home Network mode: Play/Pause the video. *3
RETURN	Go back to the file selection screen.

Buttons	Description
2D/3D*1	Switches between 2D and 3D modes.
A (red)*2	Jump to the scene where playback was last stopped.
B (green)	Stop a video.
C (blue)	Display the USB/Home Network operation panel.
D (yellow)*2	Display the USB MENU screen.
0-9*2	Jump to a point in the video during playback of a file without chapters. You can jump to a later point by pressing a higher number.*4

*1 This function is available for the UQ17U, TQ15U, SQ17U, SQ15U and LE657U models.

*2 These functions are available only for the USB mode.

*3 Jump forward/back and play/pause may not be available depending on the files.

*4 During playback of a file without chapters, playback points are set automatically. Playback points are set at intervals of a one-tenth of playback time.
Example for a file with a playback time of 100 minutes:
Pressing 1 jumps 10 minutes forward, and pressing 2 jumps 20 minutes forward. Pressing 0 returns to the start of the file being played back.

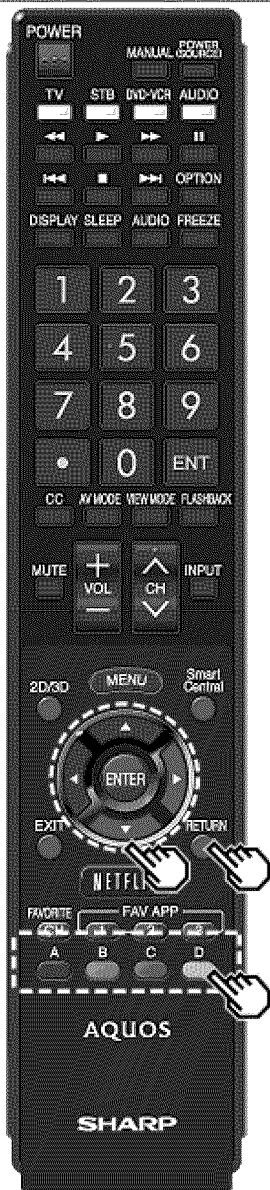

Playing Back Files on a USB Memory Device/Home Network Server (Continue)

USB Menu

On the menu to be displayed in USB mode, use ▲/▼ to select an item and make settings to your preferences.

Menu for file selecting operations

Example



* See page 6-6 for details on the Remove USB Media Device function.

Set/Reset All Auto Play

Selecting "Set All Auto Play" or "Reset All Auto Play" will display the video list screen. On the screen, set or reset the video to be played back in the slide show.

Set All Auto Play: Checkmarks are added to all the video files.

Reset All Auto Play: Removes all the checkmarks from all the video files.

Menu for playing mode

Example

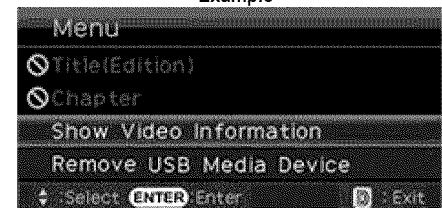

* See page 6-6 for details on the Remove USB Media Device function.

Title (Edition)/Chapter

Selecting "Title (Edition)" or "Chapter" will display a list of titles/chapters contained in the video file. Select the title or chapter you want to play back.

- The selected title or chapter is played back.
- "0-9" is displayed for files without chapters. Playback jumps to the playback point of the selected number.

NOTE

- If there is Edition information, this screen is displayed when the title is selected.
- If there is no title or edition, you cannot select "Title (Edition)".
- "Chapter" cannot be selected when there is no chapter.

Show Video Information

The information of the current file is displayed.

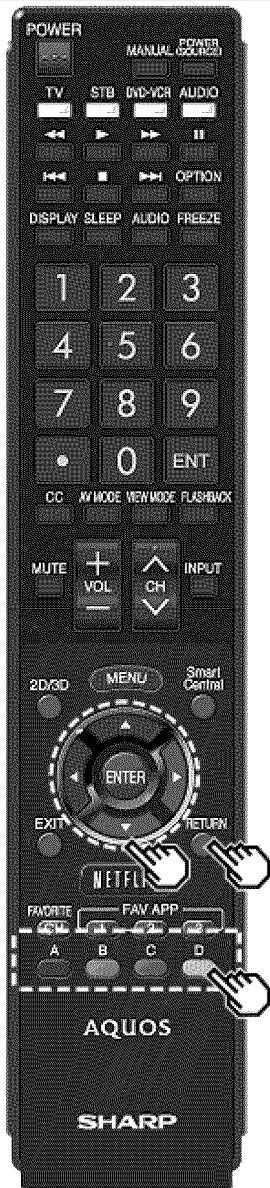

Playing Back Files on a USB Memory Device/Home Network Server (Continue)

USB Operation Panel/Home Network Operation Panel

You can use the operation panel for video playback operations.

You can call up this operation panel from "System Options" > "Shortcuts".

Example

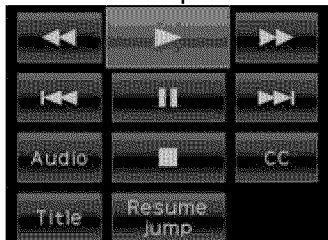

Buttons for using the USB operation panel

	Hold down to go in reverse.
	Starts playback.
	Hold down to fast forward.
	Video without chapters: Press once to return to the previous playback point.* Press twice to return to the previous file. Video with chapters: Press once to return to the previous chapter. Press twice to return to the previous file.
	Sets pauses and still pictures.
	Video without chapters: Press once to advance to the next playback point.* Press twice to display the next file. Video with chapters: Press once to advance to the next chapter. Press twice to display the next file.
Audio	Change the audio when multiple audio is available for the video you are watching.
	Playback stops.
CC	Change the Closed Caption display.
Title	Displays the title (edition).
Resume jump	Jump to the scene where playback was last stopped.

* During playback of a file without chapters, playback points are set automatically. Playback points are set at intervals of a one-tenth of playback time.

Example for a file with a playback time of 100 minutes: Playback points are set every 10 minutes. Pressing one time after viewing the file for 15 minutes jumps to the 20-minute playback point.

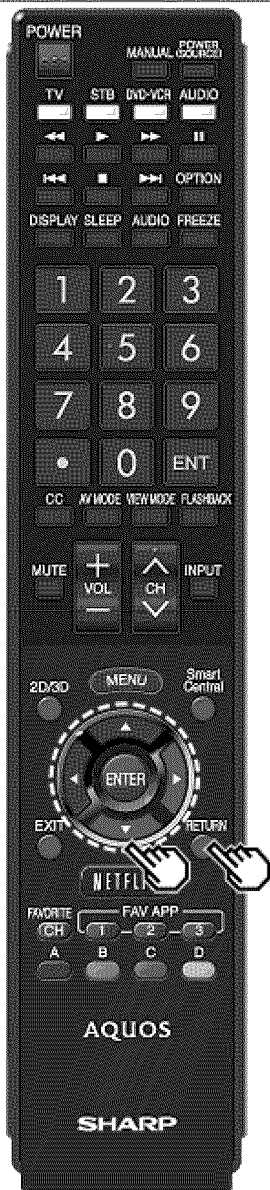

Playing Back Files on a USB Memory Device/Home Network Server (Continue)

NOTE

- Reverse/fast forward continues from one file to another during continuous playback.
- Use "CC" on the operation panel to change the Closed Caption display. You can also switch the Closed Caption display by using "System Options" > "Shortcuts" > "Change CC" or by pressing **CC** on the remote control unit.
- Use "Audio" on the operation panel to change the audio. You can also switch the audio by using "System Options" > "Shortcuts" > "Change Audio".

Buttons for using the Home Network operation panel

	Starts playback.
	Go to the beginning of a file by pressing once or to the previous file by pressing twice.
	Sets pauses and still pictures.
	Go to the next file.
	Playback stops.
	Jump back in a video.
	Jump forward in a video.

DivX® Setup

This is the function to confirm your registration code. You need to register the code at <http://www.divx.com>.

- 1 Press **MENU** to display the MENU screen.
- 2 Press to select "Setup", and then press **ENTER**.
- 3 Press to select "DivX® Setup", and then press **ENTER**.

DivX® VOD Registration

You can find your registration code on this menu. You need to register the TV at <http://www.divx.com> before playing the DivX content.

DivX® VOD Deregistration

You can find your deregistration code on this menu. You need to deregister the TV at <http://www.divx.com> to release the registration.

NOTE

- This function is available only for the USB mode.
- This function may not work while an Internet application is being used.

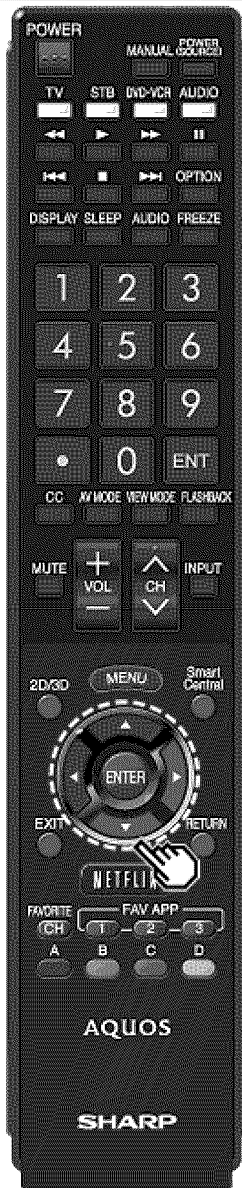

Playing Back Files from a Portable Device or PC

With the remote playback function, you can use your portable device to play back pictures, video, and music on the Home Network server.

- This TV is a DLNA certified Digital Media Renderer (DMR). To use the remote playback function, your portable device must be a DLNA Certified Digital Media Controller.
- A wireless access point is required to use a portable device.

Set Up Home Network

Make the settings for remote playback.

- 1 Press to select "Smart TV", and then press **ENTER**.
- 2 Press to select "Internet Setup", and then press **ENTER**.
- 3 Press to select "Home Network", and then press **ENTER**.
- 4 Press to select the specific adjustment item, and then press **ENTER** to set each item.

Remote Control Play Settings

This setting allows the TV to perform remote playback.

Permitted/Not allowed

Timeout Setup

This sets the time until the TV returns automatically to TV mode after remote playback ends.

10 sec./60 sec./No

NOTE

- This function may not work while an Internet application is being used.
- For information on the compatible formats, see "Home Network Server Compatibility" on [page 6-3](#).



Presetting Remote Control Function

You can operate the connected AV products (AV receiver, cable box, SAT tuner, DTV, VCR, BD, DVD, LD) using the presetting manufacturer function of your remote control unit.

Presetting manufacturer codes

- 1 Press an appropriate button (**STB**, **DVD-VCR** or **AUDIO**) to operate the connected equipment.
- 2 Press an appropriate button (**STB**, **DVD-VCR** or **AUDIO**) and **DISPLAY** at the same time to enter the code registration mode.
- 3 Press **0-9** to enter the manufacturer code.
 - Preset mode is finished once the LED no longer lights up.
- 4 After registering the code, the LED will stop blinking then turn off after one second. (If you perform an incorrect operation, the LED will blink quickly then turn off.)

Manufacturer codes

STB BRAND	REMOTE CONTROL CODE NUMBER
ANVISION	04, 05
CABLE STAR	04, 05
DISH NETWORK	39, 40
DIRECTV	41
EAGLE	05
G.INSTRUMENT	02, 03, 10, 11, 17, 20
GERROLD	17
JERROLD	02, 03, 10, 11, 12, 20, 25-34
MAGNAVOX	04, 05, 08, 12, 15, 16, 18, 19, 22, 23
MOTOROLA	38
OKA SIGMA	07
PANASONIC	14, 21
PHILIPS	04, 05, 08, 13, 15, 16, 18, 19, 22, 23
PIONEER	07
RANDTEK	04, 05
RCA	14, 36*, 37*
S.ATLANTA	01, 09, 24
VIEWSTAR	04, 05, 08, 13, 15, 16, 18, 19, 22, 23
ZENITH	06, 35

NOTE

- Numbers marked with * are SAT codes, all others are STB codes.



Presetting Remote Control Function (Continue)

BD/DVD/LD BRAND	REMOTE CONTROL CODE NUMBER
DENON	24
JVC	31
KENWOOD	36
MAGNAVOX	26
MARANTZ	26
mitsubishi	28
PANASONIC	24, 37
PHILIPS	26, 38
PIONEER	30, 33, 35
PROSCAN	25
RCA	25, 39
SAMSUNG	29, 34
SHARP	23, 32, 41, 42
SONY	27, 40
TOSHIBA	26
YAMAHA	24
ZENITH	26

- Depending on the brand, the codes of some BD players may not be supported.

VCR BRAND	REMOTE CONTROL CODE NUMBER
AUDIO DYNAMICS	09
BROCKSONIC	13
CANON	04
CRAIG	12
CURTIS MATHIS	04
DBX	09
EMERSON	10, 13, 14
GE	04
INSTANT REOLYA	04
JC PENNEY	04
JVC	09, 16, 17, 22
KENWOOD	09
MAGNAVOX	04, 05, 06
MAGNIN	12
MEMOREX	04
MONTGOMERY WARD	02
NEC	09
PANASONIC	04, 18, 19, 20, 21
PENTAX	05
PHILCO	04, 05
PHILIPS	04, 05, 06
QUASAR	04
REALISTIC	01, 02
SAMSUNG	11, 12



Presetting Remote Control Function (Continue)

VCR BRAND	REMOTE CONTROL CODE NUMBER
SHARP	01, 02, 03
SONY	07, 08, 15
SYLVANIA	04, 05, 06
TATUNG	09
TEAC	09
TMK	10
YAMAHA	09

AUDIO BRAND	REMOTE CONTROL CODE NUMBER
SHARP	01
SHARP (SOUND BAR)	02

Enjoying Photo/Music/Video Playback

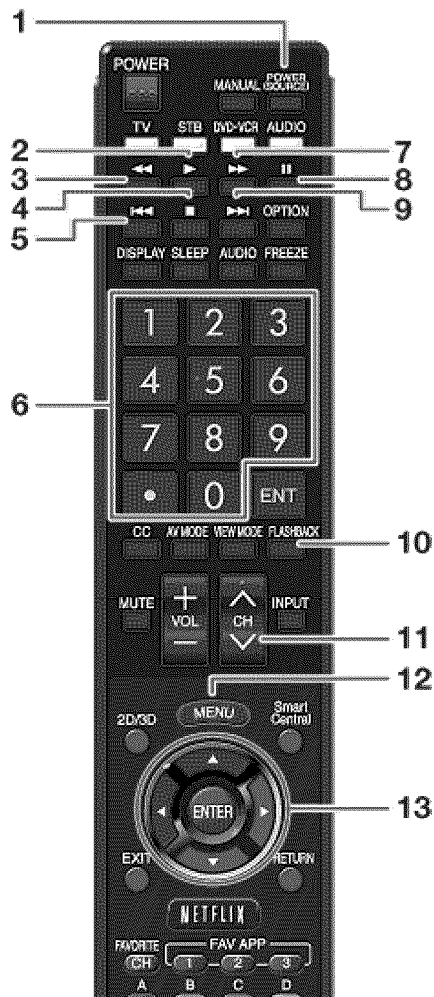

Operating the Connected Equipment

To operate the connected equipment, press **STB**, **DVD-VCR** or **AUDIO** to select your device. (STB (cable/satellite set-top box), BD, DVD, VCR or AUDIO.) The remote control unit button will function as follows.

- When you operate VCR, DVD or BD, press **INPUT** to select the terminal connected to your device.

- CABLE and SAT cannot be selected at the same time.

1 POWER (SOURCE)

- Turns the connected equipment power on and off.

2 ▶

- Starts playback. (VCR, BD, DVD)

3 ◀◀

- Rewinds the tape and allows picture search. (VCR)
- Hold down to go in reverse. (BD, DVD)

4 ■

- Stops the tape transport. (VCR)
- Playback stops when pressed. With some Blu-ray disc/DVD players, pressing the button twice may open the disc tray. (BD, DVD)

5 ◀◀◀

- Pressing quickly once takes you to the start of the chapter currently playing. Each time you press it, you move back to the start of the previous chapter. (BD, DVD)

6 0-9, • (DOT)

- Press a button (or buttons) that corresponds to the channel that you wish to watch. (STB)

7 ▶▶

- Rapidly advances the tape and allows picture search. (VCR)
- Hold down to fast forward. (BD, DVD)

8 ||

- Sets pauses and still pictures. (VCR, BD, DVD)

9 ▶▶▶

- Pressing quickly once takes you to the start of the next chapter. Each time you press it, you move ahead to the start of the next chapter. (BD, DVD)

10 FLASHBACK

- Press to switch between the current channel and the channel you were watching immediately before. Some manufacturers do not preset FLASHBACK. (STB)

11 CH▲▼

- Press **CH▲** or **CH▼** to tune in to a higher or lower channel. (STB)
- Press to select the channel of the TV tuner on the VCR. (VCR)

12 MENU

- When this button is pressed, the BD/DVD menu will display. (BD, DVD)

13 ▲▼◀▶, ENTER

- **▲▼◀▶**: Press the button to select items on the STB GUIDE screen or STB MENU screen. (STB)
- Press the button to select items on the BD/DVD menu screen. (BD, DVD)
- **ENTER**: Press to activate the selected function. (STB, BD, DVD)

Using AQUOS LINK

Controlling HDMI Equipment Using AQUOS LINK

What's AQUOS LINK?

- Using the HDMI CEC (Consumer Electronics Control) protocol, with AQUOS LINK you can interactively operate compatible system equipment (Blu-ray disc equipment, AV amplifier, DVD).
- By connecting AQUOS LINK-compatible devices with HDMI-certified cables to the TV, you can control a recorder or AV amplifier using the remote control of the TV.
- AQUOS LINK allows you to operate the HDMI-connected equipment with one remote control.

NOTE

- (UQ/TQ/SQ series) Connect 4K signals (HDCP2.2) to the HDMI IN 1 terminal. These signals will not be displayed if connected to the HDMI IN 2, 3, or 4 terminals.
- For connecting the TV to AQUOS LINK-compatible equipment, use commercially available cables.
- Point the remote control toward the TV, not to connected HDMI equipment.
- Video noise may occur depending on the type of HDMI cable used. Make sure to use an HDMI-certified cable.
- Up to 3 pieces of HDMI recording equipment and one AV amplifier can be connected using this system.
- These operations affect the HDMI equipment selected as the current input source. If the equipment does not operate, turn on the equipment and select the appropriate input source using **INPUT**.
- The AQUOS LINK feature may not operate properly when an HDMI splitter or AV selector unit is used. These devices may cause interruptions to the image and/or sound.

Connected AQUOS LINK-compatible devices can be operated without changing the settings of the remote control unit.

The **OPTION** button will function only when AQUOS LINK is used.

One Touch Play

While the TV is in standby mode, it automatically turns on and plays back the image from the HDMI source.

Single remote control

The AQUOS LINK automatically recognizes the connected HDMI device and you can control the TV and the devices as if using a universal remote control.

Control the AQUOS LINK-compatible audio system

Set the volume of AQUOS LINK-compatible audio system.

NOTE

- The above description is an example of the AQUOS LINK function.
- The steps in "AQUOS LINK Setup" on [page 7-2](#) need to be completed beforehand.
- Refer to this operation manual and the operation manual of the AQUOS LINK device to be used with this TV.

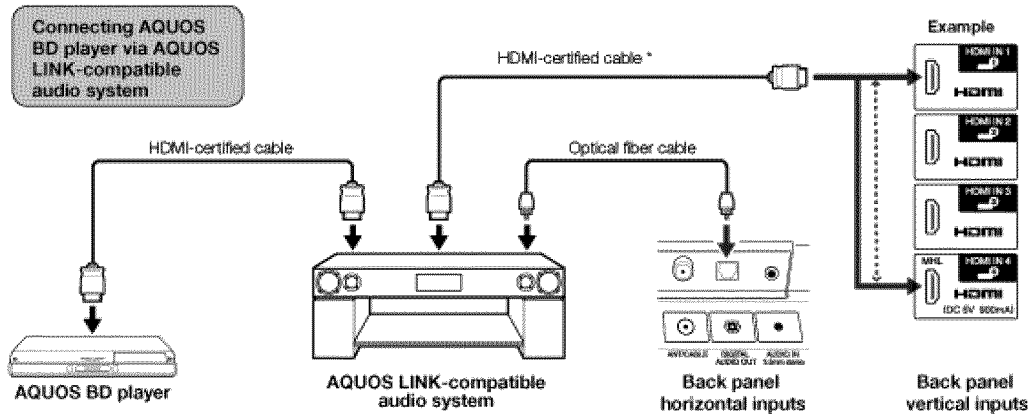

* (EQ/LE650U/C6500U/LE642U series) Use HDMI IN 1 to connect ARC-compatible equipment.
(UQ/TQ/SQ/LE657U series) Use HDMI IN 3 to connect ARC-compatible equipment.

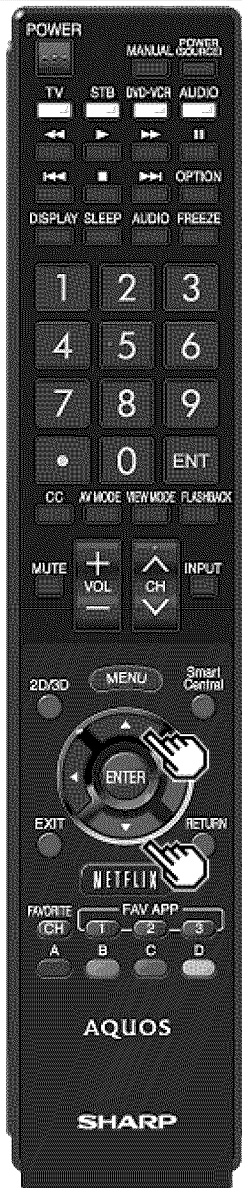

Controlling HDMI Equipment Using AQUOS LINK (Continue)

AQUOS LINK Setup

Make the settings to use AQUOS LINK. Set the settings with "Setup" > "Advanced" > "AQUOS LINK Setup".

AQUOS LINK Control

Select AQUOS LINK Control to disable the AQUOS LINK function even when an AQUOS LINK-compatible HDMI device is connected to the TV. This function prevents the device from starting to operate unexpectedly.

Auto Power On

If this is activated, the One Touch Play function is enabled. While the TV is in standby mode, it automatically turns on and plays back the image from the HDMI source.

Channel Select Key

This function can be set for each input terminal. The remote control unit of the TV can be used to select the channel, display program information, and perform other operations of the connected AQUOS LINK-compatible equipment.

Audio Return Channel

This function allows you to listen to the TV audio via audio equipment without using an optical fiber cable, which conventionally is required.

Requirements for using an ARC-compatible AV amplifier:

- ARC-compatible AV amplifier connected to the ARC-compatible HDMI IN terminal.
EQ/LE650U/C6500U/LE642U series:HDMI IN 1
UQ/TQ/SQ/LE657U series:HDMI IN 3
(Refer to the operation manual of the ARC-compatible equipment for details.)
 - Use of an ARC-compatible cable.
- Auto:** You can listen to the TV audio with ARC-compatible audio equipment.

Off: This function does not work.

NOTE

- If the TV audio cannot be output from the AV amplifier even after making the necessary settings, connect the TV to the AV amplifier with an optical fiber cable and select "Off".



Controlling HDMI Equipment Using AQUOS LINK (Continue)

One Touch Playback

AQUOS LINK allows you to operate the HDMI-connected equipment with one remote control.

Press **▶** to start playing back a title.

- The last played program is played back. You can use the following buttons during broadcast viewing.

Buttons	Description
POWER (SOURCE)	Turns the power of the HDMI connected devices on and off.
◀◀	Hold down this button to go in reverse.
▶	Starts playback.
▶▶	Hold down this button to fast forward.
■	Stops playback.
 	Sets pauses and still pictures.
◀◀◀	Pressing quickly once takes you to the start of the chapter currently playing. Each time you press it, you move back to the start of the previous chapter.
▶▶▶	Pressing quickly once takes you to the start of the next chapter. Each time you press it, you move ahead to the start of the next chapter.

NOTE

- The buttons **◀◀◀/▶▶▶** do not function with the following Blu-ray disc players currently available.
 - BD-HP20U, BD-HP50U

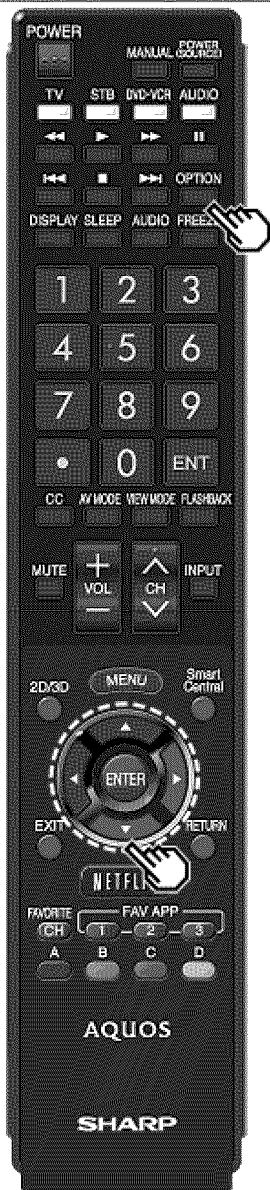

Link Operation Menu

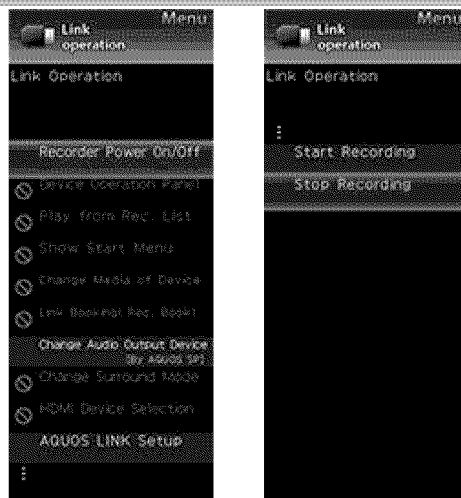

The Link Operation Menu allows you to make adjustments during operation of AQUOS LINK-compatible equipment.

- 1 Press **OPTION** to display the Link Operation Menu.
- 2 Press **▲▼** to select the desired item, and then press **ENTER**.
 - Specific operations differ depending on the item you select. Following are the basic operations for each item.

Recorder Power On/Off

You can manually turn on/off the power of the connected AQUOS LINK-compatible equipment. Each time you press **ENTER**, the connected equipment switches on or off.

Device Operation Panel

You can use the device operation panel to control playback operations.

Press **▲▼/◀▶** to select the desired operation.

NOTE

- This function works only when AQUOS LINK-compatible equipment with the Device Operation Panel function is connected.

Play from Rec. List

This function allows you to display the title list for the connected equipment and to play back the title you want to enjoy.

Before using this function.

Power on the AQUOS LINK-compatible equipment, and select the appropriate external input. Select the title with **▲▼/◀▶**, and then press **▶** to start playback.

NOTE

- This function works only when AQUOS LINK-compatible equipment is connected.

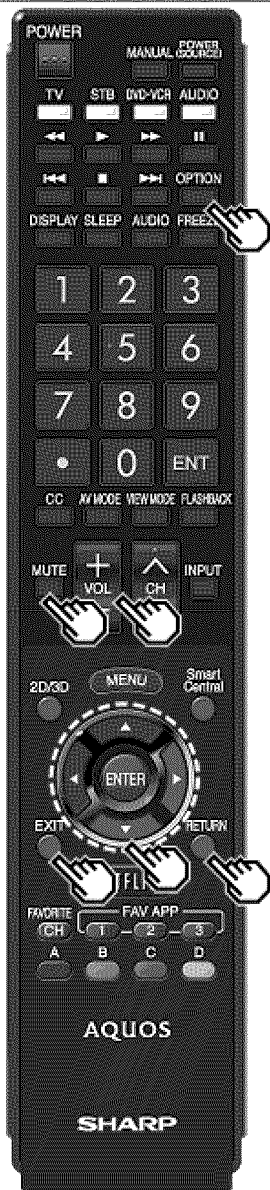

Link Operation Menu (Continue)

Show Start Menu

You can call up a setup menu from the connected AQUOS LINK-compatible equipment.

NOTE

- Depending on the status of the equipment (recording or in standby mode, etc), the setup menu will not be displayed.
- The setup menu will not be displayed with the player BD-HP20U currently available.

Change Media of Device

You can switch the media (HDD or DVD) for playback or recording on the AQUOS LINK-compatible recorder.

- The Media type toggles each time you press **ENTER** in "Change Media of Device".

Link Booking (Rec. Book)

You can call up the AQUOS LINK-compatible recorder's EPG and preset timer recordings using the TV's remote control.

Select the program on the recorder's EPG.

- You can use **▲▼◀▶**, **ENTER**, **RETURN**, **EXIT** and the colored buttons.

NOTE

- This function works only when an AQUOS LINK-compatible recorder is connected.
- Refer to the operation manual of the recorder for details.

Change Audio Output Device

You can select to listen to the TV sound only from the AQUOS LINK-compatible audio system.

- By AQUOS audio SP:** The sound from the TV speaker is muted and only the sound from the AQUOS LINK-compatible audio system is audible.
- You can use **VOL+/-** and **MUTE**.

By AQUOS SP: The sound is output from the TV speaker.

Change Surround Mode

You can manually change the AQUOS AUDIO speaker system's sound mode.

The sound mode changes each time you press **ENTER**.

- Refer to the operation manual of the AQUOS LINK-compatible audio system for details.

HDMI Device Selection

If multiple HDMI devices are connected in a daisy chain, you can specify which device to control here.

Press **▲▼** to select the desired device from a list of connected HDMI devices, and then press **ENTER**.

AQUOS Link Setup

You can also display the AQUOS LINK Setup screen from the Link Operation Menu.

Start/Stop Recording

You can also use the Link Operation Menu for recording on the connected AQUOS LINK-compatible equipment.



Using a Smartphone with the TV

This function enables you to connect the TV to a smartphone that supports Mobile High-Definition Link (MHL™) using an MHL cable.

To connect the TV to your MHL-compatible smartphone, be sure to use an MHL cable (commercially available).

- You can view pictures and video on a large screen.
- You can play back music files.

NOTE

- An MHL-compatible portable device is required to use this function. Connect the device to the HDMI IN 4 terminal.
- This product incorporates MHL 1.

Auto Power On

When an MHL-compatible device is connected to the TV, the TV turns on automatically.

- This function operates when "AQUOS LINK Control" is set to "On".
(See page 7-2.)

Auto Input Selection

When an MHL-compatible device is connected while the TV is on, the input mode is selected automatically.

- This function operates when "AQUOS LINK Control" is set to "On".
(See page 7-2.)

Operation Using the Remote Control

The remote control of the TV can be used to operate a portable device.

- ▲▼◀▶, ENTER, EXIT, 0-9, • (DOT), ENT, etc.
- The operations vary depending on the connected equipment and content being viewed.

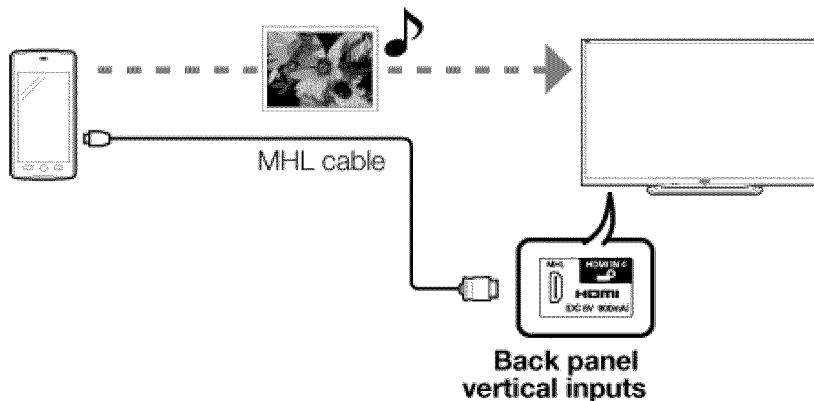

Using a PC

Adjusting the PC Image

You can adjust the position of the image input from a PC the settings with "Setup" > "Input Settings" > "PC input".

Auto Sync. (for Analog PC Input Mode Only)

For automatically adjusting the PC image.

Yes: Auto Sync. starts and "Now adjusting the image." displays.

No: This function does not work.

NOTE

- When "Auto Sync." is successful, "Completed" displays. If not, "Auto Sync." failed.
- "Auto Sync." may fail even if "Completed" displays.
- "Auto Sync." may fail if the computer image has low resolution, has unclear (black) edges, or is moved while executing "Auto Sync.".
- Be sure to connect the PC to the TV and switch it on before starting "Auto Sync.".

Fine Sync.

Ordinarily you can easily adjust the picture as necessary to change image position using "Auto Sync.". In some cases, however, manual adjustment is needed to optimize the image.

H-Pos.: Centers the image by moving it to the left or right.

V-Pos.: Centers the image by moving it up or down.

Clock: Adjust when the image flickers with vertical stripes.

Phase: Adjust when characters have low contrast or when the image flickers.

NOTE

- For resetting all "Fine Sync." adjustment items to the factory preset values, press ▲/▼ to select "Reset", and then press **ENTER**.
- It is not necessary to adjust the "Clock" or "Phase" when a digital signal is being input, so it cannot be selected.
- The default cursor position may not be in the center, because the screen position variable ranges may be asymmetrical.
- The screen position variable ranges depend on the View Mode or the signal type. The ranges can be seen on the position-setting screen.

Setting Audio Input

Audio Select

This function sets the terminal to output the computer audio. The adjustment items vary depending on the input source. Select the input source corresponding to the terminal connected to the PC and then adjust the desired item. To perform the operation, refer to "Setup" > "Advanced" > "Audio Select".

PC IN

Video: Select this when the TV and PC are connected using an analog RGB cable and the audio is not input.

Video+Audio: Select this when the TV and PC are connected using an analog RGB cable and the audio is input via a Ø 3.5 mm stereo minijack.

HDMI 2

HDMI(Digital): Select this when the TV and PC are connected using an HDMI-certified cable and audio is input via the same cable.

HDMI+Analog: Select this when the TV and PC are connected using a DVI-HDMI conversion cable and the audio is input via a Ø 3.5 mm stereo minijack.

NOTE

- When "Audio Select" is set to "HDMI(Digital)", sound will not be produced if you use only an HDMI-certified cable to connect HDMI-compatible equipment. To produce sound, you should make an analog audio connection.
- If you want to connect HDMI-compatible equipment using only an HDMI-certified cable, set "Audio Select" to "HDMI(Digital)".

Using a PC

Control of the TV

- The TV can be controlled from a PC, control panels and other devices using the RS-232C or IP.
- Use a cross-type RS-232C cable, ETHERNET cable (commercially available) or wireless LAN for the connections.

NOTE

- This operation system should be used by a person who is accustomed to using computers.

AQUOS Remote Control

Set this function when operating the TV from equipment connected by LAN or wireless LAN. To perform the operation, refer to "Smart TV".

Remote Control App

When "Remote Control App" is selected, "Change" will be highlighted. Press **ENTER**.

Detailed Settings

Make the detailed settings (Login ID, password, etc.).
Follow the on-screen instructions to configure the settings.

TV Name Setting

Set the name of the TV displayed on other network devices.

- Use the software keyboard to set the name.
[See page 9-5](#) for details on the software keyboard.

Communication Conditions for IP

Connect to the TV with the following settings made for IP on the PC.

IP protocol:	TCP/IP
Host IP address:	Set the IP address on the TV menu
Service:	None (Do not select Telnet or SSH)
TCP port#:	Set a port number on the TV menu (Control port)

When you set your ID and password on the TV menu, you need to enter them as soon as you connect to the TV.

NOTE

- When you use this function, make settings for "AQUOS Remote Control".
- The connection will be cut off when there has been no communication for 3 minutes.

Communication Conditions for RS-232C

Set the RS-232C communication settings on the PC to match the TV's communication conditions. The TV's communication settings are as follows:

Baud rate:	9,600 bps
Data length:	8 bits
Parity bit:	None
Stop bit:	1 bit
Flow control:	None

Communication procedure

Send the control commands from the PC via the RS-232C or IP.

The TV operates according to the received command and sends a response message to the PC. Do not send multiple commands at the same time.

Wait until the PC receives the OK response before sending the next command.

Using a PC

Control of the TV (Continue)

Command format

Eight ASCII codes +CR



Command 4-digits Parameter 4-digits Return code

Command 4-digits: Command. The text of four characters.

Parameter 4-digits: Parameter 0-9, x, blank, ?

Parameter

Input the parameter values, aligning left, and fill with blank(s) for the remainder. (Be sure that 4 values are input for the parameter.)

When the input parameter is not within an adjustable range, "ERR" returns. (Refer to "Response code format".)

Any numerical value can replace the "x" on the table.

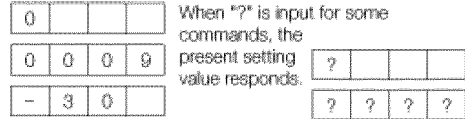

Response code format

Normal response

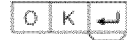

Return code (0DH)

Problem response

(communication error or incorrect command)



Return code (0DH)

Command table

- Commands not indicated here are not guaranteed to operate.

CONTROL ITEM		COMMAND				PARAMETER			CONTROL CONTENTS		
POWER ON COMMAND SETTING		R	S	P	W	0	-	-	-	Off	The Power On command rejected.
						1	-	-	-	On [RS-232C]	The Power On command accepted.
						2	-	-	-	On [IP]	The Power On command accepted.
POWER SETTING		P	O	W	R	0	-	-	-	Power Off	It shifts to standby.
						1	-	-	-	Power On	Power On
INPUT SELECTION	TOGGLE	I	T	G	D	x	-	-	-	(Toggle)	It input-switches by the toggle. (It is the same as an input change key)
	TV	I	T	V	D	0	-	-	-		It input-switches to TV. (A channel remains as it is. (Last memory))
	1-8	I	A	V	D	*	-	-	-	1: HDMI IN 1, 2: HDMI IN 2, 3: HDMI IN 3, 4: HDMI IN 4, 5: COMPONENT IN, 6: VIDEO IN 1, 7: VIDEO IN 2, 8: PC IN	

NOTE

- If an underbar (_) appears in the parameter column, enter a space.
- If an asterisk (*) appears, enter a value in the range indicated in brackets under CONTROL CONTENTS.
- Any numerical value can replace the "x" on the table.

Using a PC

Control of the TV (Continue)

CONTROL ITEM		COMMAND			PARAMETER			CONTROL CONTENTS				
AV MODE SELECTION		A	V	M	D	*	*	*	-	0: (Toggle), 1: STANDARD (ENERGY STAR)*1, 2: MOVIE, 3: GAME, 4: USER, 5: DYNAMIC (Fixed), 6: DYNAMIC, 7: PC, 8: x.v.Color, 13: VINTAGE MOVIE, 14: STANDARD (3D)/3D, 15: MOVIE (3D), 16: GAME (3D), 17: MOVIE THX, 100: AUTO	Although it can choose now, it is toggle operation in inside. 8, 13: For the UQ17U, TQ15U, SQ17U, SQ15U, SQ10U and EQ10U models. 14, 16: For the UQ17U, TQ15U, SQ17U, SQ15U and LE657U models. 15: For the LE657U model. 17: For the UQ17U models.	
VOLUME		V	O	L	M	*	*	*	-	Volume (0-100)		
POSITION	H-POSITION	H	P	O	S	*	*	*	-	The screen position variable ranges depend on the View Mode or the signal type. The ranges can be seen on the position-setting screen.		
	V-POSITION	V	P	O	S	*	*	*	-			
	CLOCK	C	L	C	K	*	*	*	-		Only PC mode. (0-180)	
	PHASE	P	H	S	E	*	*	-	-		Only PC mode. (0-40)	

*1: Except for LC-90LE657U

CONTROL ITEM	COMMAND				PARAMETER				CONTROL CONTENTS	
VIEW MODE	W	I	D	E	*	*	-	-	0: (Toggle) [AV], 1: Side Bar [AV], 2: S.Stretch [AV] 3: Zoom [AV], 4: Stretch [AV], USB-Video, Home Network Video or Internet applications], 5: Normal [PC] 6: Zoom [PC], 7: Stretch [PC], 8: Dot by Dot [PC] [AV], 9: Full Screen [AV] 10: Auto [USB-Video, Home Network Video or Internet applications], 11: Original [USB-Video, Home Network Video or Internet applications]	0: Although it can choose now, it is toggle operation in inside. 1: Only available when 4:3 signal is being input. 5, 6: Only available when 4:3 signal is being input. 8: [PC] Available except when UXGA is being input. [AV] Only available when 1080i/p is being input. 9: Only available when 720p is being input. 10, 11: Available when USB-Video, Home Network Video or Internet application is used.
MUTE	M	U	T	E	*	-	-	-	0: (Toggle), 1: On, 2: Off	

NOTE

- If an underbar (_) appears in the parameter column, enter a space.
- If an asterisk (*) appears, enter a value in the range indicated in brackets under CONTROL CONTENTS.
- Any numerical value can replace the "x" on the table.

Using a PC

Control of the TV (Continue)

CONTROL ITEM	COMMAND				PARAMETER				CONTROL CONTENTS
SURROUND	A	C	S	U	*	-	-	-	For the UQ17U, TQ15U, SQ17U, SQ15U and LE657U models: 0: (Toggle), 1: Normal, 2: Off, 4: 3D Hall, 5: 3D Movie, 6: 3D Standard, 7: 3D Stadium
									For the SQ10U, EQ10U, LE650U, C6500U and LE642U models: 0: (Toggle), 1: On, 2: Off
AUDIO SELECTION	A	C	H	A	x	-	-	-	(Toggle)
SLEEP TIMER	O	F	T	M	*	-	-	-	0: Off, 1: OFF TIMER - 30 MIN., 2: OFF TIMER - 60 MIN., 3: OFF TIMER - 90 MIN., 4: OFF TIMER - 120 MIN.

CONTROL ITEM		COMMAND				PARAMETER				CONTROL CONTENTS	
CHANNEL	DIRECT CHANNEL (ANALOG)	D	C	C	H	*	*	*	-	The channel number of TV (1-135)	An input change is included if it is not TV display. In Air, 2-69ch is effective. In Cable, 1-135ch is effective.
	DIRECT CHANNEL (DIGITAL)	D	A	2	P	*	*	*	*	(0100-9999)	DIGITAL Air (Two-Part numbers, 2-digit plus 2-digit)
		D	C	2	U	*	*	*	-	(1-999)	DIGITAL Cable (Two-Part numbers, 3-digit plus 3-digit) Front half of DIGITAL CABLE CHANNEL NO. (Designate major channel)
		D	C	2	L	*	*	*	-	(0-999)	DIGITAL Cable (Two-Part numbers, 3-digit plus 3-digit) Rear half of DIGITAL CABLE CHANNEL NO. (Designate minor channel)

NOTE

- If an underbar (_) appears in the parameter column, enter a space.
- If an asterisk (*) appears, enter a value in the range indicated in brackets under CONTROL CONTENTS.
- Any numerical value can replace the "x" on the table.

Using a PC

Control of the TV (Continue)

CONTROL ITEM		COMMAND				PARAMETER				CONTROL CONTENTS	
CHANNEL	DIRECT CHANNEL (DIGITAL)	D	C	1	0	*	*	*	*	(0-9999)	DIGITAL Cable (One-Part numbers, 5-digit, less than 10,000)
		D	C	1	1	*	*	*	*	(0-6383)	DIGITAL Cable (One-Part numbers, 5-digit, more than 10,000)
	CH UP	C	H	U	P	x	-	-	-	The channel number of TV +1	If it is not TV display, it will input-switch to TV. (same function as CH \wedge)
	CH DOWN	C	H	D	W	x	-	-	-	The channel number of TV -1	If it is not TV display, it will input-switch to TV. (same function as CH \vee)
CC	C	L	C	P	x	-	-	-	(Toggle)	Toggle operation of a closed caption.	
DEVICE NAME	T	V	N	M	1	-	-	-		The device name set in "TV Name Setting" is displayed.	
MODEL NAME	M	N	R	D	1	-	-	-		The model name of the TV	















CONTROL ITEM	COMMAND				PARAMETER			CONTROL CONTENTS		
SOFTWARE VERSION	S	W	V	N	1	-	-	-	The current version of the TV software is displayed.	
IP PROTOCOL VERSION	I	P	P	V	1	-	-	-	The currently supported version of IP protocol is displayed.	
3D	T	D	C	H	*	-	-	-	0: 3D Off, 1: 2D \rightarrow 3D, 2: SBS, 3: TAB, 4: 3D \rightarrow 2D (SBS), 5: 3D \rightarrow 2D (TAB), 6: 3D auto, 7: 2D auto	0,1,2,3,6,7: For the UQ17U, TQ15U, SQ17U, SQ15U and LE657U models.

NOTE

- If an underbar ($_$) appears in the parameter column, enter a space.
- If an asterisk (*) appears, enter a value in the range indicated in brackets under CONTROL CONTENTS.
- Any numerical value can replace the "x" on the table.

Using a PC

Control of the TV (Continue)

CONTROL ITEM	COMMAND				PARAMETER				CONTROL CONTENTS
REMOTE CONTROL BUTTONS	R	C	K	Y	*	*	-	-	0-9: 0-9, 10: DOT, 11: ENT, 12: POWER, 13: DISPLAY, 14: POWER (SOURCE) 15:  , 16:  , 17:  , 18:  , 19:   , 20:  , 21:   , 23: OPTION, 24: SLEEP, 27: CC, 28: AV MODE, 29: VIEW MODE, 30: FLASHBACK, 31: MUTE, 32: VOL -, 33: VOL +, 34: CH  , 35: CH  , 36: INPUT, 38: MENU, 39: SmartCentral, 40: ENTER, 41:  , 42:  , 43:  , 44:  , 45: RETURN, 46: EXIT, 47: FAVORITE CH, 49: AUDIO, 50: A (red), 51: B (green), 52: C (blue), 53: D (yellow), 54: FREEZE, 55: FAV APP 1, 56: FAV APP 2, 57: FAV APP 3, 58: 2D/3D, 59: NETFLIX, 60: AAL, 61: MANUAL

NOTE

- If an underbar (_) appears in the parameter column, enter a space.
- If an asterisk (*) appears, enter a value in the range indicated in brackets under CONTROL CONTENTS.
- Any numerical value can replace the "x" on the table.

Using a PC

PC Compatibility Chart

It is necessary to set the PC correctly to display XGA and WXGA signal.

Resolution		Horizontal Frequency	Vertical Frequency	VESA Standard
VGA	720 x 400	31.5 kHz	70 Hz	—
	640 x 480	31.5 kHz	60 Hz	○
		37.9 kHz	72 Hz	○
SVGA	800 x 600	37.5 kHz	75 Hz	○
		35.1 kHz	56 Hz	○
		37.9 kHz	60 Hz	○
		48.1 kHz	72 Hz	○
XGA	1024 x 768	46.9 kHz	75 Hz	○
		48.4 kHz	60 Hz	○
		56.5 kHz	70 Hz	○
WXGA	1360 x 768	60.0 kHz	75 Hz	○
		47.7 kHz	60 Hz	○
SXGA	1280 x 1024	64.0 kHz	60 Hz	○
SXGA+	1400 x 1050	65.3 kHz	60 Hz	○
UXGA	1600 x 1200	75.0 kHz	60 Hz	○
1080p	1920 x 1080	67.5 kHz	60 Hz	—

VGA and XGA are registered trademarks of International Business Machines Corp.

Using the Internet

By connecting your TV to a broadband system, you can access the Internet from the TV.

- You can enjoy a variety of streaming content and Internet applications. (See pages 9-12 to 9-14.)

NOTE

- You may not be able to view 3D images when accessing the Internet. (For the UQ17U, TQ15U, SQ17U, SQ15U and LE657U models)

Connecting to the Internet

- To connect your TV to the Internet, you must have a broadband Internet connection.
- If you do not have a broadband Internet connection, consult the store where you purchased your TV or ask your Internet service provider or telephone company.
- When an Internet connection is made, an Ethernet and wireless connection cannot be used at the same time. Use only one of the connection types.

Using an ETHERNET cable

Use an ETHERNET cable (commercially available) to connect the ETHERNET terminal on the TV to your broadband router (commercially available).

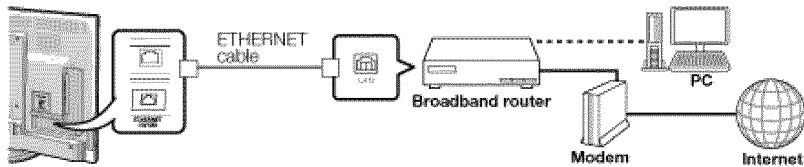

Using the wireless LAN

This TV is equipped with a wireless LAN function.

For a wireless LAN connection, you must use "Wireless Setup" to connect the access point and TV.



NOTE

- This TV has a built-in wireless LAN function. Using a separate wireless USB LAN adapter may result in radio communications that do not comply with regulations on radio communications. Therefore, do not use a separate wireless LAN adapter.
- A wireless LAN connection and performance cannot be guaranteed for all residential environments. In the following cases, the wireless LAN signal may be poor or drop, or the connection speed may become slower.
 - When used in buildings made with concrete, reinforced steel, or metal
 - When placed near objects that obstruct the signal
 - When used with other wireless devices that emit the same frequency
 - When used in the vicinity of microwave ovens and other devices that emit a magnetic field, electrostatic charge, or electromagnetic interference
- When there is significant interference in the 2.4-GHz frequency (such as from other wireless LAN devices, Bluetooth® devices, 2.4-GHz cordless telephones, and microwave ovens), it is recommended that you use a wireless LAN router/access point that supports IEEE802.11a/n (5 GHz) and set the access point to transmit at 5 GHz. For setup details, see the operation manual of your access point.



Internet Setup

Perform the procedure below to make adjustments or to confirm the settings for accessing the Internet.

- 1 Press **MENU** to display the MENU screen, and then press **ENTER**.
- 2 Press **Left/Right** to select "Smart TV", and then press **ENTER**.
- 3 Press **Up/Down** to select "Internet Setup", and then press **ENTER**.
- 4 Press **Up/Down** to select "Internet Connection" or "Interactive Service", and then press **ENTER**.
 - Select "Internet Connection" when you make general adjustments to connect to the Internet.
 - If you want to make settings to restrict access to the Internet, then select "Interactive Service".
- 5 Press **Up/Down** to select a specific item, and then press **ENTER**.
- 6 Press **Up/Down** (or **Left/Right**) to select the desired setting, and then press **ENTER**.
- 7 Press **MENU** to exit.

Internet Connection

You can connect your TV to the Internet using the setting item "Internet Connection".

Auto Setup

Adjustments for network connection will be made automatically. Select "Wired" or "Wireless" and follow the instructions displayed on the screen.

- Automatic adjustments for wireless LAN connection can be made only for the WPS method. If your access point uses any other method, perform "Manual Setup". Select the desired connection method and follow the instructions shown on the display.

Manual Setup

You can make adjustments manually for network connection.

Connection Type

Select the connection type.

Wired: The signal is detected and setup is performed automatically. Use "IP Setup" to check and change the settings as necessary.

Wireless: Configure the access point settings on "Wireless Setup".



Internet Setup (Continue)

Wireless Setup

Make adjustments and confirm the settings necessary for wireless LAN connection (such as search for the access point and registration of it).

WPS push button: Allows the TV to automatically establish the connection using a button on the access point.

WPS PIN code: Sets up the connection by registering a PIN code for the access point.

Selecting wireless network: Searches for and selects the access point to be connected.

Registering wireless network: Allows you to make the connection by entering an SSID for the access point.

If your access point supports Wi-Fi Protected Setup (WPS push button method), it is recommended that you use this function for the wireless connection. You can press the WPS button on the access point to configure the settings automatically.

- The name of the WPS button function may differ depending on the access point. See the operation manual of the access point for details.

1 Confirm the current settings in "Connection Type".

- If "Wired" is selected, press **◀▶** to select "Wireless".

2 Press **▲▼** to select "Wireless Setup", and then press **ENTER**.

- Confirm the settings. If each setting item is correct, press **MENU** to exit.
- If you are configuring the wireless setup for the first time or changing the settings, go to step 3.

3 Press **◀▶** to select "Change", and then press **ENTER**.

4 Select the desired connection method and follow the instructions shown on the display.

5 When a connection is established, the connection details are displayed. Press **ENTER**.

NOTE

- Operations cannot be guaranteed when used with access points that do not have Wi-Fi® certification.
- A wireless LAN router/access point is required to connect the TV to the Internet using a wireless LAN. See the operation manual of your access point for setup.
- If your access point is set to a stealth mode (that prevents detection by other devices), you may not be able to establish a connection. In this case, disable the stealth mode on the access point.
- A stable connection speed is required to play back streaming content. Use an Ethernet connection if the wireless LAN speed is unstable.
- Before transferring to a third party or disposal, be sure to initialize the wireless LAN settings.
- Please follow the legislation in your country when using the wireless LAN outdoors.

IP Setup

You can make adjustments manually for the IP.

- Check that numbers are displayed for each setting.
- If there are any settings without numbers, specify the numbers by following the on-screen instructions.
- Input the IP address by using remote control buttons 0-9.

Example

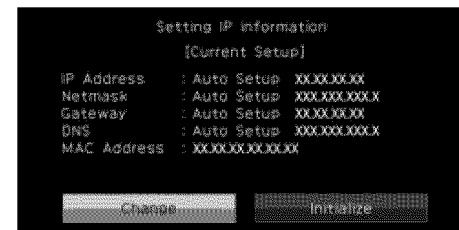

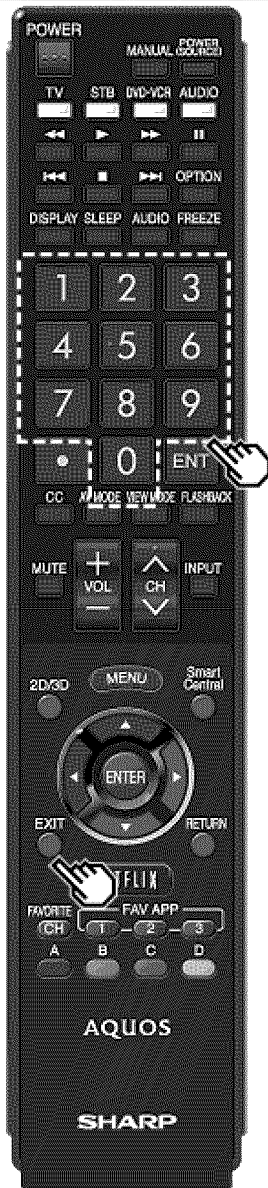

Internet Setup (Continue)

Connection Test

After the connecting and setting procedures have been completed, you can check that the preparation is correct. Press "Yes" to start the "Connection Test".

- When the test results are displayed, follow the instructions shown on the screen.

Interactive Service

If you do not want other people to connect to the Internet in your absence, you can make settings to keep the TV away from the Internet.

- Input the 4-digit secret number by using **0-9**.

NOTE

- If you have failed to connect to the Internet in the above operation, then an error message will appear. In this case, press **EXIT** to exit from the connected TV feature to make changes to the network settings.
- If you still cannot connect to the Internet, please consult your Internet service provider or telephone company.
- When an application is used, you cannot make settings for "Internet Setup".
If you need to make the settings of "Internet Setup", press **EXIT** to exit from the connected TV feature.

If you cannot connect to the Internet

If the TV fails to connect to the Internet, then select "Internet Connection" and;

- When the TV is in a wired LAN connection, make sure the values for "IP Setup" are all correctly set.
- In the case of a wireless LAN connection, check the settings of "Wireless Setup".



Entering Text (Software Keyboard)

When you are editing an input screen or specifying the Network settings used for accessing the Internet, enter text from the software keyboard.

NOTE

- You can enter up to 128 characters for text.
- Some special characters or diacritics may not be available depending on where you enter the text.

The text you enter is displayed as you type it in.

To move the cursor (the current input position), use "**<=**" or "**=>**" on the software keyboard.



While you are entering text, likely input conversion candidates are displayed based on what you typed in.

Caps Off/Caps Lock

If "alphabet" is selected, this switches characters between uppercase and lowercase.

Each time you press **ENTER**, the character type switches as shown below:

Caps Off: all the characters are lowercased

Caps Lock: all the characters are uppercased

Shift

Capitalizes the first character entered.

alphabet/Sign

Press **ENTER** to select the type of characters entered: alphabet, or sign.

Back space/Delete

Erases text one character at a time.



Entering Text (Software Keyboard) (Continue)

Enter

Applies the entered information and closes the software keyboard.

Space

Enters a space.

Clear

Erases the character string.

- When the cursor is somewhere in a line: the character string to the right of the cursor will be erased.
- When the cursor is at the right end of a line: the entire line will be erased.

Quit

Closes the software keyboard without applying the entered information.

Buttons on the remote control unit	Description
▲▼◀▶	Moves the focus. When moved at the far edge, the focus moves to the opposite edge.
ENTER	Performs the processing for the button currently in the focus.
EXIT	Closes the software keyboard without applying the original input elements for the entered text.
RETURN	When the cursor is at the end of a sentence, this acts as a back space.
0-9	Directly enters the single-byte number for that button.
A, B, C	When A, B or C is pressed on the remote control while the characters to be entered in the likely input conversion candidate are displayed in A, B or C on the keyboard, that character string is entered into the display field.
D	Enters a space



Using the Browser

- 1 Press **SmartCentral**, press (or or) to select the browser icon from the application window, and then press **ENTER**.
 - Press **SmartCentral** again to display a list of applications by category.

Buttons for Using the Browser

VIEW MODE

- Each time you press **VIEW MODE** when a browser screen is shown, the display pattern toggles between a website-only screen and a TV+Web screen.

FAV APP1, 2, 3 (TV+Web)

- You can change the screen display method when a Web browser application is assigned to the **FAV APP** buttons. Each time a **FAV APP** button assigned to a browser application is pressed while a browser is open, the screen switches between Web-site only screen and TV+Web screen.

ENTER, , , ,

- Press , , , to select a link that you want to jump, and then press **ENTER**.

EXIT

- Press the button to return to the TV screen.

RETURN

- Press the button to return to the previous page.

D

- Display the toolbar.

NOTE

- You cannot play audio or movies in the browser screen while a TV+Web screen is displayed.
- When displaying TV+Web with a channel in which the V-Chip is enabled, the cursor keys on the remote control unit do not function.
- Restrictions apply to window display.



Using the Browser (Continue)

Pages with security protection, "🔒" will be displayed.



Selected item	Description
	Allows you to go back to the previous page.
	Allows you to go to the next page.
	Refreshes the page. Interrupts a page while it is loading.
	Switches between virtual mouse and spatial navigation modes. Switching modes also switches the display. Depending on the page displayed, switching this function may make it easier to use the browser.
	Opens a search window below the toolbar. You can use this to search for a word within the displayed page.
	Displays the home page. You can set the page displayed as your home page when the browser starts up. (See page 9-10.)

Selected item	Description
	Displays the bookmarks list.
	Displays your browsing history.
	Configures browser settings such as your home page and browsing security. (See page 9-10.)
	Zooms the display in or out.
	Restrictions apply to window display.

Using the Toolbar

You can use the toolbar to control the browser and to specify settings.

- 1 Press **D** to control the toolbar.
- 2 Press **◀▶** to select a function, and then press **ENTER**.

Browsing Web Contents

You can display the web content you want to enjoy.

- 1 Press **D** to display the toolbar.
- 2 Press **◀▶** to move to the address area in the toolbar, and then press **ENTER**.
 - The Enter Address menu is displayed.
- 3 Enter an address, and then press **ENTER**.
 - The web content you want to view is displayed.



Using the Browser (Continue)

CAUTION

- If the power is cut due to a power failure or the TV being unplugged while you are using the Internet, information such as bookmarks or cookies may not be saved correctly.

NOTE

When a security notification window is displayed:

- Press **ENTER** to close the window.
- This window appears when you visit a web page that has security protection, or when you move from a protected page to an unprotected page.
- In "Security" you can set whether or not this window is displayed.
(See page 9-10.)

To users who access the Internet from a PC

- When you access the Internet from this TV, the procedures may not be the same as regular browser-based access on a PC.
- On some pages, video and audio, text or images may not be displayed correctly.

About links

- Web pages on the Internet often include "links" that allow you to jump to other web pages (or sites).
- "Links" can take various forms, including words or images, but they always work in the same way letting you jump to the link destination when you select them.
- Selected items (such as links of text input fields) are enclosed in a frame.
- You can jump from a "link" to the corresponding link destination.

DISCLAIMERS

SHARP corporation bears no responsibility regarding the content and quality of the content provided by the content serve provider.

powered
by  espial

<http://www.espial.com>



Using the Browser (Continue)

Browser Settings

You can check or modify your browser settings from the Browser menu.

- 1 Press **D** to display the toolbar.
- 2 Press to select " " in the toolbar, and then press **ENTER**.
- 3 Press to select and confirm the item you want to set.
- 4 Press to specify the required setting, and then press **ENTER**.
- 5 Press **D** to exit.

Home Page: You can set the page displayed as your home page when the browser starts up.

Encoding: You can select the desired encoding from the list below:

Western (ISO-8859-1)/Unicode (UTF-8)

Page Information: Displays information about the currently displayed page.

Security:

Secure sites:

When set to "Disabled", HTTPS sites cannot be accessed.

Security warnings:

When set to "Enabled", displays warning dialogs when going HTTP ↔ HTTPS.

Certificates: Display the list of certificates. You can choose to enable/disable a certificate.

- Disable certificate are shown unticked in the certificate list screen.

Cookies:

Accept all: Select this option to accept all cookies.

Reject all: Select this option when you do not want to accept cookies.

Delete All Cookies: Deletes all your cookies.

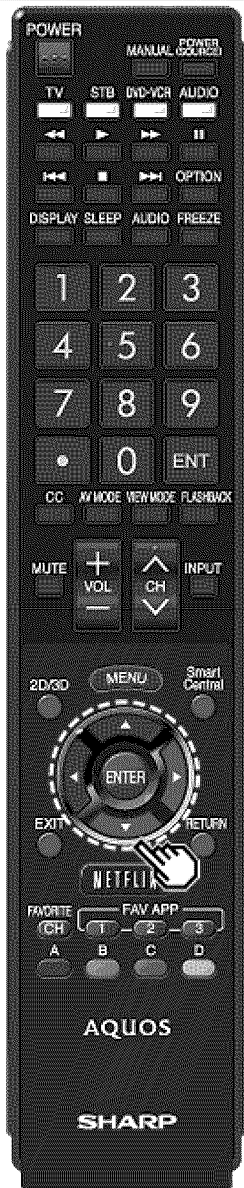

Using Keyboard and Mouse

You can use a keyboard or mouse for operating the TV while using the browser.

- When you use the USB devices, connect the device to the USB terminal on the TV.
- When you use the bluetooth device, make necessary settings with "Bluetooth".
(See page 4-24.) (For the UQ17U, TQ15U, SQ17U, SQ15U, SQ10U and LE657U models)

NOTE

- The keyboard and mouse can only be used on a browser screen.
The keyboard or mouse may not operate properly depending on the application being used.
- The software keyboard cannot be used by the keyboard and mouse connected via Bluetooth even on the browser screen.
- The bluetooth device may not operate properly depending on the device being used.



Using Applications via the Internet

By connecting the TV to the Internet, you can enjoy a variety of broadband content, including videos, music and photos.

Please check that the most current software is loaded on TV by selecting "Auto Update Setting" on "Software Update" (see page 4-32) or by visiting <http://www.sharpusa.com/products/support/> to check for a download of the newest software version.

Use the application window to access your favorite Internet applications. Press **SmartCentral** to display the application window.

Follow the on-screen instructions for each application.

- When using this TV to access an Internet application for the first time, the Disclaimer appears on the screen. Press ▲▼ to select "Agree", and then press **ENTER**. (You must select "Agree" to use the application.)
- Check the web site of the provider for details on setup and use of the functions.

NOTE

- If "📶" or "📶" is displayed after you connect to the Internet, check your TV's network settings and connection.
- Additional applications will be available in the future.
- These applications are provided by content providers. The available applications vary depending on your country or region.
- The delivery speed of applications varies depending on the network speed. Check the web site of the provider for details on application setup and other information.

Using the Application Window

During Dock Display

You can move the application icons and delete any unused icons.

Example



- 1 Select an application, and then press ▲.
- 2 Press ▲▼ to select "Move App" or "Delete App", and then press **ENTER**.

Move the Icons

You can move the icons of the more commonly used applications closer to the left.

Press ◀▶ to move the icon to the desired location.

Delete an Application

Select "Delete App" to delete the icon.

Saving Favorite Applications

You can set your favorite applications to the **FAV APP1**, **2**, and **3** buttons on the remote control for easier startup.

The applications whose icons are moved onto ①, ② and ③ during Dock Display will be assigned to the **FAV APP 1**, **2** and **3** buttons respectively.

NOTE

- The SmartCentral icon cannot be moved or deleted.

Using the Internet

Using Applications via the Internet (Continue)

During Gallery Display

During Dock display, press **SmartCentral** again to display a list of applications by category.



1 Press **◀▶** to select a category, and then press **ENTER** or **▼**.

2 Press **▲▼/◀▶** to select an application, and then press **ENTER**.

① Displays the categories.

TV: Displays broadcast programs.

Streaming: Displays VOD content.

Apps: Displays various apps offered by AQUOS.

Search: Allows you to search broadcast programs and VOD.

Settings: Allows you to configure various settings for this function.

② Displays a list of contents and applications for the selected category.

③ Displays the image now playing.

④ Provides a description of the selected item.

Deactivating Netflix Function

You can deactivate the Netflix function. Refer to "Information" > "Netflix Help" and select "Deactivate".

- To confirm the Netflix status, check the information displayed on the screen and click "OK".

Deactivating the VUDU Function

To deactivate the VUDU function, refer to "Information" > "VUDU Help" and select "Yes". When you access the Internet application for the first time, the following appears.

- This message is available only in English.



Using Applications via the Internet (Continue)

SmartCentral TV/Streaming

When "TV" or "Streaming" is selected on the SmartCentral screen, a list of broadcast programs or VOD is displayed.

- ①(TV)Guide: Displays a list of all broadcast programs.
(Streaming)New: Displays a list of new content.
- ②Popular: Displays popular programs.
- ③Favorites: Displays programs/content sorted by favorite genre as set in Settings.



NOTE

- To display broadcast programs, you must set your ZIP code and TV provider on the Settings screen.
- To display streaming content, you must select the apps on the Settings screen. However, the set apps may not be displayed on the list depending on the region.

SmartCentral Search

You can search across broadcast programs and VOD.

AQUOS Advantage Live

When you select this app on the SmartCentral screen, you can use the remote support function from the support center and display the network status.

DISCLAIMERS

- This SHARP device facilitates the access to content and services provided by third parties. The content and services accessible via this device belong to and may be proprietary to third parties. Therefore, any use of such third party content and services must be in accordance with any authorization or terms of use provided by such content or service provider. SHARP shall not be liable to you or any third party for your failure to abide by such authorization or terms of use. Unless otherwise specifically authorized by the applicable content or service provider, all third party content and services provided are for personal and non-commercial use; you may not modify, copy, distribute, transmit, display, perform, reproduce, upload, publish, license, create derivative works from, transfer or sell in any manner or medium any content or services available via this device.
- SHARP is not responsible, nor liable, for customer service-related issues related to the third party content or services. Any questions, comments or service-related inquiries relating to the third party content or service should be made directly to the applicable content or service provider.
You may not be able to access content or services from the device for a variety of reasons which may be unrelated to the device itself, including, but not limited to, power failure, other Internet connection, or failure to configure your device properly. SHARP, its directors, officers, employees, agents, contractors and affiliates shall not be liable to you or any third party with respect to such failures or maintenance outages, regardless of cause or whether or not it could have been avoided.
- ALL THIRD PARTY CONTENT OR SERVICES ACCESSIBLE VIA THIS DEVICE IS PROVIDED TO YOU ON AN "AS-IS" AND "AS AVAILABLE" BASIS AND SHARP AND ITS AFFILIATES MAKE NO WARRANTY OR REPRESENTATION OF ANY KIND TO YOU, EITHER EXPRESS OR IMPLIED, INCLUDING, WITHOUT LIMITATION, ANY WARRANTIES OF MERCHANTABILITY, NON-INFRINGEMENT, FITNESS FOR A PARTICULAR PURPOSE OR ANY WARRANTIES OF SUITABILITY, AVAILABILITY, ACCURACY, COMPLETENESS, SECURITY, TITLE, USEFULNESS, LACK OF NEGLIGENCE OR ERROR-FREE OR UNINTERRUPTED OPERATION OR USE OF THE CONTENT OR SERVICES PROVIDED TO YOU OR THAT THE CONTENT OR SERVICES WILL MEET YOUR REQUIREMENTS OR EXPECTATIONS.
- SHARP IS NOT AN AGENT OF AND ASSUMES NO RESPONSIBILITY FOR THE ACTS OR OMISSIONS OF THIRD PARTY CONTENT OR SERVICE PROVIDERS, NOR ANY ASPECT OF THE CONTENT OR SERVICE RELATED TO SUCH THIRD PARTY PROVIDERS.
- IN NO EVENT WILL SHARP AND/OR ITS AFFILIATES BE LIABLE TO YOU OR ANY THIRD PARTY FOR ANY DIRECT, INDIRECT, SPECIAL, INCIDENTAL, PUNITIVE, CONSEQUENTIAL OR OTHER DAMAGES, WHETHER THE THEORY OF LIABILITY IS BASED ON CONTRACT, TORT, NEGLIGENCE, BREACH OF WARRANTY, STRICT LIABILITY OR OTHERWISE AND WHETHER OR NOT SHARP AND/OR ITS AFFILIATES HAVE BEEN ADVISED OF THE POSSIBILITY OF SUCH DAMAGES.

Examples of Application Logos



Using the Bluetooth (For the UQ17U, TQ15U, SQ17U, SQ15U, SQ10U and LE657U models)/

Miracast devices (For the UQ17U, TQ15U, SQ17U, SQ15U, SQ10U and EQ10U models)



Using the Bluetooth/Miracast devices

Bluetooth device

You can listen to music from your TV when you connect a smartphone or other Bluetooth music player to your TV.

And when "Quick Start Mode" is set to "ON", you can also turn on your TV with a Bluetooth signal. (The TV automatically goes to the Bluetooth Music playback screen)

- 1 Switch the TV input to "Bluetooth".

NOTE

- Before using a Bluetooth device, you must pair it to the TV with "Menu" > "Smart TV" > "Bluetooth" > "Pairing New Device" > "Other Devices Setting".
- When the Miracast device is connected to the TV over a wireless LAN, Miracast video may be distorted and Miracast audio may be interrupted depending on the status of the Miracast device's connection to the access point.

Miracast device

When you connect a device such as a Miracast-compatible smartphone or tablet to this TV, you can enjoy video and audio from the device on the TV's large screen and speakers.

- 1 Switch the TV input to "Screen Sharing".
- 2 Enable the Miracast function on the Miracast device and connect to the TV. (The TV screen changes according to the behavior of the device)

NOTE

- When the TV is turned off or the connection is ended on the device, you must connect the device again.
- When connecting using a PIN code, first select the corresponding menu on the "Miracast Screen Sharing" menu, and then perform the operations from step 1.
- If you want to specify the preferred band to use with this function, select the corresponding menu on the "Miracast Screen Sharing" menu.
- For details about the operation of the Miracast-compatible device, check the manual for that device.
- When the Bluetooth device is connected to the TV over a wireless LAN, Bluetooth audio may be interrupted depending on the status of the Bluetooth device's connection to the access point.

Removing the Stand

- Before detaching (or attaching) the stand, make sure to turn off the TV and unplug the AC cord.

CAUTION

- Do not remove the stand from the TV unless using an optional wall mount bracket to mount it.

1 ① Loosen the screw(s) used to secure the stand cover.

② Remove the cover.

Example

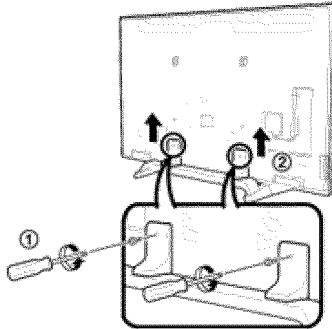

2 Unfasten the four screws used to secure the stand in place.

Example

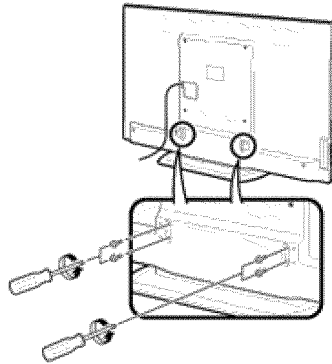

3 Detach the stand from the TV.

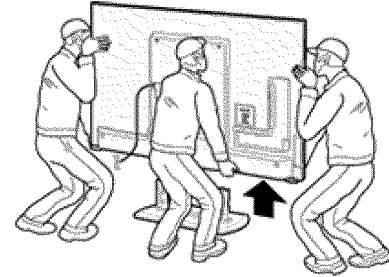

NOTE

- Be sure to always carry the TV by two people (90/80 inch models: three people) holding it with two hands.
- In the installation procedure, be careful not to catch your fingers between the TV set and the floor.

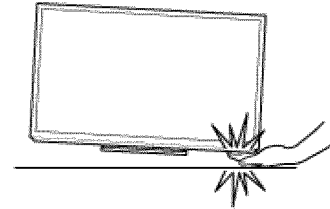

Appendix

Setting the TV on the Wall

Using an optional bracket to mount the TV

- You can ask a qualified service professional about using an optional AN-52AG4 bracket to mount the TV on the wall.
- Carefully read the instructions that come with the bracket before beginning work.

CAUTION

- This TV should be mounted on the wall only with the wall mount bracket AN-52AG4 (SHARP). The use of other wall mount brackets may result in an unstable installation and may cause serious injuries.
- Installing the TV requires special skill that should only be performed by qualified service personnel. Customers should not attempt to do the work themselves. SHARP bears no responsibility for improper mounting or mounting that results in accident or injury.

The wall mount kit (sold separately) allows you to mount the TV on the wall. For detailed information on installing the wall mount, see the instructions provided with the product. We recommend you to contact a technician for assistance when installing it. SHARP is not responsible for any damage to the product or injury to yourself or others if you elect to install the wall mount on your own.

CAUTION

- Install your wall mount on a solid wall perpendicular to the floor. When you want to attach the wall mount to surfaces other than plaster board, please contact your nearest retailer/adviser for additional information. If you install the TV on a ceiling or slanted wall, it may fall and result in severe personal injury. Always have two people mount the TV on a wall.

NOTE

- Due to the terminal configuration on this TV, when you wall-mount this model, make sure there is enough space between the wall and the TV for the cables.
- To use this TV mounted on a wall, remove the AC cord holder on the rear of the TV, and then use the screws supplied with the wall mount bracket to secure the bracket to the rear of the TV.

Hanging on the wall

AN-52AG4 wall mount bracket.
(See the bracket instructions for details.)

Hanging on the wall

AN-52AG4

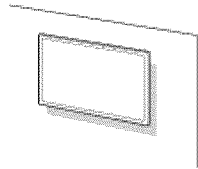

Vertical mounting

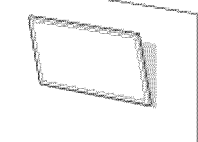

Angular mounting

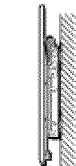

LC-70UQ17U/LC-70TQ15U

- The "c" position is at the center of the display.

LC-70SQ17U/LC-70SQ15U/LC-70SQ10U/LC-70EQ10

- The center of display : 7/16 inch (11mm) above the "c" position.

LC-70LE650U/LC-70C6500U

- The center of display : 25/64 inch (10mm) above the "c" position.

LC-60UQ17U/LC-60TQ15U

- The "c" position is at the center of the display.

LC-60SQ17U/LC-60SQ15U/LC-60SQ10U/LC-60EQ10U

- The center of display : 1/4 inch (6mm) above the "e" position.

LC-60LE650U/LC-60C6500U

- The "e" position is at the center of the display.

- Refer to the operation manual of AN-52AG4 for details.

NOTE

- The UQ and TQ series cannot be mounted on a wall at an angle.

Setting the TV on the Wall(Continue)

LC-70UQ17U/LC-70TQ15U/LC-70SQ17U/LC-70SQ15U/LC-70SQ10U/
 LC-70EQ10U/LC-60UQ17U/LC-60TQ15U/LC-60SQ17U/LC-60SQ15U/
 LC-60SQ10U/LC-60EQ10U

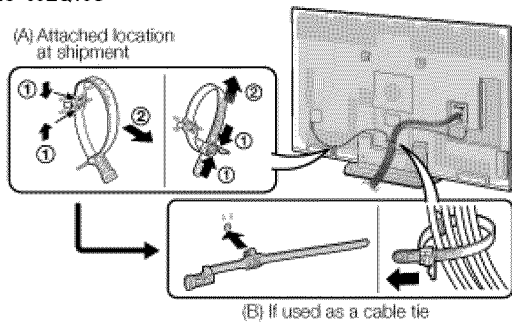

- The location of the AC cord holder differs depending on whether it is in its shipment location (A) or has been used as a cable tie (B).

LC-70LE650U/LC-70C6500U/LC-60LE650U/LC-60C6500U

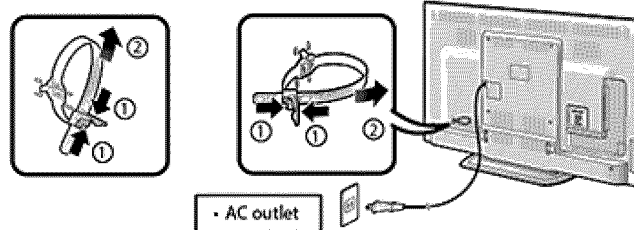

LC-80UQ17U/LC-80LE650U/LC-90LE657U/LC-80LE642U

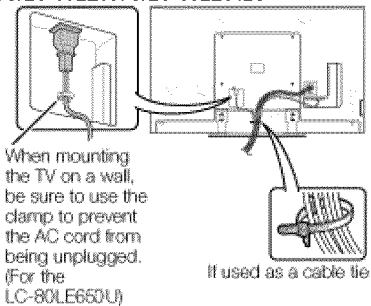

Appendix

Setting the TV on the Wall(Continue)

Wall Mount Kit Specifications

Standard dimensions for wall mount kits are shown below.

- The illustration is based on the LC-80UQ17U model as an example.

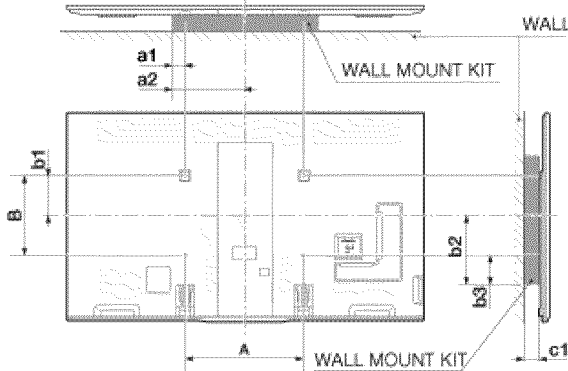

- a1: Maximum distance from the mounting hole
- a2: Maximum distance from the TV's center
- b1: Distance between the TV's center and the mounting hole
- b2: Maximum distance from the TV's center
- b3: Maximum distance from the mounting hole
- c1: Minimum gap

	LC-90LE657U LC-80LE642U	LC-80UQ17U	LC-80LE650U	LC-70UQ17U LC-70TQ15U	LC-70SQ17U LC-70SQ15U LC-70SQ10U LC-70EQ10U	LC-70LE650U LC-70C6500U	LC-60UQ17U LC-60TQ15U	LC-60SQ17U LC-60SQ15U LC-60SQ10U LC-60EQ10U	LC-60LE650U LC-60C6500U
VESA screw hole specs (A-B)	23 5/8 (600) - 15 3/4 (400)			15 3/4 (400) - 15 3/4(400)					
Width	a1	1 37/64 (40)	2 61/64 (75)	1 37/64 (40)	2 61/64 (75)				
	a2	13 25/64 (340)	14 49/64 (375)	13 25/64 (340)	10 27/32 (275)				
Height	b1	7 7/8 (200)		10 41/64 (270)	7 7/8 (200)	7 31/64 (190)	7 7/8 (200)	9 1/16 (230)	
	b2	14 49/64 (375)	13 19/32 (345)	11 1/32 (280)	14 11/64 (360)	10 41/64 (270)	12 39/64 (320)	9 1/16 (230)	
	b3	6 57/64 (175)	5 23/32 (145)	5 59/64 (150)	6 5/16 (160)	2 3/8 (60)	4 47/64 (120)	2 3/8 (60)	
c1	3 5/32 (80)			2 49/64 (70)					

Appendix

Setting the TV on the Wall(Continue)

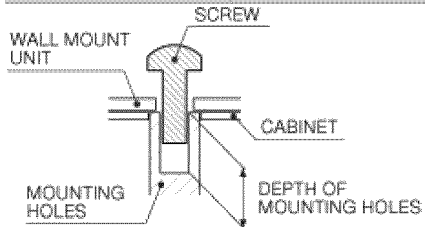

For the screws, refer to the table shown below.

	90/80 inch models	70/60 inch models
Standard screws	M8 (Use 1.25 pitch screws.)	M6 (Use 1.0 pitch screws.)
Length(Depth of mounting holes)	15/32 (12)	15/32 (12)
Quantity	4 pcs.	4 pcs.

NOTE

- Do not mount the TV at a tilt.
- To use this TV mounted on a wall, remove the cable tie as needed.
- Do not use screws that do not comply with the VESA standard screw specifications.
- Do not use screws that are longer than the standard length. Screws that are too long may cause damage to the inside of the TV.
- Do not fasten the screws too firmly or loosely. This may damage the product or cause the product to fail, leading to personal injury. SHARP is not liable for these kinds of accidents.
- SHARP is not liable for product damage or personal injury when a non-VESA or non-specified wall mount is used or the consumer fails to follow the product installation instructions.



Do not install the wall mount kit while your TV is turned on. It may result in personal injury due to electric shock.

Appendix

Troubleshooting

Problem	Possible Solution
<ul style="list-style-type: none"> No power 	<ul style="list-style-type: none"> Check if you pressed POWER on the remote control unit. Is the AC cord disconnected? Has the power been turned on?
<ul style="list-style-type: none"> Unit cannot be operated. 	<ul style="list-style-type: none"> External influences such as lightning, static electricity, may cause improper operation. In this case, operate the unit after first turning off the power of the TV or unplugging the AC cord and replugging it in after 1 or 2 minutes.
<ul style="list-style-type: none"> Remote control unit does not operate. 	<ul style="list-style-type: none"> Is the equipment to be operated by the remote control unit set correctly? Press TV to set the remote control unit to the setting for operating the TV. Are batteries inserted with polarity (+, -) aligned? Are batteries worn out? (Replace with new batteries.) Are you using it under strong or fluorescent lighting? Is a fluorescent light illuminated near the remote control sensor? Is "RC Control Lock" selected in "Operation Lock Out"? <p>Page 4-31</p>
<ul style="list-style-type: none"> Picture is cut off/with sidebar screen. 	<ul style="list-style-type: none"> Is the image position correct? <p>Pages 4-29 and 8-1</p> <ul style="list-style-type: none"> Are screen mode adjustments such as picture size made correctly? <p>Pages 3-14 to 3-16</p>
<ul style="list-style-type: none"> Strange color, light color, or color misalignment 	<ul style="list-style-type: none"> Adjust the picture tone. <p>Pages 4-5 to 4-10</p> <ul style="list-style-type: none"> Is the room too bright? The picture may look dark in a room that is too bright.
<ul style="list-style-type: none"> Power is suddenly turned off. 	<ul style="list-style-type: none"> Is the sleep timer set? <p>Pages 3-9</p> <ul style="list-style-type: none"> Check the power control settings. <p>Page 4-27</p> <ul style="list-style-type: none"> The unit's internal temperature has increased. Remove any objects blocking vent or clean.

Problem	Possible Solution
<ul style="list-style-type: none"> No picture 	<ul style="list-style-type: none"> Is connection to other components correct? Is the correct input selected? <p>Pages 2-1</p> <ul style="list-style-type: none"> Is "On" selected in "Audio Only"? <p>Page 4-27</p> <ul style="list-style-type: none"> If the PC image is not displayed, check the following: <ul style="list-style-type: none"> When connecting a laptop PC to the TV, check that display output mode of the PC is set to external monitor. Check the resolution setting on the PC. Is a non-compatible signal being input? <p>Page 8-9</p> <ul style="list-style-type: none"> The 4K signal (HDCP2.2) can be viewed via HDMI IN 1 only. Change the connection. (UQ/TQ/SQ series only)
<ul style="list-style-type: none"> Picture quality of HD programs is poor. 	<ul style="list-style-type: none"> To enjoy HD images from external equipment, you are required to set up HDMI connection or component connection. If the program content is not of HD quality, HD images cannot be displayed. Check that the program you are viewing provides HD images. The HD cable/satellite set-top box may need to be configured to output HD images via cable/satellite. The cable/satellite broadcast may not support a signal resolution of 1080p.
<ul style="list-style-type: none"> The TV sometimes makes a cracking sound. 	<ul style="list-style-type: none"> This is not a malfunction. This happens when the cabinet slightly expands and contracts according to change in temperature. This does not affect the TV's performance.
<ul style="list-style-type: none"> Some Internet functions used on a PC are not available from the TV. 	<ul style="list-style-type: none"> The TV has only limited functions compared with regular PC browsers. <p>Pages 9-7 to 9-9</p>

Appendix

Troubleshooting(Continue)

Problem	Possible Solution
<ul style="list-style-type: none"> No sound 	<ul style="list-style-type: none"> Is connection to other components correct? Is the volume too low? Page 3-2 Is "Variable" selected in "Output Select"? Page 4-20 Have you pressed MUTE on the remote control unit? Page 3-3 Check the audio output of the connected external equipment. Is the volume too low or muted? When external equipment is connected via an HDMI cable, you may need to configure the audio to be output through the HDMI cable. When audio is not output from external equipment connected to the PC IN or HDMI IN 2 terminal, check the "Audio Select" setting. Page 8-2 Even when external equipment is connected using an HDMI-certified cable, an audio cable connection may be required depending on the type of equipment and the media being played back. In this case, in addition to connecting an HDMI-certified cable to the HDMI IN 2 terminal, connect a Ø 3.5 mm stereo minijack cable to the AUDIO IN terminal and set "Audio Select" to "HDMI+Analog". Page 8-2 When connecting a PC via an HDMI-certified cable, check the following: <ul style="list-style-type: none"> Is the audio output of the PC configured correctly? Check the audio output settings and output audio format in Sound Properties on the PC. The audio formats compatible with this TV are PCM, Dolby Digital and DTS. With other formats, audio cannot be output. Depending on the board, only video signals may be output. In this case, in addition to connecting an HDMI-certified cable to the HDMI IN 2 terminal, connect a Ø 3.5 mm stereo minijack cable to the AUDIO IN terminal and set "Audio Select" to "HDMI+Analog". Page 8-2

Problem	Possible Solution
<ul style="list-style-type: none"> No sound 	<ul style="list-style-type: none"> If you are using a DVI-HDMI conversion cable to connect external equipment to the TV, check the following: <ul style="list-style-type: none"> Is an audio cable connected? The DVI-HDMI conversion cable is for video only. Connect a Ø 3.5 mm stereo minijack cable to listen to the audio. Is HDMI IN 2 being used? When the TV is connected to another HDMI IN terminal, the audio and video are not output together even if a Ø 3.5 mm stereo minijack cable is connected to the shared AUDIO IN terminal for PC IN and HDMI IN 2. Check the "Audio Select" setting. Set "Audio Select" to "HDMI+Analog". Page 8-2
<ul style="list-style-type: none"> Bluetooth (smartphone) playback cannot be displayed on the TV. 	<ul style="list-style-type: none"> Check pairing.
<ul style="list-style-type: none"> Miracast image/audio cannot be output to the TV. 	<ul style="list-style-type: none"> Check pairing.

Troubleshooting - 3D Images

Problem	Possible Solution
<ul style="list-style-type: none">• 3D images are not displayed.	<ul style="list-style-type: none">• Is "3D Auto Change" set to "Off"? Press 2D/3D to switch to 3D mode. <u>Page 5-11</u>• If "3D Auto Change" is set to "Mode 1" or "Mode 2" but no 3D images are displayed, check the display format of the content being viewed. Some 3D image signals may not be recognized as 3D images automatically. Press 2D/3D to select the appropriate display format for the 3D image. <u>Pages 5-8 to 5-9</u>• Is the power of the 3D Glasses turned on?• Are the 3D Glasses set to 2D mode?

For further details, refer to the operation manual of your 3D Glasses.

Appendix

Troubleshooting - Error Message

The example of an error message displayed on a screen	Error code	Possible Solution
• Failed to receive broadcast.	E202	• Check the antenna cable. Check that the antenna is correctly setup.
• No broadcast now.	E203	• Check the broadcast time in the program guide.
• An incompatible audio signal has been received. Check the output device settings.	—	• This message is displayed when an audio format other than PCM, DTS or Dolby Digital is input. - Set the audio output format of connected external HDMI equipment to PCM, DTS or Dolby Digital. - Refer to the operation manual of the external equipment for setting details.

Appendix

Information on the Software License for This Product

Software License

You can read the software licenses in the on-screen display menu. Refer to "Information" > "Software License".

Software composition

The software included in this product is comprised of various software components whose individual copyrights are held by SHARP or by third parties.

Cautions regarding use in high and low temperature environments

- When the unit is used in a low temperature space (e.g. room, office), the picture may leave trails or appear slightly delayed. This is not a malfunction, and the unit will recover when the temperature returns to normal.
- Do not leave the unit in a hot or cold location. Also, do not leave the unit in a location exposed to direct sunlight or near a heater, as this may cause the cabinet to deform and the front panel to malfunction.
Storage temperature: -4°F to +140°F (-20°C to +60°C)

CLEARING THE SECRET NUMBER

If you forget the secret number, clear the secret number using the following procedure.

- 1 Select an item from the list below to display the secret number input screen. (For operating the on-screen display menu, [see page 4-3.](#))
 - "Color System" (←"Advanced" ←Setup menu).
 - "Easy Setup" or "Reset" (←Setup menu).
 - "CH Setup" (←"TV Channel Setup" ←Setup menu).
 - "Parental Control" (←Setup menu).
 - "Interactive Service" (←"Internet Setup" ←Smart TV menu).
 - "Software Update" (←Information menu).
- 2 Press and hold both **CHA** and **VOL+** on the TV simultaneously until the message appears on the screen.

Specifications

TV (For the UQ17U models)

Item		Model: LC-80UQ17U	Model: LC-70UQ17U	Model: LC-60UQ17U	
LCD panel	Size	80" Class (80" Diagonal)	70" Class (69 1/2" Diagonal)	60" Class (60 1/32" Diagonal)	
	Resolution	2,073,600 pixels (1,920 x 1,080)			
TV Function	TV-standard (CCIR)	American TV Standard ATSC/NTSC System			
	Receiving Channel	VHF/UHF	VHF 2-13ch, UHF 14-69ch		
		CATV	1-135ch (non-scrambled channel only)		
		Digital Terrestrial Broadcast (8VSB)	2-69ch		
	Audio multiplex	Digital cable*1 (64/256 QAM)	1-135ch (non-scrambled channel only)		
Audio out		BTSC System			
Terminals	Back panel vertical side	HDMI IN 1	HDMI in with HDCP (HDCP2.2 supported)		
		HDMI IN 2	HDMI in with HDCP, Audio in (Ø 3.5 mm stereo jack)		
		HDMI IN 3	HDMI in with HDCP, ARC		
		HDMI IN 4	HDMI in with HDCP, MHL		
		AUDIO OUT	Audio out (Ø 3.5 mm stereo jack)		
	Back panel surface side	USB 1	Photo/Music/Video mode, Software update, USB keyboard/mouse, Wallpaper Picture		
		COMPONENT IN	COMPONENT in		
		VIDEO IN 1	AV in		
		VIDEO IN 2	AV in		
		PC IN	ANALOG RGB (PC) in (15-pin mini D-sub female connector), Audio in (Ø 3.5 mm stereo jack)		
	Back panel horizontal side	RS-232C	9-pin D-sub male connector		
		ANT/CABLE	75 Ω Unbalance, F Type x 1 for Analog (VHF/UHF/CATV) and Digital (AIR/CABLE)		
		AUDIO IN	Audio in (Ø 3.5 mm stereo jack)		
		DIGITAL AUDIO OUT	Optical Digital audio out x 1 (PCM/Dolby Digital/DTS)		
		ETHERNET	Network connector		
OSD language		English/French/Spanish			
Power Requirement		AC 120 V, 60 Hz			
On Mode Power		111 W	97 W	79 W	
Power Consumption		306 W (0.1 W Standby with AC 120 V)	227 W (0.1 W Standby with AC 120 V)	187 W (0.1 W Standby with AC 120 V)	
Weight	TV + stand	156.5 lbs./71.0 kg	106.9 lbs./48.5 kg	84.9 lbs./38.5 kg	
	TV only	135.6 lbs./61.5 kg	93.7 lbs./42.5 kg	71.7 lbs./32.5 kg	
Dimensions (W x H x D)(inch)	TV + stand	71 55/64 x 44 7/64 x 18 3/64	62 9/64 x 38 35/64 x 15 11/64	54 17/64 x 33 25/32 x 15 11/64	
	TV only	71 55/64 x 42 1/16 x 2 3/8	62 9/64 x 36 25/32 x 2 21/64	54 17/64 x 31 31/32 x 2 21/64	
Operating temperature		+32°F to +104°F (0°C to +40°C)			

*1 Emergency alert messages via Cable are unreceivable.

- As part of policy of continuous improvement, SHARP reserves the right to make design and specification changes for product improvement without prior notice. The performance specification figures indicated are nominal values of production units. There may be some deviations from these values in individual units.
- On Mode Power Consumption is measured according to Energy Star program requirements for televisions.

Specifications

TV (For the TQ15U models)

Item		Model: LC-70TQ15U	Model: LC-60TQ15U	
LCD panel	Size	70" Class (69 1/2" Diagonal)	60" Class (60 1/32" Diagonal)	
	Resolution	2,073,600 pixels (1,920 x 1,080)		
TV Function	TV-standard (CCIR)	American TV Standard ATSC/NTSC System		
	Receiving Channel	VHF/UHF	VHF 2-13ch, UHF 14-69ch	
		CATV	1-135ch (non-scrambled channel only)	
		Digital Terrestrial Broadcast (8VSB)	2-69ch	
		Digital cable*1 (64/256 QAM)	1-135ch (non-scrambled channel only)	
Audio multiplex	BTSC System			
Audio out	10W x 2 + 15W (WF)			
Terminals	Back panel vertical side	HDMI IN 1	HDMI in with HDCP (HDCP2.2 supported)	
		HDMI IN 2	HDMI in with HDCP, Audio in (Ø 3.5 mm stereo jack)	
		HDMI IN 3	HDMI in with HDCP, ARC	
		HDMI IN 4	HDMI in with HDCP, MHL	
		AUDIO OUT	Audio out (Ø 3.5 mm stereo jack)	
	Back panel surface side	USB 1	Photo/Music/Video mode, Software update, USB keyboard/mouse, Wallpaper Picture	
		COMPONENT IN	COMPONENT in	
		VIDEO IN 1	AV in	
		VIDEO IN 2	AV in	
		PC IN	ANALOG RGB (PC) in (15-pin mini D-sub female connector), Audio in (Ø 3.5 mm stereo jack)	
	Back panel horizontal side	RS-232C	9-pin D-sub male connector	
		ANT/CABLE	75 Ω Unbalance, F Type x 1 for Analog (VHF/UHF/CATV) and Digital (AIR/CABLE)	
		AUDIO IN	Audio in (Ø 3.5 mm stereo jack)	
		DIGITAL AUDIO OUT	Optical Digital audio out x 1 (PCM/Dolby Digital/DTS)	
		ETHERNET	Network connector	
OSD language	English/French/Spanish			
Power Requirement	AC 120 V, 60 Hz			
On Mode Power	97 W		79 W	
Power Consumption	227 W (0.1 W Standby with AC 120 V)		187 W (0.1 W Standby with AC 120 V)	
Weight	TV + stand	109.1 lbs./49.5 kg	87.1 lbs./39.5 kg	
	TV only	93.7 lbs./42.5 kg	71.7 lbs./32.5 kg	
Dimensions (W x H x D)(inch)	TV + stand	62 9/64 x 38 15/64 x 15 11/64	54 17/64 x 33 7/16 x 15 11/64	
	TV only	62 9/64 x 36 25/32 x 2 21/64	54 17/64 x 31 31/32 x 2 21/64	
Operating temperature	+32°F to +104°F (0°C to +40°C)			

*1 Emergency alert messages via Cable are unreceivable.

- As part of policy of continuous improvement, SHARP reserves the right to make design and specification changes for product improvement without prior notice. The performance specification figures indicated are nominal values of production units. There may be some deviations from these values in individual units.
- On Mode Power Consumption is measured according to Energy Star program requirements for televisions.

Specifications

TV (For the SQ17U, SQ15U and SQ10U models)

Item		Model: LC-70SQ17U/LC-70SQ15U/LC-70SQ10U	Model: LC-60SQ17U/LC-60SQ15U/LC-60SQ10U	
LCD panel	Size	70" Class (69 1/2" Diagonal)	60" Class (60 3/32" Diagonal)	
	Resolution	2,073,600 pixels (1,920 x 1,080)		
TV Function	TV-standard (CCIR)		American TV Standard ATSC/NTSC System	
	Receiving Channel	VHF/UHF	VHF 2-13ch, UHF 14-69ch	
		CATV	1-135ch (non-scrambled channel only)	
		Digital Terrestrial Broadcast (8VSB)	2-69ch	
		Digital cable*1 (64/256 QAM)	1-135ch (non-scrambled channel only)	
Audio multiplex		BTSC System		
Audio out		10W x 2		
Terminals	Back panel vertical side	HDMI IN 1	HDMI in with HDCP (HDCP2.2 supported)	
		HDMI IN 2	HDMI in with HDCP, Audio in (Ø 3.5 mm stereo jack)	
		HDMI IN 3	HDMI in with HDCP, ARC	
		HDMI IN 4	HDMI in with HDCP, MHL	
		AUDIO OUT	Audio out (Ø 3.5 mm stereo jack)	
	Back panel surface side	USB 1	Photo/Music/Video mode, Software update, USB keyboard/mouse, Wallpaper Picture	
		COMPONENT IN	COMPONENT in	
		VIDEO IN 1	AV in	
		VIDEO IN 2	AV in	
		PC IN	ANALOG RGB (PC) in (15-pin mini D-sub female connector), Audio in (Ø 3.5 mm stereo jack)	
	Back panel horizontal side	RS-232C	9-pin D-sub male connector	
		ANT/CABLE	75 Ω Unbalance, F Type x 1 for Analog (VHF/UHF/CATV) and Digital (AIR/CABLE)	
		AUDIO IN	Audio in (Ø 3.5 mm stereo jack)	
		DIGITAL AUDIO OUT	Optical Digital audio out x 1 (PCM/Dolby Digital/DTS)	
		ETHERNET	Network connector	
USB 2		Photo/Music/Video mode, Software update, USB keyboard/mouse, Wallpaper Picture		
OSD language		English/French/Spanish		
Power Requirement		AC 120 V, 60 Hz		
On Mode Power		97 W	79 W	
Power Consumption		228 W (0.1 W Standby with AC 120 V)	188 W (0.1 W Standby with AC 120 V)	
Weight	TV + stand	83.8 lbs./38.0 kg	61.7 lbs./28.0 kg	
	TV only	77.2 lbs./35.0 kg	55.1 lbs./25.0 kg	
Dimensions (W x H x D)(inch)	TV + stand	62 39/64 x 38 45/64 x 14 21/32	54 19/64 x 33 29/32 x 14 21/32	
	TV only	62 39/64 x 37 21/64 x 3 9/32	54 19/64 x 32 17/32 x 3 3/64	
Operating temperature		+32°F to +104°F (0°C to +40°C)		

*1 Emergency alert messages via Cable are unreceivable.

- As part of policy of continuous improvement, SHARP reserves the right to make design and specification changes for product improvement without prior notice. The performance specification figures indicated are nominal values of production units. There may be some deviations from these values in individual units.
- On Mode Power Consumption is measured according to Energy Star program requirements for televisions.

Specifications

TV (For the EQ10U models)

Item		Model: LC-70EQ10U	Model: LC-60EQ10U
LCD panel	Size	70" Class (69 1/2" Diagonal)	60" Class (60 3/32" Diagonal)
	Resolution	2,073,600 pixels (1,920 x 1,080)	
TV Function	TV-standard (CCIR)	American TV Standard ATSC/NTSC System	
	Receiving Channel	VHF/UHF	VHF 2-13ch, UHF 14-69ch
		CATV	1-135ch (non-scrambled channel only)
		Digital Terrestrial Broadcast (8VSB)	2-69ch
Audio multiplex	Digital cable*1 (64/256 QAM)	1-135ch (non-scrambled channel only)	
Audio out		BTSC System	
Terminals	Back panel vertical side	HDMI IN 1	HDMI in with HDCP, ARC
		HDMI IN 2	HDMI in with HDCP, Audio in (Ø 3.5 mm stereo jack)
		HDMI IN 3	HDMI in with HDCP
		HDMI IN 4	HDMI in with HDCP, MHL
		AUDIO OUT	Audio out (Ø 3.5 mm stereo jack)
		USB 1	Photo/Music/Video mode, Software update, USB keyboard/mouse, Wallpaper Picture
	Back panel surface side	COMPONENT IN	COMPONENT in
		VIDEO IN 1	AV in
		VIDEO IN 2	AV in
		PC IN	ANALOG RGB (PC) in (15-pin mini D-sub female connector), Audio in (Ø 3.5 mm stereo jack)
	RS-232C	9-pin D-sub male connector	
	Back panel horizontal side	ANT/CABLE	75 Ω Unbalance, F Type x 1 for Analog (VHF/UHF/CATV) and Digital (AIR/CABLE)
		AUDIO IN	Audio in (Ø 3.5 mm stereo jack)
		DIGITAL AUDIO OUT	Optical Digital audio out x 1 (PCM/Dolby Digital/DTS)
		ETHERNET	Network connector
USB 2		Photo/Music/Video mode, Software update, USB keyboard/mouse, Wallpaper Picture	
OSD language		English/French/Spanish	
Power Requirement		AC 120 V, 60 Hz	
On Mode Power		97 W	79 W
Power Consumption		228 W (0.1 W Standby with AC 120 V)	188 W (0.1 W Standby with AC 120 V)
Weight	TV + stand	83.8 lbs./38.0 kg	61.7 lbs./28.0 kg
	TV only	77.2 lbs./35.0 kg	55.1 lbs./25.0 kg
Dimensions (W x H x D)(inch)	TV + stand	62 39/64 x 38 45/64 x 14 21/32	54 19/64 x 33 29/32 x 14 21/32
	TV only	62 39/64 x 37 21/64 x 3 9/32	54 19/64 x 32 17/32 x 3 3/64
Operating temperature		+32°F to +104°F (0°C to +40°C)	

*1 Emergency alert messages via Cable are unreceivable.

- As part of policy of continuous improvement, SHARP reserves the right to make design and specification changes for product improvement without prior notice. The performance specification figures indicated are nominal values of production units. There may be some deviations from these values in individual units.
- On Mode Power Consumption is measured according to Energy Star program requirements for televisions.

Specifications

TV (For the LE650U and C6500U models)

Item		Model: LC-80LE650U	Model: LC-70LE650U/ LC-70C6500U	Model: LC-60LE650U/ LC-60C6500U
LCD panel	Size	80" Class (80" Diagonal)	70" Class (69 1/2" Diagonal)	60" Class (60 1/32" Diagonal)
	Resolution	2,073,600 pixels (1,920 x 1,080)		
TV Function	TV-standard (CCIR)	American TV Standard ATSC/NTSC System		
	Receiving Channel	VHF/UHF	VHF 2-13ch, UHF 14-69ch	
		CATV	1-135ch (non-scrambled channel only)	
		Digital Terrestrial Broadcast (8VSB)	2-69ch	
	Audio multiplex	Digital cable*1 (64/256 QAM)		
Audio out	BTSC System			
Terminals	Back panel vertical side	HDMI IN 1	HDMI in with HDCP, ARC	
		HDMI IN 2	HDMI in with HDCP, Audio in (Ø 3.5 mm stereo jack)	
		HDMI IN 3	HDMI in with HDCP	
		HDMI IN 4	HDMI in with HDCP, MHL	
		AUDIO OUT	Audio out (Ø 3.5 mm stereo jack)	
		USB 1	Photo/Music/Video mode, Software update, USB keyboard/mouse, Wallpaper Picture	
	Back panel surface side	COMPONENT IN	COMPONENT in	
		VIDEO IN 1	AV in	
		VIDEO IN 2	AV in	
		PC IN	ANALOG RGB (PC) in (15-pin mini D-sub female connector), Audio in (Ø 3.5 mm stereo jack)	
	Back panel horizontal side	RS-232C	9-pin D-sub male connector	
		ANT/CABLE	75 Ω Unbalance, F Type x 1 for Analog (VHF/UHF/CATV) and Digital (AIR/CABLE)	
		AUDIO IN	Audio in (Ø 3.5 mm stereo jack)	
		DIGITAL AUDIO OUT	Optical Digital audio out x 1 (PCM/Dolby Digital/DTS)	
		ETHERNET	Network connector	
USB 2	Photo/Music/Video mode, Software update, USB keyboard/mouse, Wallpaper Picture			
OSD language	English/French/Spanish			
Power Requirement	AC 120 V, 60 Hz			
On Mode Power	111 W	98 W	85 W	
Power Consumption	306 W (0.1 W Standby with AC 120 V)	228 W (0.1 W Standby with AC 120 V)	188 W (0.1 W Standby with AC 120 V)	
Weight	TV + stand	124.6 lbs./56.5 kg	82.7 lbs./37.5 kg	61.7 lbs./28.0 kg
	TV only	115.7 lbs./52.5 kg	76.1 lbs./34.5 kg	55.1 lbs./25.0 kg
Dimensions*2 (W x H x D)(inch)	TV + stand	71 15/16 x 43 43/64 x 17 17/32	62 39/64 x 38 19/64 x 14 11/64	54 19/64 x 33 1/2 x 14 11/64
	TV only	71 15/16 x 42 23/32 x 3 25/64	62 39/64 x 37 21/64 x 3 9/32	54 19/64 x 32 17/32 x 3 1/32
Operating temperature	+32°F to +104°F (0°C to +40°C)			

*1 Emergency alert messages via Cable are unreceivable.

- As part of policy of continuous improvement, SHARP reserves the right to make design and specification changes for product improvement without prior notice. The performance specification figures indicated are nominal values of production units. There may be some deviations from these values in individual units.
- On Mode Power Consumption is measured according to Energy Star program requirements for televisions.

Specifications

TV (For the LE657U model)

Item		Model: LC-90LE657U	
LCD panel	Size	90" Class (90 1/64" Diagonal)	
	Resolution	2,073,600 pixels (1,920 x 1,080)	
TV Function	TV-standard (CCIR)	American TV Standard ATSC/NTSC System	
	Receiving Channel	VHF/UHF	VHF 2-13ch, UHF 14-69ch
		CATV	1-135ch (non-scrambled channel only)
		Digital Terrestrial Broadcast (8VSB)	2-69ch
		Digital cable*1 (64/256 QAM)	1-135ch (non-scrambled channel only)
Audio multiplex	BTSC System		
Audio out		10W x 2 + 15W (WF)	
Terminals	Back panel vertical side	HDMI IN 1	HDMI in with HDCP
		HDMI IN 2	HDMI in with HDCP, Audio in (Ø 3.5 mm stereo jack)
		HDMI IN 3	HDMI in with HDCP, ARC
		HDMI IN 4	HDMI in with HDCP, MHL
		AUDIO OUT	Audio out (Ø 3.5 mm stereo jack)
		USB 1	Photo/Music/Video mode, Software update, USB keyboard/mouse, Wallpaper Picture
	Back panel surface side	COMPONENT IN	COMPONENT in
		VIDEO IN 1	AV in
		VIDEO IN 2	AV in
		PC IN	ANALOG RGB (PC) in (15-pin mini D-sub female connector), Audio in (Ø 3.5 mm stereo jack)
		RS-232C	9-pin D-sub male connector
	Back panel horizontal side	ANT/CABLE	75 Ω Unbalance, F Type x 1 for Analog (VHF/UHF/CATV) and Digital (AIR/CABLE)
		AUDIO IN	Audio in (Ø 3.5 mm stereo jack)
		DIGITAL AUDIO OUT	Optical Digital audio out x 1 (PCM/Dolby Digital/DTS)
		ETHERNET	Network connector
USB 2		Photo/Music/Video mode, Software update, USB keyboard/mouse, Wallpaper Picture	
OSD language		English/French/Spanish	
Power Requirement		AC 120 V, 60 Hz	
On Mode Power		138 W	
Power Consumption		381 W (0.1 W Standby with AC 120 V)	
Weight	TV + stand	150.0 lbs./68.0 kg	
	TV only	141.1 lbs./64.0 kg	
Dimensions*2 (W x H x D)(inch)	TV + stand	80 7/8 x 48 61/64 x 17 3/32	
	TV only	80 7/8 x 47 11/16 x 4 37/64	
Operating temperature		+32°F to +104°F (0°C to +40°C)	

*1 Emergency alert messages via Cable are unreceivable.

- As part of policy of continuous improvement, SHARP reserves the right to make design and specification changes for product improvement without prior notice. The performance specification figures indicated are nominal values of production units. There may be some deviations from these values in individual units.
- On Mode Power Consumption is measured according to Energy Star program requirements for televisions.

Specifications

TV (For the LE642U model)

Item		Model: LC-80LE642U	
LCD panel	Size	80" Class (80" Diagonal)	
	Resolution	2,073,600 pixels (1,920 x 1,080)	
TV Function	TV-standard (CCIR)	American TV Standard ATSC/NTSC System	
	Receiving Channel	VHF/UHF	VHF 2-13ch, UHF 14-69ch
		CATV	1-135ch (non-scrambled channel only)
		Digital Terrestrial Broadcast (8VSB)	2-69ch
		Digital cable*1 (64/256 QAM)	1-135ch (non-scrambled channel only)
Audio multiplex	BTSC System		
Audio out		10W x 2	
Terminals	Back panel vertical side	HDMI IN 1	HDMI in with HDCP, ARC
		HDMI IN 2	HDMI in with HDCP, Audio in (Ø 3.5 mm stereo jack)
		HDMI IN 3	HDMI in with HDCP
		HDMI IN 4	HDMI in with HDCP, MHL
		AUDIO OUT	Audio out (Ø 3.5 mm stereo jack)
	Back panel surface side	USB 1	Photo/Music/Video mode, Software update, USB keyboard/mouse, Wallpaper Picture
		COMPONENT IN	COMPONENT in
		VIDEO IN 1	AV in
		VIDEO IN 2	AV in
		PC IN	ANALOG RGB (PC) in (15-pin mini D-sub female connector), Audio in (Ø 3.5 mm stereo jack)
	Back panel horizontal side	RS-232C	9-pin D-sub male connector
		ANT/CABLE	75 Ω Unbalance, F Type x 1 for Analog (VHF/UHF/CATV) and Digital (AIR/CABLE)
		AUDIO IN	Audio in (Ø 3.5 mm stereo jack)
		DIGITAL AUDIO OUT	Optical Digital audio out x 1 (PCM/Dolby Digital/DTS)
		ETHERNET	Network connector
OSD language		English/French/Spanish	
Power Requirement		AC 120 V, 60 Hz	
On Mode Power		111 W	
Power Consumption		307 W (0.1 W Standby with AC 120 V)	
Weight	TV + stand	123.5 lbs./56.0 kg	
	TV only	114.6 lbs./52.0 kg	
Dimensions*2 (W x H x D)(inch)	TV + stand	73 5/16 x 45 3/32 x 17 3/32	
	TV only	73 5/16 x 43 25/32 x 3 29/32	
Operating temperature		+32°F to +104°F (0°C to +40°C)	

*1 Emergency alert messages via Cable are unreceivable.

- As part of policy of continuous improvement, SHARP reserves the right to make design and specification changes for product improvement without prior notice. The performance specification figures indicated are nominal values of production units. There may be some deviations from these values in individual units.
- On Mode Power Consumption is measured according to Energy Star program requirements for televisions.

Specifications

Wireless LAN

Specification	
Standard	IEEE 802.11a/b/g/n
Frequency Band	2412-2484 MHz 5150-5850 MHz
Security	Static WEP (64/128 bit key Index 1 only) WPA-PSK (TKIP) WPA2-PSK (AES)
Modulation	DBPSK@1Mbps DQPSK@2Mbps CCK@5.5/11Mbps BPSK@6/9 Mbps QPSK@12/18Mbps 16-QAM@24Mbps 64-QAM@48/54Mbps and above, Rx up to 300Mbps

Specifications

Bluetooth (For the UQ17U, TQ15U, SQ17U, SQ15U, SQ10U and LE657U models)

Specification	
Ver. name	Ver. 3.0+EDR
profile name	HID A2DP*

* For the UQ17U, TQ15U, SQ17U, SQ15U and SQ10U models.

IMPORTANT SAFETY INSTRUCTIONS

Bluetooth

Notes on Radio Wave Certification in the U.S.A. and Canada

This device complies with part 15 of the FCC Rules. Operation is subject to the following two conditions: (1) This device may not cause harmful interference, and (2) this device must accept any interference received, including interference that may cause undesired operation.

"This transmitter must not be co-located or operated in conjunction with any other antenna or transmitter."

FCC/INDUSTRY CANADA NOTICE

This device complies with Part 15 of FCC Rules and Industry Canada license-exempt RSS standard(s). Operation is subject to the following two conditions: (1) this device may not cause interference, and (2) this device must accept any interference, including interference that may cause undesired operation of this device.

This equipment complies with FCC/IC radiation exposure limits set forth for an uncontrolled environment and meets the FCC radio frequency (RF) Exposure Guidelines in Supplement C to OET65 and RSS-102 of the IC radio frequency (RF) Exposure rules. This equipment has very low levels of RF energy that are deemed to comply without testing of specific absorption ratio (SAR).

FCC CAUTION

Changes or modifications not expressly approved by Hosiden responsible for compliance could void the user's authority to operate the equipment.

Note: This equipment has been tested and found to comply with the limits for a Class B digital device, pursuant to Part 15 of the FCC Rules. These limits are designed to provide reasonable protection against harmful interference in a residential installation. This equipment generates, uses and can radiate radio frequency energy and, if not installed and used in accordance with the instructions, may cause harmful interference to radio communications. However, there is no guarantee that interference will not occur in a particular installation. If this equipment does cause harmful interference to radio or television reception, which can be determined by turning the equipment off and on, the user is encouraged to try to correct the interference by one or more of the following measures:

Reorient or relocate the receiving antenna. Increase the separation between the equipment and receiver. Connect the equipment into an outlet on a circuit different from that to which the receiver is connected. Consult the dealer or an experienced radio/TV technician for help.

This Class B digital apparatus complies with Canadian ICES-003

Le présent appareil est conforme aux la prtie 15 des règles de la FCC et CNR d'Industrie Canada applicables aux appareils radio exempts de licence. L'exploitation est autorisée aux deux conditions suivantes : (1) l'appareil ne doit pas produire de brouillage, et (2) l'utilisateur de l'appareil doit accepter tout brouillage radioélectrique subi, même si le brouillage est susceptible d'en compromettre le fonctionnement.

Cet équipement est conforme aux limites d'exposition aux rayonnements énoncées pour un environnement non contrôlé et respecte les règles les radioélectriques (RF) de la FCC lignes directrices d'exposition dans le Supplément C à OET65 et d'exposition aux fréquences radioélectriques (RF) CNR-102 de l'IC. Cet équipement émet une énergie RF très faible qui est considérée conforme sans évaluation du débit d'absorption spécifique (DAS).

Cet appareil numérique de la classe B est conforme à la norme NMB-3 du Canada.

3D Glasses

Notas sobre la Certificación de Radiodifusión en México

- IFETEL: RCPHOAR14-0001
- Nombre de la marca del módulo con licencia: SHARP CORPORATION
- Nombre de modelo del módulo con licencia: ARC0557
- Módulo ARC0557 instalado adentro de esta gafas

PRECAUCIÓN

La operación de este equipo está sujeta a las siguientes dos condiciones: (1) es posible que este equipo o dispositivo no cause interferencia perjudicial y (2) este equipo o dispositivo debe aceptar cualquier interferencia, incluyendo la que pueda causar su operación no deseada.

Número de licencia para la certificación de radiodifusión
Estados Unidos CONTAINS FCC ID: VIYARC0557
Canadá CONTAINS IC: 7305A-ARC0557

Trademarks

- SmartCentral is a registered trademark of Sharp Corporation.

- Manufactured under license from Dolby Laboratories. Dolby and the double-D symbol are trademarks of Dolby Laboratories.

- The terms HDMI and HDMI High-Definition Multimedia Interface, and the HDMI Logo are trademarks or registered trademarks of HDMI Licensing LLC in the United States and other countries.

- DivX®, DivX Certified®, DivX Plus® HD and associated logos are trademarks of Rovi Corporation or its subsidiaries and are used under license.

- The Wi-Fi CERTIFIED Logo is a certification mark of the Wi-Fi Alliance.
- The Wi-Fi Protected Setup Mark is a mark of the Wi-Fi Alliance.
- Wi-Fi CERTIFIED Miracast™ and Miracast™ are trademarks of Wi-Fi Alliance.

- DLNA®, the DLNA Logo and DLNA CERTIFIED™ are trademarks, service marks, or certification marks of the Digital Living Network Alliance.

- This product includes Home Networking Software 'DiXiM' developed by DigiOn, Inc.

- **LCフォント、LCFONT、エルシーフォント** and LC logo mark are registered trademarks of SHARP Corporation. This product is embedded with LC Font technology, which was developed by SHARP Corporation for clearly displaying easy-to-read characters on LCD screens. However, other fonts are used for some screen pages, too.

- "x.v.Color" and **x.v.Color** are trademarks of Sony Corporation.

- **ABOUT DIVX VIDEO:** DivX® is a digital video format created by DivX, LLC, a subsidiary of Rovi Corporation. This is an official DivX Certified® device that plays DivX video. Visit divx.com for more information and software tools to convert your files into DivX videos.
- **ABOUT DIVX VIDEO-ON-DEMAND:** This DivX Certified® device must be registered in order to play purchased DivX Video-on-Demand (VOD) movies. To obtain your registration code, locate the DivX VOD section in your device setup menu. Go to vod.divx.com for more information on how to complete your registration.

- Netflix and the Netflix logo are the registered trademarks of Netflix, Inc.

- VUDU™ is a trademark of VUDU, Inc.

- Manufactured under license under U.S. Patent Nos: 5,956,674; 5,974,380; 6,487,535 & other U.S. and worldwide patents issued & pending.
- DTS, the Symbol, & DTS and the Symbol together are registered trademarks & DTS 2.0+Digital Out is a trademark of DTS, Inc. Product includes software. © DTS, Inc. All Rights Reserved.

- MHL, the MHL Logo, and Mobile High-Definition Link are trademarks or registered trademarks of MHL LLC in the United States and other countries.
- MHL™

- The Bluetooth® word mark and logos are registered trademarks owned by Bluetooth SIG, Inc. and any use of such marks by SHARP Corporation is under license. Other trademarks and trade names are those of their respective owners.

- THX and the THX logo are trademarks of THX Ltd., registered in the United States and other jurisdictions. All rights reserved.

ENERGY STAR® User Information (Except for LC-90LE657U)

- For more information on the ENERGY STAR program, you can refer to energystar.gov.
- Leaving the ENERGY STAR home mode or enabling optional features will cause an increase power consumed.
- This product qualifies for ENERGY STAR when "Home" is selected for "TV Location". Setting "TV Location" to "Home" allows the TV to achieve an energy-saving status for household use.



Products that have earned the ENERGY STAR® are designed to protect the environment through superior energy efficiency.

Dimensional Drawings

LC-80UQ17U

Unit: inch (mm)
 Unité: pouce (mm)
 Unidad: pulgada (mm)

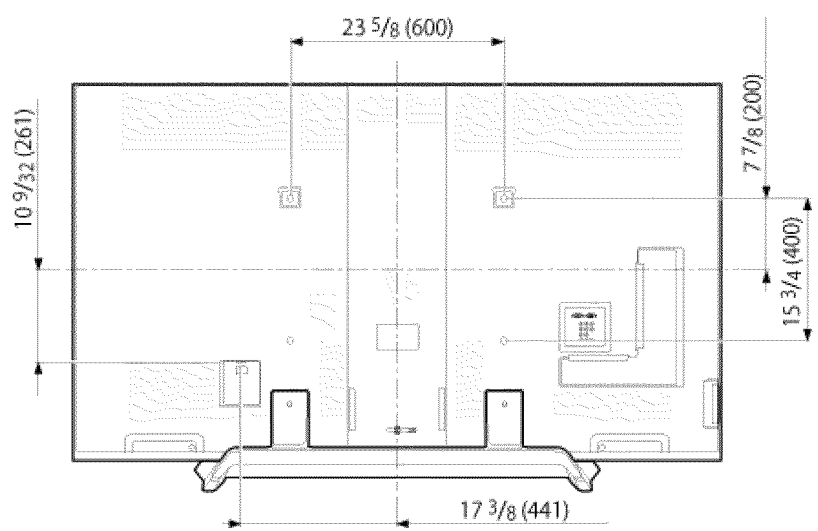
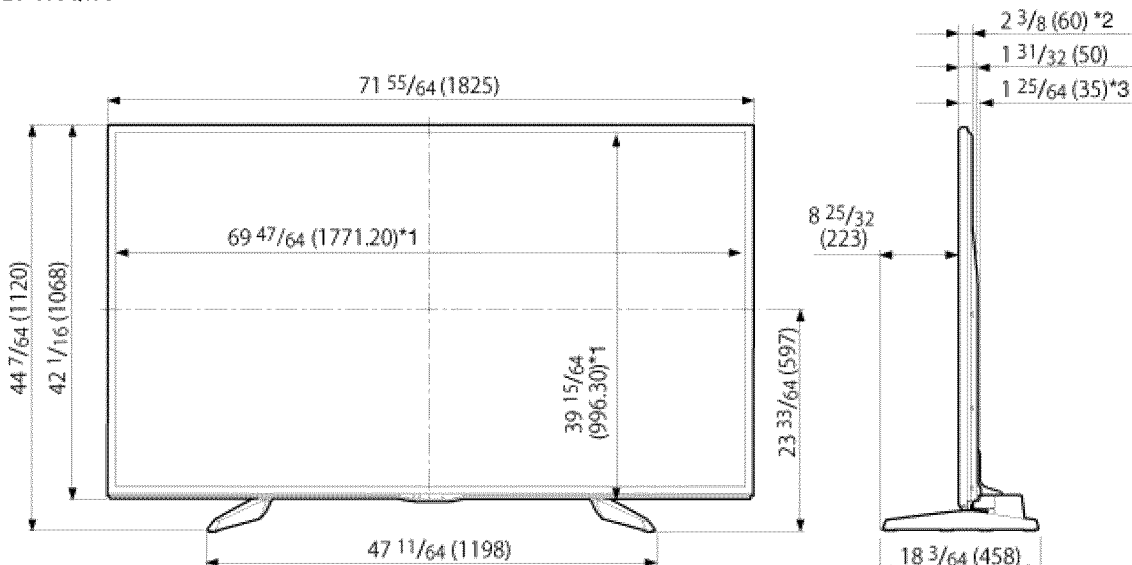

*1 Active area/Área activa/Zone active
 *2 Thinnest part/Parte más delgada/Partie la plus mince
 *3 Including projecting parts/Incluyendo partes salientes/Parties saillantes incluses

Dimensional Drawings

LC-70UQ17U

Unit: inch (mm)
 Unité: pouce (mm)
 Unidad: pulgada (mm)

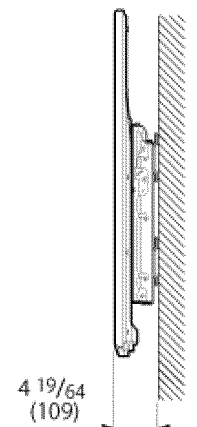
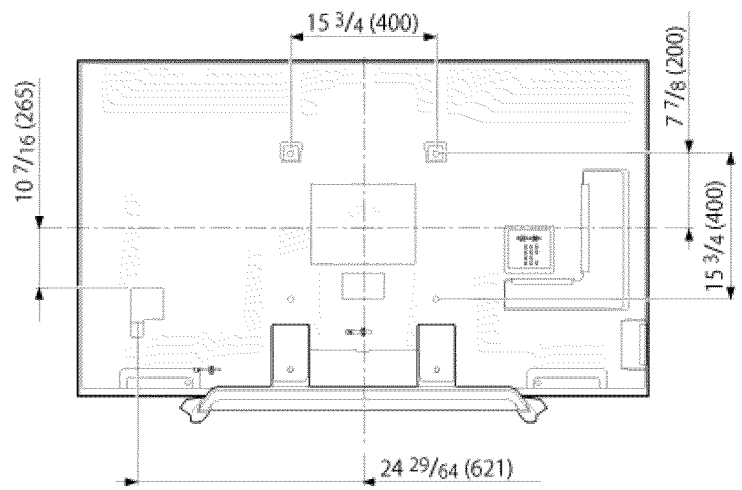
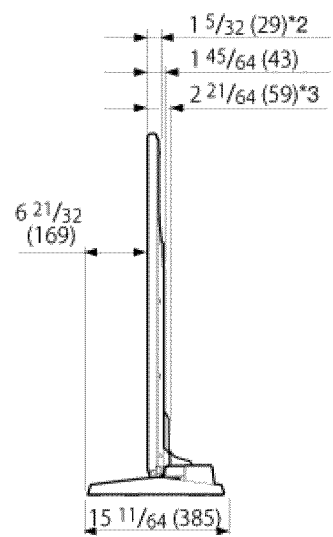
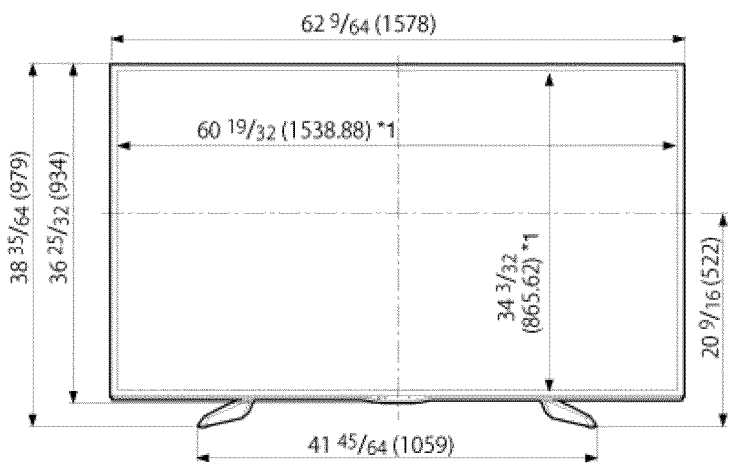

AN-52AG4

*1 Active area/Área activa/Zone active
 *2 Thinnest part/Parte más delgada/Partie la plus mince
 *3 Including projecting parts/Incluyendo partes salientes/Parties saillantes incluses

Dimensional Drawings

LC-60UQ17U

Unit: inch (mm)
 Unité: pouce (mm)
 Unidad: pulgada (mm)

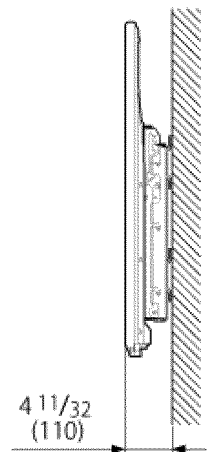
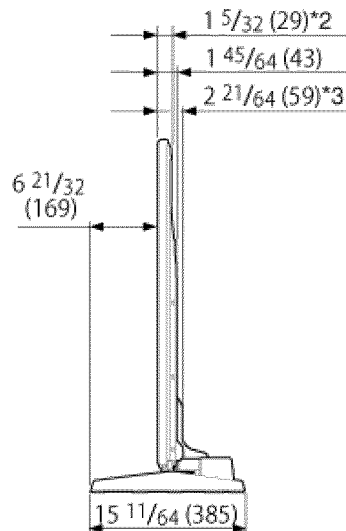
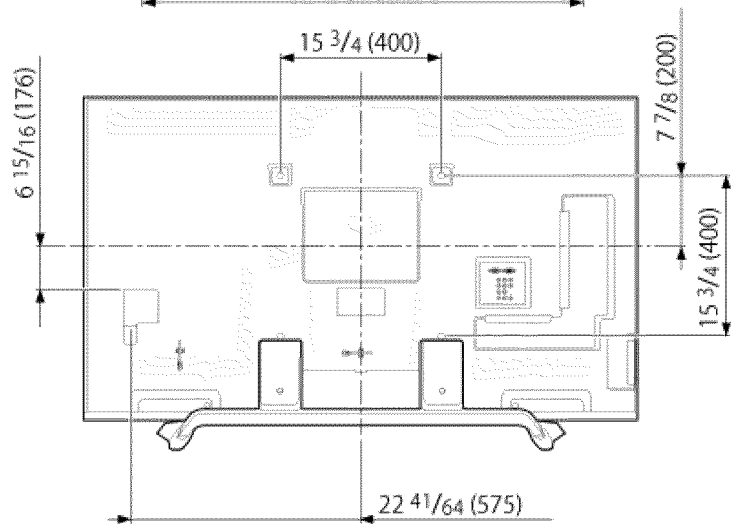
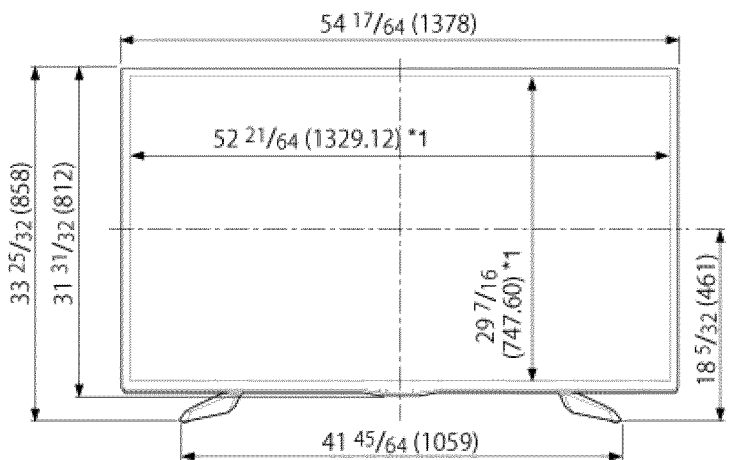

AN-52AG4

*1 Active area/Área activa/Zona active

*2 Thinnest part/Parte más delgada/Partie la plus mince

*3 Including projecting parts/Incluyendo partes salientes/Parties saillantes incluses

Dimensional Drawings

LC-70TQ15U

Unit: inch (mm)
 Unité: pouce (mm)
 Unidad: pulgada (mm)

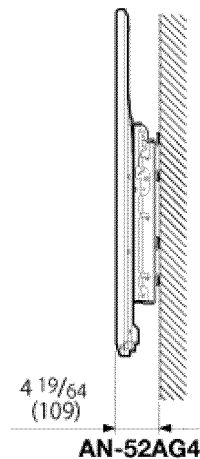
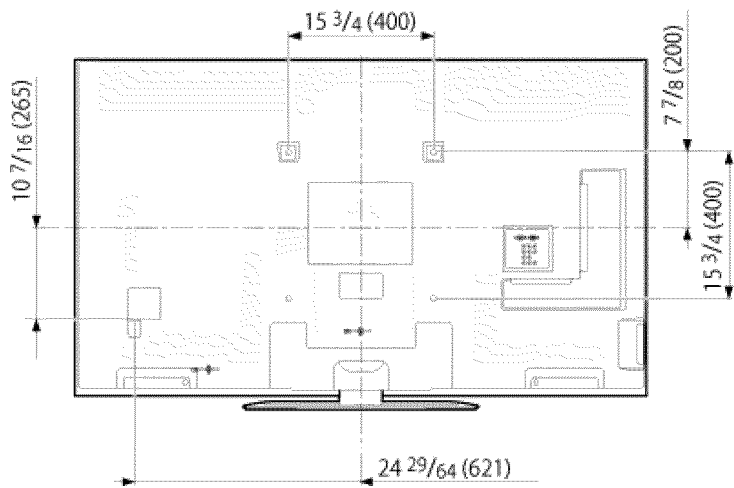
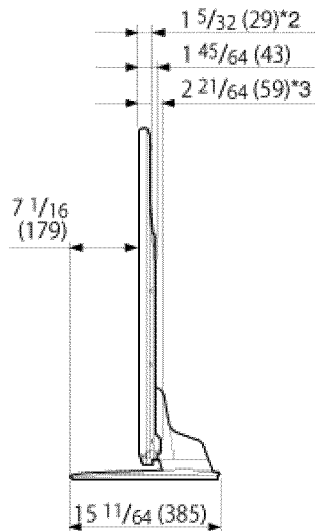
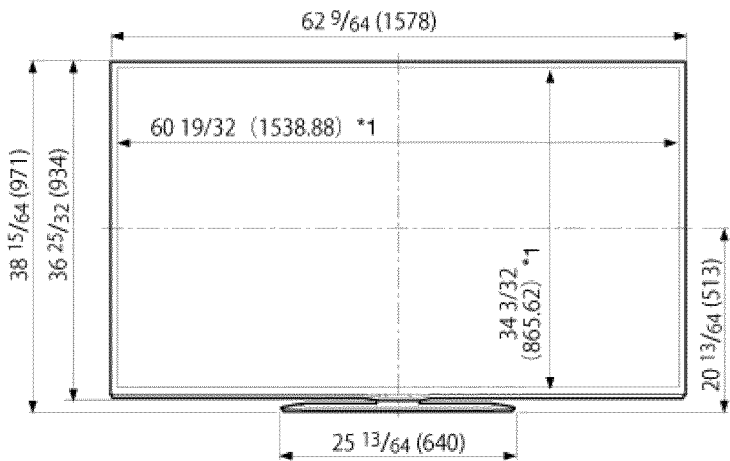

AN-52AG4

*1 Active area/Área activa/Zona active
 *2 Thinnest part/Parte más delgada/Partie la plus mince
 *3 Including projecting parts/Incluyendo partes salientes/Parties saillantes incluses

Dimensional Drawings

LC-60TQ15U

Unit: inch (mm)
 Unité: pouce (mm)
 Unidad: pulgada (mm)

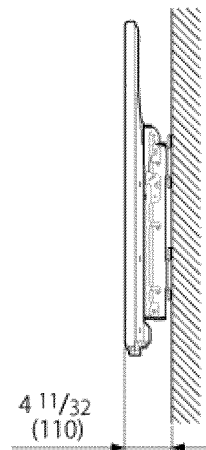
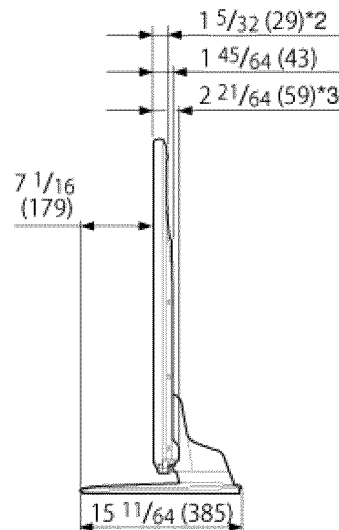
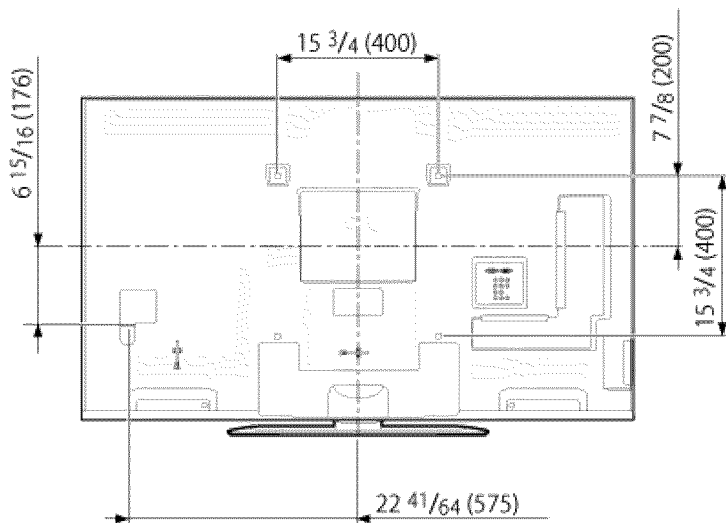
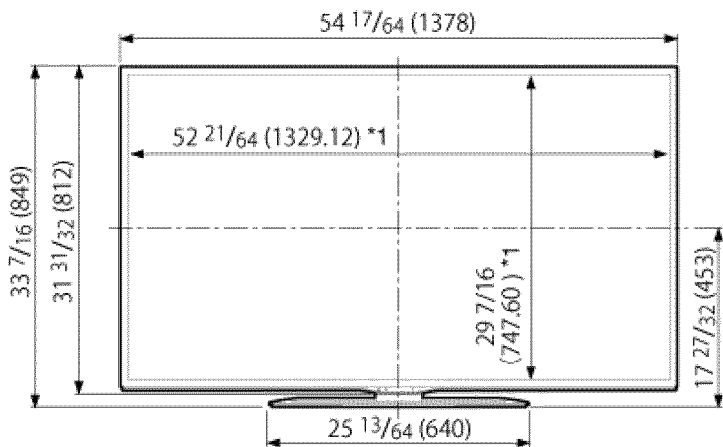

AN-52AG4

*1 Active area/Área activa/Zone active

*2 Thinnest part/Parte más delgada/Partie la plus mince

*3 Including projecting parts/Incluyendo partes salientes/Parties saillantes incluses

Dimensional Drawings

LC-70SQ17U/LC-70SQ15U/LC-70SQ10U/LC-70EQ10U

Unit: inch (mm)
Unité: pouce (mm)
Unidad: pulgada (mm)

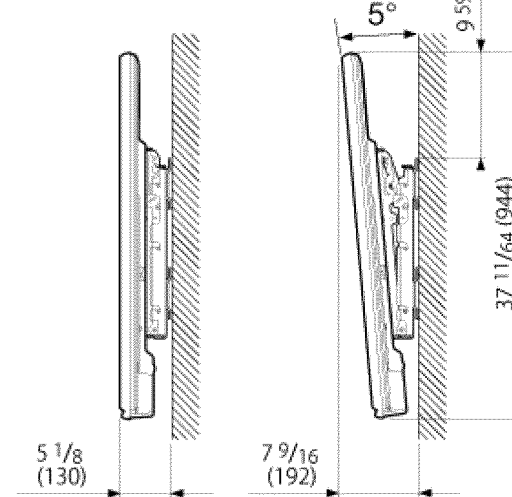
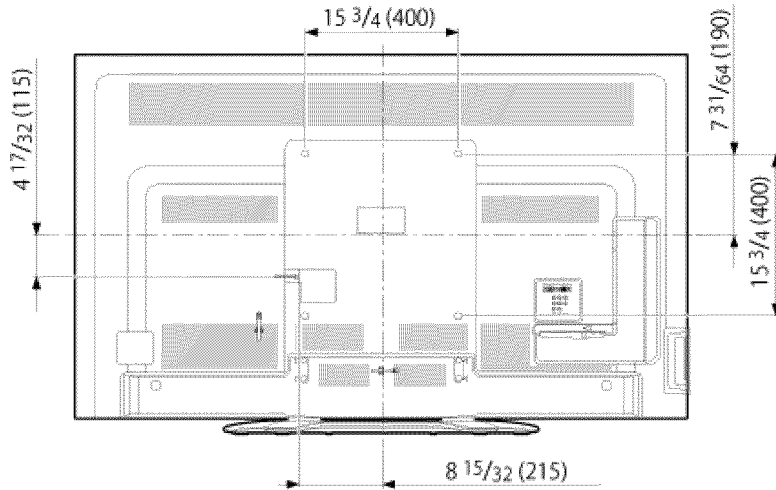
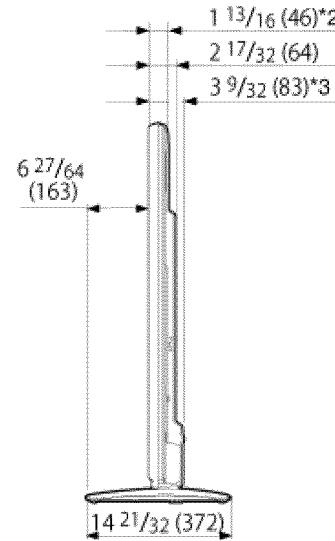
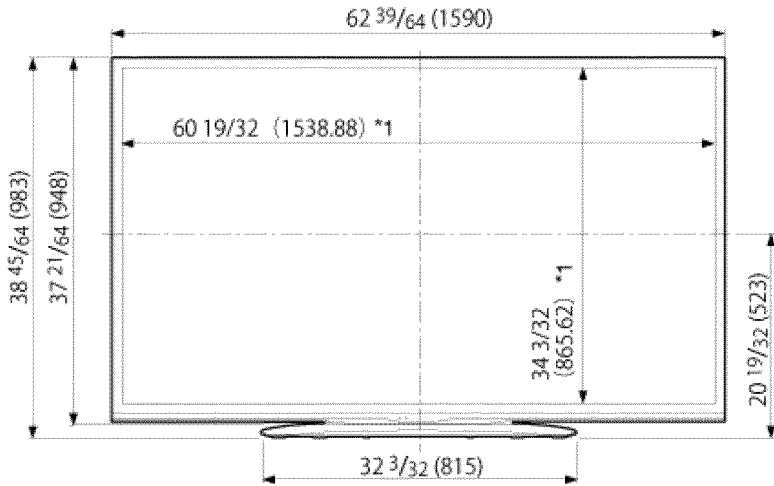

AN-52AG4

*1 Active area/Área activa/Zona activa

*2 Thinnest part/Parte más delgada/Partie la plus mince

*3 Including projecting parts/Incluyendo partes salientes/Parties saillantes incluses

Dimensional Drawings

LC-60SQ17U/LC-60SQ15U/LC-60SQ10U/LC-60EQ10U

Unit: inch (mm)
Unité: pouce (mm)
Unidad: pulgada (mm)

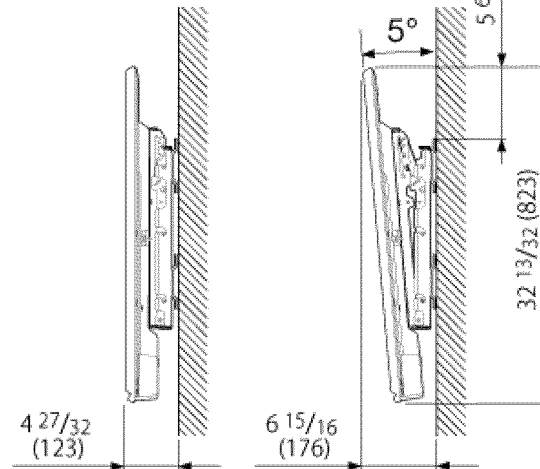
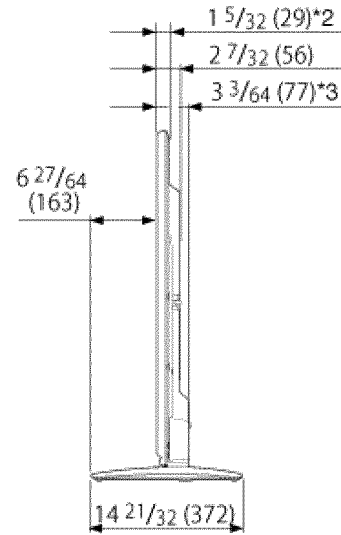
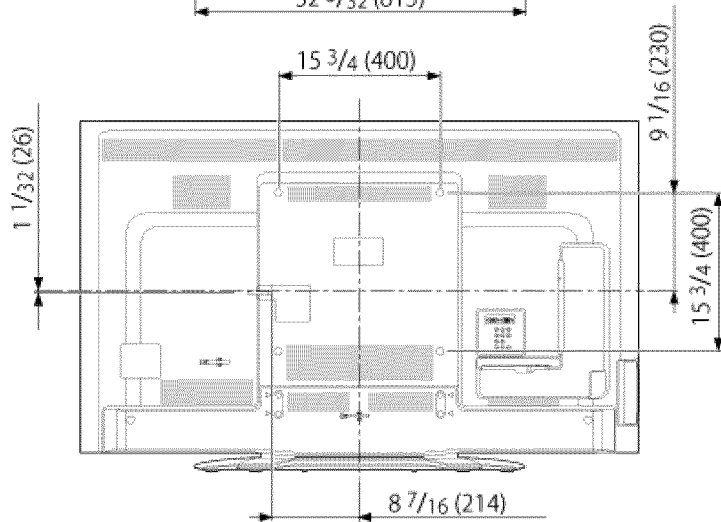
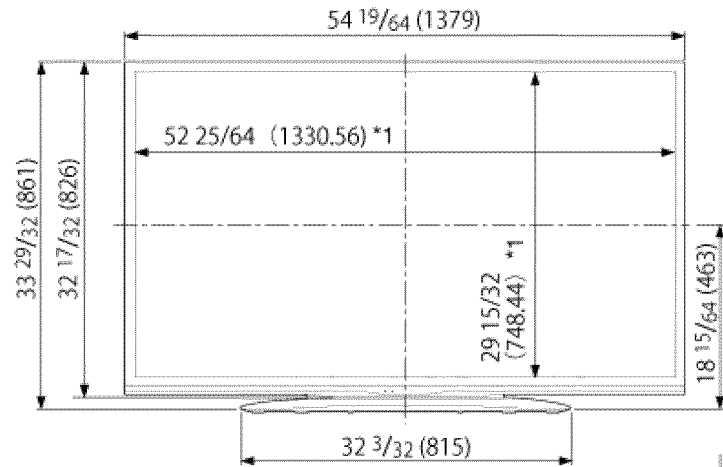

AN-52AG4

*1 Active area/Área activa/Zone active

*2 Thinnest part/Parte más delgada/Partie la plus mince

*3 Including projecting parts/Incluyendo partes salientes/Parties saillantes incluses

Dimensional Drawings

LC-80LE650U

Unit: inch (mm)
 Unité: pouce (mm)
 Unidad: pulgada (mm)

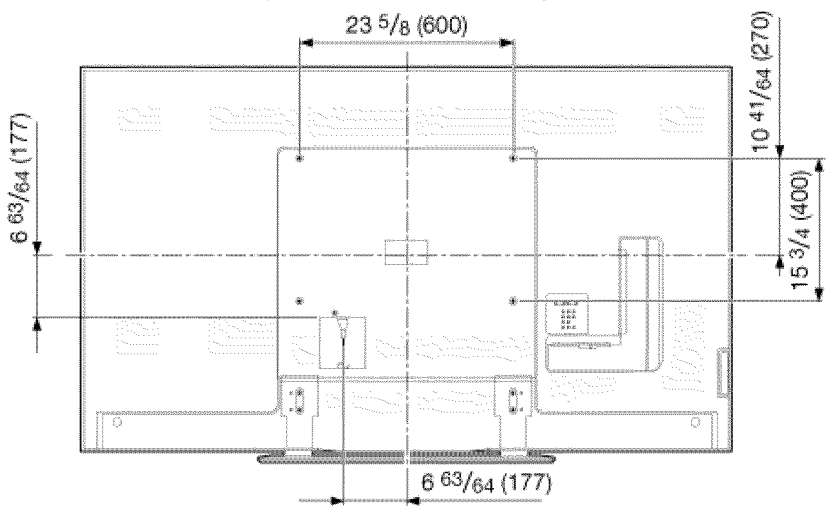
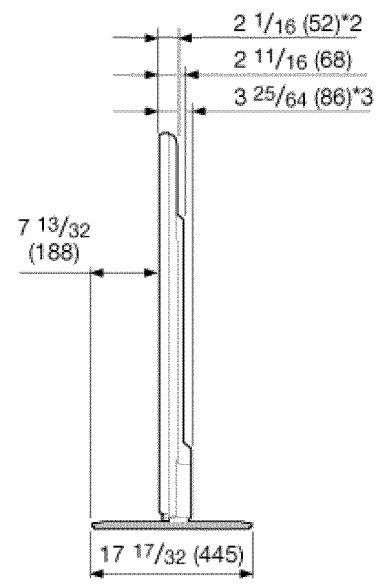
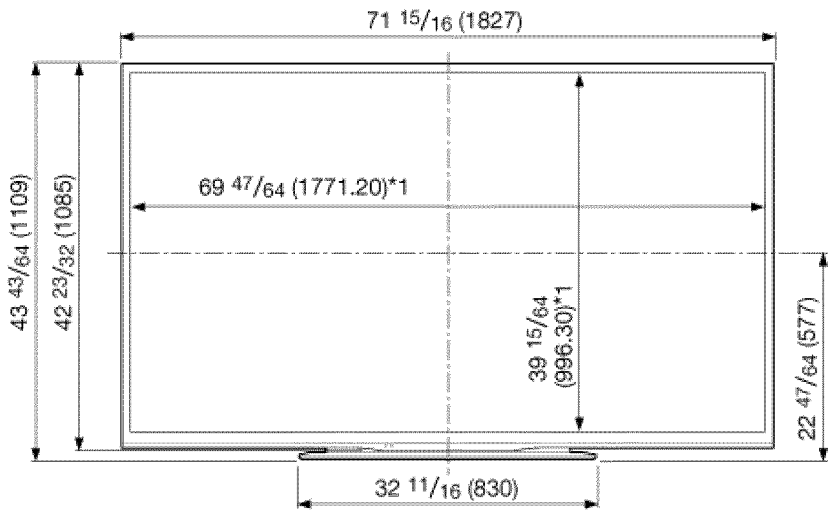

*1 Active area/Área activa/Zona activa
 *2 Thinnest part/Parte más delgada/Partie la plus mince
 *3 Including projecting parts/Incluyendo partes salientes/Parties saillantes incluses

Dimensional Drawings

LC-70LE650U/LC-70C6500U

Unit: inch (mm)
 Unité: pouce (mm)
 Unidad: pulgada (mm)

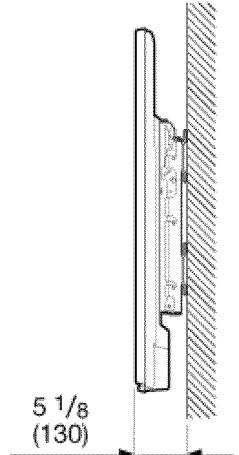
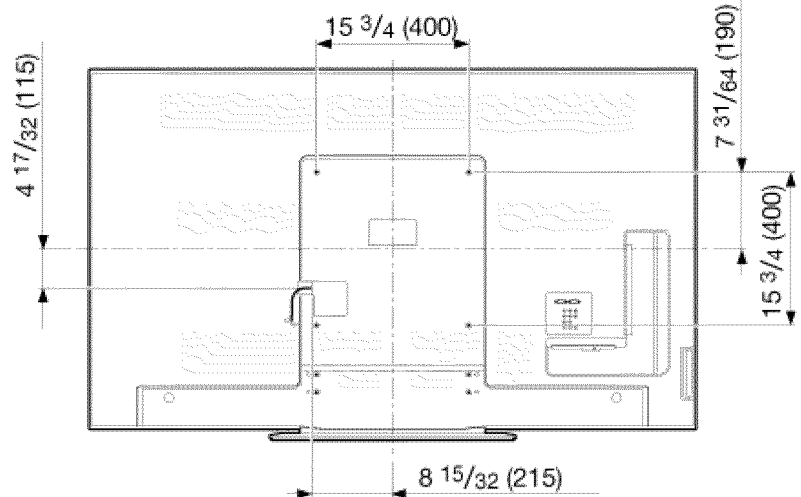
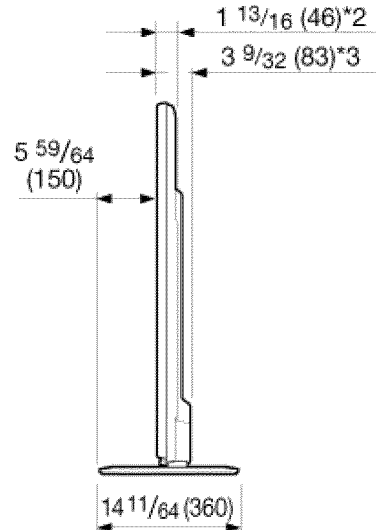
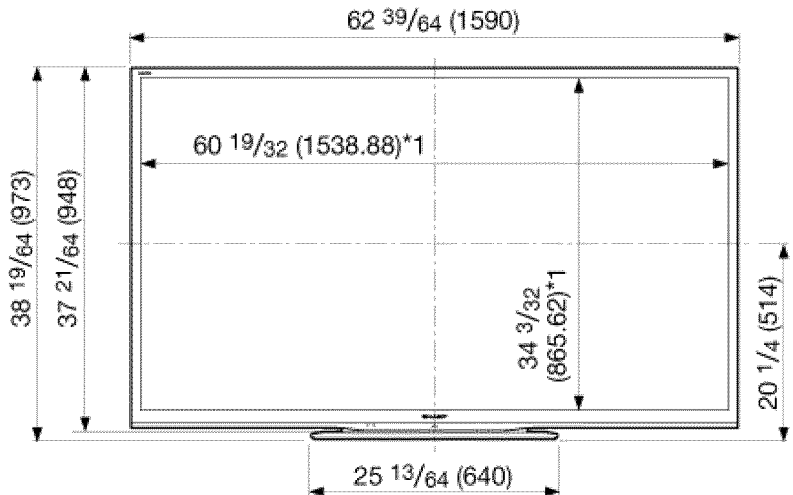

AN-52AG4

*1 Active area/Área activa/Zona active
 *2 Thinnest part/Parte más delgada/Partie la plus mince
 *3 Including projecting parts/Incluyendo partes salientes/Parties saillantes incluses

Dimensional Drawings

LC-60LE650U/LC-60C6500U

Unit: inch (mm)
 Unité: pouce (mm)
 Unidad: pulgada (mm)

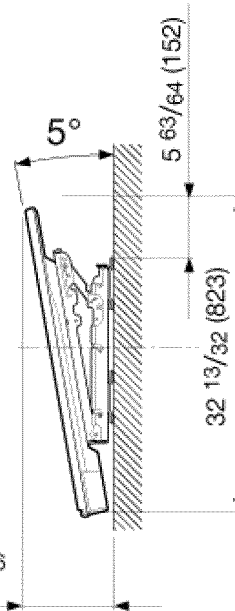
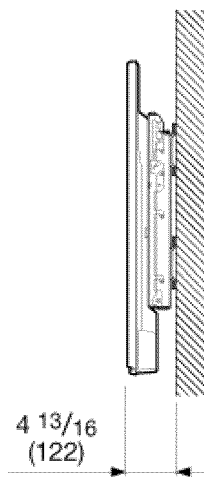
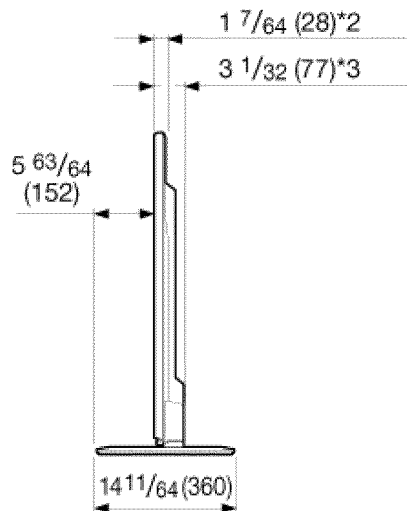
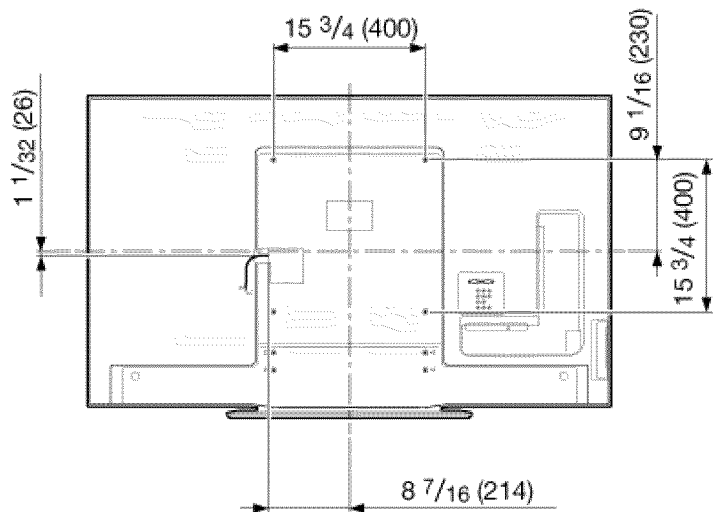
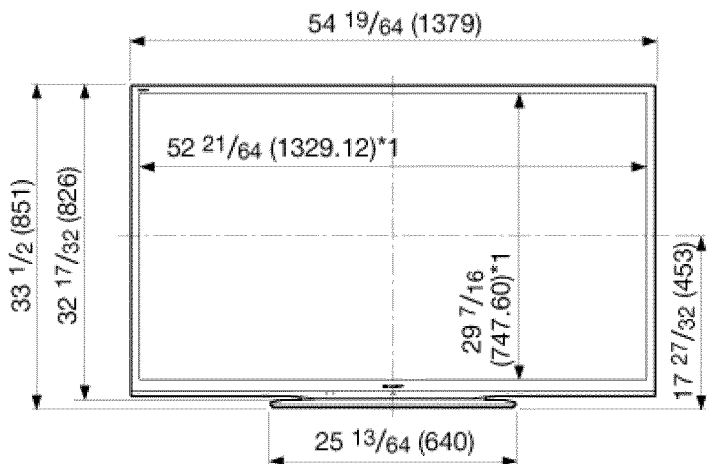

AN-52AG4

*1 Active area/Área activa/Zone active

*2 Thinnest part/Parte más delgada/Partie la plus mince

*3 Including projecting parts/Incluyendo partes salientes/Parties saillantes incluses

Dimensional Drawings

LC-90LE657U

Unit: inch (mm)
 Unité: pouce (mm)
 Unidad: pulgada (mm)

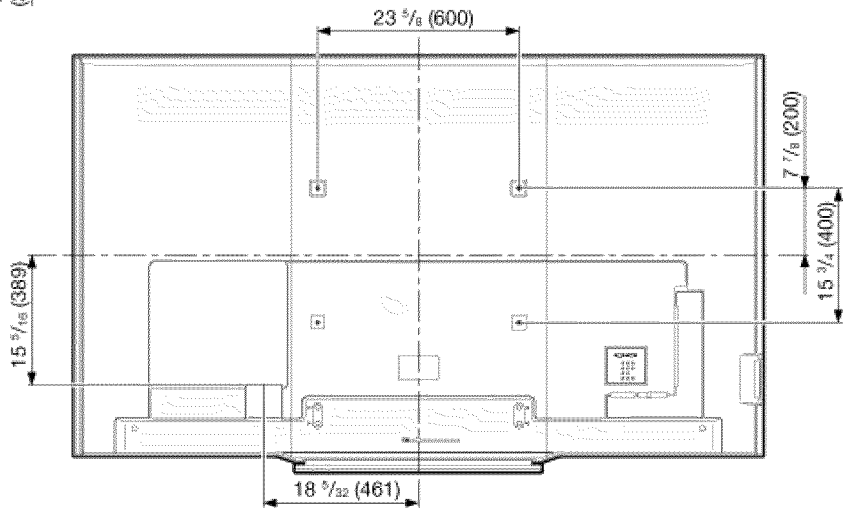
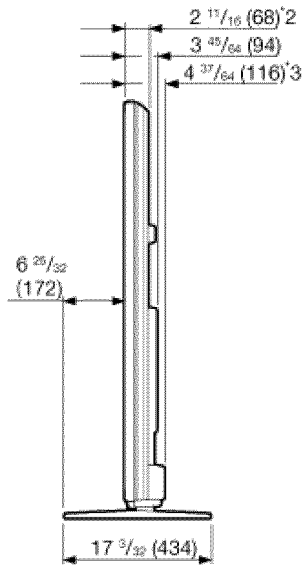
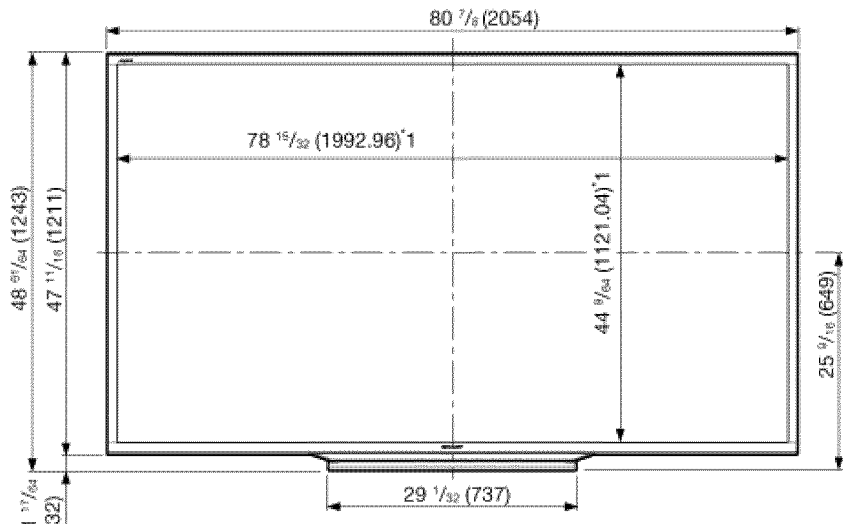

*1 Active area/Área activa/Zona active
 *2 Thinnest part/Parte más delgada/Partie la plus mince
 *3 Including projecting parts/Incluyendo partes salientes/Parties saillantes incluses

Dimensional Drawings

LC-80LE642U

Unit: inch (mm)
 Unité: pouce (mm)
 Unidad: pulgada (mm)

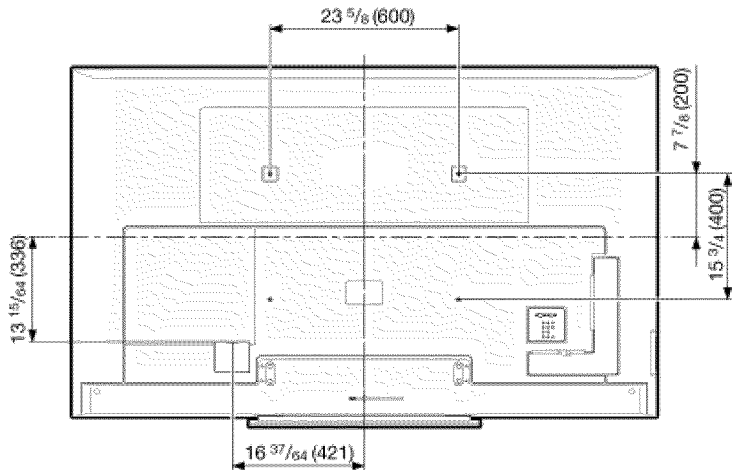
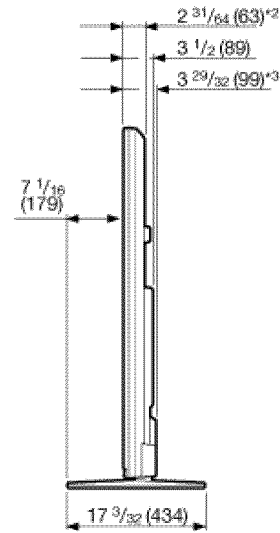
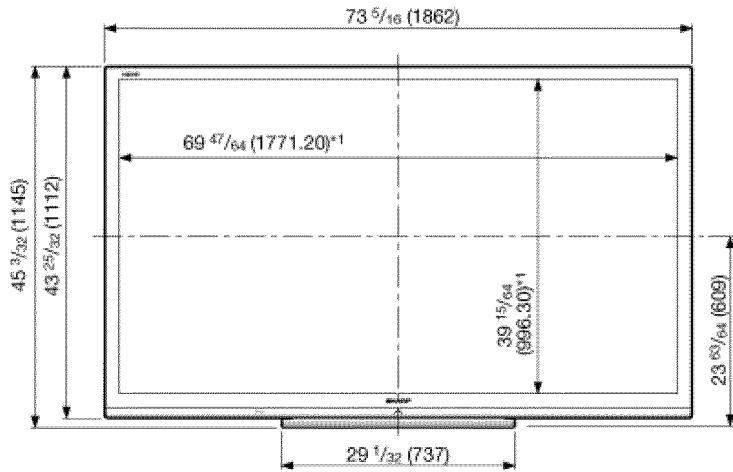

*1 Active area/Área activa/Zone active
 *2 Thinnest part/Parte más delgada/Partie la plus mince
 *3 Including projecting parts/Incluyendo partes salientes/Parties saillantes incluses

SHARP®

SHARP ELECTRONICS CORPORATION

Sharp Plaza, Mahwah, New Jersey 07495-1163

SHARP CORPORATION