

# Washing Machine user manual



Thank you for purchasing this Samsung product.  
To receive more complete service or accessory  
parts, please register your product at or  
contact



[www.samsung.com/register](http://www.samsung.com/register)

1-800-SAMSUNG (726-7864)



# contents

---

<b>INSTALLING YOUR WASHER</b>	<b>11</b>	Unpacking your washer
	<b>11</b>	Overview of your washer
	12	Electrical
	12	Grounding
	12	Water
	13	Drain facility
	13	Flooring
	13	Location considerations
	13	Alcove or closet installation
	13	Undercounter installation (washer only)
	14	With optional pedestal base or stacking kit
	<b>15</b>	Important note to installer
	15	Installation flow chart
<b>OPERATING INSTRUCTIONS</b>	<b>18</b>	Loading your washer
	<b>18</b>	Washing clothes: Basic Instructions
<b>WASHING A LOAD OF LAUNDRY</b>	<b>19</b>	Overview of the control panel
	21	Child Lock 
	22	Spin Only
	22	Garment+ 
	22	Delay End
	22	Drum Light
	23	My Cycle
	23	Smart Care
	24	Washing clothes using the cycle selector
	<b>25</b>	Using steam wash
	<b>25</b>	ATC (Auto Temperature Control)
	<b>26</b>	Detergent use
	<b>26</b>	Features
<b>MAINTAINING YOUR WASHER</b>	<b>28</b>	Cleaning the exterior
	<b>28</b>	Cleaning the interior
	<b>28</b>	Cleaning the dispensers
	<b>28</b>	Storing your washer
	<b>29</b>	Cleaning the debris filter
	<b>30</b>	Cleaning the door seal/bellow
	<b>30</b>	Preserving the top cover and the front frame
	<b>31</b>	Self Clean+
<b>TROUBLESHOOTING</b>	<b>32</b>	Check these solutions if your washer...
	<b>34</b>	Information codes
<b>APPENDIX</b>	<b>36</b>	Fabric care chart
	<b>37</b>	Cycle chart
<b>APPENDIX</b>	<b>38</b>	Helping the environment
	<b>38</b>	Declaration of conformity
	<b>38</b>	Specification

# safety information

---

Congratulations on your new Samsung washer. This manual contains important information on the installation, use, and care of your appliance. Please take time to read this manual to take full advantage of your washer's many benefits and features.

## WHAT YOU NEED TO KNOW ABOUT SAFETY INSTRUCTIONS











---

Warnings and Important Safety Instructions in this manual do not cover all possible conditions and situations that may occur. It is your responsibility to use common sense, caution, and care when installing, maintaining, and operating your washer.

## IMPORTANT SAFETY SYMBOLS AND PRECAUTIONS

---

What the icons and signs in this user manual mean:

 <b>WARNING</b>	Hazards or unsafe practices that may result in <b>severe personal injury or death</b> . To reduce the risk of fire, explosion, electric shock, or personal injury when using your washer, follow these basic safety precautions:
 <b>CAUTION</b>	Hazards or unsafe practices that may result in <b>minor personal injury or property damage</b> .
	Do NOT attempt.
	Do NOT disassemble.
	Do NOT touch.
	Follow directions explicitly.
	Unplug the power plug from the wall socket.
	Make sure the machine is grounded to prevent electric shock.
	Call the service center for help.
	Note

**These warning signs are here to prevent injury to you and others.**

**Please follow them explicitly.**

**After reading this section, keep it in a safe place for future reference.**

 Read all instructions before using the appliance.

## SAVE THESE INSTRUCTIONS

# safety information

---

 **WARNING:** To reduce the risk of fire, electric shock, or injury to persons when using your appliance, follow basic precautions, including the following:

1. Read all instructions before using the appliance.
2. Do not wash or dry articles that have been previously cleaned in, washed in, soaked in, or spotted with gasoline, dry-cleaning solvents, other flammable or explosive substances as they give off vapors that could ignite or explode.
3. Do not allow children to play on or in the appliance. Close supervision of children is necessary when the appliance is used near children.
4. Before the appliance is removed from service or discarded, remove the door to the washing or drying compartment.
5. Do not reach into the appliance if the drum is moving.
6. Do not install or store this appliance where it will be exposed to the weather.
7. Do not tamper with controls.
8. Do not repair or replace any part of the appliance or attempt any servicing unless specifically recommended in the user-maintenance instructions or in the published user-repair instructions that you understand and have the skills to carry out.
9. Do not add gasoline, dry-cleaning solvents, or other flammable or explosive substances to the wash water. These substances give off vapors that could ignite or explode.
10. Under certain conditions, hydrogen gas may be produced in a hot water system that has not been used for 2 weeks or more. **HYDROGEN GAS IS EXPLOSIVE.** If the hot water system has not been used for such a period, before using a washer or combination washer-dryer, turn on all hot water faucets and let the water flow from each for several minutes. This will release any accumulated hydrogen gas. As the gas is flammable, do not smoke or use an open flame during this time.

 **State of California Proposition 65 Warnings:**

**WARNING:** This product contains chemicals known to the State of California to cause cancer and reproductive toxicity.

## SAVE THESE INSTRUCTIONS



## SEVERE WARNING SIGNS FOR INSTALLATION

---



- Plug the power cord into an AC 120 V / 60 Hz / 15 A wall socket or higher and use the socket for this appliance only. In addition, do not use an extension cord.
- Sharing a wall socket with other appliances using a power strip or extending the power cord may result in electric shock or fire.
  - Do not use an electric transformer. It may result in electric shock or fire.
  - Ensure that the power voltage, frequency and current are the same as those of the product specifications. Failing to do so may result in electric shock or fire.

The installation of this appliance must be performed by a qualified technician or service company.

- Failing to do so may result in electric shock, fire, an explosion, problems with the product, or injury.

Remove all foreign substances such as dust or water from the power plug terminals and contact points using a dry cloth on a regular basis.

- Unplug the power plug and clean it with a dry cloth.
- Failing to do so may result in electric shock or fire.

Plug the power plug into the wall socket in the right direction so that the cord runs towards the floor.

- If you plug the power plug into the socket in the opposite direction, the electric wires within the cable may be damaged and this may result in electric shock or fire.
- 



- This appliance must be properly grounded.
- Do not ground the appliance to a gas pipe, plastic water pipe, or telephone line.
- This may result in electric shock, fire, an explosion, or problems with the product.
  - Never plug the power cord into a socket that is not grounded correctly and make sure that it is in accordance with local and national codes.
- 



- Do not install this appliance near a heater or flammable material.
- Do not install this appliance in a humid, oily or dusty location, in a location exposed to direct sunlight and water (rain drops).
- Do not install this appliance in a location where gas may leak.
- This may result in electric shock or fire.

Plug the power plug into the wall socket firmly. Do not use a damaged power plug, damaged power cord or loose wall socket.

- This may result in electric shock or fire.

Do not pull or excessively bend the power cord.

Do not twist or tie the power cord.

Do not hook the power cord over a metal object, place a heavy object on the power cord, insert the power cord between objects, or push the power cord into the space behind the appliance.

- This may result in electric shock or fire.

Do not pull the power cord when unplugging the power plug.

- Unplug the power plug by holding the plug.
- Failing to do so may result in electric shock or fire.

## SAVE THESE INSTRUCTIONS

# safety information

---

-  When the power plug or power cord is damaged, contact your nearest service center.



## CAUTION SIGNS FOR INSTALLATION

---

-  This appliance should be positioned in such a way that it is accessible to the power plug.
- Failing to do so may result in electric shock or fire due to electric leakage.

Install your appliance on a level and hard floor that can support its weight.

- Failing to do so may result in abnormal vibrations, noise, or problems with the product.
- 

-  Unplug the power plug when the appliance is not being used for long periods of time or during a thunder/lightning storm.

- Failing to do so may result in electric shock or fire.



## SEVERE WARNING SIGNS FOR USING

---

-  If the appliance is flooded, cut the power immediately and contact your nearest service center.

If the appliance generates a strange noise, a burning smell or smoke, unplug the power plug immediately and contact your nearest service center.

- Failing to do so may result in electric shock or fire.

In the event of a gas leak (such as propane gas, LP gas, etc.), ventilate immediately without touching the power plug. Do not touch the appliance or power cord.

- Do not use a ventilating fan.
- A spark may result in an explosion or fire.

Do not wash items contaminated with gasoline, kerosene, benzene, paint thinner, alcohol or other flammable or explosive substances.

- This may result in electric shock, fire or an explosion.

Do not open the washer door by force while it is operating (high-temperature washing/drying/spinning).

- Water flowing out of the washer may result in burns or cause the floor to be slippery. This may result in injury.
- Opening the door by force may result in damage to the product or injury.

Make sure to remove the packaging (sponge, styrofoam) attached to the bottom of the washer before using it.

Do not insert your hand under the washer.

- This may result in injury.

## SAVE THESE INSTRUCTIONS



Do not touch the power plug with wet hands.

- This may result in electric shock.

Do not turn the appliance off by unplugging the power plug while an operation is in progress.

- Plugging the power plug into the wall socket again may cause a spark and result in electric shock or fire.

Keep all packaging materials well out of the reach of children, as packaging materials can be dangerous to children.

- If a child places a bag over their head, they may result in suffocation.

Do not let children or infirm persons use this washer unsupervised.

- Failing to do so may result in electric shock, burns or injury.

Do not insert your hand or a metal object under the washer while it is operating.

- This may result in injury.

Make sure the detergent drawer is closed before you put laundry into the washer or remove laundry from the washer.

- If the detergent drawer is open, you could strike the drawer with your head and injure yourself.
- 



Do not attempt to repair, disassemble, or modify the appliance yourself.

- Do not use any fuse (such as copper, steel wire, etc.) other than the standard fuse.
  - When repairing or reinstalling the appliance is required, contact your nearest service center.
  - Failing to do so may result in electric shock, fire, problems with the product, or injury.
- 



If any foreign substance such as water has entered the appliance, unplug the power plug and contact your nearest service center.

- Failing to do so may result in electric shock or fire.

When the water supply hose comes loose from the faucet and floods the appliance, unplug the power plug.

- Failing to do so may result in electric shock or fire.

If any foreign substance enters the appliance, unplug the power plug and contact your nearest service center.

- Failing to do so may result in electric shock or fire.

## SAVE THESE INSTRUCTIONS

# safety information

---



## CAUTION SIGNS FOR USING

---



When the washer is contaminated by a foreign substance such as detergent, dirt, food waste, etc., unplug the power plug and clean the washer using a damp and soft cloth.

- Failing to do so may result in discoloration, deformation, damage or rust.

The front glass may be broken by a strong impact. Take care when using the washer.

- When the glass is broken, it may result in injury.

After a water supply failure or when reconnecting the water supply hose, open the faucet slowly.

Open the faucet slowly after a long period of non-use.

- The air pressure in the water supply hose or the water pipe may result in damage to a part or in water leakage.

If a drain error occurs during an operation, check if there is a draining problem.

- If the washer is used when it is flooded because of a draining problem, it may result in electric shock or fire due to electric leakage.

Insert the laundry into the washer completely so that laundry does not get caught in the door.

- If laundry gets caught in the door, it may result in damage to the laundry or the washer, or result in water leakage.

Ensure that the faucet is turned off when the washer is not being used.

- Ensure that the screw on the water supply hose connector is properly tightened.
- Failing to do so may result in property damage or injury.

Take care that the rubber seal and the front door glass are not contaminated by a foreign substance (e.g. waste, thread, hair, etc.).

- If a foreign substance is caught in the door or the door is not completely closed, it may cause a water leak.

Open the faucet and check if the water supply hose connector is firmly tightened and that there is no water leaking before using the product.

- If the screws or the water supply hose connector are loose, it may result in water leakage.

The product you have purchased is designed for domestic use only.

The use for business purposes qualifies as product misuse. In this case, the product will not be covered by the standard warranty provided by Samsung and no responsibility can be attributed to Samsung for malfunctions or damages resulting from such misuse.

If the wash is not started and the laundry is left for a period of time after you have added detergent or applied stain remover or pre-treatment onto the laundry, the laundry may be discolored.

Select the recommended cycle and temperature on the basis of the laundry items, sort the laundry by color on the basis of its colorfastness and select the appropriate cycle.

Make sure that foreign objects such as pins, buttons and coins are removed from clothing items when adding laundry to the washer. Wash dirty laundry separately from relatively clean items and wash fragile items separately from tougher textiles.

If an item is stained, wash it as soon as possible. Use stain remover or detergent only after testing the colorfastness of the item by applying a small quantity to an inside seam.

## **SAVE THESE INSTRUCTIONS**



-  Do not stand on top of the appliance or place objects (such as laundry, lighted candles, lighted cigarettes, dishes, chemicals, metal objects, etc.) on the appliance.
- This may result in electric shock, fire, problems with the product, or injury.
- Do not operate the appliance with wet hands.
- This may result in electric shock.
- Do not spray volatile material such as insecticide onto the surface of the appliance.
- As well as being harmful to humans, it may also result in electric shock, fire or problems with the product.
- Do not place an object that generates an electromagnetic field near the washer.
- This may result in injury due to a malfunction.
- Since the water drained during a high-temperature wash or drying cycle is hot, do not touch the water.
- This may result in burns or injury.
- Do not wash, spin or dry waterproof seats, mats or clothing (\*).
- Do not wash thick, hard mats even if the washer mark is on the care label.
  - This may result in injury or damage to the washer, walls, floor or clothing due to abnormal vibrations.
- \* Woolen Bedding, rain covers, fishing vests, ski pants, sleeping bags, diaper covers, sweat suits, and bicycle, motorcycle, car covers, etc.
- Do not operate the washer when the detergent dispenser is removed.
- This may result in electric shock or injury due to water leakage.
- Do not insert your hand into the detergent dispenser after opening it.
- This may result in injury as your hand may be caught.
- Do not place any objects (such as shoes, food waste, animals) other than laundry into the washer.
- This may result in damage to the washer, or injury and death in the case of pets due to the abnormal vibrations.
- Do not press the buttons using sharp objects such as pins, knives, fingernails, etc.
- This may result in electric shock or injury.
- Do not wash laundry contaminated by oils, creams or lotions usually found in skincare shops or massage clinics.
- This may result in the rubber seal becoming deformed and water leakage.
- Do not leave metal objects such as a safety pin or hair pin, or bleach in the tub for long periods of time.
- This may cause the tub to rust.
  - If rust starts appearing on the surface of the tub, apply a cleansing agent (neutral) to the surface and use a sponge to clean it. Never use a metal brush.

**SAVE THESE INSTRUCTIONS**

# safety information

---

Do not use dry cleaning detergent directly on clothing and do not wash, rinse, or spin laundry contaminated by dry cleaning detergent.

- This may result in spontaneous combustion or ignition due to heat and oxidation of the oil in the detergent.

Do not use hot water from water cooling/heating devices.

- This may result in problems with the washer.

Do not use natural hand-washing soap for the washer.

- If it hardens and accumulates inside the washer, it may result in problems with the product, discoloration, rust or bad odors.

Do not wash large laundry items such as Bedding in the washing net.

- Failing to do so may result in injury due to abnormal vibrations.
- Place smaller items, such as lace socks and lingerie in the washing net.

Do not use hardened detergent.

- If it accumulates inside the washer, it may result in water leakage.

Do not wash throw rugs or doormats.

- If you wash throw rugs or doormats, the sand will accumulate inside the washer. It may result in error such as no draining.

Take care that children's fingers are not caught in the door when closing it. This may result in injury.



## **SEVERE WARNING SIGNS FOR CLEANING**

---



Do not clean the appliance by spraying water directly onto it.

Do not use a strong acid cleaning agent.

Do not use benzene, paint thinner, or alcohol to clean the appliance.

- This may result in discoloration, deformation, damage, electric shock or fire.

Before cleaning or performing maintenance, unplug the appliance from the wall socket.

- Failing to do so may result in electric shock or fire.

## **SAVE THESE INSTRUCTIONS**

# installing your washer

## UNPACKING YOUR WASHER

Unpack your washer and inspect it for shipping damage. Make sure you have received all the items shown below. If your washer was damaged during shipping, or you do not have all of the items, contact 1-800-SAMSUNG (726-7864).

To prevent personal injury or strain, wear protective gloves whenever lifting or carrying the unit.



Packing materials can be dangerous to children. Keep all packing material (plastic bags, polystyrene, etc.) well out of the reach of children.

## OVERVIEW OF YOUR WASHER

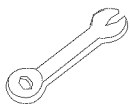
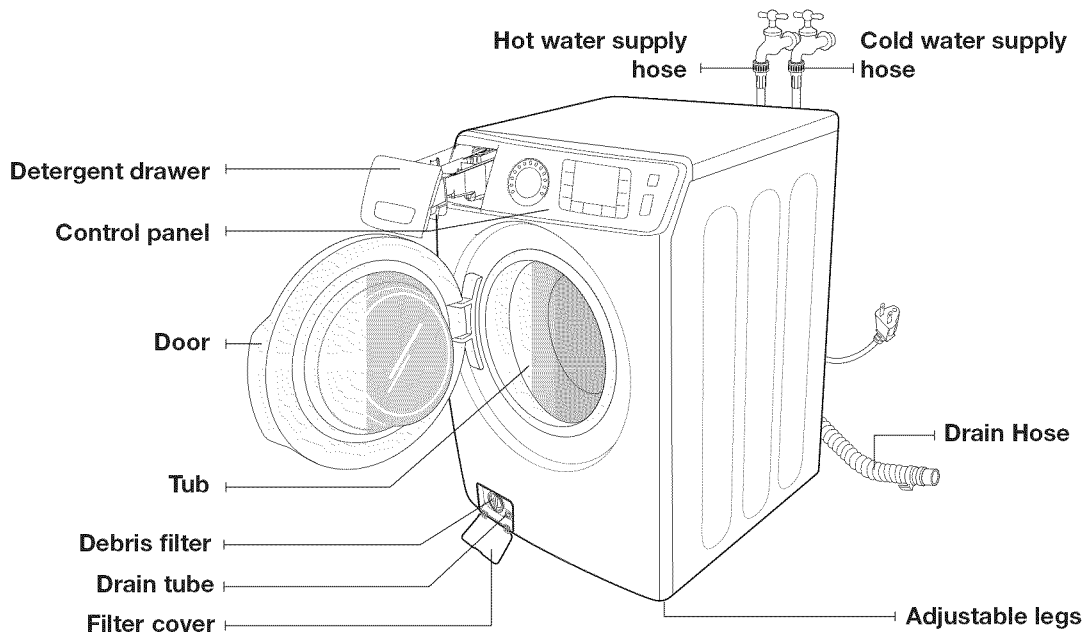

Wrench



Bolt Hole Covers

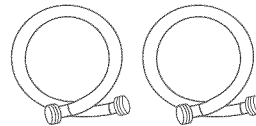

Water Supply Hoses

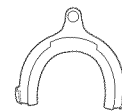

Hose Guide

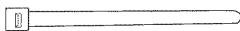

Plastic Zip Hose Tie



anti-slip pads



\* Bolt hole covers : The number of bolt hole covers depends on the model (3~6 covers).

# installing your washer

---

## BASIC LOCATION REQUIREMENTS

---

### Electrical

---

- 120 Volt 60 Hz 15 AMP fuse or circuit breaker.
- An individual branch circuit serving only your washer is recommended.
- Your washer is equipped with a power cord.



NEVER USE AN EXTENSION CORD.

### Grounding

---

#### ELECTRICAL GROUNDING IS REQUIRED FOR THIS APPLIANCE.

This appliance must be grounded. In the event of malfunction or breakdown, grounding will reduce the risk of electric shock by providing a path of least resistance for electric current.

This appliance is equipped with a power cord having a three-prong grounding plug for use in a properly installed and grounded three-prong outlet.

The plug must be plugged into an appropriate outlet that is properly installed and grounded in accordance with all local codes and ordinances.



An improperly connected equipment-grounding conductor can increase the risk of electrical shock. Check with a qualified electrician or serviceman if you are not sure whether the appliance is properly grounded. Do not modify the plug provided with the appliance – if it does not fit the outlet, have a proper outlet installed by a qualified electrician.

### IMPORTANT SAFETY PRECAUTIONS

- To prevent unnecessary risk of fire, electrical shock or personal injury, all wiring and grounding must be done in accordance with the National Electrical Code ANSI/FNPA, No. 70's latest revision and local codes and ordinances. It is the personal responsibility of the appliance owner to provide adequate electrical service for this appliance.



NEVER CONNECT THE GROUND WIRE TO PLASTIC PLUMBING LINES, GAS LINES, OR HOT WATER PIPES.

### Water

---

Using bad quality water may cause the water supply valve to operate abnormally.

To correctly fill your washer in the proper amount of time, water pressure of 20-116 psi (137-800 kPa) is required.

Water pressure less than 20 psi may cause water valve failure, may not allow the water valve to shut off completely, or may extend the fill time beyond what your washer controls allow, causing your washer to turn off. A time limit is built into the controls to prevent extensive flooding in your home if an internal hose becomes loose.

The water faucets must be within 4 feet / 122 cm of the back of your washer to match the inlet hoses provided with your washer.



Accessory inlet hoses are available in various lengths up to 10 feet/305 cm for faucets that are further away from the back of your washer.

To avoid the possibility of water damage:

- Have water faucets easily accessible.
- Turn off faucets when the washer is not in use.
- Periodically check that there is no leakage from the water inlet hose fittings.



CHECK ALL CONNECTIONS AT THE WATER VALVE AND FAUCET FOR LEAKS.

## Drain facility

The recommended height of the standpipe is 18 in/46 cm. The drain hose must be routed through the drain hose clip to the standpipe. The standpipe must be large enough to accept the outside diameter of the drain hose. The drain hose is attached at the factory.

## Flooring

For best performance, you must install your washer on a solidly constructed floor. Wood floors may need to be reinforced to minimize vibration and/or unbalanced load situations. Carpeting and soft tile surfaces are contributing factors to vibration which can cause your washer to move slightly during the spin cycle.

Never install your washer on a platform or weakly supported structure.

## Location considerations

Do not install your washer in areas where water may freeze, since your washer will always retain some water in its water valve, pump, and hose areas. Freezing water can damage the belts, the pump, hoses and other components.

## Alcove or closet installation

### MINIMUM CLEARANCES FOR CLOSET AND ALCOVE INSTALLATIONS:

Sides – 1 in / 25 mm

Top – 17 in / 432 mm

Rear – 5.9 in / 150 mm

Closet Front – 2 in / 51 mm

If the washer and dryer are installed together, the closet front must have at least a 72 in<sup>2</sup> (465 cm<sup>2</sup>) unobstructed air opening. Your washer alone does not require a specific air opening.

A. Recessed area

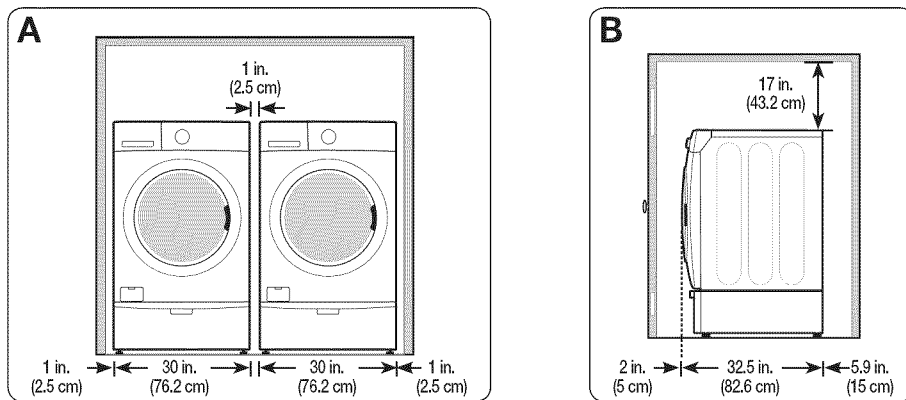

B. Side view - closet or confined area

## Undercounter installation (washer only)

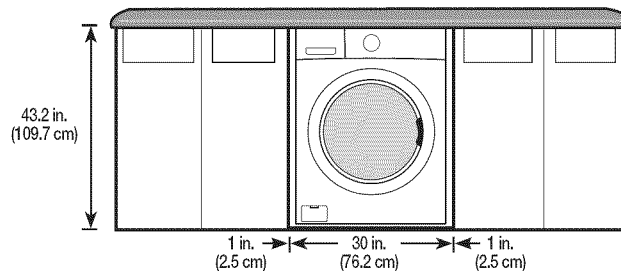

# installing your washer

## With optional pedestal base or stacking kit

### Required Dimensions for Installation With Pedestal

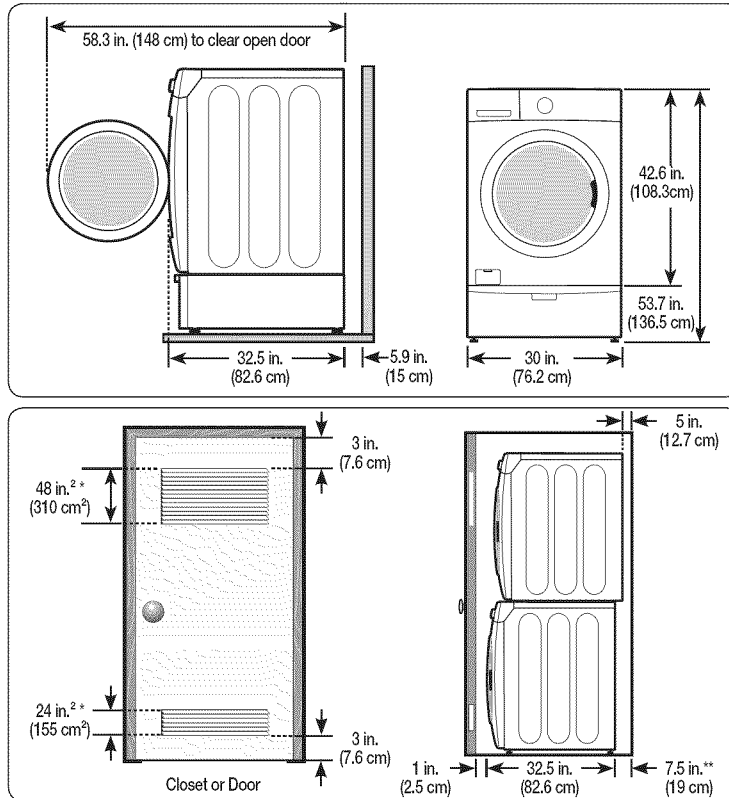

### Required Dimensions for Installation With Stacking Kit

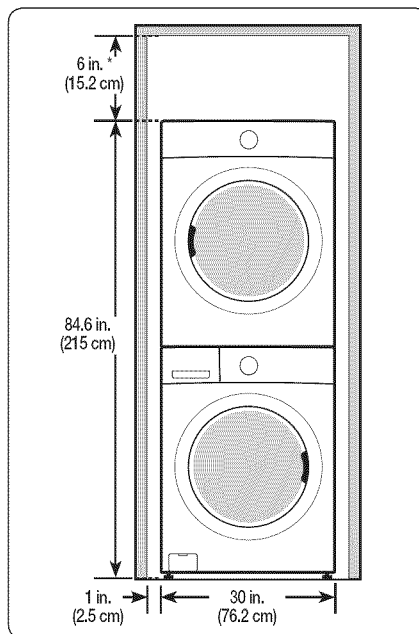

\* Required spacing

\*\* External exhaust elbow requires additional space.

## IMPORTANT NOTE TO INSTALLER

Please read the following instructions carefully before installing the washer.

These instructions should be retained for future reference.

We recommend you hire a professional to install this washer.

### Installation flow chart

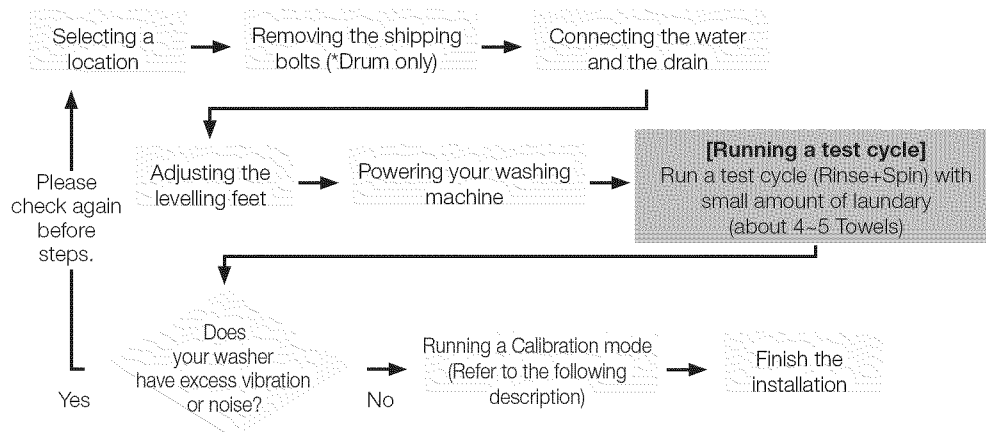

### STEP 1

#### Removing the Shipping Bolts

Before using your washer, you must remove all shipping bolts from the back of the unit.

1. Loosen all the bolts with the supplied wrench.
2. Slide the bolt and spacer up and remove the bolt with the spacer through the hole in the rear wall of your washer. Repeat for each bolt.
3. Cover the holes with the supplied Bolt Hole Covers (See page 13).
4. Keep the shipping bolts and spacers for future use.

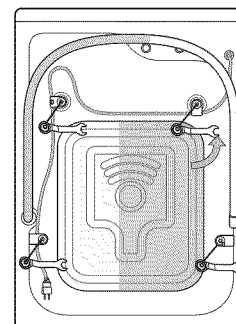

### STEP 2

#### Selecting a Location

 Before you install your washer, make sure the location:

- Has a hard, level surface.
- Is away from direct sunlight.
- Has adequate ventilation.
- Will not freeze (temperatures are never below 32 °F or 0 °C).
- Is away from heat sources such as oil or gas.
- Has enough room for the power cord.
- Doesn't have any carpeting that will obstruct ventilation openings.

# installing your washer

## STEP 3

### Installing your Washer

1. If you use a standpipe, make sure the connection between the drain hose and the standpipe is NOT airtight. The standpipe must be at least 18 in or 46 cm high.

-  You must always exercise caution to avoid collapsing or damaging the drain hose. For best results, the drain hose should not be restricted in any way – by elbows, couplings, or excessive length. For situations where the drain hose cannot be conveniently elevated to at least 18 in or 46 cm, the drain hose must be supported. If the drain hose is installed below 18”(46cm), water can be drained due to the cause of a siphon phenomenon. This will cause the washer to display a “4E” error.

-  The drain hose can be installed to a 96” (245cm) maximum, however, the drain capabilities can be reduced at this height. This can cause the washer to have an odor because of remaining water in the drain system.

-  Connect the hose guide within 6”(15cm) from the end of the drain hose. If the drain hose is extended more than 6”(15cm) beyond the end of the hose guide, mold or microorganisms could spread to the inside of the washer.

2. Check the inlet hose to ensure a washer is inside each fill hose. Thread the inlet hoses to the HOT and COLD faucet connections. On the other end of the hose, check for one rubber washer per hose and attach each fill hose to the water valve. Make sure the hose with Hot printed on it is attached to the HOT faucet. Tighten by hand until snug, then two-thirds of a turn with pliers.

-  For correct water use, connect both HOT and COLD water valves. If either or both are not connected, a “4E” error can occur.

3. Turn on the “HOT” and “COLD” water supply and check the water valve and the water supply connections for leaks.

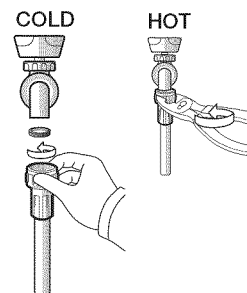
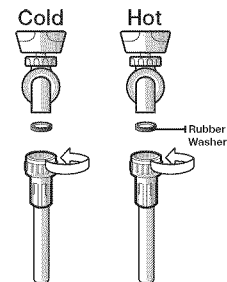
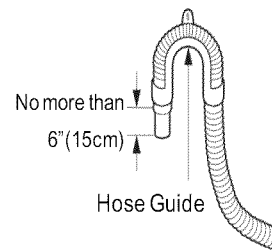
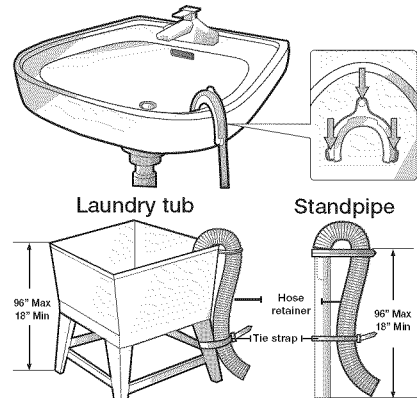



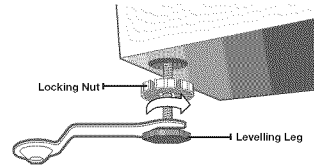
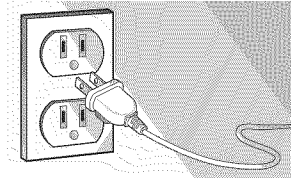

4. Slide your washer into position.
5. Level your washer by turning the leveling legs in or out as necessary by hand or by using the wrench included with your washer.  
When your washer is level, tighten the locking nuts using the wrench or (-) flathead screwdriver.
6. Plug the power cord into a 3-Prong, well grounded 120 volt 60 Hz approved electrical outlet protected by a 15-amp fuse or comparable circuit breaker.  
Your washer is grounded through the third prong of the power cord when plugged into a three-prong grounded receptacle.

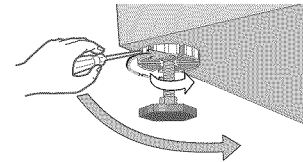

-  Your washer must be leveled on all four sides. A carpenter's level should be used on all four corners of your washer. We recommend you recheck your washer after a dozen or so washes to make sure it's still level.



-  Avoid damage to the legs. Do not move the washer unless the locking nuts are fastened to the bottom of the washer.

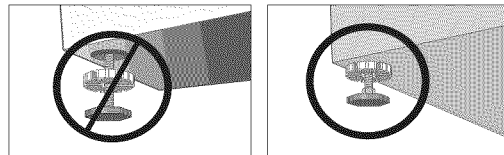

-  **Test run**  
Make sure that you install your washing machine correctly by running the **Rinse+Spin** cycle after the installation is complete.

## STEP 4 Calibration mode

Your Samsung washing machine automatically detects the weight of the laundry. For more accurate weight detection, please run the Calibration Mode after the installation. To run the Calibration Mode, follow these steps:

1. Turn on the washer.
2. Press the **Temp.** button and **Delay End** button simultaneously for at least 3 seconds.
3. Remove any contents in the tub and close the door.
4. Press the **Start/Pause** button.
5. The drum rotates clockwise and counterclockwise for approximately 3 minutes.
6. When the Calibration Mode is finished, the "En/End" appears on the display and the washing machine turns off automatically. The washing machine is now ready for use.



# operating instructions

---

 To reduce the risk of fire, electric shock, or injury to persons, read the IMPORTANT SAFETY INSTRUCTIONS before operating this appliance.





## LOADING YOUR WASHER

---

- You can fill the tub with dry, unfolded clothes, but **DO NOT OVERLOAD** the tub more than 3/4 full.
  - Overloading may reduce washing efficiency, cause excess wear, and possibly cause creasing or wrinkling of the load.
  - Wash delicate items such as bras, hosiery, and other lingerie in the Delicates cycle with similar lightweight items.
  - When washing big bulky items or a few smaller items that don't fill the tub completely – a rug, a pillow, stuffed toys, or one or two sweaters, for example – add a few towels to improve tumbling and spin performance.
-  During the spin cycle, the washer may add additional water to redistribute the clothes and correct an imbalance inside the drum.
- To ensure good cleaning result when washing heavily soiled loads, do not overload your washer.
  - When the “Garment+” light is ON (see page 22), you can add or remove laundry items during a wash.
    1. Press the **Start/Pause** Button.
    2. Wait for the Door Lock light to go out (5 seconds).
    3. Add the item, close the door, and press the **Start/Pause** Button.  
After a 10-second pause, the cycle will resume.
-  To ensure thorough cleaning, add items within five minutes of starting the wash cycle.

## WASHING CLOTHES: BASIC INSTRUCTIONS

---

1. Press the **Power** button, open the door, and then load the washer.
  2. Close the door.
-  Push the laundry into the drum completely to prevent the laundry from being caught in the door or from falling out of the drum.
3. Add detergent and additives to the dispenser (see pages 27~28).
  4. Select the appropriate cycle and options for the load (see pages 19~21 and 24).
  5. Press the **Start/Pause** Button.
-  The drum automatically rotates and measures the weight of the laundry without supplying water in order to adjust the wash time. (The rotating display on the display panel indicates that the weight of the laundry is being measured.)
6. The Wash indicator light will illuminate.
  7. The estimated cycle time will appear in the display.  
The time may fluctuate to indicate the time remaining in the cycle.
-  The actual time required for a cycle may differ from the estimated time in the display depending on the water pressure, water temperature, detergent, and laundry load.
8. Before your washer starts to fill, it will make a series of clicking noises to check the door lock and perform a quick drain.
-  • When the cycle is complete, the Door Lock light will go out and “End” will appear in the display.  
• **DO NOT** attempt to open the door until the Door Lock light is off. To add a forgotten item, see the “Loading your Washer” section above.  
• When your washer is restarted after a pause, expect a delay of up to 15 seconds before the cycle continues.  
• Pressing the **Power** button cancels the cycle and stops your washer.  
• The Pre Wash, Wash, Rinse, and Spin indicator lights will illuminate during those portions of the cycle.
-  Do not place anything on top of your washer while it is running.

# washing a load of laundry

## OVERVIEW OF THE CONTROL PANEL

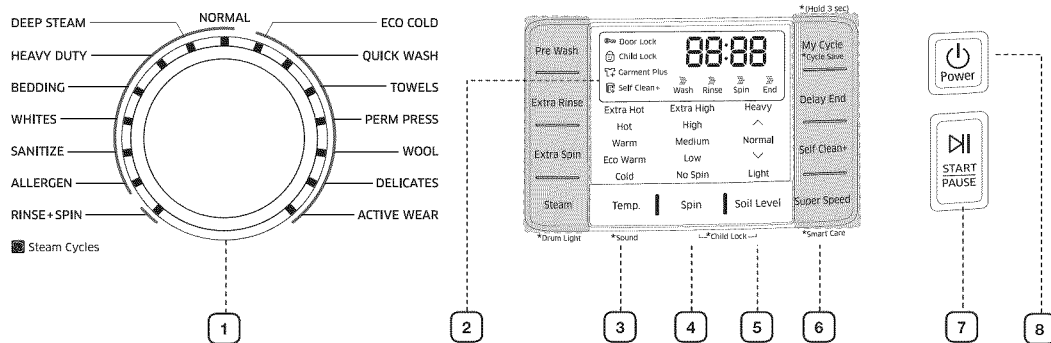

### 1 Cycle Selector

Select the appropriate cycle for the type of load.

This will determine the tumble pattern and spin speed for the cycle.

To minimize wrinkling of laundry, select the Perm Press cycle.

**DEEP STEAM** - For heavily soiled, colorfast garments, this cycle provides a high washing temperature and steam, and is effective for cleaning stains.

**HEAVY DUTY** - For sturdy, colorfast fabrics and heavily soiled garments.

**BEDDING** - For bulky items such as comforters, blankets and sheets.

When washing bulky items, use liquid detergent and refrain from rolling them because it might cause them to get stuck in the drum.

**WHITES** - For white fabrics with or without bleach

**SANITIZE** - For heavily soiled, colorfast garments. This cycle heats the water to 150 °F to eliminate bacteria.

If you select pause during the heating portion of the Sanitize Cycle, your washer door will remain locked for your safety.

When selecting this cycle, the water heats to an extra high temperature to remove 99.9% of certain bacteria typically found on clothing, bedding, or towels. This certification is conducted by NSF International, an independent third-party testing and certification organization.

Please check the garment care label to avoid garment damage.

Only the SANITIZE cycle has been designed to meet the requirements of this protocol for sanitization efficacy.



NSF Protocol P172  
Sanitization Performance of Residential and Commercial, Family-Sized Clothes Washers

**ALLERGEN** - This cycle is used to remove dust mites, pet dander or other allergic substances of the fabric.

Only the ALLERGEN cycle has been designed to meet the requirement of P351 for allergen reduction efficacy.



NSF Protocol P351  
Allergen Reduction Performance of Residential and Commercial, Family-Sized Clothes Washers

**RINSE + SPIN** - Use for loads that need rinsing only or to add rinse-aided fabric softener to a load.

**NORMAL** - For most fabrics including cottons, linens, and normally soiled garments.

# washing a load of laundry

	<p><b>ECO COLD</b> - It provides useful daily care for normally and lightly soiled laundry by using only cold water, saving energy and caring fabric.</p> <p><b>QUICK WASH</b> - For lightly soiled garments needed quickly.</p> <p><b>TOWELS</b> - For bath towels, washcloths, and mats.</p> <p><b>PERM PRESS</b> - For wash-and-wear, synthetic fabrics, and lightly to normally soiled garments.</p> <p><b>WOOL</b> - For machine-washable wool. Loads should be under 8 pounds. For best results, we recommend a load of 4.4 pounds or less.</p> <ul style="list-style-type: none"> <li>• The Wool cycle washes laundry by moving the wash drum horizontally to maintain the characteristics of the wool fibers and to prevent damage to the cloth. It then stops for a while to allow the laundry to soak in the water. This pause in the operation of the Wool cycle is normal.</li> <li>• We recommend you use a neutral detergent to prevent damage to the cloth and to improve the washing results.</li> </ul> <p><b>DELICATES</b> - For sheer fabrics, bras, lingerie silk, and other handwash-only fabrics. For best results, use liquid detergent.</p> <p><b>ACTIVE WEAR</b> - Use this cycle to wash exercise wear such as sports jerseys, training pants, shirts/tops and other performance clothing. This cycle provides effective soil removal with gentle action for special fabric care.</p>
<p>2 <b>Digital display</b></p>	<p>The large Digital Display is easy to use. It provides instructions and diagnostics while keeping you updated on the cycle status and time remaining.</p>
<p>3 <b>Temperature selection button</b></p>	<p>Press the button repeatedly to cycle through the different water temperature options.</p> <p><b>Extra Hot</b> - Heavily soiled, colorfast items. Only available with the Sanitize, and Allergen cycle.</p> <p><b>Hot</b> - Whites and heavily soiled, colorfast items.</p> <p><b>Warm</b> - Colorfast items. When warm rinse is selected, only the final rinse will be warm.</p> <p>The other rinses will be cold to conserve energy.</p> <p><b>Eco Warm</b> - Moderately soiled, colorfast items; most wrinkle-free items.</p> <p><b>Cold</b> - Brightly colored, very lightly soiled items.</p>
<p>4 <b>Spin selection button</b></p>	<p>Press the button repeatedly to cycle through the different spin speed options. (Rinse hold (All Lamp Turn Off) → No Spin → Low → Medium → High → Extra High)</p> <p><b>Extra High</b> - Removes more water from loads during spin.</p> <p> To minimize wrinkling of wrinkle-free and no-iron fabrics, DO NOT use the Extra High spin option for these loads, nor overload your Washer.</p> <p><b>High</b> - Use for underwear, t-shirts, jeans and sturdy cottons.</p> <p><b>Medium</b> - Use for jeans, wrinkle-free or wash-and-wear items and synthetics.</p> <p><b>Low</b> - Use for delicate items needing a slow spin speed.</p> <p><b>No Spin</b> - Drains your washer without spinning. Use for extremely delicate items that cannot tolerate any spin.</p> <p><b>Rinse Hold (All Lamp Turn Off)</b> - The laundry remains soaking in the final rinse water. Either a drain or spin cycle must be performed to unload the laundry.</p>
<p>5 <b>Soil Level selection button</b></p>	<p>Press the button to select the soil level/washing time. (Heavy → ^ → Normal → v → Light)</p> <p><b>Heavy</b> - For heavily soiled loads. ^</p> <p><b>Normal</b> - For moderately soiled loads. This setting is best for most loads. v</p> <p><b>Light</b> - For lightly soiled loads.</p>

<p><b>6</b> <b>Select Cycle Option</b></p>	<p>Press these buttons to select different cycle options.</p> <p><b>Pre Wash</b> - To use this feature, add detergent to the pre wash section of the detergent compartment. When turned on, the washer fills with cold water and detergent, tumbles, then drains and advances to the selected wash cycle. Some cycles cannot be selected with this option (See page 37).</p> <p><b>Extra Rinse</b> - Add an additional rinse at the end of the cycle to remove laundry additives and perfumes more thoroughly.</p> <p><b>Extra Spin</b> - Add additional time to remove more water from loads.</p> <p><b>Steam</b> - Press this button to use the Steam Wash function. Steam Wash is available with the Normal, Heavy Duty, Bedding, Sanitize, Deep Steam, Whites and Allergen cycles. For heavily soiled, colorfast garments, Steam Wash improves stain treatment and uses less water (See page 25).</p> <p><b>My Cycle</b> - Choose your favorite cycle including temperature, spin, soil level, options, etc. (see page 23)</p> <p><b>Delay End</b> - Any cycle can be delayed for up to 24 hours in one-hour increments. Displayed hour indicates the time at which the wash will be started. (See page 22).</p> <p><b>Self Clean+</b> - Use to clean dirt and possible mold from the drum. Regular use (after every 40 washes) is recommended. No detergent or bleach is needed (see page 31).</p> <p><b>Super Speed</b> - Press this button if you need to shorten the washing time, applicable for Normal, Heavy Duty, Deep Steam, Bedding or Allergen cycles. The shortened time may differ depending on the Cycle/Load/Option.</p>
<p><b>7</b> <b>Start/Pause selection button</b></p>	<p>Press to pause and restart cycles.</p>
<p><b>8</b> <b>Power button</b></p>	<p>Press once to turn your washer on, press again to turn your washer off. If the washer is left on for more than 10 minutes without any buttons being pressed, the power automatically turns off.</p>



## Child Lock

Child Lock prevents children from playing with your washer.

Once you have activated the Child Lock function, the control panel cannot be activated, preventing children from playing with the washer.

### Activating the Child Lock function

Press and hold both the **Soil Level** and **Spin** buttons simultaneously for approximately 3 seconds.

- When you activate the Child Lock function, the door locks and the “Child Lock ” lamp illuminates.
- If you press the **START/PAUSE** button after you have activated the Child Lock function, none of the buttons will work except for the **POWER** button.
- If you press a button when the buttons are locked, the “Child Lock ” lamp blinks.

### Pausing the Child Lock function

When the door is locked or the buttons are locked by the Child Lock function, you can pause the Child Lock operation for 1 minute by pressing and holding both the **Soil Level** and **Spin** buttons simultaneously for approximately 3 seconds.

- If you pause the Child Lock mode temporarily, the door lock is released for 1 minute for user convenience. During this period, the “Child Lock ” lamp blinks.
- If you open the door after the minute is over, an alarm sounds for up to 2 minutes.
- If you close the door within the 2 minutes, the door is locked and the Child Lock function is reactivated. If you close the door after the 2 minutes, the door is not locked automatically and no alarm sounds.

# washing a load of laundry

---

## Deactivating the Child Lock function

Press and hold both the **Soil Level** and **Spin** buttons simultaneously for approximately 6 seconds.

- When you deactivate the Child Lock function, the door is unlocked and the “Child Lock ” is turned off.



- The Child Lock function prevents children or the infirm from accidentally operating the washer and injuring themselves.
- If a child enters the washing machine, the child may become trapped and suffocate.
- Once you have activated the Child Lock function, it continues working even if the power is turned off.
- Opening the door by force can result in injury and damage to the product.



To add laundry after you have activated the Child Lock function, you must first pause or deactivate the Child Lock function.



If you want to open the door of the washing machine when the Child Lock function is activated:

- Pause or deactivate the Child Lock function.
- Turn the washing machine off and then on again.

## Spin Only

---

If you press the **POWER** button and then press and hold the **Spin** button for 3 seconds, the spin time will be displayed on the display panel.

Then, press the **Spin** button repeatedly until the required spin level is selected, and then press the **START/PAUSE** button.



When you have selected a cycle, you can only choose the spin level among the spin levels available for the selected cycle.

## Garment+

---

You can add or take out laundry items even after the wash has started, as long as the “Garment+ ” light is on. Pushing the **START/PAUSE** button unlocks the door, unless the water is too hot or if there is too much water in your washer. If you are able to unlock the door and wish to continue the wash cycle, close the door, and then press the **START/PAUSE** button.

## Delay End

---

You can set the washing machine to start your wash automatically at a later time, choosing a delay time. The hour displayed indicates the time at which the wash will be end.

1. Set your wash cycle.
2. Press the **Delay End** button repeatedly until the delay time is set.
3. Press the **START/PAUSE** button. The “Delay End ” indicator will be lit, and the clock will begin counting down until it reaches the set time.
4. To cancel a Delay End function, press the **POWER** button and then turn the washing machine on again.

## Drum Light



---

1. If the door is opened when the power is on, the Drum Light is automatically turned on.
2. If the door is closed when the power is on, the Drum Light is automatically turned off.
3. Press the **Steam** buttons for 3 seconds to turn the Drum Light on or off.
4. If a few minutes have passed after the Drum Light is turned on, the Drum Light is automatically turned off.

## My Cycle

Lets you save a custom wash cycle (temperature, spin, soil level, etc.) and then recall and use it with one button convenience.

To save a cycle and selected options as your My Cycle, follow these steps:



1. Select the cycle using the **Cycle Selector** dial.
2. After cycle selection, set each option.
  -  See page 37 for available option settings with each cycle.
3. You can then store the selected cycle and options by pressing and holding the **My Cycle** button for longer than 3 seconds. The cycle and options you select will be displayed the next time you choose the My Cycle function.
4. Press the My Cycle button to load and use the saved My Cycle options. The “My Cycle” light will indicate activation. Also, the chosen cycle and option lights will flicker
  -  You can change the “My Cycle” settings by repeating the process above. The washer displays the last settings used the next time you choose “My Cycle”.
  -  If you press My Cycle and release it within 3 seconds, the previously saved cycle and options appear. If you press and hold My Cycle for 3 second or longer, the currently set cycle and options are saved and the LED blinks for 3 seconds.

## Smart Care

This function enables you to check the status of the washing machine using a smartphone.

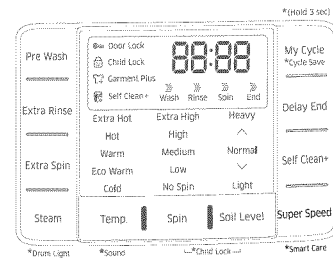
1. To enable the Smart Care function, press and hold the **SuperSpeed** button for 3 seconds.
2. If the Smart Care function is activated, the LED on the window display rotates for 2 or 3 seconds and then the Smart Care indicator is lit on the display.
3. Run the Smart Care app on your smart phone.
4. The Smart Care function is optimized with Galaxy and iPhone series phones.
5. Focus your smart phone’s camera on the display panel of the washing machine.
6. If the smart phone’s camera is focused on the display panel of the washing machine, the panel and error message is automatically recognized and the error type and countermeasures are displayed on the smart phone.
7. If the smartphone fails to recognize the error code more than twice, please enter the error code displayed on the display panel of the washer manually into the Smart Care app.



-  Downloading the Smart Care app
  - Download the Samsung Laundry App into your mobile phone from the ‘Android’ market or ‘Apple App store’. (**Search word : Samsung Smart Washer**)
-  Precautions when using Smart Care:
  - If a lighting device (e.g. fluorescent or lamp) is reflected on the display panel of the washing machine, the result on the display panel may not be recognized easily.
  - If an error occurs more than twice, please manually enter the error code displayed on the display panel of the washing machine into the Smart Care app.
  - If the angle of the smartphone camera and the display panel of the washing machine is incorrect, the error may not be recognized properly. Please try to hold the smart phone at an angle to the display panel as shown by the figure.

# washing a load of laundry

---

## Washing clothes using the cycle selector

---

Your new washing machine makes washing clothes easy, using Samsung's "Fuzzy Control" automatic control system. When you select a wash program, the machine will set the correct temperature, washing time, and washing speed.

1. Turn on your sink's water tap.
  2. Press the Power button.
  3. Open the door.
  4. Load the articles of clothing one at a time loosely into the drum, without overfilling it.
  5. Close the door.
  6. Add detergent, softener, and pre-wash detergent (if necessary) into the appropriate compartments.
-  Pre-wash is only available when selecting the NORMAL, DEEP STEAM, HEAVY DUTY, BEDDING, WHITES, SANITIZE, ALLERGEN, TOWELS, ACTIVE WEAR, PERM PRESS and ECO COLD cycles. It is only necessary if your clothing is heavily soiled.
7. Use the Cycle Selector to select the appropriate cycle according to the type of material: NORMAL, DEEP STEAM, HEAVY DUTY, BEDDING, WHITES, SANITIZE, ALLERGEN, RINSE+SPIN, ECO COLD, QUICK WASH, TOWELS, PERM PRESS, WOOL, DELICATES, ACTIVE WEAR. The relevant indicators will illuminate on the control panel.
  8. At this time, you can control the wash temperature, the number of rinse cycles, the spinning speed, and the delay time by pressing the appropriate option button.
  9. Press the **Start/Pause** button on the Cycle Selector and the wash will begin. The process indicator will light up and the remaining time for the cycle will appear in the display.

## Pause Option

1. Within 5 minutes of starting a wash, it is possible to add/remove laundry items to/from the wash.
2. Press the Start/Pause button to unlock the door.
3. The door cannot be opened when the water is too HOT or the water level is too HIGH.
4. After closing the door, press the Start/Pause button to restart the wash.

## When the cycle is finished:

After the total cycle has finished, the power will turn off automatically.

1. Open the door.
2. Remove laundry.



## USING STEAM WASH

---

If you select steam, the steam acts at the most effective times for the detected amount of laundry, maximizing the effect of the steam, increasing the wash temperature, enhancing the Soak effect, and improving wash performance.



1. Load the washer.
2. Press the **Power** button.
3. Turn the Cycle Selector and select a **Steam Cycle**. (The Deep Steam cycle automatically selects Steam.)
4. Press the **Steam** button.
5. Add detergent to the dispenser tray and add fabric softener up to the marked line.
6. Press the **Start/Pause** button.  
: The washer automatically selects the optimal wash conditions by sensing the weight of the laundry.

 Steam may not necessarily be visible during the steam cycles. Steam may not be present during the entire steam wash cycle.

## ATC (AUTO TEMPERATURE CONTROL)

---

ATC is the control function that the washer controls water temperature with temperature sensor (thermistor).

-  Because there are numerous water temperatures depending on the customer's environment (cold areas, warm areas, various water temperatures, settings of heater temperature, etc.), ATC function in our washer maintains the certain level of wash temperature to output the best washing performance at each cycle.
-  If you select normal & heavy duty cycles, those cycles are the regulation and UL cycles. Since new washer must reduce the amount of energy usage as a first priority, customers will notice more cold water entering the washers, but this is normal and not a problem.
-  In those regulation cycles, hot temperature is similar to acceptable adult bath-water temperature and warm temperature is similar to comfortable swimming-pool water temperature.  
If customers want to wash clothes in a specific water temperature, customers should choose a different cycle at each temperature (Hot/Warm/Eco Warm) .

# washing a load of laundry

## DETERGENT USE

Your Washer is designed to use high efficiency (HE) detergents.

- For best cleaning results, use a high efficiency detergents such as Tide HE, Wisk HE, Cheer HE, or Gain HE\*. High efficiency detergents contain suds suppressors that reduce or eliminate suds. When fewer suds are produced, the load tumbles more efficiently and cleaning is maximized.

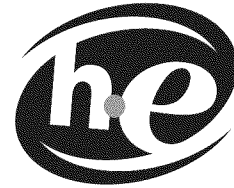

 **WARNING** Regular detergent is NOT recommended. Please use HE detergents only.

 Reducing the amount of detergent may reduce the quality of cleaning. It is important to pre-treat stains, sort carefully by color and soil level, and avoid overloading.

\* Brand names are trademarks of their respective manufacturers.

## FEATURES

### Automatic dispenser

Your washer has separate compartments for dispensing detergent and color-safe bleach, chlorine bleach, and fabric softener. Add all laundry additives to their respective compartments before starting your washer.

The automatic dispenser **MUST ALWAYS** be in place before you start your washer.

DO NOT open the automatic dispenser when your washer is running.

Usage Pointers:

- Never exceed the manufacturer's recommendations when adding detergent.
- This compartment holds liquid detergent for the main wash cycle, which the washer adds to the load at the beginning of the cycle.

 Before using powdered detergent, remove the Liquid Detergent holder from the compartment. Powdered detergent will not dispense from the Liquid Detergent holder.

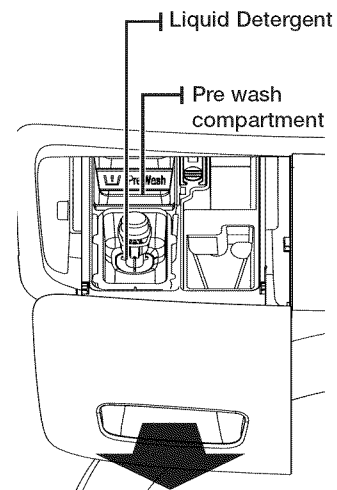

### Detergent compartment

- Pour the recommended amount of laundry detergent directly into the detergent compartment before starting your washer.

## Pre wash compartment

When using the Pre Wash option, add detergent to both the Pre Wash compartment and the detergent compartment. The washer will automatically dispense the detergent during Pre Wash.

- If you use a high efficiency (HE) detergent, add 1/3 of the recommended amount to the Pre Wash compartment and 2/3 of the recommended amount to the detergent compartment.

## Bleach compartment

(Liquid chlorine bleach only)

1. Add chlorine bleach to the bleach compartment.  
DO NOT exceed the MAX FILL line.
2. Avoid splashing or over-filling the compartment.
3. Your washer automatically dispenses bleach into the tub at the appropriate time.
4. The dispenser automatically dilutes liquid chlorine bleach before it reaches the wash load.



- Never pour undiluted liquid chlorine bleach directly onto the load or into the tub. It is a powerful chemical and can cause fabric damage, such as weakening of the fibers or color loss, if not used properly.
- Oxi-type boosters or color-safe bleach can be added to the drum prior to adding laundry.
- Put the laundry into the drum only after confirming that the oxi-type boosters or color-safe bleach has completely entered the hole of the drum.
- To use powdered detergent and powder oxi-type boosters or powdered color-safe bleach at the same time, it is more effective to put them in the drum together before adding the laundry. When you use powdered detergent, remember to remove the Liquid Detergent holder from the detergent compartment.

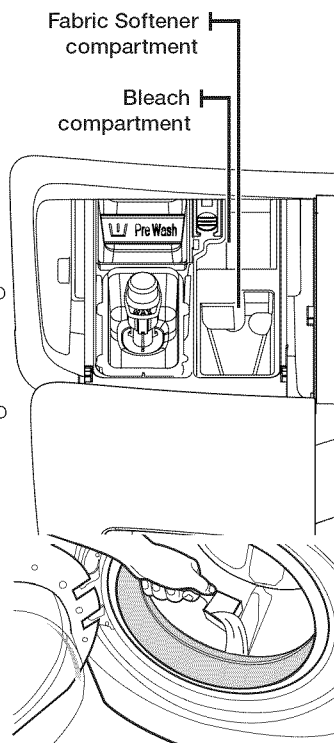

## Fabric softener compartment

1. Pour the recommended amount of liquid fabric softener into the softener compartment.  
For smaller loads, use less than one capful.
2. Dilute the fabric softener with water until it reaches MAX FILL in the compartment.
3. The dispenser automatically releases liquid fabric softener at the proper time during the rinse cycle.



- Use the softener compartment ONLY for liquid fabric softeners.
- DO NOT use a Downy Ball\* in the Fabric softener compartment of this washer. It will not be added at the appropriate time.  
Use the detergent compartment.
- \* Brand names are trademarks of their respective manufacturers.



- If you overfill the detergent, bleach, or softener compartments, the contents of the compartment will automatically be released into the washer. This could damage any garments that are in the drum.

# maintaining your washer

---

## CLEANING THE EXTERIOR

---

Turn off the water faucets after finishing the day's washing.

This will shut off the water supply to your washer and prevent the unlikely possibility of damage from escaping water. Leave the door open to allow the inside of your washer to dry out.

Use a soft cloth to wipe up all detergent, bleach or other spills as they occur.

Clean the following as recommended below:

Control Panel – Clean with a soft, damp cloth. Do not use abrasive powders or cleaning pads. Do not spray cleaners directly on the panel.

Cabinet – Clean with soap and water.

## CLEANING THE INTERIOR

---

Clean the interior of your washer periodically to remove any dirt, soil, odor, mold, mildew, or bacterial residue that may remain in your washer as a result of washing clothes.

Failure to follow these instructions may result in unpleasant conditions, including odors and/or permanent stains on your washer or laundry.

Hard water deposits may be removed, if needed. Use a cleaner labeled "Washer safe".

## CLEANING THE DISPENSERS

---

You may need to clean the automatic dispenser periodically to remove laundry additive buildup.

1. Pull out the Liquid Detergent holder from the detergent compartment.
2. Remove the siphon cap from the fabric softener and bleach compartments.
3. Wash all of the parts under running water.
4. Clean the dispenser recess with a soft brush.
5. Reinsert the siphon cap and push it firmly into place.
6. Push the Liquid Detergent holder back into place.
7. Run a Rinse+Spin cycle without any load in your washer.

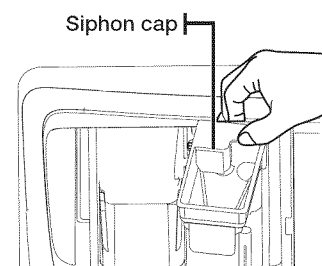
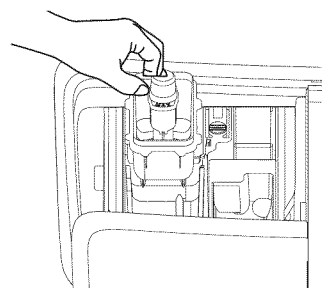

## STORING YOUR WASHER

---

Washers can be damaged if water is not removed from hoses and internal components before storage.

Prepare your washer for storage as follows:

- Select the Quick Wash cycle and add bleach to the automatic dispenser. Run your washer through the cycle without a load.
- Turn the water faucets off and disconnect the inlet hoses.
- Unplug your washer from the electrical outlet and leave your washer door open to let air circulate inside the tumbler.
- If you store your washer in below-freezing temperatures, make sure you allow time for any leftover water in your washer to thaw before use.

## CLEANING THE DEBRIS FILTER

We recommend cleaning the debris filter when water does not drain well or the “nd” error message is displayed.

1. Putting and pressing hard a flat-head screwdriver into the furrow between COVER-FILTER and FRAME-FRONT and then pull it towards to open the COVER-FILTER.

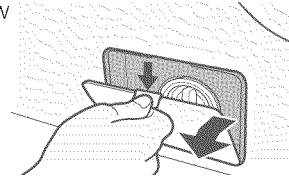

2. Holding the drain cap, pull the drain tube that is hooked on the guide hook to the front. Do not pull the drain tube with excessive force.
3. Place a bowl under the washing machine to catch any remaining water. Then, hold the drain tube with one hand, and turn the drain cap counter clockwise with the other hand to separate it from the drain tube.
4. Drain the remaining water completely.

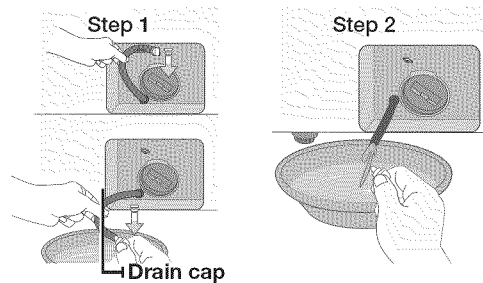

5. Turn the debris cap counterclockwise, and then pull the debris cap and debris filter assembly out of the washer.

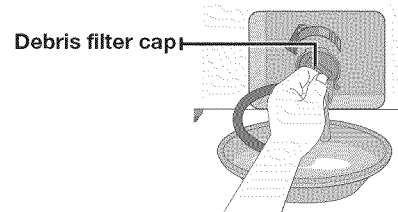

6. Wash any dirt or other material from the debris filter. Make sure the drain pump propeller behind the debris filter is not blocked.

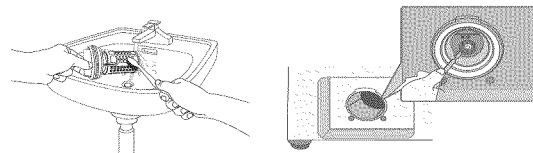

Debris filter cap → Debris filter

7. When you have finished cleaning the filter, insert the debris cap and filter assembly back into the washer. Turn the debris filter cap clockwise until the indicator on the debris filter cap is in the 12 o'clock position, pointing to the indicator on the washer.
8. Re-attach the emergency drain cap to the drain tube, and then hook the tube to the hook guide.
9. Re-install the filter cover.

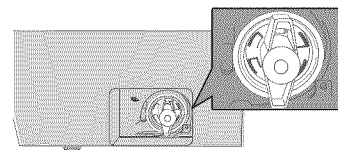

### For models with the safety filter cap

- To open, push in, and then turn the safety filter cap counterclockwise. The spring in the cap will make opening the cap easy.
- To close, turn the safety filter cap clockwise. As you turn the cap, the spring will make a rattling sound. The rattling sound is normal.

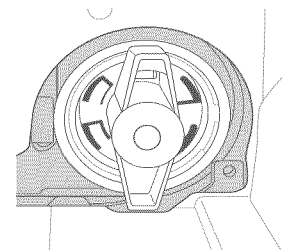

# maintaining your washer

## CLEANING THE DOOR SEAL/GASKET

1. Open the washer door and remove any clothing or items from the washer.
2. Check if there are any foreign substances on the grey seal/gasket ① between the lid and the drum.  
To check this, turn the seal/gasket ② out.

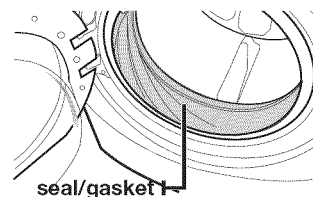

3. If there are any foreign substances, remove them.
4. If you find stained areas, wipe them down using the procedure below:
  - a) Carefully combine  $\frac{3}{4}$  cup (177 mL) of liquid chlorine bleach with 1 gal. (3.8 L) of warm tap water.
  - b) Wipe the seal/bellow area with the dilute solution using a damp cloth.
  - c) Let stand 5 minutes.
  - d) Wipe down the area thoroughly with a dry cloth and let the washer interior air dry with the door open.



### IMPORTANT:

- Wear rubber gloves when cleaning for prolonged periods.
- Refer to the bleach manufacturer's instructions for proper use.

## PRESERVING THE TOP COVER AND THE FRONT FRAME

Do not place any heavy or sharp objects or a detergent box on the washing machine. They can scratch or damage its top cover. Keep them in the pedestal (if purchased) or in a separate storage box.



Since the entire washing machine has a high-gloss finish, the surface can be scratched or damaged. Avoid scratching or damaging the surface when using the washing machine.

## SELF CLEAN+

Self Clean+ is a self-cleaning cycle that removes mold that may occur inside the washing machine.

1. Press the **Power** button.
2. Press the **Self Clean+** button.
  - Once the Self Clean+ button is pressed, the only function that can be set is Delay End.
3. Press the **Start/Pause** button.
  - When you press the Start/Pause button, Self Clean+ begins.

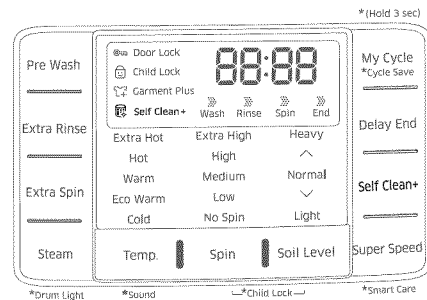

CAUTION

- Using Self Clean+, you can clean the drum without using a cleansing agent.
- Never use Self Clean+ when laundry is in the washing machine. It may cause damage to the laundry or a problem with the washing machine.
- **If you want to use a drum cleansing agent, use only 1/10 of the amount of the drum cleansing agent recommended by the cleansing agent manufacturer.** (When using a powder-type cleansing agent, remove the liquid detergent compartment.)



### The Self Clean+ Auto Indicator Function

- If the **"Self Clean+"** button is lit after a wash, it indicates that tub (drum) cleaning is required. In this case, remove the laundry from the washing machine, turn the power on, and clean the drum by running Self Clean+.
- If you do not run Self Clean+ after every 40 washes, the **"Self Clean+"** indicator turns off after one hour. However, the **"Self Clean+"** indicator will light again after five washes. Not running Self Clean+ at this point will not cause a problem with the washing machine.
- Although the Self Clean+ Auto Indicator appears once a month or so, the frequency may differ depending on the number of times the washing machine is used.

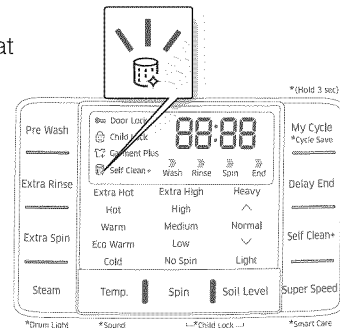

# troubleshooting

---

## CHECK THESE SOLUTIONS IF YOUR WASHER...

---

PROBLEM	SOLUTION
<b>Will not start.</b>	<ul style="list-style-type: none"><li>• Make sure the door is firmly closed.</li><li>• Make sure your washer is plugged in.</li><li>• Make sure the water source faucets are open.</li><li>• Make sure to press the Start/Pause Button to start your washer.</li><li>• Make sure the Child Lock is not activated. See page 24.</li><li>• Before your washer starts to fill, it will make a series of clicking noises to check the door lock and do a quick drain.</li><li>• Check the fuse or reset the circuit breaker</li></ul>
<b>Has no water or not enough water.</b>	<ul style="list-style-type: none"><li>• Turn both faucets on fully.</li><li>• Make sure the door is tightly closed.</li><li>• Straighten the water inlet hoses.</li><li>• Disconnect hoses and clean the screens. Hose filter screens may be clogged.</li><li>• Open and close the door, then press the Start/Pause Button.</li></ul>
<b>Has detergent remains in the automatic dispenser after the wash cycle is complete.</b>	<ul style="list-style-type: none"><li>• Make sure your washer is running with sufficient water pressure.</li><li>• Make sure the Detergent Selector dial is in the upper position when using granular detergent.</li></ul>
<b>Vibrates or is too noisy.</b>	<ul style="list-style-type: none"><li>• Make sure your washer is set on a level surface. If the surface is not level, adjust your washer feet to level the appliance.</li><li>• Make sure that the shipping bolts are removed.</li><li>• Make sure your washer is not touching any other object.</li><li>• Make sure the laundry load is balanced.</li></ul>
<b>Stops</b>	<ul style="list-style-type: none"><li>• Plug the power cord into a live electrical outlet.</li><li>• Check the fuse or reset the circuit breaker.</li><li>• Close the door and press the Start/Pause Button to start your washer. For your safety, your washer will not tumble or spin unless the door is closed.</li><li>• Before your washer starts to fill, it will make a series of clicking noises to check the door lock and do a quick drain.</li><li>• There may be a pause or soak period in the cycle. Wait and it may start.</li><li>• Check the screens on the inlet hoses at the faucets for obstructions. Clean the screens periodically.</li></ul>





PROBLEM	SOLUTION
<b>Fills with the wrong temperature water.</b>	<ul style="list-style-type: none"> <li>• Turn both faucets on fully.</li> <li>• Make sure the temperature selection is correct.</li> <li>• Make sure the hoses are connected to the correct faucets. Flush water lines.</li> <li>• Check the water heater. It should be set to deliver a minimum 120 °F (49 °C) hot water at the tap. Also check the water heater capacity and recovery rate.</li> <li>• Disconnect the hoses and clean the screens. The hose filter screens may be plugged.</li> <li>• As your washer is filling, the water temperature may change as the automatic temperature control feature checks incoming water temperature. This is normal.</li> <li>• While your washer is filling, you may notice just hot and/or just cold water going through the dispenser when you have selected cold or warm wash temperatures. This is a normal function of the automatic temperature control feature as your washer determines the temperature of the water.</li> </ul>
<b>Door locked or will not open.</b>	<ul style="list-style-type: none"> <li>• Press the Start/Pause Button to stop your washer.</li> <li>• Your washer door will remain locked during the heating portion of the Sanitize Cycle.</li> <li>• It may take a few moments for the door lock mechanism to disengage.</li> </ul>
<b>Does not drain and/or spin.</b>	<ul style="list-style-type: none"> <li>• Check the fuse or reset the circuit breaker.</li> <li>• Straighten the drain hose. Eliminate kinks in the hose. If there is a drain restriction, call for service.</li> <li>• Close the door and press the Start/Pause Button. For your safety, your washer will not tumble or spin unless the door is closed.</li> <li>• Make sure the debris filter is not clogged.</li> </ul>
<b>Load is too wet at the end of the cycle.</b>	<ul style="list-style-type: none"> <li>• Use the High or Extra High spin speed.</li> <li>• Use high efficiency detergent to reduce over-sudsing.</li> <li>• The load is too small. Very small loads (one or two items) may become unbalanced and not spin out completely.</li> </ul>
<b>Leaks water.</b>	<ul style="list-style-type: none"> <li>• Make sure the door is firmly closed.</li> <li>• Make sure all hose connections are tight.</li> <li>• Make sure the end of the drain hose is correctly inserted and secured to the drainage system.</li> <li>• Avoid overloading.</li> <li>• Use high efficiency detergent to prevent over-sudsing.</li> </ul>
<b>Has excessive suds.</b>	<ul style="list-style-type: none"> <li>• Use high efficiency detergent to prevent over-sudsing.</li> <li>• Reduce the detergent amount for soft water, small or lightly soiled loads.</li> <li>• Non-HE detergent is NOT recommended.</li> </ul>
<b>Has an odor.</b>	<ul style="list-style-type: none"> <li>• Excessive suds collect in nooks and crannies and can cause foul odors.</li> <li>• Run cleansing cycles to sanitize the machine periodically. (Sanitize Cycle or Self Clean+)</li> <li>• Clean the door seal (Diaphragm).</li> <li>• Dry the interior of your washer after the total cycle has finished.</li> </ul>

# troubleshooting

## INFORMATION CODES

The washer may display information codes to help you better understand what is occurring with your washer.

ERROR CODE	MEANING & SOLUTION
<b>UE</b>	Unbalanced load prevented your washer from spinning. Redistribute the load, press the Start/Pause button.
<b>dE</b>	The door is open when the washer is running. Close the door tightly and restart the cycle. If the code reappears, call customer service.
<b>dE1</b>	Your washer failed to lock or unlock the door.
<b>HE</b>	A water temperature control problem. (Heater control problem) Call customer service.
<b>LE</b>	Your washer has tried to fill, but has not reached the proper water level. Call customer service.  When washer displays “LE”, washer do draining for 3 minutes, At this time, Power button is invalid.
<b>5E</b>	Your washer is not draining. This can also mean that the unit senses a small clog while draining. <b>1.</b> Turn off the unit for 10 seconds and then turn it on again. <b>2.</b> Select the Spin Only cycle. <b>3.</b> Press the Start/Pause to drain the water. If it still does not drain, call for service.
<b>4E</b>	Your washer has tried to fill but was unsuccessful. Make sure the water faucets are open all the way. Check for bent hoses. Check the inlet screens on the hoses. If you are using a Flood Safety Device, please remove the device and connect the water hoses directly to the unit. Check if the hot water supply hose is connected. You must connect the hot water supply hose because hot water is supplied by the Auto Temperature Control (A.T.C.) function if the temperature of the cold water is lower than 59°F.  When washer displays “4E”, washer do draining for 3 minutes. At this time, the <b>Power</b> button is invalid.
<b>4E2</b>	The hot/cold water hose connection is not correct. Please connect the hot/cold water hose connection correctly.
<b>OE</b>	A fault is detected in the water level sensor. Call customer service.
<b>1E</b>	The Water Level sensor is not working properly. Call customer service.  When washer displays “1E”, the washer will drain for 3 minutes,At this time, the Power button is invalid
<b>BE2</b>	A jammed key. Call customer service.



































ERROR IMAGE	MEANING & SOLUTION
<b>tE1</b>	A temperature sensor problem. Restart the cycle. If the code reappears, call customer service.
<b>3E</b>	A motor problem. Restart the cycle. If the code reappears, call customer service.
<b>9E1/9E2</b>	High/Low voltage detected. Restart the cycle. If the code reappears, call customer service.
<b>AE</b>	A Communication error between the SUB(Sensor) PBA and the MAIN PBA Call customer service.
<b>8E</b>	A MEMS sensor problem. Call customer service.
<b>SF1</b> <b>SF2</b> <b>SF3</b>	A system error. Call customer service.
<b>SUd</b>	Too many suds are detected during the wash session. The unit is put on hold until the amount of suds have been reduced. The unit will then go back to operating.

For any codes not listed above, call 1-800-726-7864 (1-800-SAMSUNG)

# appendix

## FABRIC CARE CHART

The following symbols provide garment care direction. The Clothing care labels include symbols for washing, bleaching, drying and ironing, or dry cleaning when necessary. The use of symbols ensures consistency among garment manufacturers of domestic and imported items. Follow care label directions to maximize garment life and reduce laundering problems.

Wash Cycle		Special Instructions		Warning Symbols for Laundering	
	Normal		Line Dry/ Hang to Dry		Do Not Wash
	Permanent Press / Wrinkle Resistant / Wrinkle Control		Drip Dry		Do Not Wring
	Gentle/Delicates		Dry Flat		Do Not Bleach
	Hand Wash	<b>Heat Setting</b>			Do Not Tumble Dry
<b>Water Temperature**</b>			High		No Steam (added to iron)
	Hot		Medium		Do Not Iron
	Warm		Low	<b>Dryclean</b>	
	Cold		Any Heat		Dry Clean
<b>Bleach</b>			No Heat/Air		Do Not Dry Clean
	Any Bleach (when needed)	<b>Iron-Dry or Steam Temperatures</b>			Line Dry/ Hang to Dry
	Only Non-Chlorine (color-safe) Bleach (when needed)		High		Drip Dry
	Tumble Dry Cycle		Medium		Dry Flat
<b>Normal</b>			Low		
	Permanent Press/ Wrinkle Resistant/ Wrinkle Control				
	Gentle/ Delicates				

\*\* The dot symbols represent appropriate wash water temperatures for various items. The temperature range for Hot is 105° - 125 °F / 41° - 52 °C, for Warm 85° - 105 °F / 29° - 41 °C and for Cold 60° - 85 °F / 16° - 29 °C. (Wash water temperature must be a minimum of 60 °F / 16 °C for detergent activation and effective cleaning.) The clothes washer can not ensure these temperatures because the actual temperature of the water entering your washer is dependent on water heater settings and regional water supply temperatures. For example, cold water entering the home in the northern states during winter may be 40 °F / 4 °C which is too cold for effective cleaning. The water temperature in this situation will need to be adjusted by selecting a warm setting, adding some hot water to the MAX FILL line or using your washer's heating option, if available.

# CYCLE CHART

Use this chart to set the best cycle and option for you laundry.

Model: WF56H9100A\*

( ● : factory setting , \* : selectable )

Cycle	Functions														
	Temp.					Spin					Soil Level				
	EH	H	W	EW	C	EH	H	M	L	NS	H	^	N	∨	L
NORMAL		●	●	●	●	●	●	●	●	●	●	●	●	●	●
DEEP STEAM		●				●	●	●	●	●	●				
HEAVY DUTY		●	●	●	●	●	●	●	●	●	●	●	●	●	●
BEDDING			●	●	●			●	●	●	●	●	●	●	●
WHITES		●	●	●	●	●	●	●	●	●	●	●	●	●	●
SANITIZE	●					●	●	●	●	●	●	●	●	●	●
ALLERGEN	●					●	●	●	●	●	●	●	●	●	●
RINSE + SPIN						●	●	●	●	●					
QUICK WASH		●	●	●	●	●	●	●	●	●	●	●	●	●	●
TOWELS		●	●	●	●	●	●	●	●	●	●	●	●	●	●
WOOL			●	●	●				●	●			●		
DELICATES			●	●	●				●	●	●	●	●	●	●
ACTIVE WEAR			●	●	●			●	●	●	●	●	●	●	●
PERM PRESS			●	●	●		●	●	●	●	●	●	●	●	●
ECO COLD					●	●	●	●	●	●			●	●	●
SELF CLEAN+	●								●						

Cycle	Options						
	Pre Wash	Extra Rinse	Extra Spin	Steam	Super Speed	Delay End	My Cycle
NORMAL	●	●	●	●	●	●	●
DEEP STEAM	●	●	●	●	●	●	●
HEAVY DUTY	●	●	●	●	●	●	●
BEDDING	●	●	●	●	●	●	●
WHITES	●	●	●	●	●	●	●
SANITIZE	●	●	●	●	●	●	●
ALLERGEN	●	●	●	●	●	●	●
RINSE + SPIN		●	●	●	●	●	●
QUICK WASH		●	●	●	●	●	●
TOWELS	●	●	●	●	●	●	●
WOOL						●	●
DELICATES		●	●	●	●	●	●
ACTIVE WEAR	●	●	●	●	●	●	●
PERM PRESS	●	●	●	●	●	●	●
ECO COLD	●	●	●	●	●	●	●
SELF CLEAN+						●	

Temp.	Spin	Soil Level
<b>EH:</b> Extra Hot	<b>EH:</b> Extra High	<b>H:</b> Heavy
<b>H:</b> Hot	<b>H:</b> High	<b>^</b>
<b>W:</b> Warm	<b>M:</b> Medium	<b>N:</b> Normal
<b>EW:</b> Eco Warm	<b>L:</b> Low	<b>∨</b>
<b>C:</b> Cold	<b>NS:</b> No Spin	<b>L:</b> Light

06 appendix

# appendix

## HELPING THE ENVIRONMENT

- Your washer is manufactured from recyclable materials. If you decide to dispose of it, please observe local waste disposal regulations. Cut off the power cord so that the appliance cannot be connected to a power source. Remove the door so that animals and small children cannot get trapped inside the appliance.
- Do not exceed the detergent quantities recommended in the detergent manufacturers' instructions.
- Use stain removal products and bleaches before the wash cycle only when necessary.
- Save water and electricity by only washing full loads (the exact amount depends upon the program used).

## DECLARATION OF CONFORMITY

This appliance complies with UL2157.

## SPECIFICATION

TYPE	FRONT LOADING WASHER	
DIMENSIONS	Div	Inches (mm)
	A. Height-Overall	42.6" (1083)
	B. Width	30" (762)
	C. Depth with door open 90°	58.3" (1480)
	D. Depth	32.5" (826)

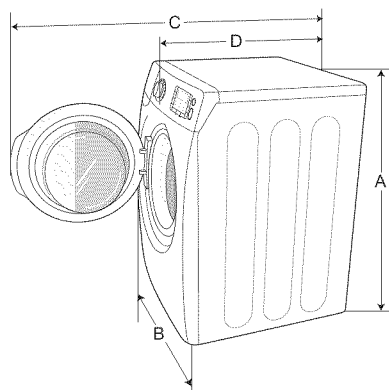

WATER PRESSURE		20-116 psi(137-800 kPa)	
WEIGHT		121 kg (267 lb)	
HEATER RATING		900 W	
POWER CONSUMPTION	WASHING	120 V	200 W
	WASHING AND HEATING	120 V	1150 W
	SPIN	120 V	550 W
	DRAIN	120 V	80 W
SPIN REVOLUTION		1300 rpm	

# warranty (U.S.A)

---

## **SAMSUNG WASHER**

### **LIMITED WARRANTY TO ORIGINAL PURCHASER**

This SAMSUNG brand product, as supplied and distributed by SAMSUNG ELECTRONICS AMERICA, INC. (SAMSUNG) and delivered new, in the original carton to the original consumer purchaser, is warranted by SAMSUNG against manufacturing defects in materials and workmanship for a limited warranty period of: One (1) year part and labor, Two (2) years Control Board Parts (Part Only), Three (3) years stainless tub part (Part Only), Five (5) years washing motor part (Part Only), Ten (10) years washing DD motor part (Part Only)

This limited warranty begins on the original date of purchase, and is valid only on products purchased and used in the United States. To receive warranty service, the purchaser must contact SAMSUNG for problem determination and service procedures. Warranty service can only be performed by a SAMSUNG authorized service center. The original dated bill of sale must be presented upon request as proof of purchase to SAMSUNG or SAMSUNG's authorized service center. SAMSUNG will provide in-home service during the warranty period at no charge, subject to availability within the contiguous United States. In-home service is not available in all areas.

To receive in-home service, product must be unobstructed and accessible to the service agent. If service is not available, SAMSUNG may elect to provide transportation of the product to and from an authorized service center.

SAMSUNG will repair, replace, or refund this product at our option and at no charge as stipulated herein, with new or reconditioned parts or products if found to be defective during the limited warranty period specified above. All replaced parts and products become the property of SAMSUNG and must be returned to SAMSUNG. Replacement parts and products assume the remaining original warranty, or ninety (90) days, whichever is longer. This limited warranty covers manufacturing defects in materials and workmanship encountered in normal, noncommercial use of this product and shall not apply to the following: damage that occurs in shipment; delivery and installation; applications and uses for which this product was not intended; altered product or serial numbers; cosmetic damage or exterior finish; accidents, abuse, neglect, fire, water, lightning, or other acts of nature or God; use of products, equipment, systems, utilities, services, parts, supplies, accessories, applications, installations, repairs, external wiring or connectors not supplied or authorized by SAMSUNG that damage this product or result in service problems; incorrect electrical line voltage, fluctuations and surges; customer adjustments and failure to follow operating instructions, maintenance and environmental instructions that are covered and prescribed in the instruction book; product removal and reinstallation; problems caused by pest infestations. This limited warranty does not cover problems resulting from incorrect electric current, voltage or supply, light bulbs, house fuses, house wiring, cost of a service call for instructions, or fixing installation errors. SAMSUNG does not warrant uninterrupted or error-free operation of the product.

EXCEPT AS SET FORTH HEREIN, THERE ARE NO WARRANTIES ON THIS PRODUCT EITHER EXPRESS OR IMPLIED, AND SAMSUNG DISCLAIMS ALL WARRANTIES INCLUDING, BUT NOT LIMITED TO, ANY IMPLIED WARRANTIES OF MERCHANTABILITY, INFRINGEMENT OR FITNESS FOR A PARTICULAR PURPOSE.

NO WARRANTY OR GUARANTEE GIVEN BY ANY PERSON, FIRM, OR CORPORATION WITH RESPECT TO THIS PRODUCT SHALL BE BINDING ON SAMSUNG. SAMSUNG SHALL NOT BE LIABLE FOR LOSS OF REVENUE OR PROFITS, FAILURE TO REALIZE SAVINGS OR OTHER BENEFITS, OR ANY OTHER SPECIAL, INCIDENTAL OR CONSEQUENTIAL DAMAGES CAUSED BY THE USE, MISUSE, OR INABILITY TO USE THIS PRODUCT, REGARDLESS OF THE LEGAL THEORY ON WHICH THE CLAIM IS BASED, AND EVEN IF SAMSUNG HAS BEEN ADVISED OF THE POSSIBILITY OF SUCH DAMAGES.

NOR SHALL RECOVERY OF ANY KIND AGAINST SAMSUNG BE GREATER IN AMOUNT THAN THE PURCHASE PRICE OF THE PRODUCT SOLD BY SAMSUNG AND CAUSING THE ALLEGED DAMAGE. WITHOUT LIMITING THE FOREGOING, PURCHASER ASSUMES ALL RISK AND LIABILITY FOR LOSS, DAMAGE, OR INJURY TO PURCHASER AND PURCHASER'S PROPERTY AND TO OTHERS AND THEIR PROPERTY ARISING OUT OF THE USE, MISUSE, OR INABILITY TO USE THIS PRODUCT. THIS LIMITED WARRANTY SHALL NOT EXTEND TO ANYONE OTHER THAN THE ORIGINAL PURCHASER OF THIS PRODUCT, IS NONTRANSFERABLE AND STATES YOUR EXCLUSIVE REMEDY.

Some states do not allow limitations on how long an implied warranty lasts, or the exclusion or limitation of incidental or consequential damages, so the above limitations or exclusions may not apply to you. This warranty gives you specific rights, and you may also have other rights, which vary from state to state.

**To obtain warranty service, please contact SAMSUNG at:  
Samsung Electronics America, Inc.  
85 Challenger Road Ridgefield Park, NJ 07660  
1-800-SAMSUNG (726-7864)  
[www.samsung.com/us](http://www.samsung.com/us)**

Visits by a Service Engineer to explain functions, maintenance or installation is not covered by warranty. Please contact your Samsung call agent for help with any of these issues.



# warranty(CANADA)

---

## **SAMSUNG WASHER**

### **LIMITED WARRANTY TO ORIGINAL PURCHASER**

This SAMSUNG brand product, as supplied and distributed by SAMSUNG ELECTRONICS CANADA, INC. (SAMSUNG) and delivered new, in the original carton to the original consumer purchaser, is warranted by SAMSUNG against manufacturing defects in materials and workmanship for a limited warranty period of: One (1) year part and labor, Ten (10) years washing DD motor (Part only)

This limited warranty begins on the original date of purchase, and is valid only on products purchased and used in the Canada. To receive warranty service, the purchaser must contact SAMSUNG for problem determination and service procedures. Warranty service can only be performed by a SAMSUNG authorized service center. The original dated bill of sale must be presented upon request as proof of purchase to SAMSUNG or SAMSUNG's authorized service center. SAMSUNG will provide in-home service during the warranty period at no charge, subject to availability within the Canada. In-home service is not available in all areas.

To receive in-home service, product must be unobstructed and accessible to the service agent. If service is not available, SAMSUNG may elect to provide transportation of the product to and from an authorized service center.

SAMSUNG will repair, replace, or refund this product at our option and at no charge as stipulated herein, with new or reconditioned parts or products if found to be defective during the limited warranty period specified above. All replaced parts and products become the property of SAMSUNG and must be returned to SAMSUNG. Replacement parts and products assume the remaining original warranty, or ninety (90) days, whichever is longer. This limited warranty covers manufacturing defects in materials and workmanship encountered in normal, noncommercial use of this product and shall not apply to the following: damage that occurs in shipment; delivery and installation; applications and uses for which this product was not intended; altered product or serial numbers; cosmetic damage or exterior finish; accidents, abuse, neglect, fire, water, lightning, or other acts of nature or God; use of products, equipment, systems, utilities, services, parts, supplies, accessories, applications, installations, repairs, external wiring or connectors not supplied or authorized by SAMSUNG that damage this product or result in service problems; incorrect electrical line voltage, fluctuations and surges; customer adjustments and failure to follow operating instructions, maintenance and environmental instructions that are covered and prescribed in the instruction book; product removal and reinstallation; problems caused by pest infestations. This limited warranty does not cover problems resulting from incorrect electric current, voltage or supply, light bulbs, house fuses, house wiring, cost of a service call for instructions, or fixing installation errors. SAMSUNG does not warrant uninterrupted or error-free operation of the product.

EXCEPT AS SET FORTH HEREIN, THERE ARE NO WARRANTIES ON THIS PRODUCT EITHER EXPRESS OR IMPLIED, AND SAMSUNG DISCLAIMS ALL WARRANTIES INCLUDING, BUT NOT LIMITED TO, ANY IMPLIED WARRANTIES OF MERCHANTABILITY, INFRINGEMENT OR FITNESS FOR A PARTICULAR PURPOSE.

NO WARRANTY OR GUARANTEE GIVEN BY ANY PERSON, FIRM, OR CORPORATION WITH RESPECT TO THIS PRODUCT SHALL BE BINDING ON SAMSUNG. SAMSUNG SHALL NOT BE LIABLE FOR LOSS OF REVENUE OR PROFITS, FAILURE TO REALIZE SAVINGS OR OTHER BENEFITS, OR ANY OTHER SPECIAL, INCIDENTAL OR CONSEQUENTIAL DAMAGES CAUSED BY THE USE, MISUSE, OR INABILITY TO USE THIS PRODUCT, REGARDLESS OF THE LEGAL THEORY ON WHICH THE CLAIM IS BASED, AND EVEN IF SAMSUNG HAS BEEN ADVISED OF THE POSSIBILITY OF SUCH DAMAGES.

NOR SHALL RECOVERY OF ANY KIND AGAINST SAMSUNG BE GREATER IN AMOUNT THAN THE PURCHASE PRICE OF THE PRODUCT SOLD BY SAMSUNG AND CAUSING THE ALLEGED DAMAGE. WITHOUT LIMITING THE FOREGOING, PURCHASER ASSUMES ALL RISK AND LIABILITY FOR LOSS, DAMAGE, OR INJURY TO PURCHASER AND PURCHASER'S PROPERTY AND TO OTHERS AND THEIR PROPERTY ARISING OUT OF THE USE, MISUSE, OR INABILITY TO USE THIS PRODUCT. THIS LIMITED WARRANTY SHALL NOT EXTEND TO ANYONE OTHER THAN THE ORIGINAL PURCHASER OF THIS PRODUCT, IS NONTRANSFERABLE AND STATES YOUR EXCLUSIVE REMEDY.

Some provinces do not allow limitations on how long an implied warranty lasts, or the exclusion or limitation of incidental or consequential damages, so the above limitations or exclusions may not apply to you. This warranty gives you specific rights, and you may also have other rights, which vary from province to province.

**To obtain warranty service, please contact SAMSUNG at:  
Samsung Electronics Canada Inc.,  
Customer Service 55 Standish Court Mississauga, Ontario L5R 4B2 Canada  
1-800-SAMSUNG (726-7864)  
[www.samsung.com/ca](http://www.samsung.com/ca) (English)  
[www.samsung.com/ca\\_fr](http://www.samsung.com/ca_fr) (French)  
FAX:1-866-436-4617**

Visits by a Service Engineer to explain functions, maintenance or installation is not covered by warranty. Please contact your Samsung call agent for help with any of these issues.

memo

---

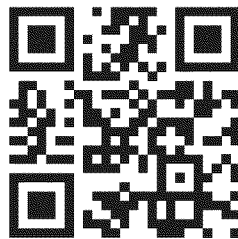

Scan this with your smartphone

Scan the QR code\* or visit [www.samsung.com/spsn](http://www.samsung.com/spsn) to view our helpful How-to Videos and Live Shows

\*Requires reader to be installed on your smartphone

### QUESTIONS OR COMMENTS?

Country	CALL	OR VISIT US ONLINE AT
U.S.A	1-800-SAMSUNG (726-7864)	<a href="http://www.samsung.com/us">www.samsung.com/us</a>
MEXICO	01-800-SAMSUNG (726-7864)	<a href="http://www.samsung.com">www.samsung.com</a>
CANADA	1-800-SAMSUNG (726-7864)	<a href="http://www.samsung.com/ca">www.samsung.com/ca</a> (English) <a href="http://www.samsung.com/ca_fr">www.samsung.com/ca_fr</a> (French)

Visits by a Service Engineer to explain functions, maintenance or installation is not covered by warranty. Please contact your Samsung call agent for help with any of these issues.

Code No. DC68-03404A\_EN