

CROSLEY

WASHING MACHINE OWNER'S MANUAL

CFW-8000GW / GR / GS / GBL

Features

■ Economic wash system

With artificial intelligence, the washer uses minimum energy and water by selecting optimal water level and washing time.

■ Low noise system

The washer minimizes the washing and spinning noises by sensing the amount of laundry.

■ Child-Lock

The Child-Lock system is adopted to prevent children from pressing any button to change the program during operation.

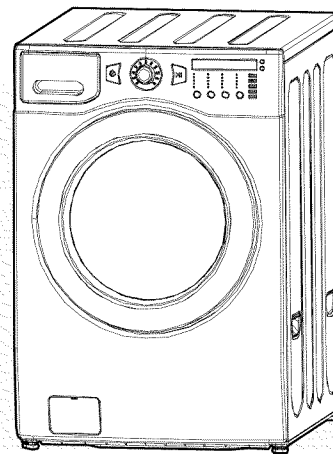

CONTENTS

Page

| | |
|--------------------------------------|----|
| IMPORTANT SAFETY GUIDE..... | 2 |
| PARTS AND FEATURES..... | 3 |
| INSTALLATION INSTRUCTIONS..... | 4 |
| INSTALLATION OF ACCESSORIES..... | 7 |
| OPERATING YOUR WASHER..... | 8 |
| USING THE DISPENSER..... | 10 |
| THE FUNCTION OF CONTROL PANEL..... | 12 |
| WASHING PROGRAM..... | 14 |
| WASHING PROCEDURE AND SELECTION..... | 16 |
| GUIDE FOR OTHER USEFUL PROGRAMS..... | 27 |
| MAINTENANCE..... | 30 |
| HOW TO CLEAN THE FILTER..... | 31 |
| REMOVING STAINS..... | 32 |
| TROUBLE SHOOTING..... | 33 |
| SPECIFICATION..... | 34 |

IMPORTANT SAFETY INSTRUCTIONS

READ ALL INSTRUCTIONS BEFORE USE

⚠️ WARNING!

For your safety, the information in this manual must be followed to minimize the risk of fire or explosion, electric shock, or to prevent property damage, personal injury, or loss of life

IMPORTANT SAFETY INSTRUCTIONS

⚠️ WARNING! - To reduce the risk of fire, electric shock, or injury to persons when using your appliance, follow basic precautions, including the following :

1. Read all instructions before using the appliance.
2. Do not wash or dry articles that have been previously cleaned in, washed in, soaked in, or spotted with gasoline, dry-cleaning solvents, other flammable or explosive substances as they give off vapors that could ignite or explode.
3. Do not allow children to play on or in the appliance. Close supervision of children is necessary when the appliance is used near children.
4. Before the appliance is removed from service or discarded, remove the door to the washing or drying compartment.
5. Do not reach into the appliance if the drum is moving.
6. Do not install or store this appliance where it will be exposed to the weather.
7. Do not tamper with controls
8. Do not repair or replace any part of the appliance or attempt any servicing unless specifically recommended in the user-maintenance instructions or in published user-repair instructions that you understand and have the skills to carry out.
9. Do not add gasoline, dry-cleaning solvents, or other flammable or explosive substances to the wash water. These substances give off vapors that could ignite or explode.
10. Under certain conditions, hydrogen gas may be produced in a hot water system that has not been used for 2 weeks or more. **HYDROGEN GAS IS EXPLOSIVE.** If the hot water system has not been used for such a period, before using a washing machine or combination washer-dryer, turn on all hot water faucets and let the water flow from each for several minutes. This will release any accumulated hydrogen gas. As the gas is flammable, do not smoke or use an open flame during this time.
11. Keep area around the exhaust opening and adjacent surrounding areas free from the accumulation of lint, dust, and dirt.
12. Do not place items exposed to cooking oils in your dryer. Items contaminated with cooking oils may contribute to a chemical reaction that could cause a load to catch fire
13. Do not use heat to dry articles containing foam rubber or similarly textured rubber-like materials.
14. Do not use fabric softeners or products to eliminate static unless recommended by the manufacturer of the fabric softener or product.

SAVE THESE INSTRUCTIONS

GROUNDING INSTRUCTIONS

This appliance must be grounded. In the event of malfunction or breakdown, grounding will reduce the risk of electric shock by providing a path of least resistance for electric current. This appliance is equipped with a cord having an equipment-grounding conductor and a grounding plug. The plug must be plugged into an appropriate outlet that is properly installed and grounded in accordance with all local codes and ordinances.

⚠️ WARNING! - Improper connection of the equipment-grounding conductor can result in a risk of electric shock. Check with a qualified electrician or serviceman if you are in doubt as to whether the appliance is properly grounded. Do not modify the plug provided with the appliance - if it will not fit the outlet, have a proper outlet installed by a qualified electrician

OPERATION INSTRUCTIONS

"WARNING - To reduce the risk of fire, electric shock, or injury to persons, read the IMPORTANT SAFETY INSTRUCTIONS before operating this appliance." This statement is omitted when the operating instructions are preceded by the safety instructions and are included in the same manual.

Understanding your responsibilities when using the washer.

1. Do not use chlorine bleach and ammonia or acid (such as vinegar or rust remover) in the same wash. Hazardous fumes can form.
2. Unplug power supply cord before attempting to service your washer.
3. Do not wash fiberglass material. Small particles can stick to fabrics washed in following loads and cause skin irritation.
4. Do not spray water on the control panel of the washer. It could cause fire or an electric shock.
5. In case of the dual valve model, if you connect only cold water inlet valve, while water temperature is selected as hot or warm, there can be water leakage from unconnected water inlet valve.

PARTS AND FEATURES



The parts and features of your washer are illustrated on the page.
 Become familiar with all parts and features before using your washer.

NOTE

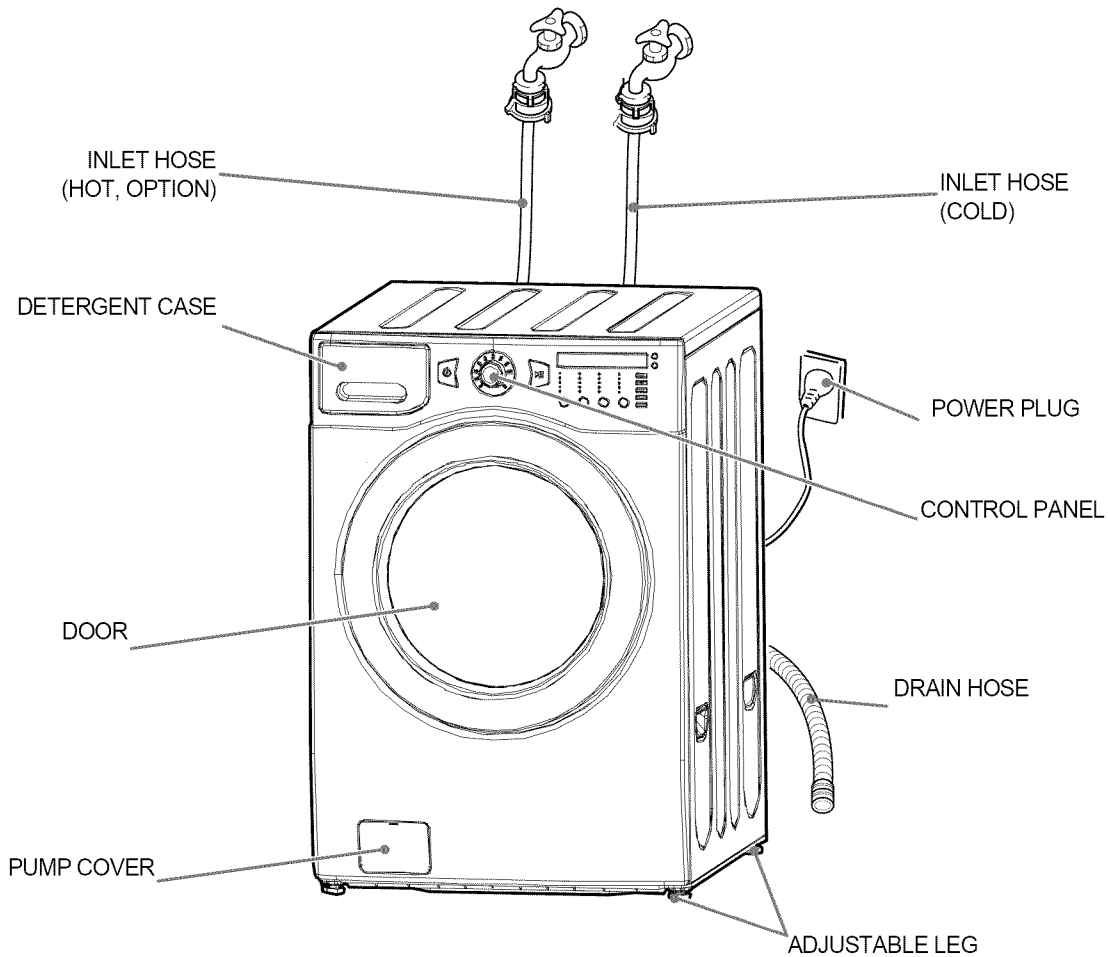
The drawings in the book may vary from your washer model.
 They are designed to show the different features of all models covered by this book,
 So your model may not include all the features.

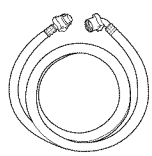
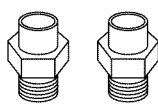
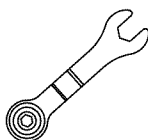
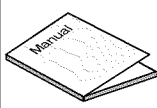

Accessories

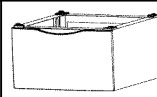
| Drain hose | Inlet hose | Connector | Wrench | Owner's Manual | Cap holder(4EA) | Pedestal Purchased Separately |
|---|---|---|---|--|---|---|
|  |  |  |  |  |  |  <p>* Design of pedestals is subject to change without manufacturers notice.</p> |

INSTALLATION INSTRUCTIONS

Removing transit bolts

1. Before operating the washer, remove the transit bolts(4ea) along with the rubber.

- If the bolts are not removed, it may cause heavy vibration, noise and malfunction.

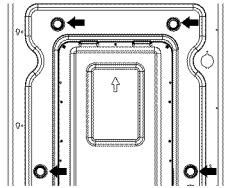

2. Unscrew the 4 bolts with the spanner supplied. Keep the 4 bolts and spanner for future use.

- Whenever the appliance is transported, the transit bolts must be refitted.

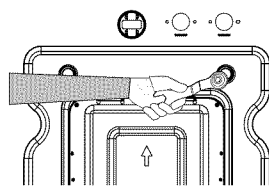

3. Close holes with supplied cap holders.

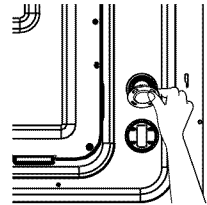

Location of your washer

- Check location where the washer will be installed. Make sure you have everything necessary for correct installation.
- Do not place or store your washer below 0°C (32°F) to avoid any damage from freezing.
- Do not place or store laundry products on top of washer at any times.
- Install the washer on the horizontal solid floor. If the washer is installed on an unsuitable floor, it could make considerable noise, vibrate severely and cause a malfunction. If the washer is not level, adjust leg up or down for horizontal installation.
- Ventilation openings must not be obstructed by carpeting when the washer is installed on a carpeted floor.
- Leave some space (right & left : 1 inch, rear : 4 inch).
- In case of built-in installation, the distance between top of the washer and bottom of upper plate should be at least 3mm.

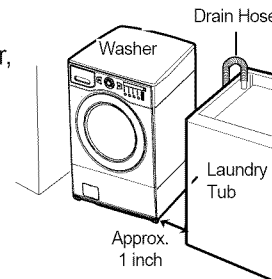

Level adjustment

- ① If the washer is installed on an unsuitable floor, it could make considerable noise, vibrate and cause a malfunction.
- ② Adjust the level of washer using adjustable legs.
 - Please check if there is any gap between the four adjustable legs and the floor.
 - Turning adjustable legs by the enclosed spanner, adjust the level of washer and make it sure that there is no swaying of washer.
 - After the adjustment is finished, turn the fixing nuts up tightly so that the washer maintains the adjustment.
- ③ Make it sure that the washer does not sway when you press down the four corners of the washer's top plate.

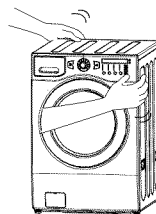
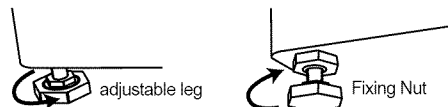
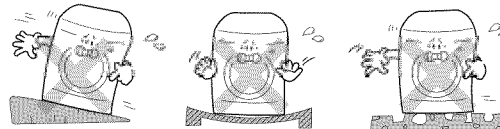

NOTE

There should be no swaying of washer and all the adjustable legs should stick to the floor closely.

Connecting water supply hose

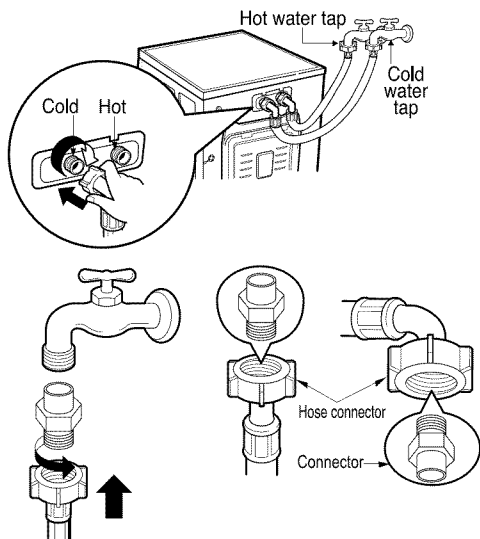

- Water supply pressure must be between 4.5 and 145 PSI (30~1000 kPa).
- Do not crossthread when connecting inlet hose to the valve. If the water supply pressure is more than 145 PSI, a pressure reducing device should be installed.
- Two Sealing washers are supplied with the water inlet hoses to prevent water leaks.
- Check for leakage of washing machine connections by turning the tap completely on.
- Periodically check the condition of the hose and replace the hose if necessary.
- Make sure that there is no kink in the hose and that it is not crushed.
- Be sure that the two water input ports are connected to the correct water faucets. The connector for hot water is colored red.

NOTE: Washing Machine is to be connected to the water mains using new hoses.
Old hoses should not be used

Repairs to the washing machine must only be carried out by qualified personnel. Repairs carried out by inexperienced persons may cause injury or serious malfunctioning. Contact your local service center.

Do not install your washing machine in a room where temperatures below freezing may occur.

Frozen hoses may burst under pressure. The reliability of the electronic control unit may be impaired at temperatures below the freezing point

If the appliance is delivered in the winter months and temperatures are below freezing, store the washing machine at room temperature for a few hours before putting it into operation.

Drain system

- Never forget to install drain hose before operating your washer.
- Open the packing box, and there is a drain hose inside the drum.
- Connect the drain hose to the drain outlet at the back side of the washer.
- Top of laundry tub must be at least 24 inches high and no higher than 40 inches from bottom of washer.
- When installing the drain hose to tub(sink), secure it tightly with a string.
- Proper securing of the drain hose will protect the floor from damage due to water leakage.
- When the drain hose is too long, do not force it back into the washer. This will cause abnormal noise.

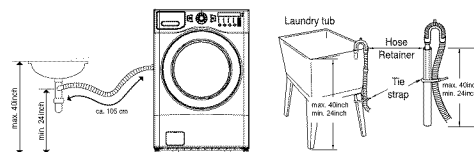

Electrical connection

- Do not use an extension cord or double adaper.
- If the supply cold is damaged, it must be replaced by a qualified person in order to avoid a hazard.
- If the machine will not be used for an extended time, unplug it and shut off the water supply.
 - Connect the machine to a grounded outlet in occordance with current wiring regulations.
- The appliance must be positioned so that the plug is easily accesible.

Positioning the washer

• Installation clearances

The location must be large enough to fully open the washer door.

• Washer dimensions

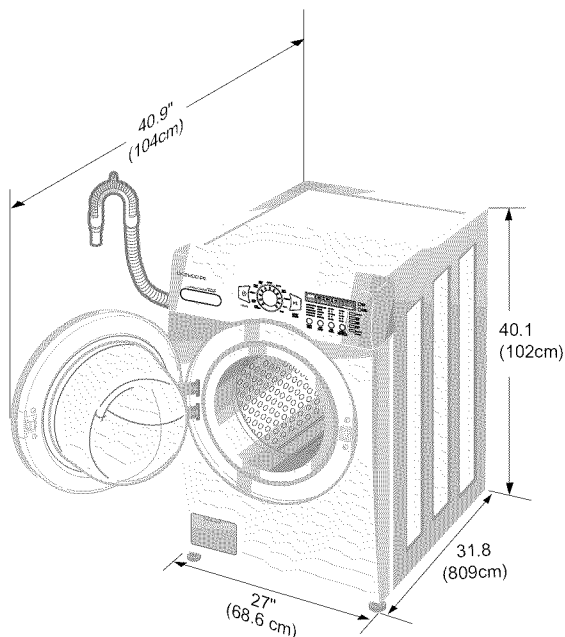

- Most installations require a minimum 4 in. (10 cm) clearance behind the washer.

■ Minimum installation spacing for recessed area installation.

The following dimensions shown are for the minimum spacing allowed. Additional spacing should be considered for installation and servicing.

- Additional clearances might be required for wall, door and floor moldings.
- Additional spacing of 1 in. (2.5 cm) on all sides of the washer is recommended to reduce noise transfer.

Companion appliance spacing should also be considered.

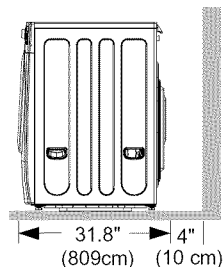

[Side view]

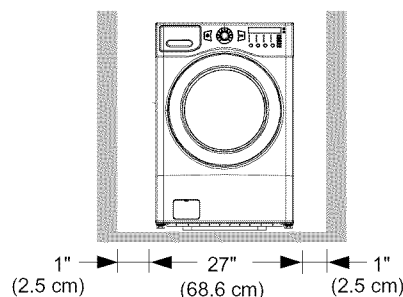

[Front view]

■ Level floor

- Allowable slope under entire washer is 1°.
- **To minimize noise and vibration, the washer MUST be installed on a solidly constructed floor.**
- Carpeting and soft tile surfaces are not recommended.
- Never install the washer on a platform or weakly supported structure

NOTE: A firm, solid floor is even more critical to a front-loading washer than to a top-loader. If your floor is wood and/or frame construction, you may need to reinforce it. Front-loaders use substantially faster spin speeds than top-loaders, causing greater vibration. If the floor is not solid, your washer will vibrate. You will hear and feel the vibration throughout your house.

■ Power outlet

- Must be within 60 in. (1.5 m) of either side of the washer. Do not overload the outlet with more than one appliance.
- Time-delay fuse or circuit breaker is recommended.

NOTE: It is the personal responsibility and obligation of the customer to have a proper outlet installed by a qualified electrician.

INSTALLATION OF ACCESSORIES

*Please be sure to read and follow the installation operation manual. (Pedestal Model : P-W151W)

CAUTION : When installing the said product, please be sure to let the expert with electricity & machine related training and sufficient experiences install it.

People's safety is the first priority.

There are many safety particulars in the guidebook and product. Therefore, please be sure to read and abide by all safety particulars.

! CAUTION

Excessive load is dangerous.

In case of installing and carrying the adjustable cases of the washer and dryer, more than two persons should do it together. Please let children not play on the cases.

Installation methods

1. Please take out the height-high shelf and its installation manual from the wrapped box.
2. Please untie 4 horizontal adjustment legs of the washer and dryer.
3. Please turn and insert 4 horizontal adjustment legs in the lower part of adjustable cases.

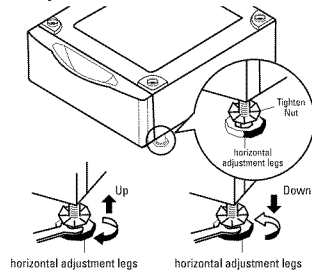

4. Please place the washer or dryer on the adjustable cases.
 N.B : The washer and dryer are heavy so that more than two persons have to raise them together.
 N.B : Please pull out the plugs of the washer and dryer in use, lock the faucet and divide the supply hose and drainage hose. Then, please pull out water from all hoses.

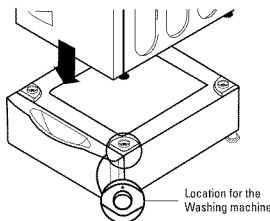

5. After pulling out and opening the drawers of adjustable cases forwards, pull out the accessory bags for bolts from the drawers and insert the spring washer (b) and plain washer (c) into the joint BOLT (a) in order.

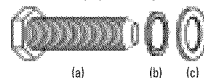

6. In order for the washer or dryer to operate properly the combination of adjustable cases on the bottom must be balanced. If the adjustable legs are not balanced due to a unstable platform, it is needed to balance them by adjusting the horizontal adjustment legs. And, to fix the position of these legs, tighten the bolts by using wrench provided as much as possible. This would result in a balanced operation.

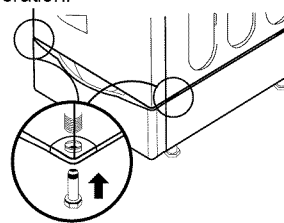

7. Take out the back cover and screw from the left part of the height-high shelf drawer.
 Assemble 10 screws at the holes back of the shelf.

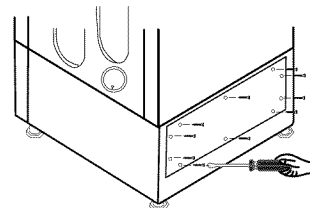

8. After transferring it into the desired installation spot, try to operate the washer or dryer and check whether there are any mechanical noises and vibration.

N.B : In order for the washer or dryer to be operate the combination of adjustable cases on the plain bottom. When they are not at a level with each adjustment legs of adjustable cases, leave the horizontal adjustment legs as it is, and fasten the lock nut towards the cases solidly.

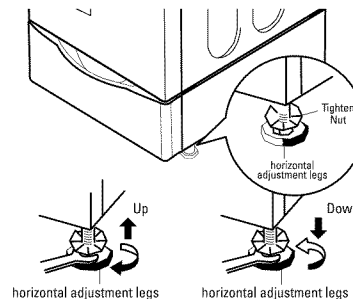

9. After transferring them in the desired installation location, get the washer or dryer operated and check whether there are any mechanical noises and vibration.

OPERATING YOUR WASHER

To obtain the best washing results, you must operate your washer properly. This section gives you this important information.

| Preparing clothes for washing | |
|--|--|
| <ul style="list-style-type: none"> • Close zippers, snaps, and hooks to avoid snagging other items. Remove pin, buckles, and other hard objects to avoid scratching the washer interior. • Empty pockets and pull them inside out. | <ul style="list-style-type: none"> • Turn down cuffs and turn synthetic knits inside out to avoid pilling. • Tie strings and sashes to avoid tangling. • Treat spots and stains. (See "Removing stains" on page 21) |

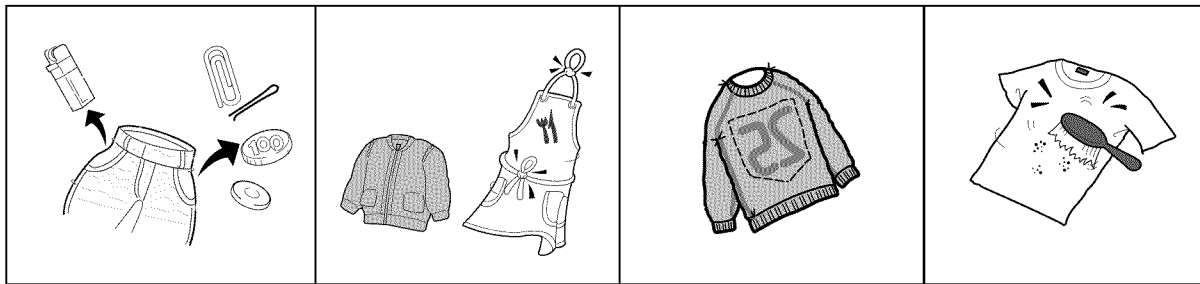

| Sorting |
|---|
| <ul style="list-style-type: none"> • Separate heavily soiled items from lightly soiled ones, even if they would normally be washed together. • Separate dark colors from light colors, colorfast items from non-colorfast item. |

| | |
|-----------------------------------|---|
| Soil (Heavy, Normal, Light) | Separate clothes according to amount of soil. |
| Color (White, Lights, Darks) | Separate white clothes from colored clothes. |
| Lint (Lint producers, Collectors) | Wash lint producers and lint collectors separately. |

Loading

- Drop items into washer loosely. Items should move easily through wash water for best cleaning and wrinkle-free results.
- Load washer properly and select correct load size setting. Overloading and selecting a setting too small for the wash load can :
 - Cause poor cleaning
 - Increase wrinkling
 - Create excessive lint
 - Wear out items faster (because of pilling)
- Mix large and small items in each load. Load evenly to maintain washer balance. An unbalanced load can make the washer vibrate during spin.
- Reduce wash time when using a small load size setting. Load with only a few small items needs less wash time.
- Use a large load size setting to reduce wrinkling with permanent press clothes and some synthetic knits. These items should have more room to move in the water than heavy items. (towels, jeans)

Adding detergent

① Detergent case

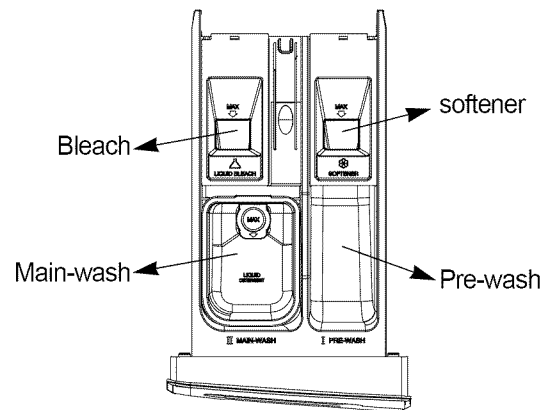

② Adding fabric softener or bleach or liquid detergent

- If desired, add measured liquid softener or bleach or liquid detergent to the softener or bleach or liquid detergent inlet.
- Pour liquid softener or bleach or liquid detergent into the dispenser using the amount recommended on the package.
- Do not exceed the maximum fill line. Overfilling can cause early dispensing of the softener or bleach or liquid detergent which could stain clothes.
- Do not open the detergent case when water is supplied.
- Avoid pouring softener or bleach or liquid detergent directly on the clothes.
- Check to see if the liquid case are even.

USING THE DISPENSER

The automatic dispenser consists of four compartments which hold 1) liquid chlorine bleach, 2) liquid fabric softener, 3) liquid or powdered detergent for prewash and 4) liquid or powdered detergent and color safe bleach for main wash.

All laundry products can be added at once in their respective dispenser compartments.

They will be dispensed at the appropriate time for most effective cleaning. After loading the laundry additives into the dispenser, close the dispenser drawer.

Add detergent, bleach and fabric softener to the automatic dispenser following these steps:

1. Open the dispenser drawer.
2. Load the laundry products into the appropriate compartments.
3. Close the dispenser drawer.

■ About detergent



Designed specially to use only
HE(High Efficiency) detergent

Your DAEWOO KLASSE washer is designed to use only High Efficiency (HE) detergents.

HE detergents are formulated specifically for front load washers and contain suds reducing components.

HE detergents make less suds, improve washing and rinsing performance, and help to keep the interior of your DAEWOO KLASSE washer clean. Use the manufacture's recommend amount.

If a regular detergent is used, it may cause oversudsing and unsatisfactory performance.

For the best washing and rinsing performance, low-sudsing HE detergents are strongly recommended.

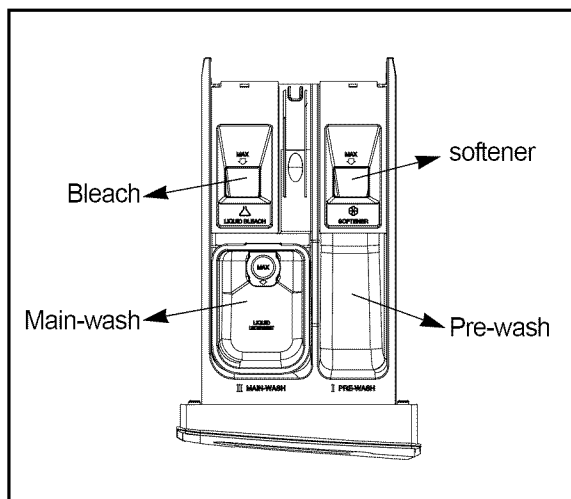

1. Prewash Detergent Compartment

- Add detergent to this compartment when using the Prewash option. Liquid or powdered detergent may be used in this compartment. The detergent will automatically be dispensed during Prewash if the Prewash option is selected.
- Add 1/2 the recommended amount of detergent to the Prewash compartment and the recommended amount of detergent to the main wash compartment.

NOTE: Liquid detergent will drain into the washer drum as it is added.

2. Main Wash Detergent Compartment

- Add measured detergent to this compartment for Main wash. Detergent is flushed from the dispenser at the beginning of the cycle. Either powdered or liquid detergent can be used.
- Liquid or powdered color-safe bleach may be added to the main wash compartment along with the same type of liquid or powdered detergent.
- When using liquid detergent, make sure the liquid detergent box and insert are in place. Do not exceed the maximum fill line.
- For powdered detergent, remove both the liquid detergent box and insert.
- Powdered detergent will not dispense with the liquid detergent box and insert in place.



**Designed specially to use only
HE(High Efficiency) detergent**

3. Liquid Bleach Compartment

- Add measured liquid chlorine bleach to this compartment. The bleach will be automatically dispensed at the proper time during the wash cycle.
- Do not exceed the maximum fill line. Overfilling can cause early dispensing of the bleach which could result in damaged clothes.
- Do not pour undiluted liquid chlorine bleach directly onto the load or into the drum. Fabric damage can occur.
- Do not use powdered bleach in this compartment.







4. Fabric Softener Compartment

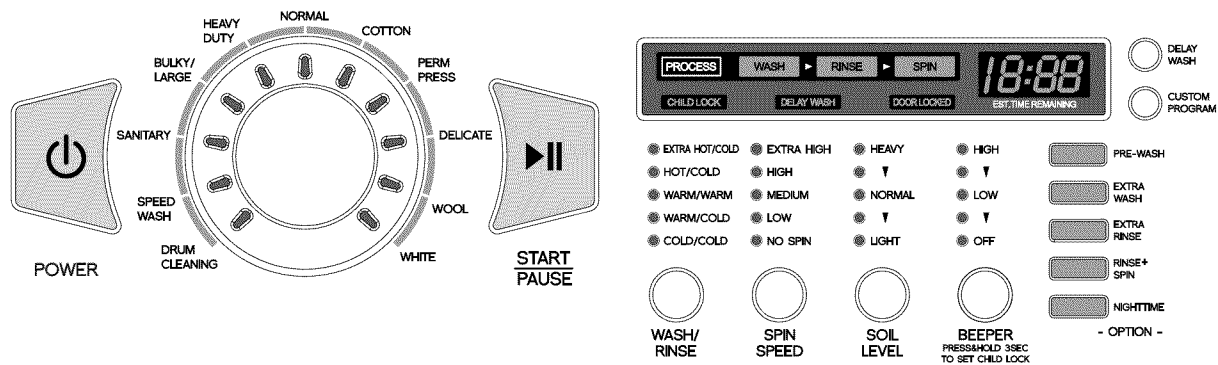



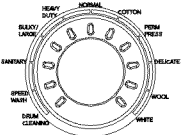



- Add recommended amount of fabric softener to this compartment.
- Dilute concentrated softeners with warm water to the fill line.
- Do not exceed the maximum fill line. Overfilling can cause early dispensing of the fabric softener which could result in stained clothes.
- Do not pour fabric softener directly on the wash load.
- The fabric softener will be automatically dispensed during the last rinse cycle.

NOTE: Do not place, store, or spill laundry products (Soap, detergent, bleach, softener, etc.) on the top of your washer or dryer. These products can damage the finish or controls if left there too long. Design capacity of fabric softener compartment shall be such as to maintain a minimum pressure of 10 pounds per square inch(psi).

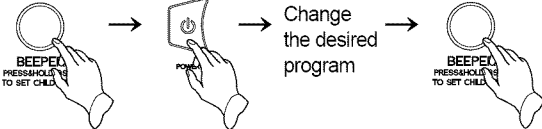
THE FUNCTION OF CONTROL PANEL



| | |
|--|---|
|  <p>POWER</p> | <p>Press this switch to turn the power "ON" or "OFF".</p> |
|  <p>START PAUSE</p> | <p>Operation and temporary stop is repeated as it is pressed. When you want to change program in operating; Press the "Start / Pause" button → Select the program that you want to change → Press the "Start / Pause" button again.</p> |
|  | <p>You can select the course you want and each lamp is turned on when that course is selected.</p> |
|  <p>WASH/ RINSE</p> | <p>You can select the wash/rinse course you want and each lamp is turned on when that course is selected. As this button is pressed, the wash/rinse course is selected by 'Warm/Cold' → 'Warm/Warm' → 'Hot/Cold' → 'Extra hot/cold' → 'Cold/Cold'</p> |
|  <p>SPIN SPEED</p> | <p>You can select the soil level you want and each lamp is turned on when that course is selected.</p> |
|  <p>SOIL LEVEL</p> | <p>You can select the soil level you want and each lamp is turned on when that level is selected. As this button is pressed, the soil level is selected by 'Normal' → 'Heavy' → 'Light'</p> |
|  <p>BEEPER</p> | <p>You can select the volume of beeper you want and each lamp is turned on when that volume of beeper is selected. As this button is pressed, the volume of beeper is selected by 'Low' → 'High' → 'Off'</p> |

| | |
|---|--|
|  DELAY WASH | <p>If can be used to pre-engaged in for wash 1 hour to 12 hours.</p> |
|  CUSTOM PROGRAM | <p>use to memorize frequently used program To make a Custom Program.</p> <ol style="list-style-type: none"> 1. Select a cycle. ('18:88' or 'CEP' will be shown by turns) 2. Select Wash/Rinse Temperature, Spin Speed, and Soil Level. 3. Select other desired Options. 4. Press Start/Pause Button. |
|  BEEPER PRESS&HOLD 3SEC TO SET CHILD LOCK | <p>Use this function when you want to protect any accident occurring from handling of washer by a child. During an operation of washer, press 'BEEPER' buttons simultaneously during 3 second. If this mode will be set successfully, Child Lock Lamp will be burn out. In Child Lock mode, no button functions except Power button. And if you want to release this mode, press 'BEEPER' buttons simultaneously again during 3 second.</p>  <p>*The Child Lock will be cancelled when power is off.</p> |
|  PRE-WASH | <p>Use this option for loads that need pretreatment. Adds 16 minutes prewash and drain.</p> |
|  EXTRA WASH | <p>Adds time to the wash for better stain removal.</p> |
|  EXTRA RINSE | <p>This option provides an additional rinse. Use this option to ensure the removal of detergent or bleach residue from garments.</p> |
|  RINSE+ SPIN | <p>Use this option to rinse and then spin.</p> |
|  NIGHTTIME | <p>The NIGHTTIME cycle reduce the noise.</p> |

WASHING PROGRAM

| Program | Fabric type | Proper Temp. | Default data | Maximum Load |
|---------------|---|------------------|---|-----------------------|
| White | First check whether laundry is machine washable. (white cotton, linen, towel and sheets..) | Warm/ Cold | Wash: main wash Rinse: 2 Spin: Medium soil level : light | Refer to rating label |
| Wool | Machine washable woolens with pure new wool only | Cold / Cold | Wash: main wash Rinse: 1 Spin: Low soil level : light | Refer to rating label |
| Delicate | Delicated laundry easily damaged. (silk, curtains,..) | Cold / Cold | Wash: main wash Rinse: 1 Spin: Low soil level : normal | Refer to rating label |
| Perm Press | Dress shirts/ pants, wrinkle free clothing, poly/cotton blend clothing, table cloths | Warm / Cold | Wash: main wash Rinse: 2 Spin: High soil level : normal | Refer to rating label |
| Cotton | Cotton, Linen, Towels, Shirts, Sheets | Warm / Cold | Wash: main wash Rinse: 2 Spin: Extra High soil level : normal | Refer to rating label |
| Normal | Mixed loads, Work Clothes, Jeans, Shirts. | Warm / Cold | Wash: main wash Rinse: 2 Spin: Medium soil level : normal | Refer to rating label |
| Bulky/Large | This selection is used for washing blankets, curtain etc. | Cold/Cold | Wash: main wash Rinse: 2 Spin: Medium soil level : normal | Refer to rating label |
| Heavy Duty | Heavy soiled clothes (blue-jean,climbing clothes, ruck sack, sports wear,...) | Warm / Warm | Wash: pre wash + main wash Rinse: 3 Spin: High soil level : normal | Refer to rating label |
| Sanitary | Heavy soiled underwear, work clothes, diapers, etc. | Extra hot / cold | Wash: main wash Rinse: 2 Spin: Medium soil level : normal | Refer to rating label |
| Speed Wash | Lightly soiled clothes and frequently washing clothes and small amount of clothes. Wash. | Cold / Cold | Wash: main wash Rinse: 1 Spin: Low soil level : light | Less than 3 kg |
| Drum Cleaning | Use to clean the Tub and Drum. | Cold / Cold | Wash: soak Rinse: 2 Spin: Low | Without load. |

| Program | Soak | Delay Wash | PreWash | Extra Wash | Extra Rinse | Rinse +Spin | Night Time |
|---------------|-----------------------|-----------------------|-----------------------|-----------------------|-----------------------|-----------------------|-----------------------|
| White | | <input type="radio"/> | <input type="radio"/> | <input type="radio"/> | <input type="radio"/> | <input type="radio"/> | <input type="radio"/> |
| Wool | | | | | <input type="radio"/> | <input type="radio"/> | <input type="radio"/> |
| Delicate | | | <input type="radio"/> | | <input type="radio"/> | <input type="radio"/> | <input type="radio"/> |
| Permpress | | <input type="radio"/> | <input type="radio"/> | <input type="radio"/> | <input type="radio"/> | <input type="radio"/> | <input type="radio"/> |
| Cotton | | <input type="radio"/> | <input type="radio"/> | <input type="radio"/> | <input type="radio"/> | <input type="radio"/> | <input type="radio"/> |
| Normal | | <input type="radio"/> | <input type="radio"/> | <input type="radio"/> | <input type="radio"/> | <input type="radio"/> | <input type="radio"/> |
| Heavy Duty | | <input type="radio"/> | <input type="radio"/> | <input type="radio"/> | <input type="radio"/> | <input type="radio"/> | <input type="radio"/> |
| Bulk | | | <input type="radio"/> | <input type="radio"/> | <input type="radio"/> | <input type="radio"/> | <input type="radio"/> |
| Sanitary | | <input type="radio"/> | <input type="radio"/> | <input type="radio"/> | <input type="radio"/> | <input type="radio"/> | <input type="radio"/> |
| Speed wash | | <input type="radio"/> | | | | <input type="radio"/> | <input type="radio"/> |
| Drun Cleanign | <input type="radio"/> | | | | | | |

WASHING PROCEDURE AND SELECTION

1. WHITE PROGRAM

| | |
|---|---|
| 1 | <p>Put the laundry into the Drum and put the detergent and softener into the detergent case. Then close the Door.</p> <ul style="list-style-type: none">• Put the detergent into the main wash room(I l marking) and prewash room(I marking) in the detergent case.• Liquid detergent, Softner and Bleach should be below 'MAX' level.• Put the detergent into the pre wash room(I marking) only if you want to add prewash. |
| 2 | <p>Press the Power button.</p> <ul style="list-style-type: none">• The LED shows only '- --' signal. |
| 3 | <p>Select the 'WHITE' program using the program selection dial.</p> <ul style="list-style-type: none">• If you press 'Start/Pause' button after pressing Power button without selecting program, the 'Cotton' program is selected as default program.• 'Main wash' and '2' times rinse and 'Medium' spin speed and ' Warm/Cold' water temperature and 'light' soil level are selected automatically.• If you want to change the 'Wash/Rinse' and 'Water Temperature' and 'Spin Speed' and 'Soil Level' and 'Beeper' , select program what you want to change by pressing each button. |
| 4 | <p>Press the 'Start/Pause' button.</p> <ul style="list-style-type: none">• The washer will be operated with locking Door and supplying water after sensing the amount of laundry automatically. |

Note

- If you want to change the setting program during operation, press the 'Start/Pause' button to hold the operation and change the program you want to change by pressing each corresponding button.
- The water temperature 'Cold/Cold'~'Hot/Cold' are only selectable.

2. WOOL PROGRAM

| | |
|---|--|
| 1 | <p>Put the laundry into the Drum and put the detergent and softener into the detergent case. Then close the Door.</p> <ul style="list-style-type: none">• Put the detergent into the main wash room(I I marking) in the detergent case.• Liquid detergent, Softner and Bleach should be below 'MAX' level. |
| 2 | <p>Press the Power button.</p> <ul style="list-style-type: none">• The LED shows only '- --' signal. |
| 3 | <p>Select the 'WOOL' program using the program selection dial.</p> <ul style="list-style-type: none">• If you press 'Start/Pause' button after pressing Power button without selecting program, the 'Cotton' program is selected as default program.• 'Cold/Cold' water temperature and 'Light' soil level and 'Main Wash' and '1' time rinse and 'Low' spin speed are selected automatically.• If you want to change the 'Spin Speed' and 'Beeper', select program what you want to change by pressing each button. |
| 4 | <p>Press the 'Start/Pause' button.</p> <ul style="list-style-type: none">• The washer will be operated with locking Door and supplying water after sensing the amount of laundry automatically. |

Note

- If you want to change the setting program during operation, press the 'Start/Pause' button to hold the operation and change the program you want to change by pressing each corresponding button.
- Water Temperature 'Cold/Cold' is only selected, in order to prevent clothes from damaging.
- 'Time Delay' is not selected.
- Soil Level 'Light' is only selected, in order to prevent clothes from damaging.
- Spin speed 'no spin'~'Low' are only selectable.

3. DELICATE PROGRAM

| | |
|---|--|
| 1 | <p>Put the laundry into the Drum and put the detergent and softener into the detergent case. Then close the Door.</p> <ul style="list-style-type: none">• Put the detergent into the main wash room(I I marking) and prewash room(I marking) in the detergent case.• Liquid detergent, Softner and Bleach should be below 'MAX' level.• Put the detergent into the pre wash room(I marking) only if you want to add prewash. |
| 2 | <p>Press the Power button.</p> <ul style="list-style-type: none">• The LED shows only '- --' signal. |
| 3 | <p>Select the 'DELICATE' program using the program selection dial.</p> <ul style="list-style-type: none">• If you press 'Start/Pause' button after pressing Power button without selecting program, the 'NORMAL' program is selected as default program.• 'Cold / Cold' Water temperature and 'Normal' soil level and 'Main Wash' and '1' times rinse and 'Low' spin speed are selected automatically.• If you want to change the 'Spin Speed' and 'Soil Level' and 'Beeper' , select program what you want to change by pressing each button. |
| 4 | <p>Press the 'Start/Pause' button.</p> <ul style="list-style-type: none">• The washer will be operated with locking Door and supplying water after sensing the amount of laundry automatically. |

Note

- If you want to change the setting program during operation, press the 'Start/Pause' button to hold the operation and change the program you want to change by pressing each corresponding button.
- Time Delay is not selected.
- Spin speed 'no spin ~ 'Medium' are only selectable.
- Wash/Rinse water Temperature 'cold/cold' is only selected, in order to prevent clothes from damaging.

4. Perm Press PROGRAM

| | |
|---|---|
| 1 | <p>Put the laundry into the Drum and put the detergent and softener into the detergent case. Then close the Door.</p> <ul style="list-style-type: none">• Put the detergent into the main wash room(I l marking) and prewash room(I marking) in the detergent case.• Liquid detergent, Softner and Bleach should be below 'MAX' level.• Put the detergent into the pre wash room(I marking) only if you want to add prewash. |
| 2 | <p>Press the Power button.</p> <ul style="list-style-type: none">• The LED shows only '- --' signal. |
| 3 | <p>Select the 'Perm Press' program using the program selection dial.</p> <ul style="list-style-type: none">• If you press 'Start/Pause' button after pressing Power button without selecting program, the 'NORMAL' program is selected as default program.• 'Warm / Cold' Water temperature and 'Normal' soil level and 'Main Wash' and '2' times rinse and 'High' spin speed are selected automatically.• If you want to change the 'Wash/Rinse Water Temperature' and 'Spin Speed' and 'Soil Level' and 'Beeper', select program what you want to change by pressing each button. |
| 4 | <p>Press the 'Start/Pause' button.</p> <ul style="list-style-type: none">• The washer will be operated with locking Door and supplying water. |

Note

- If you want to change the setting program during operation, press the 'Start/Pause' button to hold the operation and change the program you want to change by pressing each corresponding button.
- The water temperature 'Cold/Cold'~'Hot/Cold' are only selectable.

5. COTTON PROGRAM

| | |
|---|--|
| 1 | <p>Put the laundry into the Drum and put the detergent and softener into the detergent case. Then close the Door.</p> <ul style="list-style-type: none">• Put the detergent into the main wash room(I l marking) and prewash room(I marking) in the detergent case.• Liquid detergent, Softner and Bleach should be below 'MAX' level.• Put the detergent into the pre wash room (I marking) only if you want to add prewash. |
| 2 | <p>Press the Power button.</p> <ul style="list-style-type: none">• The LED shows only '- --' signal. |
| 3 | <p>Select the 'COTTON' program using the program selection dial.</p> <ul style="list-style-type: none">• If you press 'Start/Pause' button after pressing Power button without selecting program, the 'Cotton' program is selected as default program.• 'Warm/Cold' water temperature and 'Normal' soil level and 'Main Wash' and '2' times rinse and 'Extra High' spin speed are selected automatically.• If you want to change the 'Wash/Rinse Water Temperature' and 'Spin Speed' and 'Soil Level' and 'Beeper' , select program what you want to change by pressing each button. |
| 4 | <p>Press the 'Start/Pause' button.</p> <ul style="list-style-type: none">• The washer will be operated with locking Door and supplying water. |

Note

- If you want to change the setting program during operation, press the 'Start/Pause' button to hold the operation and change the program you want to change by pressing each corresponding button.
- The water temperature 'Cold/Cold'~'Hot/Cold' are only selectable.

6. NORMAL PROGRAM

| | |
|---|--|
| 1 | <p>Put the laundry into the Drum and put the detergent and softener into the detergent case. Then close the Door.</p> <ul style="list-style-type: none">• Put the detergent into the main wash room(I marking) and prewash room(I marking) in the detergent case.• Liquid detergent, Softner and Bleach should be below 'MAX' level.• Put the detergent into the pre wash room (I marking) only if you want to add prewash. |
| 2 | <p>Press the Power button.</p> <ul style="list-style-type: none">• The LED shows only '- --' signal. |
| 3 | <p>Select the 'NORMAL' program using the program selection dial.</p> <ul style="list-style-type: none">• If you press 'Start/Pause' button after pressing Power button without selecting program, the 'Cotton' program is selected as default program.• 'Warm/Cold' water temperature and 'Normal' soil level and 'Main Wash' and '2' times rinse and 'Medium' spin speed are selected automatically.• If you want to change the 'Wash/Rinse Water Temperature' and 'Spin Speed' and 'Soil Level' and 'Beeper' , select program what you want to change by pressing each button. |
| 4 | <p>Press the 'Start/Pause' button.</p> <ul style="list-style-type: none">• The washer will be operated with locking Door and supplying water. |

Note

- If you want to change the setting program during operation, press the 'Start/Pause' button to hold the operation and change the program you want to change by pressing each corresponding button.
- The water temperature 'Cold/Cold'~'Hot/Cold' are only selectable.

7. HEAVY Duty PROGRAM

| | |
|---|--|
| 1 | <p>Put the laundry into the Drum and put the detergent and softener into the detergent case. Then close the Door.</p> <ul style="list-style-type: none">• Put the detergent into the main wash room(I l marking) and prewash room(I marking) in the detergent case.• Liquid detergent, Softner and Bleach should be below 'MAX' level.• Put the detergent into the pre wash room(I marking) only if you want to add prewash. |
| 2 | <p>Press the Power button.</p> <ul style="list-style-type: none">• The LED shows only '- --' signal. |
| 3 | <p>Select the 'HEAVY DUTY' program using the program selection dial.</p> <ul style="list-style-type: none">• If you press 'Start/Pause' button after pressing Power button without selecting program, the 'Cotton' program is selected as default program.• 'Warm/Warm' water temperature and 'Normal' soil level and 'Pre Wash + Main Wash' and '3' times rinse and 'High' spin speed are selected automatically.• If you want to change the 'Wash/Rinse Water Temperature' and 'Spin Speed' and 'Soil Level' and 'Beeper', select program what you want to change by pressing each button. |
| 4 | <p>Press the 'Start/Pause' button.</p> <ul style="list-style-type: none">• The washer will be operated with locking Door and supplying water. |

Note

- If you want to change the setting program during operation, press the 'Start/Pause' button to hold the operation and change the program you want to change by pressing each corresponding button.
- The water temperature 'Cold/Cold'~'Hot/Cold' are only selectable.

8. BULKY / LARGE PROGRAM

| | |
|---|--|
| 1 | <p>Put the laundry into the Drum and put the detergent and softener into the detergent case.</p> <p>Then close the Door.</p> <ul style="list-style-type: none">• Put the detergent into the main wash room(I l marking) and prewash room(I marking) in the detergent case.• Liquid detergent, Softner and Bleach should be below 'MAX' level.• Put the detergent into the pre wash room (I marking) only if you want to add prewash. |
| 2 | <p>Press the Power button.</p> <ul style="list-style-type: none">• The LED shows only '- --' signal. |
| 3 | <p>Select the 'BULKY / LARGE' program using the program selection dial.</p> <ul style="list-style-type: none">• If you press 'Start/Pause' button after pressing Power button without selecting program, the 'Cotton' program is selected as default program.• 'Cold/Cold' water temperature and 'Normal' soil level and 'Main Wash' and '2' times rinse and 'Medium' spin speed are selected automatically.• If you want to change the 'Wash/Rinse Water Temperature' and 'Spin Speed' and 'Soil Level' and 'Beeper', select program what you want to change by pressing each button. |
| 4 | <p>Press the 'Start/Pause' button.</p> <ul style="list-style-type: none">• The washer will be operated with locking Door and supplying water. |

Note

- If you want to change the setting program during operation, press the 'Start/Pause' button to hold the operation and change the program you want to change by pressing each corresponding button.
- 'Time Delay' is not selected.
- The water temperature 'Cold/Cold'~'Warm/Warm' are only selectable.
The spin speed 'No Spin'~'High' are only selectable.

9. SANITARY PROGRAM

| | |
|---|--|
| 1 | <p>Put the laundry into the Drum and put the detergent and softener into the detergent case. Then close the Door.</p> <ul style="list-style-type: none">• Put the detergent into the main wash room(I l marking) and prewash room(I marking) in the detergent case.• Liquid detergent, Softner and Bleach should be below 'MAX' level.• Put the detergent into the pre wash room (I marking) only if you want to add prewash. |
| 2 | <p>Press the Power button.</p> <ul style="list-style-type: none">• The LED shows only '- --' signal. |
| 3 | <p>Select the 'Sanitary' program using the program selection dial.</p> <ul style="list-style-type: none">• If you press 'Start/Pause' button after pressing Power button without selecting program, the 'Cotton' program is selected as default program.• 'Extra Hot/Cold' water temperature and 'Normal' soil level and 'Main Wash' and '2' times rinse and 'Medium' spin speed are selected automatically.• If you want to change the 'Wash/Rinse Water Temperature' and 'Spin Speed' and 'Soil Level' and 'Beeper', select program what you want to change by pressing each button. |
| 4 | <p>Press the 'Start/Pause' button.</p> <ul style="list-style-type: none">• The washer will be operated with locking Door and supplying water. |

Note

- If you want to change the setting program during operation, press the 'Start/Pause' button to hold the operation and change the program you want to change by pressing each corresponding button.

10. SPEED-WASH PROGRAM

| | |
|---|---|
| 1 | <p>Put the laundry into the Drum and put the detergent and softener into the detergent case. Then close the Door.</p> <ul style="list-style-type: none">• Put the detergent into the main wash room(I I marking) in the detergent case.• Liquid detergent, Softner and Bleach should be below 'MAX' level. |
| 2 | <p>Press the Power button.</p> <ul style="list-style-type: none">• The LED shows only '- --' signal. |
| 3 | <p>Select the 'Speed-wash' program using the program selection dial.</p> <ul style="list-style-type: none">• If you press 'Start/Pause' button after pressing Power button without selecting program, the 'Cotton' program is selected as default program.• 'Cold/Cold' water temperature and 'Light' soil level and 'Main Wash' and '1' times rinse and 'Low' spin speed are selected automatically.• If you want to change the 'Wash/Rinse Water Temperature' and 'Spin Speed' and 'Soil Level' and 'Beeper', select program what you want to change by pressing each button. |
| 4 | <p>Press the 'Start/Pause' button.</p> <ul style="list-style-type: none">• The washer will be operated with locking Door and supplying water. |

Note

- The appropriate amount of laundry is below 3 kg.
- If you want to change the setting program during operation, press the 'Start/Pause' button to hold the operation and change the program you want to change by pressing each corresponding button.
- The water temperature 'Cold/Cold'~'Warm/Warm' are only selectable.
The spin speed 'No Spin'~'Medium' are only selectable.

11. DRUM CLEANING PROGRAM

| | |
|---|---|
| 1 | Press the Power button. • The LED shows only '- -' signal. |
| 2 | Select the 'DRUM CLEANING' program using the program selection dial. • If you press 'Start/Pause' button after pressing Power button without selecting program, the 'Cotton' program is selected as default program. • 'Cold/Cold' water temperature and 'soak' washing course and '2' times rinse and 'Low' spin speed are selected automatically. |
| 3 | Press the 'Start/Pause' button. • The washer will be operated with locking Door and supplying water. |

Note

- 'Time Delay' is not selected.
- Use this program without load.
- The appropriate cleaning time is one time per a month.

GUIDE FOR OTHER USEFUL PROGRAMS

DELAY WASH

| | |
|---|---|
| 1 | <p>Put the laundry into the Drum and put the detergent and softener into the detergent case. Then close the Door.</p> <ul style="list-style-type: none"> • Put the detergent into the main wash room(I I marking) and prewash room(I marking) in the detergent case. • Softener should be below 'MAX' level. • Put the detergent into the pre wash room(I marking) only if you want to add prewash. • When you want to use bleach, put it into the main wash room (I I marking) with detergent. |
| 2 | <p>Press the Power button.</p> <ul style="list-style-type: none"> • The LED shows only '- --' signal. |
| 3 | <p>Select the program using the program selection dial.</p> <ul style="list-style-type: none"> • If you press 'Start/Pause' button after pressing Power button without selecting program, the 'Cotton' program is selected as default program. • If you want to change the 'Water Temperature' and 'Soil level' and 'Washing Course' and 'Rinse Time(s)' and 'Spin Speed', select program what you want to change by pressing each button. |
| 4 | <p>Press the 'Time Delay' button.</p> <ul style="list-style-type: none"> • The 'Time Delay' LED is to be lighting. • Select the time delay time you want from 1 hour to 12 hours by pressing button. • The displayed time shows program finishing time. |
| 5 | <p>Press the 'Start/Pause' button.</p> <ul style="list-style-type: none"> • If you make this program successfully, only 'Time Delay' and 'Lock' LED are lighting. |

Note

- If you want to check the selected program, press the 'Start/Pause' button again.
- Preparing washing before starting 'Time Delay';
 - Turn on the water tap.
 - Load laundry and close Door.
 - Place the detergent and fabric softner in the detergent case.
- The actual time of finishing is a little different with your selecting time because of water supply condition and selected water temperature,....
- 'WOOL' and 'DELICATE' and 'DRUM CLEANING' and 'Bulky/Large' program are not select 'Time Delay'.
- Adding clothes during 'Time Delay' operation is not allowed.

CUSTOM PROGRAM

| | |
|---|--|
| 1 | Put the laundry into the Drum and put the detergent and softener into the detergent case. Then close the Door. <ul style="list-style-type: none">• Put the detergent into the main wash room(I I marking) and prewash room(I marking) in the detergent case.• Softener should be below 'MAX' level.• Put the detergent into the pre wash room(I marking) only if you want to add prewash.• When you want to use bleach, put it into the main wash room (I I marking) with detergent. |
| 2 | Press the Power button. <ul style="list-style-type: none">• The LED shows only '- --' signal. |
| 3 | Press the Custom button <ul style="list-style-type: none">• '18:88' or 'CEP' will be shown by turns. |
| 4 | Press Start/ pause Button |

Note :

use to memorize frequently used program

To make a Custom Program.

1. Select a cycle. ('18:88' or 'CEP' will be shown by turns)
2. Select Wash/Rinse Temperature, Spin Speed, and Soil Level.
3. Select other desired Options.
4. Press Start/Pause Button.

ONLY SPIN

| | |
|---|---|
| 1 | Put the laundry into the Drum and close the Door. |
| 2 | Press the Power button. <ul style="list-style-type: none">• The LED shows only '- --' signal. |
| 3 | Select the 'SPIN CONDITION' you want by pressing 'SPIN' button. <ul style="list-style-type: none">• The 'Cotton' program is selected automatically.• The water temperature is selected to 'Cold/Cold' automatically. |
| 4 | Press the 'Start/Pause' button. <ul style="list-style-type: none">• The washer will be operated with locking Door. |

RINSE+SPIN

| | |
|---|--|
| 1 | Put the laundry into the Drum and put softener into the detergent case. Then close the Door. • Softener should be below 'MAX' level. |
| 2 | Press the Power button. • The LED shows only '- --' signal. |
| 3 | Select the program you want using the program selection dial. • If you press 'RINSE+SPIN' button without selecting program, the 'Cotton' program is selected as default program. |
| 4 | Press the 'RINSE+SPIN' button. • '1' time rinse and 'Medium' rpm spin speed and 'Cold/Cold' water temperature are selected automatically. • 'Low' rpm spin speed is selected in 'WOOL' and 'DELICATE' program. • If you want to change the Rinse time(s) and Spin condition, press each corresponding button. |
| 5 | Press the 'Start/Pause' button. • The washer will be operated with locking Door. |

Note :

- The water temperature selecting is possible during this process.

MAINTENANCE

Proper care of your washer can extend its life. This section explains how to care for your washer properly and safely.

Cleaning your washer

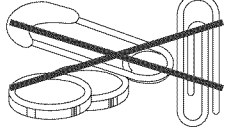
| Exterior | Interior |
|---|---|
| <p>Wipe up detergent, bleach, and other spills with a soft, damp cloth or sponge as they occur. Occasionally wipe the outside of the washer to keep its looking like new one.</p>  | <p>Clean interior with 250ml of chlorine bleach mixed with 500ml of detergent. Run washer through a complete cycle. Repeat this process if necessary.</p> |
| <p>Do not put sharp or metal object in your washer, or they can damage the finish. Check all pockets for pins, clips, money, bolts, nuts, etc. Do not lay these objects in your washer after emptying pockets.</p>  | |

Winter storage or moving care

Install and store your washer where it will not freeze. Because some water may stay in the hoses, freezing can damage your washer.

If you store or move your washer during freezing weather, winterize it.

| To winterize washer | To use washer again |
|--|---|
| <ul style="list-style-type: none"> • Turn off water faucet. • Disconnect and drain water inlet hoses. • Run washer on a drain and spin setting (see page 10) for 1 minute. • Unplug the power supply cord. | <ul style="list-style-type: none"> • Flush water pipes and hoses. • Reconnect water inlet hoses. • Turn on water faucet. • Reconnect power supply cord. |

Non-use or vacation care

Operate your washer only when you are at home.

If you are on vacation or don't use your washer for an extended period of time, you should:

- Unplug the power supply cord or turn off electrical power to the washer.
- Turn off the water supplier to the washer.

This helps avoid accidental flooding (due to a water pressure surge) while you are away.

HOW TO CLEAN THE FILTER

Cleaning the water inlet filter

Clean the filter when water leaks from the water inlet.

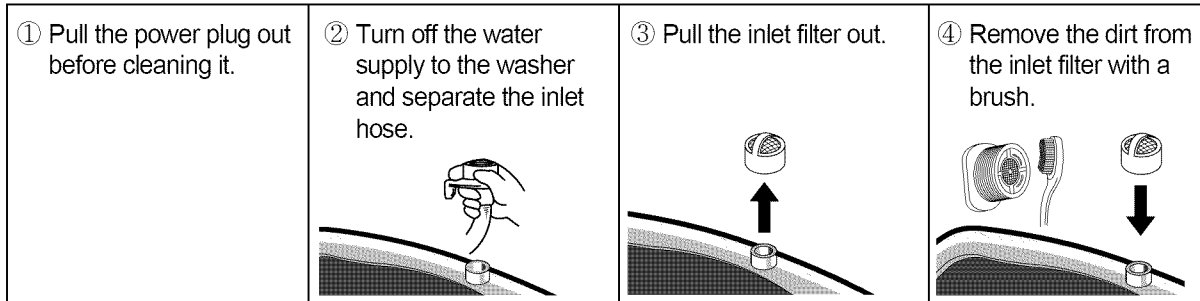

Cleaning the drain filter

- This drain filter is used to screen the foreign stuffs such as threads, coins, pins, buttons etc..
- If the drain filter is not cleaned at proper time (every 10 times of use), drain problem could be caused.

CAUTION : Be careful when draining if the water is hot.

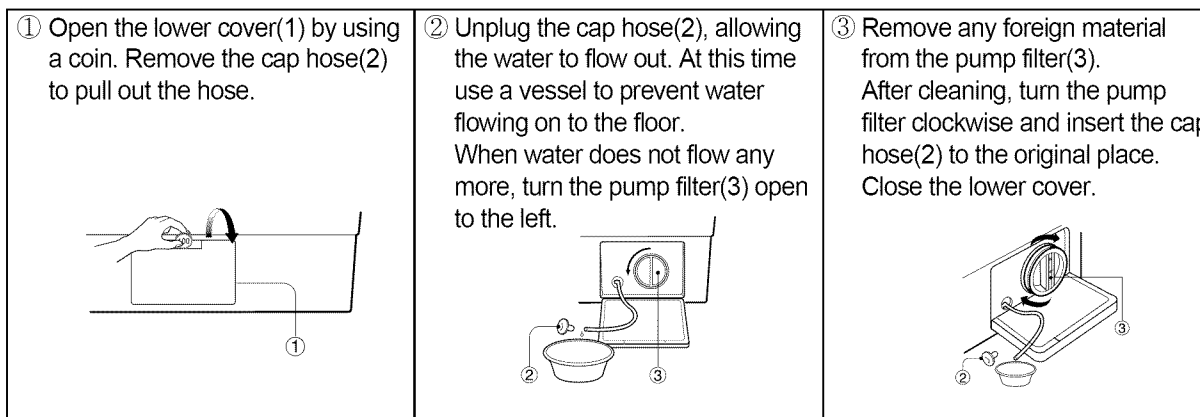

Cleaning the detergent case

After a while detergent and fabric softeners leave a deposit in the case;

- It should be cleaned from time to time with a jet of running water.
- If necessary it can be removed completely from the machine by pressing the catch downwards and by pulling it out.
- To facilitate cleaning, the upper part of the fabric softener compartment can be removed.

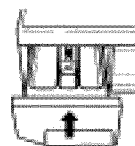
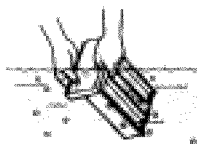
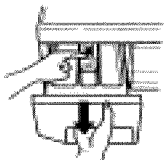

- Detergent can also accumulate inside the recess which should be cleaned occasionally with a brush.
- Once you have finished cleaning, replace the case and run a rinse cycle without laundry.

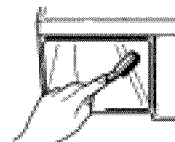

REMOVING STAINS

Stained, heavily-soiled, or greasy items may need to be prewashed or soaked for best results. Soaking helps remove protein-type stains like blood, milk or grass. Prewashing helps loosen soil before washing.

Stain removal rules

- Use warm water for soaking or prewashing stained laundry. Hot water can set stains.
- Most stains are easier to remove when they are fresh.
- Before treating any stain, find out what kind of stain it is, how old the stain is, what kind of fabric it is, and whether the fabric is colorfast. (Check the care label)
- Washing and drying can set some stains.
- Start with cold or warm water. Hot water can set some stains.
- When bleach is recommended, use a bleach that is safe for the fabric.
- Put the stained area face down on a paper towel or white cloth. Apply the stain remover to the back of the stain. This forces the stain off fabric instead of through it.

Stain removal guide

| STAIN | TO REMOVE |
|----------------------|---|
| Blood | Rinse immediately in COLD water. If stain remains, soak in cold water with an enzyme prewash. |
| Chewing gum | Use ice in plastic bag to harden the gum. Scrape off what you can and the sponge with white spirits. |
| Cocoa, Chocolate | Sponge with COLD water and soak in an enzyme prewash. If stains persist, rub in a little detergent and rinse in cold water. |
| Coffee | Blot up quickly and rinse out in COLD water. Rub in a little detergent and wash in the maximum temperature allowed for the fabric type. |
| Cream/Milk/Ice cream | Rinse in COLD water and wash normally. If stain is still apparent, sponge with white spirits. |
| Deodorant | Rub affected area with white vinegar and then rinse out in COLD water. Sponge with white spirits. Treat stiffened areas with enzyme prewash. |
| Egg | Soak in a COLD enzyme prewash, rinse and wash normally. |
| Fabric/Softener | Rub affected area with bar soap and wash normally. |
| Fruit stains | Treat as soon as possible by sponging with COLD water. Rub a little detergent on the stain and wash normally. |
| Grass | Sponge with white spirits. Rub in an enzyme prewash and wash as normally. |
| Grease and oil | Lay the affected area face down on an absorbent cloth and work from the back. Sponge with white spirits or dry cleaning fluid. Wash normally. |
| Iron or rust | Apply lemon juice and salt and place in the sun. Wash normally. |
| Lipstick | Sponge with white methylated spirits and wash normally. |
| Mildew | Wash in WARM water and detergent. Moisten area with lemon juice, dry in the sun and wash normally. If stain persists and the fabric allows, use a bleach. |
| Mud | Brush off any dry mud. Rinse in cold water. If stain persists rub in a little detergent and wash normally. |
| Paint-oil based | Scrape off any fresh paint and sponge with a non flammable dry cleaning fluid and wash normally. |
| Paint-water based | Treat while still wet, rinse in WARM water and wash normally. |
| Scorch marks | Dampen a cloth with hydrogen peroxide, lay it over the affected area and press with a fairly hot iron. |

TROUBLE SHOOTING

Most problems are easily solved if you understand the cause.

Check the following list for problem before calling for service.

If the error mode such as IE, OE, UE were displayed on the control part, in order to solve these problem, first turn off the power of the washing machine and then turn on the power pressing Power button.

If PFE error mode was displayed on the control part, in order to solve this problem, first turn off the power of the washing machine, second turn on the power pressing Power button, third press SPIN button and last press Start/Hold button.

| PROBLEM | CHECK POINT |
|---|--|
| <ul style="list-style-type: none"> The washer will not operate at all. | <ul style="list-style-type: none"> Is there a power failure? Is the power cord correctly connected to an electric outlet? Did you turn on the power? Did you press Start/Hold button? Is there correct amount of laundry in the washer? |
| <ul style="list-style-type: none"> Water is not supplied Error display IE | <ul style="list-style-type: none"> Did you connect the inlet hose and open the water tap? Is the inlet hose or the water tap frozen? Is the water supply shot off? Is there any foreign matter blocking up the inlet hose filter? |
| <ul style="list-style-type: none"> The washer will not drain Error display OE | <ul style="list-style-type: none"> Is the drain hose frozen or blocked up by dirt? Is the drain hose kinked or deformed? Is the end of the drain hose immersed in water? Is there excessive dirt inside the drain filter? |
| <ul style="list-style-type: none"> The washer will not spin Error display UE | <ul style="list-style-type: none"> Is the clothes in the drum collected on one side? Is the washer installed on an uneven floor or is the vibration serious? Is the door open? (The lamp "LE" will light up in this case.) |
| <ul style="list-style-type: none"> The washer will stop during spinning . Spinning is insufficient. Error display PFE | <ul style="list-style-type: none"> Is the filter of the drain pump clogged? Is the drain pump operated? Did you use the proper amount of detergent? Is the drain hose placed higher than 1m above floor? |
| <ul style="list-style-type: none"> Vibrating and too noisy | <ul style="list-style-type: none"> Is the washer installed on an uneven floor? Have all the transit bolts removed? |

Note

- If **EB** and **E9** error mode are showed on LED panel, please contact service center.

These cases are not malfunctions;

- The sound "wing" heard during water supply is the operating sound made by the water inlet valve.

SPECIFICATION

| MODEL | CFW-8000GW / GR / GS / GBL |
|--------------------------|---|
| Dimension (inches) | 27 x 31.8 x 40.1 (W x D x H) (Door open D : 40.9) |
| Unit Weight (lbm) | 198.4(Net) / 227(Gross) |
| Wash capacity | 3.29 cu.ft (3.8cu.ft IEC) |
| Spin Speed (RPM) | 1100 rpm max. |
| Operating Water Pressure | 4.5~145 PSI (30~1000 kPa) |
| Electrical Spec. | 120V / 60Hz, 10 A |

WIRING DIAGRAM

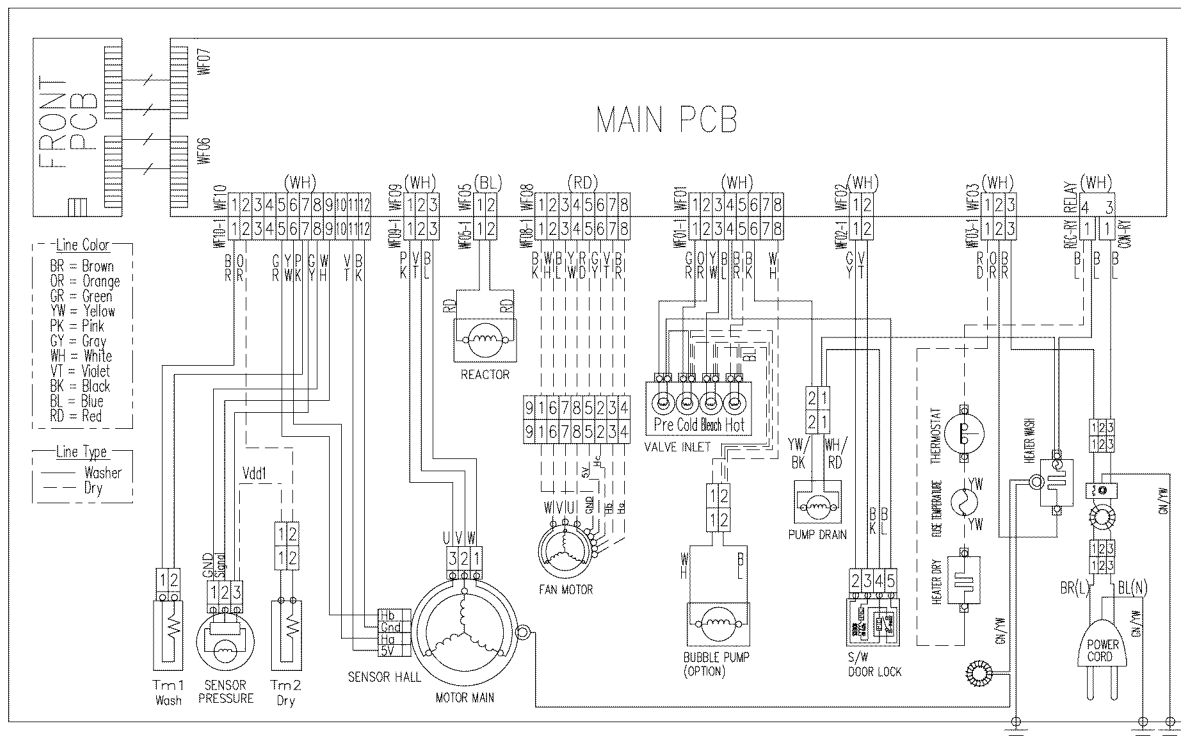

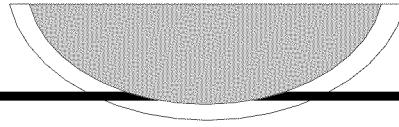

ABOUT THIS MANUAL

VISION CREATIVE, INC.

서울 종로구 봉의동 6번지 이룸빌딩4층

| | | | |
|---|--------------------------------------|----------|-----|
| 담 당 | 최수현님 | TEL | |
| MODEL | 27인치 washer, dryer, combo 및 pedestal | | |
| BUYER | CFW -8000GW / GR / GS / GBL _영어 | | |
| 일 정 | 1차 | 08.01.07 | 6차 |
| | 2차 | | 7차 |
| | 3차 | | 8차 |
| | 4차 | | 9차 |
| | 5차 | | 10차 |
| 제 판 | | 인쇄 | 동일 |
| 규 격 | | | |
| MEMO 08.01.07 - 표지, 34p 수정 08.01.09 - 표지, 12p 수정 35p 삭제 | | | |

연락처

VISION 담당 전지현

TEL: 730 - 0660 FAX: 730 - 3788