

Integrated High Definition LED Television User's Guide:

32L2400U
40L2400U
50L2400U

If you need assistance:

Toshiba's Support Web site support.toshiba.com

For more information, see "Troubleshooting" on page 97 in this guide.

Owner's Record

The model number and serial number are on the back and side of your TV.

Print out this page and write these numbers in the spaces below. Refer to these numbers whenever you communicate with your Toshiba dealer about this TV.

Model number: _____

Serial number: _____

Register your Toshiba Television at register.toshiba.com

Note: To display a High Definition picture, the TV must be receiving a High Definition signal (such as an over-the-air High Definition TV broadcast, a High Definition digital cable program, or a High Definition digital satellite program). For details, contact your TV antenna installer, cable provider, or satellite provider

GMA300033010

3/14

Dear Customer,

Thank you for purchasing this Toshiba LED TV. This document will help you use the many exciting features of your new LED TV. Before operating your LED TV, carefully read this document completely.

Safety Precautions

WARNING: TO REDUCE THE RISK OF FIRE OR ELECTRIC SHOCK, DO NOT EXPOSE THIS APPLIANCE TO RAIN OR MOISTURE.



WARNING
RISK OF ELECTRIC
SHOCK DO NOT OPEN.



WARNING: TO REDUCE THE RISK OF ELECTRIC SHOCK, DO NOT REMOVE COVER (OR BACK). NO USER-SERVICEABLE PARTS INSIDE. REFER SERVICING TO QUALIFIED SERVICE PERSONNEL.



The lightning flash with arrowhead symbol, within an equilateral triangle, is intended to alert the user to the presence of uninsulated "dangerous voltage" within the product's enclosure that may be of sufficient magnitude to constitute a risk of electric shock to persons.



The exclamation point within an equilateral triangle is intended to alert the user to the presence of important operating and maintenance (servicing) instructions in the literature accompanying the appliance.

WARNING

Improper location and installation of a television can lead to the death of your child. Never place the television on furniture or in a location where children can climb up on and tip over the television. Please refer to the Child Safety information in item 26) on page 5 of the Important Safety Instructions/Installation section.

WARNING: If you decide to wall mount this television, always use a mounting bracket that has been Listed by an independent laboratory (such as UL, CSA, ETL) and is appropriate for the size and weight of this television. The use of inappropriate or non-Listed mounting brackets could result in serious bodily injury and/or property damage. See "To Display your LED TV on the included Pedestal Stand:" on page 6

NOTE TO CATV INSTALLERS

This is a reminder to call the CATV system installer's attention to Article 820-40 of the U.S. NEC, which provides guidelines for proper grounding and, in particular, specifies that the cable ground shall be connected to the grounding system of the building, as close to the point of cable entry as practical. For additional antenna grounding information, see 33) on page 5 and 34) on page 5 .

CHILD SAFETY:

PROPER TELEVISION PLACEMENT MATTERS



TOSHIBA CARES

- Manufacturers, retailers and the rest of the consumer electronics industry are committed to making home entertainment safe and enjoyable.
- As you enjoy your television, please note that all televisions – new and old – must be supported on proper stands or installed according to the manufacturer's recommendations. Televisions that are inappropriately situated on dressers, bookcases, shelves, desks, speakers, chests, carts, etc., may fall over, resulting in injury.



TUNE IN TO SAFETY

- **ALWAYS** follow the manufacturer's recommendations for the safe installation of your television.
- **ALWAYS** read and follow all instructions for proper use of your television.
- **NEVER** allow children to climb on or play on the television or the furniture on which the television is placed.
- **NEVER** place the television on furniture that can easily be used as steps, such as a chest of drawers.
- **ALWAYS** install the television where it cannot be pushed, pulled over or knocked down.
- **ALWAYS** route cords and cables connected to the television so that they cannot be tripped over, pulled or grabbed.

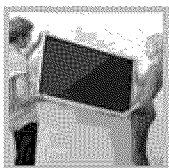

WALL OR CEILING MOUNT YOUR TELEVISION

- **ALWAYS** contact your retailer about professional installation if you have any doubts about your ability to safely mount your television.
- **ALWAYS** use a mount that has been recommended by the television manufacturer and has a safety certification by an independent laboratory (such as UL, CSA, ETL).
- **ALWAYS** follow all instructions supplied by the television and mount manufacturers.
- **ALWAYS** make sure that the wall or ceiling where you are mounting the television is appropriate. Some mounts are not designed to be mounted to walls and ceilings with steel studs or cinder block construction. If you are unsure, contact a professional installer.
- Televisions can be heavy. A minimum of two people is required for a wall or ceiling mount installation.



MOVING AN OLDER TELEVISION TO A NEW PLACE IN YOUR HOME

- Many new television buyers move their older CRT televisions into a secondary room after the purchase of a flat-panel television. Special care should be made in the placement of older CRT televisions.
- **ALWAYS** place your older CRT television on furniture that is sturdy and appropriate for its size and weight.
- **NEVER** place your older CRT television on a dresser where children may be tempted to use the drawers to climb.
- **ALWAYS** make sure your older CRT television does not hang over the edge of your furniture.

CE.org/safety



Important Safety Instructions

- 1) **Read these instructions.**
 - 2) **Keep these instructions.**
 - 3) **Heed all warnings.**
 - 4) **Follow all instructions.**
-
- 5) **Do not use this apparatus near water.**
-
- 6) **Clean only with dry cloth.**
-
- 7) **Do not block any ventilation openings.** Install in accordance with the manufacturer's instructions.
-
- 8) **Do not install near any heat sources** such as radiators, heat registers, stoves, or other apparatus (including amplifiers) that produce heat.
-
- 9) **Do not defeat the safety purpose of the polarized or grounding type plug.** A polarized plug has two blades with one wider than the other. A grounding type plug has two blades and a third grounding prong. The wide blade or the third prong are provided for your safety. If the provided plug does not fit into your outlet, consult an electrician for replacement of the obsolete outlet.
 
-
- 10) **Protect the power cord** from being walked on or pinched, particularly at plugs, convenience receptacles, and the point where they exit from the apparatus.
-
- 11) **Only use attachments/accessories specified by the manufacturer.**
-
- 12) **Use only with the cart, stand, tripod, bracket, or table specified by the manufacturer, or sold with the apparatus.** When a cart is used, use caution when moving the cart/apparatus combination to avoid injury from tip-over.
 
-
- 13) **Unplug this apparatus during lightning storms or when unused for long periods of time.**
-
- 14) **Refer all servicing to qualified service personnel.** Servicing is required when the apparatus has been damaged in any way, such as when power-supply cord or plug is damaged, liquid has been spilled or objects have fallen into the apparatus, the apparatus has been exposed to rain or moisture, does not operate normally, or has been dropped.

Additional Safety Precautions

- 14a) **CAUTION:** If the TV is dropped and the cabinet or enclosure surface has been damaged or the TV does not operate normally, take the following precautions:
 - ALWAYS turn off the TV and unplug the power cord to avoid possible electric shock or fire.
 - NEVER allow your body to come in contact with any broken glass or liquid from the damaged television. The LCD panel inside the TV contains glass and a toxic liquid. If the liquid comes in contact with your mouth or eyes, or your skin is cut by broken glass, rinse the affected area thoroughly with water and contact your doctor immediately.

- ALWAYS contact a service technician to inspect the TV any time it has been damaged or dropped.

15) CAUTION:

- To reduce the risk of electric shock, do not use the polarized plug with an extension cord, receptacle, or other outlet unless the blades can be inserted completely to prevent blade exposure.
- To prevent electric shock, match wide blade of plug to wide slot; fully insert.

16) CAUTION:

- Do not let children swallow any small parts included on or with the product or play with the plastic bag. Keep the small parts and the plastic bag out of the reach of children.

17) CAUTION:

- Do not let water or other liquids come into contact with the product, as it may result in damage.



18) WARNING:

- To prevent the spread of fire, keep candles or other open flames away from this product at all times.
- Keep the product away from direct sunlight, fire or a heat source such as a heater. This may reduce the product life time or result in fire.

Installation, Care, and Service

Installation

Follow these recommendations and precautions and heed all warnings when installing your TV:

- 19)  **WARNING: Never expose the batteries to excessive heat such as sunshine, fire, or the like.**
- 20) ALWAYS plug the product into an outlet that is located in such a manner that it can be easily unplugged in case the product requires service.
- 21) NEVER route the product's power cord inside a wall or similar enclosed area.
- 22) Never modify this equipment. Changes or modifications may void: a) the warranty, and b) the user's authority to operate this equipment under the rules of the Federal Communications Commission.
- 23)  **DANGER: RISK OF SERIOUS PERSONAL INJURY, DEATH, OR EQUIPMENT DAMAGE!**

Never place the TV on an unstable cart, stand, or table. The TV may fall, causing serious personal injury, death, or serious damage to the TV.

- 24) When selecting a location for the TV,
- NEVER allow any part of the TV to hang over the edge of the supporting furniture,
 - NEVER place the TV on tall furniture (for example, entertainment centers or bookcases) without anchoring both the furniture and the TV to a suitable support,
 - Never place cloth or other material between the TV and the supporting furniture.
 - NEVER allow children to climb on the TV

25) To avoid damage to this product, never place or store the TV in direct sunlight; hot, humid areas; or areas subject to excessive dust or vibration.

- 26) Always place the TV on the floor or a sturdy, level, stable surface that can support the weight of the unit. Secure the TV using one of the following methods:
- (1) Secure the TV with a mounting screw (Recommended).
- Place the TV on a sturdy surface that has a sufficient thickness and screw the unit on the surface securely by using the mounting screw and the fall-prevention screw hole.
 - If secured to furniture or other movable objects, the furniture must be secured to an immovable structure using the method shown in item 2 below.

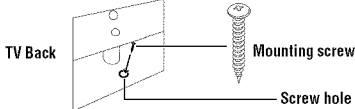

- (2) Secure the TV with a sturdy strap to a wall stud, pillar, or other immovable structure. When connecting the strap:
- attach the strap to the TV using the hooks on the back of the TV, the clips on the pedestal, or the hole in the base of the pedestal as available.
 - make sure the strap is tight, secure, and parallel to the floor.

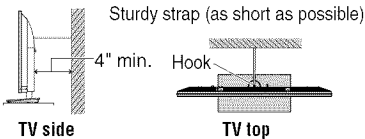

- 27) The product shall not be exposed to dripping or splashing, and that no objects filled with liquids, such as vases, shall be placed on the apparatus.
- 28) Never block or cover the slots or openings in the TV cabinet back, bottom, and sides. Never place the TV:
- on a bed, sofa, rug, or similar surface;
 - too close to drapes, curtains, or walls; or
 - in a confined space such as a bookcase, built-in cabinet, or any other place with poor ventilation.

29) Always leave a space of at least 4 (four) inches around the TV. The slots and openings are provided to protect the TV from overheating and to help maintain reliable operation of the TV.

30) Never allow anything to rest on or roll over the power cord, and never place the TV where the power cord is subject to wear or abuse.

31) Never overload wall outlets and extension cords.

32) Always operate this equipment from a 120V AC, 60 Hz power source.

33) Always make sure the antenna system is properly grounded to provide adequate protection against voltage surges and built-up static charges (see Section 810 of the National Electric Code).

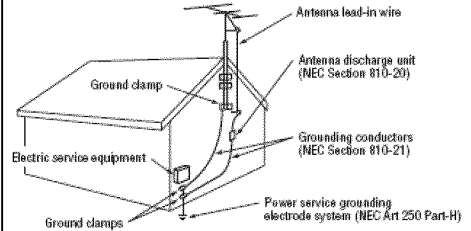

34)



DANGER: RISK OF SERIOUS PERSONAL INJURY OR DEATH!

- When installing a rooftop antenna, use extreme care to make sure you are never in a position where your body (or any item you are in contact with, such as a ladder or screwdriver) can accidentally touch overhead power lines. Never locate the antenna near overhead power lines or other electrical circuits.
- Never attempt to install any of the following during lightning activity: a) an antenna system; or b) cables, wires, or any home theater component connected to an antenna or phone system.

Care

For better performance and safer operation of your TOSHIBA TV, follow these recommendations and precautions:

35) If you use the TV in a room where the temperature is 32° F (0° C) or below, the picture brightness may vary until the LED warms up. This is not a sign of malfunction.

36)



WARNING: RISK OF SERIOUS PERSONAL INJURY OR EQUIPMENT DAMAGE!

- Never use chemicals (such as air fresheners, cleaning agents, etc.) on or near the TV pedestal.

Studies indicate that plastics may weaken and crack over time from the combined effects of chemical agents and mechanical stress (such as the weight of the TV). Failure to follow these instructions could result in serious injury and/or permanent damage to TV and TV pedestal.

- Always unplug the TV before cleaning. Gently wipe the display panel surface (the TV screen) using a dry, soft cloth (cotton, flannel, etc.). A hard cloth may damage the surface of the panel. Avoid contact with alcohol, thinner, benzene, acidic or alkaline solvent cleaners, abrasive cleaners, or chemical cloths, which may damage the surface. Never spray volatile compounds such as insecticide on the cabinet. Such products may damage or discolor the cabinet.

37) Never hit, press, or place anything on the back cover. These actions will damage internal parts.

38)



WARNING:

RISK OF ELECTRIC SHOCK!



Never spill liquids or push objects of any kind into the TV cabinet slots.

39) During a lightning storm, do not touch the connecting cables or product.

40) For added protection of your TV from lightning and power surges, always unplug the power cord and disconnect the antenna from the TV if you leave the TV unattended or unused for long periods of time.

41) Always unplug the TV to completely disconnect from mains power. When the TV is turned off using the on/off switch, it is not completely disconnected from power and a minute amount of current is still consumed.

42) During normal use, the TV may make occasional snapping or popping sounds. This is normal, especially when the unit is being turned on or off. If these sounds become frequent or continuous, unplug the power cord and contact a Toshiba Authorized Service Provider.

43)



WARNING: RISK OF SERIOUS PERSONAL INJURY OR EQUIPMENT DAMAGE!

Never strike the screen with a sharp or heavy object.

44)

- The LCD screen of this product can be damaged by ultraviolet radiation from the sun. When selecting a location for the television, avoid locations where the screen may be exposed to direct sunlight, such as in front of a window.
- Never touch, press, or place anything on the LCD screen. These actions will damage the LCD screen. If you need to clean the LCD screen, follow the instructions in item 36) on page 5.

Service

45)



WARNING:

RISK OF ELECTRIC SHOCK!



Never attempt to service the TV yourself. Opening

and removing the covers may expose you to dangerous voltage or other hazards. Failure to follow this WARNING may result in death or serious injury. Refer all servicing not specified in this manual to a Toshiba Authorized Service Provider.

46) If you have the TV serviced:

- Ask the service technician to use only replacement parts specified by the manufacturer.
- Upon completion of service, ask the service technician to perform routine safety checks to determine that the TV is in safe operating condition.

Choosing a location for your LED TV

To Display your LED TV on the included Pedestal Stand:

Observe the following safety precautions:

1) Read and follow the pedestal assembly instructions included with the pedestal.

CAUTION: Before beginning pedestal assembly, carefully lay the front of the LCD Panel face down on a flat, cushioned surface such as a quilt or blanket. Leave the bottom of the unit protruding over the edge of the surface and assemble the pedestal as described in this instruction document.

Note: *Extreme care should always be used when attaching the pedestal stand to avoid damage to the LCD panel.*

2) Place the TV on a sturdy, level surface that can support the weight of the TV.

3) Be sure to secure the TV to a wall, pillar, surface, or other immovable structure see item 26) on page 5 for additional details.

To Display your LED TV using a Wall Bracket:

If you decide to wall mount your LED TV, always use a wall bracket Listed by an independent laboratory (such as UL, CSA, ETL) that is appropriate for the size and weight of the TV:

1) **CAUTION:** Two people are required for installation.

2) Unplug and remove any cables and/or other component connectors from the rear of the TV.

3) Remove the screws of the VESA Mounting Pattern shown in the table below, if applicable.

CAUTION: Do not use the screws removed from the back cover to attach the wall mount bracket to the TV.

4) Always use the screws supplied or recommended by the wall mount manufacturer.

5) Follow the instructions provided with your wall bracket. Before proceeding, make sure the appropriate bracket(s) are attached to the wall and the back of the TV as described in the instructions provided with the wall bracket.

6) After attaching the appropriate bracket(s) to the wall and the back of the TV, remove the pedestal stand from the TV, as described in this instruction document.

7) VESA Mounting Pattern

TV Size	Hole Pattern (HxV)	Screw Size
32"	200mm x 200mm	M6
40"	200mm x 200mm	M6
50"	400mm x 200mm	M8

Removing the Pedestal Stand

- 1) Carefully lay the front of the unit face down on a flat, cushioned surface such as a quilt or blanket. Leave the stand protruding over the edge of the surface.
Note: Extreme care should always be used when removing the pedestal stand to avoid damage to the LCD panel.
- 2) Remove the stand screws shown in the diagram below. This will allow removal of the pedestal stand.
- 3) Once you have removed the screws holding the pedestal stand in place, remove the pedestal stand from the TV.

32" TV.

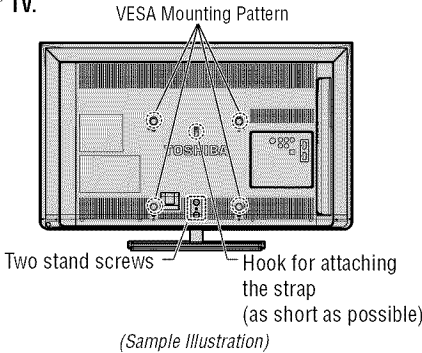

40" TV.

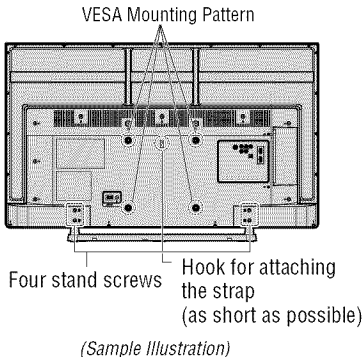

50" TV.

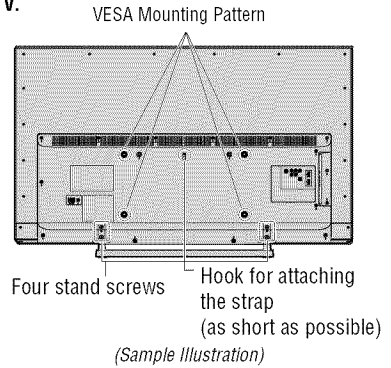

CAUTION: Always place the TV on the floor or a sturdy, level, stable surface that can support the weight of the unit. To secure the TV, use a sturdy strap from the hook(s) on the rear of the TV to a wall stud, pillar, or other immovable structure. Make sure the strap is tight, secure, and parallel to the floor.

FCC Declaration of Conformity Compliance Statement (Part 15):

Toshiba 32L2400U, 40L2400U, 50L2400U
Television models comply with Part 15 of the FCC
Rules.

Operation is subject to the following two conditions:

- (1) This device may not cause harmful interference, and
 - (2) This device must accept any interference received, including interference that may cause undesired operation.
- The party responsible for compliance to these rules is:

Toshiba America Information Systems, Inc.

9740 Irvine Blvd., Irvine, CA 92618.

Ph: 800-631-3811

Note: *This equipment has been tested and found to comply with the limits for a Class B digital device, pursuant to Part 15 of the FCC Rules. These limits are designed to provide reasonable protection against harmful interference in a residential installation. This equipment generates, uses, and can radiate radio frequency energy and, if not installed and used in accordance with the instructions, may cause harmful interference to radio communications. However, there is no guarantee that interference will not occur in a particular installation. If this equipment does cause harmful interference to radio or television reception, which can be determined by removing and applying power to the equipment, the user is encouraged to try to correct the interference by one of the following measures:*

- Reorient or relocate the receiving antenna.
- Increase the separation between the equipment and receiver.
- Connect the equipment into an outlet on a circuit different from that to which the receiver is connected.
- Consult the dealer or an experienced radio/TV technician for help.

Caution: *Changes or modifications to this equipment not expressly approved by Toshiba could void the user's authority to operate this equipment.*

ENERGY STAR® User Information

ENERGY STAR User Information Statement: the factory default settings of this television meet ENERGY STAR® requirements. Changing Picture Settings may increase energy consumption, possibly beyond the limits required for ENERGY STAR qualification.

To ensure your television is operating at optimal energy efficiency, select [Home] mode during initial activation. To return to [Home] mode settings, select the [Installation] icon from the menu, select [Store / Home Mode], then select [Home]. This places the TV in [Standard] mode. [Standard] mode is recommended for normal home use.



ENERGY STAR® qualified TV. Products that earn the ENERGY STAR prevent green house gas emissions by meeting strict guidelines set by the U.S. Environmental Protection Agency. ENERGY STAR and the ENERGY STAR mark are registered U.S. marks.

Important notes about your TV

The following symptoms are technical limitations of LCD Display technology and are not an indication of malfunction; therefore, Toshiba is not responsible for perceived issues resulting from these symptoms.

- 1) An afterimage (ghost) may appear on the screen if a fixed, non-moving image appears for a long period of time. The afterimage is not permanent and will disappear in a short period of time.
- 2) The LCD panel contained in this TV is manufactured using an extremely high level of precision technology; however, there may be an occasional pixel (dot of light) that does not operate properly (does not light, remains constantly lit, etc.). This is a structural property of LCD technology, is not a sign of malfunction, and is not covered under your warranty. Such pixels are not visible when the picture is viewed from a normal viewing distance.

Note: *Interactive video games that involve shooting a "gun" type of joystick at an on-screen target may not work with this TV.*

Trademark Information

- ColorStream, ColorMaster, DynaLight, GameTimer, Native Mode, Stable Sound, Surflock, TosLink, and TheaterWide are trademarks or registered trademarks of Toshiba America Information Systems, Inc.
- Blu-ray Disc™, Blu-ray™, and the logos are trademarks of the Blu-ray Disc Association.



- For DTS patents, see <http://patents.dts.com>. Manufactured under license from DTS Licensing Limited. DTS, the Symbol, & DTS and the Symbol together are registered trademarks, and DTS TruSurround is a trademark of DTS, Inc. © DTS, Inc. All Rights Reserved.



- Manufactured under license from Dolby® Laboratories. Dolby® and the double-D symbol are trademarks of Dolby® Laboratories.



- The terms HDMI and HDMI High-Definition Multimedia Interface, and the HDMI Logo are trademarks or registered trademarks of HDMI Licensing LLC in the United States and other countries.

- MPEG Layer-3 audio coding technology licensed from Fraunhofer IIS and Thomson.

- This production contains Bitstream Vera Sans fonts under the following copyright: Copyright © 2003 by Bitstream, Inc. All Rights Reserved. Bitstream Vera is a trademark of Bitstream, Inc.

- All other brand and product names are trademarks or registered trademarks of their respective companies.

Copyright

© 2014 by Toshiba America Information Systems, Inc. All rights reserved. Under the copyright laws, this guide cannot be reproduced in any form without the prior written permission of Toshiba. No patent liability is assumed, however, with respect to the use of the information contained herein.

Notice

The information contained in this manual, including but not limited to any product specifications, is subject to change without notice.

TOSHIBA AMERICA INFORMATION SYSTEMS, INC., TOSHIBA OF CANADA LIMITED, AND TOSHIBA DE MEXICO, S.A. DE. C.V. (COLLECTIVELY TOSHIBA) PROVIDES NO WARRANTY WITH REGARD TO THIS MANUAL OR ANY OTHER INFORMATION CONTAINED HEREIN AND HEREBY EXPRESSLY DISCLAIMS ANY IMPLIED WARRANTIES OF MERCHANTABILITY OR FITNESS FOR ANY PARTICULAR PURPOSE WITH REGARD TO ANY OF THE FOREGOING. TOSHIBA ASSUMES NO LIABILITY FOR ANY DAMAGES INCURRED DIRECTLY OR INDIRECTLY FROM ANY TECHNICAL OR TYPOGRAPHICAL ERRORS OR OMISSIONS CONTAINED HEREIN OR FOR DISCREPANCIES BETWEEN THE PRODUCT AND THE MANUAL. IN NO EVENT SHALL TOSHIBA BE LIABLE FOR ANY INCIDENTAL, CONSEQUENTIAL, SPECIAL, OR EXEMPLARY DAMAGES, WHETHER BASED ON TORT, CONTRACT OR OTHERWISE, ARISING OUT OF OR IN CONNECTION WITH THIS MANUAL OR ANY OTHER INFORMATION CONTAINED HEREIN OR THE USE THEREOF.

Contents

Chapter 1: Introduction	16
Features	17
Overview of installation, setup, and use.....	18
TV front and side panel controls and connections....	19
TV back panel connections	20
Chapter 2: Connecting Your TV.....	22
Overview of cable types.....	22
Coaxial (F-type) cable	22
Standard A/V cables (red/white/yellow).....	23
Component video cables (red/green/blue).....	23
HDMI® cable (with HDMI Logo).....	23
Optical audio cable	24
About the connection illustrations	24
Connecting a VCR, antenna, cable TV, or camcorder.....	24
Connecting a Blu-ray™ / DVD player, satellite receiver with ColorStream™ or VCR	26

Connecting an HDMI® or DVI device to the HDMI® input.....	27
HDMI® CEC connection	29
Connecting a digital audio system	31
Connecting a computer	32
Connection to the TV's HDMI® terminal	32
Chapter 3: Using the Remote Control.....	33
Installing batteries	33
Remote control effective range.....	34
Learning about the remote control.....	36
Chapter 4: Menu Layout and Navigation	39
Main menu layout.....	39
Navigating the menu system	41
Chapter 5: Setting up your TV	42
Initial Setup	42
Installation setup selection	43
Storing channels in memory (optional)	44
Auto Tuning	44
Manual Tuning.....	46
Setting channel skip	46
Setting the AV input mode	47
Setting the time zone	47
Viewing the system status	48
Resetting Factory Defaults.....	48
Chapter 6: Setting up your TV	49
Selecting the video input source	49
Labeling the video input sources	51
Tuning channels using the Channel Browser.....	52
Favorites browser.....	53
Elements of the Channel Browser	54
Adding and clearing channels and inputs in the History List	56

Tuning to the next programmed channel.....	56
Tuning to a specific channel (programmed or unprogrammed)	56
Switching between two channels using Channel Return	57
Switching between two channels using SurfLock™	57
Selecting the picture size	58
Full	59
TheaterWide 1	59
TheaterWide 2	59
TheaterWide 3	60
Native	60
4:3	61
Normal	61
Dot by Dot	61
Scrolling the TheaterWide™ picture (TheaterWide 2 and 3 only)	62
Using the Auto Aspect feature	62
Using the 4:3 Stretch	63
Using the FREEZE feature	63
Adjusting the picture	64
Selecting the picture mode	64
Adjusting the picture quality	65
Using closed captions	66
Base closed captions	66
Digital CC settings	67
Adjusting the audio	68
Muting the sound	68
Using the Digital Audio Selection	69
Selecting stereo/SAP broadcasts.....	69
Adjusting the audio quality	70
DTS TruSurround™	71
Sound Mode.....	71
Stable Sound™	71

Using the Dolby® Digital Dynamic Range	
Control feature	71
Selecting the PIN code	72
Enter a new PIN code.....	72
Forgotten PIN code	72
Changing or deleting your PIN code	72
Using parental controls (for USA region).....	72
Blocking TV programs and movies by rating (V-Chip)	72
Downloading an additional rating system	73
Displaying ratings	76
Unlocking programs temporarily.....	76
Using the input lock feature	77
Locking channels	77
Using the GameTimer™.....	78
Using the panel lock feature.....	79
Using the Media Player.....	80
Auto Start function	81
To open the Media Player.....	81
Viewing photo files.....	82
Playing music files	84
Viewing photo files and playing music files at the same time	85
Sorting photo or music files	85
Setting the sleep timer.....	86
No Signal Power Down.....	87
Using HDMI® CEC	87
HDMI® CEC playback device (Blu-ray™/DVD player, etc.) control	87
Other HDMI® CEC functions	89
Setting up HDMI® CEC.....	90
Using the HDMI® settings feature	90
HDMI® 1(or 2) RGB Range	90
HDMI® Information Display	91
Displaying TV status information.....	91
Understanding the last mode memory feature	92

Chapter 7: Using the TV's Advanced Features	93
Using the advanced picture settings	93
ColorMaster™	93
Base Color Adjustment	93
Color Temperature.....	94
Static Gamma.....	94
DynaLight™	95
Dynamic Contrast.....	95
Cinema Mode	95
Noise Reduction	95
Chapter 8: Troubleshooting.....	97
General troubleshooting	97
Picture problems.....	98
Sound problems.....	99
Remote control problems.....	100
Channel tuning problems	100
Closed caption problems.....	101
Rating blocking (V-Chip) problems	101
No HDMI® CEC operation	101
HDMI® problems.....	102
Media Player problems.....	102
If the problem persists after trying the solutions....	102
Appendix A: Specifications	103
Television system	103
Channel coverage.....	103
Power source	104
Power maximum current.....	104
Power consumption	104
Audio power.....	104
Speaker type	104
Video/audio terminals	104
Video/audio input	104
ColorStream™ (component video) HD input....	105

HDMI® input.....	105
Dimensions (with stand)	105
Weight / mass (with stand).....	105
Operating conditions	105
Supplied accessories.....	106
Acceptable signal formats for HDMI®	106
HDMI® signal formats.....	106
Appendix B: Index.....	107

Chapter 1

Introduction

Safety icons

This manual contains safety instructions that must be observed to avoid potential hazards that could result in personal injuries, damage to your equipment, or loss of data. These safety cautions have been classified according to the seriousness of the risk, and icons highlight these instructions as follows:

▲ DANGER Indicates an imminently hazardous situation which, if not avoided, will result in death or serious injury.

▲ WARNING Indicates a potentially hazardous situation which, if not avoided, could result in death or serious injury.

▲ CAUTION Indicates a potentially hazardous situation which, if not avoided, may result in minor or moderate injury.

CAUTION Indicates a potentially hazardous situation which, if not avoided, may result in property damage.

NOTE Provides important information.

Features

The following are just a few of the many exciting features of your new Toshiba wide screen, integrated HD LED TV:

- ❖ **Integrated digital tuning (8VSB ATSC and QAM)**—Eliminates the need for a separate digital converter set-top box (in most cases)
- ❖ **1366 x 768 output resolution (32L2400U)**
1920 x 1080 output resolution (40/50L2400U)
- ❖ **Two HDMI®**—Digital, High-Definition Multimedia Interfaces with 1080p input support. See “Connecting an HDMI® or DVI device to the HDMI® input” on page 27
- ❖ **ColorStream™ HD**—High-resolution component video input and shared composite video input, see “Connecting a Blu-ray™ / DVD player, satellite receiver with ColorStream™ or VCR” on page 26
- ❖ **Digital Audio Out**—Optical audio connection with Dolby® Digital optical output form. See “Connecting a digital audio system” on page 31
- ❖ **DTS TruSurround™**—Delivers an immersive virtual surround sound experience over front facing speaker configurations, complete with rich bass, high frequency detail and clear dialog. For more information, see “DTS TruSurround™” on page 71.
- ❖ **ColorMaster™**—Allows you to adjust the TV’s standard colors, see “ColorMaster™” on page 93
- ❖ **Cinema Mode**—Shows film-like quality movies, see “Cinema Mode” on page 95
- ❖ **DynaLight™**—Backlight control monitors the brightness of each video frame and automatically adjusts backlight intensity based on the content to create higher dynamic contrast, for deeper blacks and increased depth, see “DynaLight™” on page 95
- ❖ **DNR**—Digital picture Noise Reduction, see “Digital Noise Reduction (DNR)” on page 96
- ❖ **Edge Enhancer**—Lets you adjust the levels for your desired picture settings and achieve a sharper picture, see “Edge Enhancer” on page 96
- ❖ **HDMI® CEC**—Allows control of external devices from the TV remote via HDMI® connection, see “Using HDMI® CEC” on page 87
- ❖ **Media Player**—Allows you to view photo files and play music files, see “Using the Media Player” on page 80



❖ **ENERGY STAR® qualified**

Overview of installation, setup, and use

Follow these steps to set up your TV and begin using its many exciting features.

- 1 Carefully read the important safety, installation, care, and service information. Keep this document for future reference.
- 2 To choose a location for the TV:
 - ❖ Read “Important notes about your TV” on page 8
 - ❖ Place the TV on the floor or a sturdy, level, stable surface that can support the weight of the unit. Secure the TV to a wall, pillar, or other immovable structure, see 26) on page 5.
 - ❖ Place the TV in a location where light does not reflect on the screen.
 - ❖ Always leave a space of at least 4 (four) inches around the TV. The slots and openings are provided to protect the TV from overheating and to help maintain reliable operation of the TV.
- 3 Do not plug in any power cords until after you have connected all cables and devices to your TV.
- 4 Before connecting cables or devices to the TV, learn the functions of the TV’s connections and controls, see “Overview of cable types” on page 22
- 5 Connect your other electronic device(s) to the TV, see “Connecting an HDMI® or DVI device to the HDMI® input” on page 27
- 6 Install the batteries in the remote control, see “Installing batteries” on page 33
- 7 See “Using the Remote Control” on page 33 for an overview of the buttons on the remote control.
- 8 After connecting all cables and devices, plug in the power cords for your TV and other devices. Then press the **POWER** button on the TV control panel or remote control to turn on the TV. If the TV stops responding to the buttons on the remote control or TV control panel and you cannot turn the TV off or on, unplug the power cords for a few seconds and then plug them in and try again.
- 9 See “Navigating the menu system” on page 41 for a quick overview of navigating the TV’s menu system.

- 10 Program channels into the TV's channel memory, see "Auto Tuning" on page 44
- 11 For details on using the TV's features, see Chapter 6 and Chapter 7
- 12 For help, refer to "Troubleshooting" on page 97
- 13 For technical specifications, see "Specifications" on page 103
- 14 For the End User License Agreement, see "License Agreement" on page 107

TV front and side panel controls and connections

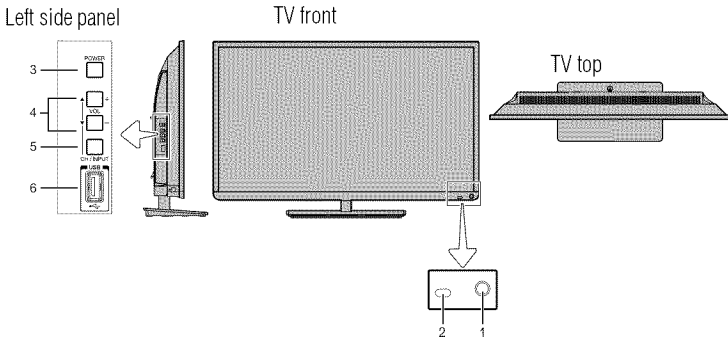

(Sample Illustration) 32L2400U - Front and side panel controls and connections

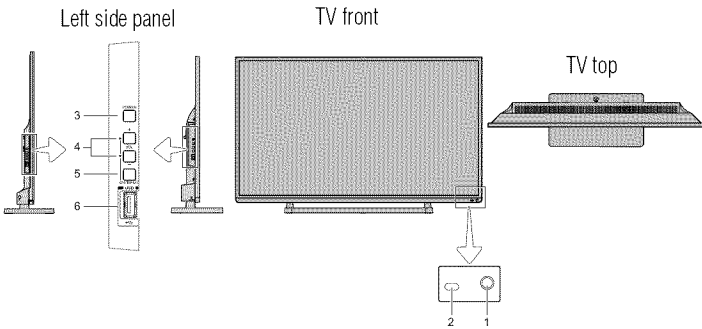

(Sample Illustration) 40/50L2400U - Front and side panel controls and connection

- 1 **Power On/Standby LED**—Power indicator light, (glows red when the TV power is Off).
- 2 **Remote sensor (embedded)**—Point the remote control toward this remote sensor.
- 3 **POWER**—Turns the TV On/Off. If the TV stops responding to the buttons on the remote control or TV control panel and you

cannot turn off the TV, press and hold the **POWER** button on the TV control panel for a few seconds to reset the TV.

- 4 ▲/▼/+/— — Adjust the volume level, change the channel, or change the input or source you are viewing, depending on the mode, which is selected by the **CH/INPUT** button.
- 5 **CH/INPUT**—Switches the function of the ▲/▼/+/— buttons to select the volume, channel, or input mode.
 - In Volume mode, the buttons increase or decrease the volume.
 - In Channel mode, the buttons change the channel up or down.
 - In Source mode, the buttons toggle the input from one source to the next.
- 6 **USB port**—Accesses JPEG or MP3 files, or updates TV firmware.

TV back panel connections

For explanations of cable types and connections, see on page 22.

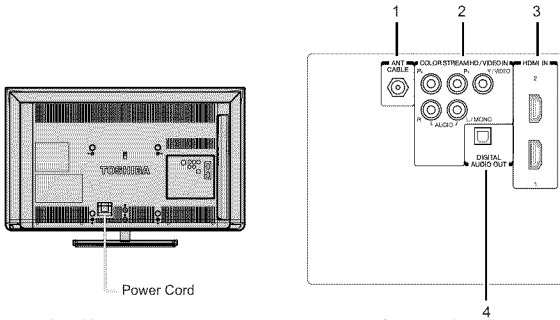

(Sample Illustration) 32L2400U - Back panel connections

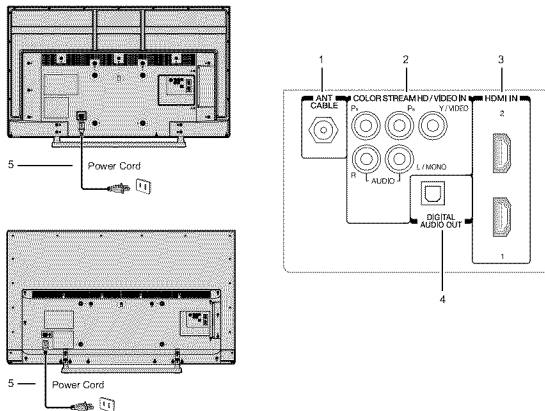

(Sample Illustration) 40/50L2400U - Back panel connections

- 1 **ANT/CABLE**—Antenna input that supports analog (NTSC) and digital (ATSC) off-air antenna signals and analog and digital cable TV (QAM) signals.
- 2 **ColorStream™ HD**—High-resolution component video input and shared composite video input, see “Connecting a Blu-ray™ / DVD player, satellite receiver with ColorStream™ or VCR” on page 26
- 3 **HDMI® IN**—High-Definition Multimedia Interface input receives digital audio and uncompressed digital video from an HDMI® device or uncompressed digital video from a DVI device. HDMI® connection is necessary to receive 1080p signals.
- 4 **Digital Audio out**—Optical audio output in Dolby® Digital, DTS® or PCM (pulse-code modulation) format for connecting an external Dolby® Digital and/or DTS® decoder, amplifier, or home theater system with optical audio input.
- 5 **Power Cord**— Plug one end of the power cord into the jack on the back of the unit, and the other end into a live electrical outlet. (Only for 40/50L2400U models)

CAUTION

The included power cord is for use with this unit only. Do not use it with other equipment.

If you are not going to use the unit for an extended period of time, disconnect the power cord from the wall outlet. Whenever the power cord is plugged into the wall outlet, it will draw some power, even when the unit is off.

NOTE

Component/Standard (composite) video cables carry only video information; separate audio cables are required for a complete connection.

Chapter 2

Connecting Your TV

Overview of cable types

Before purchasing cables, know the connector types your devices require. You can purchase cables from most stores that sell audio/video devices.

Coaxial (F-type) cable



(Sample Illustration) Coaxial cable

Coaxial (F-type) cable connects your antenna, cable TV service, and/or cable converter box to the ANT/CABLE input on your TV.

NOTE

Please tighten this connection by hand. Using tools may damage the connection.

Standard A/V cables (red/white/yellow)

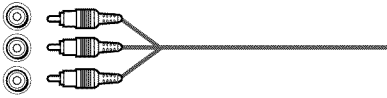

(Sample Illustration) Standard AV cables

Standard A/V cables (composite video) usually come in sets of three, and connect to video devices with analog audio and composite video output. These cables (and the related inputs on your TV) are typically color-coded according to use: yellow for video, red for stereo right audio, and white for stereo left (or mono) audio.

Component video cables (red/green/blue)

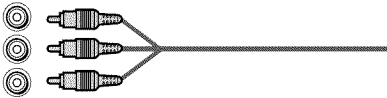

Component video cables (red/green/blue)

Component video cables come in sets of three and connect with video devices with component video output. (ColorStream™ is Toshiba's brand of component video.) These cables are typically color-coded red, green, and blue. Separate audio cables are required for a complete connection.

NOTE Component video cables provide better picture quality than composite video cables.

HDMI® cable (with HDMI Logo)



(Sample Illustration) HDMI® cable

HDMI® (High-Definition Multimedia Interface) cable connects to devices that have an HDMI® output. An HDMI® cable delivers digital audio and video in its native format. Separate audio cables are not required, see “Connecting an HDMI® or DVI device to the HDMI® input” on page 27

NOTE

HDMI® cables provide the best audio and picture quality.

Optical audio cable*(Sample Illustration) Optical audio cable*

Optical audio cable connect receivers with Dolby® Digital, DTS®, or PCM (pulse-code modulation) optical audio input to the TV's Digital Audio Out terminal, see "Connecting a digital audio system" on page 31.

About the connection illustrations

You can connect different types and brands of devices to your TV in several different configurations. The connection illustrations in this manual are representative of typical device connections only. The input/output terminals on your devices may differ from those illustrated herein. For details on connecting and using your specific devices, refer to each device's User's Guide.

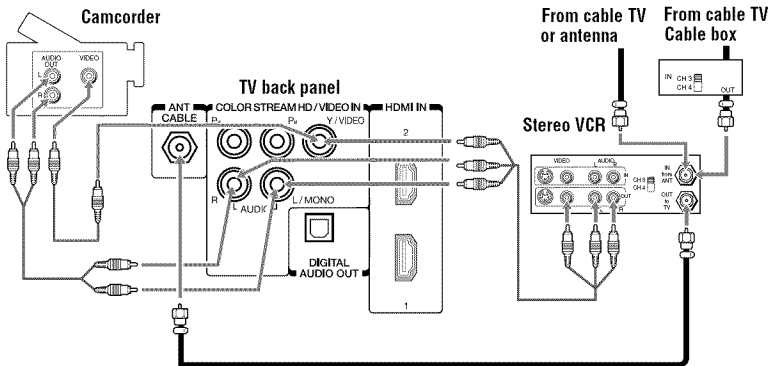
Connecting a VCR, antenna, cable TV, or camcorder

(Sample Illustration) 32/40/50L2400U—Connecting to a VCR, antenna, or cable TV, or camcorder

Items needed:

- ❖ Coaxial cables
- ❖ Standard AV cables
- If you have a mono VCR, connect L/MONO on the TV to your VCR's audio out terminal using the white audio cable only.
- ❖ Standard audio cable

NOTE The menu setting may need to be changed in order to watch the shared input between composite and component video. Composite and component video cannot be used simultaneously.

NOTE When you use a cable box, you may not be able to use the remote control to program or access certain features on the TV. When you use ColorStream™ HD or Video, switch AV input mode appropriately.

To view the antenna or cable signal:

Select **ANT/CABLE** video input source on the TV.*

To view basic and premium cable channels:

Turn off the VCR. Select the **ANT/CABLE** video input source on the TV.* Tune the TV to channel 3 or 4 (whichever channel the cable box output is set to). Use the cable box controls to change channels.

To view the VCR or camcorder video:

Turn on the VCR or camcorder video. Select **VIDEO** input source on the TV.*

*To select the video input source, press the **INPUT** button on the remote control, see “Selecting the video input source” on page 49

NOTE The unauthorized recording, use, distribution, or revision of television programs, videotapes, DVDs, and other materials is prohibited under the Copyright Laws of the United States and other countries, and may subject you to civil and criminal liability.

Connecting a Blu-ray™ / DVD player, satellite receiver with ColorStream™ or VCR

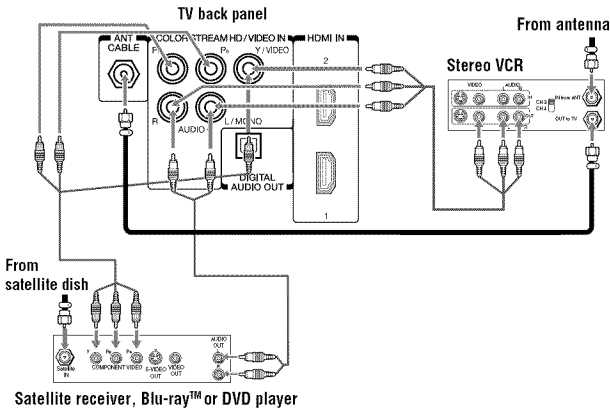

(Sample Illustration) 32/40/50L2400U—Connecting a Blu-ray™ / DVD player or Satellite receiver with ColorStream™ (or VCR).

NOTE ColorStream™ and composite video cables cannot be connected simultaneously.

Items needed:

- ❖ Coaxial cables
- ❖ Standard AV cables
 - If you have a mono VCR, connect L/MONO on the TV to your VCR's audio out terminal using the white audio cable only.
- ❖ Standard audio cables
- ❖ Component video cables
 - ❖ You can connect the component video cables (plus audio cables) from the DVD player or satellite receiver to the COLOR STREAM HD terminal in the TV. The COLOR STREAM HD terminal can be used to display Progressive (480p, 720p) and Interlaced (480i, 1080i) scan systems. Please note that 1080p is not supported. Check the User's Guide of the DVD player in order to determine the best output signal available.
 - ❖ If your DVD player or satellite receiver does not have component video, connect a standard A/V cable to the AUDIO/VIDEO terminal. If your DVD player has HDMI® video, see "Connecting an HDMI® or DVI device to the HDMI® input" on page 27

NOTE When you use ColorStream™ HD or Video, switch AV input mode appropriately.

To view antenna or Cable channels:

Select the **ANT/CABLE** video input source on the TV.*

To view the DVD player:

Turn on the DVD player. Select the **COLORSTREAM HD Video** input source on the TV.*

To view satellite programs using the component video connections:

Turn on the satellite receiver. Select the **COLORSTREAM HD Video** input source on the TV.*

To view the VCR or view and record antenna channels:

Turn on the VCR. Tune the VCR to the channel you want to watch. Select the **VIDEO** input source on the TV.*

To record a TV program while watching a DVD:

Turn on the VCR. Tune the VCR to the channel to record. Select the **COLORSTREAM HD Video** input source on the TV* to view the DVD.

*To select the video input source, press the **INPUT** button on the remote control, see “Selecting the video input source” on page 49

NOTE The unauthorized recording, use, distribution, or revision of television programs, videotapes, DVDs, and other materials is prohibited under the Copyright Laws of the United States and other countries, and may subject you to civil and criminal liability.

Connecting an HDMI® or DVI device to the HDMI® input

The HDMI® input on your TV receives digital audio and uncompressed digital video from an HDMI® source device, or uncompressed digital video from a DVI (Digital Visual Interface) source device.

This input is designed to accept HDCP (High-Bandwidth Digital-Content Protection) program material in digital form from EIA/CEA-861-D-compliant^[1] consumer electronic devices (such as a set-top box or DVD player with HDMI® or DVI output).

The HDMI® input can accept and display various signal formats. For detailed signal specifications, see “HDMI® signal formats” on

page 106. Supported Audio format: Linear PCM, sampling rate 32/44.1/48 kHz.

To connect a computer to the HDMI® input, see “Connection to the TV’s HDMI® terminal” on page 32

To connect an HDMI® device, you will need one HDMI® cable (type A connector) per HDMI® device.

- ❖ For proper operation, it is recommended that you use an HDMI® cable with the HDMI® Logo ()
- ❖ HDMI® cables transfer both video and audio. Separate analog audio cables are not required (see illustration).

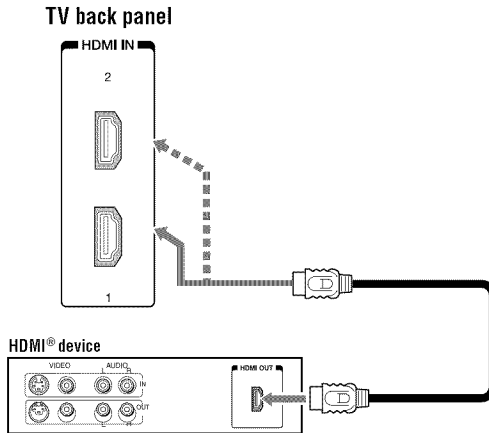

(Sample Illustration) 32/40/50L2400U—HDMI® connections

To view the HDMI® device video:

Select **HDMI 1** or **HDMI 2** video input source on the TV. (Press the **INPUT** button on the remote control. For more information, see “Selecting the video input source” on page 49)

To connect a DVI device, you will need:

- ❖ HDMI® to DVI adapter cable
For proper operation, the length of an HDMI® to DVI adapter cable should not exceed 9.8 ft (3m). The recommended length is 6.6 ft (2m).

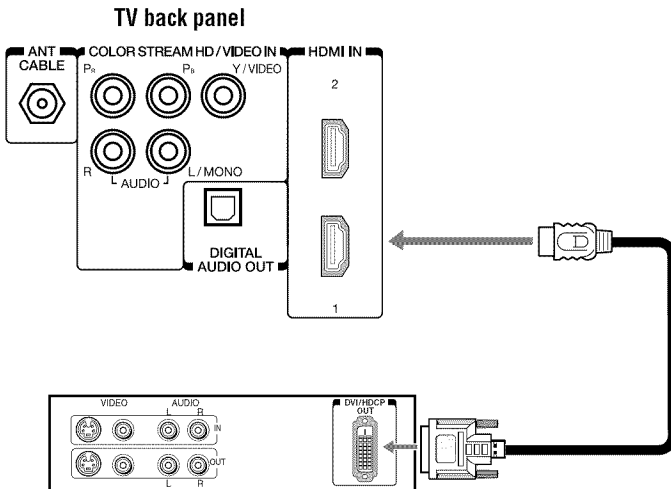

(Sample Illustration) 32/40/50L2400U—DVI connections

NOTE

To ensure that the HDMI® or DVI device is reset properly:

- ❖ When turning on your electronic components, turn on the TV first, and then the HDMI® or DVI device.
- ❖ When turning off your electronic components, turn off the HDMI® or DVI device first, and then the TV.

NOTE

EIA/CEA-861-D compliance covers the transmission of uncompressed digital video with high-bandwidth digital content protection, which is being standardized for reception of high-definition video signals. Because this is an evolving technology, it is possible that some devices may not operate properly with the TV.

HDMI® CEC connection

You can control the basic functions of connected audio/video devices using the TV's remote control if you connect a HDMI® CEC compatible audio receiver or playback device. The HDMI® CEC Control feature uses CEC technology as regulated by the HDMI® standard.

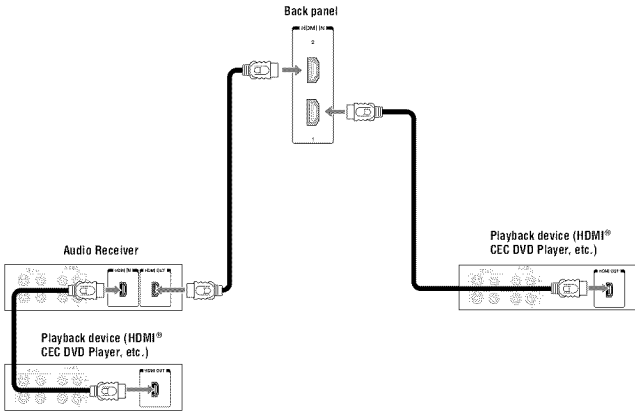

(Sample Illustration) 32/40/50L2400U—HDMI® CEC compatible audio receiver and playback device connections

To connect an HDMI® device, you will need one HDMI® cable (type A connector) per HDMI® device (see “Overview of cable types” on page 22)

- NOTE**
- ❖ If several devices are connected, HDMI® CEC Control feature may not operate properly.
 - ❖ For proper operation, it is recommended that you use an HDMI® cable with the HDMI® Logo ()

Before controlling the device(s):

- ❖ After completing the above connections, configure the HDMI® CEC Setup menu with the desired settings, see “Setting up HDMI® CEC” on page 90
- ❖ The connected devices must also be configured. For details, see the operation manual for each device.
- ❖ This feature uses the CEC technology as regulated by the HDMI® standard.
- ❖ This feature is limited to models incorporating Toshiba’s HDMI® CEC. However, Toshiba is not liable for those operations. Refer to the individual instruction manuals for compatibility information.

- NOTE** This feature may not work properly depending on the devices that are connected.

Connecting a digital audio system

The TV's Digital Audio Out terminal outputs a Dolby® Digital or 2-channel down-mixed PCM (pulse-code modulation) signal for use with an external Dolby® Digital decoder or other external audio system with optical audio input.

You will need an optical audio cable (Use an optical audio cable that has the larger “TosLink™” connector and not the smaller “mini-optical” connector.)

TV back panel

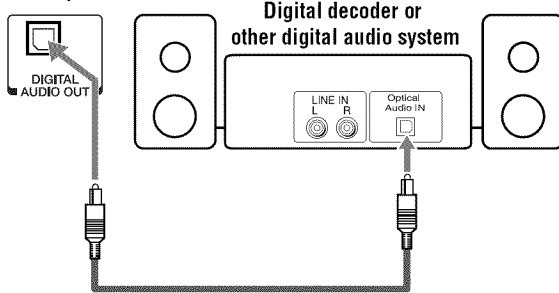

(Sample Illustration) 32/40/50L2400U—Connecting a digital audio system

To control the audio:

- 1 Turn on the TV and the digital audio device.
- 2 Press the **MENU** button on the remote control and open the Sound menu.
- 3 Press the ◀/▶ (arrow) buttons to select **Digital Audio Output** and then press the **ENTER** button.
- 4 Press the ◀/▶ (arrow) buttons to select either **Auto** or **PCM**, depending on your device.

NOTE

Some audio systems may not be compatible with Dolby® Digital or DTS® bitstream signals. Older audio systems that are not compatible with standard optical out signals may not work properly, creating a high noise level that may damage speakers or headphones. THIS DAMAGE IS NOT COVERED BY YOUR WARRANTY. The DIGITAL AUDIO OUT terminal may not output some digital audio sources because of copy restrictions.

❖ The Dolby® Digital or DTS format is available in the following situations:

- When tuned to a digital RF channel
- When an HDMI® input is used
- When network devices are used

Connecting a computer

With HDMI® connection, you can view your computer's display on the TV and hear the sound from the TV's speakers.

Connection to the TV's HDMI® terminal

When connecting a computer with a DVI terminal, use an HDMI®-to-DVI adapter cable and analog audio cables.

When connecting a computer with an HDMI® terminal, use an HDMI® cable (type A connector). Separate analog audio cables may not be necessary, depending on computer hardware and setup, see "Connecting an HDMI® or DVI device to the HDMI® input" on page 27

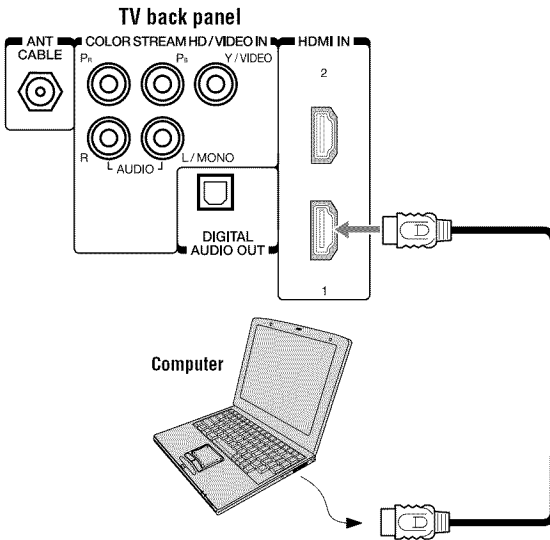

(Sample Illustration) 32/40/50L2400U Series - Connecting a computer to the TV through the HDMI® terminal.

NOTE

- ❖ The edges of the picture may be hidden.
 - ❖ If receiving a 480i (HDMI®), 480p (HDMI®), 720p, 1080i, or 1080p signal program, Native Mode™ scales the video to display the entire picture within the borders of the screen (i.e. no overscan).
-

Chapter 3

Using the Remote Control

Installing batteries

To install batteries :

- 1 Remove the battery cover from the back of the remote control.

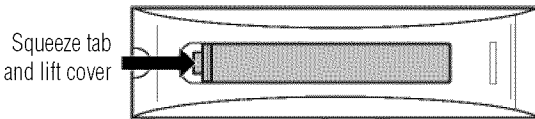

(Sample Illustration) Removing the remote back cover

- 2 Insert two AAA batteries, corresponding to the (+) and (-) markings on the battery compartment.

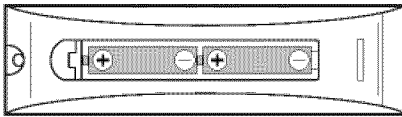

(Sample Illustration) Installing the batteries

- 3 Replace the battery cover.

CAUTION

Do not expose batteries to excessive heat such as sunshine, fire, etc.

NOTE

- ❖ Be sure to use AAA size batteries.
- ❖ Dispose of batteries in a designated disposal area.
- ❖ Always consider the environment when disposing of batteries. Always follow applicable laws and regulations.
- ❖ If the remote does not operate correctly, or if the operating range is reduced, replace the batteries.
- ❖ Always replace both batteries with new ones. Never mix battery types or use new and used batteries together.
- ❖ Always remove batteries from the remote if they are dead or if the remote control is not to be used for an extended period of time. This prevents battery acid from leaking into the battery compartment.

Remote control effective range

For optimum performance, aim the remote control directly at the TV and make sure there is no obstruction between the remote control and the TV.

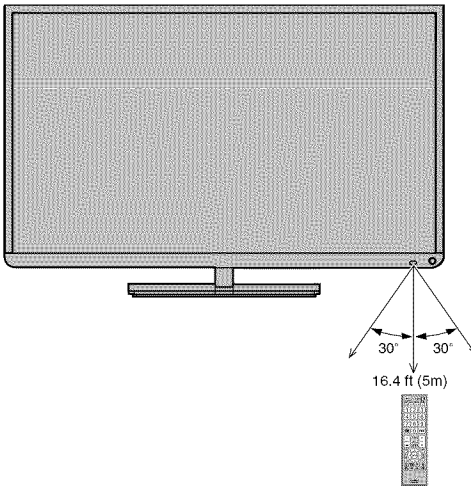

(Sample Illustration) 32L2400U-Remote control effective range

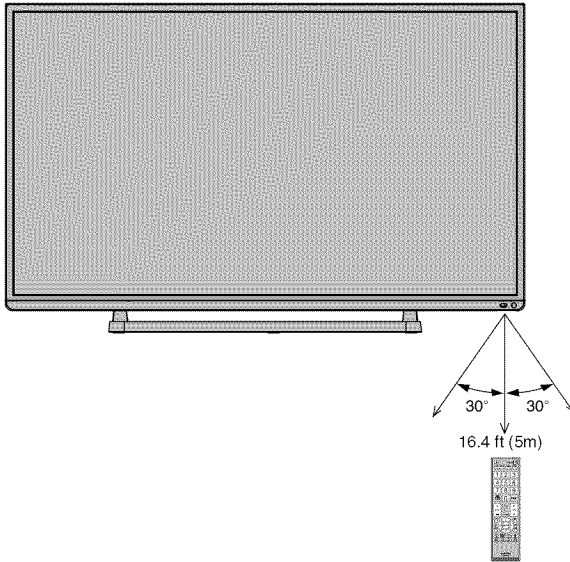

(Sample Illustration) 40/50L2400U-Remote control effective range

Learning about the remote control

The buttons used for operating the TV are described below. For the HDMI® CEC remote control functions, see “HDMI® CEC playback device Blu-ray™/DVD player, etc.) control” on page 87

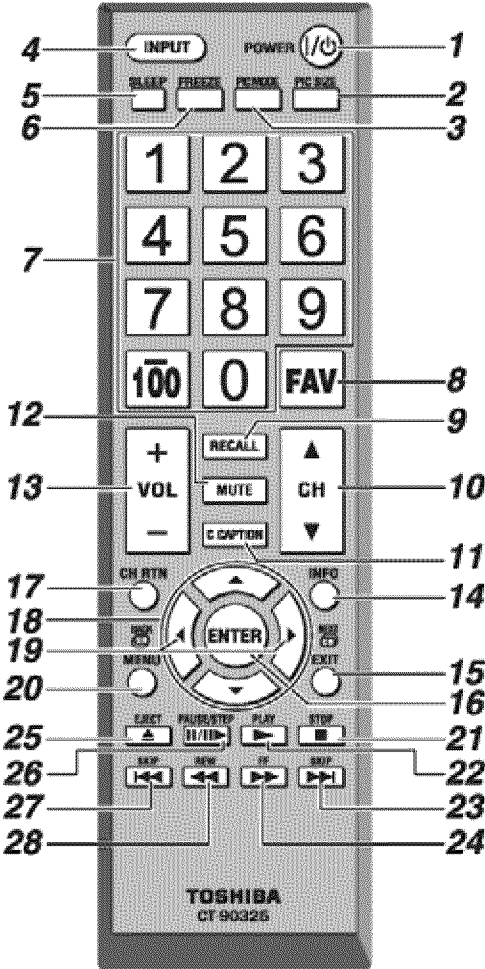

(Sample Illustration) Remote control overview

NOTE The error message “NOT AVAILABLE” may appear if you press a button for a function that is not available.

- 1 The **POWER** button turns the TV **On/Off**. When the TV is off, the power LED indicator on the TV front glows red.
- 2 The **PIC SIZE** button cycles through the picture sizes, see “Selecting the picture size” on page 58
- 3 The **PIC MODE** button selects the picture mode, see “Adjusting the picture” on page 64
- 4 The **INPUT** button selects the video input source, see “Selecting the video input source” on page 49
- 5 The **SLEEP** button accesses the sleep timer, see “Setting the sleep timer” on page 86
- 6 The **FREEZE** button freezes the picture. Press again to restore the moving picture, see “Using the FREEZE feature” on page 63
- 7 The **Channel Number** buttons (**0-9**, and **Dash 100**) directly tune channels. The (**Dash 100**) button allows you to enter two part channel numbers, see “Storing channels in memory (optional)” on page 44 or to edit the Favorites List, see “Favorites browser” on page 53
- 8 The **FAV** button accesses the Favorites List in the Channel Browser, see “Favorites browser” on page 53
- 9 The **RECALL** button displays TV status information.
- 10 The **CH ▲/▼** (arrow) buttons cycle through programmed channels (when no on-screen menu is present), see “Tuning channels using the Channel Browser” on page 52
- 11 The **C. CAPTION** button accesses closed captions, see “Using closed captions” on page 66
- 12 The **MUTE** button reduces or turns off the sound, see “Muting the sound” on page 68
- 13 The **VOL (+ -)** buttons adjust the volume level.
- 14 The **INFO** button displays TV status information as well as program details, when available, see “Displaying TV status information” on page 91
- 15 The **EXIT** button closes on-screen menus.
- 16 The **ENTER** button activates highlighted items in the main menu system.

- 17 The **CH RTN** button returns to the last viewed channel or source, see “Switching between two channels using Channel Return” on page 57
- 18 The **Arrow** buttons (▲/▼/◀/▶) select or adjust programming menus when a menu is on-screen.
- 19 The **Arrow** buttons (◀/▶) open the Channel Browser and tune to the previous/next channel in the channel history when TV programming is on-screen. See “Tuning channels using the Channel Browser” on page 52
- 20 The **MENU** button accesses the main TV menu system. See “Navigating the menu system” on page 41. The following key functions allow you to control Toshiba HDMI® CEC compatible devices via HDMI® connection. See “Using HDMI® CEC” on page 87
- 21 The **STOP** button stops playback of the loaded playback device.
- 22 The **PLAY** button begins playback of the loaded playback device.
- 23 The **SKIP** forward button skips forward to locate later DVD chapters.
- 24 The **FF** button fast-forwards the playback device. (Press during play mode to view the picture moving rapidly forward.)
- 25 The **EJECT** button ejects the DVD or tape.
- 26 The **PAUSE/STEP** button suspends play or record temporarily. Press during play or record mode to pause the picture; press again to restart.
- 27 The **SKIP** reverse button skips to the beginning of the current DVD chapter or locates the previous chapter.
- 28 The **REW** button rewinds/reverses the playback device. (Press during play mode to view the picture moving rapidly backward.)





Chapter 4

Menu Layout and Navigation

Main menu layout

The tables below and on the next pages provide a quick overview of your TV's menu system. To open the menus (illustrated below), press **MENU** on the remote control.

<i>Icon</i>	<i>Item</i>	<i>Option</i>
Picture	Picture Mode	Dynamic / Standard / Movie / Game / PC / Store
		NOTE Store Mode is only available if the TV is set to Store Mode at initial setup. This option is hidden in the Home Mode. NOTE When the TV is set to Store in the initial menu or Store in the Installation Menu, the set will always reset to Store Picture Mode.
	Reset	Reverts to the factory defaults for the selected picture mode
	Backlight	Adjusts Backlight
	Contrast	Adjusts Contrast
	Brightness	Adjusts Brightness
	Color	Adjusts Color
	Tint	Adjusts Tint
	Sharpness	Adjusts Sharpness
	Advanced Picture Settings	Opens the Advanced Picture Settings menu
	Display Settings	Opens the Display Settings menu

<i>Icon</i>	<i>Item</i>	<i>Option</i>
	Sound	
	Balance	Adjusts Balance
	Bass	Adjusts Bass
	Treble	Adjusts Treble
	DTS TruSurround	On / Off
	Sound Mode	Standard/Music/Movie/Clear Voice
	Stable Sound	On / Off
	Dynamic Range Control	On / Off
	TV Speakers	On/Off
	MTS	Stereo / Mono / SAP
	Digital Audio Selection	Offers different audio choices for digital channels
	Primary Audio Language	Primary audio choice for digital channels
	Digital Audio Output	Opens the Digital Audio Output menu
	Options	
	Channel Options	Opens Channel Options menu
	Closed Captions	Opens Closed Captions menu
	MediaShare Setup	Opens MediaShare Setup menu
	HDMI CEC Control Setup	Opens HDMI CEC Control Setup menu
	HDMI CEC Player Control	Opens HDMI CEC Player Control menu
	Input Options	Opens Input Options menu
	Channel Browser Setup	Opens Channel Browser Setup menu
	Power Management	Opens Power Management menu
	Panel Lock	On / Off
	HDMI Information Display	On / Off
	Parental PIN Setup	Opens Parental PIN Setup menu
	Parental Control and Locks	Opens Parental Control and Locks menu
	Installation	
	Menu Language	English / Français / Español
	Time Zone	Eastern / Newfoundland / Atlantic / Hawaii / Alaska / Pacific / Mountain / Central
	Daylight Saving Time	On / Off
	Store / Home Mode	Home / Store
	Channel Tuning	Opens Channel Tuning menu
	Quick Setup	Executes Quick Setup
	Reset TV	Resets to Factory Defaults
	Timers	
	Sleep Timer	10-minute increments, from 0 min to a maximum of 12 hours
	Game Timer	Off/30 min/60 min/90 min/120 min

Icon	Item	Option
Get Help	System Information	Opens the System Information screen
	Auto Demo	Opens Auto Demo menu

NOTE Only available if the TV is set to Store mode.

Navigating the menu system

You can use the buttons on the remote control to access and navigate your TV's on-screen menu system.

- 1 Press the **MENU** button to open the menu system.

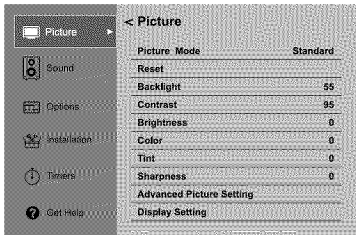

(Sample Image) Navigating the menu system

- 2 When a menu is open, use the **▲/▼/◀/▶** (arrow) buttons on the remote control to move in the corresponding direction in the menu.
- 3 Press the **ENTER** button to save your menu settings or select a highlighted item.
A highlighted menu item appears in a different color in the menu.
- 4 All menus close automatically if you do not make a selection within approximately 60 seconds.
- 5 To close a menu instantly, press the **EXIT** button.

NOTE The menu background may sometimes appear black, depending on the signal the TV is receiving. This is not a sign of malfunction.

Chapter 5

Setting up your TV

Initial Setup

When you first turn on or reset the TV, the Initial Setup window will appear.

- 1 In the **Menu Language** field, press the ◀/▶ (arrow) buttons to select your preferred language.
- 2 Press the ▲/▼ (arrow) buttons to select **Time Zone**. Then set your desired time zone, using the ◀/▶ (arrow) buttons and press the **ENTER** button.
The **Store / Home Mode** settings window appears.
- 3 For normal home use, press the ◀/▶ (arrow) buttons to select **Home**, and then press the **ENTER** button.
The **ANT/CABLE In** setup window appears.
- 4 Press the ◀/▶ (arrow) buttons to select the input source (**Cable** or **Antenna**), and then press the **ENTER** button.
- 5 Press the **ENTER** button to select Start Scan and continue with the Auto Tuning.

You must select a **Language** and either **Home/Store** mode, before you can exit out of the Setup Menu. The **EXIT** button will not function until these selections have been made.

Installation setup selection

Menu language

You can choose from three different menu language settings (English, Français, and Español) for the on-screen display of menus and messages.

To select the menu language:

- 1 Press the **MENU** button and open the **Installation** menu, then highlight **Menu Language**.
- 2 Press the **◀/▶/▲/▼** (arrow) buttons to select your preferred language.

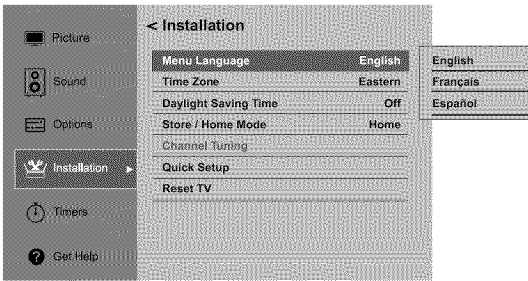

(Sample Image) Selecting the menu language

- 3 Press the **EXIT** button to close the **Installation** menu.

ANT/CABLE IN

This setting configures the input source for the **ANT/CABLE** terminal.

- 1 Press the **MENU** button and open the **Installation** menu.
- 2 Highlight **Channel Tuning**, and then press the **ENTER** button.

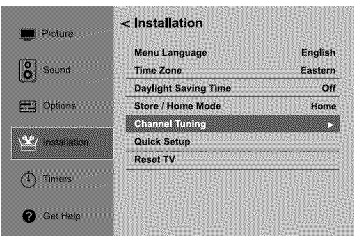

(Sample Image) Installation - Setup selection

- 3 Open the **Channel Tuning** menu, highlight **ANT/CABLE In**, and then press the **ENTER** button.

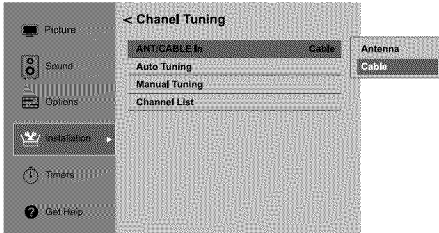

(Sample Image) Channel tuning menu - Input configuration selection

- 4 Press the **▲/▼** (arrow) buttons to select the input source (**Cable** or **Antenna**), and then press the **ENTER** button to save your new settings.

Storing channels in memory (optional)

To make sure your TV stops only on the channels you want when you press the **▲/▼** (arrow) buttons on the remote control or the control panel, store those channels in the TV's memory.

Auto Tuning

You can set up the TV to detect all active channels in your area and store them in its memory. Then you can manually add or erase individual channels from memory.

- NOTE**
- ❖ You must set up the ANT/CABLE input source before programming channels. See "ANT/CABLE IN" on page 43.
 - ❖ The automatic channel programming process will erase channels that were previously programmed into the TV's memory.
 - ❖ To tune the TV to a channel not programmed in the channel memory, you must use the **Channel Number** buttons on the remote control.
 - ❖ Programming channels when the **ANT/CABLE** input is configured for Cable will take substantially longer than when the antenna input is configured for Antenna. This is normal; however, once channel programming is finished, you should not have to repeat the programming process again unless your Cable TV service lineup changes significantly.

To program channels automatically:

- 1 Configure the antenna input source, if you have not already done so, see “ANT/CABLE IN” on page 43.
- 2 Press the **MENU** button and open the **Installation** menu.
- 3 Highlight **Channel Tuning**, and then press the **ENTER** button.

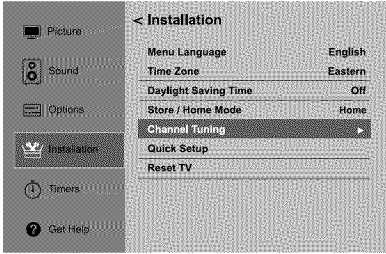

(Sample Image) Setup menu - Installation selection

- 4 Highlight **Auto Tuning**, and then press the **ENTER** button to open the **Channel Program** menu to begin channel programming.

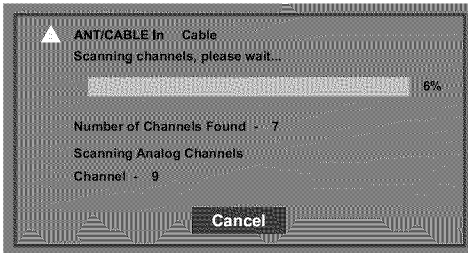

(Sample Image) Installation menu - Channel selection

The TV will automatically cycle through all the antenna/cable channels, and store all active channels in the channel memory. While the TV is cycling through the channels, the message “Scanning channels, please wait” appears.

- 5 To cancel channel programming, press the **EXIT** button on the remote control or highlight **Cancel** in the on-screen display, and then press the **ENTER** button. When channel programming is complete, press the **CH** ▲/▼ (arrow) buttons to view the programmed channels.

Manual Tuning

After storing channels in memory, you can manually enter channels if the physical channel is known.

- 1 Press the **MENU** button and open the **Installation** menu.
- 2 Highlight **Channel Tuning** and then press the **ENTER** button.
- 3 Highlight **Manual Tuning** and then press the **ENTER** button, the **Manual Tuning** form will appear.
- 4 Use buttons 0–9 on the remote control to enter the channel number (for example, 56)
- 5 Press the **ENTER** button to start Manual Tuning.

<i>Type:</i>	<i>Description:</i>
ATV	Analog channel.
DTV	Digital channel.

Setting channel skip

To prevent a channel from being viewed, you can set it to be skipped.

- 1 From the **Options** menu, highlight **Channel Options**, and then press the **ENTER** button.
The list of channels appears.

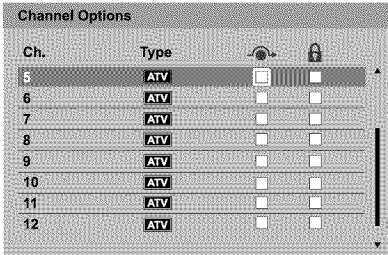

(Sample Illustration) Channel Options

- 2 Press the **▲/▼** (arrow) buttons to select a channel position to be skipped, and then press the **ENTER** button.
A check will appear in the box. To remove the check, press the **ENTER** button again.

To add a channel to the channel memory:

- ❖ Highlight the checked box next to the channel number you wish to add, and then press the **ENTER** button to remove the check.

NOTE You can also block specific channels so that they cannot be tuned until you unlock them. For information, see “Locking channels” on page 77.

To manually add digital sub-channels on a physical channel:

- ❖ Use the Channel Numbers and the **(Dash 100)** on the remote control to enter the channel number (for example, 56-1). If the channel is found, the number will be added to the list and the box will be unchecked. If the channel is not found, a message appears.

NOTE Skipped channels cannot be selected with the **CH ▲/▼** (arrow) buttons; however, they can be accessed using the number keys on the remote control.

Setting the AV input mode

This setting determines the configuration of the shared AV input on your TV. You can set this input for either ColorStream HD or Video. Add the following descriptions:

To set the **AV Input** mode:

- 1 From **Options** menu, highlight **Input Options**, and then press the **ENTER** button.
- 2 Press **▲/▼** (arrow) buttons to select **AV Input**, and then press the **ENTER** button.
- 3 Press **▲/▼** (arrow) buttons to select **Video** or **ColorStream HD**, and then press the **ENTER** button to save your new setting.

Setting the time zone

The Time Zone setup allows you to specify the correct time zone for your region. This feature allows the TV status information to display the correct time zone information for your viewing area.

To set the time zone:

- 1 In the **Installation** menu, highlight **Time Zone**, and press the **ENTER** button.
- 2 Press the **▲/▼** (arrow) buttons to select the region, and then press the **ENTER** button.

To set the Daylight Saving Time status:

- 1 In the **Installation** menu, highlight **Daylight Saving Time**, and press the **ENTER** button.
- 2 Press the **▲/▼** (arrow) buttons to select **On** or **Off**, and then press the **ENTER** button.

Viewing the system status

- 1 In the **Get Help** menu, highlight **System Information**, and then press the **ENTER** button. The related information appears.

To close the screen and return to the **Get Help** menu:

- ❖ Highlight **Done** in the Support Information screen, and then press the **ENTER** button.

To return to normal viewing, press the **EXIT** button.

Resetting Factory Defaults

To reset all settings and channels to their factory default values:

- 1 Press the **MENU** button and open the **Installation** menu.
- 2 Highlight **Reset TV**, and then press the **ENTER** button.
- 3 Enter your PIN code (If a PIN code has been set).
- 4 A confirmation screen appears. Select **Yes**, and press the **ENTER** button. The TV will turn off automatically.

To cancel the reset process, select **No**, and press the **ENTER** button.

Chapter 6

Setting up your TV

Selecting the video input source

To select the video input source to view:

- 1 Press the **INPUT** button on the remote control or TV control panel.
- 2 Do one of the following:
 - ❖ Press 0-3.
 - ❖ Repeatedly press the ▲/▼(arrow) buttons on the remote control, and then press the **ENTER** button to change the input setting.
 - ❖ Repeatedly press the **INPUT** button to cycle through all the inputs. Stop pressing the **INPUT** button when the desired input is selected.

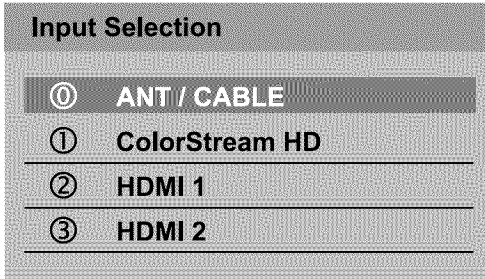

(Sample Image) Input Selection screen

- NOTE**
- ❖ You can label the video input sources according to the specific devices you have connected to the TV, see “Labeling the video input sources” on page 51
 - ❖ Sources can be “hidden,” see “Labeling the video input sources” on page 51
 - ❖ “NO VIDEO” will appear randomly on the screen if no signal is received in video input mode.
 - ❖ If a CEC device is connected to an HDMI® input, the HDMI® CEC icon appears.

If a HDMI® CEC device with HDMI® switching capability (e.g. Audio Receiver) is connected to the HDMI® input, press the **INPUT** button on the remote control repeatedly to highlight **HDMI 1** or **HDMI 2**.

If the connected CEC device has any connected devices, a separate device selection pop-up window appears:

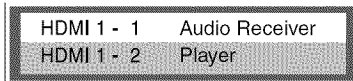

(Sample Illustration) HDMI® setting pop-up window

Press the **INPUT** button repeatedly to highlight the desired input source, and then press the **EXIT** button.

- NOTE**
- ❖ When you select HDMI® CEC input sources from the pop-up window using the **INPUT** button, some HDMI® CEC devices may automatically turn on.

- NOTE** ❖ When selecting input sources using the **CH ▲/▼** (arrow) buttons, you will need to press the **ENTER** button to actually select a particular device from the pop-up window or wait 5 seconds after highlighting desired input.

Labeling the video input sources

You can label each video input source according to the type of device you have connected to each source. Choose from the following preset list of labels:

- ❖ -- (default label)
- ❖ Receiver
- ❖ Cable
- ❖ DVD
- ❖ Game
- ❖ PC
- ❖ Recorder
- ❖ Satellite
- ❖ VCR
- ❖ Blu-Ray
- ❖ Hide (to hide an unused input in the Input Selection screen and in the Channel Browser Inputs list)

To label the video input sources:

- 1 In **Options** menu, highlight **Input Options** and then press the **ENTER** button.
- 2 Highlight **Input Labeling**, and then press the **ENTER** button.
- 3 Press the **▲/▼** (arrow) buttons to highlight the video source you wish to label.
- 4 Press the **◀/▶** (arrow) buttons to select the desired label for that input source. If a particular input is not used, Hide can be selected as the label. This will cause that input to be grayed out in the Input Selection screen and skipped over when you press the **INPUT** button on the remote control.

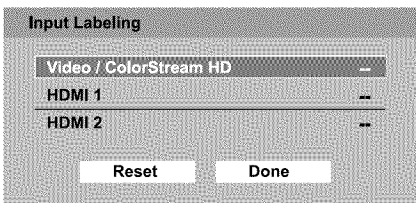

(Sample Image) Input Labeling screen

- 5 To save the new input labels, highlight **Done**, and then press the **ENTER** button.
To revert to the factory default labels, highlight **Reset** and press the **ENTER** button.

Input labeling example:

The screen below left shows the default Input Selection screen (with none of the inputs labeled as a specific device). The screen below (right) is an example of how you can label the inputs if you connected a VCR to ColorStream™ HD, a video recorder to HDMI 1, and a DVD player to HDMI 2.

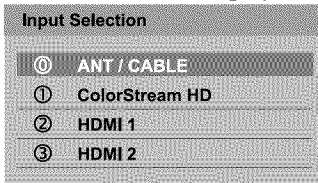

No inputs labeled

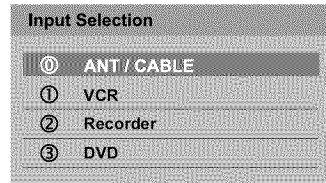

All inputs labeled

(Sample Image) Input selection screens

To clear the input labels:

- 1 In **Options** menu, highlight **Input Options** and then press the **ENTER** button.
- 2 Highlight **Input Labeling**, and then press the **ENTER** button.
- 3 Highlight **Reset**, and then press the **ENTER** button.

Tuning channels using the Channel Browser

The Channel Browser provides an easy navigation interface for all your channels and inputs. This feature allows you to:

- ❖ Navigate and select entries.
- ❖ Keep a list of your favorite channels, see “Favorites browser” on page 53
- ❖ Quickly surf and tune your recently viewed channels/inputs from the Channel Browser History List.
- ❖ Surf via Browse mode (to immediately tune channels as you highlight them in the Channel Browser) or Select mode (to surf over channels in the Channel Browser before you select one to tune).
- ❖ Quickly change inputs from the Inputs List.
- ❖ Quickly select HDMI® CEC devices from the HDMI® CEC List.

Favorites browser

The Favorites Browser allows you to quickly set up a favorite channels/inputs list that is integrated into the Channel Browser.

To add a favorite channel/input:

- 1 Tune to the channel or input.
- 2 Press and hold the **FAV** button for a few seconds.

NOTE

The channel or input is added to the beginning of the Favorites list on the left side of the Channel Browser.

To delete a favorite channel/input:

- 1 Press the **FAV** button to open the Favorites browser list.
- 2 Highlight the channel or input to delete by pressing **BACK CB** or **NEXT CB** arrow buttons.
- 3 Press and hold the **(Dash 100)** button for a few seconds. The channel/input will be removed from the Favorites list.

To set up the Channel Browser:

- 1 In the **Options** menu, highlight **Channel Browser Setup**, and then press the **ENTER** button.
- 2 Press the **▲** (arrow) button to highlight **Navigation**, and then press the **◀/▶** (arrow) buttons to select either **Browse Mode** or **Select Mode**.

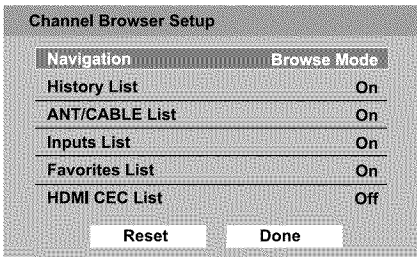

(Sample Image) Channel browser setup screen

- 3 Press the **▼** (arrow) button to highlight **History List**, **ANT/CABLE List**, **Input List**, **Favorites List** or **HDMI CEC List**, and then press the **◀/▶** (arrow) buttons to select **On** or **Off**.

NOTE

- ❖ The History List will be cleared every time the TV is powered off.
- ❖ HDMI® CEC List is automatically grayed out and set to **Off** when **Enable HDMI® CEC** is switched to **Off**. See "Using HDMI® CEC" on page 87

- 4 To save the new entries, highlight **Done**, and then press the **ENTER** button.
 To return to factory defaults, highlight **Reset**, and then press the **ENTER** button.

To open the Channel Browser:

- ❖ Press **BACK CB** or **NEXT CB** arrow buttons on the remote control.
- ❖ Press the **BACK CB** arrow button to surf backward through the previously tuned channels in the History list, the channels in the ANT/CABLE channel list, the inputs in the Inputs list, the favorite channels/inputs in the Favorites list, or the HDMI® CEC devices in the HDMI® CEC List.
- ❖ Press the **NEXT CB** arrow button to surf forward through the channel History, the ANT/CABLE channel list, the Inputs list, the favorite channels/inputs in the Favorites list, or the HDMI® CEC List.

Elements of the Channel Browser

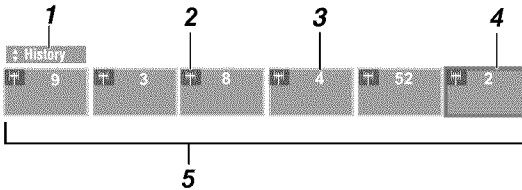

(Sample Illustration) Channel Browser elements

- 1 Current list (**History, ANT/CABLE, Inputs, Favorites, or HDMI® CEC**).
- 2 Channel or input type.
- 3 Channel or input currently being viewed.
- 4 Channel or input that is currently highlighted in the browser.
- 5 Channels stored in the Current List.

To toggle among the available lists:

After opening the Channel Browser, press the ▲/▼ (arrow) buttons to toggle through the **History**, **ANT/CABLE**, **Inputs**, **Favorites**, or **HDMI CEC** options.

-
- NOTE**
- ❖ The Channel Browser opens in History List by default. Once another list has been selected, the Channel Browser will open in the last selected list.
 - ❖ If all lists are turned off, pressing **BACK CB** or **NEXT CB** arrow buttons or the **FAV** button will not display the Channel Browser. If Favorites List is turned off, the **FAV** button will have no effect.
 - ❖ Pressing the **FAV** button will display the Channel Browser Favorites list regardless of the last selected list in the Channel Browser.
-

To tune to a channel or input in Browse mode:

- 1 While watching TV, press **BACK CB** or **NEXT CB** arrow buttons to display the Channel Browser and surf back to a previous item or surf forward to the next item in the list. In Browse mode, when you stop on an item in the Channel Browser, it is highlighted and the TV automatically tunes to the channel or input.
- 2 Press the **EXIT** button to close the Channel Browser.

To tune to a channel or input in Select mode:

- 1 While watching TV, press **BACK CB** or **NEXT CB** arrow buttons to display the Channel Browser and surf back to a previous item or surf forward to the next item in the list. In Select mode, when you stop on an item in the Channel Browser, it is highlighted, but the TV is not turned to the channel until you press the **ENTER** button.
- 2 Press the **ENTER** button to tune the TV to the highlighted item.
- 3 Press the **EXIT** button to close the Channel Browser.

Adding and clearing channels and inputs in the History List

As a channel or input is tuned, the Channel Browser adds it to the History List and displays it on the right side of the Channel Browser. Previously tuned channels/inputs are shifted to the left, eventually moving off the left side. Press the **BACK CB** arrow button to surf backward through the previously tuned channels/inputs. Any channel or input that is tuned repeatedly will not be repeated in the History List, but instead is moved to the end of the list on the right side of the Channel Browser.

- ❖ All channels that are tuned using the numeric buttons on the remote control.
- ❖ All channels that are tuned using the ◀/▶ (arrow) buttons on the remote control.

NOTE Whenever an item is selected that cannot be tuned (for various reasons), the TV will automatically tune to the previously viewed channel or input.

Clearing channels from the History List:

- ❖ Reconfiguring the ANT/CABLE input will clear the History List. see “ANT/CABLE IN” on page 43
- ❖ Turning off the TV will clear the History List.

Tuning to the next programmed channel

To tune to the next programmed channel, press the ◀/▶ (arrow) buttons on the remote control or TV control panel.

NOTE This feature will not function until you have programmed channels into the TV's channel memory, see “Storing channels in memory (optional)” on page 44

Tuning to a specific channel (programmed or unprogrammed)

To tune analog channels:

Press the Channel Number (0–9) on the remote control. For example, to select channel 125, press 1, 2, 5, and then press the **ENTER** button.

Tuning digital channels:

Press the Channel Number (0–9) on the remote control, followed by the **(Dash 100)** button, and then the sub-channel number. For example, to select digital channel 125-1, press 1, 2, 5, –, 1, and then press the **ENTER** button.

NOTE If a digital channel is not programmed, either through the automatic channel scan or the Channel add function, see “Auto Tuning” on page 44, you will have to tune the RF channel using the Channel Numbers and the (**Dash 100**) button on the remote control.

Switching between two channels using Channel Return

The Channel Return feature allows you to switch between two channels without entering an actual channel number each time.

- 1 Select the first channel you want to view.
- 2 Select a second channel using the **Channel Number** buttons (and the (**Dash 100**) button if selecting a digital channel).
- 3 Press the **CH RTN** button on the remote control. The previous channel will display. Each time you press the **CH RTN** button, the TV will switch back and forth between the last two channels that were tuned.

NOTE If you press the **CH RTN** button from a non-antenna input, the TV will return to the last-viewed input.

Switching between two channels using SurfLock™

The SurfLock™ feature temporarily “memorizes” one channel to the **CH RTN** button, so you can return to that channel quickly from any other channel by pressing the **CH RTN** button.

To memorize a channel to the **CH RTN** button:

- 1 Tune the TV to the channel you wish to program into the **CH RTN** button.
- 2 Press and hold the **CH RTN** button for a few seconds until the message “Memorized” appears on the screen. The channel has been programmed to the **CH RTN** button.
- 3 You can then change channels repeatedly, and when you press the **CH RTN** button, the memorized channel will be tuned.

The TV will return to the memorized channel one time only. Once you press the **CH RTN** button and then change channels again, the **CH RTN** memory will be cleared and the button will function as Channel Return, by switching back and forth between the last two channels that are tuned. This feature also works for external inputs.

Selecting the picture size

You can view many program formats in several picture sizes—Native, 4:3, Full, TheaterWide 1, TheaterWide 2, TheaterWide 3, Normal, and Dot by Dot.

NOTE

The picture size illustrations are examples only. The format of the image (in any of the picture sizes) depends on the format of the signal you are currently watching. Select the picture size that displays the current program in the way that looks best to you.

You can save separate picture size preferences for each input on your TV.

To select the picture size:

- 1 Press the **PIC SIZE** button on the remote.
 - 2 With the **Picture Size** menu displayed, do one of the following:
 - ❖ Repeatedly press the **PIC SIZE** button.
 - ❖ Press the corresponding number button (0-5) while the **Picture Size** menu is displayed.
 - ❖ Press the **▲/▼** (arrow) buttons while the Picture Size menu is displayed.
-

NOTE

Some of the picture sizes may not be available depending on the receiving signal format (those will be grayed out in the Picture Size screen).

NOTE

Using these functions to change the picture size (i.e., changing the height/width ratio) for any purpose other than your private viewing may be prohibited under the Copyright Laws of the United States and other countries, and may subject you to civil and criminal liability.

NOTE

If you select a TheaterWide™ picture size, the top and bottom edges of the picture (including subtitles or captions) may be hidden. To view these edges, adjust the Picture Position or try viewing the program in 4:3 or Full, see “Scrolling the TheaterWide™ (TheaterWide 2 and 3 only)” on page 62

Full

The Full setting is for viewing in the 16:9 (480i, 480p) source programs. If receiving a squeezed 4:3 format program, the picture is stretched horizontally to fill the width of the screen but not stretched vertically.

The Full setting is for viewing in 1080i, 1080p, and 720p program source.

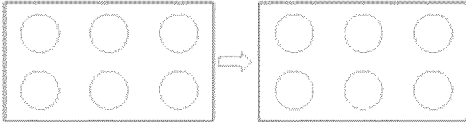

(Sample Illustration) Picture size - Full

The edges of the picture may be hidden.

TheaterWide 1

This setting is for viewing 4:3 format programs.

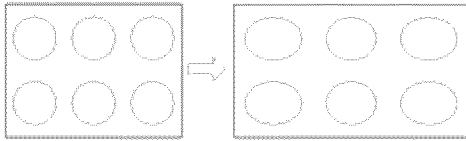

(Sample Illustration) Picture size - TheaterWide 1

The center of the picture remains close to its original proportion, but the left and right edges are stretched horizontally to fill the screen.

TheaterWide 2

This setting is for viewing letter box programs.

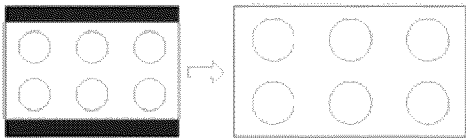

(Sample Illustration) Picture size - TheaterWide 2, letter box

The picture's top and bottom edges may be hidden*.

TheaterWide 3

This setting is for viewing letter box programs with subtitles.

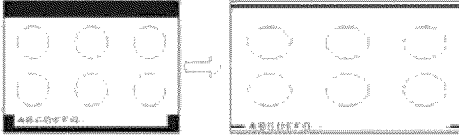

(Sample Illustration) Picture size - TheaterWide 3, letter box with subtitles

The picture's top and bottom edges are hidden*.

* To view the hidden areas (such as subtitles or captions), see “Scrolling the TheaterWide™ picture (TheaterWide 2 and 3 only)” on page 62

Native

These settings are for viewing in 480i (HDMI®), 480p (HDMI®), 720p, 1080i, and 1080p signal programs).

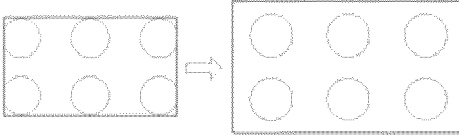

(Sample Illustration) Picture size - Native

- ❖ If receiving a 1080i, 1080p, 720p, 480i (HDMI®), or 480p (HDMI®) signal program, the video is scaled to display the entire picture within the borders of the screen (i.e. no over-scanning).
- ❖ This is especially useful for external HD sources such as DVD movies, Video Games, or computer graphics.

NOTE

- ❖ The Native mode is supported only for HDMI® (1080i, 1080p, 720p, 480i, and 480p), ColorStream™ (1080i and 720p), and ANT/CABLE (digital) inputs (1080i, 1080p, and 720p).
- ❖ Depending on the input signal, the picture's border may be hidden, displayed in black, or noisy.

4:3

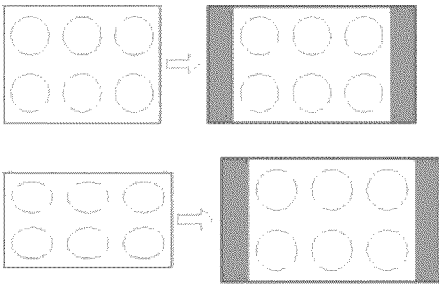

(Sample Illustration) Picture size - 4:3

Some program formats will display with sidebars and/or bars at the top and bottom.

Normal

This setting is for viewing VGA, SVGA, XGA, WXGA, and SXGA sources.

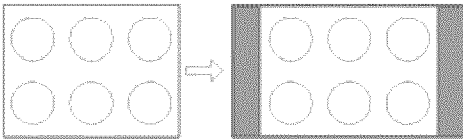

(Sample Illustration) Picture size - Normal

This size is a non-stretched display. Some input signal formats will display with sidebars and/or bars at the top and bottom.

Dot by Dot

This setting is for viewing VGA, SVGA, XGA, WXGA, and SXGA sources.

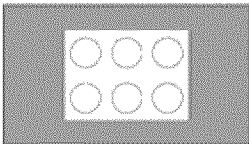

(Sample Illustration) Picture size - Dot by Dot

Dot by Dot is a non-scaling display. Depending on the input signal format (VGA, for example) the picture may appear with sidebars and/or bars at the top and bottom.

Scrolling the TheaterWide™ picture (TheaterWide 2 and 3 only)

You can set separate scroll settings for the TheaterWide 2 and TheaterWide 3 modes for each input.

To set the scroll settings:

- 1 In the **Picture** Menu, highlight **Display Settings**, and then press the **ENTER** button.
- 2 Highlight **Picture Position**, and then press the **ENTER** button. (The **Picture Position** will be available when **Picture Size** is **TheaterWide 2** or **TheaterWide 3**.)



(Sample Image) Picture menu - Theater Settings selection

- 3 The **Picture Position** screen will appear, press **◀/▶** (arrow) button to scroll the picture up and down as needed.
- 4 To save the new settings, highlight **Done**, and then press the **ENTER** button.
To revert to the factory defaults, highlight **Reset** and then press the **ENTER** button.
The adjustment range is from **-5** to **+10**.

NOTE

When receiving a signal at 480i resolution, the picture scroll function may have limited adjustment range.

Using the Auto Aspect feature

When this feature is set to On, the TV will automatically select the picture size when one of the following input sources is received:

- ❖ A 480i, 480p, 720p, 1080i digital signal from the ANT/CABLE input.
- ❖ 480i, 480p, 720p, 1080i, 1080p, or VGA (60Hz) signal from the HDMI® inputs.

<i>Aspect Ratio of Signal Source</i>	<i>Automatic Aspect Size (automatically selected when Auto Aspect is On)</i>
4:3 Normal	4:3
4:3 Letter Box	TheaterWide 2
16:9 Full	Full
Not defined (no ID-1 data or HDMI® aspect data)	The current picture size you selected, see “Selecting the picture size” on page 58

To turn on the auto aspect ratio feature:

- 1 Press the **MENU** button and open the **Picture** menu.
- 2 Highlight **Display Settings**, and then press the **ENTER** button.
- 3 In the **Auto Aspect** field, press the **ENTER** button, and then select **On**.

To turn off the Auto Aspect ratio feature, Select **Off** in step 3 above.

Using the 4:3 Stretch

When 4:3 Stretch is activated, the TV displays 4:3 programs as a full-screen picture.

- 1 From the **Picture** menu, highlight **Display Settings**, and then press the **ENTER** button.
- 2 Press the **▲/▼** (arrow) buttons to select 4:3 Stretch, and then press the **ENTER** button.
- 3 Press the **▲/▼** (arrow) buttons to select **On** or **Off**, and then press the **ENTER** button

NOTE This feature is available when **Auto Aspect** is set to **On**.

Using the FREEZE feature

To use the FREEZE feature:

- 1 When watching the TV, press the **FREEZE** button to freeze the picture.
- 2 To unfreeze the picture, press the **FREEZE** button again (or any other button).

NOTE Using the FREEZE function for any purpose other than your private viewing may be prohibited under the Copyright Laws of the United States and other countries, and may subject you to civil and criminal liability.

NOTE If the TV is left in FREEZE mode for more than 15 minutes, the FREEZE mode will automatically release and the TV returns to normal video.

Adjusting the picture

Selecting the picture mode

You can select your desired picture settings from the modes described below.

<i>Mode:</i>	<i>Description:</i>
Dynamic	Maximizes Contrast, Color Saturation, Sharpness, Gray Scale, and Brightness to create more vivid and dynamic images.
Standard	Standard picture settings.
Movie	Lower contrast for darkened rooms.
Game	Optimized for playing video games by displaying the images in their purest form (4:4:4) without the loss of color information. The result is superior image quality and shorter signal to screen time for a faster gaming experience
PC	Optimized for viewing your personal computer.

NOTE Store Mode is only available if the TV is set to Store Mode at initial setup. This option is hidden in the Home Mode. When the TV is set to **Store** in the initial menu or **Store** in the Installation Menu, the set will always reset to **Store** Picture Mode.

NOTE PC mode is available for HDMI® only (grayed out for other input sources).

To select the picture mode using the menu system:

- 1 Press the **MENU** button and open the **Picture** menu.
- 2 Highlight **Picture Mode**, and then press the **ENTER** button.

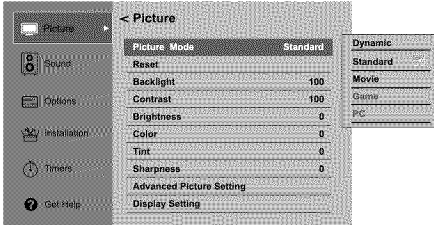

(Sample Image) Picture menu - Mode selection

- 3 Press the **▲/▼** (arrow) buttons to select the picture mode you prefer, and then press the **ENTER** button.

Adjusting the picture quality

You can adjust the picture quality (Contrast, Backlight, DynaLight™, Brightness, Color, Tint, and Sharpness.) to your personal preferences.

Selection	Press (◀)	Press (▶)
Backlight*	darker	lighter
Contrast	lower	higher
Brightness	darker	lighter
Color	paler	deeper
Tint	reddish	greenish
Sharpness	softer	sharper

* Backlight: adjusts the brightness of the entire screen. When in video mode and no signal is input, this selection is automatically set to 0. (Settings are stored in memory.)

To adjust the picture quality:

- 1 Press the **MENU** button and open the **Picture** menu.
- 2 Press the **▲/▼** (arrow) buttons to select the picture quality you wish to adjust (Backlight, Contrast, Brightness, Color, Tint, or Sharpness), press the **ENTER** button. Then press the **◀/▶** (arrow) buttons to adjust the setting.

To reset to the factory defaults:

- 1 Press the **MENU** button.
 - 2 Select **Picture ► Reset**.
 - 3 Press the **ENTER** button. A confirmation screen appears.
 - 4 Press the **▲/▼** (arrow) buttons to select **Yes**, and then press **ENTER**.
-

NOTE

Any picture setting that you adjust affects the current input only. You can adjust the picture quality separately for each input. Depending on a Sharpness value, the Edge Enhancer effect may be reduced.

Using closed captions

Base closed captions

Closed caption mode has two options:

- ❖ **Captions**—An onscreen display of the dialogue, narration and sound effects of TV programs and videos that are closed captioned (usually marked “CC” in program guides).
- ❖ **Text**—An onscreen display of information not related to the current program, such as weather or stock data (when provided by individual stations).

To view captions or text:

- 1 In **Options** menu, highlight **Closed Captions**, and then press the **ENTER** button.
- 2 In the **Closed Caption Display** field, select **On**.
- 3 In the **Analog CC Mode** field, select the desired closed caption mode, and then press the **ENTER** button.

To view captions, highlight **CC1**, **CC2**, **CC3**, or **CC4**.

(CC1 displays translation of the primary language in your area.)



(Sample Illustration) Viewing captions

NOTE If the program or video you selected is not closed captioned, no captions will display onscreen.

To view text, highlight **T1**, **T2**, **T3**, or **T4**.

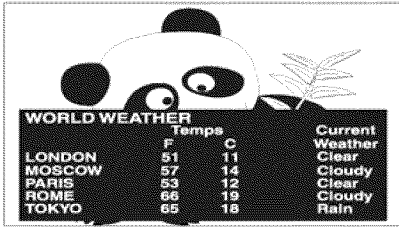

(Sample Illustration) Captions - text

NOTE If text is not available in your area, a black rectangle may appear on screen. If this happens, set the Base CC Mode to **Off**.

To turn off closed caption mode, select **Off** in step 2 above.

NOTE A closed caption signal may not display in the following situations:

- ❖ When a recording has been dubbed
- ❖ When the signal reception is weak
- ❖ When the signal reception is non-standard

Digital CC settings

You can customize the closed caption display characteristics by changing the background color, opacity, text size, type, edge, and color.

NOTE

- ❖ These settings are available for digital channels only.
- ❖ You cannot set Caption Text and Background as the same color.

To customize closed captions:

- 1 In **Options** menu, highlight **Closed Captions**, and then press the **ENTER** button.

- 2 Highlight **Digital CC Settings**, and then press the **ENTER** button.
- 3 Press the **▲/▼** (arrow) buttons to highlight the characteristic you wish to change, and then press the **◀/▶** (arrow) buttons to select the format for that characteristic.
- 4 To save the new settings, highlight **Done**, and then press the **ENTER** button.
To revert to the factory defaults, highlight **Reset**, and then press the **ENTER** button.

<i>Mode:</i>	<i>Description</i>
Caption Size	Auto, Small, Standard, Large
Caption Text Type	Auto, Default, Mono (with Serif), Prop. (with Serif), Mono (without Serif), Prop. (without Serif), Casual, Cursive, Small Capitals
Caption Text Edge	Auto, None, Raised, Depressed, Uniform, Left Drop Shadow, Right Drop shadow
Caption Text Color	Auto, Black, White, Red, Green, Blue, Yellow, Magenta, Cyan
Text Foreground Opacity	Auto, Transparent, Translucent, Flashing, Solid
Background Color	Auto, Black, White, Red, Green, Blue, Yellow, Magenta, Cyan Magenta, Cyan
Text Background Opacity	Auto, Transparent, Translucent, Flashing, Solid
Caption Text Edge Color	Auto, Black, White, Red, Green, Blue, Yellow, Magenta, Cyan

Adjusting the audio

Muting the sound

Press the **MUTE** button to partially reduce (1/2 Mute) or turn off (Mute) the sound. Each time you press the **MUTE** button, the mute mode changes in the following order: 1/2 Mute, Mute, Volume, 1/2 Mute, etc.



(Sample Image) Levels of mute

NOTE If you modify items in the **Sound** menu while Mute is active, Mute is cancelled.

Using the Digital Audio Selection

You can use the **Digital Audio Selection** to conveniently switch between audio tracks on a digital channel (for those channels that have multiple audio tracks). This temporarily overrides the audio track chosen by the **Primary Audio Language** option under the **Sound** menu, see “Selecting stereo/SAP broadcasts” on page 69

- 1 Press the **MENU** button and open the **Sound** menu.
- 2 Highlight **Digital Audio Selection**, and then press the **ENTER** button.

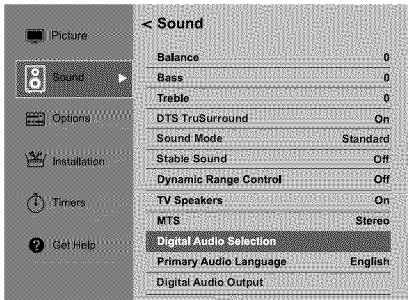

(Sample Image) Sound menu - Digital Audio Selector selection

- 3 Press the ◀/▶ (arrow) buttons to select the desired service.
- 4 Press the **EXIT** button.

Selecting stereo/SAP broadcasts

The multi-channel TV sound (MTS) feature allows you to output high-fidelity stereo sound. MTS also can transmit a second audio program (SAP) containing a second language, music or other audio information (when provided by individual stations).

When the TV receives a stereo or SAP broadcast, the icon **Stereo** or **SAP** appears when the **INFO** button is pressed. The MTS feature is only available for analog signals on the ANT/CABLE input.

To listen in stereo sound:

- 1 Press the **MENU** button and open the **Sound** menu.
- 2 Highlight **MTS**, and then press the **ENTER** button.
- 3 Select **Stereo**, and then press the **ENTER** button.

-
- NOTE**
- ❖ You can typically leave the TV in Stereo mode because it outputs the type of sound being broadcast (stereo or monaural).
 - ❖ If the sound is noisy, select Mono to reduce the noise.
-

To listen to an alternate language on an ATSC digital station (if available), highlight the **Primary Audio Language** field in step 2 above, and then press the ◀/▶ (arrow) buttons to select the language you prefer.

To listen to a second audio program on an analog station, if available, select **SAP** in step 2 above.

- NOTE**
- ❖ A second audio program (SAP) can be heard only on those TV stations that offer it. For example, a station might broadcast another language as a second audio program. If you have SAP on, you will see the current program on the screen but hear the other language instead of the program's normal audio.
 - ❖ If you have SAP on and the station you are watching is not broadcasting a second audio program, the station's normal audio will be output. However, occasionally there is no sound at all in SAP mode. If this happens, set the MTS feature to Stereo mode.
-

Adjusting the audio quality

You can adjust the audio quality by adjusting the bass, treble and balance.

To adjust the audio quality:

- 1 Press the **MENU** button and open the **Sound** menu.
- 2 Press the ▲/▼ (arrow) buttons to highlight the item you wish to adjust (Bass, Treble, or Balance), and then press the **ENTER** button.
- 3 Press the ◀/▶ (arrow) buttons to adjust the level.
 - ❖ ◀ makes the bass or treble weaker or increases the balance in the left channel (depending on the item selected).
 - ❖ ▶ makes the bass or treble stronger or increases the balance in the right channel (depending on the item selected).

DTS TruSurround™

This technology delivers an immersive virtual surround sound experience over front facing speaker configurations, complete with rich bass, high frequency detail and clear dialog.

To turn on **DTS TruSurround™**:

- 1 Press the **MENU** button and open the **Sound** menu.
- 2 Highlight **DTS TruSurround** field, and then press the **ENTER** button.
- 3 Press the **▲/▼** (arrow) buttons to select **On**, and then press the **ENTER** button

Sound Mode

Select the **Sound Mode** your prefer.

To select a **Sound Mode**:

- 1 Press the **MENU** button and open the **Sound** menu.
- 2 Highlight **Sound Mode** field, and then press the **ENTER** button.
- 3 Press the **▲/▼** (arrow) buttons to select one of **Sound Mode**, and then press the **ENTER** button.

Stable Sound™

The **Stable Sound™** feature limits high volume levels and prevents the extreme changes in volume that can occur when channels are changed or a program switches to a commercial.

To turn on **Stable Sound™**:

- 1 Press the **MENU** button and open the **Sound** menu.
- 2 Highlight **Stable Sound**, and then press the **ENTER** button.
- 3 Press the **▲/▼** (arrow) buttons to select **On**.

Using the Dolby® Digital Dynamic Range Control feature

You can further compress Dolby® Digital dynamic range, allowing you to switch from digital to analog broadcasts at the same dynamic range.

To use the Dolby® **Digital Dynamic Range Control**:

- 1 Press the **MENU** button and open the **Sound** menu.
- 2 Highlight **Dynamic Range Control**, and then press the **ENTER** button.
- 3 Press the **▲/▼** (arrow) buttons to select **On**, and then press the **ENTER** button.

- NOTE** ❖ This feature is available when the TV is tuned to a digital RF channel or an HDMI® input with the Dolby® Digital signal.
-

Selecting the PIN code

A PIN code is necessary for some menus.

- NOTE** ❖ The Parental Control and Locks menu is grayed out if no PIN has been set.
-

Enter a new PIN code

- 1 Press the **MENU** button and open the **Options** menu.
- 2 Highlight **Parental PIN Setup**, and then press the **ENTER** button.
- 3 Use the number buttons to enter a 4-digit number. Confirm the code.

Forgotten PIN code

While the PIN code entering screen is displayed, press the **INFO** button four times within five seconds. The PIN code will be cleared and you can enter a new PIN code.

Changing or deleting your PIN code

- 1 Press the **MENU** button and open the **Options** menu.
- 2 Highlight **Parental PIN Setup**, and then press the **ENTER** button.
- 3 Use the number button to enter a 4-digit number.
- 4 Select Change PIN or Delete PIN. Press the **ENTER** button.

Using parental controls (for USA region)

Blocking TV programs and movies by rating (V-Chip)

Some TV programs and movies include signals that classify the content of the program (as unsuitable for younger viewers). The V-Chip feature in this TV detects the signals and blocks the programs according to the ratings you select.

- 1 Press the **MENU** button and open the **Options** menu.
- 2 Highlight **Parental Control and Locks**, and then press the **ENTER** button.
- 3 Enter your four-digit PIN code.

- 4 Press the ▲/▼ (arrow) buttons to highlight **Enable Rating Blocking**, and press **ENTER** button.
- 5 Press the ▲/▼ (arrow) buttons to select **On**, and then press the **ENTER** button.

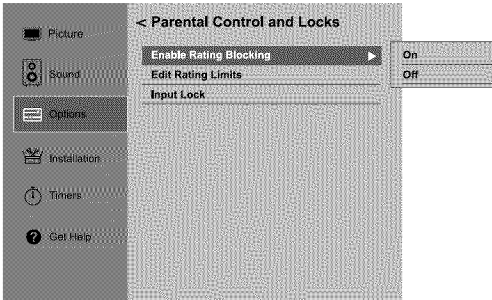

(Sample Image) Locks menu - Enable Rating Blocking selection

- 6 Press the ▼ (arrow) button to highlight **Edit Rating Limits**, and then press the **ENTER** button. The Edit Rating Limits screen appears.
- 7 For each desired selection, press the ▲/▼/◀/▶ (arrow) buttons to highlight the selection, and then press the **ENTER** button to select it.
A box with an “X” is a rating that will be blocked. As you highlight a rating, a definition for the rating appears at the bottom of the screen.
- 8 To save the new settings, highlight **Done**, and then press the **ENTER** button.

NOTE This feature will be not available if no PIN code is set.

Downloading an additional rating system

In the future, an additional rating system may become available for use in selectively blocking TV programs and movies.

NOTE The currently tuned station must be receiving a digital signal before an additional rating system can be downloaded.

To download the additional rating system, if available:

- 1 Press the **MENU** button and open the **Options** menu.
- 2 Highlight **Parental Control and Locks**, and then press the **ENTER** button.
- 3 Enter your four-digit PIN code.

- 4 Press the ▲/▼ (arrow) buttons to highlight **Enable Rating Blocking**, and press the **ENTER** button.
 - 5 Press the ▲/▼ (arrow) buttons to select **On**, and then press the **ENTER** button.
 - 6 Press the ▼ (arrow) button to highlight **Edit Rating Limits**, and then press the **ENTER** button.
The Edit Rating Limits screen appears.
 - 7 Highlight **Alt RS**, and then press the **ENTER** button.
The Edit Alternate Ratings screen appears.
-

- NOTE**
- ❖ The **ALT RS** button will only be available if an additional rating system is currently available.
 - ❖ It may take several minutes for the TV to download the additional rating system.
 - ❖ The information displayed in the Alternate Ratings screen will depend on the configuration of the additional rating system available at the time of download.
-

- 8 For each desired selection, press the ▲/▼/◀/▶ (arrow) buttons to highlight the selection, and then press the **ENTER** button to select it.
A box with an “X” is a rating that will be blocked.
 - 9 To save the new settings, highlight **Done**, and then press the **ENTER** button.
 - 10 In the Edit Rating Limits screen, highlight **Done**, and then press the **ENTER** button.
-

- NOTE**
- ❖ The additional rating system can only be downloaded one time. You will not be able to download any updates to the rating system should such updates become available.
 - ❖ The additional rating system is not designed, transmitted or controlled by the TV or Toshiba, nor is the availability of an additional rating system determined or controlled by Toshiba. Similarly, the rating of programs in an additional rating system is not determined, transmitted or controlled by the TV or Toshiba.
 - ❖ The additional rating system is an evolving technology; therefore, availability, content and format may vary.
-

Rating system

Independent rating system for broadcasters:

<i>Ratings:</i>	<i>Description and Content themes:</i>
TV-MA	Mature Audience Only (This program is specifically designed to be viewed by adults and therefore may be unsuitable for children under 17. L) Crude or indecent language S) Explicit sexual activity V) Graphic violence
TV-14	Parents Strongly Cautioned (This program contains some material that many parents would find unsuitable for children under 14 years of age.) D) Intensely suggestive dialogue L) Strong, coarse language S) Intense sexual situations V) Intense violence
TV-PG	Parental Guidance Suggested (This program contains material parents may find unsuitable for younger children.) D) Some suggestive dialogue L) Infrequent coarse language S) Some sexual situations V) Moderate violence
TV-G	General Audience (Most parents would find this program suitable for all ages)
TV-Y7, TV-Y7FV	Directed to Older Children (This program is designed for children age 7 and above. NOTE: Programs in which fantasy violence may be more intense or more combative than other programs in this category are designated TV-Y7FV.)
TV-Y	All Children (This program is designed to be appropriate for all children)

Independent rating system for movies:

<i>Ratings:</i>	<i>Description and Content themes:</i>
X	X-rated (For adults only)
NC-17	Not intended for anyone 17 and under
R	Restricted (Under 17 requires accompanying parent or adult)
PG-13	Parents Strongly Cautioned (Some material may be inappropriate for children under 13)
PG	Parents Guidance Suggested (Some material may be not be suitable for children)
G	General Audience (Appropriate for all ages)

Indication other than rating system:

<i>Display:</i>	<i>Description:</i>
TV-NONE	TV None
MPAA N/A	Movie Not Applicable
NOT RATE	Movie Not Rated
(No rating appears)	No rating information is provided

NOTE If you place an "X" in the box next to "None" Rated, programs rated "None" or "Not Rated" will be blocked; Programs that do not provide any rating information will not be blocked.

Displaying ratings

To display the rating of the program you are watching, press the **INFO** button on the remote control. If it is rated "None" the word "NONE" appears in the **INFO** screen. If rating information is not provided, no rating will appear in the **INFO** screen.

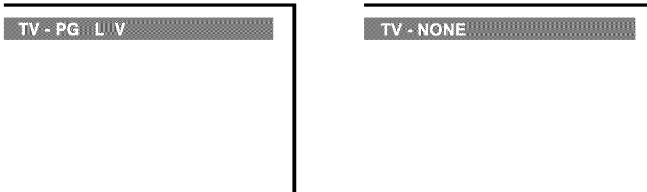

(Sample Image) Rating Info screens

Unlocking programs temporarily

If you try to tune to a program that exceeds the rating limits you have set, the TV will enter program lock mode and a warning message appears on the screen.

This program exceeds the rating limit you set.
Push " MUTE " to enter PIN.

(Sample Illustration) Warning - exceeded rating limit

You can either temporarily unlock the program or select an unlocked program to watch.

To temporarily unlock the program:

- 1 Press the **MUTE** button.

- 2 Enter your four-digit PIN code, and then press the **ENTER** button.

If the correct code is entered, the program lock mode is released and the normal picture appears. All locking will be enabled again when you change the channel.

Using the input lock feature

You can use the Input Lock feature to lock the video inputs (Video, ColorStream™ HD, HDMI 1 and HDMI 2). You will not be able to view the input sources you unlock the inputs.

To lock/unlock the video inputs:

- 1 In the **Options** menu, highlight the **Parental Control and Locks**, and then press the **ENTER** button.
- 2 Enter your four-digit PIN code.
- 3 Highlight **Input Lock**, and then press the **ENTER** button.
- 4 Press the **▲/▼** (arrow) buttons to select the level of video input locking you prefer (see table below for descriptions), and then press the **ENTER** button.

<i>Mode:</i>	<i>Description:</i>
Video	Locks Video, ColorStream™ HD, HDMI 1 and HDMI 2.
Video+	Locks Video, ColorStream™ HD, HDMI 1, HDMI 2 and channels 3 and 4. Select Video+ if you play video tapes via an ANT/CABLE input.
Off	Unlocks all video inputs.

Locking channels

With the Lock feature, you can lock specific channels. Locked channels can only be accessed by entering the PIN code, see “Enter a new PIN code” on page 72

To lock channels:

- 1 From the **Options** menu, highlight **Channel Options**, and then press the **ENTER** button.

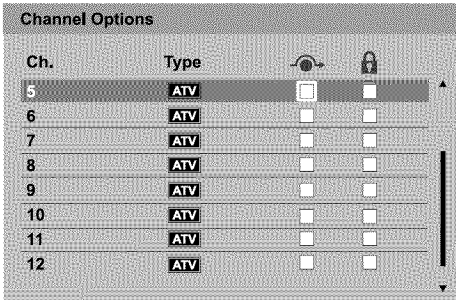

(Sample Illustration) Channel options

- 2 Press the ▲/▼ (arrow) buttons to select a channel in the lock column.
- 3 Press the **ENTER** button. PIN code entry will be required to set a locked channel.

NOTE If the PIN code has not yet been set, a warning message appears.

- 4 A check appears in the box.
- 5 To remove the check, press the **ENTER** button.
- 6 Press the **EXIT** button.

Using the GameTimer™

You can use the GameTimer™ to set a time limit for playing a video game (30–120 minutes). When the GameTimer™ expires, the TV enters Input Lock mode and locks out the input source for the video game device.

To set the GameTimer™:

- 1 In the **Timers** menu, highlight **GameTimer**, and then press the **ENTER** button.
- 2 Enter your four-digit PIN code.
- 3 Press the ▼ (arrow) button to select 30, 60, 90 or 120 minutes, and then press the **ENTER** button.

To cancel the GameTimer™, select **Off** in step 3 above.

To deactivate the Input Lock once the GameTimer™ has activated it:

- ❖ Set the Input Lock to **Off**, see “Using the input lock feature” on page 77

- NOTE**
- ❖ A message appears when 10 minutes, 3 minutes, and 1 minute are remaining.
 - ❖ If the TV loses power with time remaining, the TV will enter Input Lock mode when power is restored (as if the GameTimer™ had been activated). To resume use, you must deactivate the Input Lock, see “Using the input lock feature” on page 77

Using the panel lock feature

You can lock the control panel to prevent your settings from being changed accidentally (by children, for example). When Panel Lock is set to **On**, none of the controls on the control panel operate except the **POWER** button.

To lock the control panel:

- 1 In the **Options** menu, highlight **Panel Lock**, and then press the **ENTER** button.
- 2 Enter your four-digit PIN code.
- 3 Press the **▼** (arrow) button to select **On**.

When the control panel is locked and any button on the control panel (except the **POWER** button) is pressed, the message “NOT AVAILABLE” appears.

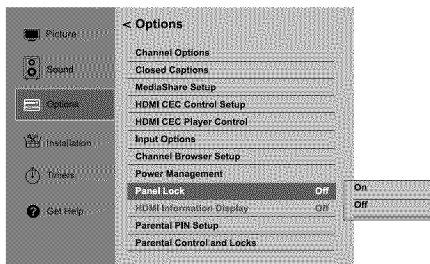

(Sample Illustration) Locks menu - Panel Lock selection

To unlock the control panel, select **Off** in Step 3 in this section or press and hold the **VOLUME (-)** button on the TV control panel for approximately 15 seconds until the volume icon appears.

Using the Media Player

Using Media Player with a USB device

You can enjoy photo or music content stored on a USB storage device.

Photo Viewer specifications:

- ❖ Data type: JPEG EXIF ver 2.1
- ❖ File format: JPEG
- ❖ Maximum photo size: 6 MB
- ❖ Maximum number of files: 500/folder
- ❖ Maximum photo resolution: 4096 x 4096 pixels

Music Player specifications:

- ❖ File format: MP3
- ❖ Sampling frequency: 32 kHz, 44.1 kHz, 48 kHz
- ❖ Bit rate: from 32 to 320 kbps
- ❖ Maximum number of files: 500/folder

Supported file system: FAT16 and FAT32

NOTE

- ❖ Gently insert the USB device into the port and do not remove while viewing Media Player.
 - ❖ USB device: USB Mass Storage Class device (MSC)
 - ❖ Connectivity is not guaranteed for all devices.
 - ❖ Connect the USB device to the TV directly.
 - ❖ Do not use a USB Hub.
 - ❖ You must obtain any required permission from copyright owners to use copyright content. Toshiba cannot and does not grant such permission.
 - ❖ Depending on the file size and amount in your USB storage device, it may take some time to load before content is viewable. A message will display on-screen when files are loading from the USB storage device.
 - ❖ Only limited types of U3 USB device are supported. Therefore, it is suggested that you not use U3 USB with Media Player.
 - ❖ Non-supported characters will be replaced with a square.
-

Auto Start function

When Auto Start is enabled, you will be asked if you want to start the Media Player when a USB device is inserted. If Auto Start is disabled, you must manually start the Media Player from the menu. To change the Auto Start setting:

- 1 In the **Options** menu, highlight **MediaShare Setup**, and then press the **ENTER** button.
- 2 Press the **▲/▼** (arrow) buttons to highlight **USB Auto Start**.
- 3 Press the **◀/▶** (arrow) buttons to select **On** or **Off**.

To open the Media Player

There are two methods for starting the Media Player: auto start and manual start.

Auto Start:

- 1 Gently insert a supported USB storage device to the USB port on the back of the TV. A prompt will appear.

NOTE If you repeatedly insert and remove the USB connector, the prompt may not appear.

- 2 Press the **◀/▶** (arrow) buttons to select **Yes**, and then press the **ENTER** button.
The Media Player menu appears. (If you select **No**, nothing happens.)

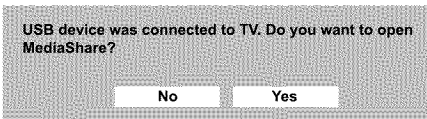

(Sample Image) Media Player - open screen

NOTE

- ❖ The prompt will disappear after about 10 sec.
- ❖ If Auto Start is set to **Off**, you can start the Media Player manually.

Manual Start:

- 1 In the **Options** menu, highlight **MediaShare Setup**, and then press the **ENTER** button.
- 2 Press the **▲/▼** (arrow) buttons to highlight **Photo** or **Music**, and then press the **ENTER** button.

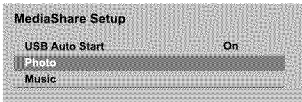

(Sample Image) Media Play screen

- NOTE**
- ❖ The viewer will open even if there are no photo or music files.
 - ❖ While the Media Player is active, the main menu cannot be displayed.

Viewing photo files

There are three types of view modes: multi view, single view, and slide show. Within Slide show, you can skip forward, repeat, and set time interval.

Multi View

This view allows you to search for photos in a grid format. These pictures are displayed using thumbnail data in each image file.

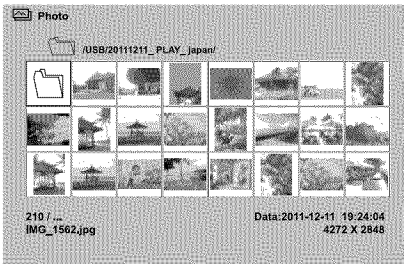

(Sample Image) Media Play - photos screen

To use multi view:

Press the ▲/▼/◀/▶ (arrow) buttons to move the highlight in one window. If all of the photos will not fit in one screen, the screen will move to the previous page when you press ◀ from the top left thumbnail. When you press ▶ from the bottom right thumbnail, the screen will move to the next page. You can also use the ▲/▼ (arrow) buttons to page up or down the in photo list when there are more photos than will fit on one screen.

- 3 When you select a folder, press the **ENTER** button to move to the next layer, or press the **CHRTN** button to return to the previous layer.

- 4 Press the **ENTER** button to view the selected photo in Single View mode.

Single view

In this view mode, only files located in the selected directory will be displayed. This view allows you to change the photo content manually. When you move from Multi View to the Single View, the currently selected photo is displayed.

To use single view:

- ❖ Press the **▶** (arrow) button to view the next photo. Press **◀** to view the previous photo.
- ❖ Press **▲** to rotate the image 90° counterclockwise. Press **▼** to rotate the image 90° clockwise.

Slide show

This view allows you to watch a slide show of the photos. In this mode, only files located in the selected directory will be played.

To use slide show:

- 1 Press the **ENTER** button in the Single View mode.
- 2 Press the **◀/▶** (arrow) buttons to view the previous or next photo.

To set Interval Time and Repeat settings:

- 1 Press the **MENU** button to open the **Quick Menu**.
- 2 Press the **▲/▼** (arrow) buttons to select either **Interval Time** or **Repeat**.
- 3 Press the **◀/▶** (arrow) buttons to adjust the setting and press the **CH RTN** button.

NOTE Zoom and Picture size functions are disable.

To close the Photo Viewer, press the **EXIT** button. The television will return to the last viewed channel or external input.

Playing music files

You can listen to music from a list of available files. When listening to music files, you can select music lists, play, pause, stop, skip, repeat play, and adjust sound settings.

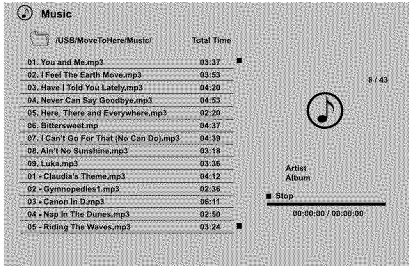

(Sample Image) Media Play - music list

After opening Media Player and selecting Music (see “To open the Media Player” on page 81) press the ▲/▼ (arrow) buttons to select a file or folder. You can use the ▲/▼ (arrow) buttons to page up or down the music list when there are more files than will fit onto one screen.

- 4 Select the desired folder and press the **ENTER** button to move to the next layer. Press the **CH RTN** button to move back to the previous layer.
- 5 With the desired file selected, press the **ENTER** button or the **PLAY** button to start playback.
- 6 Press the **STOP** button to stop playback

- NOTE**
- ❖ If playback finishes before **STOP** is pressed, the next file will automatically start to play from the beginning.
 - ❖ Depending on the file size, it may take some time for playback to begin.

During playback you can do the following:

- ❖ Press **PAUSE** to pause.
- ❖ To resume normal playback, press **PLAY**.
- ❖ To locate a specific file, press the **SKIP Reverse** or **SKIP Forward** button repeatedly.
- ❖ To adjust volume, press the **VOL (+ -)** buttons.

- NOTE** To play in fast reverse or fast forward, press **REV** or **FF** during playback. Each time you press **REV** or **FF**, the playback speed changes.

NOTE During playback, you can adjust the **Sound** menu functions from the Quick Menu.

To set the repeat mode:

- 1 Press the **MENU** button to open the **Quick Menu**.
- 2 Press the **▲/▼** (arrow) buttons to select **Repeat**.
- 3 Press the **◀/▶** (arrow) buttons to select **Off**, **All** or **1**.
- 4 Press **CH RTN**.

To close the Music Player, press **EXIT**.

Viewing photo files and playing music files at the same time

While viewing photo files, you can listen to music from a list of available files.

- 1 While viewing photos in the **Single View** or **Slide Show** mode, press the **MENU** button to open the **Quick Menu**.
 - 2 Highlight **Background Music** and press the **ENTER** button.

The music list appears.

- 3 **Select a music file and press the ENTER button to start playback.**
- 4 Press **CH RTN** twice to move back to photo view mode. The music is now playing in the background.

Sorting photo or music files

From the photos Multi View or from the music list, you can sort your photo or music folders and files.

To sort photo or music folders and files:

- 1 From photo Multi View mode or from the music list, press the **MENU** button to open the **Quick Menu**.
- 2 Press the **▲/▼** (arrow) buttons to select **Sort**.
- 3 Press the **◀/▶** (arrow) buttons to select **Title**, **New**, or **Old** to set the sorting rule.

Title-File sorting rules:

- ❖ Unicode priority

- ❖ Numerical (0-9), Uppercase (A-Z), lowercase (a-z), Chinese
- ❖ Increasing order

New-From new to old according to the date and time when the picture was taken.

Old-From old to new according to the date and time when the picture was taken.

NOTE

During playback, you can adjust the **Sound** menu functions from the Quick Menu.

NOTE

The Sorting or Total Time display display may not be available in all cases.

Setting the sleep timer

You can set the sleep timer to turn off the TV after a set length of time (maximum of 12 hours).

To set the sleep timer using the remote control:

- 1 Press the **SLEEP** button on the remote control to set the length of time until the TV turns off.
- 2 Repeatedly press the **SLEEP** button to increase the time in 10-minute increments, or press the **▲/▼**(arrow) buttons to increase or decrease the time in 10-minute increments, to a maximum of 12 hours.

To set the sleep timer using the on-screen menus:

- 1 In **Timers** menu, highlight **Sleep Timer**, and then press the **ENTER** button.

Press the **Number** buttons to enter the length of time (maximum of 12 hours) and then press the **ENTER** button. Or press the **▲/▼**(arrow) buttons to increase or decrease in 10-minute increments (maximum of 12 hours).

NOTE

If a power failure occurs, the sleep timer setting may be cleared.

To display the time remaining until the TV turns off, press the **SLEEP** button.

To cancel the sleep timer, repeatedly press **SLEEP** until it is set to 0 minutes.

No Signal Power Down

The TV will automatically turn itself off after 15 minutes when no signal is detected. You can change the setting to Off for the following purposes:

- ❖ Low signal strength of analog channel (no signal detection)
- ❖ Only Audio L/R is connected to external input to listen to music through the TV speakers.

To change the no signal power down setting:

- 1 From the **Options** menu, highlight **Power Management**, and then press the **ENTER** button.
- 2 Highlight **No Signal Power Down**, and then press the **ENTER** button.
- 3 Press the **▲/▼** (arrow) buttons to highlight the item you want to change, and press the **◀/▶** (arrow) buttons to select **On** or **Off**.

NOTE

- ❖ Default setting for this feature is **On**.
 - ❖ A warning message will appear 1 minute before the TV turns off.
-

Using HDMI® CEC

This is a new feature that uses CEC technology and allows you to control Toshiba HDMI® CEC compatible devices from the TV remote via HDMI® (see “HDMI® CEC connection” on page 29)

When **Enable HDMI CEC Control** in the **HDMI CEC Control Setup** menu is set to **On** (see “Setting up HDMI® CEC” on page 90), the HDMI® CEC functions described below will be enabled.

HDMI® CEC playback device (Blu-ray™/DVD player, etc.) control

With your TV’s remote control, or using the HDMI® CEC Player Control menu, you can control the connected HDMI® CEC playback device you are watching.

Available remote control key functions

<i>Button:</i>	<i>Description:</i>
PLAY	Begin playback
STOP	Stop playback
PAUSE	Pause the picture during play or record mode
SKIP Forward	Skip Forward
SKIP Reverse	Skip backward

<i>Button:</i>	<i>Description:</i>
FF	Fast forward
REW	Rewind/reverse
▲/▼/◀/▶	Navigates menu options
ENTER	Enters menu options
EXIT	Return to the previous menu

NOTE These functions depend on the devices connected.

HDMI® CEC Player Control menu functions

To control the HDMI® CEC player from the menu:

- 1 From the **Options** menu, highlight **HDMI CEC Player Control**, and then press the **ENTER** button.

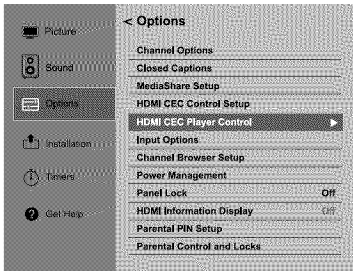

(Sample Image) Preferences menu - HDMI® CEC Player Control

- 2 Press the ▲/▼ (arrow) buttons to select the item you wish to control and press the **ENTER** button.

<i>Item:</i>	<i>Description:</i>
Power	Turns the select device On/Off
Root Menu	Accesses the root menu of the selected device
Contents Menu	Accesses the contents list when you press ENTER . At this time, the HDMI CEC Player Control menu disappears.
Setup Menu	Accesses the setup menu of a selected device
Top Menu	Accesses the top menu of a selected device
Menu	Accesses the menu of a selected device

NOTE These functions depend on the devices that are connected. The HDMI® CEC Player Control item will be grayed out in the following conditions:

- ❖ A non-HDMI® input is currently selected.
 - ❖ The **Enable HDMI CEC** item is set to **Off**.
 - ❖ The connected CEC device is not a playback or recording device.
-

HDMI® CEC input source selection

If a HDMI® CEC device with HDMI® switching capability (e.g. Audio Receiver) is connected to the HDMI® input, you can select another HDMI® CEC device that is connected to the master HDMI® device using the TV's **INPUT** button, see "Selecting the video input source" on page 49

VOLUME and MUTE controls of Audio Receiver

With your TV's remote control, you can adjust or mute the sound volume of the Audio Receiver.

- ❖ **VOL (+ -)** buttons adjust the volume level.
- ❖ **MUTE** button turns off the sound.

To use this function:

- ❖ Set **Speaker Preference** to **Receiver** in the **HDMI CEC Setup** menu.
 - ❖ Confirm that a connected HDMI® CEC device (such as DVD player, etc.) is selected for the Audio Receiver input source.
-

NOTE These functions depend on the device connected.

Other HDMI® CEC functions

When the **Enable HDMI CEC Control** and each item in the **HDMI CEC Control Setup** menu are set to **On**, the following functions will be enabled.

<i>Item:</i>	<i>Description:</i>
TV Auto Power	If a HDMI® CEC device is turned on, the TV turns on automatically.
Auto Standby	If the TV is turned off, the TV will send a message to turn off all of the HDMI® CEC devices connected to the TV.
Amplifier Control	If Amplifier Control is set to On, you can adjust the sound volume or turn off the sound using the remote control.

<i>Item:</i>	<i>Description:</i>
Initial Speaker Setting	From this item, you can set your audio output preference to the TV speakers or the audio receiver speakers. When this item is set to Receiver, the TV remote can be used to adjust or mute the volume of the audio. This item will be grayed out when Amplifier Control is set to Off.

NOTE When you turn on the Audio Receiver, change its input source or adjust the sound volume, the sound will be output from the audio receiver's speakers even if TV Speakers has been selected. Turn the TV off and on again to output the sound from the TV speakers.

Setting up HDMI® CEC

To set the HDMI® CEC Setup:

- 1 From the **Options** menu, highlight **HDMI CEC Control Setup** and press the **ENTER** button.
- 2 Highlight **Enable HDMI CEC Control**, and then press the **ENTER** button.
- 3 Select **On**, and then press the **ENTER** button.

NOTE If you select **Enable HDMI CEC Off**, the other items will be grayed out.

- 4 Press the **▲/▼** (arrow) buttons to highlight the HDMI® CEC Setup item you want to use, and press the **ENTER** button, follow by **▲/▼** (arrow) buttons.
 - ❖ **TV Auto Power:** On/Off
 - ❖ **Auto Standby:** On/Off

Using the HDMI® settings feature

HDMI® 1(or 2) RGB Range

You can select RGB range of HDMI inputs from the following modes, as described below:

- 1 From the **Options** menu, highlight **Input Options**, and then press the **ENTER** button.
- 2 Highlight **HDMI 1(or 2) RGB Range** and then press the **ENTER** button.

- 3 Press the **▲/▼** (arrow) buttons to select **Auto**, **Full**, or **Limited**, and then press the **ENTER** button.

<i>Mode</i>	<i>Description</i>
Auto(default)	Adjusts RGB full range signal automatically.
Full	RGB input signal is displayed in the range from 0 to 255.
Limited	RGB input signal is displayed in the range from 16 to 235.

The HDMI® setting (RGB Range) needs proper HDMI™ source devices. If your HDMI® source device does not support these features, the TV may not work properly when this feature is enabled.

HDMI® Information Display

Viewing the HDMI® signal information:

- 1 From the **Options** menu, highlight **HDMI Information Display**, and then press the **ENTER** button.
- 2 Press the **▲/▼** (arrow) buttons to select **On** or **Off**, and then press the **ENTER** button.
- 3 When the HDMI Information is set to **On**, pressing the **INFO** button displays the **HDMI Information** banner (Resolution, Scan Type, Frame Rate, Aspect, Bit Depth, Color Space, RGB/YUV, Chroma Format). When the **HDMI Information** is set to **Off**, the normal banner is displayed.

-
- NOTE**
- ❖ The signal information banner will appear when this feature is set to **On** and you watch an HDMI® input and press the **INFO** button. The signal information will disappear after approximately 60 seconds.
 - ❖ If you press the **INFO** button when this feature is set to **Off**, only the normal banner will appear.
-

Displaying TV status information

To display TV status information using the **RECALL** button:

- ❖ Press the **RECALL** button on the remote control.

The following information will be displayed (if applicable):

- ❖ Current input (**ANT/CABLE**, **Video**, etc.)
- ❖ If **ANT/CABLE** is the current input, either “**CABLE**” (for cable TV) or “**ANT**” (for over-the-air broadcasts).
- ❖ Channel number (if in **ANT/CABLE** mode)

- ❖ Digital signal strength indicator (bar graph in lower right corner of box; for digital signals only)
- ❖ Stereo, Mono, or SAP audio status (when in HDMI® input mode, Dolby® Digital, or PCM)
- ❖ Video resolution
- ❖ Aspect ratio of incoming video signal (4:3 or 16:9)
- ❖ V-Chip rating status
- ❖ GameTimer (if set)

To close the Recall screen, press the **RECALL** button again.

To display TV status information using INFO, press the **INFO** button.

The following additional information will display for digital channels, if applicable:

- ❖ Title
- ❖ Duration
- ❖ Detailed description

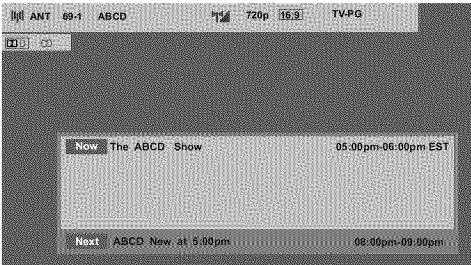

(Sample Illustration) Info banner

To close the INFO screen, press the **INFO** button again.

Understanding the last mode memory feature

If the power is cut off while you are viewing the TV, the Last Mode Memory feature automatically turns on the TV when the power is resupplied.

NOTE

If you know you will be away from the TV for an extended period of time you should unplug the power cord.

Chapter 7

Using the TV's Advanced Features

Using the advanced picture settings

ColorMaster™

The ColorMaster™ feature allows you to adjust standard colors.

- 1 From the **Picture** menu, highlight **Advanced Picture Settings**, and then press the **ENTER** button.
- 2 Highlight **ColorMaster**, and then press the **ENTER** button.
- 3 Press the **▲/▼** (arrow) buttons to select **On**, and then press the **ENTER** button.

Base Color Adjustment

When **ColorMaster™** is set to **On**, the list of base colors appears. You can select a base color to adjust.

- 1 From the **Picture** menu, highlight **Advanced Picture Settings**, and then press the **ENTER** button.
- 2 Highlight **Base Color Adjustment** and then press the **ENTER** button.
- 3 Press the **▲/▼** (arrow) buttons to select a color. Press the **ENTER** button.
- 4 Press the **◀/▶** (arrow) buttons to select **Hue**, **Saturation**, or **Brightness**.
- 5 Press the **▲/▼** (arrow) buttons to adjust the setting.

- 6 Repeat Steps 3 through 5 to adjust other colors.
To reset the adjustments to the factory defaults, select **Reset** on the screen. Press the **ENTER** button.

Color Temperature

You can change the quality of the picture by selecting from three preset Color Temperatures (Cool, Medium, and Warm), as described below.

<i>Mode:</i>	<i>Picture Quality:</i>
Cool	blueish
Medium	neutral
Warm	reddish

- 1 From the **Picture** menu, highlight **Advanced Picture Settings**, and then press the **ENTER** button.
- 2 Highlight **Color Temperature** and then press the **ENTER** button.
- 3 Press the **ENTER** button, follow by **▲/▼** (arrow) buttons to select the desired color temperature, and then press the **ENTER** button.
- 4 Press the **▲/▼** (arrow) buttons to highlight **Red**, **Green**, or **Blue** level, and then press the **◀/▶** (arrow) buttons to adjust the level. Press the **EXIT** button.

NOTE The Red, Green, and Blue level settings are connected to the Color Temperature settings and will change based on which preset color temperature (Cool, Medium, or Warm) is selected.

Static Gamma

The static gamma feature lets you adjust the levels of black in the picture.

- 1 From the **Picture** menu, highlight **Advanced Picture Settings**, and then press the **ENTER** button.
- 2 Highlight **Static Gamma** and then press the **ENTER** button.
- 3 Press the **◀/▶** (arrow) buttons to adjust the level of black detail. Press the **EXIT** button.
 - ❖ If the setting is decreased, the detail of black colors is decreased.
 - ❖ If the setting is increased, the detail of black colors is increased.

DynaLight™

The DynaLight™ feature automatically strengthens the black coloring of dark areas in the video according to the level of darkness.

- 1 From the **Picture** menu, highlight **Advanced Picture Settings**, and then press the **ENTER** button.
- 2 Highlight **DynaLight** and then press the **ENTER** button.
- 3 Press the **▲/▼** (arrow) buttons to select **High**, **Low**, or **Off**. Press the **ENTER** button.

Dynamic Contrast

Dynamic Contrast detects changes in picture quality that affect the appearance of your contrast settings and then automatically adjusts the video.

- 1 From the **Picture** menu, highlight **Advanced Picture Settings**, and then press the **ENTER** button.
- 2 Highlight **Dynamic Contrast** and then press the **ENTER** button.
- 3 Press the **▲/▼** (arrow) buttons to select **High**, **Middle**, **Low**, or **Off**. Press the **ENTER** button.

Cinema Mode

When you view a DVD (3:2 pulldown processed) from a DVD player connected to the VIDEO, ColorStream™ HD (component video), or HDMI® inputs on the TV, smoother motion can be obtained by setting the Cinema Mode to **On**. (available for 480i and 1080i signals).

- 1 From the **Picture** menu, highlight **Advanced Picture Settings**, and then press the **ENTER** button.
- 2 Highlight **Cinema Mode** and then press the **ENTER** button.
- 3 Press the **▲/▼** (arrow) buttons to select **On** or **Off**. Press the **ENTER** button.

Noise Reduction

MPEG NR

The MPEG noise reduction feature allows you to reduce visible interference caused by MPEG compression.

- 1 From the **Picture** menu, highlight **Advanced Picture Settings**, and then press the **ENTER** button.
- 2 Highlight **Noise Reduction** and then press the **ENTER** button.
- 3 Press the **▲/▼** (arrow) buttons to select **MPEG NR** and then press the **ENTER** button.
- 4 Press the **▲/▼** (arrow) buttons to select **High, Middle, Low, or Off**, and then press the **ENTER** button.

Digital Noise Reduction (DNR)

DNR lets you soften the screen representation of a weak signal to reduce the noise effect.

- 1 From the **Picture** menu, highlight **Advanced Picture Settings**, and then press the **ENTER** button.
- 2 Highlight **Noise Reduction** and then press the **ENTER** button.
- 3 Press the **▲/▼** (arrow) buttons to select **DNR** and then press the **ENTER** button.
- 4 Press the **▲/▼** (arrow) buttons to select **High, Middle, Low, or Off**, and then press the **ENTER** button.

Edge Enhancer

The Edge Enhancer feature lets you adjust the levels for your desired picture settings and achieve a sharper picture.

- 1 From the **Picture** menu, highlight **Advanced Picture Settings**, and then press the **ENTER** button.
- 2 Highlight **Edge Enhancer** and then press the **ENTER** button.
- 3 Press the **▲/▼** (arrow) buttons to select **On** or **Off**. Press the **ENTER** button.

NOTE This feature may not work properly depending on the content.

Chapter 8

Troubleshooting

General troubleshooting

Before calling a service technician, review this chapter or visit the Toshiba technical support Web site at support.toshiba.com for possible causes/solutions for the problem you are experiencing.

Before you begin to troubleshoot any problem, first unplug the TV from the AC wall outlet, wait approximately one minute, and then plug the TV back into the AC wall outlet. If the problem still exists attempt to troubleshoot the problem.

Black box on-screen.

The closed caption feature is set to one of the Text modes (T1, T2, T3, or T4). Set the closed caption feature to Off, see “Using closed captions” on page 66

TV stops responding to controls.

If the TV stops responding to the buttons on the remote control or TV control panel and you cannot turn off the TV, press and hold **POWER** button on the TV control panel for several seconds to reset the TV. If the TV does not power off using this method, unplug the TV from the AC wall outlet and plug it back in.

If you cause a static discharge when touching the TV and the TV fails to function, simply unplug the TV from the AC outlet and plug it back in. The TV should return to normal operation.

Other problems.

If your TV’s problem is not addressed in this Troubleshooting section or the recommended solution has not worked, use the Reset Factory Defaults procedure, see “Resetting Factory Defaults” on page 48

Onscreen Demo Pop-up

If your TV is displaying a Demo pop-up screen, reset the Store / Home mode setting to Home. For more information see “Installation setup selection” on page 43

TV will not turn on.

Ensure the power cord is plugged in properly, and then press the **POWER** button. Ensure the TV is plugged into a working AC power outlet by plugging another device into the AC power outlet to verify the AC power outlet is working.

Replace the batteries in the remote control, see “Installing batteries” on page 33

Try the control panel buttons on the TV.

Picture problems**General picture problems.**

Check the antenna/cable connections, see “Connecting Your TV” on page 22

Press the **INPUT** button on the remote control or on the TV and select a valid video input source, see “Selecting the video input source” on page 49. If no device is connected to an input on the TV, no picture appears when you select that particular input source. For device connection details, see “Connecting Your TV” on page 22

Antenna reception may be poor. Use a highly directional outdoor antenna (if applicable).

The station may be having broadcast difficulties. Try another channel.

Adjust the picture quality, see “Using the advanced picture settings” on page 93

Picture size changes by itself or when the TV is turned OFF and back ON.

Turn the Auto Aspect feature of the TV to OFF, see “Using the advanced picture settings” on page 93

Cannot select external video sources or channels 3 or 4.

If you cannot view signals from external devices connected to VIDEO, ColorStream™ HD, HDMI 1, HDMI 2, or from channel 3 or 4, ensure that the Input Lock is set to Off, see “Using the input lock feature” on page 77

Noisy picture.

If you are watching an analog channel (off-air broadcast or Cable TV), you can set the DNR feature to reduce visible interference in the TV picture, see “Digital Noise Reduction (DNR)” on page 96

Video Input Selection problems

If the Input Selection window does not appear when you press **INPUT** on the remote control or TV, press **INPUT** a second time. This will cause a change to the next video input source and display the Input Selection window.

Poor display color or no color.

The station may be having broadcast difficulties. Try another channel.

Adjust the Tint and/or Color, see “Adjusting the picture quality” on page 65

Poor composite picture.

If the TV is connected to an external A/V device (e.g. DVD player, video game system, set-top box, etc.) try using a ColorStream™ or HDMI® video connection instead.

Picture and sound are out of sync.

As with all products that contain a digital display, this may occur in rare instances, when viewing certain content (e.g. television broadcasts, video games, DVDs). The cause may include, without limitation, video processing within the TV, video processing in an attached gaming system, and video processing or different compression rates used by broadcasters in their programming.

Try the following:

- ❖ If the TV is connected to an A/V receiver that has a programmable audio delay feature, use this feature to help synchronize the sound to the picture.
- ❖ If the problem occurs only on certain TV channels, inform your local broadcast, cable, or satellite provider.
- ❖ Turn off and unplug the TV from the AC wall outlet for a few seconds and plug it back in.

Sound problems

Check the antenna/cable connections, see “Connecting a VCR, antenna, cable TV, or camcorder” on page 24

The station may be having broadcast difficulties. Try another channel.

The sound may be muted. Press the **VOL (+)** button.

If you hear no sound, try setting the MTS feature to Stereo mode, see “Selecting stereo/SAP broadcasts” on page 69

If you are not receiving a second audio program from a known SAP source, make sure the MTS feature is set to SAP mode, see “Selecting stereo/SAP broadcasts” on page 69

If you hear audio that seems incorrect for the program you are watching (such as music or a foreign language), the SAP mode may be on. Set the MTS feature to Stereo mode, see “Selecting stereo/SAP broadcasts” on page 69

Remote control problems

Remove all obstructions between the remote control and the TV.

Replace the remote control’s batteries, see “Installing batteries” on page 33

Your TV’s remote control may not operate certain features on your external devices. Refer to the User’s Guide for your other device to determine its available features. If your TV remote control does not operate a specific feature on another device, use the remote control that came with the device, see “Learning about the remote control” on page 36

If the TV still does not act as expected, perform the Reset Factory Defaults procedure, see “Resetting Factory Defaults” on page 48

Channel tuning problems

The Auto Tuning feature may have erased the channel from memory. Add the channel to the channel memory, see “Storing channels in memory (optional)” on page 44

The Lock feature may have blocked the channel. Unblock the channel, see “Locking channels” on page 77

If you cannot tune digital channels, check the antenna configuration. If the problem persists, clear all channels from the channel list and reprogram channels into memory, see “Storing channels in memory (optional)” on page 44. For additional information, see “TV stops responding to controls.” on page 97. If the problem persists, use the Reset Factory Defaults procedure, see “Resetting Factory Defaults” on page 48

Closed caption problems

If the program or video you have selected is not closed captioned, no captions appear on the screen. If text is not available, a black rectangle may appear.

If this happens, turn off the closed caption feature, see “Using closed captions” on page 66

A closed caption signal may not display correctly under the following circumstances:

- ❖ The recording is dubbed
- ❖ The signal reception is weak
- ❖ The signal reception is non-standard

For additional information, see “Using closed captions” on page 66

Rating blocking (V-Chip) problems

Forgotten PIN code.

When the PIN code screen appears, press the **INFO** button 4 times within approximately 5 seconds. The old PIN code is cleared, see “Forgotten PIN code” on page 72

The V-Chip feature is available for U.S. V-Chip systems only, see “Using parental controls (for USA region)” on page 72

No HDMI® CEC operation

The HDMI® CEC feature is available for Toshiba HDMI® CEC compatible devices.

Ensure that HDMI® cables with the  Logo are used.

When the connected HDMI® CEC device does not work correctly after you have changed settings of the device, turn off your TV and unplug the power cord, then plug in and turn on again.

If several devices are connected, the HDMI® CEC feature may not operate properly.

Read the instruction manual furnished with the connected HDMI® CEC device.

HDMI® problems

HDMI® cables.

Ensure that HDMI® cables with the (**HDMI**) Logo are used, see “Connecting an HDMI® or DVI device to the HDMI® input” on page 27

Legacy HDMI® sources.

Some legacy HDMI® sources may not work properly with the latest HDMI® TV products due to new standard adoption.

Media Player problems

Incorrect functionality may occur when using a USB HUB connection.

Photo files that were processed and edited using the computer’s application software may not be viewable.

The TV may select one format automatically and play it when contents that support two or more formats are played.

Confirm that the contents of the USB storage device are in formats that are supported by this TV, see “Using the Media Player” on page 80

If the problem persists after trying the solutions

Contact Toshiba at: support.toshiba.com.

Appendix A

Specifications

-
- NOTE**
- ❖ These models comply with the specifications listed below.
 - ❖ Designs and specifications are subject to change without notice.
 - ❖ These models may not be compatible with features and/or specifications that may be added in the future.
-

Television system

NTSC standard	
ATSC standard	8VSB
Digital Cable	64 QAM, 256 QAM; in-the-clear, unencrypted

Channel coverage

VHF	2 through 13
UHF	14 through 69
Cable TV	Mid band (A-8 through A-1, A through I)
	Super band (J through W)
	Hyper band (AA through ZZ, AAA, BBB)
	Ultra band (65 through 94, 100 through 135)

Power source

120V AC, 60 Hz

Power maximum current

32L2400U	0.9 A
40L2400U	1.1 A
50L2400U	1.4 A

Power consumption

32L2400U	0.3 W in Standby mode
40L2400U	0.3 W in Standby mode
50L2400U	0.3 W in Standby mode

Audio power

32L2400U	6 Ω 7W
40L2400U	6 Ω 7W
50L2400U	6 Ω 7W

Speaker type

32L2400U	Two 5.98 x 1.57 x 1.42"
40L2400U	Two 5.98 x 1.57 x 1.42"
50L2400U	Two 5.98 x 1.57 x 1.42"

Video/audio terminals

Video/audio input

Video	1 V (p-p), 75 ohm, negative sync.
Audio	200 mV(rms) (-20dBFS, 47K ohm or greater)

ColorStream™ (component video) HD input

Video	Y: 1V(p-p), 75 ohm
	PR: 0.7V(p-p), 75 ohm
	PB: 0.7V(p-p), 75 ohm
	Suggested formats: 1080i, 720p, 480p, 480i
Audio	200 mV(rms) (-20dBFS, 47K ohm or greater)

HDMI® input

HDMI® compliant (type A connector)	
HDCP compliant	
HDMI® Audio	2-channel Linear-PCM/Dolby® Digital; 32/44.1/48kHz sampling frequency; 16/20/24 bits per sample

Dimensions (with stand)

32L2400U	Width	28.9" (734mm)
	Height	19.3" (489mm)
	Depth	7.1" (180mm)
40L2400U	Width	36.5" (928mm)
	Height	23.1" (588mm)
	Depth	7.6" (194mm)
50L2400U	Width	44.2" (1122mm)
	Height	27.6" (702mm)
	Depth	8.5" (217mm)

Weight / mass (with stand)

32L2400U	12.8 lbs (5.8 kg)
40L2400U	20.9 lbs (9.5 kg)
50L2400U	35.1 lbs (15.9 kg)

Operating conditions

Temperature	32°F - 95°F (0°C - 35°C)
-------------	--------------------------

Humidity	20 - 80 % (no moisture condensation)
----------	--------------------------------------

Supplied accessories

- ❖ Remote control with two size “AAA” batteries
- ❖ Resource Guide
- ❖ Quick Start Guide
- ❖ Pedestal and hardware
- ❖ Warranty information
- ❖ Power cord (available on certain models)

Acceptable signal formats for HDMI®

HDMI® signal formats

<i>Format</i>	<i>Resolution</i>	<i>V. Frequency</i>	<i>H. Frequency</i>	<i>Pixel Clock Frequency</i>
VGA	640 x 480	59.940 Hz	31.469 kHz	25.175 MHz
SVGA	800 x 600	60.317 Hz	37.879 kHz	40.000 MHz
XGA	1024 x 768	60.004 Hz	48.363 kHz	65.000 MHz
WXGA	1280 x 768	59.870 Hz	47.776 kHz	79.500 MHz
	1360 x 768	60.015 Hz	47.712 kHz	85.500 MHz
SXGA	1280 x 1024	60.020 Hz	63.981 kHz	108.000 MHz
480i	720 x 480i	59.940 Hz	15.734 kHz	27.000 MHz
480p	720 x 480p	59.940 Hz	31.469 kHz	27.000 MHz
720p	1280 x 720p	60.000 Hz	45.000 kHz	74.250 MHz
1080i	1920 x 1080i	60.000 Hz	33.750 kHz	74.250 MHz
1080p	1920 x 1080p	24.000 Hz	27.000 kHz	74.250 MHz
		60.000 Hz	67.500 kHz	148.500 MHz

NOTE

- ❖ Some illustrations in this User's Guide are for explanation purposes and may differ from the actual unit.
- ❖ Designs and specifications are subject to change without notice.
- ❖ These models may not be compatible with features and/or specifications that may be added in the future.

Appendix B

Index

A

Acceptable signal formats for HDMI®
HDMI® signal formats 106

Additional Safety Precautions
Installation, Care, and Service
Choosing a location for your
LED TV
To Display your LED TV on the
included Pedestal Stand 4

Adjusting the picture
Selecting the picture mode
Adjusting the picture quality
Using closed captions 64, 65

ANT/CABLE IN
Storing channels in memory
(optional)
Auto Tuning
Manual Tuning 43

Audio
Adjusting quality 70
Dolby® Digital Dynamic Range
Control 71
Muting sound 68
Stereo/SAP broadcasts 69

Auto Aspect
using 62
Auto Start function
Media Player 81
Available remote control key functions
HDMI® CEC Player Control menu
functions
HDMI® CEC input source
selection
VOLUME and MUTE controls of
Audio Receiver 87

B

Base closed captions
Digital CC settings
Adjusting the audio
Muting the sound 66
Blocking TV programs and movies by
rating (V-Chip)
Downloading an additional rating
system
Rating system

Displaying ratings 72

C

Channel Browser

Elements 54

Tuning channels 52

Channels

Locking channels 77

Cinema Mode

Noise Reduction

MPEG NR

DNR 95

Color Temperature

Static Gamma

DynaLight™

Dynamic Contrast 94

Component video cables (red/green/blue)

HDMI® cable (with HDMI Logo)

Optical audio cable

About the connection illustrations

23

Connecting a digital audio system

Connecting a computer

Connection to the TV's HDMI®

terminal 31

Connecting a VCR, antenna, cable TV, or camcorder

Connecting a Blu-ray™ / DVD

player, satellite receiver with

ColorStream® or VCR

Connecting an HDMI® or DVI

device to the HDMI® input

HDMI® CEC connection 24

Connecting Your TV

Overview of cable types

Coaxial (F-type) cable

Standard A/V cables (red/white/
yellow) 22

D

Dimensions (with stand)

Weight (mass)

Operating conditions

Supplied accessories 105

E

Edge Enhancer 96

Enter a new PIN code

Forgotten PIN code

Changing or deleting your PIN
code

Using parental controls (for USA
region) 72

F

Favorites browser

Elements of the Channel Browser

Adding and clearing channels
and inputs in the History List

Tuning to the next programmed
channel 53

Features 17, 18

Freeze

Feature 63

Full

TheaterWide 1

TheaterWide 2

TheaterWide 3 58, 59, 63, 91

H

HDMI®-CEC

using 87

HDMI® Information Display

Displaying TV status information

Understanding the last mode
memory feature 91

I

Introduction

- Safety icons
 - Features
 - Overview of installation, setup, and use 16
- L**
- Last mode memory feature 92
 - Locks menu
 - setting pin code 72
- M**
- Media Player
 - Playing music files 84
 - Menu
 - Navigation 41
 - Menu Layout and Navigation
 - Main menu layout
 - Navigating the menu system 39
- N**
- Native
 - 4:3
 - Normal
 - Dot by Dot 58, 60
 - No HDMI® CEC operation
 - HDMI® problems
 - Media Player problems
 - If the problem persists after trying the solutions 101
 - No signal power down
 - set 87
- O**
- Other HDMI® CEC functions
 - Setting up HDMI® CEC
 - Using the HDMI® settings feature
- HDMI® 1(or 2) RGB Range 89
- P**
- Panel lock feature
 - using 79
 - Parental controls
 - using 72
 - Picture
 - Adjusting quality 65
 - Picture size
 - 4:3 61
 - Normal 61
 - TheaterWide 1 59
 - TheaterWide 2 59
 - TheaterWide 3 60
 - Pin code
 - Changing 72
 - Deleting 72
 - Entering PIN code 72
 - Forgotten 72
 - Power maximum current
 - Power consumption
 - Audio power
 - Speaker type 104
 - Program ratings
 - Displaying 76
 - Unlocking programs 76
- Q**
- Quick setup
 - ANT/CABLE IN 43
- R**
- Remote control problems
 - Channel tuning problems
 - Closed caption problems
 - Rating blocking (V-Chip) problems 100
 - Resetting Factory Defaults 48

S

- Safety
 - icons 16
- Safety Precautions
 - WARNING
 - CHILD SAFETY
 - Important Safety Instructions 2, 4
- Scrolling the TheaterWide™ picture (TheaterWide 2 and 3 only)
 - Using the Auto Aspect feature
 - Using the 4:3 Stretch
 - Using the FREEZE feature 58, 60, 62
- Setting channel skip
 - Setting the AV input mode
 - Setting the time zone
 - Viewing the system status 46
- Setting the sleep timer
 - No Signal Power Down
 - Using HDMI® CEC
 - HDMI® CEC playback device (Blu-ray™/DVD player, etc.) control 86
- Setting up your TV
 - Initial Setup
 - Installation setup selection
 - Menu language 42
- Slide show
 - Playing music files
 - Viewing photo files and playing music files at the same time
 - Sorting photo or music files 82, 83
- Sound Mode
 - Stable Sound
 - Using the Dolby® Digital Dynamic Range Control feature
 - Selecting the PIN code 71
- Specifications
 - Dimensions 105
 - HDMI® input 105
 - Speaker type 104

- Supplied accessories 106
- TV system 103

Specifications

- Television system
 - Channel coverage
- Power source 103

T

- Timer
 - sleep timer 86
- Time zone
 - setting 47
- To Display your LED TV using a Wall Bracket
 - FCC Declaration of Conformity Compliance Statement (Part 15) ENERGY STAR® User Information
 - Important notes about your TV 6
- To open the Media Player
 - Viewing photo files
 - Multi View
 - Single view 81
- Trademark Information
 - Copyright
 - Notice 9
- Troubleshooting
 - Closed caption problems 101
 - Contact Toshiba 102
 - HDMI® 102
 - Media player problems 102
 - Picture problems 98
 - Rating blocking problems 101
 - Sound problems 99
- Troubleshooting
 - General troubleshooting
 - Picture problems
 - Sound problems 97
 - Tuning to a specific channel (programmed or unprogrammed)

- Switching between two channels using Channel Return
 - Switching between two channels using SurfLock™
- Selecting the picture size 56
- TV front and side panel controls and connections
 - TV back panel connections 19
- TV panel controls
 - left side 19
- TV remote
 - functionality 36

U

- Unlocking programs temporarily
 - Using the input lock feature
 - Locking channels
 - Using the GameTimer™ 76
- Using the Digital Audio Selection
 - Selecting stereo/SAP broadcasts
 - Adjusting the audio quality
 - DTS TruSurround™ 69
- Using the panel lock feature
 - Using the Media Player
 - Using Media Player with a USB device
 - Auto Start function 79
- Using the Remote Control
 - Installing batteries
 - Remote control effective range
 - Learning about the remote control 33
- Using the TV's Advanced Features
 - Using the advanced picture settings
 - ColorMaster™
 - Base Color Adjustment 93

V

- Video/audio terminals
 - Video/audio input

- ColorStream™ (component video) HD input
- HDMI® input 104
- Video input sources
 - labeling 51