

Use & Care Guide

Manual de Uso y Cuidado

English / Español

Models/Modelos: 790.4511\*, 790.4512\*.

# Kenmore Elite<sup>®</sup>

## Electric Cooktop

## Parrilla de Cocinar Eléctrica

\* = Color number, número de color

P/N 318205613A (1301)

Sears Brands Management Corporation

Hoffman Estates, IL 60179 U.S.A.

[www.kenmore.com](http://www.kenmore.com)

[www.sears.com](http://www.sears.com)



---

## Table of Contents

Warranty .....	2	General Cooktop Information .....	7
IMPORTANT SAFETY INSTRUCTIONS .....	3-4	Use Proper Cookware .....	7
Serial Plate Location .....	4	Operating the Single Radiant Surface Elements .....	8
Product Record .....	4	Operating the Dual Radiant Surface Element .....	9
Cooktop Features .....	5	General Care & Cleaning .....	10-11
Setting Surface Controls .....	6-9	Cleaning Your Cooktop .....	10
About the Ceramic Glass Cooktop .....	6	Ceramic Glass Cooktop Cleaning & Maintenance ..	10
About Radiant Surface Elements .....	6	Cleaning Recommendations for Ceramic Glass .....	11
Locations of the Radiant Surface Element and		Before You Call .....	12
Controls .....	6	Protection Agreements .....	13
		Sears Service .....	14

---

## Kenmore Elite Warranty

When installed, operated and maintained according to all instructions supplied with the product, if this appliance fails due to a defect in material and workmanship within one year from the date of purchase, call 1-800-4-MY-HOME® to arrange for free repair.

This warranty applies for only 90 days from the date of purchase if this appliance is ever used for other than private family purposes.

**This warranty covers only defects in material and workmanship. Sears will NOT pay for:**

1. Cracks in a ceramic glass cooktop that are not a result of thermal shock.
2. Stains and scratches on a ceramic glass cooktop resulting from accident or improper operation or maintenance.
3. Expendable items that can wear out from normal use, including but not limited to filters, belts, light bulbs, and bags.
4. A service technician to instruct the user in correct product installation, operation or maintenance.
5. A service technician to clean or maintain this product.
6. Damage to or failure of this product if it is not installed, operated or maintained according to the all instructions supplied with the product.
7. Damage to or failure of this product resulting from accident, abuse, misuse or use for other than its intended purpose.
8. Damage to or failure of this product caused by the use of detergents, cleaners, chemicals or utensils other than those recommended in all instructions supplied with the product.
9. Damage to or failure of parts or systems resulting from unauthorized modifications made to this product.

### Disclaimer of implied warranties; limitation of remedies

Customer's sole and exclusive remedy under this limited warranty shall be product repair as provided herein. Implied warranties, including warranties of merchantability or fitness for a particular purpose, are limited to one year or the shortest period allowed by law. Sears shall not be liable for incidental or consequential damages. Some states and provinces do not allow the exclusion or limitation of incidental or consequential damages, or limitation on the duration of implied warranties of merchantability or fitness, so these exclusions or limitations may not apply to you.

This warranty applies only while this appliance is used in the United States or Canada.

This warranty gives you specific legal rights, and you may also have other rights which vary from state to state.

**Sears Brands Management Corporation, Hoffman Estates, IL 60179**  
**Sears Canada Inc., Toronto, Ontario, Canada M5B 2C3**

# IMPORTANT SAFETY INSTRUCTIONS

Read all instructions before using this appliance. Save these instructions for future reference.

This manual contains important safety symbols and instructions. Please pay attention to these symbols and follow all instructions given.

**⚠ WARNING** This symbol will help alert you to situations that may cause serious bodily harm, death or property damage.

**⚠ CAUTION** This symbol will help alert you to situations that may cause bodily injury or property damage.

- **Remove all tape and packaging before using the appliance.** Destroy the carton and plastic bags after unpacking the appliance. Never allow children to play with packaging material. Do not remove the model/serial plate attached to the cooktop.
- **Proper Installation. Be sure your appliance is properly installed and grounded by a qualified technician in accordance with National Electrical Code ANSI/NFPA No.70-latest edition and local code requirements.** Install only per installation instructions provided in the literature package for this appliance.
- **In case of an emergency, know how to disconnect the electrical power to the appliance at the circuit breaker or fuse box.**
- **User Servicing—Do not repair or replace any part of the appliance unless specifically recommended in the manuals.** All other servicing should be done only by a qualified technician to reduce the risk of personal injury and damage to the cooktop. Sears Parts & Repair is the recommended repair service for this appliance.
- **Never modify or alter the construction of an appliance by removing panels, wire covers or any other part of the product.**

**⚠ WARNING** Stepping or leaning on this cooktop can result in serious injuries and may also cause damage to the cooktop. Do not allow children to climb or play around the cooktop.

- **Storage on Appliance. Flammable materials should not be stored near surface units.** This includes paper, plastic and cloth items, such as cookbooks, plasticware and towels, as well as flammable liquids. Do not store explosives, such as aerosol cans, on or near the appliance. Flammable materials may explode and result in fire or property damage.

**⚠ WARNING** Do not store items of interest to children in the cabinets above the appliance.

- **Do not leave children alone. Children should not be left alone or unattended in the area where an appliance is in use.** They should never be allowed to sit or stand on any part of the appliance.

- **DO NOT TOUCH SURFACE UNITS OR AREAS NEAR THESE SURFACES.** Surface units may be hot even though they are dark in color. Areas near surface units may become hot enough to cause burns. During and after use, do not touch, or let clothing or other flammable materials touch these areas until they have had sufficient time to cool. Among these areas are the cooktop and areas facing the cooktop.
- **Wear Proper Apparel. Loose-fitting or hanging garments should never be worn while using the appliance.** Do not let clothing or other flammable materials contact hot surfaces.

**⚠ WARNING** Never use your appliance for warming or heating the room.

- **Do Not Use Water or Flour on Grease Fires.** Smother the fire with a pan lid, or use baking soda, a dry chemical or foam-type extinguisher.
- **When heating fat or grease, watch it closely.** Fat or grease may catch fire if allowed to become too hot.
- **Use Only Dry Potholders. Moist or damp potholders on hot surfaces may result in burns from steam.** Do not let the potholders touch hot heating surface units. Do not use a towel or other bulky cloth instead of a potholder.
- **Do Not Heat Unopened Food Containers.** Buildup of pressure may cause the container to burst and result in injury.

**IMPORTANT.** Do not attempt to operate the cooktop during a power failure. If the power fails, always turn off the cooktop. If the cooktop is not turned off and the power resumes, the cooktop will begin to operate again. Food left unattended could catch fire or spoil.

## IMPORTANT INSTRUCTIONS FOR USING YOUR COOKTOP

- **Know which knob controls each surface unit.**
- **Clean the appliance regularly to keep all parts free of grease that could catch fire.** Exhaust fan ventilation hoods and grease filters should be kept clean. Do not allow grease to accumulate on hood or filter. Greasy deposits

# IMPORTANT SAFETY INSTRUCTIONS

in the fan could catch fire. When flaming food under the hood, turn fan on. Refer to hood manufacturer's instructions for cleaning.

- **⚠ WARNING Use Proper Pan Size.** This appliance is equipped with one or more surface units of different sizes. Select utensils having flat bottoms large enough to cover the surface unit. The use of undersized utensils will expose a portion of the surface heating unit to direct contact and may result in ignition of clothing. Proper relationship of utensil to the surface unit will also improve efficiency.
- **Utensil Handles Should Be Turned Inward from Edges of Cooktop and Should Not Extend Over Adjacent Surface Units.** To reduce the risk of burns, ignition of flammable materials, and spillage due to unintentional contact with the utensil.
- **Never Leave Surface Units Unattended at a Hi Heat Settings.** Boilovers cause smoking and greasy spillovers that may ignite, or a pan that has boiled dry may melt.
- **Protective Liners.** Do not use aluminum foil to line any part of the appliance. Only use aluminum foil as recommended for baking if used as a cover placed on the food. Any other use of protective liners or aluminum foil may result in a risk of electric shock or fire or short circuit.
- **Glazed Cooking Utensils.** Only certain types of glass, glass/ceramic, ceramic, earthenware, or other glazed utensils are suitable for range top service without breaking due to the sudden change in temperature. Check the manufacturer's recommendations for cooktop use.

- **Ventilating hood.** The ventilating hood above your cooking surface should be cleaned frequently, so the grease from cooking vapors does not accumulate on the hood or filter.
- **Do Not Use Decorative Surface Element Covers.** If an element is accidentally turned on, the decorative cover will become hot and possibly melt. Burns will occur if the hot covers are touched. Damage may also be done to the appliance.
- **Do Not Clean or Operate a Broken Cooktop.** If cooktop should break, cleaning solutions and spillovers may penetrate the broken cooktop and create a risk of electric shock. Contact a qualified technician immediately.
- **Clean Cooktop with Caution.** If a wet sponge or cloth is used to wipe spills on a hot cooking area, be careful to avoid a steam burn. Some cleaners can produce harmful fumes if applied to a hot surface.
- **Do Not Place Hot Cookware on Cold Cooktop Glass.** This could cause glass to break.
- **Do not slide pans across the cooktop surface.** They may scratch the cooktop surface.
- **Do not let pans boil dry.** Pans that boil dry may permanently damage the cooktop by breaking, fusing to, or marking it. (This type of damage is not covered by your warranty).

---

## IMPORTANT SAFETY NOTICE

The California Safe Drinking Water and Toxic Enforcement Act requires the Governor of California to publish a list of substances known to the state to cause cancer, birth defects or other productive harm, and requires businesses to warn customers of potential exposure to such substances.

---

## Product Record

In this space below, record the date of purchase, model and serial number of your product. You will find the model and serial number printed on the serial plate. This serial plate is located under the cooktop.

Model No. **790.** \_\_\_\_\_

Serial No. \_\_\_\_\_

Date of purchase \_\_\_\_\_

Save these instructions and your sales receipt for future reference.

## Serial Plate Location

You will find the model and serial number printed on the serial plate.

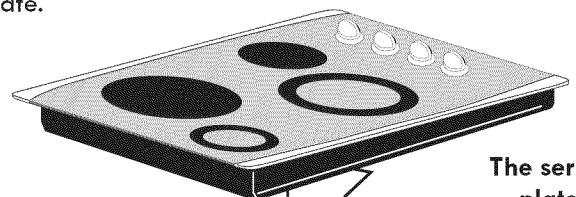

The serial plate is located under the cooktop.

Please see the illustration for exact location. Remember to record the serial number for future reference (See Product Record below).

# Cooktop Features

READ THESE INSTRUCTIONS CAREFULLY BEFORE USING THE COOKTOP

**CAUTION** The Cooking Zones may appear to be cool while turned ON and after they have been turned OFF. The glass surface may be **HOT** from residual heat transferred from the cookware and burns may occur.

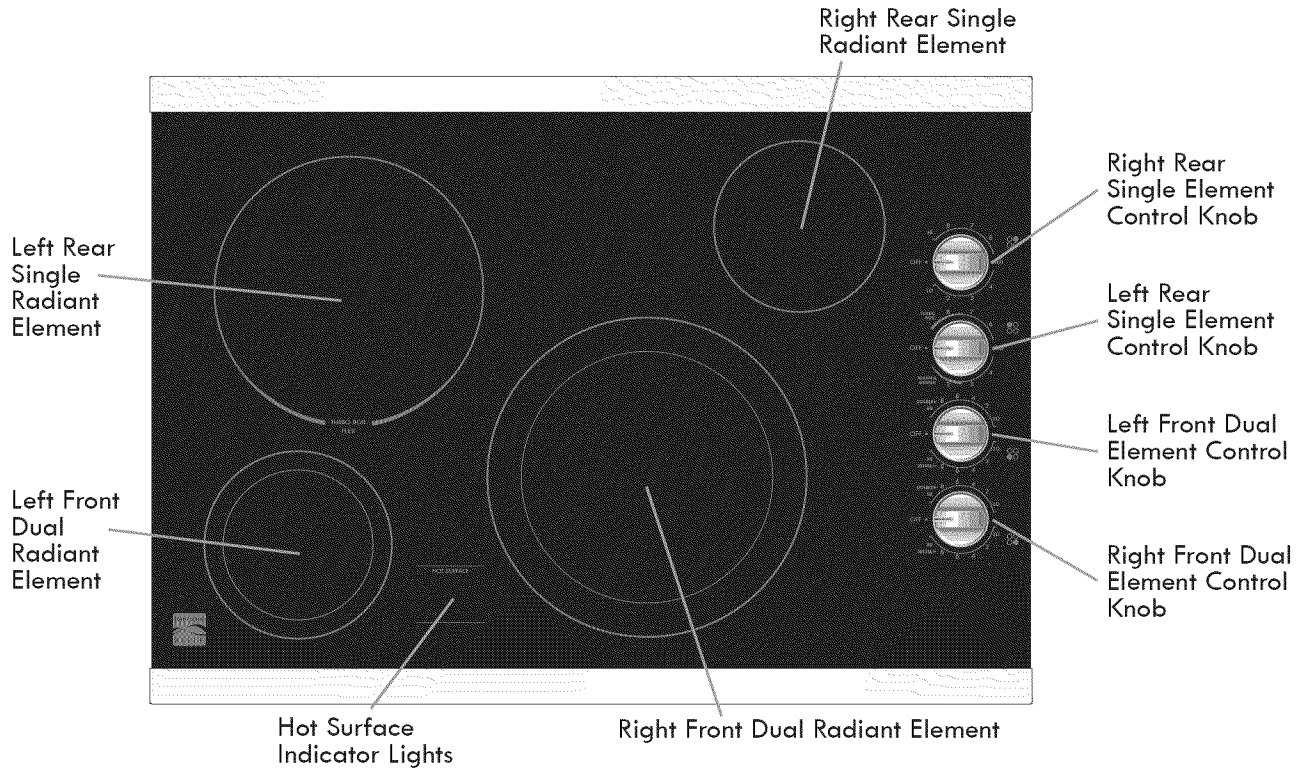

Fig. 1 - 30" Model

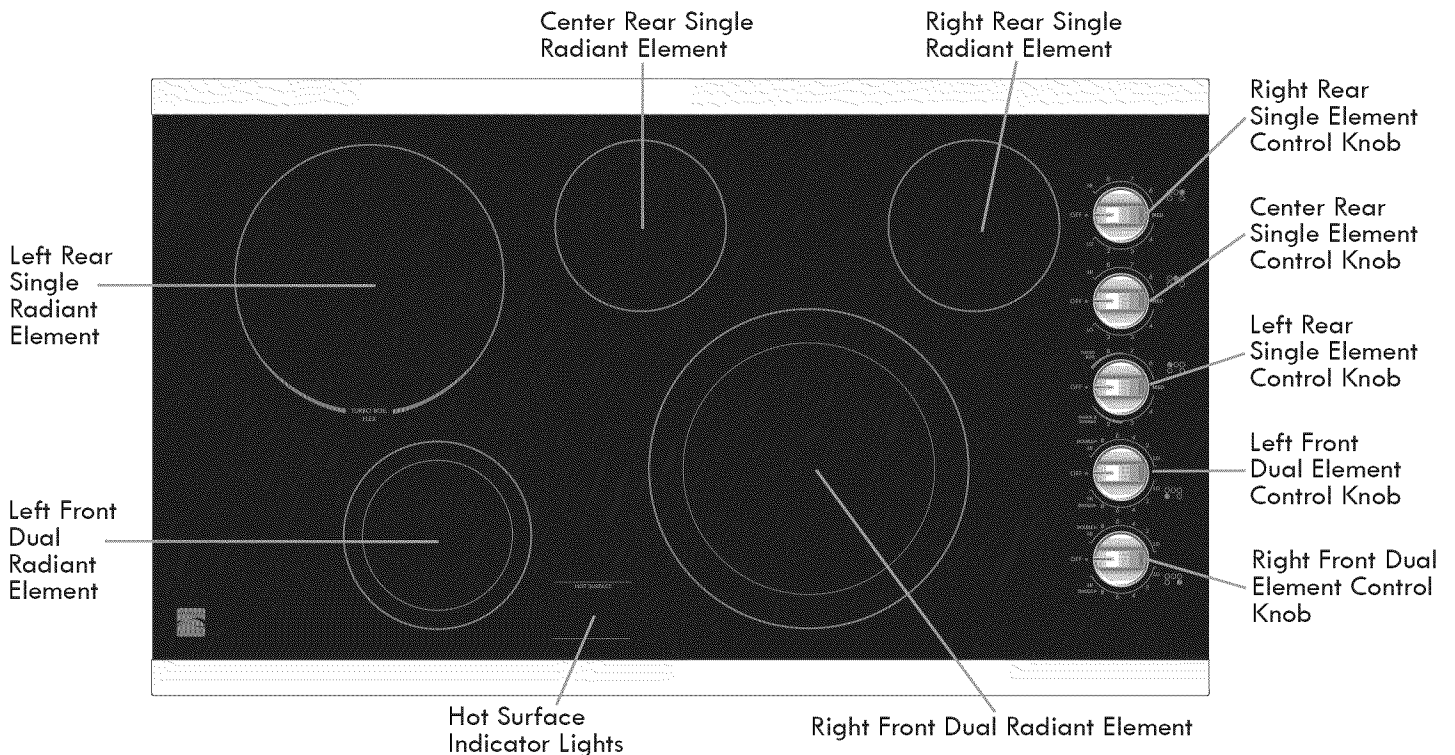

Fig. 2 - 36" Model

# Setting Surface Controls

## About the Ceramic Glass Cooktop

The ceramic cooktop has radiant surface elements located below the surface of the glass. The design of the ceramic cooktop outlines the area of the surface element underneath. **Make sure** the diameter of the pan matches the diameter of the element outline on the cooktop. Heat is transferred up through the surface of the cooktop to the cookware. Only flat-bottom cookware should be used. The type and size of cookware, the number of surface elements in use and their settings, are all factors that will affect the amount of heat that will spread to areas beyond the surface elements. The areas surrounding the elements may become **hot enough to cause burns**.

## About the Radiant Surface Elements

The element temperature rises gradually and evenly. As the temperature rises, the element will glow red. To maintain the selected setting, the element will cycle on and off. The heating element retains enough heat to provide a uniform and consistent heat during the off cycle. For energy efficient cooking, turn off the element several minutes before cooking is complete. This will allow residual heat to complete the cooking process.

## Locations of the Radiant Surface Elements and Controls

Your cooktop is equipped with radiant surface burners with different wattage ratings. The ability to heat food quicker and in larger volumes increases as the element wattage increases.

The radiant surface elements are located on the 30" cooktop as follows (See Figure 1):

- One **9 inch Turbo Boil Flex™** radiant element located at the left rear position;
- One **6 inch** single radiant element located at the right rear position;
- One **9 or 12 inch** dual radiant element located at the right front position;
- One **5 or 7 inch** dual radiant element located at the left front position.

The radiant surface elements are located on the 36" cooktop as follows (See Figure 2):

- Two **6 inch** radiant elements located at the center and right rear position;
- One **9 inch Turbo Boil Flex™** radiant element located at the left rear position;
- One **9 or 12 inch** dual radiant element located at the right front position;
- One **5 or 7 inch** dual radiant element located at the left front position.

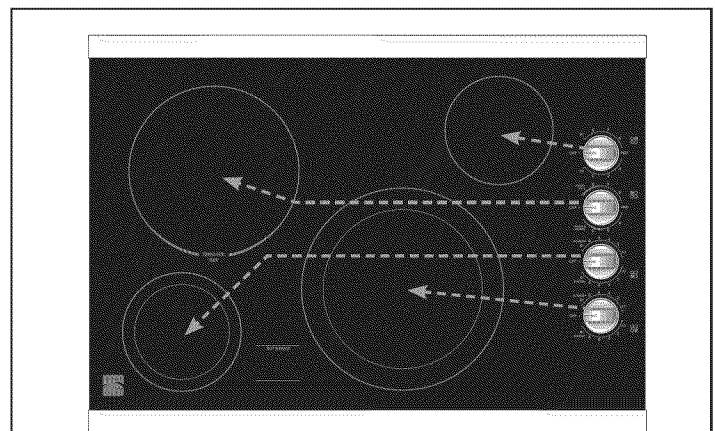

30" Cooktop - Location of the Radiant Surface Elements and Controls  
Figure 1

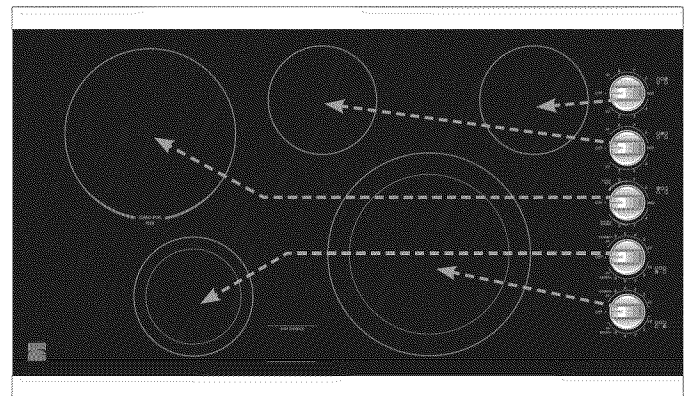

36" Cooktop - Location of the Radiant Surface Elements and Controls  
Figure 2

**NOTE:** Please read detailed instructions for ceramic glass cooktop cleaning in the **General Care & Cleaning** section and **Before You Call** checklist section of this Use and Care Guide.

**NOTE:** Radiant elements have a limiter that allows the element to cycle on and off, even at the HI setting. This helps to prevent damage to the ceramic cooktop. Cycling at the HI setting is normal and will mostly occur if the cookware is too small for the radiant element or if the cookware bottom is not flat (For information concerning cookware, refer to **use proper cookware** on page 7 of this Use and Care Guide)

# Setting Surface Controls

## General Cooktop Information

Use the table below to determine the correct setting for the kind of food you are preparing. The low settings are used to simmer and keep larger quantities of foods warm such as stews and soups. The lowest simmer settings are ideal for delicate foods and melting chocolate or butter.

**Note:** The size and type of cookware used will influence the setting needed for best cooking results.

Recommended Settings Table for Single, Dual and Bridge Surface Elements	
Setting	Type of Cooking
HI (High)	Start most foods, bring water to a boil, pan broiling.
5-8 (Medium high)	Continue a rapid boil, fry, deep fat fry.
5 (Medium)	Maintain a slow boil, thicken sauces and gravies, steam vegetables.
2-4 (Medium low)	Keep foods cooking, poach, stew.
LO-2 (Low)	Keep warm, melt, simmer.

### Use Proper Cookware

Cookware should have flat bottoms that make good contact with the entire surface heating element. Check for flatness by rotating a ruler across the bottom of the cookware (See Figure 1). Be sure to follow the recommendations for using cookware as shown to the right.

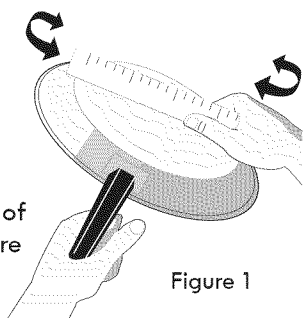
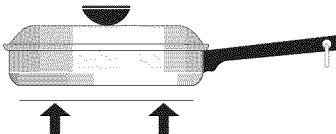

Figure 1

**Note:** The size and type of cookware used will influence the setting needed for best cooking results.

### CORRECT



- Flat bottom and straight sides.
- Tight fitting lids.
- Weight of handle does not tilt pan. Pan is well balanced.
- Pan sizes match the amount of food to be prepared and the size of the surface element.
- Made of material that conducts heat well.
- Easy to clean.
- Always match pan diameter to element surface diameter.

### INCORRECT



- Curved and warped pan bottoms.

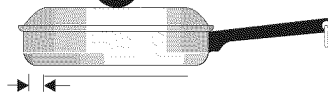

- Pan overhangs unit by more than one-half inch.

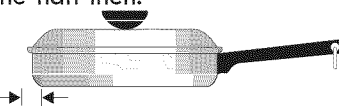

- Pan is smaller than the element.



- Heavy handle tilts the pan.

# Setting Surface Controls

## Operating the Single Radiant Surface Elements

The cooktop has 2 (3 on 36" model) single radiant surface elements: the LEFT REAR & RIGHT REAR (for 30" model) or LEFT REAR, CENTER REAR & RIGHT REAR (for 36" model) positions (Figures 1 and 2).

### To Operate the Single Radiant Surface Elements

1. Place correctly sized cookware on the radiant surface element.
2. Push in and turn the surface control knob in either direction to the desired setting (Figure 3). Turn the knob to adjust the setting if desired. Start most cooking operations on a higher setting and then turn to a lower setting to finish cooking. Each surface element provides a constant amount of heat at each setting. A glowing red surface heating area extending beyond the bottom edge of the cookware indicates the cookware is **too small** for the surface heating area.
3. **When cooking has completed, turn the surface control knob to OFF before removing the cookware.** **Note:** The Hot Surface Indicator light will come on when the control knob is turned on and will continue to glow until the glass cooktop has cooled down to a moderate level that will not cause burns if the area is touched. The light may remain on even though the controls are turned OFF.

**Note:** See Table on page 7 for recommended control settings.

**⚠ WARNING** Radiant surface elements may appear to have cooled after they have been turned off. A hot surface indicator light will come on and will continue to glow until the glass cooktop has cooled down to a moderate level. **The glass surface may still be hot** and burns may occur if the glass surface is touched before the indicator light has turned off.

**⚠ WARNING** Do not place plastic items such as salt and pepper shakers, spoon holders or plastic wrappings on cooktop when it is in use. These items could melt or ignite. Potholders, towels or wooden spoons could catch fire if placed too close to the surface elements.

**⚠ CAUTION** Do not allow aluminum foil, or ANY material that can melt to make contact with the ceramic glass cooktop. If these items melt on the cooktop they will damage the ceramic cooktop.

### Using Turbo Boil Flex™ Element

The **Turbo Boil Flex™** feature offers power to melt, warm, simmer and boil without moving the pot from element to element. The **Turbo Boil Flex™** will bring food items to boil much quicker and may be used when preparing larger quantities of food. The cooktop graphics will be clearly marked with this feature.

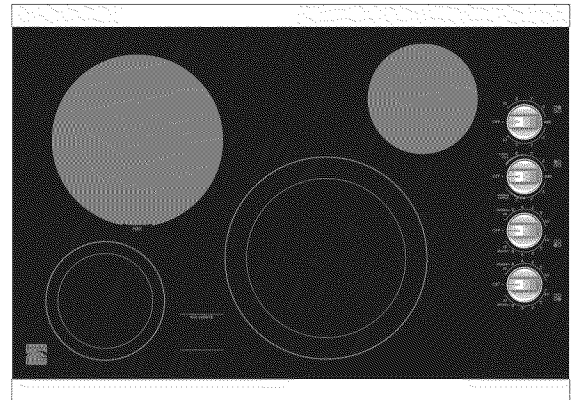
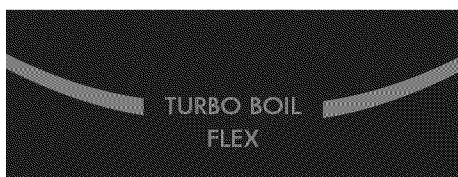

Figure 1

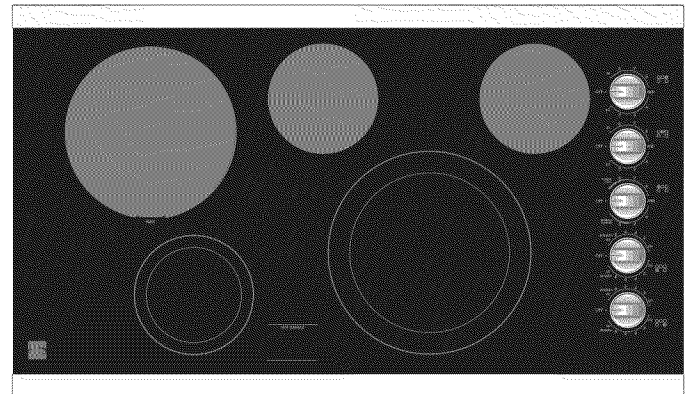

Figure 2

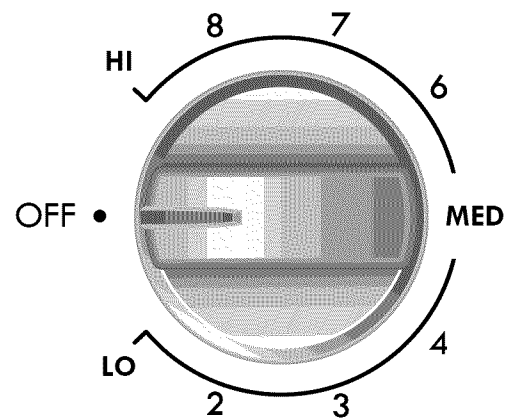

Figure 3



# Setting Surface Controls

## Operating the Dual Surface Radiant Element

The cooktop is equipped with a dual radiant surface element located at the RIGHT & LEFT FRONT position (See Figures 1 & 2). Symbols on the control knob area are used to indicate which coil of the dual radiant element will heat. The **SINGLE** marking indicates that only the inner coil will heat (Figure 3). The **DOUBLE** marking indicates that both inner and outer coils will heat (Figure 4). You may switch between settings at any time during cooking.

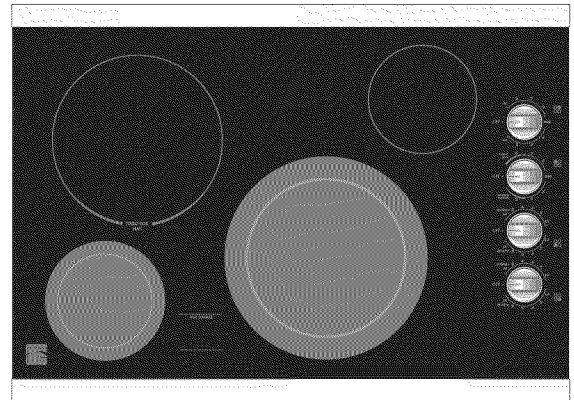

Figure 1

### To Operate the Dual Surface Element:

1. Place correctly sized cookware on the dual surface element.
2. Push in and turn the control knob counterclockwise (See Figure 3) for smaller cookware or clockwise (See Figure 4) for larger cookware.
3. Turn the knob to adjust the setting if needed. Start most cooking operations on a higher setting and then turn to a lower setting to finish cooking. Each surface element provides a constant amount of heat at each setting. A glowing red surface heating area extending beyond the bottom edge of the cookware indicates the cookware is **too small** for the surface heating area.
4. **When cooking has completed, turn the surface control knob to OFF before removing the cookware. Note:** The Hot Surface Indicator light will come on when the control knob is turned on and will continue to glow until the glass cooktop has cooled down to a moderate level that will not cause burns if the area is touched. The light may remain on even though the controls are turned OFF.

**Note:** See Table on page 7 for recommended control settings.

**⚠ WARNING** Radiant surface elements may appear to have cooled after they have been turned off. A hot surface indicator light will come on and will continue to glow until the glass cooktop has cooled down to a moderate level. **The glass surface may still be hot** and burns may occur if the glass surface is touched before the indicator light has turned off.

**⚠ WARNING** Do not place plastic items such as salt and pepper shakers, spoon holders or plastic wrappings on cooktop when it is in use. These items could melt or ignite. Potholders, towels or wooden spoons could catch fire if placed too close to the surface elements.

**⚠ CAUTION** Do not allow aluminum foil, or ANY material that can melt to make contact with the ceramic glass cooktop. If these items melt on the cooktop they will damage the ceramic cooktop.



Figure 2

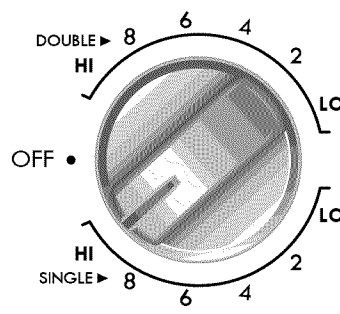

Figure 3  
Single Setting

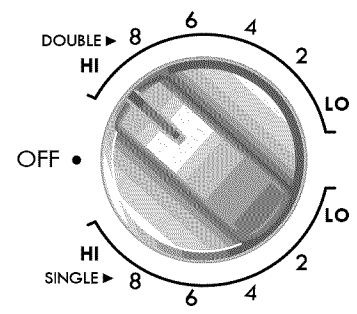
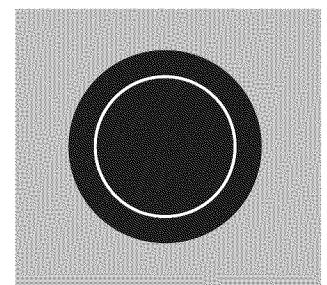
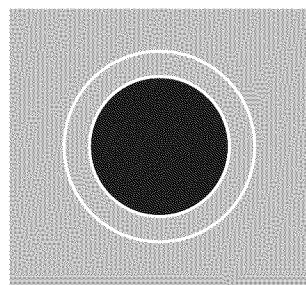

Figure 4  
Dual Setting



Dual Radiant heating areas on ceramic smooth top  
(shown in black)

# General Care & Cleaning

## Cleaning Your Cooktop

Before cleaning any part of the cooktop, be sure all controls are turned OFF and the cooktop is COOL. REMOVE SPILLOVERS AND HEAVY SOILING AS SOON AS POSSIBLE. REGULAR CLEANINGS NOW WILL REDUCE THE DIFFICULTY AND EXTENT OF A MAJOR CLEANING LATER.

Surfaces	How to Clean
<b>Painted and Plastic</b> Control Knobs, Body Parts, and Decorative Trim	For general cleaning, use hot soapy water and a cloth. For more difficult soils and built-up grease, apply a liquid detergent directly onto the soil. Leave on soil for 30 to 60 minutes. Rinse with a damp cloth and dry. <b>DO NOT</b> use abrasive cleaners on any of these materials; they can scratch or dull the finish.
<b>Stainless Steel, Chrome parts</b> Decorative Trim Cooktop	Clean with hot, soapy water and a dishcloth. Rinse with clean water and cloth. <b>Do not use cleaners with high concentrations of chlorides or chlorines.</b> Do not use harsh scrubbing cleaners. Only use kitchen cleaners that are especially made for cleaning stainless steel. Always be sure to rinse the cleaners off from the surface as bluish stains may occur during heating that cannot be removed.
<b>Ceramic Glass</b> Cooktop	See <b>Ceramic Glass Cooktop Cleaning &amp; Maintenance</b> in this Use & Care Guide.

## Ceramic Glass Cooktop Cleaning & Maintenance

**Consistent and proper cleaning is essential to maintaining your Ceramic glass cooktop**

Prior to using your cooktop for the first time, apply the recommended CookTop® Cleaning Creme to the ceramic surface (on the web visit [www.sears.com](http://www.sears.com) for replacement cooktop cleaner, item number 40079). Buff with a **non-abrasive** cloth or **no-scratch** cleaning pad. This will make cleaning easier when soiled from cooking. The special cooktop cleaning cream leaves a protective finish on the glass to help prevent scratches and abrasions.

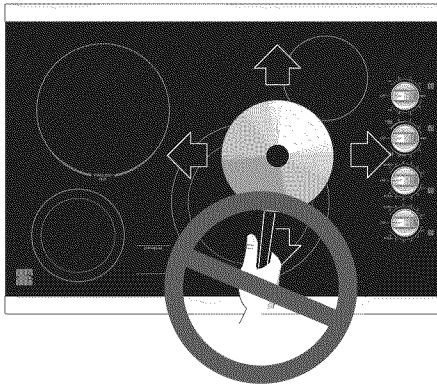

Sliding aluminum or copper clad bottom pans on the cooktop can cause metal markings on the cooktop surface. These marks should be removed **immediately** after the cooktop has cooled using the cooktop cleaning cream. Metal marks can become permanent if not removed prior to future use.

Cookware (cast iron, metal, ceramic or glass) with rough bottoms can mark or scratch the cooktop surface. **Do not slide anything metal or glass** across the cooktop. **Do not** use your cooktop as a cutting board or work surface in the kitchen. **Do not** cook foods directly on the cooktop surface without a pan. **Do not** drop heavy or hard objects on the glass cooktop, because they may cause it to crack.

# General Care & Cleaning

## Cleaning Recommendations for the Ceramic Glass Cooktop

**CAUTION** Before cleaning the cooktop, be sure the controls are turned to **OFF** and the cooktop is **COOL**.

**WARNING** **DO NOT** use a cooktop cleaner on a hot cooktop. The fumes can be hazardous to your health, and can chemically damage the ceramic glass surface.

### For light to moderate soil:

Apply a few drops of CookTop® Cleaning Creme directly to the cooktop. Use a paper towel or use a **non-abrasive** plastic type **no-scratch** pad to clean the entire cooktop surface. Make sure the cooktop is cleaned thoroughly, leaving no residue.

### For heavy, burned on soil:

Apply a few drops of CookTop® Cleaning Creme directly to the soiled area. Rub the soiled area using a **non-abrasive** plastic type **no-scratch** pad, applying pressure as needed. Do not use the pad you use to clean the cooktop for any other purpose.

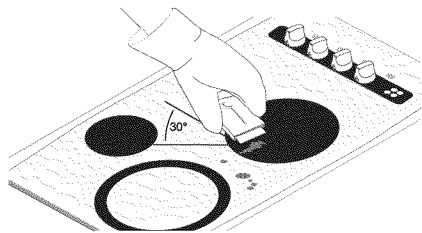

If soils remain, carefully scrape them with a metal razor blade scraper, holding scraper at a 30 degree angle to the surface. Remove loosened soils, then apply a few drops of cleaning cream and buff surface clean.

**IMPORTANT NOTE:** Damage to the ceramic glass cooktop may occur if you use an abrasive type scratch pad. Only use cleaning products that have been specifically designed for ceramic glass cooktop.

### Plastic or foods with a high sugar content:

These types of soils need be removed immediately if spilled or melted onto the ceramic cooktop surface. Permanent damage (such as pitting of the cooktop surface) may occur if not removed **immediately**. After turning the surface elements **OFF**, use a razor blade scraper or a metal spatula with a mitt and scrape the soil from the hot surface (as illustrated). Allow the cooktop to cool, and use the same method for heavy or burned on soils.

### Do not use the following on the ceramic glass cooktop:

- Do not use abrasive cleaners and scouring pads, such as metal and some nylon pads. They may scratch the cooktop, making it more difficult to clean.
- Do not use harsh cleaners, such as chlorine bleach, ammonia or oven cleaners, as they may etch or discolor the cooktop.
- Do not use dirty sponges, cloths or paper towels, as they can leave soil or lint on the cooktop which can burn and cause discoloration.

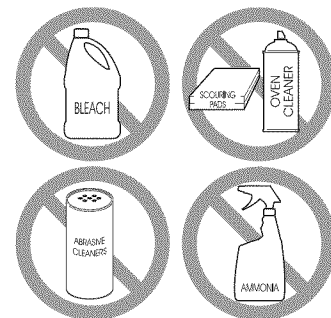

### Special Caution for Aluminum Foil and Aluminum Cooking Utensils

- **Aluminum foil:** Use of aluminum foil will damage the cooktop. Do not use under any circumstances.
- **Aluminum utensils:** Since the melting point of aluminum is much lower than that of other metals, care must be taken when aluminum pots or pans are used. Pans that boil dry may permanently damage cooktop by breaking, fusing to, or marking it.

## Before You Call

OCCURRENCE	POSSIBLE CAUSE/SOLUTION
<b>Entire cooktop does not operate.</b>	House fuse has blown or circuit breaker has tripped. Check/reset breaker or replace fuse. If the problem is a circuit overload, have this situation corrected by a qualified electrician.
	Wiring connection is not complete. Call 1-800-4-MY-HOME® for service (see back cover).
	Power outage. Check house lights to be sure. Call your local electric company for service.
<b>Surface element does not heat.</b>	No power to the appliance. Check steps under “Entire Cooktop Does Not Operate” in this <b>Before You Call</b> checklist.
	Too low heat setting. Turn control to a slightly higher setting until element comes on.
	Incorrect control is on. Be sure to use correct control for the element to be used.
<b>Surface element too hot or not hot enough.</b>	Incorrect control setting. Raise or lower setting until proper amount of heat is obtained. Dial markings are an indicator of relative heat settings and will vary slightly.
	Voltage is incorrect. Be sure appliance is properly connected to the specified power source. If you are not sure about this requirement call 1-800-4-MY-HOME® for service (see back cover).
	Lightweight or warped pans were used. Be sure to use proper cookware. Use only flat bottom, evenly balanced medium or heavyweight cookware. Heavy and medium weight pans heat evenly. Because lightweight pans heat unevenly, foods may burn easily.
<b>Food not heating evenly.</b>	Lightweight or warped pans were used. Be sure to use proper cookware. Use only flat bottom, evenly balanced medium or heavyweight cookware. Heavy and medium weight pans heat evenly. Because lightweight pans heat unevenly, foods may burn easily.
	Incorrect control setting. Raise or lower setting until proper amount of heat is obtained.
<b>Scratches or abrasions on Ceramic glass cooktop surface.</b>	Coarse particles such as salt or sand between cooktop and utensils can cause scratches. Be sure cooktop surface and bottoms of utensils are clean before usage. Small scratches do not affect cooking and will become less visible with time.
	Cleaning materials not recommended for ceramic-glass cooktop have been used. See <b>Ceramic Glass Cooktop Cleaning &amp; Maintenance</b> in this Use and Care Guide.
	Cookware with rough bottom has been used. Use smooth, flat-bottomed cookware.
<b>Metal marks on Ceramic glass cooktop surface.</b>	Sliding or scraping of metal utensils on cooktop surface. Do not slide metal utensils on cooktop surface. Use a ceramic-glass cooktop cleaning cream to remove the marks. See <b>Ceramic Glass Cooktop Cleaning &amp; Maintenance</b> in this Use and Care Guide.
<b>Brown streaks and specks on Ceramic glass cooktop surface.</b>	Boilovers have cooked onto surface. Use razor blade scraper to remove soil. See <b>Ceramic Glass Cooktop Cleaning &amp; Maintenance</b> in this Use and Care Guide.
	Cleaning materials not recommended for ceramic-glass cooktop have been used. Use recommended cleaners and cleaning method. See <b>Ceramic Glass Cooktop Cleaning &amp; Maintenance</b> in this Use and Care Guide.
<b>Areas of discoloration on Ceramic glass cooktop surface.</b>	Mineral deposits from water and food. Remove using a ceramic-glass cooktop cleaning creme. To avoid this occurrence use cookware with clean, dry bottoms.

# PROTECTION AGREEMENTS

## Master Protection Agreements

*Congratulations on making a smart purchase. Your new Kenmore® product is designed and manufactured for years of dependable operation. But like all products, it may require preventive maintenance or repair from time to time. That's when having a Master Protection Agreement can save you money and aggravation.*

The Master Protection Agreement also helps extend the life of your new product. Here's what the Agreement\* includes:

- ☑ **Parts and labor** needed to help keep products operating properly **under normal use**, not just defects. Our coverage goes **well beyond the product warranty**. No deductibles, no functional failure excluded from coverage – **real protection**.
- ☑ **Expert service** by a force of more than **10,000 authorized Sears service technicians**, which means someone you can trust will be working on your product.
- ☑ **Unlimited service calls and nationwide service**, as often as you want us, whenever you want us.
- ☑ **«No-lemon» guarantee** – replacement of your covered product if four or more product failures occur within twelve months.
- ☑ **Product replacement** if your covered product can't be fixed.
- ☑ **Annual Preventive Maintenance Check** at your request – no extra charge.
- ☑ **Fast help by phone** – we call it **Rapid Resolution** – phone support from a Sears representative on all products. Think of us as a «talking owner's manual».
- ☑ **Power surge protection** against electrical damage due to power fluctuations.
- ☑ **\$250 Food Loss Protection** annually for any food spoilage that is the result of mechanical failure of any covered refrigerator or freezer.
- ☑ **Rental reimbursement** if repair of your covered product takes longer than promised.
- ☑ **10% discount** off the regular price of any non-covered repair service and related installed parts.

Once you purchase the Agreement, a simple phone call is all that it takes for you to schedule service. You can call anytime day or night, or schedule a service appointment online.

The Master Protection Agreement is a risk free purchase. If you cancel for any reason during the product warranty period, we will provide a full refund. Or, a prorated refund anytime after the product warranty period expires. Purchase your Master Protection Agreement today!

**Some limitations and exclusions apply. For prices and additional information in the U.S.A. call 1-800-827-6655.**

**\* Coverage in Canada varies on some items. For full details call Sears Canada at 1-800-361-6665.**

## Sears Installation Service

*For Sears professional installation of home appliances, garage door openers, water heaters, and other major home items, in the U.S.A. or Canada call **1-800-4-MY-HOME**®.*

## Acuerdos maestros de protección

*Enhorabuena por haber hecho una compra inteligente. Su nuevo producto Kenmore® está diseñado y fabricado para brindarle años de funcionamiento fiable. Pero, como cualquier producto, puede necesitar mantenimiento preventivo o reparaciones periódicas. Es por eso que tener un Acuerdo maestro de protección podría ahorrarle dinero y molestias.*

El Acuerdo maestro de protección también sirve para prolongar la durabilidad de su nuevo producto. El acuerdo\* incluye lo siguiente:

- ☑ **Piezas y mano de obra** necesarias para contribuir a mantener el funcionamiento adecuado de los productos **utilizados en condiciones normales de uso**, no sólo en caso de defectos de los productos. Nuestra cobertura va **mucho más allá que la garantía del producto**. No se aplican deducibles ni exclusiones por fallas del funcionamiento: es decir, **verdadera protección**.
- ☑ **Servicio técnico por expertos** (más de **10000 técnicos autorizados de Sears**), lo cual significa que quien repare o realice el mantenimiento de su producto será un profesional de confianza.
- ☑ **Servicio técnico a escala nacional y número ilimitado de llamadas de solicitud de servicio técnico**: se puede poner en contacto con nosotros cuantas veces lo desee y cuando lo desee.
- ☑ **Garantía «sin sorpresas»**: se reemplaza el producto cubierto por el acuerdo si ocurren cuatro o más fallas del producto en un periodo de 12 meses.
- ☑ **Reemplazo del producto**: en caso de que no se pueda reparar el producto cubierto por el acuerdo.
- ☑ **Revisión anual preventiva de mantenimiento del producto**: puede solicitarla en cualquier momento, sin costo alguno.
- ☑ **Rápida asistencia telefónica**, la cual denominamos **Solución rápida**: es decir, asistencia telefónica a través de cualquiera de nuestros representantes de Sears, sobre cualquiera de nuestros productos. Piense en nosotros como en un «manual parlante del usuario».
- ☑ **Protección contra fallas eléctricas**, contra daños debidos a fluctuaciones de la corriente eléctrica.
- ☑ **\$250 al año para cubrir cualquier posible deterioro de alimentos** que haya tenido que desechar debido a una falla mecánica de cualquiera de nuestros refrigeradores o congeladores cubiertos por este acuerdo.
- ☑ **Devolución de gastos de alquiler de electrodomésticos** si la reparación de su producto asegurado toma más que el tiempo prometido.
- ☑ **10% de descuento** aplicable tanto a los costos del servicio de reparación, como de las piezas instaladas relacionadas que no hayan quedado cubiertos por este acuerdo.

Una vez que haya realizado el pago de este acuerdo, bastará una simple llamada telefónica para concertar una visita de servicio. Puede llamar a cualquier hora del día o de la noche, o bien concertar una visita de servicio por Internet.

La adquisición del Acuerdo maestro de protección es una inversión exenta de riesgos. Si por cualquier motivo decide cancelar dicho acuerdo durante el periodo de garantía del producto, le haremos un reintegro total del valor. O bien un importe proporcional si cancela el acuerdo en cualquier otro momento posterior al vencimiento del periodo de garantía del producto. ¡Adquiera hoy mismo su Acuerdo maestro de protección!

**Algunas limitaciones y exclusiones podrían aplicarse. Para solicitar precios e información adicional, llame al 1-800-827-6655 (en los EE.UU.).**

**\* La cobertura en Canadá varía en el caso de algunos artículos. Para obtener detalles completos al respecto, llame al 1-800-361-6665 de Sears de Canadá.**

## Servicio de instalación de Sears

*Para solicitar la instalación por profesionales de Sears de electrodomésticos, abridores de puertas de garaje, calentadores de agua y otros artículos de uso prioritario en el hogar, llame al **1-800-4-MY-HOME** en los EE.UU. o Canadá.*

# Get it fixed, at your home or ours!

## Your Home

For troubleshooting, product manuals and expert advice:



[www.managemylife.com](http://www.managemylife.com)

For repair – **in your home** – of **all** major brand appliances, lawn and garden equipment, or heating and cooling systems, **no matter who made it, no matter who sold it!**

For the replacement parts, accessories and owner's manuals that you need to do-it-yourself.

For Sears professional installation of home appliances and items like garage door openers and water heaters.

**1-800-4-MY-HOME<sup>®</sup>** (1-800-469-4663)

Call anytime, day or night (U.S.A. and Canada)

[www.sears.com](http://www.sears.com)

[www.sears.ca](http://www.sears.ca)

## Our Home

For repair of carry-in items like vacuums, lawn equipment, and electronics, call anytime for the location of your nearest

**Sears Parts & Repair Service Center**

**1-800-488-1222** (U.S.A.)

[www.sears.com](http://www.sears.com)

**1-800-469-4663** (Canada)

[www.sears.ca](http://www.sears.ca)

To purchase a protection agreement on a product serviced by Sears:

**1-800-827-6655** (U.S.A.)

**1-800-361-6665** (Canada)

Para pedir servicio de reparación a domicilio, y para ordenar piezas:

**1-888-SU-HOGAR<sup>®</sup>**

(1-888-784-6427)

[www.sears.com](http://www.sears.com)

Au Canada pour service en français:

**1-800-LE-FOYER<sup>MC</sup>**

(1-800-533-6937)

[www.sears.ca](http://www.sears.ca)

The Sears logo, featuring the word "sears" in a lowercase, serif font with a distinctive dot over the 's'.

® Registered Trademark / <sup>TM</sup> Trademark of KCD IP, LLC in the United States, or Sears Brands, LLC in other countries

® Marca Registrada / <sup>TM</sup> Marca de Fábrica de KCD IP, LLC en Estados Unidos, o Sears Brands, LLC in otros países

<sup>MC</sup> Marque de commerce / <sup>MD</sup> Marque déposée de Sears Brands, LLC