

Blu-ray Disc Player  
Lecteur Blu-ray Disc

# BD-S473

*Owner's Manual*  
*Mode d'emploi*  
*Bedienungsanleitung*  
*Bruksanvisning*  
*Manuale di istruzioni*  
*Manual de Instrucciones*  
*Gebruiksaanwijzing*

English

Français

Deutsch

Svenska

Italiano

Español

Nederlands

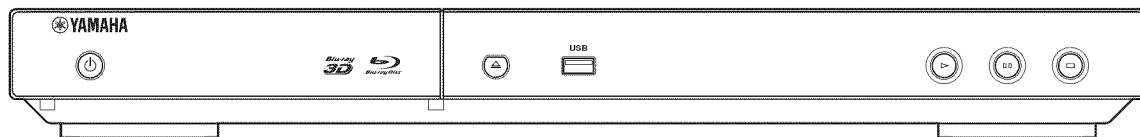

## Important notes for users in the U.K.

### Mains plug

This apparatus is fitted with an approved 13 Amp plug. To change a fuse in this type of plug proceed as follows:

- 1 Remove fuse cover and fuse.
- 2 Fix new fuse which should be a BS1362 5 Amp, A.S.T.
- 3 Refit the fuse cover.

If the fitted plug is not suitable for your jack outlets, it should be cut off and an appropriate plug fitted in its place.

If the mains plug contains a fuse, this should have a value of 5 Amp. If a plug without a fuse is used, the fuse at the distribution board should not be greater than 5 Amp.

Note: The severed plug must be disposed to avoid a possible shock hazard should it be inserted into a 13 Amp jack elsewhere.

### How to connect a plug

The wires in the mains lead are coloured with the following code:

blue = neutral (N), brown = live (L).

- As these colours may not correspond with the colour markings identifying the terminals in your plug, proceed as follows:
  - Connect the blue wire to the terminal marked N or coloured black
  - Connect the brown wire to the terminal marked L or coloured red.
  - Do not connect either wire to the earth terminal in the plug, marked E (or e) or coloured green (or green and yellow).

Before replacing the plug cover, make certain that the cord grip is clamped over the sheath of the lead - not simply over the two wires.

### Copyright in the U.K.

Recording and playback of material may require consent. See Copyright Act 1956 and The Performer's Protection Acts 1958 to 1972.

## VAROITUS

Muiden kuin tässä esitettyjen toimintojen säädön tai asetusten muutto saattaa altistaa vaaralliselle säteilylle tai muille vaarallisille toiminnoille.

### DK

Advarsel: Usynlig laserstråling ved åbning når sikkerhedsafbrydere er ude af funktion. Undgå udsættelse for stråling.

Bemærk: Netafbryderen  er sekundært indkoblet og afbryder ikke strømmen fra nettet. Den indbyggede netdel er derfor tilsluttet til lysnettet så længe netstikket sidder i stikkontakten.

### N

Observer: Nettbryteren  er sekundært innkopleet. Den innebygdenetdelen er derfor ikke frakopleet nettet så lenge apparatet er tilsluttet nettkontakten.

### S

Klass I laseraparat

Varning! Om apparaten används på annat sätt än i denna bruksanvisning specificerats, kan användaren utsättas för osynlig laserstrålning, som överskrider gränsen för laserklass 1.

Observera! Strömbrytaren  är sekundärt kopplad och inte bryter inte strömmen från nätet. Den inbyggda nät delen är därför ansluten till elnätet så länge stickproppen sitter i vägguttaget.

### SF

Luokan I laserlaite

Varoitus! Laitteen käyttäminen muulla kuin tässä käyttöohjeessa mainitulla tavalla saattaa altistaa käyttäjän turvallisuusluokan I ylittävälle näkymättömälle lasersäteilylle.

Oikeus muutoksiin varataan. Laite ei saa olla alttiina tippu- ja roiskevedelle.

Toiminnanvalitsin  on kytketty toisipuolelle, eikä se kytkä laitetta irti sähköverkosta. Sisäänrakennettu verkko-osa on kytkettyä sähköverkkoon aina silloin, kun pistoke on pistorasiassa.

### VARO!

AVATTAESSA JA SUOJALUKITUS  
OHITETTAESSA OLET ALTTIINA  
NÄKYMÄTTÖMÄLLE LASERSÄTEILYLLE.  
ÄLÄ KATSO SÄ TEESEEN.

### WARNING!

OSYNLIG LASERSTRÅLNING NÄR DENNA DEL  
ÄR ÖPPNAD OCH SPÄRREN ÄR URKOPPLAD.  
BETRAKTA EJ STRÅLEN.

**CAUTION**

Use of controls or adjustments or performance of procedures other than those specified herein may result in hazardous radiation exposure.

**AVERTISSEMENT**

L'utilisation de commandes et l'emploi de réglages ou de méthodes autres que ceux décrits ci-dessous, peuvent entraîner une exposition à un rayonnement dangereux.

**VORSICHT**

Die Verwendung von Bedienelementen oder die Einstellung bzw. die Ausführung von anderen als in dieser Anleitung beschriebenen Vorgängen kann zu Gefährdung durch gefährliche Strahlung führen.

**OBSERVERA**

Användning av reglering eller justeringar eller utförande av åtgärder på annat sätt än så som beskrivs här kan resultera i farlig strålning.

**ATTENZIONE**

L'uso di controlli, regolazioni, operazioni o procedure non specificati in questo manuale possono risultare in esposizione a radiazioni pericolose.

**PRECAUCIÓN**

El uso de los controles, los ajustes o los procedimientos que no se especifican en este manual pueden causar una exposición peligrosa a la radiación.

**LET OP**

Gebruik van bedieningsorganen, instellingen of procedures anders dan beschreven in dit document kan leiden tot blootstelling aan gevaarlijke stralen.

CAUTION: INVISIBLE LASER RADIATION WHEN OPEN.  
DO NOT STARE INTO BEAM.  
DANGER: INVISIBLE LASER RADIATION WHEN OPEN.  
AVOID DIRECT EXPOSURE TO THE BEAM.

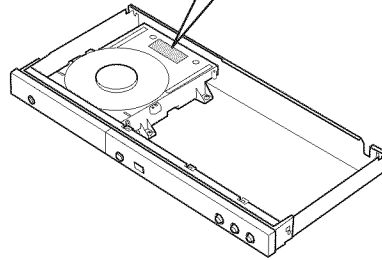
**Yamaha Music Europe GmbH**

Siemensstr. 22-34 25462 Rellingen, Germany  
Tel: +49-4101-303-0



CLASS 1 LASER PRODUCT  
LASER KLASSE 1 PRODUKT  
LUOKAN 1 LASERLAITE  
KLASS 1 LASER APPARAT  
PRODUIT LASER DE CLASSE 1

## Caution: Read this before operating your unit.

- 1 To assure the finest performance, please read this manual carefully. Keep it in a safe place for future reference.
- 2 Install this sound system in a well ventilated, cool, dry, clean place-away from direct sunlight, heat sources, vibration, dust, moisture, and/or cold. For proper ventilation, allow the following minimum clearances.  
Top : 10 cm (4 in)  
Rear: 10 cm (4 in)  
Side: 10 cm (4 in)
- 3 Locate this unit away from other electrical appliances, motors, or transformers to avoid humming sounds.
- 4 Do not expose this unit to sudden temperature changes from cold to hot, and do not locate this unit in an environment with high humidity (i.e. a room with a humidifier) to prevent condensation inside this unit, which may cause an electrical shock, fire, damage to this unit, and/or personal injury.
- 5 Avoid installing this unit where foreign object may fall onto this unit and/or this unit may be exposed to liquid dripping or splashing. On the top of this unit, do not place:
  - Other components, as they may cause damage and/or discoloration on the surface of this unit.
  - Burning objects (i.e. candles), as they may cause fire, damage to this unit, and/or personal injury.
  - Containers with liquid in them, as they may fall and liquid may cause electrical shock to the user and/or damage to this unit.
- 6 Do not cover this unit with a newspaper, tablecloth, curtain, etc. in order not to obstruct heat radiation. If the temperature inside this unit rises, it may cause fire, damage to this unit, and/or personal injury.
- 7 Do not plug in this unit to a wall outlet until all connections are complete.
- 8 Do not operate this unit upside-down. It may overheat, possibly causing damage.
- 9 Do not use force on switches, knobs and/or cords.
- 10 When disconnecting the power cable from the wall outlet, grasp the plug; do not pull the cable.
- 11 Do not clean this unit with chemical solvents; this might damage the finish. Use a clean, dry cloth.
- 12 Only voltage specified on this unit must be used. Using this unit with a higher voltage than specified is dangerous and may cause fire, damage to this unit, and/or personal injury. Yamaha will not be held responsible for any damage resulting from use of this unit with a voltage other than specified.
- 13 To prevent damage by lightning, keep the power cable disconnected from a wall outlet or this unit during a lightning storm.
- 14 Do not attempt to modify or fix this unit. Contact qualified Yamaha service personnel when any service is needed. The cabinet should never be opened for any reasons.
- 15 When not planning to use this unit for long periods of time (i.e. vacation), disconnect the AC power plug from the wall outlet.
- 16 Be sure to read the “Troubleshooting” section on common operating errors before concluding that this unit is faulty.
- 17 Before moving this unit, press  to set this unit to the standby mode, and disconnect the AC power plug from the wall outlet.
- 18 Condensation will form when the surrounding temperature changes suddenly. Disconnect the power cable from the outlet, then leave this unit alone.
- 19 When using this unit for a long time, this unit may become warm. Turn the power off, then leave this unit alone for cooling.
- 20 Install this unit near the AC outlet and where the AC power plug can be reached easily.
- 21 The batteries shall not be exposed to excessive heat such as sunshine, fire or the like.

This unit is not disconnected from the AC power source as long as it is connected to the wall outlet, even if this unit itself is turned off by . This state is called the standby mode. In this state, this unit is designed to consume a very small quantity of power.

### WARNING

TO REDUCE THE RISK OF FIRE OR ELECTRIC SHOCK, DO NOT EXPOSE THIS UNIT TO RAIN OR MOISTURE.

The laser component in this product is capable of emitting radiation exceeding the limit for Class 1.

### LASER Specification:

Class 1 LASER Product

Wave length: 790 nm (CDs)/658 nm (DVDs)/405 nm (BDs)

Laser output: max. 1 mW

### LASER SAFETY

This unit employs a laser. Due to possible eye injury, only a qualified service person should remove the cover or attempt to service this device.

### DANGER

This unit emits visible laser radiation when open. Avoid direct eye exposure to beam. When this unit is plugged into the wall outlet, do not place your eyes close to the opening of the disc tray and other openings to look into inside.

# Contents

1

## 1. Introduction

<b>What you can do with this Player</b> .....	2
<b>Supplied parts</b> .....	2
<b>About discs and files</b> .....	3
Types of discs/files that can be used with this Player ....	3
Loading a disc.....	4
Disc precautions .....	4
Notice for watching 3D video images .....	4
Cinavia technology.....	4
<b>Controls and functions</b> .....	5
Front panel.....	5
Rear panel.....	5
Remote control .....	6

## 2. Connection

<b>HDMI connection</b> .....	10
Connecting to the HDMI terminal.....	10
Connection for the playback of Blu-ray 3D Discs .....	10
<b>Network and USB connection</b> .....	11
Connecting to the NETWORK terminal .....	11
Connecting to the USB connector .....	11

## 3. Playback

<b>Initial Wizard/Easy Setup</b> .....	12
Setting with the Initial Wizard/Easy Setup.....	12
<b>HOME/MEDIA menu</b> .....	13
Playing back photo/music/video.....	13
Using network content.....	15
<b>Using network services</b> .....	16
<b>Playing videos from YouTube™</b> .....	16
<b>Advanced playback operation</b> .....	17
On Screen menu.....	17
Status menu.....	18
Using Bookmark.....	19
Program play.....	19
Using Search .....	19
Enjoying BONUSVIEW™ and BD-Live™.....	20
Using Picture in Picture function (secondary audio/video playback) .....	20
Using the feature of BD-Live™ .....	20

## 4. Settings

<b>SETUP menu</b> .....	21
Example of SETUP menu operation.....	23
General Setting.....	24
Display Setting.....	26
Audio Setting .....	27
System Information.....	27
About the audio output formats .....	28
About the video output formats .....	29
<b>Software upgrade</b> .....	30
Upgrading the software.....	30

## 5. Additional information

<b>Troubleshooting</b> .....	31
Power .....	31
Basic operation.....	31
Disc playback.....	31
Picture .....	32
Sound .....	32
Network.....	33
Messages on the screen.....	33
<b>Glossary</b> .....	34
<b>Specifications</b> .....	35
General .....	35
Input/output.....	35
Copyright .....	36
<b>Index</b> .....	37

(at the end of this manual)

Information about software .....	i
----------------------------------	---

2

3

4

5

English

## ■ About this manual

- This manual describes how to operate this Player using a remote control except when it is not available. Some of these operations are also available using the front panel buttons.
- Notes contain important information about safety and operating instructions. Hint(s) indicates a tip for your operation.
- This manual is printed prior to production. Design and specifications are subject to change in part as a result of improvements, etc. In case of differences between the manual and the product, the product has priority.

## The icons used in this manual

Icons are used to indicate available buttons/functions for a particular format. For details on playable discs and formats, see page 3.

<b>BD</b>	: BD-Video
<b>DVD</b>	: DVD-Video, DVD-VR, DVD+VR
<b>CD</b>	: Audio CD
<b>VIDEO</b>	: Video files
<b>MUSIC</b>	: Audio files
<b>PHOTO</b>	: Photo files

## What you can do with this Player

**Easy setting for language, resolution, screen aspect ratio** → p. 12

You can perform language and TV settings.

**Play back commercially-released Blu-ray Disc™/Blu-ray 3D™/DVD/CD discs\*** → p. 17

In addition to Blu-ray Discs, this Player also supports playback of a variety of other discs.

**Play back BONUSVIEW™, BD-Live™, etc.\*** → p. 20

You can enjoy additional movies on the latest Blu-ray Discs.

**Play back Video, Music, Photo files on a disc/USB memory device\*** → p. 13

Files recorded on discs/USB memory devices can be played back with this Player.

**Play back Video, Music, Photo files on a Home Network Server\*\*** → p. 15

PC contents can be played back with TV or AV receiver by connecting this Player to a network server.

**Operation with the remote control of TV, AV receiver, etc.** → p. 24

Connecting devices with an HDMI cable, you can control devices with a single remote control using the HDMI Control function.

**Streaming Playback contents on the Network Services\*\*** → p. 16

You can instantly enjoy videos over the internet with this Player.

\* For details on playable discs and formats, see page 3.

\*\* Network setting is needed to use this function.

## Supplied parts

Make sure the following accessories are provided with the product.

Remote control

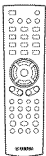

Batteries (x2)  
(AAA, R03, UM-4)

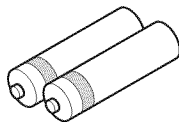

## Types of discs/files that can be used with this Player

- 12 cm (5") and 8 cm (3") discs can be played back in this Player. Do not use an 8 cm (3") to 12 cm (5") adapter.
- Use discs that conform to compatible standards as indicated by the presence of official logos on the disc label. Playback of discs not complying with these standards is not guaranteed. In addition, the image quality or sound quality is not guaranteed even if the discs can be played back.

Media Type	Recording Format
BD-ROM/BD-R/ BD-RE	BD-Video/Data files
DVD-ROM	DVD-Video
DVD-R/DVD-R DL/DVD-RW	DVD-Video/DVD-VR/AVCHD/Data files
DVD+R/DVD+R DL/DVD+RW	DVD-Video/DVD+VR/AVCHD/Data files
CD-ROM	CDDA/HDCD
CD-R/CD-RW	CDDA/Data files
USB*	Data files
DLNA	Data files

\* This Player is compatible with a USB memory device formatted with FAT 16/32 and NTFS.



Playable audio file formats	Playable video file formats	Playable photo file formats
MUSIC	VIDEO	PHOTO
MP3 (.mp3) WMA (.wma) AAC (.aac/.m4a) WAV (.wav) FLAC (.flac)	MKV with H.264 (.mkv) MPEG PS (.mpeg/.mpg) MPEG TS (.ts) MPEG-4 (.mp4) VOB (.vob) AVI (.avi) ASF (.asf) WMV (.wmv)	JPEG (.jpeg/.jpg) GIF (.gif) PNG (.png)

### Notes

- Playback of a file listed in the chart above is not guaranteed depending on methods of file creation or codecs used.
- A copyright protected file cannot be played back.
- When using DLNA, a file needs to meet the DLNA sever requirement.

## Region management information for Blu-ray Disc/DVD videos

- Blu-ray Disc/DVD video players and discs have region codes, which dictate the regions in which a disc can be played. Verify the region code mark on the rear panel of this Player.
- For a Blu-ray Disc, the disc can be played back on this Player with the same region code mark, or the region code "ABC" mark.
- For a DVD disc, the disc can be played back on this Player with the same region code mark, or the region code "ALL" mark.

Examples of region codes	
BD-Video	DVD-Video
Region code "A" or "ABC"	Region code "1" or "ALL"
	

### Notes

- Blu-ray Disc/DVD video operations and functions may be different from the explanations in this manual and some operations may be prohibited due to disc manufacturer's settings.
- If a menu screen or operating instructions are displayed during playback of a disc, follow the operating procedure displayed.
- Playback for some of the discs may not be possible depending on the disc.
- Finalize all recording media that is played back in this Player.
- "Finalize" refers to a recorder processing a recorded disc so that it will play in other players/recorders as well as this Player. Only finalized discs can be played back in this Player. (This Player does not have a function to finalize discs.)
- Playback of all files on the disc, USB memory device and network is not guaranteed.
- A copyright protected file cannot be played back via USB memory device and network.

## Audio file requirement

- Sampling frequency: within 32 - 48 kHz (MP3/WMA), LPCM 44.1 kHz/16 bit/Stereo (WAV), 192 kHz/24 bit (FLAC)
- Bitrate: within 8 - 320 kbps (MP3), 32 - 192 kbps (WMA)

## WMV file requirement

- WMV9, maximum resolution is 1,920 x 1,080.

## ■ Loading a disc

- Insert the disc with the label facing up.
- In case of the disc recorded on both sides, face down the side to play back.

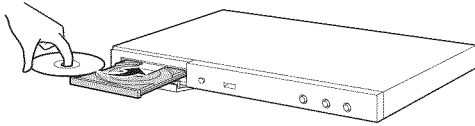

### Notes

- Playback may begin automatically, depending on the disc and setting of this Player.
- The menu may be displayed first, depending on the disc.
- The disc load time may vary depending on the disc.

## ■ Disc precautions

### Be careful of scratches and dust

- Blu-ray Disc, DVD and CD discs are sensitive to dust, fingerprints and especially scratches. A scratched disc may not be able to be played back. Handle discs with care and store them in a safe place.

### Proper disc storage

Place the disc in the center of the disc case and store the case and disc upright.	
Avoid storing discs in locations subject to direct sunlight, close to heating appliances or in locations of high humidity.	
Do not drop discs or subject them to strong vibrations or impacts.	
Avoid storing discs in locations where there are large amounts of dust or moisture.	

### Handling precautions

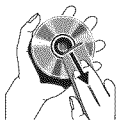

- If the surface is soiled, wipe gently with a soft, damp (water only) cloth. When wiping discs, always move the cloth from the center hole toward the outer edge.
- Do not use record cleaning sprays, benzene, thinner, static electricity prevention liquids or any other solvent.
- Do not touch the surface.
- Do not stick paper or adhesive labels to the disc.
- If the playing surface of a disc is soiled or scratched, the Player may decide that the disc is incompatible and eject the disc tray, or it may fail to play the disc correctly. Wipe any dirt off the playing surface with a soft cloth.

### Cleaning the pick up lens

- Never use commercially available cleaning discs. The use of these discs can damage the lens.
- Request the nearest service center approved by Yamaha to clean the lens.

## ■ Notice for watching 3D video images

- Some people may experience discomfort (such as eye strain, fatigue, or nausea) while watching 3D video images. We recommend that all viewers take regular breaks while watching 3D video images.
- If you experience any discomfort, stop watching the 3D video images until the discomfort subsides. Consult a doctor if you experience severe discomfort.
- Read the owner's manuals (Blu-ray Disc and TV) and/or the caution messages that appear on the TV carefully.
- The vision of young children (especially those under six years old) is still under development. Consult your doctor (such as a pediatrician or eye doctor) before allowing young children to watch 3D video images.
- Adults should supervise young children to ensure they follow the recommendations described above.

## ■ Cinavia technology

- Cinavia technology is a part of the content protection system included in your Blu-ray Disc Player.

### Note

- The following messages may be displayed and playback stopped or audio outputs temporarily muted by your Blu-ray Disc player if you are playing an unauthorized copy of content that is protected by Cinavia technology.

These messages are displayed in English only.

Playback stopped. The content being played is protected by Cinavia™ and is not authorized for playback on this device.

For more information, see <http://www.cinavia.com>. Message Code 1.

Audio outputs temporarily muted. Do not adjust the playback volume. The content being played is protected by Cinavia™ and is not authorized for playback on this device.

For more information, see <http://www.cinavia.com>. Message Code 3.

### Cinavia Notice

This product uses Cinavia technology to limit the use of unauthorized copies of some commercially-produced film and videos and their soundtracks. When a prohibited use of an unauthorized copy is detected, a message will be displayed and playback or copying will be interrupted. More information about Cinavia technology is provided at the Cinavia Online Consumer Information Center at <http://www.cinavia.com>. To request additional information about Cinavia by mail, send a postcard with your mailing address to: Cinavia Consumer Information Center, P.O. Box 86851, San Diego, CA, 92138, USA.



## ■ Front panel

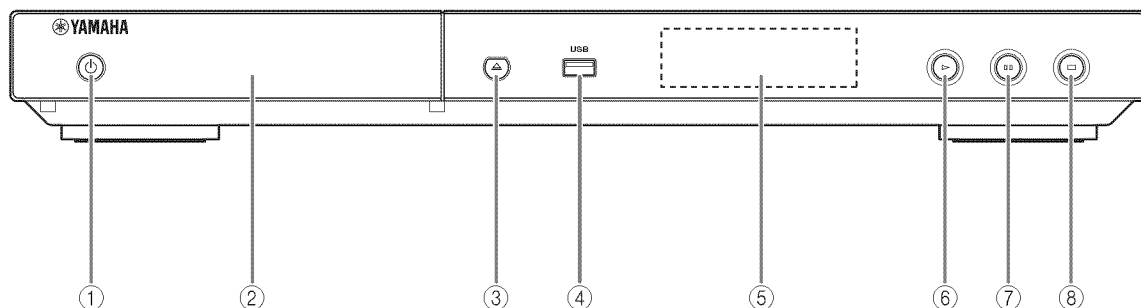

① **⏻ (On/Standby)**

Turns this Player on/Sets to standby mode.  
Pressing and holding this button for approximately 5 seconds forcibly resets this Player (system reset).

② **Disc tray door**

③ **▲ (Eject)**

Opens/Closes the disc tray.

④ **USB connector (p. 11)**

⑤ **Front panel display**

Displays various information for operational status.

⑥ **▶ (Play)**

Starts a playback.

⑦ **⏸ (Pause)**

Pauses a playback.

⑧ **■ (Stop)**

Stops a playback.

**Note**

- A factory-fitted protective film covers the front panel of this Player. Remove the protective film from the Player before operating it.

## ■ Rear panel

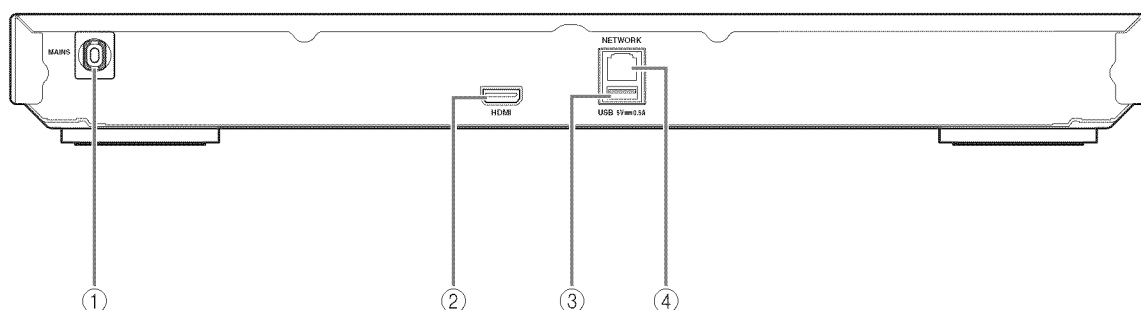

① **Power cable**

This Player has a captive power cable. Connect it to an AC outlet after all connections are made (p. 10).

**Note**

- To prevent risk of electric shock, do not touch the un-insulated parts of any cables while the power cable is connected.

② **HDMI terminal (p. 10)**

③ **USB connector (p. 11)**





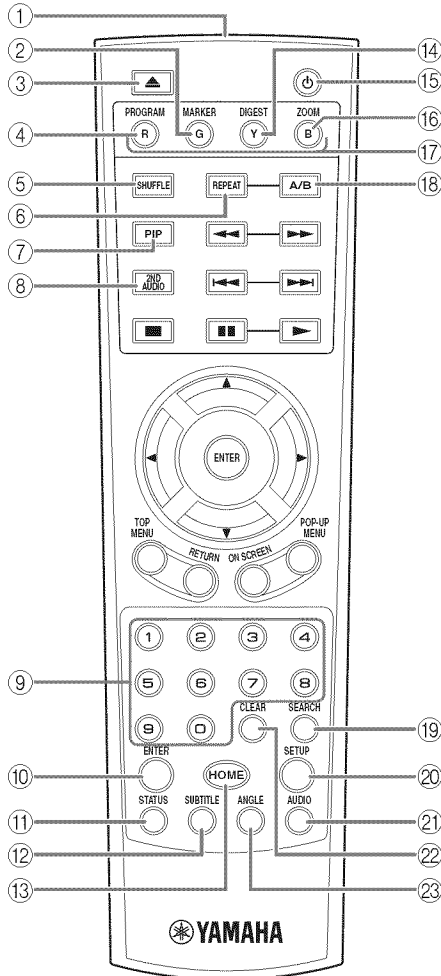

④ **NETWORK terminal (p. 11)**

## Remote control

### Note

-  will appear on the top left corner of the screen when the pressed button is not available.



- Infrared signal transmitter:** Outputs infrared signal. Aim this window to the remote control sensor (p. 9).
- MARKER DVD VIDEO:** Sets Bookmark (p. 19) at a specified point of a movie. After Bookmark is set, to select the set point you want to jump to, press **DIGEST**. You can set up to 12 Bookmarks.
- ▲:** Opens/closes the disc tray.
- PROGRAM DVD CD:** Sets the order of playback (p. 19). You can set up to 15 tracks (for an audio disc) or titles/chapters (DVD-Video).
- SHUFFLE DVD CD VIDEO MUSIC PHOTO:** Selects shuffle play mode (p. 17).
- REPEAT BD DVD CD VIDEO MUSIC PHOTO:** Changes repeat mode. Repeat mode shown below will change each time you press the button.
  - : Repeats the title being played back.
  - : Repeats the chapter being played back.
  - : Repeats the folder being played back.
  - : Repeats all tracks/files on the disc.
  - : Repeats the track/file being played back.
- PIP BD:** Turns on/off the Picture in Picture (p. 20). PIP Mark () is displayed on the screen when this function is available. You can also select this item from On Screen menu (p. 17).
- 2ND AUDIO BD:** Selects the secondary audio of the Picture in Picture (p. 20) or audio commentaries. The Secondary Audio Mark () is displayed on the screen when this function is available (p. 27). You can also select this item from On Screen menu (p. 17).

### Note

- PIP Mark is displayed only when the PIP Mark is set to on (p. 25).

### Note

- Secondary Audio Mark is displayed only when Secondary Audio Mark is set to on (p. 25).
- Number buttons:** Enters numbers, or during playback, jumps to the track/chapter corresponding to the number you input. These buttons may not be available depending on the disc type and playback condition.
  - ENTER:** Selects the focused menu/item.
  - STATUS:** Displays the playback information (p. 18).
  - SUBTITLE BD DVD VIDEO:** Changes subtitle languages (p. 35) if available. You can also select this item from On Screen menu (p. 17).

- ⑬ **HOME**: Displays the HOME menu screen (p. 13).
- ⑭ **DIGEST PHOTO**: Shows 12 photo thumbnails.  
When thumbnails are displayed, you can proceed to the next/previous page with ◀◀/▶▶.
- DVD VIDEO**: Displays Bookmark select bar (p. 19).
- ⑮ **⏻**: Turns this Player on or sets it to standby mode.
- ⑯ **ZOOM DVD VIDEO PHOTO**: Zooms in/out.  
The size of the screen will change each time you press the button (zoom in/out: 3 steps each).
- ⑰ **Color buttons BD**: Use these buttons according to on-screen instructions.
- ⑱ **A/B BD DVD CD VIDEO MUSIC**: Plays back a specific part you want to repeat.
- 1 Press **A/B** at the scene where you want to set the start point. "A-" is displayed on the screen.
  - 2 Press **A/B** again at the scene where you want to set the end point. "A-B" is displayed on the screen. Repeat playback starts.
  - 3 To cancel the repeat playback, press **A/B**. "A-B" disappears and the repeat playback is finished.

**Note**

– This function cannot be performed depending on the specifications of the disc.

- ⑲ **SEARCH BD DVD CD VIDEO MUSIC**:  
Jumps to a specified point during playback. For details on this function, refer to "Using Search" (p. 19). You can also select this item from status menu (p. 18).
- ⑳ **SETUP**: Displays SETUP menu screen (p. 21).
- ㉑ **AUDIO BD DVD**: Changes the audio language or format. You can also select this item from On Screen menu (p. 17).
- ㉒ **CLEAR**: Clears entered number/set item.
- ㉓ **ANGLE BD DVD**: Changes the camera angle if video is recorded with multiple angles. The Angle Mark () is displayed on the screen when this function is available. You can also select this item from On Screen menu (p. 17).

**Note**

– Angle Mark is displayed only when the Angle Mark is set to on (p. 25).

**Continued to the next page. ➔**

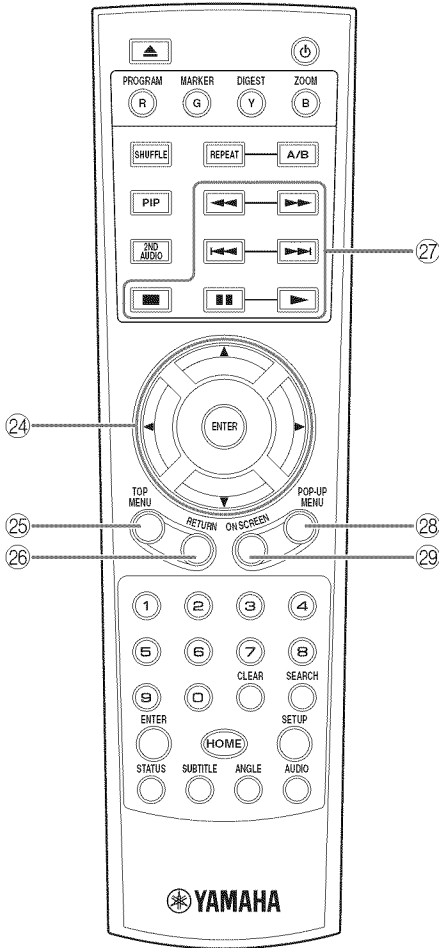

②④ **Cursor buttons (▲/▼/◀/▶)**: Moves the focus in the menu screen.

**ENTER**: Selects the focused menu/item.

②⑤ **TOP MENU** **BD** **DVD**: Displays the top menu screen if the disc contains a menu. Select the desired item using ▲/▼/◀/▶ and **ENTER**.

**Note**

– Specific operations may be different depending on the disc. Follow the instructions of each menu screen.

②⑥ **RETURN**: Returns to the previous menu or screen, etc.

②⑦ **Control buttons**

**BD** **DVD** **CD** **VIDEO** **MUSIC** **PHOTO**

■: Stops playback. To stop playback completely, press this button twice.

■: Pauses playback.

▶: Plays back contents.



**BD** **DVD** **CD** **VIDEO** **MUSIC**:

Searches backward/forward. The search speed will change each time you press the button (search backward/forward: 5 steps each). Press ▶ to resume normal playback.

**PHOTO**: Changes the speed of a slide show (slower/faster: 3 steps).

◀/▶: Skips backward/forward.

**Note**

– Depending on the disc, this Player resumes playback from the point that where the Player was previously stopped. To play back from the beginning, press ■ twice and then ▶.

②⑧ **POP-UP/MENU** **BD** **DVD**: Displays pop-up menu. The menu contents displayed vary depending on the disc. For details on how to see and operate the pop-up menu, refer to the manual for the disc. The top menu screen may be displayed by pressing **POP-UP/MENU** depending on the DVD.

②⑨ **ON SCREEN**: Displays On Screen menu (p. 17).

## Loading the batteries in the remote control

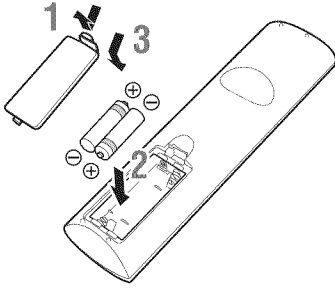

### Notes

- Change both batteries when the operation range of the remote control decreases.
- Use AAA, R03, UM-4 batteries.
- Make sure that the polarities are correct. Refer to the illustration inside the battery compartment.
- Remove the batteries if the remote control is not to be used for an extended period of time.
- Do not use old batteries together with new ones.
- Do not use different types of batteries (such as alkaline and manganese batteries) together. Read the packaging carefully as these different types of batteries may have the same shape and color.
- If the batteries have leaked, dispose of them immediately. Avoid touching the leaked material or letting it come into contact with clothing, etc. Clean the battery compartment thoroughly before installing new batteries.
- Do not throw away batteries with general house waste; dispose of them correctly in accordance with your local regulations.
- Keep batteries away from children. If a battery is accidentally swallowed, contact your doctor immediately.
- When not planning to use the remote control for long periods of time, remove the batteries from the remote control.
- Do not charge or disassemble the supplied batteries.

## Approximate operating range of remote control

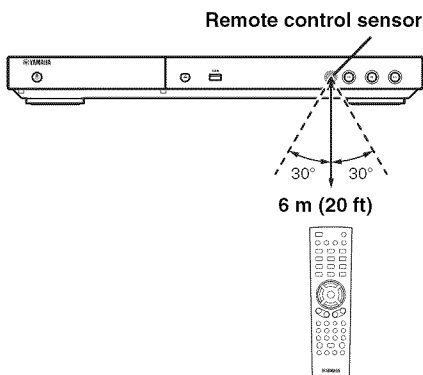

# HDMI connection

## ■ Connecting to the HDMI terminal

- You can enjoy high quality digital picture and sound through the HDMI terminal.
- Firmly connect an HDMI cable (commercially available) to the HDMI terminals.
- See page 28 for information on the audio/video output formats.
- Use HIGH SPEED HDMI cables that have the HDMI logo (as shown on the back cover).

### Caution!

**Do not connect the power cable of this Player until all connections are completed.**

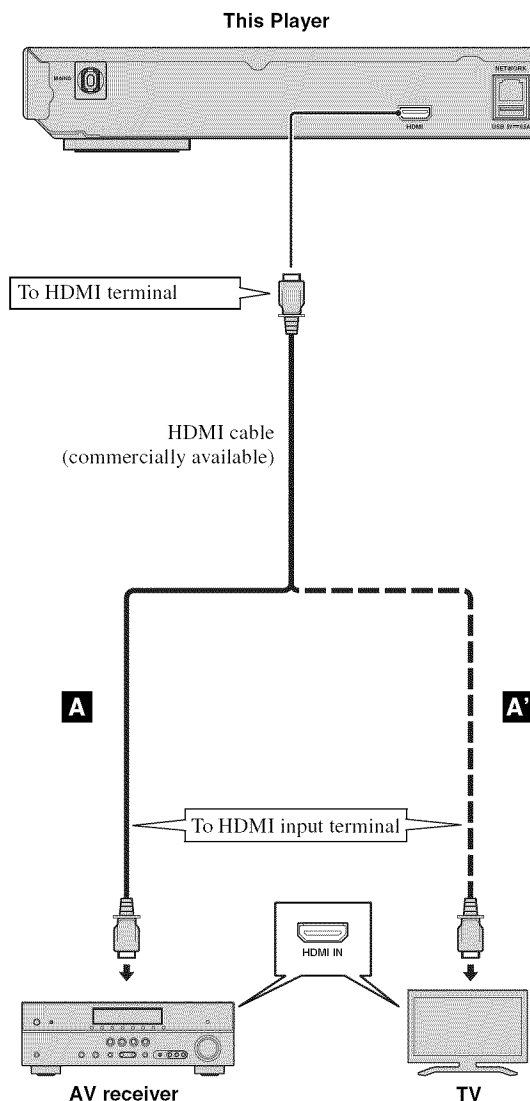

### Hints

- When you use the HDMI Control function, refer to the “HDMI Control” (p. 24).
- For information on the output mode of HDMI terminal, refer to the “HDMI” (p. 27).
- When no picture is displayed, refer to “Troubleshooting” (p. 32).

## ■ Connection for the playback of Blu-ray 3D Discs

To enjoy Blu-ray 3D Discs on this Player, you need the following equipment and connections:

- You need a TV and an AV receiver (if you need) that have 3D functionality.
- All the components must be connected with HDMI cables.
- A Blu-ray Disc should contain 3D images.
- You need to set 3D Output in Display Setting (p. 26) to Auto.

# Network and USB connection

2

Connection

## ■ Connecting to the NETWORK terminal

- PC contents can be played back by connecting this Player to the network.
- You can enjoy a variety of contents with interactive functions by connecting to the internet when playing BD-Live compatible discs. Refer to page 20 regarding further information on BD-Live functions.

### Notes

- Firmly connect a network cable (commercially available) to the NETWORK terminal.
- Use only an STP (shielded twisted pair) network cable.
- When using the internet, a broadband internet connection as shown below is required.
- Connect the other connector of the network cable to the hub/broadband router.
- When using a broadband internet connection, a contract with an internet service provider is required. For more details, contact your nearest internet service provider.
- Refer to the operation manual of the equipment you have as the connected equipment and connection method may differ depending on your internet environment.
- Use a network cable/router supporting 10BASE-T/100BASE-TX.

## ■ Connecting to the USB connector

- You can connect a USB memory device for Local Storage to the USB connector on the rear panel (or front panel) of this Player to save the BD-Live data, or to upgrade the software of this Player.
- Firmly connect a USB memory device (commercially available) to the USB connector.

### CAUTION:

- Do not remove the USB memory device or unplug the power cable while the operations for BD-Live (p. 20) or software upgrade are being performed.
- Do not use a USB extension cable when connecting a USB memory device to the USB connector of this Player. Using a USB extension cable may prevent the Player from performing correctly.

### Note

- Yamaha cannot guarantee that all brands' USB memory devices will operate with this Player.

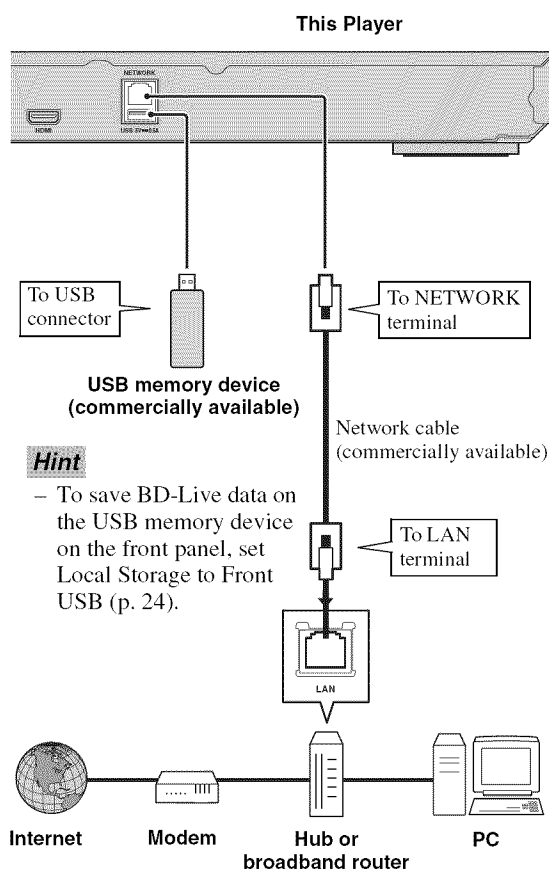

English

## After connecting

- When you set the Network setting manually, refer to "Network" (p. 25).
- To play back the PC contents on your network, refer to "Using network content" (p. 15).

# Initial Wizard/Easy Setup

## ■ Setting with the Initial Wizard/Easy Setup

Initial Wizard/Easy Setup allows you to set language, resolution, and screen aspect ratio easily. Initial Wizard screen is displayed when you turn this Player on for the first time after purchase. Same setting can be performed from SETUP menu → System → Easy Setup.

- 1 When Easy Setup screen is displayed, press **ENTER** to start Easy Setup.

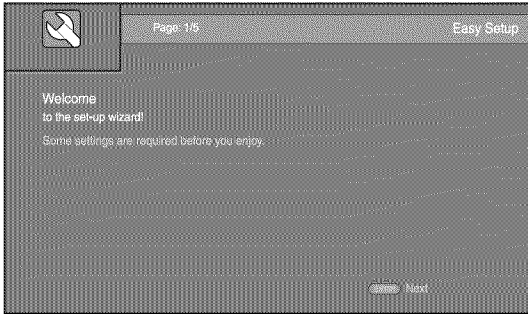

- 2 Set the language, resolution, and screen aspect ration by following the on-screen messages.

### **Notes**

- When no picture is displayed after Initial Wizard/Easy Setup is completed, refer to “Troubleshooting” (p. 32).
- A warning message concerning 3D video playback appears when this Player is turned on. Press **ENTER** to dismiss the message or **CLEAR** to disable it (p. 24).



# HOME/MEDIA menu

HOME and MEDIA menus allow you to browse and play multi-media files on data discs, USB memory devices and your network.

## Note

- For details on playable discs and formats, see page 3.

## ■ Playing back photo/music/video

### Basic operation

◀/▶/▲/▼: Moves the focus.

◀: Returns to the parent folder.

HOME: Moves to/exits HOME menu screen.

ENTER: Confirms the folder/file.

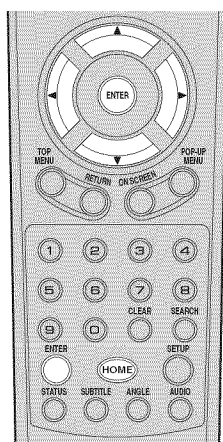

### Icons on the top of MEDIA menu

: Plays back the disc on the tray, or displays contents in the data disc.

: Displays contents in the USB memory device connected to the USB connector.

: Searches for a DLNA (p. 15) server on the network.

: Displays contents on the connected DLNA server.

### Common operations for playing back files in a selected folder

**Example:** Selecting a movie file on a USB memory device

## Note

- Stop the playback of the video before you move to MEDIA menu screen.

- 1 Press **HOME** to move to HOME menu screen.

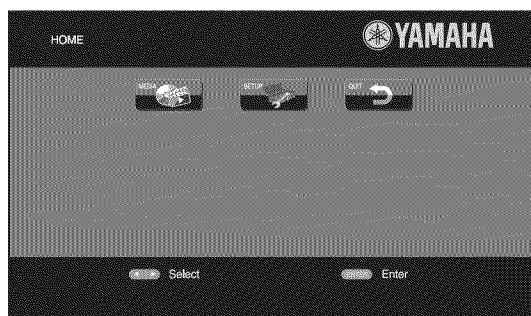

## Hint

- The HOME menu screen may differ depending on the model.

- 2 Press ◀/▶/▲/▼ to select MEDIA, then press **ENTER**. MEDIA screen appears.



- 3 Select the item which contains the file you want to play back, then press **ENTER**.



3

Playback

English

- 4 Select the Photo, Music, Video or AVCHD folder you want to play back, then press **ENTER**.

To return to the parent folder, press **◀** or select **⬆**.

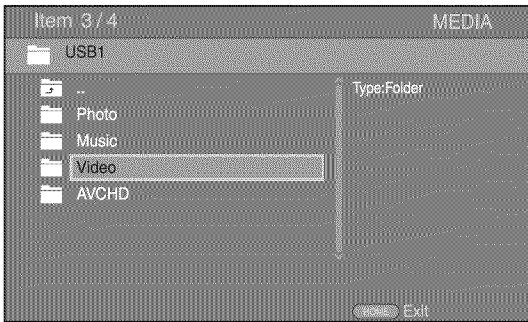

#### Note

- Note that the only the file type selected on this step will be displayed in the following step. For example, if you selected Photo folder in this step, only photo files are displayed after this step. When you want to play back other than photo, return to this step and select file type again.

- 5 Select the folder(s) containing the file you want to play back.



- 6 Select the file you want to play back, then press **ENTER**.

When a video file is selected, playback starts.

When a music file is selected, status screen is displayed and playback starts.

When a photo file is selected, slide show starts.

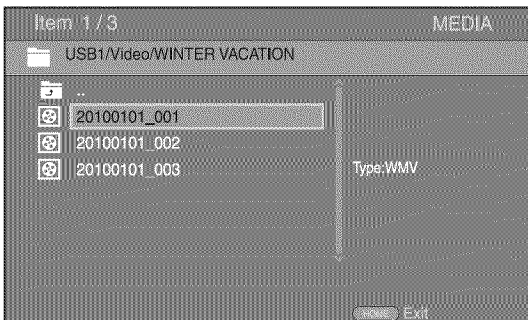

#### Hint

- To enjoy slide show with music, press **HOME** to return to the HOME menu screen while music is played back, and select photo file.

#### Note

- The displayed file may not be played back depending on the content.

### Operations for viewing photos

While viewing photos, the buttons on the remote control work as shown below.

- : Stops slide show and returns to the file browser.
- : Pauses a slide show.
- ▶: Plays a slide show.
- ▶▶: Moves to a next photo.
- ◀◀: Moves to a previous photo.
- ▶▶▶: Makes a slide show faster in 3 steps.
- ◀◀◀: Makes a slide show slower in 3 steps.
- ▲: Inverts a photo.
- ▼: Reflects a photo.
- ◀: Rotates a photo counterclockwise.
- ▶: Rotates a photo clockwise.
- : Zooms in/out a photo (zoom in/out: 3 steps each).
- ▲/▼/◀/▶: Pans in zoom mode when a photo is larger than the screen.
- DIGEST:** Switches to thumbnail mode (p. 7). When thumbnails are displayed, you can proceed to the next/previous page with ◀◀/▶▶.

## ■ Using network content

This Player is DLNA certified (p. 34). You can manage photo, music and video contents stored on DLNA servers on your home network.

### Playing back shared contents

- 1 To play back files on your PC, install a DLNA server software, such as Windows Media Player 12, and share files you want to play back.
- 2 Turn on the PC with DLNA server software installed or the DLNA device connected to your home network.
- 3 Press **HOME** to display HOME menu screen. Then select **MEDIA** to move to MEDIA menu. The DLNA servers connected to the network are listed on the screen.

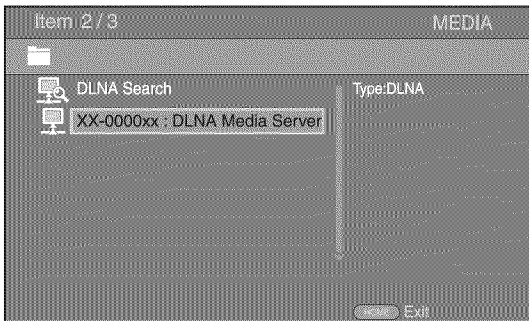

#### Notes

- If your DLNA server is not listed, select DLNA Search to find it.
  - Depending on the DLNA server, this Player may need to be permitted from the server.
  - To play the file on the DLNA server, this Player and the server must be connected to the same access point.
  - The file requirements may not always be compatible. There may be some restrictions depending on file features and DLNA sever capability.
- 4 Select the file you want to play back.

#### Notes

- The playback and operating quality may be affected by your home network condition.
- The files from removable media such as USB memory devices or DVD-drive on your media server, may not be shared properly.

## Using network services

You can instantly watch the videos that the following network services provide.

- YouTube

### Notes

- Access to content provided by third parties requires a high speed internet connection and may also require account registration and a paid subscription.
- Third party content services may be changed, suspended, interrupted, or discontinued at any time without notice, and Yamaha disclaims any liability in connection with such occurrences.
- Some content may only be available for specific countries and may be presented in specific languages.
- Yamaha does not represent or warrant that content services will continue to be provided or available for a particular period of time, and any such warranty, express or implied, is disclaimed.

## Playing videos from YouTube™

You can watch movies from YouTube over the internet using this Player.

The services may be changed without notice.

- 1 Press **HOME** to display HOME menu screen.

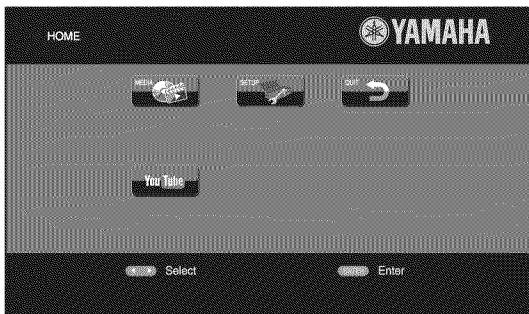

### Hint

- The HOME menu screen may differ depending on the model.

- 2 Press **◀/▶/▲/▼** to select YouTube, then press **ENTER**.

### Hint

- To return to the HOME menu screen, press **RETURN**.

# Advanced playback operation

This chapter explains playback of commercially available Blu-ray Discs, DVDs, CDs, and recorded DVD-RW/R discs.

## Note

- For the basic playback operation, see page 6.

## ■ On Screen menu

To display On Screen menu, press **ON SCREEN**. After that, press **▲/▼/◀/▶** to select an item, then press **ENTER** to operate the desired function.

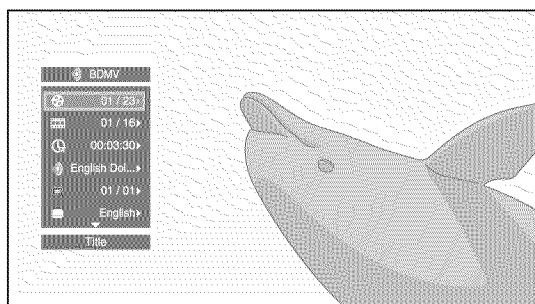

On Screen menu contains following items.

**Title** **BD** **DVD** **VIDEO** : Shows the title number being played back. You can skip to the desired title by selecting it from this item.

**Chapter** **BD** **DVD** **VIDEO** : Shows the chapter number being played back. You can skip to the desired chapter by selecting it from this item.

**Track/File** **CD** **VIDEO** **MUSIC** **PHOTO** : Shows track/file number being played back. You can skip to the desired track/file by selecting it from this item.

**Time** **BD** **DVD** **CD** **VIDEO** **MUSIC** : Shows the playback time. Select display type from the following:

- Elapsed playback time of the title, chapter, disc, track or file
- Remaining playback time of the title, chapter, disc, track or file

## Mode/Play Mode

**DVD** **CD** **VIDEO** **MUSIC** **PHOTO** : Shows current playback mode. You can select playback mode from the following:

- CD**
  - Normal: Normal playback.
  - Shuffle: Random playback without repetition.
  - Random: Random playback with repetition.

## DVD

- Normal
- Shuffle CH (chapter)
- Shuffle TT (title)
- Shuffle All
- Random CH (chapter)
- Random TT (title)
- Random All

## VIDEO MUSIC PHOTO

- Normal
- Shuffle F (folder)
- Random F (folder)

**Audio** **BD** **DVD** **VIDEO** : Shows audio language/signal of a Blu-ray Disc/DVD currently selected. You can select the desired type of audio.

**Angle** **BD** **DVD** : Shows the currently-selected angle number. If the video is recorded with multiple angles, you can change the angle.

**Subtitle** **BD** **DVD** **VIDEO** : Shows the currently-selected subtitle language when the subtitle is provided.

**Subtitle Style** **BD** : Shows the currently-selected subtitle style. This function is available only for Video-file external subtitle. You can select the desired text style of subtitle.

**Bitrate** **BD** **DVD** **CD** **VIDEO** **MUSIC** : Shows bitrate of the audio/video signal.

**Second Video** **BD** : Turns the PIP on/off (p. 6).

**Second Audio** **BD** : Turns the secondary audio on/off (p. 6).

## Ins Search

**BD** **DVD** **CD** **VIDEO** **MUSIC** : Skips 30 seconds.

## Ins Replay

**BD** **DVD** **CD** **VIDEO** **MUSIC** : Replays the content from 10 seconds before.

## Slide Show PHOTO :

Shows slide show speed. You can select the slide show speed from Slow/Medium/Fast.

**Transition** **PHOTO** : Shows how photo appears on the screen. You can select the transition type.

## ■ Status menu

This shows various settings, such as subtitles, angle settings and the title/chapter/track number currently played back. To display status menu, press **STATUS**. Status menu contains following menus.

**BD DVD VIDEO**

**Example:** Icons when playing a Blu-ray Disc

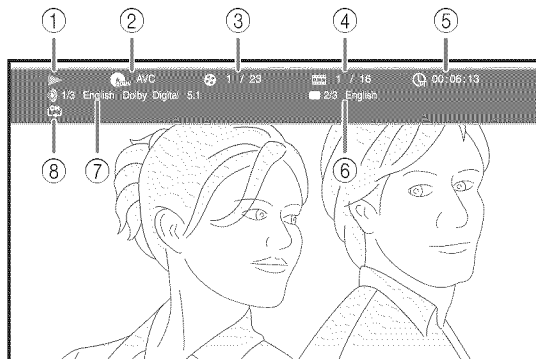

- ① **(Playback status)**
- ② **(Disc type/video file icon)**
- ③ **(Title number being played):** You can jump to specified title with **SEARCH** button (p. 7).
- ④ **(Chapter number being played):** You can jump to specified chapter with **SEARCH** button (p. 7).
- ⑤ **(Elapsed playback time):** You can jump to specified point with **SEARCH** button (p. 7).
- ⑥ **(Subtitle currently selected):** You can change the subtitle language with **SUBTITLE** button.
- ⑦ **(Audio currently selected):** You can change the audio language or format with **AUDIO** button.
- ⑧ **(Repeat mode):** Shows current repeat mode (p. 6).

**CD MUSIC**

**Example:** Icons when playing a music file

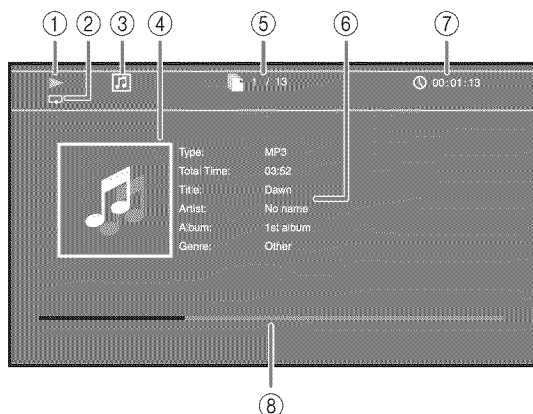

- ① **(Playback status)**
- ② **(Repeat mode):** Shows current repeat mode (p. 6).
- ③ **(Disc type/music file icon)**
- ④ **(Artwork) MUSIC:** Displays artwork if the file contains it.
- ⑤ **(Track/file number being played):** You can jump to specified track with **SEARCH** button (p. 7).
- ⑥ **(Information) MUSIC:** Displays music information if the file contains them.
- ⑦ **(Elapsed playback time):** You can jump to specified point with **SEARCH** button (p. 7).
- ⑧ **(Progress bar) MUSIC:** Shows progress status of current song.

**PHOTO**

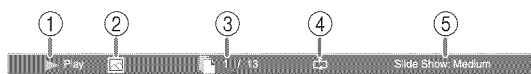

- ① **(Playback status)**
- ② **(Photo file icon)**
- ③ **(File number being displayed)**
- ④ **(Repeat mode):** Shows current repeat mode (p. 6).
- ⑤ **(Slide show speed)**

## ■ Using Bookmark **DVD** **VIDEO**

This allows you to set Bookmark at the specified point of the video. After Bookmark is set, you can move to the point you set using this function. You can set up to 12 Bookmarks.

- 1 Press **MARKER** during playing back the movie to set Bookmark. Bookmark number, and the status are displayed.

Bookmark: 1/12 Title: 1 Chapter: 1 Time: 00:01:26

- 2 After Bookmark is set, press **DIGEST** to display Bookmark select bar.

Title:01 Chapter:01 Time:00:01:26 Bookmark  
01 02 03 04 05 06 07 08 09 10 11 12 Clear

- 3 Press **◀/▶** to select the Bookmark you want to play back, then press **ENTER**. Press **CLEAR** to delete the selected Bookmark.

### Note

- When playback is finished (e.g., ejecting the disc, pressing **■** twice), Bookmarks are automatically deleted.

## ■ Program play **DVD** **CD**

This allows you to program playback order of audio disc tracks or DVD chapters.

Press **PROGRAM** during playback to display the PROGRAM window to program playback order. You can program up to 15 tracks/chapters.

**Example:** Programming the playback order of CD tracks

- 1 Press **PROGRAM** during playback.

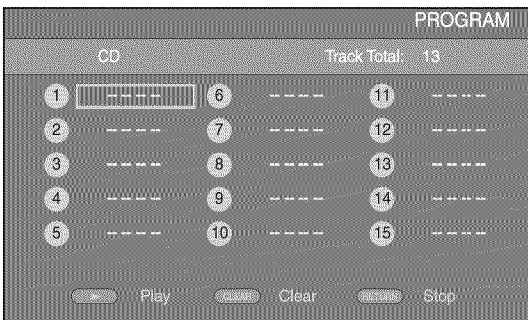

- 2 Press **ENTER** to program playback order. For audio disc, press **▲/▼** to select a desired track then press **ENTER**. For DVD-Video disc, select a desired title (shown as TT) and chapter (shown as CH) instead of a track. To clear a set track, select the track you want to clear, then press **CLEAR**. Press **RETURN** to cancel the Program play.

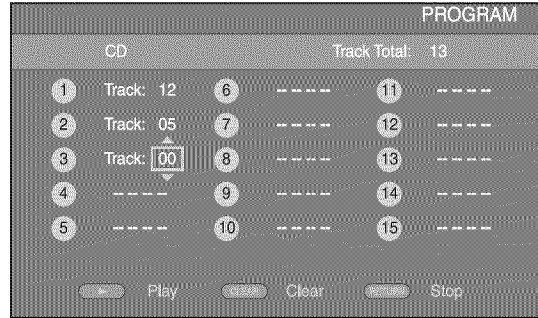

- 3 After programming is finished, press **▶** to set and start program playback.
- 4 To cancel program play, stop playback completely by pressing **■** twice.





## ■ Using Search

**BD** **DVD** **CD** **VIDEO** **MUSIC** **PHOTO**



This allows you to jump to the specified point during playback.

- 1 Press **SEARCH** during playback. Status bar appears.
- 2 Press **▲/▼/◀/▶** to select one of the item below, then press **ENTER**.



**BD** **DVD** :

- Title number (shown as )
- Chapter number (shown as )
- Elapsed title time (shown as )
- Elapsed chapter time (shown as )

**CD** :

- Track number (shown as )
- Elapsed track time (shown as )
- Elapsed disc time (shown as )

**VIDEO** **MUSIC** :

- File number (shown as )
- Elapsed file time (shown as )

**PHOTO** :

- File number (shown as )

- 3 Press **▲/▼** or number buttons to set/adjust the value of the focused item, and press **ENTER** to jump to the specified point.
- 4 To close the status bar, press **STATUS**.

## ■ Enjoying BONUSVIEW™ and BD-Live™

This Player supports BONUSVIEW (p. 34) (BD-ROM Profile 1 Version 1.1) and BD-Live (p. 34) (BD-ROM Profile 2) playback functions.



### Note

- Functions and playback method vary depending on the disc. See the guidance on the disc or the supplied user's manual.

## ■ Using Picture in Picture function (secondary audio/video playback)

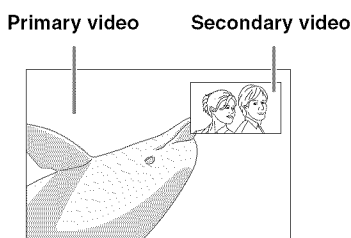
BD-Video that includes secondary audio and video compatible with Picture in Picture can be played back with secondary audio and video simultaneously as a small video in the corner.



**While PIP Mark (  ) or Secondary Audio Mark (  ) is displayed, press PIP to turn the Picture in Picture function on/off.**

### Notes

- To listen to secondary audio, make sure that the Audio Output setting (HDMI) is set to PCM or Reencode (p. 27).
- Depending on the disc, to listen to secondary audio, you may need to set secondary audio to on from the top menu of the disc (p. 8).
- The secondary audio and video for Picture in Picture may automatically play back and be removed depending on the content. Also, playable areas may be restricted.

## ■ Using the feature of BD-Live™

### 1. Set the Network setting (p. 25).

### 2. Connect the USB memory device to this Player (p. 11).

BD-Live data is saved in a USB memory device connected to this Player. To enjoy these functions, connect a USB memory device supporting USB 2.0 High Speed (480 Mbit/s) to the USB connector that you select on Local Storage (p. 24). The default setting is the USB connector on the rear panel.

- BUDA folder is created automatically in the USB memory device when necessary.
- If there is insufficient storage space, the data will not be copied/downloaded. Delete unneeded data or use a new USB memory device.
- Some time may be required for the data to load (read/write).

### Notes

- Yamaha cannot guarantee that all brands' USB memory devices will operate with this Player.
- Do not use a USB extension cable when connecting a USB memory device to the USB connector of the Player. Using a USB extension cable may prevent the Player from performing correctly.

### 3. Play back the disc.

### 4. Run BD-Live according to the instructions on the disc.

### Notes



- Regarding playback method of BD-Live contents, etc., perform the operations in accordance with the instructions in the Blu-ray Disc manual.
- To enjoy BD-Live functions, perform the network connection (p. 11) and Network settings (p. 25).
- Refer to "BD-Live Connection" (p. 25) regarding the setup to restrict access to BD-Live contents.
- The time required to download the provided programs into the USB memory device connected to this Player varies depending on the internet connection speeds and the data volume of the programs.
- BD-Live programs provided through the internet may not be able to display the connection depending on the status (upgrading) of the provider. In such cases, take out the disc and try again.
- If the BD-Live screen does not appear for a while after you select the BD-Live function in the Blu-ray Disc menu, the USB memory device may not have enough free space. In such cases, eject the disc from the Player, and then erase the data in the USB memory device using the "Format" menu in the "Local Storage" (p. 24).



# SETUP menu

The SETUP menu enables various audio/visual settings and adjustments for functions using the remote control unit.

Menu/Submenu	Item	Function	Page
 <b>General Setting</b>	<b>System</b>		
	Screen Saver	Sets screen saver on/off.	24
	Disc Auto Playback	Sets this Player to start disc playback automatically.	24
	HDMI Control	Sets this Player to receive control signal from the remote control of your TV/AV receiver.	24
	Load Default	Resets all settings to the default setting except Security setting.	24
	Upgrade	Performs upgrade of this Player.	24
	Easy Setup	Sets language, resolution, screen aspect ratio.	24
	Local Storage	Displays status of Local Storage (p. 24), formats Local Storage and selects the front/rear USB connector for Local Storage.	24
	3D Playback Message	Displays a warning message concerning 3D video playback when this Player is turned on.	24
	<b>Language</b>		
	OSD	Selects the language for On Screen Display.	24
	Menu	Prioritizes the language for disc menu.	24
	Audio	Prioritizes the language for audio.	24
	Subtitle	Prioritizes the language for subtitle.	24
	<b>Playback</b>		
	Angle Mark	Sets to display the Angle Mark when Blu-ray Disc/DVD with multiple angles is played back.	25
	PIP Mark	Sets to display the PIP Mark when Blu-ray Disc/DVD with Picture in Picture is played back.	25
	Secondary Audio Mark	Sets to display the Secondary Audio Mark when Blu-ray Disc/DVD with secondary audio is played back.	25
	Last Memory	Sets this Player to remember the last playback position of a disc when it is set to standby mode or the disc tray is opened.	25
	<b>Security</b>		
	Change Password	Changes password for Parental Control and Country Code.	25
	Parental Control	Sets the Parental Control depending on the disc content.	25
	Country Code	Sets your Country Code.	25
	<b>Network</b>		
	Internet Connection	Sets the internet connection to Enable/Disable.	25
	Information	Displays network information screen.	25
	Connection Test	Performs the network connection test.	25
	IP Setting	Sets the IP setting to Auto/Manual.	25
	BD-Live Connection	Sets the BD-Live connection to Permitted/Partial Permitted/Prohibited.	25
	DLNA	Sets the DLNA to Enable/Disable.	25
Proxy Setting	Sets the proxy setting.	25	

Menu/Submenu	Item	Function	Page	
 <b>Display Setting</b>	<b>TV</b>	3D Output	Selects 3D or 2D videos.	26
	TV Screen	Sets the screen aspect ratio of the connected TV, and adjust the video output.	26	
	Video Out Select	Selects the resolution of video output.	26	
	TV System	Selects the TV System from NTSC/PAL/Multi.	26	
	Color Space	Selects Color Space from YCbCr 4:4:4/YCbCr 4:2:2/Full RGB/RGB.	26	
	HDMI Deep Color	Selects HDMI Deep Color from 30 bits/36 bits/48 bits/Off.	26	
	HDMI 1080p 24Hz	Sets HDMI 1080p 24Hz to auto/off.	27	
	Lip Sync	Adjusts the lag between video and audio, such as when the mouth movement is out of sync with the voice.	27	
	<b>Video Process</b>	Video Mode	Adjusts the visual image.	27
	Color Adjust	Adjusts Brightness/Saturation/Hue for each color.	27	
	Noise Reduction	Sets the level of Noise Reduction.	27	
De-interlacing Mode	Sets how to detect the video signal.	27		
 <b>Audio Setting</b>	<b>Audio Output</b>	HDMI	Selects the output mode of HDMI terminal from Bitstream/PCM/Reencode/Off.	27
	DRC	Sets the DRC (Dynamic Range Compression).	27	
 <b>System Information</b>		Displays software version and MAC address (p. 35).	27	

## ■ Example of SETUP menu operation

You need to call up the SETUP menu screen to perform settings for this Player. The following is the explanation for basic operations of the SETUP menu.

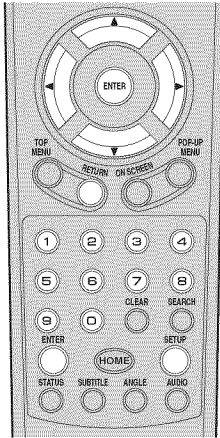

**Example:** Setting Parental Control

**Note**

- Some items cannot be set during playback. In this case, press **■** twice to stop playback completely before setting.

### 1. Display the SETUP menu screen.

Press **SETUP** to display the SETUP menu screen. Press **◀▶** to select General Setting, then press **ENTER** or **▼**.

### 2. Select a Submenu.

Press **▲/▼** to select Security, then press **ENTER** or cursor **▶**.

### 3. Select a menu item.

Press **▲/▼** to select Parental Control, then press **ENTER** or cursor **▶**.

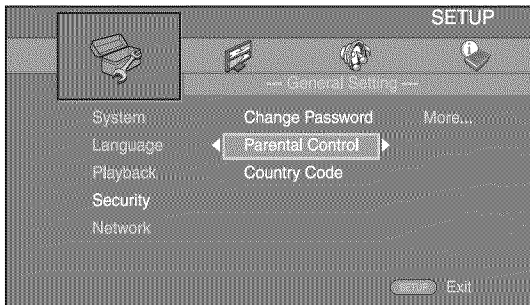

### 4. Enter password.

- Enter your password with number buttons.
- The default password is 0000.
  - You cannot move to the next setting screen until you have input the correct password.
  - To change the password, refer to “Change Password” (p. 25).

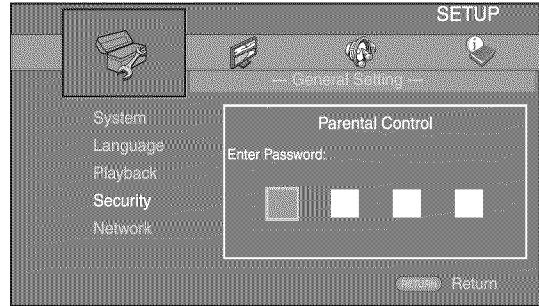

### 5. Select a next item.

Press **▲/▼** to select the Parental Control Level for Blu-ray Disc/DVD, then press **ENTER**.

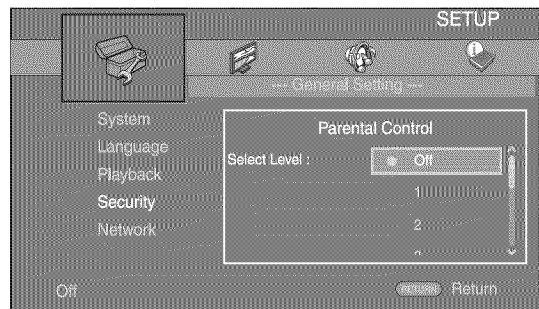

### 6. Exit the menu screen.

Press **◀** to return to the previous menu.

## ■ General Setting

The default settings are marked with “\*”.

### System

#### Screen Saver

You can set the screen saver to on/off.

When set to on, this Player will switch to screen saver mode if there is no operation for 3 minutes. After that, this Player will turn to standby mode when there is no operation for 27 minutes.

On\*, Off

#### Disc Auto Playback

You can set Disc Auto Playback to on/off. When set to on, a disc will play back automatically after loading.

On\*, Off

#### HDMI Control

You can set the Player to receive control signal from a TV/AV receiver compatible with the HDMI Control function via an HDMI cable (p. 10).

On, Off\*

#### Using HDMI Control function

Using the HDMI Control function, you can interactively operate this Player with your TV (HDMI Control function supported).

When you connect this Player to the TV compatible with the HDMI Control function using an HDMI cable and set HDMI Control in the SETUP menu to on (p. 24), you can perform the function listed below.

- Automatic input select function  
When you start playback of this Player, the input selector of the TV (and an AV receiver if this Player is connected to the TV via the AV receiver) is switched to this Player automatically. TV Power is turned on automatically depending on the TV.
- Automatic power off function  
When you turn off the TV while this Player is in stop mode and the SETUP menu screen is not displayed, the power of this Player is also turned off automatically.

#### Notes

- HDMI Control function may not work properly depending on the TV.
- Functions other than ones shown above may work depending on the TV or AV receiver.
- In order to make the HDMI Control function available, set up settings for the HDMI Control function on ALL components (this Player, TV, and AV receiver). Certain operation may also be required.
- Each function may be set independently to activate/deactivate depending on the TV.
- Refer to the operation manuals supplied with the TV and/or AV receiver for details regarding setup.
- When set to on, power consumption during standby mode increases due to HDMI Control function.

#### Load Default

You can reset all settings of this Player to default setting except Security setting (p. 25). For details on default settings, see pages 21–27.

#### Upgrade

You can upgrade the software manually from USB Storage or Network. For details on software upgrade, refer to “Software upgrade” (p. 30).

#### Easy Setup

You can perform Easy Setup (p. 12).

#### Local Storage

You can display Local Storage information, format Local Storage, and select Front USB/Rear USB to save the BD-Live data.

To format (empty) the “BUDA” folder in the USB memory device, select Information and press **ENTER** when “Format” is focused on the screen.

#### Front USB, Rear USB\*

#### Hint

- Local Storage is used as an auxiliary memory when Blu-ray Disc is played back.

#### 3D Playback Message

You can turn on or off a warning message concerning 3D video playback that appears on the TV when this Player is turned on.

On\*, Off

### Language

#### OSD

You can select the language for On Screen Display which is the messages or menu displayed on the screen such as SETUP menu.

English, Français, Español, Deutsch, Italiano, Svenska, Nederlandse, Русский, 中文

#### Menu

You can prioritize the language for disc menu.

English, Français, 中文, Español, Deutsch, Italiano, Nederlandse, Portuguese, Danish, Svenska, Finnish, Norwegian, Русский, Korean, Japanese, More

#### Audio

You can prioritize the audio language for Blu-ray Disc/DVD playback. For details on setting items, see “Menu” (p. 24).

#### Subtitle

You can prioritize the language for Subtitle.

English, Français, 中文, Español, Deutsch, Italiano, Nederlandse, Portuguese, Danish, Svenska, Finnish, Norwegian, Русский, Korean, Japanese, More, Off

(The default settings in [Language] differ depending on your model.)

## Playback

### Angle Mark

You can set to display the Angle Mark () when Blu-ray Disc/DVD with multiple angles is played back.

On\*, Off

### PIP Mark

You can set to display the PIP Mark () when Blu-ray Disc with picture in picture (p. 20) is played back.

On\*, Off

### Secondary Audio Mark

You can set to display the Secondary Audio Mark () when Blu-ray Disc with secondary audio is played back.

On\*, Off

### Last Memory

You can set whether this Player remembers the last playback position of a disc when it is set to standby mode or the disc tray is opened.

On\*, Off

#### Note

- Some discs are not compatible with this function.

## Security

### Change Password

You can set the password for changing the Parental Control Level and Country Code. Refer to “Parental Control” (p. 25) and “Country Code” (p. 25).

#### Notes

- The default password is 0000.
- If you forget the password, refer to “Troubleshooting” (p. 31) and set all the Security settings to their default settings.

### Parental Control

In some Blu-ray Discs/DVDs, a control level for disc viewing is set depending on the age of the viewer. You can set the Parental Control shown on the screen depending on the disc content.

The password (see “Change Password” on p. 25) needs to be entered before the Parental Control Levels is set.

After you set the Parental Control, when you play back a disc with level higher than current Parental Control Level, or you want to change the Parental Control Level, a dialog box will pop up to ask you to enter the password.

Off\*, 1–8

### Country Code

You can set the Country Code you live in. The password (see “Change Password” on p. 25) needs to be entered before the Country Code is set. This setting may be used for rating of Parental Control and disc playback.

## Network

### Internet Connection

Set this item to Enable when you use BD-Live (p. 20), DLNA (p. 15), software upgrade from the network (p. 30), and the other network functions.

Enable\*, Disable

### Information

You can display network information screen. On this screen, you can view the information of Interface (Ethernet), Address Type, IP Address, Subnet Mask, Default Gateway, and DNS.

### Connection Test

You can perform an internet connection test. If the test is failed, please check “IP Setting” (p. 25) and perform the test again.



### IP Setting

You can configure the network settings.

**Auto\*** Select to automatically configure the network settings of this Player with the DHCP server.

**Manual** Select to configure the network settings (IP Address, Subnet Mask, Default Gateway, and DNS) manually.

#### Hints

- **Numeric keys** Enters characters.
-   Moves the highlight.
- **CLEAR** Deletes a character.
- **ENTER** Saves the settings and exits from the menu.

### BD-Live Connection

You can set access restriction to BD-Live contents.

**Permitted** Allows all BD-Live discs to connect the network.

**Partial Permitted\*** Allows only discs with owner certification.

**Prohibited** Prohibits all BD-Live discs to connect the network.

### DLNA

You can set the DLNA (p. 34) to Enable/Disable. When you do not use the DLNA function, set to Disable.

Enable\*, Disable

### Proxy Setting

You can set Proxy Setting. Set to Disable for normal use. Set to Enable to set the proxy setting.

**Enable** Enables proxy host and proxy port setting.

**Disable\*** Sets proxy server to disable. Select this item when proxy server is not used.

**Proxy Host** Sets proxy host.

**Proxy Port** Sets proxy port.

## ■ Display Setting

The default settings are marked with “\*”.

### TV

#### 3D Output

You can select 3D or 2D video output from this Player.

- Auto\*** This Player automatically selects 3D or 2D videos.
- Off** This Player always selects 2D videos.

#### Note

- Even if you set “3D Output” to “Auto” and play back a Blu-ray 3D Disc, this Player selects 2D images depending on the connection and the setting of TV, etc (p. 10).



#### TV Screen

You can set the screen aspect ratio of the connected TV, and adjust the video output.

If you switch your TV (i.e. because you have bought a new one) and the screen aspect ratio of the connected TV changes, you will have to change the TV Screen setting.

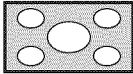
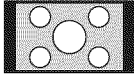
- 16:9 Full** Select this when this Player is connected to a TV with a 16:9 screen. When a 4:3 aspect ratio video is played back, the video is displayed as shown below.
- 16:9 Normal\*** Select this when this Player is connected to a TV with a 16:9 screen. When a 4:3 aspect ratio video is played back, the video is displayed as shown below.
- 4:3 Pan Scan** Select this when this Player is connected to a TV with a 4:3 screen. When a 16:9 aspect ratio video is played back, the video is displayed as shown below.
- 4:3 Letter Box** Select this when this Player is connected to a TV with a 4:3 screen. When a 16:9 aspect ratio video is played back, the video is displayed as shown below.

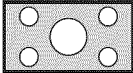
Original image size	On 16:9 (wide screen) TV	
	16:9 Full	16:9 Normal
 4:3		

Original image size	On 4:3 TV	
	4:3 Pan Scan	4:3 Letter Box
 16:9		

### Video Out Select

You can select the video output resolution from Auto, 480i/576i, 480p/576p, 720p, 1080i, and 1080p. When set to Auto, resolution is set to the maximum resolution according to the connected TV.

For more details on output formats, refer to “About the video output formats” (p. 29).

**Auto\*, 480i/576i, 480p/576p, 720p, 1080i, 1080p**

#### Note

- To output HD audio (Dolby TrueHD or DTS-HD Master Audio) from HDMI terminal, set Video Out Select to Auto or more than 720p.

### TV System

You can select TV System from PAL, NTSC and Multi. Set the same TV System as your TV set. For more details on output formats, refer to “About the video output formats” (p. 29).

#### NTSC, PAL, Multi

(The default setting differs depending on your model.)

### Color Space

You can select the Color Space (p. 34) output from HDMI. This function is available when this Player is connected with an HDMI cable.

**YCbCr 4:4:4\*** Sets Color Space to YCbCr 4:4:4.

**YCbCr 4:2:2** Sets Color Space to YCbCr 4:2:2.

**Full RGB** When RGB is set and white and black on the screen are too faint, select this item. This setting is effective when a connected component supports RGB 0–255 range.

**RGB** Outputs video signal at normal signal range.

#### Note

- This function is only available on TVs that support this function.

### HDMI Deep Color

When your TV and/or AV receiver is compatible with Deep Color (p. 34), set this item according to your TV/AV receiver. This function is available when this Player is connected with an HDMI cable.

**30 bits, 36 bits, 48 bits, Off\***

## HDMI 1080p 24Hz

This outputs the BD-Video encoded in 24Hz frame rate in HDMI 1080p 24Hz. Smoother video playback may be available with this function. This function is available when your TV/AV receiver support this function, and this Player is connected with an HDMI cable. For more details on output formats, refer to “About the video output formats” (p. 29).

**Auto\***, Off

### Note

- This setting is disabled when output resolution is other than 1080p.

## Lip Sync

You can set/adjust the Lip Sync (p. 35) function.

<b>Auto*</b>	This Player adjusts the Lip Sync function automatically.
<b>Manual</b>	You can adjust the Lip Sync function manually. You can set the delay of the audio for 2D and 3D contents independently.
	<b>2D</b>
	<b>3D</b>
<b>Off</b>	This Player does not adjust the Lip Sync function.

## Video Process

### Video Mode

You can select Video Mode below.

<b>Standard*</b>	The image is most natural and well-balanced. This mode suits for normal use.
<b>Vivid</b>	The image is more vivid and sharp.
<b>Cinema</b>	The image suits for watching movie in dark room.
<b>Custom</b>	You can adjust the visual image manually. Press ▲/▼ to select the parameter, then press ◀/▶ to adjust the figure.

### Brightness

Adjusts the overall brightness of the image.

### Saturation

Adjusts the richness of the color in the projected image.

### Hue

Adjusts the tint of the projected image.

### Contrast

Adjusts the bright areas (white levels) in the image.

### Sharpness

Adjusts the sharpness of objects in the video.

### CTI

Smooths out the edges of color images. Color images are rendered more distinct.

**The default settings are 0.**

## Color Adjust

You can adjust Brightness/Saturation/Hue for each color (Red/Green/Blue/Yellow/Cyan/Magenta). To use this function, set Video Mode to Custom. For details on the setting items, see “Video Mode” (p. 27).

**The default settings are 0.**

## Noise Reduction

You can set the Noise Reduction to a level of 0 to 3. 0 is off, and 3 is the maximum level.

**0, 1, 2\*, 3**

## De-interlacing Mode

You can select how to detect the video signal. Set to Auto for normal use. When horizontal stripping noise appears on the screen, set this to Film/Video to remove the noise.

**Auto\*, Film, Video**

## Audio Setting

The default settings are marked with “\*”.

## Audio Output

### HDMI

You can select the output mode of HDMI terminal. For more details on output formats, refer to “About the audio output formats” (p. 28).

**Bitstream\*, PCM, Reencode, Off**

### Note

- To output HD audio (Dolby TrueHD or DTS-HD Master Audio) from HDMI terminal, set Video Out Select to Auto or more than 720p (p. 26).

## DRC

You can set the DRC (Dynamic Range Compression) (p. 34) to on/off/Auto. When set to Auto, DRC is automatically turned on for a source with DRC information in Dolby TrueHD format. DRC makes the strong sound such as plosive sound lower, and conversations more audible. It is useful when you watch movies in the night.

**Off, On, Auto\***

## System Information

Software version and MAC address (p. 35) are displayed.

## ■ About the audio output formats

Source format		HDMI		
		Bitstream	PCM	Reencode
PCM 2ch	with SA* or BCS**	PCM 2ch		Dolby Digital
	without SA* or BCS**	PCM 2ch		
PCM 5.1ch	with SA* or BCS**	PCM 5.1ch		Dolby Digital
	without SA* or BCS**	PCM 5.1ch		
PCM 7.1ch	with SA* or BCS**	PCM 7.1ch		Dolby Digital
	without SA* or BCS**	PCM 7.1ch		
Dolby Digital	with SA* or BCS**	Dolby Digital	PCM up to 5.1ch	Dolby Digital
	without SA* or BCS**			
Dolby Digital Plus	with SA* or BCS**	Dolby Digital Plus	PCM up to 7.1ch	Dolby Digital
	without SA* or BCS**			Dolby Digital Plus
Dolby TrueHD	with SA* or BCS**	Dolby TrueHD	PCM up to 7.1ch	Dolby Digital
	without SA* or BCS**			Dolby TrueHD
DTS	with SA* or BCS**	DTS	PCM up to 5.1ch	DTS
	without SA* or BCS**			
DTS HD High Resolution	with SA* or BCS**	DTS HD High Resolution	PCM up to 5.1ch (Core decode)	DTS
	without SA* or BCS**			DTS HD High Resolution
DTS-HD Master Audio	with SA* or BCS**	DTS-HD Master Audio	PCM up to 5.1ch (Core decode)	DTS
	without SA* or BCS**			DTS-HD Master Audio

\* “SA” is a Secondary Audio.

\*\* “BCS” is a button click sound, the sound effect for pop-up menus, etc.

### Notes

- When HDMI is set to Bitstream, secondary audio is not output. (p. 27)
- To output HD audio (Dolby TrueHD or DTS-HD Master Audio) from HDMI terminal, set Video Out Select to Auto or more than 720p (p. 26).



## ■ About the video output formats

### When TV System is set to NTSC

	Resolution	Auto	480i/576i	480p/576p	720p	1080i	1080p
HDMI	BD-Video with 1080p/24 Hz content	*1, *2	480i	480p	720p 60 Hz	1080i 60 Hz	1080p 24/60 Hz *2
	Others						1080p 60 Hz

### When TV System is set to PAL

	Resolution	Auto	480i/576i	480p/576p	720p	1080i	1080p
HDMI	BD-Video with 1080p/24 Hz content	*1, *2	576i	576p	720p 50 Hz	1080i 50 Hz	1080p 24/50 Hz *2
	Others						1080p 50 Hz

\*1 Resolution is set to the maximum resolution supported by the connected TV. For example, when the maximum resolution supported by the connected TV is 1080p, the resolution will be set to 1080p.

\*2 If the source is 1080p 24 Hz content, and the connected TV supports 1080p 24 Hz content output, 1080p 24 Hz will be output instead of 1080p 50/60 Hz when resolution is set to Auto or 1080p, and Auto is set for HDMI 1080p 24Hz (p. 27) in Display Setting.

### When TV System is set to Multi

When TV System is set to Multi, video signal is output at the same frequency as the source. Refer to the tables above for details on the frequency setting of the TV and resolution of the output video signal.

#### Notes

- HDMI 1080p 24Hz setting is disabled when output resolution is other than 1080p.
- When TV System is set to NTSC and video source is not 60 Hz, the video output signal is converted to 60 Hz.
- When TV System is set to PAL and video source is not 50 Hz, the video output signal is converted to 50 Hz.

# Software upgrade

Some of the newly released Blu-ray Discs cannot be played back unless you upgrade this Player software to the latest version. We recommend upgrading the software of this Player with software upgrade so that this Player is operated based on the latest software.

To check for the availability of a software upgrade, visit <http://download.yamaha.com/>

## Note

- Do not remove the USB memory device, set this Player to standby mode or unplug the power cable/LAN cable while the software upgrade is being performed.

## ■ Upgrading the software

### 1. Prepare for the software upgrade.

When you upgrade the software from USB Storage:

- ① Save the upgrade file package to the appropriate folder on the USB memory device. For more details, refer to the procedure document attached with the upgrade file package.
- ② Connect the USB memory device.  
Skip step 2.

When you upgrade the software from Network:  
Confirm that this Player is connected to the network.

### 2. Select the upgrade method and start upgrade from SETUP menu.

- ① Press **SETUP** to display SETUP menu screen.
- ② Select General Setting → System → Upgrade.
- ③ Select the item which contains the upgrade file package from USB Storage/Network.

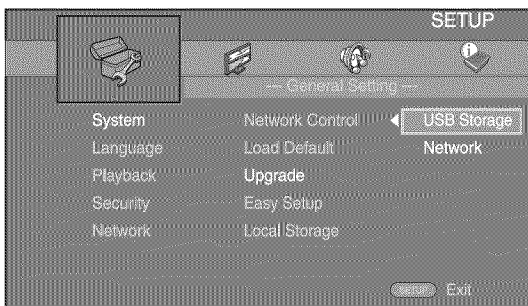

The system will search for upgrade file package.

### 3. Upgrade the software by following the on-screen messages.

Upgrade is completed. The system will be reset.





# Troubleshooting

Refer to the table below when this Player does not function properly. If the problem you are experiencing is not listed below or if the instruction below does not help, turn off this Player, disconnect the power cable, and contact the nearest authorized Yamaha dealer or service center.

## ■ Power

Problem	Possible causes and solutions
No power.	<ul style="list-style-type: none"> <li>– Connect the AC power cable properly.</li> <li>– Press  on the front panel to turn on the power.</li> </ul>
The Player power is turned off.	<ul style="list-style-type: none"> <li>– The power will be automatically turned off after 30 continuous minutes of inactivity (no playback).</li> </ul>





## ■ Basic operation

Problem	Possible causes and solutions
The remote control does not work.	<ul style="list-style-type: none"> <li>– Use the remote control within its operating range. (p. 9)</li> <li>– Replace the batteries. (p. 9)</li> </ul>
Buttons do not work.	<ul style="list-style-type: none"> <li>– Press and hold  on the front panel for more than 5 seconds, and release to reset this Player.</li> <li>– To completely reset this Player, unplug the power cable from the AC outlet for 10 seconds or more, plug the power cable to the AC outlet again, and then turn on this Player.</li> </ul>
Password is forgotten.	<ul style="list-style-type: none"> <li>– Press and hold  and  on the front panel simultaneously when no disc is inserted and playback is stopped to set all the settings including Security settings (p. 25) of this Player to their default settings. After the power is turned off automatically, press  to turn on the power again.</li> </ul>

## ■ Disc playback

Problem	Possible causes and solutions
The Player cannot play a disc.	<ul style="list-style-type: none"> <li>– Take out the disc and clean it. (p. 4)</li> <li>– Make sure that the disc is loaded properly (aligned in disc tray and label-side up). (p. 4)</li> <li>– Use a disc supported by the Player. (p. 3)</li> <li>– Remove the disc and then check whether the Player supports the disc or not. (p. 3)</li> <li>– Check the region code. (p. 3)</li> <li>– Check whether the disc is defective by trying another disc.</li> <li>– The CD-R/RW, DVD+R/RW/R DL, and DVD-R/RW/R DL must be finalized. (p. 3)</li> </ul>
Video stops.	<ul style="list-style-type: none"> <li>– The Player will stop if it senses shock or vibration.</li> </ul>
The Player makes a snapping sound when starting playback or loading a disc.	<ul style="list-style-type: none"> <li>– These sounds are not malfunctions of the Player but are normal operating conditions.</li> </ul>

## Picture

Problem	Possible causes and solutions
No picture.	<ul style="list-style-type: none"> <li>- Make sure that the HDMI cable is connected correctly. (p. 10)</li> <li>- Make sure that the connected TV or the AV receiver is set to the correct input. (p. 10)</li> <li>- With no disc inserted, or playback stopped, press and hold  and  on the front panel simultaneously to set video resolution to the default value.</li> <li>- If a picture is still not output, press and hold  on the front panel for approximately 5 seconds to switch NTSC/PAL.</li> </ul>
Screen freezes and operation buttons do not work.	<ul style="list-style-type: none"> <li>- Press , then restart playback.</li> <li>- Turn off the power and turn on the power again.</li> <li>- Press and hold  on the front panel for more than 5 seconds, and release to reset this Player.</li> </ul>
Video is not output with the desired resolution.	<ul style="list-style-type: none"> <li>- Set to the desired resolution. (p. 26)</li> </ul>
Wide-screen video appears vertically stretched, or black bands appear at the top and bottom of the screen. Or 4:3 video appears horizontally stretched.	<ul style="list-style-type: none"> <li>- Change the aspect ratio of your TV. (p. 26)</li> </ul>
Square noise (mosaic) appears on the screen.	<ul style="list-style-type: none"> <li>- Blocks in images may be visible in scenes with rapid movement due to the characteristics of digital image compression technology.</li> </ul>
Audio is not output, or images are not played back properly.	<ul style="list-style-type: none"> <li>- The audio may not be output or the images may not be played back properly for some discs in which copyright-protected contents are recorded.</li> </ul>

## Sound

Problem	Possible causes and solutions
No sound, or sound is distorted.	<ul style="list-style-type: none"> <li>- Check that the HDMI cable is connected correctly. (p. 10)</li> <li>- Turn the volume of TV or AV receiver up.</li> <li>- There is no sound during still mode, fast forward, and fast reverse. (p. 8)</li> <li>- Audio may not be output depending on the audio recording status, such as when audio other than an audio signal or non-standard audio is recorded for the audio content. (p. 3)</li> </ul>
Left and right channels of audio are reversed, or sound comes out of only one side.	<ul style="list-style-type: none"> <li>- Check the HDMI connection. (p. 10)</li> </ul>
Audio is not output, or images are not played back properly.	<ul style="list-style-type: none"> <li>- The audio may not be output or the images may not be played back properly for some discs in which copyright-protected contents are recorded.</li> </ul>
Cannot hear the sound of PIP (secondary audio).	<ul style="list-style-type: none"> <li>- Set HDMI to PCM/Reencode. (p. 27)</li> <li>- To hear secondary audio, press <b>2ND AUDIO</b>. (p. 6)</li> <li>- Depending on the disc, you may need to set secondary audio on the top menu of the disc. (p. 8)</li> </ul>

## ■ Network

Problem	Possible causes and solutions
<b>Cannot connect to the Internet.</b>	<ul style="list-style-type: none"> <li>- Connect the Network cable properly.</li> <li>- Turn on the connected equipment, such as broadband router or modem.</li> <li>- Connect the broadband router and/or modem properly.</li> <li>- Set the proper value(s) in the network setting. Check "Network". (p. 25)</li> </ul>
<b>Cannot download BD-Live contents.</b>	<ul style="list-style-type: none"> <li>- Connect the Network cable properly. (p. 11)</li> <li>- Connect USB memory device properly. Check that the USB memory device is connected to the USB connector of this Player. (p. 11)</li> <li>- Check if the Blu-ray Disc supports BD-Live.</li> <li>- Check the setting for "Internet Connection". (p. 25)</li> <li>- Connect the USB memory device formatted in FAT16, FAT32, or NTFS.</li> <li>- It is recommended to connect the USB memory device with at least 2 GB of free space. If there is not enough free space, format the USB memory device. (p. 24)</li> <li>- Refer to the supplied user's manual of the disc or consult the disc manufacturer.</li> </ul>
<b>Cannot detect the DLNA server.</b>	<ul style="list-style-type: none"> <li>- Connect the network cable properly.</li> <li>- Turn on the connected equipment, such as broadband router or the server.</li> <li>- Confirm the Player and the server are connected to the same access point.</li> <li>- Set the proper value(s) in the network setting. Check "Network". (p. 25)</li> <li>- Depending on the DLNA server, the Player may need to be permitted from the server.</li> <li>- Depending on the DLNA server, it needs to change a firewall setting.</li> </ul>
<b>Cannot play the file on the home network server.</b>	<ul style="list-style-type: none"> <li>- Make sure the file is playable. (p. 3)</li> <li>- Check your DLNA server's setting.</li> <li>- The playback and operating quality may be affected by your home network condition.</li> </ul>

## ■ Messages on the screen

- The following messages appear on the TV screen in case the disc you tried to play back is not appropriate or the operation is not correct.

Error message	Possible causes and solutions
<b>Unsupported File</b>	- The file is not supported with this Player. See "Types of discs/files that can be used with this Player" (p. 3).
<b>Wrong region code!</b>	- The disc is an incompatible region code. See "Region management information for Blu-ray Disc/DVD videos" (p. 3).
<b>Network has FAILED.</b>	- This Player cannot be connected to the network. Check connection (p. 11) and Network setting (p. 25).
<b>Network is OK, proxy has FAILED.</b>	- This Player cannot be connected to the proxy server. See "Proxy Setting" (p. 25).
<b>BD-Live connection is prohibited in SETUP menu.</b>	- BD-Live connection is prohibited. See "BD-Live Connection" (p. 25).
<b>Upgrade has failed for some reason!</b>	- Upgrade is failed. Check if the upgrade file is corrupted or unreadable.

# Glossary

## **AVCHD**

AVCHD is a new format (standard) for high definition video cameras that can be used to record and play high-resolution HD images.

## **BD-Live™**

BD-Live is a Blu-ray Disc standard that utilizes a network connection, enabling this Player to go online to download promotional videos and other data.

## **BDMV**

BDMV (Blu-ray Disc Movie) refers to one of the application formats used for BD-ROM which is one of the Blu-ray Disc specifications. BDMV is a recording format equivalent to DVD-Video of the DVD specification.

## **Blu-ray 3D™**

Blu-ray 3D enables you to view full high definition 3D images.

## **BONUSVIEW™**

BONUSVIEW compatible discs let you simultaneously enjoy video sub-channel for two screens, audio sub-channel and sub-titles. A small screen appears within the main screen during playback (Picture in Picture).

## **Color Space**

Color Space is a color range that can be represented. RGB is a color space based on the RGB color model (red, green and blue) and is typically used for PC monitors. YCbCr is a color space based on a luminance signal (Y) and two color difference signals (Cb and Cr).

## **Deep Color**

Deep Color refers to the use of various color depths in displays, up from the 24-bit depths in previous versions of the HDMI specification. This extra bit depth allows HDTVs and other displays go from millions of colors to billions of colors and eliminate on-screen color banding for smooth tonal transitions and subtle gradations between colors. The increased contrast ratio can represent many times more shades of gray between black and white. Also Deep Color increases the number of available colors within the boundaries defined by the RGB or YCbCr color space.

## **DLNA**

DLNA (Digital Living Network Alliance) provides easy sharing of digital media through network in the home, and you can enjoy digital contents stored on your DLNA-server-software-installed PC or other DLNA compatible device with your TV via this Player. To connect this Player to your DLNA servers, some settings for the DLNA server or device are required. For details, refer to your DLNA server software or DLNA device.

## **Dolby Digital**

A sound system developed by Dolby Laboratories Inc. that gives movie theater ambience to audio output when the product is connected to a Dolby Digital processor or amplifier.

## **Dolby Digital Plus**

A sound system developed as an extension to Dolby Digital. This audio coding technology supports 7.1 multi-channel surround sound.

## **Dolby TrueHD**

Dolby TrueHD is a lossless coding technology that supports up to 8 channels of multi-channel surround sound for the next generation optical discs. The reproduced sound is true to the original source bit-for-bit.

## **DRC (Dynamic Range Control)**

DRC lets you adjust the range between the loudest and softest sounds (dynamic range) for playback at average volume. Use this when it is hard to hear dialog, or during times when playback may disturb neighbors.

## **DTS**

This is a digital sound system developed by DTS, Inc. for use in cinemas.

## **DTS-HD High Resolution Audio**

DTS-HD High Resolution Audio is a new technology developed for the next generation high definition optical disc format.

## **DTS-HD Master Audio**

DTS-HD Master Audio is a lossless audio compression technology developed for the next generation high definition optical disc format.

## **FLAC**

FLAC (Free Lossless Audio Codec) is an open file format for lossless audio data compression. While inferior in compression rate to other lossy compressed audio formats, it can often provide higher audio quality.

## **HDMI**

HDMI (High-Definition Multimedia Interface) is an interface that supports both video and audio on a single digital connection. The HDMI connection carries standard to high definition video signals and multi-channel audio signals to AV components such as HDMI equipped TVs, in digital form without degradation.

## **Letterbox (LB 4:3)**

A screen size with black bars on the top and bottom of the image to allow viewing of wide-screen (16:9) material on a connected 4:3 TV.

## **Linear PCM Sound**

Linear PCM is a signal recording format used for Audio CDs and on some DVD and Blu-ray Discs. The sound on Audio CDs is recorded at 44.1 kHz with 16 bits. (Sound is recorded between 48 kHz with 16 bits and 96 kHz with 24 bits on DVD discs and between 48 kHz with 16 bits and 192 kHz with 24 bits on Blu-ray Discs.)

**Lip Sync**

Lip Sync, an abbreviation for lip synchronization, is a technical term that involves both a problem and a capability of maintaining audio and video signals synchronized during post-production and transmission. Whereas the audio and video latency requires complex end-user adjustments, HDMI incorporates an automatic audio and video syncing capability that allows devices to perform this synchronization automatically and accurately without user interaction.

**Mac address**

The Mac address is a unique value assigned to a network device for identification purposes.

**Pan Scan (PS 4:3)**

A screen size that cuts off the sides of the image to allow viewing of wide-screen (16:9) material on a connected 4:3 TV.

**Subtitles**

These are the lines of text appearing at the bottom of the screen which translate or transcribe the dialog. They are recorded on many DVDs and Blu-ray Discs.

**x.v.Color**

x.v.Color reproduces a greater range of color than before, showing almost all of the colors that the human eye can detect.

## Specifications

### ■ General

Power supply	
[U.S.A. and Canada models]	AC 110–240 V, 60 Hz
[Central and South America model]	AC 110–240 V, 50/60 Hz
[Australia model]	AC 110–240 V, 50 Hz
[U.K., Europe and Russia model]	AC 110–240 V, 50 Hz
[China model]	AC 110–240 V, 50 Hz
[Asia model]	AC 110–240 V, 50/60 Hz
[Korea model]	AC 110–240 V, 60 Hz
Power consumption (Normal)	18 W
Power consumption (Standby)	0.5 W or less
Dimensions (W × H × D)	435 × 50 × 202 mm (17-1/8 × 2 × 8 in)
Weight	2.0 kg (4.4 lbs.)

### ■ Input/output

HDMI output	Type A connector × 1 480i/576i/480p/576p/720p/1080i/1080p/1080p@24Hz, Deep Color, x.v. Color support
USB	Type A connector × 2
Other equipment	Ethernet × 1

Specifications are subject to change without notice.

## ■ Copyright

- Audio-visual material may consist of copyrighted works which must not be recorded without the authority of the owner of the copyright. Refer to relevant laws in your country.
- Manufactured under license from Dolby Laboratories. Dolby and the double-D symbol are trademarks of Dolby Laboratories.
- Manufactured under license under U.S. Patent Nos: 5,956,674; 5,974,380; 6,487,535 & other U.S. and worldwide patents issued & pending. DTS, the Symbol, & DTS and the Symbol together are registered trademarks & DTS Digital Surround and the DTS logos are trademarks of DTS, Inc. Product includes software. © DTS, Inc. All Rights Reserved.
- “Blu-ray Disc™”, “Blu-ray™”, “Blu-ray 3D™”, “BD-Live™”, “BONUSVIEW™”, and the logos are trademarks of the Blu-ray Disc Association.
-  is a trademark of DVD Format/Logo Licensing Corporation.
- “HDMI,” the “HDMI” logo and “High-Definition Multimedia Interface” are trademarks, or registered trademarks of HDMI Licensing LLC.
- “x.v.Color” and “x.v.Color” logo are trademarks of Sony Corporation.
- “AVCHD” and the “AVCHD” logo are trademarks of Panasonic Corporation and Sony Corporation.
- Java and all Java-based trademarks and logos are trademarks or registered trademarks of Sun Microsystems, Inc. in the United States and/or other countries.
- This product is licensed under the AVC patent portfolio license and VC-1 patent portfolio license for the personal and non-commercial use of a consumer to (i) encode video in compliance with the AVC Standard and VC-1 Standard (“AVC/VC-1 Video”) and/or (ii) decode AVC/VC-1 Video that was encoded by a consumer engaged in a personal and non-commercial activity and/or was obtained from a video provider licensed to provide AVC/VC-1 Video. No license is granted or shall be implied for any other use. Additional information may be obtained from MPEG LA, LLC.  
See <http://www.mpegla.com>.
- Windows Media Player is a registered trademark or trademark of Microsoft corporation in the United States and/or other countries.
- YouTube and the YouTube logo are trademarks of Google, Inc.
- DLNA and DLNA CERTIFIED are trademarks and/or service marks of Digital Living Network Alliance.
- Copyright 2004-2010 Verance Corporation.  
Cinavia™ is a Verance Corporation trademark.  
Protected by U.S. Patent 7,369,677 and worldwide patents issued and pending under license from Verance Corporation. All rights reserved.



# Index

## ■ Numerics

2ND AUDIO, remote control .....	6
3D Output, SETUP menu .....	26
3D Playback Message, SETUP menu .....	24

## ■ A

A/B, remote control .....	7
Angle Mark, SETUP menu .....	25
Angle, On Screen menu .....	17
ANGLE, remote control .....	7
Audio file requirement .....	3
Audio output formats .....	28
Audio Output, SETUP menu .....	27
Audio Setting, SETUP menu .....	27
Audio, On Screen menu .....	17
AUDIO, remote control .....	7
Audio, SETUP menu .....	24

## ■ B

BD-Live .....	20
BD-Live Connection, SETUP menu .....	25
Bitrate, On Screen menu .....	17
Bookmark .....	19

## ■ C

Change Password, SETUP menu .....	25
Chapter, On Screen menu .....	17
CLEAR, remote control .....	7
Color Adjust, SETUP menu .....	27
Color buttons, remote control .....	7
Color Space, SETUP menu .....	26
Connection Test, SETUP menu .....	25
Control buttons, remote control .....	8
Country Code, SETUP menu .....	25
Cursor buttons, remote control .....	8

## ■ D

Data disc playback .....	13
De-interlacing Mode, SETUP menu .....	27
DIGEST, remote control .....	7
Disc Auto Playback, SETUP menu .....	24
Disc precautions .....	4
Display Setting, SETUP menu .....	26
DLNA, SETUP menu .....	25
DRC, SETUP menu .....	27

## ■ E

Easy Setup .....	12
Easy Setup, SETUP menu .....	24
ENTER, remote control .....	6, 8

## ■ G

General Setting, SETUP menu .....	24
-----------------------------------	----

## ■ H

HDMI 1080p 24Hz, SETUP menu .....	27
HDMI connection .....	10
HDMI Control function .....	24
HDMI Control, SETUP menu .....	24
HDMI Deep Color, SETUP menu .....	26

HDMI, SETUP menu .....	27
HOME menu .....	13
HOME, remote control .....	7

## ■ I

Information, SETUP menu .....	25
Initial Wizard .....	12
Ins Replay, On Screen menu .....	17
Ins Search, On Screen menu .....	17
Internet Connection, SETUP menu .....	25
IP Setting, SETUP menu .....	25

## ■ L

Language, SETUP menu .....	24
Last Memory, SETUP menu .....	25
Lip Sync, SETUP menu .....	27
Load Default, SETUP menu .....	24
Local Storage, SETUP menu .....	24

## ■ M

MARKER, remote control .....	6
MEDIA menu .....	13
Menu, SETUP menu .....	24
Mode/Play Mode, On Screen menu .....	17

## ■ N

Network connection .....	11
Network, SETUP menu .....	25
Noise Reduction, SETUP menu .....	27
Number buttons, remote control .....	6

## ■ O

On Screen menu .....	17
ON SCREEN, remote control .....	8
OSD, SETUP menu .....	24

## ■ P

Parental Control, SETUP menu .....	25
PIP Mark, SETUP menu .....	25
PIP, remote control .....	6
Playback, SETUP menu .....	25
POP UP/MENU, remote control .....	8
Program play .....	19
PROGRAM, remote control .....	6
Proxy Setting, SETUP menu .....	25

## ■ R

Remote control .....	6
REPEAT, remote control .....	6
RETURN, remote control .....	8

## ■ S

Screen Saver, SETUP menu .....	24
Search function .....	19
SEARCH, remote control .....	7
Second Audio, On Screen menu .....	17
Second Video, On Screen menu .....	17
Secondary Audio Mark, SETUP menu .....	25
Security, SETUP menu .....	25
SETUP menu .....	21

SETUP menu operation .....	23
SETUP, remote control .....	7
SHUFFLE, remote control .....	6
Slide Show, On Screen menu .....	17
Software upgrade .....	30
Status menu .....	18
STATUS, remote control .....	6
Subtitle Style, On Screen menu .....	17
Subtitle, On Screen menu .....	17
SUBTITLE, remote control .....	6
Subtitle, SETUP menu .....	24
Supplied parts .....	2
System Information, SETUP menu .....	27
System, SETUP menu .....	24

## ■ T

Time, On Screen menu .....	17
Title, On Screen menu .....	17
TOP MENU, remote control .....	8
Track/File, On Screen menu .....	17
Transition, On Screen menu .....	17
Troubleshooting .....	31
TV Screen, SETUP menu .....	26
TV System, SETUP menu .....	26
TV, SETUP menu .....	26

## ■ U

Upgrade of software .....	30
Upgrade, SETUP menu .....	24
USB connection .....	11
USB content playback .....	13
Using Picture in Picture function .....	20

## ■ V

Video Mode, SETUP menu .....	27
Video Out Select, SETUP menu .....	26
Video output formats .....	29
Video Process, SETUP menu .....	27

## ■ Y

YouTube playback .....	16
------------------------	----

## ■ Z

ZOOM, remote control .....	7
----------------------------	---

# Precaución: lea las indicaciones siguientes antes de utilizar este aparato.

- 1 Para asegurar el mejor rendimiento de este aparato, lea atentamente este manual. Y luego guárdelo en un lugar seguro para poder consultarlo en el futuro en caso de ser necesario.
- 2 Instale esta unidad en un lugar bien ventilado, fresco, seco y limpio, alejado de la luz directa del sol, fuentes de calor, vibración, polvo, humedad y/o frío. Para una adecuada ventilación, permita que el equipo tenga el siguiente espacio libre mínimo:  
Superior: 10 cm  
Posterior: 10 cm  
Laterales: 10 cm
- 3 Coloque este aparato lejos de otros aparatos eléctricos, motores o transformadores, para evitar así los ruidos de zumbido.
- 4 No exponga este aparato a cambios bruscos de temperaturas, del frío al calor, ni lo coloque en lugares muy húmedos (una habitación con deshumidificador, por ejemplo), para impedir así que se forme condensación en su interior, lo que podría causar una descarga eléctrica, un incendio, daños en el aparato y/o lesiones a las personas.
- 5 Evite instalar este aparato en un lugar donde puedan caer encima objetos extraños y/o donde quede expuesto al goteo o a la salpicadura de líquidos. Encima de este aparato no ponga:
  - Otros componentes, porque pueden causar daños y/o decoloración en la superficie de este aparato.
  - Objetos con fuego (velas, por ejemplo), porque pueden causar un incendio, daños en el aparato y/o lesiones a las personas.
  - Recipientes con líquidos, porque pueden caer y derramar el líquido, causando descargas eléctricas al usuario y/o dañando el aparato.
- 6 No tape este aparato con un periódico, mantel, cortina, etc. para no impedir el escape del calor. Si aumenta la temperatura en el interior del aparato, esto puede causar un incendio, daños en el aparato y/o lesiones a las personas.
- 7 No enchufe este aparato a una toma de corriente hasta después de haber terminado todas las conexiones.
- 8 No ponga el aparato al revés. Podría recalentarse y posiblemente causar daños.
- 9 No utilice una fuerza excesiva con los conmutadores, los controles y/o los cables.
- 10 Cuando desconecte el cable de alimentación de la toma de corriente, sujete la clavija y tire de ella; no tire del propio cable.
- 11 No limpie este aparato con disolventes químicos porque podría estropear el acabado. Utilice un paño limpio y seco para limpiar el aparato.
- 12 Utilice solamente la tensión especificada en este aparato. Utilizar el aparato con una tensión superior a la especificada resulta peligroso y puede producir un incendio, daños en el aparato y/o lesiones a las personas. Yamaha no se hará responsable de ningún daño debido al uso de este aparato con una tensión diferente de la especificada.
- 13 Para impedir daños debidos a relámpagos, desconecte el cable de alimentación de la toma de corriente durante una tormenta eléctrica.
- 14 No intente modificar ni arreglar este aparato. Póngase en contacto con el personal de servicio Yamaha cualificado cuando necesite realizar alguna reparación. La caja no deberá abrirse nunca por ninguna razón.
- 15 Cuando no piense utilizar este aparato durante mucho tiempo (cuando se ausente de casa por vacaciones, por ejemplo) desconecte el cable de alimentación de la toma de corriente.
- 16 Asegúrese de leer la sección “Resolución de problemas” antes de dar por concluido que su aparato está averiado.
- 17 Antes de trasladar este aparato, pulse  para ponerlo en el modo de espera, y luego desconecte el cable de alimentación de CA de la toma de corriente.
- 18 La condensación se formará cuando cambie de repente la temperatura ambiental. Desconecte en este caso el cable de alimentación de la toma de corriente y no utilice el aparato.
- 19 El aparato se calentará cuando la utilice durante mucho tiempo. Desconecte en este caso la alimentación y luego no utilice el aparato para permitir que se enfríe.
- 20 Instale este aparato cerca de la toma de CA y donde se pueda alcanzar fácilmente la clavija de alimentación.
- 21 Las baterías no deberán exponerse a un calor excesivo como, por ejemplo, el que producen los rayos del sol, el fuego y similares.

Este aparato no se desconecta de la fuente de alimentación de CA si está conectada a una toma de corriente, aunque la propia aparato esté apagada con . A este estado se le llama modo de espera. En este estado, este aparato ha sido diseñada para que consuma un cantidad de corriente muy pequeña.

## ADVERTENCIA

PARA REDUCIR EL RIESGO DE INCENDIO O DESCARGA ELÉCTRICA, NO EXPONGA ESTE APARATO A LA LLUVIA NI A LA HUMEDAD.

El componente láser de este producto es capaz de emitir radiación que sobrepasa el límite establecido para la clase 1.

## Especificaciones LÁSER:

Producto LÁSER de Clase 1

Longitud de onda: 790 nm (CD)/658 nm (DVD)/405 nm (BD)  
Salida de láser: máxima de 1 mW

## SEGURIDAD CONTRA LA RADIACIÓN LÁSER

Este aparato utiliza rayos láser. Debido a la posibilidad de que se produzcan daños en los ojos, la extracción de la cubierta del aparato o las reparaciones solamente deberán ser realizadas por un técnico cualificado.

## PELIGRO

Este aparato emite radiación láser visible cuando se abre. Evite la exposición directa a los rayos láser. Cuando se conecte este aparato a una toma de corriente no acerque sus ojos a la abertura de la bandeja del disco ni a otras aberturas para mirar al interior.

# Índice general

1

## 1. Introducción

Qué puede hacer con este reproductor .....	2
Piezas incluidas .....	2
Información sobre discos y archivos.....	3
Tipos de discos/archivos que pueden utilizarse con este reproductor .....	3
Para cargar un disco.....	4
Precauciones con los discos.....	4
Aviso para ver imágenes de vídeo en 3D.....	4
Tecnología Cinavia.....	4
Controles y funciones .....	5
Panel delantero .....	5
Panel trasero .....	5
Mando a distancia.....	6

## 2. Conexiones

Conexión HDMI.....	10
Conexión con el terminal HDMI.....	10
Conexión para la reproducción de discos Blu-ray 3D....	10
Conexión de red y USB .....	11
Conexión con el terminal NETWORK.....	11
Conexión con el conector USB .....	11

## 3. Reproducción

Asistente inicial/Configuración Sencilla.....	12
Configuración con el Asistente inicial/Configuración Sencilla.....	12
Menú HOME/MEDIA .....	13
Reproducción de fotos/música/vídeo.....	13
Uso de contenidos de red.....	15
Uso de servicios de red.....	16
Reproducción de vídeos de YouTube™ .....	16
Funciones avanzadas de reproducción.....	17
Menú en pantalla .....	17
Menú de estado.....	18
Uso de Marcador .....	19
Programación de la reproducción.....	19
Uso de la búsqueda .....	19
Uso de BONUSVIEW™ y BD-Live™.....	20
Utilización de la función Imagen en Imagen (reproducción de audio/vídeo secundario).....	20
Utilización de la función BD-Live™ .....	20

## 4. Ajustes

Menú SETUP .....	21
Ejemplo de funcionamiento del menú SETUP.....	23
Configuración General .....	24
Configuración de pantalla .....	26
Configuración de audio.....	27
Sistema de Información .....	27
Acerca de los formatos de salida de audio.....	28
Acerca de los formatos de salida de vídeo.....	29
Actualización de software .....	30
Actualización del software.....	30

## 5. Información adicional

Resolución de problemas.....	31
Alimentación.....	31
Funcionamiento básico .....	31
Reproducción de disco .....	31
Imagen.....	32
Sonido .....	32
Red .....	33
Mensajes en pantalla .....	33
Glosario .....	34
Especificaciones .....	35
Información general .....	35
Entrada/salida.....	35
Propiedad intelectual.....	36
Índice .....	37

### (al final de este manual)

Information about software .....	i
----------------------------------	---

## ■ Acerca de este manual

- Este manual describe cómo utilizar este reproductor con un mando a distancia, excepto cuando no esté disponible. También se puede acceder a algunas de estas operaciones mediante los botones del panel delantero.
- Las notas contienen información importante sobre seguridad e instrucciones de funcionamiento. Las indicaciones señalan consejos de funcionamiento.
- Este manual se ha impreso antes de la fabricación. El diseño y las especificaciones están sujetos a cambios en parte como resultado de mejoras, etc. En caso de diferencias entre el manual y el producto, este último tiene prioridad.

## Iconos utilizados en este manual

Los iconos se utilizan para indicar botones/funciones disponibles para un formato particular. Para obtener información sobre los discos y formatos que se pueden reproducir, consulte página 3.

- BD** : Vídeo BD
- DVD** : DVD-Video, DVD-VR, DVD+VR
- CD** : CD de audio
- VIDEO** : archivos de vídeo
- MUSIC** : archivos de audio
- PHOTO** : archivos de fotos

2

3

4

5

Español

## Qué puede hacer con este reproductor

### **Configuración sencilla de idioma, resolución y relación de aspecto de la pantalla** → pág. 12

Puede ajustar la configuración de idioma y TV.

### **Reproducción de discos Blu-ray Disc™/Blu-ray 3D™/DVD/CD comercializados en el mercado\*** → pág. 17

Además de los discos Blu-ray, este reproductor también admite la reproducción de otros tipos de discos.

### **Reproducción de BONUSVIEW™, BD-Live™, etc.\*** → pág. 20

Puede disfrutar de más películas en los discos Blu-ray más recientes.

### **Reproducción de archivos de Vídeo, Música, Foto de un disco/dispositivos de memoria USB\*** → pág. 13

Con este reproductor se pueden reproducir archivos grabados en discos/dispositivos de memoria USB.

### **Reproducción de archivos de Vídeo, Música, Foto de un servidor doméstico de red\*\*** → pág. 15

El contenido del PC se puede reproducir en el televisor o el receptor de A/V conectando este reproductor a un servidor de red.

### **Control con el mando a distancia del televisor, receptor de A/V, etc.** → pág. 24

Puede conectar dispositivos con un cable HDMI y controlarlos con un único mando a distancia utilizando la función Control HDMI.

### **Transferencia de contenidos de reproducción en los servicios de red\*\*** → pág. 16

Puede disfrutar instantáneamente de vídeos a través de Internet con este reproductor.

\* Para obtener información sobre los discos y formatos que se pueden reproducir, consulte la página 3.

\*\* Para utilizar esta función, es necesaria la configuración de red.

## Piezas incluidas

Asegúrese de que con el producto se han suministrado los siguientes accesorios.

**Mando a distancia**



**Pilas (x2)  
(AAA, R03, UM-4)**

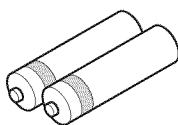

## Tipos de discos/archivos que pueden utilizarse con este reproductor

- En este reproductor se pueden reproducir discos de 12 cm y 8 cm. No utilice un adaptador de 8 cm a 12 cm.
- Utilice discos que sean compatibles con los estándares que se indican con la presencia de logotipos oficiales en la etiqueta del disco. La reproducción de discos que no cumplan con estos estándares no está garantizada. Además, la calidad de imagen o sonido no está garantizada aunque puedan reproducirse estos discos.

Tipo de soporte	Formato de grabación
BD-ROM/BD-R/ BD-RE	BD-Video/archivos de datos
DVD-ROM	DVD-Video
DVD-R/DVD-R DL/DVD-RW	DVD-Video/DVD-VR/AVCHD/archivos de datos
DVD+R/DVD+R DL/DVD+RW	DVD-Video/DVD+VR/AVCHD/archivos de datos
CD-ROM	CDDA/HDCD
CD-R/CD-RW	CDDA/archivos de datos
USB*	Archivos de datos
DLNA	Archivos de datos

\* Este reproductor es compatible con un dispositivo de memoria USB con formato FAT 16/32 y NTFS.

Formatos de archivo de audio reproducibles <b>MUSIC</b>	Formatos de archivo de vídeo reproducibles <b>VIDEO</b>	Formatos de archivo de foto reproducibles <b>PHOTO</b>
MP3 (.mp3) WMA (.wma) AAC (.aac/.m4a) WAV (.wav) FLAC (.flac)	MKV con H.264 (.mkv) MPEG PS (.mpeg/.mpg) MPEG TS (.ts) MPEG-4 (.mp4) VOB (.vob) AVI (.avi) ASF (.asf) WMV (.wmv)	JPEG (.jpeg/.jpg) GIF (.gif) PNG (.png)

### Notas

- No se garantiza la reproducción de los archivos incluidos en la tabla anterior en función del método utilizado para la creación del archivo o del códec empleado.
- No pueden reproducirse los archivos con protección de los derechos de autor.
- Al utilizar DLNA, el archivo debe cumplir los requisitos del servidor DLNA.

## Información sobre la gestión de la región en los vídeos Blu-ray Disc/DVD

- Los discos y los reproductores de vídeo Blu-ray Disc/DVD tienen códigos de región, que dictan las regiones en las que se puede reproducir un disco. Consulte la marca de código de región que aparece en el panel trasero de este reproductor.
- En el caso de un Blu-ray Disc, el disco puede reproducirse en este reproductor si tiene la misma marca de código de región o bien la marca “ABC” de código de región.
- En el caso de un disco DVD, el disco puede reproducirse en este reproductor si tiene la misma marca de código de región o bien la marca “ALL” de código de región.

Ejemplos de código de región	
BD-Video	DVD-Video
Código de región “A” o “ABC”	Código de región “1” o “ALL”

### Notas

- Las operaciones y funciones de vídeo Blu-ray Disc/DVD pueden ser diferentes de las explicaciones que aparecen en este manual y algunas operaciones pueden estar prohibidas debido a las configuraciones del fabricante del disco.
- Si aparece una pantalla de menú o instrucciones de funcionamiento durante la reproducción de un disco, siga el procedimiento de funcionamiento indicado.
- Según el disco, puede que no sea posible su reproducción.
- Finalice todos los soportes de grabación que desee reproducir en este reproductor.
- “Finalizar” hace referencia a un procesamiento al que se somete un disco grabado para que se pueda reproducir en otros reproductores/grabadores, así como en este reproductor. Solo pueden reproducirse en el reproductor los discos que se hayan finalizado. (Este reproductor no dispone de una función para finalizar discos.)
- No se garantiza la reproducción de todos los archivos de un disco, dispositivo de memoria USB y de la red.
- Un archivo con protección de los derechos de autor no se puede reproducir a través de un dispositivo de memoria USB o red.

## Requisitos de los archivos de audio

- Frecuencia de muestreo: entre 32 - 48 kHz (MP3/WMA), LPCM 44,1 kHz/16 bits/estéreo (WAV), 192 kHz/24 bits (FLAC)
- Bitrate: entre 8 - 320 kbps (MP3), 32 - 192 kbps (WMA)

## Requisitos de los archivos WMV

- WMV9; la resolución máxima es de 1.920 × 1.080.

## ■ Para cargar un disco

- Inserte el disco con la etiqueta hacia arriba.
- En el caso de un disco grabado por ambos lados, ponga boca abajo el lado que va a reproducir.

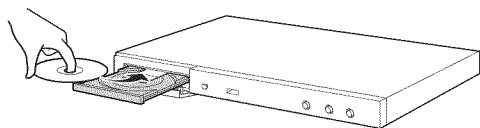

### Notas

- La reproducción podría iniciarse automáticamente, dependiendo del disco y la configuración del reproductor.
- Es posible que el menú aparezca primero, según el disco.
- El tiempo para cargar el disco puede variar dependiendo del disco.

## ■ Precauciones con los discos

### Tenga cuidado con los arañazos y el polvo

- Los discos Blu-ray Disc, DVD y CD son sensibles al polvo, a las huellas dactilares y especialmente a los arañazos. Es posible que no se pueda reproducir un disco con arañazos. Maneje los discos con cuidado y guárdelos en un lugar seguro.

### Almacenamiento apropiado de los discos

Ponga el disco en el centro de la caja y almacene la caja y el disco en posición vertical.	
Evite guardar los discos en lugares con luz solar directa, cerca de equipos de calefacción o en lugares con una humedad alta.	
No deje caer los discos ni los someta a vibraciones o impactos fuertes.	
Evite almacenar los discos en lugares donde haya mucha cantidad de polvo o humedad.	

### Precauciones de manipulación

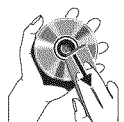

- Si la superficie está sucia, límpiela con cuidado con un paño suave humedecido (con agua solamente). Cuando limpie los discos, mueva siempre el paño desde el orificio central hacia el borde exterior.
- No utilice pulverizadores de limpieza de discos de vinilo, benceno, diluyente, líquidos para prevenir la electricidad estática ni otros disolventes.
- No toque la superficie.
- No pegue papel ni etiquetas adhesivas en el disco.
- Si la superficie de reproducción de un disco está sucia o rayada, el reproductor puede decidir que el disco es incompatible y expulsar la bandeja portadiscos o es posible que el disco no se reproduzca correctamente. Limpie cualquier mancha de la superficie de reproducción con un paño suave.

## Limpieza de la lente lectora

- No utilice nunca discos de limpieza de venta en el mercado. La utilización de estos discos podría dañar la lente.
- Solicite la limpieza de la lente en el centro de atención al cliente aprobado por Yamaha más cercano.

## ■ Aviso para ver imágenes de vídeo en 3D

- Algunas personas pueden sufrir molestias (como vista cansada, fatiga o náuseas) al ver imágenes de vídeo en 3D. Se recomienda a todos los espectadores realizar pausas periódicas durante la visualización de imágenes de vídeo en 3D.
- Si sufre alguna molestia, deje de ver las imágenes de vídeo en 3D hasta que ésta desaparezca. Consulte con un médico si sufre molestias agudas.
- Lea atentamente los manuales de instrucciones (del Blu-ray Disc y del televisor) y los mensajes de precaución que aparecen en el televisor.
- La vista de los niños pequeños (especialmente de menos de seis años) todavía está en proceso de desarrollo. Consulte con su médico (como un pediatra o un oftalmólogo) antes de permitir a niños pequeños ver imágenes de vídeo en 3D.
- Los niños pequeños deben estar bajo la supervisión de un adulto para garantizar que siguen las recomendaciones descritas anteriormente.

## ■ Tecnología Cinavia

- La tecnología Cinavia forma parte del sistema de protección de los contenidos incluido en este reproductor de Blu-ray Disc.

### Nota

- Es posible que aparezcan los siguientes mensajes y que su reproductor de Blu-ray Disc detenga la reproducción o silencie temporalmente la salida de audio si reproduce una copia no autorizada de un contenido protegido mediante la tecnología Cinavia.

Estos mensajes aparecen solo en inglés.

Reproducción detenida. Los contenidos que se están reproduciendo están protegidos por Cinavia™ y su reproducción en este dispositivo no está autorizada. Para más información, visite <http://www.cinavia.com>. Código de Mensaje 1.

Salida de audio temporalmente detenida. No ajuste el volumen de reproducción. Los contenidos que se están reproduciendo están protegidos por Cinavia™ y su reproducción en este dispositivo no está autorizada. Para más información, visite <http://www.cinavia.com>. Código de Mensaje 3.

### Aviso sobre Cinavia

Este producto utiliza la tecnología Cinavia para limitar el uso de copias no autorizadas de algunas películas y vídeos comerciales y de sus bandas sonoras. Al detectar el uso prohibido de una copia no autorizada, aparecerá un mensaje y se detendrá la reproducción o la copia. Para obtener más información sobre la tecnología Cinavia, consulte el Centro de información al consumidor de Cinavia, que encontrará en el sitio web <http://www.cinavia.com>. Para solicitar más información sobre Cinavia por correo, envíe una carta con su dirección de correo a: Cinavia Consumer Information Center, P.O. Box 86851, San Diego, CA, 92138, Estados Unidos.

## ■ Panel delantero

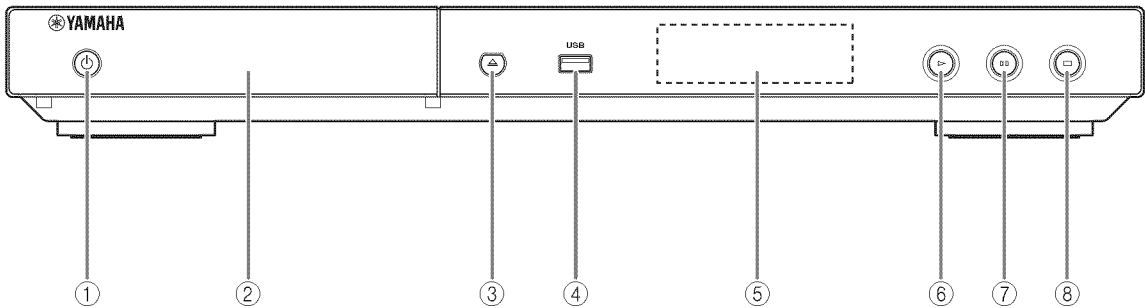

- ① **(Encendido/en espera)**  
Pone en marcha el reproductor/activa el modo en espera. Si mantiene pulsado este botón durante aproximadamente 5 segundos, forzará el arranque del reproductor (se reiniciará el sistema).
- ② **Puerta de la bandeja portadiscos**
- ③ **(Expulsar)**  
Abre/cierra la bandeja portadiscos.
- ④ **Conector USB (pág. 11)**
- ⑤ **Visor del panel delantero**  
Muestra distintos tipos de información sobre el estado del dispositivo.
- ⑥ **(Reproducción)**  
Inicia la reproducción.
- ⑦ **(Pausa)**  
Pone la reproducción en pausa.
- ⑧ **(Detener)**  
Detiene la reproducción.

### Nota

- Una película protectora colocada en la fábrica cubre el panel delantero de este reproductor. Retírela antes de empezar a utilizar el reproductor.

## ■ Panel trasero

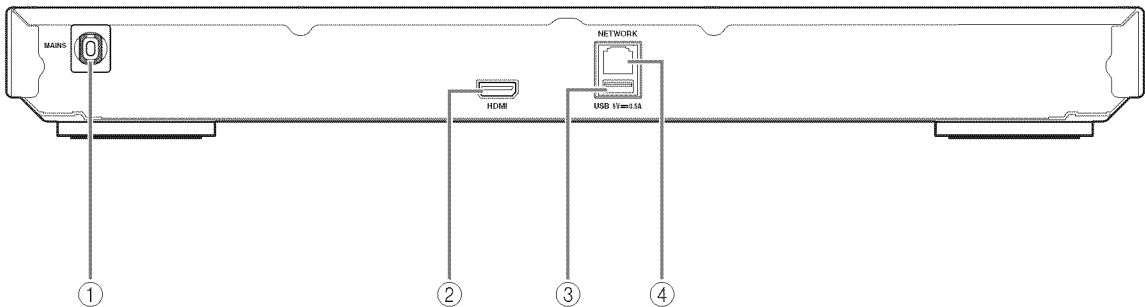

- ① **Cable de alimentación**  
Este reproductor tiene un cable de alimentación cautivo. Conéctelo a una toma de corriente de CA después de realizar todas las conexiones (pág. 10).
- ② **Terminal HDMI (pág. 10)**
- ③ **Conector USB (pág. 11)**
- ④ **Terminal NETWORK (pág. 11)**

### Nota

- Para prevenir el riesgo de descargas eléctricas, no toque las partes sin aislamiento de ningún cable cuando el cable de alimentación esté conectado.





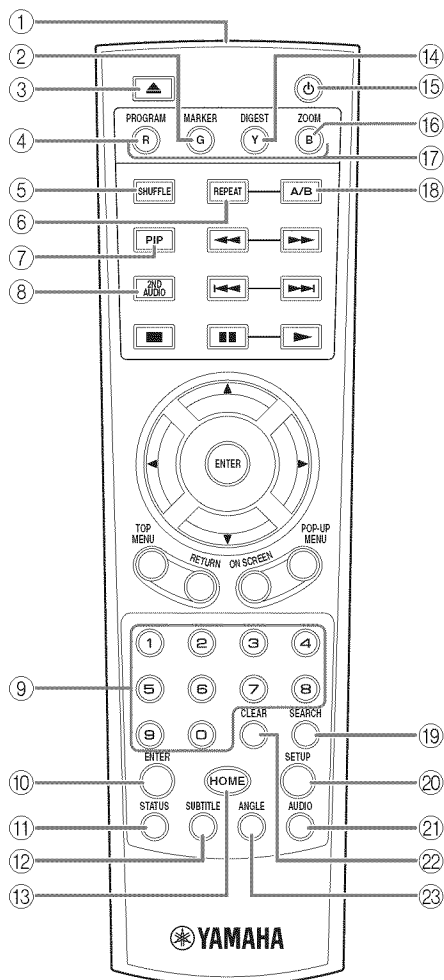

- ② **Terminal HDMI (pág. 10)**
- ③ **Conector USB (pág. 11)**

## Mando a distancia

### Nota

-  aparecerá en la esquina superior izquierda de la pantalla cuando la tecla pulsada no esté disponible.



- 1 **Transmisor de señales infrarrojas:** emite la señal infrarroja. Oriente esta ventana al sensor del mando a distancia (pág. 9).
- 2 **MARKER DVD VIDEO:** establece un Marcador (pág. 19) en un punto concreto de una película. Tras definir un Marcador, para seleccionar el punto de ajuste al que desea ir, pulse **DIGEST**. Puede definir hasta 12 marcadores.
- 3 : abre/cierra la bandeja portadiscos.
- 4 **PROGRAM DVD CD:** establece el orden de reproducción (pág. 19). Puede configurar hasta 15 pistas (para discos de audio) o títulos/capítulos (DVD-Video).
- 5 **SHUFFLE DVD CD VIDEO MUSIC PHOTO:** selecciona el modo de reproducción aleatoria (pág. 17).
- 6 **REPEAT BD DVD CD VIDEO MUSIC PHOTO:** permite cambiar el modo de repetición. El modo de repetición mostrado a continuación cambiará cada vez que se pulse el botón.
  - : repite el título que se está reproduciendo.
  - : repite el capítulo que se está reproduciendo.
  - : repite la carpeta que se está reproduciendo.
  - : repite todas las pistas/archivos del disco.
  - : repite la pista/archivo que se está reproduciendo.
- 7 **PIP BD:** permite encender/apagar la función Imagen en pantalla (pág. 20). Marca PIP () se muestra en pantalla cuando esta función está disponible. También puede seleccionar esta opción desde el menú en pantalla (pág. 17).

### Nota

- Marca PIP se muestra solo cuando la Marca PIP está activada (pág. 25).
- 8 **2ND AUDIO BD:** selecciona el audio secundario de la función Imagen en imagen (pág. 20) o los comentarios de audio. Cuando esta función está disponible se muestra en pantalla Marca Audio Secundario () (pág. 27). También puede seleccionar esta opción desde el menú en pantalla (pág. 17).

### Nota

- Marca Audio Secundario se muestra solo cuando la Marca Audio Secundario está activada (pág. 25).
- 9 **Botones numéricos:** permiten introducir números o, durante la reproducción, saltar a la pista/capítulo correspondiente al número introducido. Es posible que estos botones no estén disponibles en función del tipo de disco y la situación de reproducción.



- ⑩ **ENTER:** selecciona el menú/opción resaltado.
- ⑪ **STATUS:** muestra la información de reproducción (pág. 18).
- ⑫ **SUBTITLE** **BD** **DVD** **VIDEO**: permite cambiar el idioma de los subtítulos (pág. 35) si está disponible. También puede seleccionar esta opción desde el menú en pantalla (pág. 17).
- ⑬ **HOME:** muestra la pantalla del menú HOME (pág. 13).
- ⑭ **DIGEST** **PHOTO**: muestra 12 fotografías en miniatura. Cuando se muestran las miniaturas, puede ir a la página siguiente o anterior con **◀◀/▶▶**.  
**DVD** **VIDEO**: muestra la barra de selección Marcador (pág. 19).
- ⑮ **⏻**: enciende el reproductor o lo pone en modo de espera.
- ⑯ **ZOOM** **DVD** **VIDEO** **PHOTO**: acerca/aleja la imagen. El tamaño de la pantalla cambiará cada vez que pulse la tecla (acercar/alejar la imagen: 3 pasos cada uno).
- ⑰ **Botones de colores** **BD**: utilice estos botones según las instrucciones en pantalla.
- ⑱ **A/B** **BD** **DVD** **CD** **VIDEO** **MUSIC**: permite reproducir una parte específica que desee repetir.
  - 1 Pulse **A/B** en la escena donde desee establecer el punto inicial. Aparecerá "A-" en la pantalla.
  - 2 Vuelva a pulsar **A/B** en la escena donde desee establecer el punto final. Aparecerá "A-B" en la pantalla. Se inicia la reproducción de la repetición.
  - 3 Para cancelar la reproducción de la repetición, pulse **A/B**. Desaparecerá "A-B" y terminará la reproducción de la repetición.

**Nota**

– Es posible que esta función no se pueda realizar dependiendo de las especificaciones del disco.

- ⑲ **SEARCH** **BD** **DVD** **CD** **VIDEO** **MUSIC**: permite ir a un punto especificado durante la reproducción. Para conocer los detalles sobre esta función, consulte "Uso de la búsqueda" (pág. 19). También puede seleccionar esta opción desde el menú de estado (pág. 18).
- ⑳ **SETUP:** muestra la pantalla de menú SETUP (pág. 21).
- ㉑ **AUDIO** **BD** **DVD**: permite cambiar el idioma o formato de audio. También puede seleccionar esta opción desde el menú en pantalla (pág. 17).
- ㉒ **CLEAR:** borra el número introducido o la opción seleccionada.

- ㉓ **ANGLE** **BD** **DVD**: permite cambiar el ángulo de la cámara si el vídeo se ha grabado con varios ángulos. Cuando esta función está disponible se muestra en pantalla Marca de Angulo (). También puede seleccionar esta opción desde el menú en pantalla (pág. 17).

**Nota**

– Marca de Angulo se muestra solo cuando la Marca de Angulo está activada (pág. 25).

**Continúa en la página siguiente. ➔**

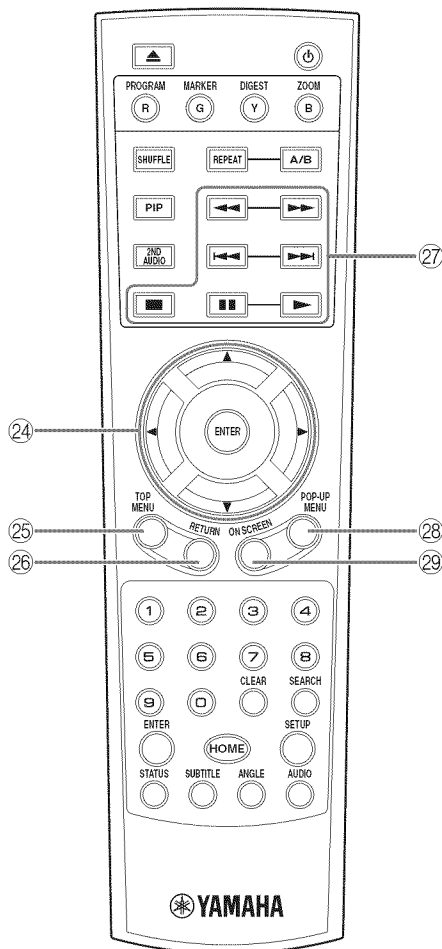

24 **Botones de cursor (▲/▼/◀/▶)**: permiten cambiar la selección en la pantalla de menú.

**ENTER**: selecciona el menú/opción resaltado.

25 **TOP MENU** **BD** **DVD**: muestra la pantalla de menú principal si el disco contiene un menú. Seleccione la opción deseada mediante ▲/▼/◀/▶ y **ENTER**.

**Nota**

– Las operaciones concretas pueden diferir dependiendo del disco. Siga las instrucciones de cada pantalla de menú,

26 **RETURN**: permite volver al menú o pantalla anterior, etc.

27 **Botones de control**

**BD** **DVD** **CD** **VIDEO** **MUSIC** **PHOTO**

■: detiene la reproducción. Para detener totalmente la reproducción, pulse dos veces este botón.

■: pone la reproducción en pausa.

▶: reproduce el contenido.

◀/▶

**BD** **DVD** **CD** **VIDEO** **MUSIC**:

permite buscar hacia atrás/hacia adelante. La velocidad de búsqueda cambiará cada vez que pulse el botón (buscar hacia atrás/adelante: 5 pasos cada uno). Pulse ▶ para reanudar la reproducción normal.

**PHOTO**: permite cambiar la velocidad de un pase de diapositivas (más lento/más rápido: 3 pasos).

◀/▶: permite saltar hacia atrás/hacia adelante.

**Nota**

– En función del disco, el reproductor reanuda la reproducción desde el punto en el que se paró anteriormente el reproductor. Para reproducir desde el principio, pulse ■ dos veces y después ▶.

28 **POP-UP/MENU** **BD** **DVD**: muestra el menú emergente. Los contenidos del menú que aparecen varían en función del disco. Encontrará más información sobre cómo ver y controlar el menú emergente en el manual del disco.

La pantalla del menú principal aparece a veces al pulsar **POP-UP/MENU**, dependiendo del DVD.

29 **ON SCREEN**: muestra el menú en pantalla (pág. 17).

## Instalación de las pilas en el mando a distancia

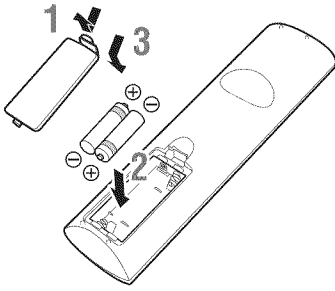

### Notas

- Cambie las dos pilas cuando note que disminuye el alcance del mando a distancia.
- Utilice pilas AAA, R03 y UM-4.
- Asegúrese de que las polaridades son las correctas. Consulte la ilustración que encontrará en el interior del compartimento de las pilas.
- Extraiga las pilas si no va a utilizar el mando a distancia durante un periodo de tiempo prolongado.
- No mezcle pilas viejas con pilas nuevas.
- No utilice juntas pilas de diferentes tipos (como pilas alcalinas y pilas de manganeso). Lea con atención la información del paquete, ya que diferentes tipos de pilas pueden tener la misma forma y color.
- Si observa fugas en las pilas, deséchelas inmediatamente. Evite tocar el material derramado y no deje que entre en contacto con ropa, etc. Limpie con cuidado el compartimento antes de colocar pilas nuevas.
- No mezcle las pilas con los residuos domésticos; deséchelas siguiendo la normativa local.
- Mantenga las pilas fuera del alcance de los niños. En caso de que se traguen una por accidente, acuda inmediatamente a un médico.
- Si tiene previsto no utilizar el mando a distancia durante un periodo de tiempo prolongado, extraiga las pilas del mando a distancia.
- No cargue ni desmonte las pilas suministradas.

## Alcance aproximado de funcionamiento del mando a distancia

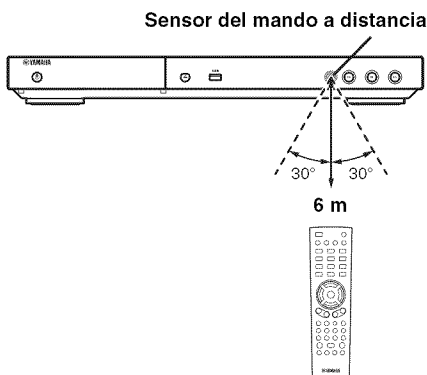

# Conexión HDMI

## ■ Conexión con el terminal HDMI

- Puede disfrutar de imagen y sonido digital de alta calidad a través del terminal HDMI.
- Conecte con firmeza un cable HDMI (de venta en el mercado) a los terminales HDMI.
- Consulte la página 28 para obtener información sobre los formatos de salida de audio/vídeo.
- Utilice cables HIGH SPEED HDMI con el logotipo HDMI (tal como se muestra en la contraportada).

## ¡Precaución!

**No conecte el cable de alimentación del reproductor hasta haber realizado todas las conexiones.**

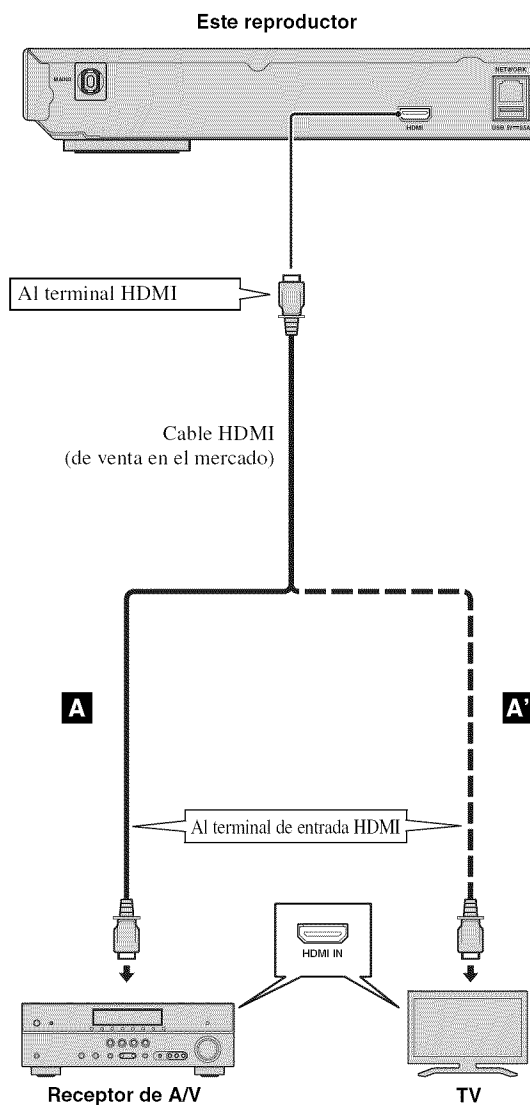

## Consejos

- Cuando utilice la función Control HDMI, consulte “Control HDMI” (pág. 24).
- Para obtener más información sobre el modo de salida del terminal HDMI, consulte “HDMI” (pág. 27).
- Si no aparece la imagen, consulte “Resolución de problemas” (pág. 32).

## ■ Conexión para la reproducción de discos Blu-ray 3D

Para disfrutar de discos Blu-ray 3D en este reproductor, necesita los equipos y conexiones siguientes:

- Necesita un televisor y un receptor de A/V (si es preciso) con funcionalidad 3D.
- Todos los componentes deben estar conectados con cables HDMI.
- El Blu-ray Disc debe contener imágenes 3D.
- Debe ajustar la opción Salida 3D de Configuración de pantalla (pág. 26) en Auto.

# Conexión de red y USB

2

Conexiones

## ■ Conexión con el terminal NETWORK

- El contenido del PC se puede reproducir conectando este reproductor a la red.
- Puede disfrutar de un amplio abanico de contenidos con funciones interactivas mediante la conexión a Internet cuando reproduzca discos compatibles BD-Live. Consulte la página 20 para obtener más información sobre las funciones de BD-Live.

### Notas

- Conecte con firmeza un cable de red (de venta en el mercado) al terminal NETWORK.
- Utilice solo un cable de red STP (par trenzado blindado).
- Cuando utilice Internet, necesitará una conexión a Internet de banda ancha como se muestra más abajo.
- Conecte el otro conector del cable de red al nodo/enrutador de banda ancha.
- Cuando utilice una conexión a Internet de banda ancha, es necesario un contrato con un proveedor de servicios de Internet. Para más información, póngase en contacto con su proveedor de servicios de Internet más cercano.
- Consulte el manual de instrucciones de su equipo, ya que el equipo conectado y el método de conexión pueden variar dependiendo de su entorno de Internet.
- Emplee un cable de red/enrutador compatible con 10BASE-T/100BASE-TX.

## ■ Conexión con el conector USB

- Puede conectar un dispositivo de memoria USB para Almacenamiento Local al conector USB del panel posterior (o delantero) del reproductor para guardar los datos BD-Live o para actualizar el software de este reproductor.
- Conecte con firmeza un dispositivo de memoria USB (de venta en el mercado) al conector USB.

### PRECAUCIÓN:

- No desconecte el dispositivo de memoria USB ni desenchufe el cable de alimentación mientras se estén realizando las operaciones de BD-Live (pág. 20) o se esté llevando a cabo la actualización del software.
- No utilice un cable de extensión USB cuando conecte un dispositivo de memoria USB al conector USB del reproductor. El uso de un cable de extensión USB puede impedir que el reproductor funcione correctamente.

### Nota

- Yamaha no puede garantizar que los dispositivos de memoria USB de todas las marcas funcionen con este reproductor.

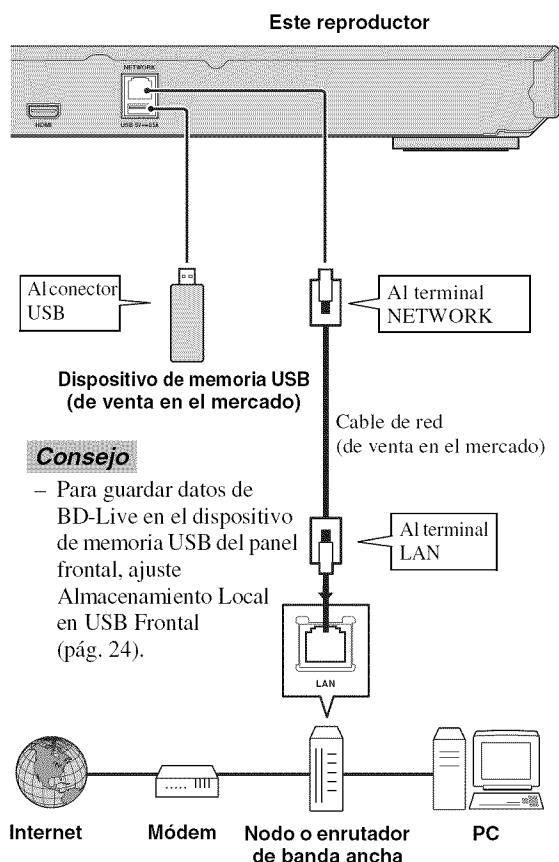

### Consejo

- Para guardar datos de BD-Live en el dispositivo de memoria USB del panel frontal, ajuste Almacenamiento Local en USB Frontal (pág. 24).

## Después de la conexión

- Para configurar el parámetro de Red manualmente, consulte "Red" (pág. 25).
- Para reproducir el contenido del PC conectado a su red, consulte "Uso de contenidos de red" (pág. 15).

Español

# Asistente inicial/Configuración Sencilla

## ■ Configuración con el Asistente inicial/Configuración Sencilla

Asistente inicial/Configuración Sencilla le permite configurar fácilmente el idioma, la resolución y la relación de aspecto de la pantalla. La pantalla del Asistente inicial aparece la primera vez que enciende este reproductor después de comprarlo. La misma configuración se puede realizar desde el menú SETUP → Sistema → Configuración Sencilla.

- 1 Cuando aparezca la pantalla Configuración Sencilla, pulse **ENTER** para empezar con la Configuración Sencilla.

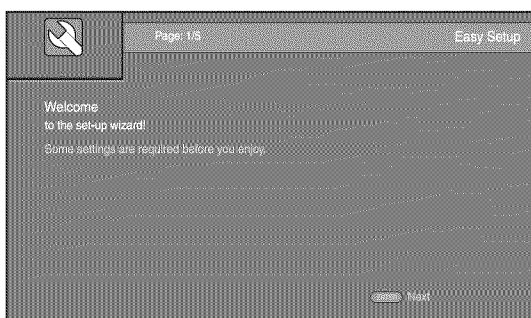

- 2 Configure el idioma, la resolución y la relación de aspecto de la pantalla siguiendo los mensajes que aparecen en pantalla.

### **Notas**

- Si no aparece la imagen tras completar Asistente inicial/Configuración Sencilla, consulte “Resolución de problemas” (pág. 32).
- Aparecerá un mensaje de advertencia acerca de la reproducción de vídeo en 3D al encender este reproductor. Pulse **ENTER** para descartar el mensaje o **CLEAR** para desactivarlo (pág. 24).

# Menú HOME/MEDIA

Los menús HOME y MEDIA le permiten examinar y reproducir archivos multimedia guardados en discos de datos, dispositivos de memoria USB y en su red.

## Nota

- Para obtener información sobre los discos y formatos que se pueden reproducir, consulte la página 3.

## ■ Reproducción de fotos/música/vídeo

### Funcionamiento básico

◀/▶/▲/▼: mueve la selección.

◀: vuelve a la carpeta principal.

**HOME**: permite entrar/salir de la pantalla del menú HOME.

**ENTER**: confirma la carpeta/archivo.

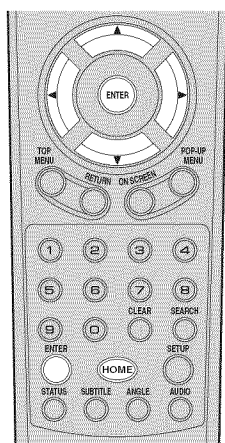

### Iconos sobre el menú MEDIA

: reproduce el disco que hay en la bandeja o muestra el contenido del disco de datos.

: muestra el contenido del dispositivo de memoria USB conectado al conector USB.

: busca un servidor DLNA (pág. 15) en la red.

: muestra el contenido del servidor DLNA conectado.

### Operaciones comunes para la reproducción de archivos en una carpeta seleccionada

**Ejemplo**: selección de un archivo de película en un dispositivo de memoria USB

## Nota

- Detenga la reproducción del vídeo antes de desplazarse a la pantalla del menú MEDIA.

1 Pulse **HOME** para ir a la pantalla del menú HOME.

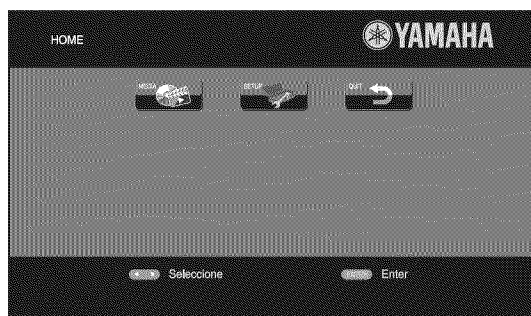

## Consejo

- La pantalla del menú HOME puede variar en función del modelo.

2 Pulse ◀/▶/▲/▼ para seleccionar MEDIA y, a continuación, pulse **ENTER**. Aparece la pantalla MEDIA.



3 Seleccione el elemento que contiene el archivo que desea reproducir y, a continuación, pulse **ENTER**.

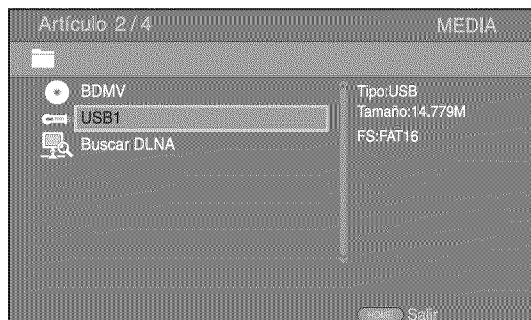

3

Reproducción

Español

- 4 Seleccione la carpeta de Foto, Música, Vídeo o AVCHD que desea reproducir y, a continuación, pulse **ENTER**. Para volver a la carpeta principal, pulse ◀ o seleccione .

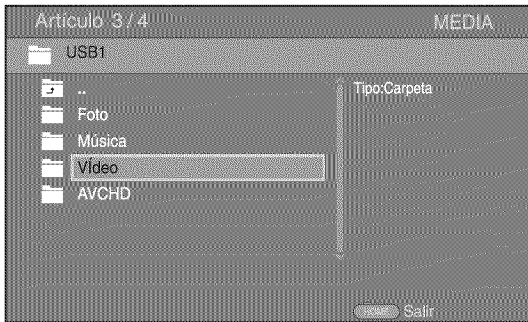

#### Nota

- Tenga en cuenta que en el siguiente paso solo se mostrarán los archivos del tipo que seleccione en este paso. Por ejemplo, si selecciona la carpeta Foto en este paso, solo se mostrarán archivos de fotos después de este paso. Cuando desee reproducir un tipo de archivo que no sea de fotos, vuelva a este paso y seleccione de nuevo el tipo de archivo.
- 5 Seleccione las carpetas que contienen el archivo que desea reproducir.



- 6 Seleccione el archivo que desea reproducir y, a continuación, pulse **ENTER**. Si selecciona un archivo de vídeo, se inicia la reproducción. Si selecciona un archivo de música, se muestra la pantalla de estado y se inicia la reproducción. Si selecciona un archivo de fotos, se inicia el pase de diapositivas.

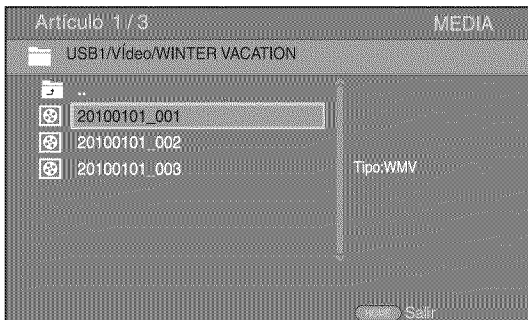

#### Consejo

- Para disfrutar del pase de diapositivas con música, pulse **HOME** para volver a la pantalla del menú HOME mientras se reproduce la música y seleccione un archivo de fotos.

#### Nota

- Es posible que el archivo mostrado no se reproduzca dependiendo del contenido.

## Operaciones para la visualización de fotos

Durante la visualización de fotos, los botones del mando a distancia funcionan como se indica a continuación.

: detiene el pase de diapositivas y vuelve al explorador de archivos.

: pone en pausa el pase de diapositivas.

: reproduce un pase de diapositivas.

: pasa a la foto siguiente.

: pasa a la foto anterior.

: aumenta la velocidad de un pase de diapositivas en 3 pasos.

: reduce la velocidad de un pase de diapositivas en 3 pasos.



: invierte una foto.



: muestra la foto reflejada.

: gira una foto en sentido contrario a las agujas del reloj.

: gira una foto en el sentido de las agujas del reloj.

**ZOOM:** amplía/reduce una foto (ampliar/reducir zoom: 3 pasos cada uno).

//: permite desplazarse en modo de zoom cuando la foto es mayor que la pantalla.

**DIGEST:** activa el modo de miniaturas (pág. 7). Cuando se muestran las miniaturas, puede ir a la página siguiente o anterior con /.



## ■ Uso de contenidos de red

Este reproductor cuenta con la certificación DLNA (pág. 34). Puede administrar fotos, música y vídeos almacenados en servidores DLNA de su red doméstica.

### Reproducción de contenido compartido

- 1 Para reproducir archivos guardados en su PC, instale un software de servidor DLNA como, por ejemplo, Windows Media Player 12 y comparta los archivos que desee reproducir.
- 2 Encienda el PC con el software de servidor DLNA instalado o el dispositivo DLNA conectado a su red doméstica.
- 3 Pulse **HOME** para mostrar la pantalla del menú HOME. Seleccione MEDIA para pasar al menú MEDIA. Los servidores DLNA conectados a la red aparecen en pantalla.

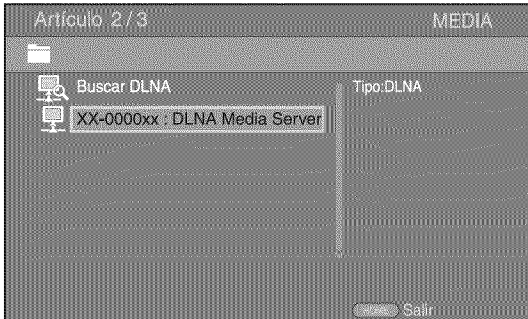

#### Notas

- Si su servidor DLNA no aparece en la lista, seleccione Buscar DLNA para buscarlo.
  - Dependiendo del servidor DLNA, es posible que sea necesario autorizar al reproductor desde el servidor.
  - Para reproducir el archivo guardado en el servidor DLNA, el reproductor y el servidor deben estar conectados al mismo punto de acceso.
  - Es posible que los requisitos de archivo no siempre sean compatibles. Puede haber algunas restricciones dependiendo de las características de los archivos y de la capacidad del servidor DLNA.
- 4 Seleccione el archivo que desee reproducir.

#### Notas

- La calidad de funcionamiento y reproducción podría verse afectada por las condiciones de la red doméstica.
- Es posible que los archivos de soportes extraíbles como dispositivos de memoria USB o unidades de DVD del servidor de soportes no se compartan correctamente.

## Uso de servicios de red

Puede ver al instante los vídeos que ofrecen los servicios de red siguientes.

- YouTube

### Notas

- El acceso a contenidos suministrados por terceros requiere una conexión a Internet de alta velocidad y, a veces, también un registro de cuenta y una suscripción de pago.
- Los servicios de contenidos de terceros pueden modificarse, suspenderse, interrumpirse o dejar de proporcionarse en cualquier momento sin previo aviso, y Yamaha no asume ninguna responsabilidad en este sentido.
- Es posible que parte de los contenidos solo estén disponibles en algunos países y que se presenten en idiomas específicos.
- Yamaha no garantiza que los servicios de contenidos se seguirán proporcionando ni estarán disponibles durante un periodo de tiempo concreto y rechaza cualquier garantía de este tipo, ya sea expresa o implícita.

## Reproducción de vídeos de YouTube™

Puede ver películas de YouTube a través de Internet mediante este reproductor.

Los servicios pueden modificarse sin previo aviso.

- 1 Pulse **HOME** para mostrar la pantalla del menú HOME.

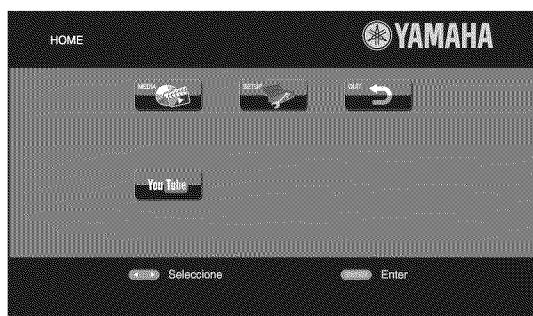

### Consejo

- La pantalla del menú HOME puede variar en función del modelo.
- 2 Pulse **◀/▶/▲/▼** para seleccionar YouTube y, a continuación, pulse **ENTER**.

### Consejo

- Para volver a la pantalla del menú HOME, pulse **RETURN**.

# Funciones avanzadas de reproducción

En este capítulo se explica la reproducción de discos Blu-ray, DVD y CD de venta en el mercado, así como discos DVD-RW/R grabados.

## Nota

- Para conocer las funciones básicas de reproducción, consulte la página 6.

## Menú en pantalla

Para mostrar el menú en pantalla, pulse **ON SCREEN**. A continuación, pulse **▲/▼/◀/▶** para seleccionar una opción y, después, pulse **ENTER** para utilizar la función deseada.

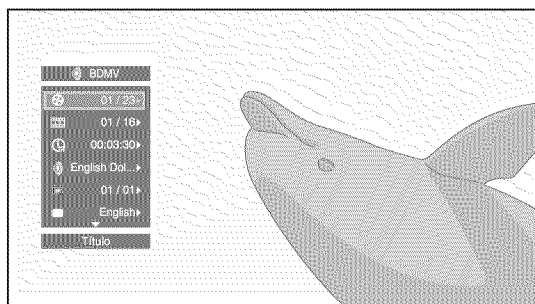

El menú en pantalla consta de las siguientes opciones.

**Título** **BD** **DVD** **VIDEO**: muestra el número del título que se está reproduciendo. Puede ir al título deseado seleccionándolo desde esta opción.

**Capítulo** **BD** **DVD** **VIDEO**: muestra el número del capítulo que se está reproduciendo. Puede ir al capítulo deseado seleccionándolo desde esta opción.

**Pista/Archivo** **CD** **VIDEO** **MUSIC** **PHOTO**: muestra el número de la pista o archivo que se está reproduciendo. Puede ir a la pista o al archivo deseado seleccionándolo desde esta opción.

**Hora** **BD** **DVD** **CD** **VIDEO** **MUSIC**: muestra el tiempo de reproducción. Seleccione el tipo de visualización entre las siguientes posibilidades:

- Tiempo de reproducción transcurrido del título, capítulo, disco, pista o archivo
- Tiempo de reproducción restante del título, capítulo, disco, pista o archivo

## Modo/Modo de reproducción

**DVD** **CD** **VIDEO** **MUSIC** **PHOTO**: muestra el modo de reproducción actual. Puede seleccionar uno de los modos de reproducción siguientes:

### CD

- Normal: reproducción normal.
- Shuffle: reproducción aleatoria sin repetición.
- Aleatorio: reproducción aleatoria con repetición.

### DVD

- Normal
- Shuffle CH (capítulo)
- Shuffle TT (título)
- Shuffle All
- Aleatorio CH (capítulo)
- Aleatorio TT (título)
- Aleatorio All

### VIDEO MUSIC PHOTO

- Normal
- Shuffle F (carpeta)
- Aleatorio F (carpeta)

**Audio** **BD** **DVD** **VIDEO**: muestra el idioma/señal de audio del Blu-ray Disc/DVD seleccionado. Puede seleccionar el tipo de audio deseado.

**Ángulo** **BD** **DVD**: muestra el número del ángulo seleccionado en ese momento. Si el vídeo se ha grabado con varios ángulos, puede cambiar el ángulo.

**Subtítulo** **BD** **DVD** **VIDEO**: muestra el idioma de los subtítulos seleccionado si hay subtítulos.

**Estilo subtítulos** **BD**: muestra el estilo de los subtítulos seleccionado. Esta función solo está disponible para subtítulos externos de archivo de vídeo. Puede seleccionar el estilo de texto deseado de los subtítulos.

**Bitrate** **BD** **DVD** **CD** **VIDEO** **MUSIC**: muestra el bitrate de la señal de audio/vídeo.

**Video secundario** **BD**: activa o desactiva PIP (pág. 6).

**Audio Secundario** **BD**: activa o desactiva el audio secundario (pág. 6).

## Búsqueda Ins

**BD** **DVD** **CD** **VIDEO** **MUSIC**: salta 30 segundos.

## Repetición Ins

**BD** **DVD** **CD** **VIDEO** **MUSIC**: reproduce el contenido desde 10 segundos antes.

## Pase de diapositivas: PHOTO:

muestra la velocidad del pase de diapositivas. Puede seleccionar la velocidad del pase de diapositivas entre Lento/Medio/Rápido.

**Transición** **PHOTO**: muestra cómo aparece la foto en la pantalla. Puede seleccionar el tipo de transición.

## Menú de estado

Muestra varios ajustes, cómo los subtítulos, el ángulo y el número de título/capítulo/pista reproducido. Para mostrar el menú de estado, pulse **STATUS**. El menú de estado consta de los siguientes menús.

**BD DVD VIDEO**

**Ejemplo:** Iconos que aparecen al reproducir un Blu-ray Disc

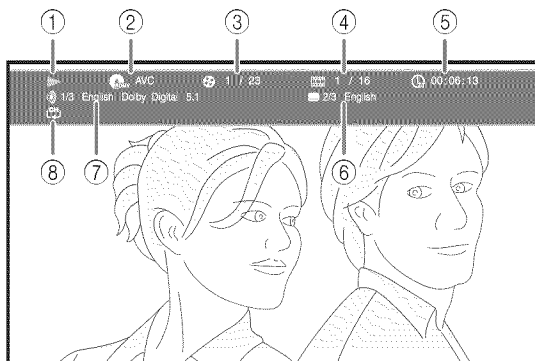

- ① **(Estado de reproducción)**
- ② **BD-MV (Icono de tipo de disco/archivo de vídeo)**
- ③ **(Número del título que se está reproduciendo):** puede ir al título especificado con el botón **SEARCH** (pág. 7).
- ④ **(Número del capítulo que se está reproduciendo):** puede ir al capítulo especificado con el botón **SEARCH** (pág. 7).
- ⑤ **(Tiempo de reproducción transcurrido):** puede ir al punto especificado con el botón **SEARCH** (pág. 7).
- ⑥ **(Subtítulo seleccionado):** puede cambiar el idioma de los subtítulos con el botón **SUBTITLE**.
- ⑦ **(Audio seleccionado):** puede cambiar el formato o idioma de audio con el botón **AUDIO**.
- ⑧ **CH (Modo repetición):** muestra el modo de repetición actual (pág. 6).

**CD MUSIC**

**Ejemplo:** Iconos que aparecen al reproducir un archivo de música

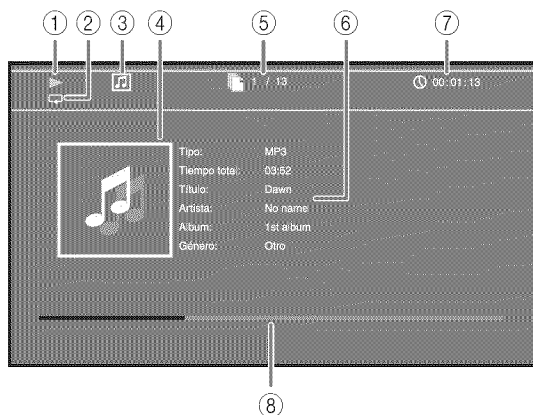

- ① **(Estado de reproducción)**
- ② **(Modo repetición):** muestra el modo de repetición actual (pág. 6).
- ③ **(Icono de tipo de disco/archivo de música)**
- ④ **(Gráficos) MUSIC:** muestra gráficos si el archivo tiene estos contenidos.
- ⑤ **(Número de pista/archivo reproducido):** puede ir a la pista especificada con el botón **SEARCH** (pág. 7).
- ⑥ **(Información) MUSIC:** muestra información sobre la música si está incluida en el archivo.
- ⑦ **(Tiempo de reproducción transcurrido):** puede ir al punto especificado con el botón **SEARCH** (pág. 7).
- ⑧ **(Barra de progreso) MUSIC:** muestra el estado de progreso de la canción actual.

**PHOTO**



- ① **(Estado de reproducción)**
- ② **(Icono de archivo de fotos)**
- ③ **(Número del archivo mostrado)**
- ④ **(Modo repetición):** muestra el modo de repetición actual (pág. 6).
- ⑤ **(Velocidad de pase de diapositivas)**

## ■ Uso de Marcador **DVD VIDEO**

Le permite establecer un Marcador en un punto especificado del vídeo. Después de establecer el Marcador, puede ir al punto elegido utilizando esta función. Puede definir hasta 12 marcadores.

- 1 Pulse **MARKER** durante la reproducción de la película para definir un Marcador. Se muestran el número de Marcador y el estado.



- 2 Después de establecer el Marcador, pulse **DIGEST** para mostrar la barra de selección de Marcador.



- 3 Pulse **◀▶** para seleccionar el Marcador que desee reproducir y, a continuación, pulse **ENTER**. Pulse **CLEAR** para eliminar el Marcador seleccionado.

### Nota

- Cuando finaliza la reproducción (por ejemplo, al expulsar el disco o al presionar **■** dos veces), los marcadores se eliminan automáticamente.

## ■ Programación de la reproducción **DVD CD**

Esta opción le permite programar el orden de reproducción de las pistas de un disco de audio o de los capítulos de un DVD.

Pulse **PROGRAM** durante la reproducción para mostrar la ventana PROGRAMA para programar el orden de reproducción.

Puede programar hasta 15 pistas/capítulos.

**Ejemplo:** Programación del orden de reproducción de las pistas de un CD

- 1 Pulse **PROGRAM** durante la reproducción.



- 2 Pulse **ENTER** para programar el orden de reproducción. En un disco de audio, pulse **▲/▼** para seleccionar una pista y, a continuación, pulse **ENTER**.

En un disco DVD de vídeo, seleccione un título (indicado con TT) y un capítulo (indicado con CH) en lugar de una pista.

Para borrar una pista configurada, seleccione la pista que desea borrar y, a continuación, pulse **CLEAR**.

Pulse **RETURN** para cancelar la reproducción del programa.

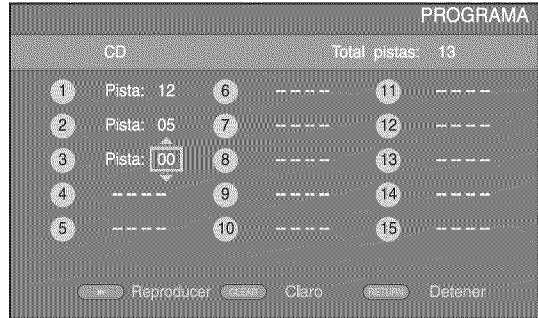

- 3 Una vez finalizada la programación, pulse **▶** para definir e iniciar la reproducción del programa.
- 4 Para cancelar la reproducción del programa, detenga la reproducción por completo pulsando **■** dos veces.





## ■ Uso de la búsqueda

**BD DVD CD VIDEO MUSIC PHOTO**



Esta opción le permite ir a un punto específico durante la reproducción.

- 1 Pulse **SEARCH** durante la reproducción. Aparece la barra de estado.
- 2 Pulse **▲/▼/◀▶** para seleccionar una de las opciones siguientes y, a continuación, pulse **ENTER**.



**BD DVD :**

- Número de título (indicado con )
- Número de capítulo (indicado con )
- Tiempo de título transcurrido (indicado con )
- Tiempo de capítulo transcurrido (indicado con )

**CD :**

- Número de pista (indicado con )
- Tiempo de pista transcurrido (indicado con )
- Tiempo de disco transcurrido (indicado con )

**VIDEO MUSIC :**

- Número de archivo (indicado con )
- Tiempo de archivo transcurrido (indicado con )

**PHOTO :**

- Número de archivo (indicado con )

- 3 Pulse **▲/▼** o los botones numéricos para definir o ajustar el valor de la opción seleccionada y pulse **ENTER** para ir al punto especificado.
- 4 Para cerrar la barra de estado, pulse **STATUS**.

## ■ Uso de BONUSVIEW™ y BD-Live™

Este reproductor admite las funciones de reproducción de BONUSVIEW (pág. 34) (BD-ROM Perfil 1 versión 1.1) y BD-Live (pág. 34) (BD-ROM Perfil 2).

### Nota

- Las funciones y el método de reproducción varían según el disco. Siga las indicaciones del disco o del manual de usuario suministrado.

## ■ Utilización de la función Imagen en Imagen (reproducción de audio/vídeo secundario)

El Vídeo BD que incluye audio y vídeo secundario compatible con Imagen en Imagen se puede reproducir con audio y vídeo secundario simultáneamente como un vídeo pequeño en la esquina.

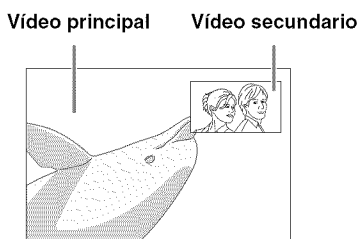

**Mientras se muestra Marca PIP (PIP) o Marca Audio Secundario (AS), pulse PIP para activar o desactivar la función Imagen en imagen.**

### Notas

- Para escuchar audio secundario, asegúrese de que el ajuste Salida de audio (HDMI) se encuentre en la posición PCM o Recodificar (pág. 27).
- Dependiendo del disco, para escuchar audio secundario, es posible que tenga que activar el audio secundario desde el menú principal del disco (pág. 8).
- Dependiendo del contenido, el audio y el vídeo secundario para Imagen en Imagen pueden reproducirse y desaparecer automáticamente. Además, puede haber restricciones con respecto a las áreas que pueden reproducirse.

## ■ Utilización de la función BD-Live™

### 1. Ajuste la configuración de red (pág. 25).

### 2. Conecte el dispositivo de memoria USB al reproductor (pág. 11).

Los datos de BD-Live se guardan en un dispositivo de memoria USB conectado a este reproductor. Para disfrutar de estas funciones, conecte un dispositivo de memoria USB compatible con USB 2.0 de alta velocidad (480 Mbit/s) al conector USB seleccionado en Almacenamiento Local (pág. 24). La configuración predeterminada es el conector USB del panel trasero.

- La carpeta BUDA se crea automáticamente en el dispositivo de memoria USB cuando es necesario.
- Si el espacio de almacenamiento es insuficiente, los datos no se copiarán/descargarán. Elimine datos innecesarios o utilice otro dispositivo de memoria USB.
- La carga de los datos (lectura/escritura) puede llevar un tiempo.

### Notas

- Yamaha no puede garantizar que los dispositivos de memoria USB de todas las marcas funcionen con este reproductor.
- No utilice un cable de extensión USB cuando conecte un dispositivo de memoria USB al conector USB del reproductor. El uso de un cable de extensión USB puede impedir que el reproductor funcione correctamente.

### 3. Reproduzca el disco.

### 4. Ejecute BD-Live siguiendo las instrucciones del disco.



### Notas

- En relación con el método de reproducción de contenidos BD-Live, etc., lleve a cabo las operaciones de acuerdo con las instrucciones del manual del Blu-ray Disc.
- Para disfrutar de las funciones de BD-Live, realice la conexión de red (pág. 11) y los ajustes de Red (pág. 25).
- Consulte el apartado “Conexión BD-Live” (pág. 25) para obtener información sobre la configuración para restringir el acceso a contenidos BD-Live.
- El tiempo que se necesita para descargar los programas ofrecidos al dispositivo de memoria USB conectado a este reproductor depende de las velocidades de conexión a Internet y del volumen de datos de los programas.
- Es posible que los programas BD-Live suministrados a través de Internet no puedan mostrar la conexión dependiendo del estado (actualización) del proveedor. En este caso, extraiga el disco y vuelva a intentarlo.
- Si la pantalla BD-Live no aparece durante un rato después de seleccionar la función BD-Live en el menú del Blu-ray Disc, es posible que el dispositivo de memoria USB no tenga suficiente espacio libre. En este caso, expulse el disco del reproductor y, a continuación, borre los datos del dispositivo de memoria USB utilizando el menú “Formato” de “Almacenamiento Local” (pág. 24).

# Menú SETUP

El menú SETUP permite realizar diversos ajustes y configuraciones audiovisuales en las funciones utilizando el mando a distancia.

Menú/submenú	Opción	Función	Página	
 <b>Configuración General</b>	<b>Sistema</b>	Protector de pantalla	Activa/desactiva el protector de pantalla.	24
	Reproducción Automática Disco	Ajusta el reproductor para que inicie automáticamente la reproducción del disco.	24	
	Control HDMI	Configura el reproductor para que reciba la señal de control desde el mando a distancia de su televisor/receptor de A/V.	24	
	Cargar configuración por defecto	Restablece todos los ajustes a los valores predeterminados, excepto el ajuste Seguridad.	24	
	Actualizar	Aplica la actualización del reproductor.	24	
	Configuración Sencilla	Ajusta el idioma, la resolución y la relación de aspecto de la pantalla.	24	
	Almacenamiento Local	Muestra el estado de Almacenamiento Local (pág. 24), formatea Almacenamiento Local y selecciona el conector USB delantero o posterior de Almacenamiento Local.	24	
	Mensaje Reproducción 3D	Muestra un mensaje de advertencia acerca de la reproducción de vídeo en 3D al encender este reproductor.	24	
	<b>Idioma</b>	OSD	Selecciona el idioma del menú en pantalla.	24
	Menú	Permite dar prioridad al idioma del menú del disco.	24	
	Audio	Permite dar prioridad al idioma del audio.	24	
	Subtítulo	Permite dar prioridad al idioma de los subtítulos.	24	
	<b>Reproducción</b>	Marca de Angulo	Permite mostrar la Marca de Angulo cuando se reproducen Blu-ray Disc/DVD con varios ángulos.	25
	Marca PIP	Permite mostrar la Marca PIP cuando se reproducen Blu-ray Disc/DVD con Imagen en imagen.	25	
	Marca Audio Secundario	Permite mostrar la Marca Audio Secundario cuando se reproducen Blu-ray Disc/DVD con audio secundario.	25	
	Memoria última	Configura este reproductor para que recuerde la última posición de reproducción de un disco cuando se pone en modo de espera o si se abre la bandeja portadiscos.	25	
	<b>Seguridad</b>	Cambiar Contraseña	Permite cambiar la contraseña de Control Paterno y Código de país.	25
	Control Paterno	Establece el Control Paterno en función del contenido del disco.	25	
	Código de país	Establece el Código de país.	25	
	<b>Red</b>	Conexión a Internet	Permite definir la conexión a Internet en Permitir/Desactivar.	25
	Información	Muestra la pantalla de información de red.	25	
	Prueba de conexión	Realiza la prueba de conexión de red.	25	
	Configuración IP	Permite definir la configuración IP en Auto/Manual.	25	
	Conexión BD-Live	Permite definir la conexión a BD-Live en Autorizada/Permitida Parcialmente/Prohibido.	25	
	DLNA	Permite definir la conexión a DLNA en Permitir/Desactivar.	25	
	Configuración Proxy	Permite definir la configuración proxy.	25	

Menú/submenú	Opción	Función	Página	
 <b>Configuración de pantalla</b>	<b>TV</b>	Salida 3D	Selecciona vídeos en 3D o 2D.	26
	Pantalla de TV	Ajusta la relación de aspecto de la pantalla del televisor conectado y ajusta la salida de vídeo.	26	
	Seleccionar Salida de Video	Selecciona la resolución de la salida de vídeo.	26	
	Sistema de TV	Permite seleccionar el Sistema de TV entre NTSC/PAL/Multi.	26	
	Color Space	Permite seleccionar Color Space entre YCbCr 4:4:4/YCbCr 4:2:2/Full RGB/RGB.	26	
	HDMI Deep Color	Permite seleccionar HDMI Deep Color entre 30 bits/36 bits/48 bits/Desactivar.	26	
	HDMI 1080p 24Hz	Ajusta HDMI 1080p 24Hz en la configuración automática o lo desactiva.	27	
	Sincronismo de labios	Ajusta el retardo entre vídeo y audio, como por ejemplo cuando el movimiento de la boca no se corresponde con la voz.	27	
	<b>Procesamiento de Video</b>	Modo de vídeo	Ajusta la imagen visual.	27
	Ajuste de color	Ajusta Brillo/Saturación/Tonalidad para cada color.	27	
	Reducción de ruido	Ajusta el nivel de Reducción de ruido.	27	
Modo desentrelazado	Ajusta cómo detectar la señal de vídeo.	27		
 <b>Configuración de audio</b>	<b>Salida de audio</b>	HDMI	Permite seleccionar el modo de salida del terminal HDMI entre Bitstream/PCM/Recodificar/Desactivar.	27
	DRC	Define el valor de DRC (Compresión de gama dinámica).	27	
 <b>Sistema de Información</b>			Muestra la versión de software y la dirección MAC (pág. 34).	27



## ■ Ejemplo de funcionamiento del menú SETUP

Debe acceder a la pantalla del menú SETUP para realizar ajustes en el reproductor. A continuación se explican las operaciones básicas del menú SETUP.

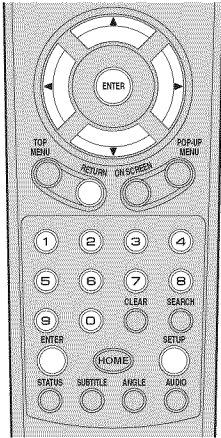

**Ejemplo:** Ajuste del Control Paterno

### Nota

- Algunas opciones no se pueden ajustar durante la reproducción. En este caso, pulse dos veces para detener la reproducción completamente antes de realizar el ajuste.

### 1. Muestre la pantalla del menú SETUP.

Pulse **SETUP** para mostrar la pantalla del menú SETUP.

Pulse **◀/▶** para seleccionar Configuración General y, a continuación, pulse **ENTER** o **▼**.

### 2. Seleccione un submenú.

Pulse **▲/▼** para seleccionar Seguridad y, a continuación, pulse **ENTER** o el cursor **▶**.

### 3. Seleccione una opción del menú.

Pulse **▲/▼** para seleccionar Control Paterno y, a continuación, pulse **ENTER** o el cursor **▶**.

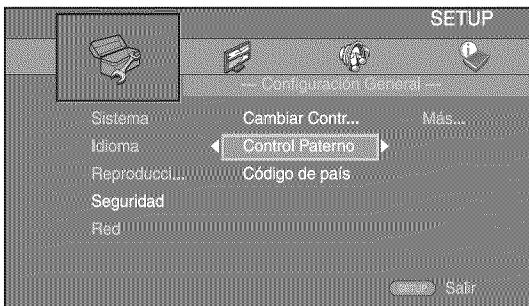

### 4. Introduzca la contraseña.

- Introduzca la contraseña con los botones numéricos.
- La contraseña predeterminada es 0000.
  - No puede ir a la siguiente pantalla de configuración hasta que no haya introducido la contraseña correcta.
  - Para cambiar la contraseña, consulte el apartado “Cambiar Contraseña” (pág. 25).

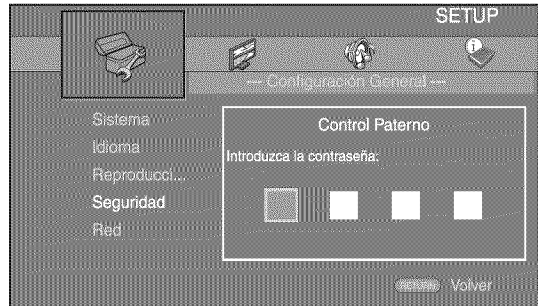

### 5. Seleccione otra opción.

Pulse **▲/▼** para seleccionar el nivel de Control Paterno para Blu-ray Disc/DVD y, a continuación, pulse **ENTER**.

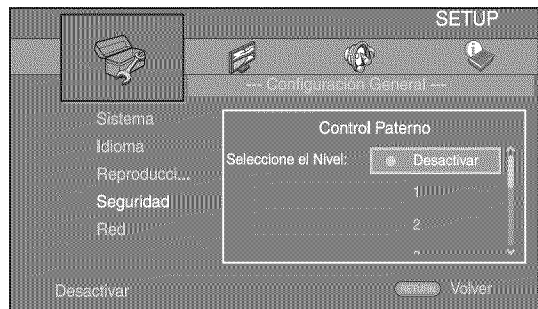

### 6. Salga de la pantalla del menú.

Pulse **◀** para volver al menú anterior.

## ■ Configuración General

Los ajustes predeterminados están marcados con “\*\*\*”.

### Sistema

#### Protector de pantalla

Puede activar o desactivar el protector de pantalla. Cuando se activa, el reproductor pasará al modo de protector de pantalla si no se utiliza durante 3 minutos. Posteriormente, el reproductor pasará al modo de espera cuando no se utilice durante 27 minutos.

Activar\*, Desactivar

#### Reproducción Automática Disco

Puede activar o desactivar la Reproducción Automática Disco. Cuando se activa, el disco se reproducirá automáticamente después de cargarlo.

Activar\*, Desactivar

#### Control HDMI

Puede ajustar el reproductor para que reciba una señal de control desde un televisor/receptor de A/V compatible con la función Control HDMI a través de un cable HDMI (pág. 10).

Activar, Desactivar\*

#### Utilización de la función Control HDMI

Con la función Control HDMI, puede controlar de forma interactiva este reproductor con su televisor (si es compatible con la función Control HDMI).

Cuando se conecta el reproductor a un televisor compatible con la función Control HDMI mediante un cable HDMI y se activa el Control HDMI en el menú SETUP (pág. 24), pueden realizarse las funciones indicadas a continuación.

- Función de selección de entrada automática  
Cuando inicie la reproducción en este reproductor, el selector de entrada del televisor (y de un receptor A/V si este reproductor está conectado con el televisor mediante un receptor A/V) pasará automáticamente a este reproductor. La alimentación del televisor se enciende automáticamente dependiendo del televisor.
- Función de apagado automático  
Si apaga el televisor cuando este reproductor está en modo de parada y no se visualiza la pantalla del menú SETUP, este reproductor también se apagará automáticamente.

#### Notas

- Es posible que la función Control HDMI no funcione correctamente dependiendo del televisor.
- Otras funciones, aparte de las que se han mencionado anteriormente, pueden funcionar según el televisor o receptor A/V.
- Para poder utilizar la función Control HDMI, configure los ajustes de la función Control HDMI en TODOS los componentes (este reproductor, el televisor y el receptor de A/V). Es posible que también sean necesarias determinadas operaciones.
- Cada función se puede configurar de forma independiente para que se active o desactive según el televisor.
- Consulte los detalles relacionados con la configuración en los manuales de funcionamiento que se proporcionan con el televisor y/o el receptor A/V.
- Cuando está activado, el consumo de energía durante el modo de espera aumenta por la función Control HDMI.

#### Cargar configuración por defecto

Puede restablecer todos los ajustes de este reproductor al ajuste predeterminado, excepto el ajuste Seguridad (pág. 25). Para obtener información sobre los ajustes predeterminados, consulte las páginas 21–27.

#### Actualizar

Puede actualizar el software manualmente desde Almacenamiento USB o Red. Para obtener información sobre la actualización de software, consulte “Actualización de software” (pág. 30).

#### Configuración Sencilla

Puede realizar la Configuración Sencilla (pág. 12).

#### Almacenamiento Local

Puede mostrar información de Almacenamiento Local, formatear Almacenamiento Local y seleccionar USB Frontal/USB Trasera para guardar los datos de BD-Live. Para formatear (vaciar) la carpeta “BUDA” en el dispositivo de memoria USB, seleccione Información y pulse **ENTER** mientras “Formato” está seleccionado en la pantalla.

USB Frontal, USB Trasera\*

#### Consejo

- Almacenamiento Local se utiliza como memoria auxiliar cuando se reproduce un Blu-ray Disc.

#### Mensaje Reproducción 3D

Puede activar o desactivar la visualización de un mensaje de advertencia acerca de la reproducción de vídeo en 3D en el televisor al encender este reproductor.

Activar\*, Desactivar

### Idioma

#### OSD

Puede seleccionar el idioma de pantalla, es decir, del menú o los mensajes mostrados en pantalla como, por ejemplo, el menú SETUP.

English, Français, Español, Deutsch, Italiano, Svenska, Nederlandse, Русский, 中文

#### Menú

Puede dar prioridad al idioma del menú del disco.

English, Français, 中文, Español, Deutsch, Italiano, Nederlandse, Portugués, Danés, Svenska, Finlandés, Noruego, Русский, Corea, Japonés, Más

#### Audio

Puede dar prioridad al idioma del audio para la reproducción de Blu-ray Disc/DVD. Para obtener información sobre la configuración de las opciones, consulte “Menú” (pág. 24).

#### Subtítulo

Puede dar prioridad al idioma de los Subtítulo.

English, Français, 中文, Español, Deutsch, Italiano, Nederlandse, Portugués, Danés, Svenska, Finlandés, Noruego, Русский, Corea, Japonés, Más, Desactivar

(Los ajustes predeterminados de [Idioma] varían en función del modelo.)

## Reproducción

### Marca de Angulo

Puede ajustar la visualización de la Marca de Angulo () cuando se reproducen Blu-ray Disc/DVD con varios ángulos.

Activar\*, Desactivar

### Marca PIP

Puede ajustar la visualización de la Marca PIP () cuando se reproducen Blu-ray Disc (pág. 20) con Imagen en imagen.

Activar\*, Desactivar

### Marca Audio Secundario

Puede ajustar la visualización de la Marca Audio Secundario () cuando se reproducen Blu-ray Disc con audio secundario.

Activar\*, Desactivar

### Memoria última

Puede configurar este reproductor para que recuerde la última posición de reproducción de un disco cuando se pone en modo de espera o se abre la bandeja portadiscos.

Activar\*, Desactivar

#### Nota

- Algunos discos no son compatibles con esta función.

## Seguridad

### Cambiar Contraseña

Puede ajustar la contraseña para cambiar el nivel de Control Paterno y el Código de país. Consulte “Control Paterno” (pág. 25) y “Código de país” (pág. 25).

#### Notas

- La contraseña predeterminada es 0000.
- Si olvida la contraseña, consulte “Resolución de problemas” (pág. 31) y restaure todos los ajustes predeterminados de Seguridad.

### Control Paterno

En algunos discos Blu-ray/DVD, existe un nivel de control para la visualización del disco en función de la edad del espectador. Puede ajustar el Control Paterno mostrado en pantalla en función del contenido del disco. Es necesario introducir la contraseña (consulte “Cambiar Contraseña” en pág. 25) antes de ajustar los niveles de Control Paterno.

Después de ajustar el Control Paterno, si reproduce un disco con un nivel más alto del nivel de Control Paterno actual o si desea cambiar el nivel de Control Paterno, aparecerá un cuadro de diálogo solicitando que introduzca la contraseña.

Desactivar,\* 1–8

### Código de país

Puede ajustar el Código de país del estado en el que vive. Es necesario introducir la contraseña (consulte “Cambiar Contraseña” en pág. 25) antes de ajustar el Código de país. Este parámetro puede utilizarse para la calificación de Control Paterno y reproducción de discos.

## Red

### Conexión a Internet

Ajuste esta opción en Permitir cuando utilice BD-Live (pág. 20) o DLNA (pág. 15), actualice el software desde la red (pág. 30) o use otras funciones de red.

Permitir\*, Desactivar

### Información

Puede mostrar la pantalla de información de red. En esta pantalla puede ver información de Interfaz (Ethernet), Tipo de dirección, Dirección IP, Máscara de subred, Default Gateway y DNS.

### Prueba de conexión

Puede realizar una prueba de conexión a Internet. Si la prueba falla, compruebe la “Configuración IP” (pág. 25) y vuelva a realizar la prueba.

### Configuración IP

Puede configurar los ajustes de red.

**Auto\*** Seleccione este valor para configurar automáticamente los ajustes de red de este reproductor con el servidor DHCP.

**Manual** Seleccione este valor para configurar los ajustes de red (Dirección IP, Máscara de subred, Default Gateway y DNS) manualmente.

#### Consejos

- **Teclas numéricas** Permiten introducir caracteres.
- **◀▶** Permiten cambiar la opción resaltada.
- **CLEAR** Permite eliminar un carácter.
- **ENTER** Permite guardar los ajustes y salir del menú.

### Conexión BD-Live

Puede definir la restricción de acceso a los contenidos de BD-Live.

**Autorizada** Permite que todos los discos de BD-Live se conecten a la red.

**Permitida Parcialmente\*** Permite utilizar únicamente los discos con certificación de propietario.

**Prohibido** Prohíbe que todos los discos de BD-Live se conecten a la red.

### DLNA

Puede ajustar la función DLNA (pág. 34) en Permitir/Desactivar. Cuando no utilice la función DLNA, ajústela en Desactivar.

Permitir\*, Desactivar

### Configuración Proxy

Puede definir Configuración Proxy. Ajuste la opción en Desactivar para un uso normal. Seleccione Permitir para definir la configuración del proxy.

**Permitir** Activa los ajustes del host y el puerto proxy.

**Desactivar\*** Desactiva el servidor proxy. Seleccione esta opción cuando no utilice el servidor proxy.

**Host Proxy** Define el host proxy.

**Puerto proxy** Define el puerto proxy.

## ■ Configuración de pantalla

Los ajustes predeterminados están marcados con “\*\*\*\*”.

### TV

#### Salida 3D

Puede seleccionar la salida de vídeo en 3D o 2D desde este reproductor.

**Auto\*** Este reproductor selecciona automáticamente vídeos en 3D o 2D.

**Desactivar** Este reproductor siempre selecciona vídeos en 2D.

#### Nota

- Aunque ajuste “Salida 3D” en “Auto” y reproduzca un disco Blu-ray 3D, este reproductor selecciona imágenes en 2D en función de la conexión y del ajuste del televisor, etc. (pág. 10).

#### Pantalla de TV

Puede ajustar la relación de aspecto de la pantalla del televisor conectado y configurar la salida de vídeo.

Si cambia de televisor, por ejemplo, porque ha adquirido uno nuevo, y la relación de aspecto de la pantalla del televisor conectado cambia, también tendrá que cambiar el ajuste de Pantalla de TV.



**16:9 Lleno** Selecciónelo cuando conecte el reproductor a un televisor con pantalla 16:9. Cuando se reproduce vídeo con una relación de aspecto 4:3, el vídeo se muestra como aparece en la ilustración.

**16:9 Normal\*** Selecciónelo cuando conecte el reproductor a un televisor con pantalla 16:9. Cuando se reproduce vídeo con una relación de aspecto 4:3, el vídeo se muestra como aparece en la ilustración.

**4:3** Selecciónelo cuando conecte el reproductor a un televisor con pantalla 4:3. Cuando se reproduce vídeo con una relación de aspecto 16:9, el vídeo se muestra como aparece en la ilustración.

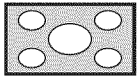
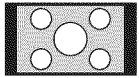
**4:3 Buzón** Selecciónelo cuando conecte el reproductor a un televisor con pantalla 4:3. Cuando se reproduce vídeo con una relación de aspecto 16:9, el vídeo se muestra como aparece en la ilustración.

Tamaño de imagen original	En un televisor 16:9 (pantalla panorámica)	
	16:9 Lleno	16:9 Normal
 <p>4:3</p>		

Tamaño de imagen original	En un televisor 4:3	
	4:3 Panorámico	4:3 Buzón
 <p>16:9</p>		

#### Seleccionar Salida de Vídeo

Puede seleccionar la resolución de salida de vídeo entre Auto, 480i/576i, 480p/576p, 720p, 1080i y 1080p.

Cuando se define en Auto, la resolución se ajusta a la resolución máxima según el televisor conectado.

Para obtener más información sobre los formatos de salida, consulte “Acerca de los formatos de salida de vídeo” (pág. 29).

**Auto\*, 480i/576i, 480p/576p, 720p, 1080i, 1080p**

#### Nota

- Para emitir audio HD (Dolby TrueHD o DTS-HD Master Audio) desde un terminal HDMI, configure Seleccionar Salida de Vídeo en Auto o un ajuste superior a 720p.

#### Sistema de TV

Puede seleccionar el valor de Sistema de TV entre PAL, NTSC y Multi. Ajuste el mismo valor de Sistema de TV que su televisor. Para obtener más información sobre los formatos de salida, consulte “Acerca de los formatos de salida de vídeo” (pág. 29).

**NTSC, PAL, Multi**

(El ajuste predeterminado varía en función del modelo.)

#### Color Space

Puede seleccionar la salida Color Space (pág. 34) desde HDMI. Esta función está disponible cuando el reproductor se conecta con un cable HDMI.

**YCbCr 4:4:4\*** Permite definir Color Space en YCbCr 4:4:4.

**YCbCr 4:2:2** Permite definir Color Space en YCbCr 4:2:2.

**Full RGB** Si ha configurado RGB y el blanco y negro de la pantalla están demasiado difuminados, seleccione esta opción. Esta opción se aplica si un componente conectado admite el intervalo RGB 0–255.

**RGB** Permite la salida de la señal de vídeo con el rango normal de señal.

#### Nota

- Esta función solo está disponible en televisores que admitan dicha función.

#### HDMI Deep Color

Si su televisor y/o receptor de A/V es compatible con Deep Color (pág. 34), ajuste esta opción según su televisor o receptor de A/V. Esta función está disponible cuando el reproductor se conecta con un cable HDMI.

**30 bits, 36 bits, 48 bits, Desactivar\***

## HDMI 1080p 24Hz

Permite la salida de vídeo BD codificado con una velocidad de fotogramas de 24 Hz en HDMI 1080p 24Hz. Con esta función es posible que disfrute de una reproducción de vídeo más fluida. Esta función está disponible si el receptor de A/V o el televisor admiten esta función y el reproductor está conectado con un cable HDMI. Para obtener más información sobre los formatos de salida, consulte “Acerca de los formatos de salida de vídeo” (pág. 29).

**Auto\***, **Desactivar**

### Nota

- Este parámetro se desactiva cuando la resolución de salida es diferente de 1080p.

## Sincronismo de labios

Puede definir o ajustar la función Sincronismo de labios (pág. 35).

<b>Auto*</b>	Este reproductor ajusta la función Sincronismo de labios automáticamente.
<b>Manual</b>	Puede ajustar la función Sincronismo de labios manualmente. Puede definir el retraso del audio para contenido 2D y 3D de forma independiente.
	2D
	3D
<b>Desactivar</b>	Este reproductor no ajusta la función Sincronismo de labios.

## Procesamiento de Video

### Modo de vídeo

Puede seleccionar Modo de vídeo más abajo.

<b>Estándar*</b>	La imagen es más natural y equilibrada. Este modo es adecuado para usos normales.
<b>Rico</b>	La imagen es más viva e intensa.
<b>Cine</b>	La imagen es adecuada para ver películas en una habitación a oscuras.
<b>Particularizado</b>	Puede ajustar la imagen visual manualmente. Pulse ▲/▼ para seleccionar el parámetro y, a continuación, pulse ◀/▶ para ajustar la figura.

#### Brillo

Ajusta el brillo global de la imagen.

#### Saturación

Ajusta la riqueza de color de la imagen proyectada.

#### Tonalidad

Ajusta el tono de la imagen proyectada.

#### Contraste

Ajusta las áreas claras (niveles de blanco) de la imagen.

#### Nitidez

Ajusta la nitidez de los elementos del vídeo.

#### CTI

Suaviza los bordes de las imágenes en color. De este modo, las imágenes en color se distinguen más.

**Los valores predeterminados son 0.**

## Ajuste de color

Ajusta los valores de Brillo/Saturación/Tonalidad para cada color (Rojo/Verde/Azul/Amarillo/Cian/Magenta). Para utilizar esta función, ajuste Modo de vídeo en Particularizado. Para obtener más información sobre la configuración de opciones, consulte “Modo de vídeo” (pág. 27).

**Los valores predeterminados son 0.**

## Reducción de ruido

Puede configurar la Reducción de ruido a un nivel de entre 0 y 3. 0 equivale a desactivado y 3 es el nivel máximo.

**0, 1, 2\*, 3**

## Modo desentrelazado

Puede seleccionar cómo detectar la señal de vídeo. Ajuste la opción en Auto para un uso normal. Cuando aparece en la pantalla un ruido de desgarro horizontal, configure esta opción en Película/Vídeo para eliminar el ruido.

**Auto\***, **Película**, **Vídeo**

## Configuración de audio

Los ajustes predeterminados están marcados con “\*\*\*”.

## Salida de audio

### HDMI

Puede seleccionar el modo de salida del terminal HDMI. Para obtener más información sobre los formatos de salida, consulte “Acerca de los formatos de salida de audio” (pág. 28).

**Bitstream\***, **PCM**, **Recodificar**, **Desactivar**

### Nota

- Para emitir audio HD (Dolby TrueHD o DTS-HD Master Audio) desde un terminal HDMI, configure Seleccionar Salida de Vídeo en Auto o un ajuste superior a 720p (pág. 26).

## DRC

Puede activar, desactivar o poner en modo Auto el DRC (Compresión de gama dinámica) (pág. 34). Al seleccionar Auto, la DRC se activa automáticamente en una fuente con información DRC en formato Dolby TrueHD. DRC hace que los sonidos fuertes como los sonidos oclusivos se escuchen menos y que las conversaciones sean más audíbles. Resulta útil cuando se ven películas de noche.

**Desactivar**, **Activar**, **Auto\***

## Sistema de Información

Se muestran la versión del software y la dirección MAC (pág. 34).

## ■ Acerca de los formatos de salida de audio

Formato de origen		HDMI		
		Bitstream	PCM	Recodificar
PCM 2 canales	con AS* o SCB**	PCM 2 canales		Dolby Digital
	sin AS* o SCB**	PCM 2 canales		
PCM 5.1 canales	con AS* o SCB**	PCM 5.1 canales		Dolby Digital
	sin AS* o SCB**	PCM 5.1 canales		
PCM 7.1 canales	con AS* o SCB**	PCM 7.1 canales		Dolby Digital
	sin AS* o SCB**	PCM 7.1 canales		
Dolby Digital	con AS* o SCB**	Dolby Digital	PCM hasta 5.1 canales	Dolby Digital
	sin AS* o SCB**			
Dolby Digital Plus	con AS* o SCB**	Dolby Digital Plus	PCM hasta 7.1 canales	Dolby Digital
	sin AS* o SCB**			Dolby Digital Plus
Dolby TrueHD	con AS* o SCB**	Dolby TrueHD	PCM hasta 7.1 canales	Dolby Digital
	sin AS* o SCB**			Dolby TrueHD
DTS	con AS* o SCB**	DTS	PCM hasta 5.1 canales	DTS
	sin AS* o SCB**			
DTS HD High Resolution	con AS* o SCB**	DTS HD High Resolution	PCM hasta 5.1 canales (Descodificación de núcleo)	DTS
	sin AS* o SCB**			DTS HD High Resolution
DTS-HD Master Audio	con AS* o SCB**	DTS-HD Master Audio	PCM hasta 5.1 canales (Descodificación de núcleo)	DTS
	sin AS* o SCB**			DTS-HD Master Audio

\* “AS” es audio secundario.

\*\* “SCB” es el sonido clic del botón, el efecto de sonido de los menús emergentes, etc.

### Notas

- Si HDMI se define en Bitstream, no se produce la salida de audio secundario. (pág. 27)
- Para emitir audio HD (Dolby TrueHD o DTS-HD Master Audio) desde un terminal HDMI, configure Seleccionar Salida de Video en Auto o un ajuste superior a 720p (pág. 26).

## ■ Acerca de los formatos de salida de vídeo

### Si Sistema de TV se define en NTSC

	Resolución	Auto	480i/576i	480p/576p	720p	1080i	1080p
HDMI	BD-Video con contenido 1080p/24 Hz	*1, *2	480i	480p	720p 60 Hz	1080i 60 Hz	1080p 24/60 Hz *2
	Otros						1080p 60 Hz

### Si Sistema de TV se define en PAL

	Resolución	Auto	480i/576i	480p/576p	720p	1080i	1080p
HDMI	BD-Video con contenido 1080p/24 Hz	*1, *2	576i	576p	720p 50 Hz	1080i 50 Hz	1080p 24/50 Hz *2
	Otros						1080p 50 Hz

\*1 La resolución se ajusta en la resolución máxima admitida por el televisor conectado. Por ejemplo, si la resolución máxima admitida por el televisor conectado es de 1080p, se ajustará la resolución 1080p.

\*2 Si la fuente es un contenido de 1080p 24 Hz y el televisor conectado admite la salida de contenidos 1080p 24 Hz, se utilizará 1080p 24 Hz en lugar de 1080p 50/60 Hz cuando la resolución esté ajustada en Auto o 1080p y la opción Auto esté seleccionada para HDMI 1080p 24Hz (pág. 27) en Configuración de pantalla.

### Si Sistema de TV se define en Multi

Si Sistema de TV está configurado como Multi, la salida de la señal de vídeo tiene la misma frecuencia que la fuente. Consulte las tablas anteriores para obtener información sobre la configuración de frecuencia del televisor y la resolución de la señal de vídeo de salida.

#### Notas

- El parámetro HDMI 1080p 24Hz se desactiva cuando la resolución de salida es diferente de 1080p.
- Cuando Sistema de TV se define en NTSC y la fuente de vídeo no es 60 Hz, la señal de salida de vídeo se convierte a 60 Hz.
- Cuando Sistema de TV se define en PAL y la fuente de vídeo no es 50 Hz, la señal de salida de vídeo se convierte a 50 Hz.

# Actualización de software

Algunos de los discos Blu-ray que acaban de salir al mercado no se pueden reproducir a menos que actualice el software del reproductor e instale la versión más reciente. Le recomendamos la actualización para que el reproductor funcione con el software más actual.

Para comprobar la disponibilidad de una actualización de software, visite <http://download.yamaha.com/>

## Nota

- No extraiga el dispositivo de memoria USB, no ponga el reproductor en modo de espera ni desenchufe el cable de alimentación o el cable LAN mientras se lleva a cabo la actualización de software.

## ■ Actualización del software

### 1. Prepárese para la actualización de software.

Si actualiza el software desde Almacenamiento USB:

- ① Guarde el paquete de archivos de actualización en la carpeta correspondiente en el dispositivo de memoria USB. Para obtener más información, consulte el documento de procedimientos adjunto con el paquete de archivos de actualización.
- ② Conecte el dispositivo de memoria USB.  
Omita el paso 2.

Si actualiza el software desde Red:

Compruebe que el reproductor está conectado a la red.

### 2. Seleccione el método de actualización e inicie la actualización desde el menú **SETUP**.

- ① Pulse **SETUP** para mostrar la pantalla del menú SETUP.
- ② Seleccione Configuración General → Sistema → Actualizar.
- ③ Seleccione el elemento que contiene el paquete de archivos de actualización desde Almacenamiento USB/Red.



El sistema buscará el paquete de archivos de actualización.

### 3. Actualice el software siguiendo las indicaciones de los mensajes que aparecen en pantalla.

La actualización se ha completado. El sistema se reiniciará.







# Resolución de problemas

Consulte la tabla que aparece a continuación cuando el reproductor no funcione correctamente. Si el problema que tiene no aparece en la lista siguiente o las instrucciones no le sirven de ayuda, apague este reproductor, desenchufe el cable de alimentación y póngase en contacto con el centro de servicio o concesionario Yamaha autorizado más cercano.

## ■ Alimentación

Problema	Posibles causas y soluciones
No hay alimentación.	<ul style="list-style-type: none"> <li>– Conecte correctamente el cable de alimentación de CA.</li> <li>– Pulse  en el panel delantero para encender la alimentación.</li> </ul>
La alimentación del reproductor está apagada.	<ul style="list-style-type: none"> <li>– La alimentación se desconectará automáticamente pasados 30 minutos seguidos de inactividad (sin reproducción).</li> </ul>





## ■ Funcionamiento básico

Problema	Posibles causas y soluciones
El mando a distancia no funciona.	<ul style="list-style-type: none"> <li>– Utilice el mando a distancia dentro de su alcance operativo. (pág. 9)</li> <li>– Cambie las pilas. (pág. 9)</li> </ul>
Los botones no funcionan.	<ul style="list-style-type: none"> <li>– Mantenga pulsado  en el panel delantero durante más de 5 segundos y deje de pulsarlo para reiniciar el reproductor.</li> <li>– Para reiniciar completamente el reproductor, desenchufe el cable de alimentación de la toma de CA durante 10 segundos o más, vuelva a enchufarlo y, a continuación, encienda el reproductor.</li> </ul>
He olvidado la contraseña.	<ul style="list-style-type: none"> <li>– Mantenga pulsado  y  en el panel delantero simultáneamente sin ningún disco insertado y con la reproducción parada para restaurar los valores predeterminados de todos los ajustes, incluidos los ajustes de Seguridad (pág. 25). Una vez que la alimentación se desconecte automáticamente, pulse  para volver a activarla.</li> </ul>

## ■ Reproducción de disco

Problema	Posibles causas y soluciones
El reproductor no puede reproducir un disco.	<ul style="list-style-type: none"> <li>– Extraiga el disco y límpielo. (pág. 4)</li> <li>– Asegúrese de que se ha cargado correctamente el disco (alineado en la bandeja portadiscos y con la cara de la etiqueta hacia arriba). (pág. 4)</li> <li>– Utilice un disco admitido por el reproductor. (pág. 3)</li> <li>– Extraiga el disco y compruebe si es un disco admitido por el reproductor o no. (pág. 3)</li> <li>– Compruebe el código de región. (pág. 3)</li> <li>– Compruebe si el disco es defectuoso probando con otro disco.</li> <li>– Los discos CD-R/RW, DVD+R/RW/R DL y DVD-R/RW/R DL deben estar finalizados. (pág. 3)</li> </ul>
El vídeo se para.	<ul style="list-style-type: none"> <li>– El reproductor se parará si detecta golpes o vibraciones.</li> </ul>
El reproductor hace un sonido de chasquido cuando comienza la reproducción o al cargar un disco.	<ul style="list-style-type: none"> <li>– Estos sonidos no son síntoma de avería sino parte del funcionamiento normal del reproductor.</li> </ul>

## ■ Imagen

Problema	Posibles causas y soluciones
<b>No hay imagen.</b>	<ul style="list-style-type: none"> <li>– Asegúrese de que el cable HDMI esté conectado correctamente. (pág. 10)</li> <li>– Asegúrese de que el televisor o receptor de A/V conectado está ajustado a la entrada correcta. (pág. 10)</li> <li>– Sin ningún disco cargado o con la reproducción parada, mantenga pulsados los botones  y  del panel delantero simultáneamente para restaurar el valor predeterminado de la resolución del vídeo.</li> </ul> <p>Si sigue sin aparecer la imagen, mantenga pulsado el botón  del panel delantero durante unos 5 segundos para activar NTSC/PAL.</p>
<b>La pantalla se congela y los botones de control no funcionan.</b>	<ul style="list-style-type: none"> <li>– Pulse  y, después, reinicie la reproducción.</li> <li>– Desconecte la alimentación y conéctela de nuevo.</li> <li>– Mantenga pulsado  en el panel delantero durante más de 5 segundos y deje de pulsarlo para reiniciar el reproductor.</li> </ul>
<b>La salida de vídeo no tiene la resolución deseada.</b>	<ul style="list-style-type: none"> <li>– Ajuste la resolución deseada. (pág. 26)</li> </ul>
<b>El vídeo de pantalla ancha aparece estirado verticalmente o aparecen bandas negras en las partes superior e inferior de la pantalla. O el vídeo 4:3 aparece estirado horizontalmente.</b>	<ul style="list-style-type: none"> <li>– Cambie la relación de aspecto del televisor. (pág. 26)</li> </ul>
<b>Aparece ruido cuadrado (mosaicos) en la pantalla.</b>	<ul style="list-style-type: none"> <li>– Es posible que aparezcan bloques en las imágenes en escenas con movimientos rápidos debido a las características de la tecnología de compresión de imagen digital.</li> </ul>
<b>No se escucha el audio o las imágenes no se reproducen adecuadamente.</b>	<ul style="list-style-type: none"> <li>– En algunos discos en los que se ha grabado contenido protegido por derechos de autor, es posible que no se escuche el audio o que las imágenes no se reproduzcan adecuadamente.</li> </ul>

## ■ Sonido

Problema	Posibles causas y soluciones
<b>No se escucha el sonido o está distorsionado.</b>	<ul style="list-style-type: none"> <li>– Compruebe que el cable HDMI esté conectado correctamente. (pág. 10)</li> <li>– Suba el volumen del televisor o del receptor de A/V.</li> <li>– No se escucha sonido durante el modo de reproducción fija, avance rápido y retroceso rápido. (pág. 8)</li> <li>– Es posible que el audio no se escuche dependiendo del estado de grabación del audio, por ejemplo, si el contenido de audio grabado no es de señal de audio o es audio no estándar. (pág. 3)</li> </ul>
<b>Los canales de audio izquierdo y derecho están invertidos o el sonido solo sale por uno de ellos.</b>	<ul style="list-style-type: none"> <li>– Compruebe la conexión HDMI. (pág. 10)</li> </ul>
<b>No se escucha el audio o las imágenes no se reproducen adecuadamente.</b>	<ul style="list-style-type: none"> <li>– En algunos discos en los que se ha grabado contenido protegido por derechos de autor, es posible que no se escuche el audio o que las imágenes no se reproduzcan adecuadamente.</li> </ul>
<b>No se escucha el sonido de PIP (audio secundario).</b>	<ul style="list-style-type: none"> <li>– Ajuste HDMI en PCM/Recodificar. (pág. 27)</li> <li>– Para escuchar el audio secundario, pulse <b>2ND AUDIO</b>. (pág. 6)</li> <li>– Dependiendo del disco, es posible que tenga que activar el audio secundario en el menú principal del disco (pág. 8).</li> </ul>

## ■ Red

Problema	Posibles causas y soluciones
<b>No se puede conectar a Internet.</b>	<ul style="list-style-type: none"> <li>– Conecte correctamente el cable de red.</li> <li>– Encienda el equipo conectado como, por ejemplo, un módem o enrutador de banda ancha.</li> <li>– Conecte correctamente el módem y/o el enrutador de banda ancha.</li> <li>– Configure correctamente el valor o valores de la red. Consulte “Red”. (pág. 25)</li> </ul>
<b>No se pueden descargar contenidos BD-Live.</b>	<ul style="list-style-type: none"> <li>– Conecte correctamente el cable de red. (pág. 11)</li> <li>– Conecte el dispositivo de memoria USB correctamente. Compruebe que el dispositivo de memoria USB esté conectado al conector USB del reproductor. (pág. 11)</li> <li>– Compruebe si el Blu-ray Disc admite BD-Live.</li> <li>– Compruebe el ajuste de “Conexión a Internet”. (pág. 25)</li> <li>– Conecte el dispositivo de memoria USB con formato FAT16, FAT32 o NTFS.</li> <li>– Se recomienda conectar el dispositivo de memoria USB con al menos 2 GB de espacio libre. Si no hay suficiente espacio libre, formatee el dispositivo de memoria USB. (pág. 24)</li> <li>– Consulte el manual del usuario suministrado con el disco o póngase en contacto con el fabricante del disco.</li> </ul>
<b>No se puede detectar el servidor DLNA.</b>	<ul style="list-style-type: none"> <li>– Conecte correctamente el cable de red.</li> <li>– Encienda el equipo conectado como, por ejemplo un enrutador de banda ancha o el servidor.</li> <li>– Asegúrese de que el reproductor y el servidor están conectados al mismo punto de acceso.</li> <li>– Configure correctamente el valor o valores de la red. Consulte “Red”. (pág. 25)</li> <li>– Dependiendo del servidor DLNA, es posible que sea necesario autorizar al reproductor desde el servidor.</li> <li>– En función del servidor DLNA, es necesario modificar el ajuste del cortafuego.</li> </ul>
<b>No se puede reproducir el archivo del servidor de red doméstico.</b>	<ul style="list-style-type: none"> <li>– Asegúrese de que el archivo se puede reproducir. (pág. 3)</li> <li>– Compruebe la configuración del servidor DLNA.</li> <li>– La calidad de funcionamiento y reproducción podría verse afectada por las condiciones de la red doméstica.</li> </ul>

5

Información adicional

## ■ Mensajes en pantalla

- Los mensajes siguientes aparecerán en la pantalla del televisor si el disco que intenta reproducir no es apropiado o la operación no es correcta.

Mensaje de error	Posibles causas y soluciones
<b>Fichero no compatible</b>	– El reproductor no admite el archivo. Consulte “Tipos de discos/archivos que pueden utilizarse con este reproductor” (pág. 3).
<b>¡Código de región erróneo!</b>	– El disco tiene un código de región incompatible. Consulte “Información sobre la gestión de la región en los vídeos Blu-ray Disc/DVD” (pág. 3).
<b>La red ha fallado.</b>	– El reproductor no se puede conectar a la red. Compruebe la conexión (pág. 11) y la configuración de la red (pág. 25).
<b>Red está bien, proxy ha fallado.</b>	– El reproductor no se puede conectar al servidor proxy. Consulte “Configuración Proxy” (pág. 25).
<b>La conexión BD-Live está prohibida en el menú de SETUP</b>	– La conexión de BD-Live está prohibida. Consulte “Conexión BD-Live” (pág. 25).
<b>¡La actualización ha fallado por alguna razón!</b>	– La actualización ha fallado. Compruebe si el archivo de actualización está dañado o es ilegible.

# Glosario

## **AVCHD**

AVCHD es un nuevo formato (estándar) para cámaras de vídeo de alta definición que se puede utilizar para grabar y reproducir imágenes de alta resolución HD.

## **BD-Live™**

BD-Live es un estándar de Blu-ray Disc que utiliza una conexión de red y permite al reproductor conectarse a Internet para descargar vídeos promocionales y otros datos.

## **BDMV**

BDMV (película en disco Blu-ray) es uno de los formatos de aplicación utilizados en BD-ROM, que es una de las especificaciones de Blu-ray Disc. BDMV es un formato de grabación equivalente a DVD-Video en la especificación DVD.

## **Blu-ray 3D™**

Blu-ray 3D le permite ver imágenes 3D de alta definición completa.

## **BONUSVIEW™**

Los discos compatibles con BONUSVIEW le permiten disfrutar simultáneamente de subcanal de vídeo para dos pantallas, subcanal de audio y subtítulos. Aparece una pequeña pantalla dentro de la pantalla principal durante la reproducción (Imagen en imagen).

## **Buzón (LB 4:3)**

Un tamaño de pantalla con barras negras en las partes superior e inferior de la imagen para permitir la visualización de material en pantalla ancha (16:9) en un televisor 4:3 conectado.

## **Color Space**

Color Space es una gama de colores que se puede representar. RGB es un espacio de color basado en el modelo de color RGB (rojo, verde y azul) y se utiliza normalmente en monitores de PC. YCbCr es un espacio de color basado en una señal de luminancia (Y) y dos señales de diferencia de color (Cb y Cr).

## **Deep Color**

Deep Color hace referencia al uso de varias profundidades de color en pantallas, a partir de profundidades de 24 bits en versiones anteriores de la especificación HDMI. Esta profundidad de bits adicional permite que las pantallas HDTV y otros tipos de pantallas pasen de millones a miles de millones de colores y eliminen la aparición de bandas de color en pantalla para disfrutar de unas transiciones tonales fluidas y una gradación sutil entre colores. La mayor relación de contraste permite representar muchos más tonos de gris entre blanco y negro. Además, Deep Color aumenta el número de colores disponibles dentro de los límites definidos por el espacio de color RGB o YCbCr.

## **Dirección Mac**

La dirección Mac es un valor único asignado a un dispositivo de red para su identificación.

## **DLNA**

DLNA (Digital Living Network Alliance) permite compartir de forma sencilla contenidos digitales a través de una red doméstica, para que pueda disfrutar de contenidos digitales almacenados en un PC con el software del servidor DLNA instalado u otro dispositivo compatible con DLNA con su televisor a través de este reproductor. Para conectar este reproductor a sus servidores DLNA se requieren algunos ajustes del dispositivo o del servidor DLNA. Para más detalles, consulte el software del servidor DLNA o el dispositivo DLNA.

## **Dolby Digital**

Un sistema de sonido desarrollado por Dolby Laboratories Inc. que da un ambiente de sala de cine a la salida de audio cuando el producto está conectado a un amplificador o procesador Dolby Digital.

## **Dolby Digital Plus**

Un sistema de sonido desarrollado como una extensión de Dolby Digital. Esta tecnología de codificación de audio es compatible con sonido envolvente de 7.1 canales.

## **Dolby TrueHD**

Dolby TrueHD es una tecnología de codificación sin pérdidas que admite hasta 8 canales de sonido envolvente multicanal para los discos ópticos de la próxima generación. El sonido reproducido refleja fielmente, bit a bit, la fuente original.

## **DRC (Control de gama dinámica)**

DRC le permite ajustar la gama entre los sonidos más alto y más bajo (gama dinámica) para reproducir los contenidos a un volumen intermedio. Utilícela cuando sea difícil escuchar los diálogos o durante las horas en que la reproducción pueda molestar a los vecinos.

## **DTS**

Un sistema de sonido digital desarrollado por DTS, Inc. para su uso en salas de cine.

## **DTS-HD High Resolution Audio**

DTS-HD High Resolution Audio es una nueva tecnología desarrollada para el formato de disco óptico de alta definición de la próxima generación.

## **DTS-HD Master Audio**

DTS-HD Master Audio es una tecnología de compresión de audio sin pérdidas desarrollada para el formato de disco óptico de alta definición de la próxima generación.

## **FLAC**

FLAC (Free Lossless Audio Codec, Códec libre de compresión de audio sin pérdida) es un formato de audio para la compresión de datos de audio sin pérdida. Aunque el grado de compresión es inferior al de otros formatos de audio comprimido con pérdida, normalmente el audio es de mayor calidad.

**HDMI**

HDMI (High-Definition Multimedia Interface, Interfaz Multimedia de Alta Definición) es una interfaz que admite vídeo y audio en una sola conexión digital. La conexión HDMI lleva señales de vídeo (estándar y de alta definición) y señales de audio multicanal a componentes A/V como, por ejemplo, televisores equipados con HDMI en forma digital y sin degradación.

**Panorámico (PS 4:3)**

Un tamaño de pantalla que recorta los lados de la imagen para permitir la visualización de material de pantalla ancha (16:9) en un televisor 4:3 conectado.

**Sincronismo de labios**

Sincronismo de labios, una abreviatura de “lip synchronization”, o sincronización de labios, es un término que hace referencia tanto a un problema habitual como a la posibilidad de mantener sincronizadas las señales de audio y vídeo durante la posproducción y la transmisión. La latencia de audio y vídeo requiere complejos ajustes por parte del usuario, pero la versión HDMI incorpora una función de sincronización automática de audio y vídeo que permite a los dispositivos sincronizarse de forma automática y precisa y sin la intervención del usuario.

**Sonido PCM lineal**

PCM lineal es un formato de grabación de señales utilizado para CD de audio y en algunos discos DVD y Blu-ray. El sonido de los CD de audio se graba a 44,1 kHz con 16 bits. (El sonido se graba entre 48 kHz con 16 bits y 96 kHz con 24 bits en discos DVD y entre 48 kHz con 16 bits y 192 kHz con 24 bits en discos Blu-ray.)

**Subtítulos**

Son las líneas de texto que aparecen en la parte inferior de la pantalla y que traducen o transcriben el diálogo. Están grabadas en muchos discos DVD y Blu-ray.

**x.v.Color**

x.v.Color reproduce una gama de colores más amplia que antes, mostrando casi todos los colores que puede detectar el ojo humano.

## Especificaciones

### ■ Información general

Alimentación	
[Modelos de EE. UU. y Canadá].....	110–240 V CA, 60 Hz
[Modelo para América Central y del Sur].....	110–240 V CA, 50/60 Hz
[Modelo para Australia].....	110–240 V CA, 50 Hz
[Modelo para Reino Unido, Europa y Rusia].....	110–240 V CA, 50 Hz
[Modelo para China].....	110–240 V CA, 50 Hz
[Modelo para Asia].....	110–240 V CA, 50/60 Hz
[Modelo para Corea].....	110–240 V CA, 60 Hz
Consumo de energía (normal).....	18 W
Consumo (en espera).....	0,5 W o menos
Dimensiones (An. × Al. × Pr.).....	435 × 50 × 202 mm
Peso.....	2,0 kg

### ■ Entrada/salida

Salida HDMI .....	Conector tipo A × 1 480i/576i/480p/576p/720p/1080i/1080p@24Hz, Compatibilidad con Deep Color, x.v. Color
USB .....	Conector tipo A × 2
Otros equipos.....	Ethernet × 1

Las especificaciones están sujetas a cambio sin previo aviso.

## ■ Propiedad intelectual

- El material audio-visual puede consistir de productos con propiedad intelectual que no se deben grabar sin la autorización del poseedor de dicha propiedad intelectual. Remítase a las leyes aplicables en su país.
  - Fabricado con la licencia de Dolby Laboratories. Dolby y el símbolo de la doble D son marcas comerciales de Dolby Laboratories.
  - Fabricado con licencia en aplicación de las patentes de EE. UU.: 5,956,674; 5,974,380; 6,487,535 y otras patentes de los EE. UU. e internacionales registradas o pendientes. DTS, el símbolo y DTS y el símbolo juntos son marcas comerciales registradas, y DTS Digital Surround y los logotipos DTS son marcas comerciales de DTS, Inc. El producto incluye software. © DTS, Inc. Todos los derechos reservados.
  - “Blu-ray Disc™”, “Blu-ray™”, “Blu-ray 3D™”, “BD-Live™”, “BONUSVIEW™” y los logotipos son marcas comerciales de la Blu-ray Disc Association.
  - **DVD** es una marca comercial de DVD Format/Logo Licensing Corporation.
  - “HDMI”, el logotipo “HDMI” y “High-Definition Multimedia Interface” son marcas comerciales o marcas comerciales registradas de HDMI Licensing LLC.
  - “x.v.Color” y el logotipo “x.v.Color” son marcas comerciales de Sony Corporation.
  - “AVCHD” y el logotipo “AVCHD” son marcas comerciales de Panasonic Corporation y Sony Corporation.
  - Java y todas las marcas comerciales y logotipos basados en Java son marcas comerciales o marcas comerciales registradas de Sun Microsystems, Inc. en los Estados Unidos y/o otros países.
  - Este producto se otorga con licencia en aplicación de la licencia de cartera de patentes AVC y la licencia de cartera de patentes VC-1 para su uso personal y no comercial por parte de un consumidor para (i) codificar vídeo que cumpla con las normas AVC y VC-1 (“vídeo AVC/VC-1”) y/o (ii) decodificar vídeo AVC/VC-1 codificado por un consumidor dedicado a una actividad personal y no comercial y/o suministrado por un proveedor de vídeo con licencia para proporcionar vídeo AVC/VC-1. No se otorga ni se da por supuesta licencia alguna para cualquier otro uso. Se puede obtener información adicional de MPEG LA, LLC.  
Consulte <http://www.mpegla.com>.
  - Windows Media Player es una marca comercial o una marca comercial registrada de Microsoft Corporation en Estados Unidos y/o en otros países.
  - YouTube y el logotipo YouTube son marcas comerciales de Google, Inc.
  - DLNA y DLNA CERTIFIED son marcas comerciales y/o marcas de servicio de Digital Living Network Alliance.
- Copyright 2004-2010 Verance Corporation. Cinavia™ es una marca comercial de Verance Corporation. Protegida por la patente estadounidense 7.369.677 y patentes internacionales registradas y pendientes de aprobación en virtud de la licencia de Verance Corporation. Todos los derechos reservados.

# Índice

## ■ Numerics

2ND AUDIO, mando a distancia .....6

## ■ A

A/B, mando a distancia .....7

Actualización de software .....30

Actualizar, menú SETUP .....24

Ajuste de color, menú SETUP .....27

Almacenamiento Local, menú  
SETUP .....24

ANGLE, mando a distancia .....7

Ángulo, menú en pantalla .....17

Asistente inicial .....12

Audio Secundario, menú en pantalla ...17

Audio, formatos de salida .....28

AUDIO, mando a distancia .....7

Audio, menú en pantalla .....17

Audio, menú SETUP .....24

## ■ B

BD-Live .....20

Bitrate, menú en pantalla .....17

Botones de colores, mando a distancia ...7

Botones de control, mando a distancia ...8

Botones de cursor, mando a distancia ...8

Botones numéricos, mando a distancia ...6

Búsqueda Ins, menú en pantalla .....17

## ■ C

Cambiar Contraseña, menú SETUP .....25

Capítulo, menú en pantalla .....17

Cargar configuración por defecto,  
menú SETUP .....24

CLEAR, mando a distancia .....7

Código de país, menú SETUP .....25

Color Space, menú SETUP .....26

Conexión a Internet, menú SETUP .....25

Conexión BD-Live, menú SETUP .....25

Configuración de audio, menú  
SETUP .....27

Configuración de pantalla, menú  
SETUP .....26

Configuración General, menú  
SETUP .....24

Configuración IP, menú SETUP .....25

Configuración Proxy, menú SETUP .....25

Configuración Sencilla .....12

Configuración Sencilla, menú SETUP  
.....24

Contenido USB, reproducción .....13

Contenidos de YouTube, reproducción  
.....16

Control HDMI, menú SETUP .....24

Control Paterno, menú SETUP .....25

## ■ D

DIGEST, mando a distancia .....7

Disco de datos, reproducción .....13

DLNA, menú SETUP .....25

DRC, menú SETUP .....27

## ■ E

ENTER, mando a distancia .....7, 8

Estado, menú .....18

Estilo subtítulos, menú en pantalla .....17

## ■ F

Función Control HDMI .....24

Función de búsqueda .....19

Funcionamiento del menú SETUP .....23

## ■ H

HDMI 1080p 24Hz, menú SETUP .....27

HDMI Deep Color, menú SETUP .....26

HDMI, conexión .....10

HDMI, menú SETUP .....27

HOME, mando a distancia .....7

HOME, menú .....13

Hora, menú en pantalla .....17

## ■ I

Idioma, menú SETUP .....24

Información, menú SETUP .....25

## ■ M

Mando a distancia .....6

Marca Audio Secundario, menú  
SETUP .....25

Marca de Angulo, menú SETUP .....25

Marca PIP, menú SETUP .....25

Marcador .....19

MARKER, mando a distancia .....6

MEDIA, menú .....13

Memoria última, menú SETUP .....25

Mensaje Reproducción 3D, menú  
SETUP .....24

Menú, menú SETUP .....24

Modo de vídeo, menú SETUP .....27

Modo desentrelazado, menú SETUP ...27

Modo/Modo de reproducción, menú  
en pantalla .....17

## ■ O

ON SCREEN, mando a distancia .....8

OSD, menú SETUP .....24

## ■ P

Pantalla de TV, menú SETUP .....26

Pantalla, menú .....17

Pase de diapositivas, menú en pantalla  
.....17

Piezas incluidas .....2

PIP, mando a distancia .....6

Pista/Archivo, menú en pantalla .....17

POP UP/MENU, mando a distancia .....8

Precauciones con los discos .....4

Procesamiento de Video, menú SETUP  
.....27

PROGRAM, mando a distancia .....6

Programación de la reproducción .....19

Protector de pantalla, menú SETUP .....24

Prueba de conexión, menú SETUP .....25

## ■ R

Red, conexión .....11

Red, menú SETUP .....25

Reducción de ruido, menú SETUP .....27

REPEAT, mando a distancia .....6

Repetición Ins, menú en pantalla .....17

Reproducción Automática Disco,  
menú SETUP .....24

Reproducción, menú SETUP .....25

Requisitos de los archivos de audio .....3

Resolución de problemas .....31

RETURN, mando a distancia .....8

## ■ S

Salida 3D, menú SETUP .....26

Salida de audio, menú SETUP .....27

SEARCH, mando a distancia .....7

Seguridad, menú SETUP .....25

Seleccionar Salida de Video, menú  
SETUP .....26

SETUP, mando a distancia .....7

SETUP, menú .....21

SHUFFLE, mando a distancia .....6

Sincronismo de labios, menú SETUP  
.....27

Sistema de Información, menú  
SETUP .....27

Sistema de TV, menú SETUP .....26

Sistema, menú SETUP .....24

Software, actualización .....30

STATUS, mando a distancia .....7

SUBTITLE, mando a distancia .....7

Subtítulo, menú en pantalla .....17

Subtítulo, menú SETUP .....24

## ■ T

Título, menú en pantalla .....17

TOP MENU, mando a distancia .....8

Transición, menú en pantalla .....17

TV, menú SETUP .....26

## ■ U

USB, conexión .....11

Utilización de la función Imagen  
en Imagen .....20

## ■ V

Vídeo secundario, menú en pantalla ....17

Vídeo, formatos de salida .....29

## ■ Z

ZOOM, mando a distancia .....7

# Information about software

This product uses the following software.  
For information (copyright, etc) about each software, read the original sentences stated below.

## ■ About Linux, Busybox, SquashFS, LIRC, U-boot, gdb, mtd-utils

### GNU GENERAL PUBLIC LICENSE Version 2, June 1991

Copyright (C) 1989, 1991 Free Software Foundation, Inc.  
51 Franklin St, Fifth Floor, Boston, MA 02110-1301 USA

Everyone is permitted to copy and distribute verbatim copies of this license document, but changing it is not allowed.

#### Preamble

The licenses for most software are designed to take away your freedom to share and change it. By contrast, the GNU General Public License is intended to guarantee your freedom to share and change free software—to make sure the software is free for all its users. This General Public License applies to most of the Free Software Foundation's software and to any other program whose authors commit to using it. (Some other Free Software Foundation software is covered by the GNU Library General Public License instead.) You can apply it to your programs, too.

When we speak of free software, we are referring to freedom, not price. Our General Public Licenses are designed to make sure that you have the freedom to distribute copies of free software (and charge for this service if you wish), that you receive source code or can get it if you want it, that you can change the software or use pieces of it in new free programs; and that you know you can do these things.

To protect your rights, we need to make restrictions that forbid anyone to deny you these rights or to ask you to surrender the rights. These restrictions translate to certain responsibilities for you if you distribute copies of the software, or if you modify it.

For example, if you distribute copies of such a program, whether gratis or for a fee, you must give the recipients all the rights that you have. You must make sure that they, too, receive or can get the source code. And you must show them these terms so they know their rights.

We protect your rights with two steps: (1) copyright the software, and (2) offer you this license which gives you legal permission to copy, distribute and/or modify the software. Also, for each author's protection and ours, we want to make certain that everyone understands that there is no warranty for this free software. If the software is modified by someone else and passed on, we want its recipients to know that what they have is not the original, so that any problems introduced by others will not reflect on the original authors' reputations.

Finally, any free program is threatened constantly by software patents. We wish to avoid the danger that redistributors of a free program will individually obtain patent licenses, in effect making the program proprietary. To prevent this, we have made it clear that any patent must be licensed for everyone's free use or not licensed at all. The precise terms and conditions for copying, distribution and modification follow.

### GNU GENERAL PUBLIC LICENSE TERMS AND CONDITIONS FOR COPYING, DISTRIBUTION AND MODIFICATION

0. This License applies to any program or other work which contains a notice placed by the copyright holder saying it may be distributed under the terms of this General Public License. The "Program", below, refers to any such program or work, and a "work based on the Program" means either the Program or any derivative work under copyright law; that is to say, a work containing the Program or a portion of it, either verbatim or with modifications and/or translated into another language. (Hereinafter, translation is included without limitation in the term "modification".) Each licensee is addressed as "you".

Activities other than copying, distribution and modification are not covered by this License; they are outside its scope. The act of running the Program is not restricted, and the output from the Program is covered only if its contents constitute a work based on the Program (independent of having been made by running the Program). Whether that is true depends on what the Program does.

1. You may copy and distribute verbatim copies of the Program's source code as you receive it, in any medium, provided that you conspicuously and appropriately publish on each copy an appropriate copyright notice and disclaimer of warranty; keep intact all the notices that refer to this License and to the absence of any warranty; and give any other recipients of the Program a copy of this License along with the Program.

You may charge a fee for the physical act of transferring a copy, and you may at your option offer warranty protection in exchange for a fee.

2. You may modify your copy or copies of the Program or any portion of it, thus forming a work based on the Program, and copy and distribute such modifications or work under the terms of Section 1 above, provided that you also meet all of these conditions:

- You must cause the modified files to carry prominent notices stating that you changed the files and the date of any change.
- You must cause any work that you distribute or publish, that in whole or in part contains or is derived from the Program or any part thereof, to be licensed as a whole at no charge to all third parties under the terms of this License.

- If the modified program normally reads commands interactively when run, you must cause it, when started running for such interactive use in the most ordinary way, to print or display an announcement including an appropriate copyright notice and a notice that there is no warranty (or else, saying that you provide a warranty) and that users may redistribute the program under these conditions, and telling the user how to view a copy of this License. (Exception: if the Program itself is interactive but does not normally print such an announcement, your work based on the Program is not required to print an announcement.)

These requirements apply to the modified work as a whole. If identifiable sections of that work are not derived from the Program, and can be reasonably considered independent and separate works in themselves, then this License, and its terms, do not apply to those sections when you distribute them as separate works. But when you distribute the same sections as part of a whole which is a work based on the Program, the distribution of the whole must be on the terms of this License, whose permissions for other licensees extend to the entire whole, and thus to each and every part regardless of who wrote it.

Thus, it is not the intent of this section to claim rights or contest your rights to work written entirely by you; rather, the intent is to exercise the right to control the distribution of derivative or collective works based on the Program.

In addition, mere aggregation of another work not based on the Program with the Program (or with a work based on the Program) on a volume of a storage or distribution medium does not bring the other work under the scope of this License.

3. You may copy and distribute the Program (or a work based on it, under Section 2) in object code or executable form under the terms of Sections 1 and 2 above provided that you also do one of the following:

- Accompany it with the complete corresponding machine-readable source code, which must be distributed under the terms of Sections 1 and 2 above on a medium customarily used for software interchange; or,
- Accompany it with a written offer, valid for at least three years, to give any third party, for a charge no more than your cost of physically performing source distribution, a complete machine-readable copy of the corresponding source code, to be distributed under the terms of Sections 1 and 2 above on a medium customarily used for software interchange; or,
- Accompany it with the information you received as to the offer to distribute corresponding source code. (This alternative is allowed only for noncommercial distribution and only if you received the program in object code or executable form with such an offer, in accord with Subsection b above.)

The source code for a work means the preferred form of the work for making modifications to it. For an executable work, complete source code means all the source code for all modules it contains, plus any associated interface definition files, plus the scripts used to control compilation and installation of the executable. However, as a special exception, the source code distributed need not include anything that is normally distributed (in either source or binary form) with the major components (compiler, kernel, and so on) of the operating system on which the executable runs, unless that component itself accompanies the executable.

If distribution of executable or object code is made by offering access to copy from a designated place, then offering equivalent access to copy the source code from the same place counts as distribution of the source code, even though third parties are not compelled to copy the source along with the object code.

4. You may not copy, modify, sublicense, or distribute the Program except as expressly provided under this License. Any attempt otherwise to copy, modify, sublicense or distribute the Program is void, and will automatically terminate your rights under this License. However, parties who have received copies, or rights, from you under this License will not have their licenses terminated so long as such parties remain in full compliance.

5. You are not required to accept this License, since you have not signed it. However, nothing else grants you permission to modify or distribute the Program or its derivative works. These actions are prohibited by law if you do not accept this License. Therefore, by modifying or distributing the Program (or any work based on the Program), you indicate your acceptance of this License to do so, and all its terms and conditions for copying, distributing or modifying the Program or works based on it.

6. Each time you redistribute the Program (or any work based on the Program), the recipient automatically receives a license from the original licensor to copy, distribute or modify the Program subject to these terms and conditions. You may not impose any further restrictions on the recipients' exercise of the rights granted herein. You are not responsible for enforcing compliance by third parties to this License.

7. If, as a consequence of a court judgment or allegation of patent infringement or for any other reason (not limited to patent issues), conditions are imposed on you (whether by court order, agreement or otherwise) that contradict the conditions of this License, they do not excuse you from the conditions of this License. If you cannot distribute so as to satisfy simultaneously your obligations under this License and any other pertinent obligations, then as a consequence you may not distribute the Program at all. For example, if a patent license would not permit royalty-free redistribution of the Program by all those who receive copies directly or indirectly through you, then the only way you could satisfy both it and this License would be to refrain entirely from distribution of the Program.

If any portion of this section is held invalid or unenforceable under any particular circumstance, the balance of the section is intended to apply and the section as a whole is intended to apply in other circumstances.



It is not the purpose of this section to induce you to infringe any patents or other property right claims or to contest validity of any such claims; this section has the sole purpose of protecting the integrity of the free software distribution system, which is implemented by public license practices. Many people have made generous contributions to the wide range of software distributed through that system in reliance on consistent application of that system; it is up to the author/donor to decide if he or she is willing to distribute software through any other system and a licensee cannot impose that choice.

This section is intended to make thoroughly clear what is believed to be a consequence of the rest of this License.

8. If the distribution and/or use of the Program is restricted in certain countries either by patents or by copyrighted interfaces, the original copyright holder who places the Program under this License may add an explicit geographical distribution limitation excluding those countries, so that distribution is permitted only in or among countries not thus excluded. In such case, this License incorporates the limitation as if written in the body of this License.

9. The Free Software Foundation may publish revised and/or new versions of the General Public License from time to time. Such new versions will be similar in spirit to the present version, but may differ in detail to address new problems or concerns.

Each version is given a distinguishing version number. If the Program specifies a version number of this License which applies to it and "any later version", you have the option of following the terms and conditions either of that version or of any later version published by the Free Software Foundation. If the Program does not specify a version number of this License, you may choose any version ever published by the Free Software Foundation.

10. If you wish to incorporate parts of the Program into other free programs whose distribution conditions are different, write to the author to ask for permission. For software which is copyrighted by the Free Software Foundation, write to the Free Software Foundation; we sometimes make exceptions for this. Our decision will be guided by the two goals of preserving the free status of all derivatives of our free software and of promoting the sharing and reuse of software generally.

#### NO WARRANTY

11. BECAUSE THE PROGRAM IS LICENSED FREE OF CHARGE, THERE IS NO WARRANTY FOR THE PROGRAM, TO THE EXTENT PERMITTED BY APPLICABLE LAW. EXCEPT WHEN OTHERWISE STATED IN WRITING THE COPYRIGHT HOLDERS AND/OR OTHER PARTIES PROVIDE THE PROGRAM "AS IS" WITHOUT WARRANTY OF ANY KIND, EITHER EXPRESSED OR IMPLIED, INCLUDING, BUT NOT LIMITED TO, THE IMPLIED WARRANTIES OF MERCHANTABILITY AND FITNESS FOR A PARTICULAR PURPOSE. THE ENTIRE RISK AS TO THE QUALITY AND PERFORMANCE OF THE PROGRAM IS WITH YOU. SHOULD THE PROGRAM PROVE DEFECTIVE, YOU ASSUME THE COST OF ALL NECESSARY SERVICING, REPAIR OR CORRECTION.

12. IN NO EVENT UNLESS REQUIRED BY APPLICABLE LAW OR AGREED TO IN WRITING WILL ANY COPYRIGHT HOLDER, OR ANY OTHER PARTY WHO MAY MODIFY AND/OR REDISTRIBUTE THE PROGRAM AS PERMITTED ABOVE, BE LIABLE TO YOU FOR DAMAGES, INCLUDING ANY GENERAL, SPECIAL, INCIDENTAL OR CONSEQUENTIAL DAMAGES ARISING OUT OF THE USE OR INABILITY TO USE THE PROGRAM (INCLUDING BUT NOT LIMITED TO LOSS OF DATA OR DATA BEING RENDERED INACCURATE OR LOSSES SUSTAINED BY YOU OR THIRD PARTIES OR A FAILURE OF THE PROGRAM TO OPERATE WITH ANY OTHER PROGRAMS), EVEN IF SUCH HOLDER OR OTHER PARTY HAS BEEN ADVISED OF THE POSSIBILITY OF SUCH DAMAGES.

#### END OF TERMS AND CONDITIONS

##### How to Apply These Terms to Your New Programs

If you develop a new program, and you want it to be of the greatest possible use to the public, the best way to achieve this is to make it free software which everyone can redistribute and change under these terms.

To do so, attach the following notices to the program. It is safest to attach them to the start of each source file to most effectively convey the exclusion of warranty; and each file should have at least the "copyright" line and a pointer to where the full notice is found.

```
<one line to give the program's name and a brief idea of what it does.>
Copyright (C) <year> <name of author>
```

This program is free software; you can redistribute it and/or modify it under the terms of the GNU General Public License as published by the Free Software Foundation; either version 2 of the License, or (at your option) any later version.

This program is distributed in the hope that it will be useful, but WITHOUT ANY WARRANTY; without even the implied warranty of MERCHANTABILITY or FITNESS FOR A PARTICULAR PURPOSE. See the GNU General Public License for more details.

You should have received a copy of the GNU General Public License along with this program; if not, write to the Free Software Foundation, Inc., 51 Franklin St, Fifth Floor, Boston, MA 02110-1301 USA

Also add information on how to contact you by electronic and paper mail.

If the program is interactive, make it output a short notice like this when it starts in an interactive mode:

```
Gnomovision version 69, Copyright (C) year name of author Gnomovision comes
with ABSOLUTELY NO WARRANTY; for details type 'show w'. This is free
software, and you are welcome to redistribute it under certain conditions; type
'show c' for details.
```

The hypothetical commands 'show w' and 'show c' should show the appropriate parts of the General Public License. Of course, the commands you use may be called something other than 'show w' and 'show c'; they could even be mouse-clicks or menu items--whatever suits your program.

You should also get your employer (if you work as a programmer) or your school, if any, to sign a "copyright disclaimer" for the program, if necessary. Here is a sample; alter the names:

```
Yoyodyne, Inc., hereby disclaims all copyright interest in the program
'Gnomovision' (which makes passes at compilers) written by James Hacker.
```

```
<signature of Ty Coon>, 1 April 1989
```

Ty Coon, President of Vice

This General Public License does not permit incorporating your program into proprietary programs. If your program is a subroutine library, you may consider it more useful to permit linking proprietary applications with the library. If this is what you want to do, use the GNU Library General Public License instead of this License..

## ■ About glibc, libmtp, libusb, libusb-compat, DirectFB, SawMan

GNU LESSER GENERAL PUBLIC LICENSE  
Version 2.1, February 1999

Copyright (C) 1991, 1999 Free Software Foundation, Inc.  
59 Temple Place, Suite 330, Boston, MA 02111-1307 USA

Everyone is permitted to copy and distribute verbatim copies of this license document, but changing it is not allowed.

[This is the first released version of the Lesser GPL. It also counts as the successor of the GNU Library Public License, version 2, hence the version number 2.1.]

#### Preamble

The licenses for most software are designed to take away your freedom to share and change it. By contrast, the GNU General Public Licenses are intended to guarantee your freedom to share and change free software--to make sure the software is free for all its users.

This license, the Lesser General Public License, applies to some specially designated software packages--typically libraries--of the Free Software Foundation and other authors who decide to use it. You can use it too, but we suggest you first think carefully about whether this license or the ordinary General Public License is the better strategy to use in any particular case, based on the explanations below.

When we speak of free software, we are referring to freedom of use, not price. Our General Public Licenses are designed to make sure that you have the freedom to distribute copies of free software (and charge for this service if you wish); that you receive source code or can get it if you want it; that you can change the software and use pieces of it in new free programs; and that you are informed that you can do these things.

To protect your rights, we need to make restrictions that forbid distributors to deny you these rights or to ask you to surrender these rights. These restrictions translate to certain responsibilities for you if you distribute copies of the library or if you modify it. For example, if you distribute copies of the library, whether gratis or for a fee, you must give the recipients all the rights that we gave you. You must make sure that they, too, receive or can get the source code. If you link other code with the library, you must provide complete object files to the recipients, so that they can relink them with the library after making changes to the library and recompiling it. And you must show them these terms so they know their rights.

We protect your rights with a two-step method: (1) we copyright the library, and (2) we offer you this license, which gives you legal permission to copy, distribute and/or modify the library.

To protect each distributor, we want to make it very clear that there is no warranty for the free library. Also, if the library is modified by someone else and passed on, the recipients should know that what they have is not the original version, so that the original author's reputation will not be affected by problems that might be introduced by others.

Finally, software patents pose a constant threat to the existence of any free program.

We wish to make sure that a company cannot effectively restrict the users of a free program by obtaining a restrictive license from a patent holder. Therefore, we insist that any patent license obtained for a version of the library must be consistent with the full freedom of use specified in this license.

Most GNU software, including some libraries, is covered by the ordinary GNU General Public License. This license, the GNU Lesser General Public License, applies to certain designated libraries, and is quite different from the ordinary General Public License. We use this license for certain libraries in order to permit linking those libraries into non-free programs.

When a program is linked with a library, whether statically or using a shared library, the combination of the two is legally speaking a combined work, a derivative of the original library. The ordinary General Public License therefore permits such linking only if the entire combination fits its criteria of freedom. The Lesser General Public License permits more lax criteria for linking other code with the library.

We call this license the "Lesser" General Public License because it does Less to protect the user's freedom than the ordinary General Public License. It also provides other free software developers Less of an advantage over competing non-free programs. These disadvantages are the reason we use the ordinary General Public License for many libraries. However, the Lesser license provides advantages in certain special circumstances.

For example, on rare occasions, there may be a special need to encourage the widest possible use of a certain library, so that it becomes a de-facto standard. To achieve this, non-free programs must be allowed to use the library. A more frequent case is that a free library does the same job as widely used non-free libraries. In this case, there is little to gain by limiting the free library to free software only, so we use the Lesser General Public License.

In other cases, permission to use a particular library in non-free programs enables a greater number of people to use a large body of free software. For example, permission to use the GNU C Library in non-free programs enables many more people to use the whole GNU operating system, as well as its variant, the GNU/Linux operating system. Although the Lesser General Public License is less protective of the users' freedom, it does ensure that the user of a program that is linked with the Library has the freedom and the wherewithal to run that program using a modified version of the Library. The precise terms and conditions for copying, distribution and modification follow. Pay close attention to the difference between a "work based on the library" and a "work that uses the library". The former contains code derived from the library, whereas the latter must be combined with the library in order to run.

## GNU LESSER GENERAL PUBLIC LICENSE

### TERMS AND CONDITIONS FOR COPYING, DISTRIBUTION AND MODIFICATION

0. This License Agreement applies to any software library or other program which contains a notice placed by the copyright holder or other authorized party saying it may be distributed under the terms of this Lesser General Public License (also called "this License"). Each license is addressed as "you".

A "library" means a collection of software functions and/or data prepared so as to be conveniently linked with application programs (which use some of those functions and data) to form executables.

The "Library", below, refers to any such software library or work which has been distributed under these terms. A "work based on the Library" means either the Library or any derivative work under copyright law; that is to say, a work containing the Library or a portion of it, either verbatim or with modifications and/or translated straightforwardly into another language. (Hereinafter, translation is included without limitation in the term "modification".)

"Source code" for a work means the preferred form of the work for making modifications to it. For a library, complete source code means all the source code for all modules it contains, plus any associated interface definition files, plus the scripts used to control compilation and installation of the library.

Activities other than copying, distribution and modification are not covered by this License; they are outside its scope. The act of running a program using the Library is not restricted, and output from such a program is covered only if its contents constitute a work based on the Library (independent of the use of the Library in a tool for writing it). Whether that is true depends on what the Library does and what the program that uses the Library does.

1. You may copy and distribute verbatim copies of the Library's complete source code as you receive it, in any medium, provided that you conspicuously and appropriately publish on each copy an appropriate copyright notice and disclaimer of warranty; keep intact all the notices that refer to this License and to the absence of any warranty; and distribute a copy of this License along with the Library.

You may charge a fee for the physical act of transferring a copy, and you may at your option offer warranty protection in exchange for a fee.

2. You may modify your copy or copies of the Library or any portion of it, thus forming a work based on the Library, and copy and distribute such modifications or work under the terms of Section 1 above, provided that you also meet all of these conditions:

- The modified work must itself be a software library.
- You must cause the files modified to carry prominent notices stating that you changed the files and the date of any change.
- You must cause the whole of the work to be licensed at no charge to all third parties under the terms of this License.
- If a facility in the modified Library refers to a function or a table of data to be supplied by an application program that uses the facility, other than as an argument passed when the facility is invoked, then you must make a good faith effort to ensure that, in the event an application does not supply such function or table, the facility still operates, and performs whatever part of its purpose remains meaningful.

(For example, a function in a library to compute square roots has a purpose that is entirely well-defined independent of the application. Therefore, Subsection 2d requires that any application-supplied function or table used by this function must be optional: if the application does not supply it, the square root function must still compute square roots.)

These requirements apply to the modified work as a whole. If identifiable sections of that work are not derived from the Library, and can be reasonably considered independent and separate works in themselves, then this License, and its terms, do not apply to those sections when you distribute them as separate works. But when you distribute the same sections as part of a whole which is a work based on the Library, the distribution of the whole must be on the terms of this License, whose permissions for other licensees extend to the entire whole, and thus to each and every part regardless of who wrote it.

Thus, it is not the intent of this section to claim rights or contest your rights to work written entirely by you; rather, the intent is to exercise the right to control the distribution of derivative or collective works based on the Library.

In addition, mere aggregation of another work not based on the Library with the Library (or with a work based on the Library) on a volume of a storage or distribution medium does not bring the other work under the scope of this License.

3. You may opt to apply the terms of the ordinary GNU General Public License instead of this License to a given copy of the Library. To do this, you must alter all the notices that refer to this License, so that they refer to the ordinary GNU General Public License, version 2, instead of to this License. (If a newer version than version 2 of the ordinary GNU General Public License has appeared, then you can specify that version instead if you wish.) Do not make any other change in these notices.

Once this change is made in a given copy, it is irreversible for that copy, so the ordinary GNU General Public License applies to all subsequent copies and derivative works made from that copy.

This option is useful when you wish to copy part of the code of the Library into a program that is not a library.

4. You may copy and distribute the Library (or a portion or derivative of it, under Section 2) in object code or executable form under the terms of Sections 1 and 2 above provided that you accompany it with the complete corresponding machine-readable source code, which must be distributed under the terms of Sections 1 and 2 above on a medium customarily used for software interchange.

If distribution of object code is made by offering access to copy from a designated place, then offering equivalent access to copy the source code from the same place satisfies the requirement to distribute the source code, even though third parties are not compelled to copy the source along with the object code.

5. A program that contains no derivative of any portion of the Library, but is designed to work with the Library by being compiled or linked with it, is called a "work that uses the Library". Such a work, in isolation, is not a derivative work of the Library, and therefore falls outside the scope of this License.

However, linking a "work that uses the Library" with the Library creates an executable that is a derivative of the Library (because it contains portions of the Library), rather than a "work that uses the Library". The executable is therefore covered by this License. Section 6 states terms for distribution of such executables.

When a "work that uses the Library" uses material from a header file that is part of the Library, the object code for the work may be a derivative work of the Library even though the source code is not. Whether this is true is especially significant if the work can be linked without the Library, or if the work is itself a library. The threshold for this to be true is not precisely defined by law.

If such an object file uses only numerical parameters, data structure layouts and accessors, and small macros and small inline functions (ten lines or less in length), then the use of the object file is unrestricted, regardless of whether it is legally a derivative work. (Executables containing this object code plus portions of the Library will still fall under Section 6.)

Otherwise, if the work is a derivative of the Library, you may distribute the object code for the work under the terms of Section 6. Any executables containing that work also fall under Section 6, whether or not they are linked directly with the Library itself.

6. As an exception to the Sections above, you may also combine or link a "work that uses the Library" with the Library to produce a work containing portions of the Library, and distribute that work under terms of your choice, provided that the terms permit modification of the work for the customer's own use and reverse engineering for debugging such modifications.

You must give prominent notice with each copy of the work that the Library is used in it and that the Library and its use are covered by this License. You must supply a copy of this License. If the work during execution displays copyright notices, you must include the copyright notice for the Library among them, as well as a reference directing the user to the copy of this License. Also, you must do one of these things:

- Accompany the work with the complete corresponding machine-readable source code for the Library including whatever changes were used in the work (which must be distributed under Sections 1 and 2 above); and, if the work is an executable linked with the Library, with the complete machine-readable "work that uses the Library", as object code and/or source code, so that the user can modify the Library and then relink to produce a modified executable containing the modified Library. (It is understood that the user who changes the contents of definitions files in the Library will not necessarily be able to recompile the application to use the modified definitions.)
- Use a suitable shared library mechanism for linking with the Library. A suitable mechanism is one that (1) uses at run time a copy of the library already present on the user's computer system, rather than copying library functions into the executable, and (2) will operate properly with a modified version of the library, if the user installs one, as long as the modified version is interface-compatible with the version that the work was made with.
- Accompany the work with a written offer, valid for at least three years, to give the same user the materials specified in Subsection 6a, above, for a charge no more than the cost of performing this distribution.
- If distribution of the work is made by offering access to copy from a designated place, offer equivalent access to copy the above specified materials from the same place.
- Verify that the user has already received a copy of these materials or that you have already sent this user a copy.

For an executable, the required form of the "work that uses the Library" must include any data and utility programs needed for reproducing the executable from it. However, as a special exception, the materials to be distributed need not include anything that is normally distributed (in either source or binary form) with the major components (compiler, kernel, and so on) of the operating system on which the executable runs, unless that component itself accompanies the executable.

It may happen that this requirement contradicts the license restrictions of other proprietary libraries that do not normally accompany the operating system. Such a contradiction means you cannot use both them and the Library together in an executable that you distribute.

7. You may place library facilities that are a work based on the Library side-by-side in a single library together with other library facilities not covered by this License, and distribute such a combined library, provided that the separate distribution of the work based on the Library and of the other library facilities is otherwise permitted, and provided that you do these two things:

- Accompany the combined library with a copy of the same work based on the Library, uncombined with any other library facilities. This must be distributed under the terms of the Sections above.

- b) Give prominent notice with the combined library of the fact that part of it is a work based on the Library, and explaining where to find the accompanying uncombined form of the same work.
8. You may not copy, modify, sublicense, link with, or distribute the Library except as expressly provided under this License. Any attempt otherwise to copy, modify, sublicense, link with, or distribute the Library is void, and will automatically terminate your rights under this License. However, parties who have received copies, or rights, from you under this License will not have their licenses terminated so long as such parties remain in full compliance.
9. You are not required to accept this License, since you have not signed it. However, nothing else grants you permission to modify or distribute the Library or its derivative works. These actions are prohibited by law if you do not accept this License. Therefore, by modifying or distributing the Library (or any work based on the Library), you indicate your acceptance of this License to do so, and all its terms and conditions for copying, distributing or modifying the Library or works based on it.
10. Each time you redistribute the Library (or any work based on the Library), the recipient automatically receives a license from the original licensor to copy, distribute, link with or modify the Library subject to these terms and conditions. You may not impose any further restrictions on the recipients' exercise of the rights granted herein. You are not responsible for enforcing compliance by third parties with this License.
11. If, as a consequence of a court judgment or allegation of patent infringement or for any other reason (not limited to patent issues), conditions are imposed on you (whether by court order, agreement or otherwise) that contradict the conditions of this License, they do not excuse you from the conditions of this License. If you cannot distribute so as to satisfy simultaneously your obligations under this License and any other pertinent obligations, then as a consequence you may not distribute the Library at all. For example, if a patent license would not permit royalty-free redistribution of the Library by all those who receive copies directly or indirectly through you, then the only way you could satisfy both it and this License would be to refrain entirely from distribution of the Library.
- If any portion of this section is held invalid or unenforceable under any particular circumstance, the balance of the section is intended to apply, and the section as a whole is intended to apply in other circumstances.
- It is not the purpose of this section to induce you to infringe any patents or other property right claims or to contest validity of any such claims; this section has the sole purpose of protecting the integrity of the free software distribution system which is implemented by public license practices. Many people have made generous contributions to the wide range of software distributed through that system in reliance on consistent application of that system; it is up to the author/donor to decide if he or she is willing to distribute software through any other system and a licensee cannot impose that choice.
- This section is intended to make thoroughly clear what is believed to be a consequence of the rest of this License.
12. If the distribution and/or use of the Library is restricted in certain countries either by patents or by copyrighted interfaces, the original copyright holder who places the Library under this License may add an explicit geographical distribution limitation excluding those countries, so that distribution is permitted only in or among countries not thus excluded. In such case, this License incorporates the limitation as if written in the body of this License.
13. The Free Software Foundation may publish revised and/or new versions of the Lesser General Public License from time to time. Such new versions will be similar in spirit to the present version, but may differ in detail to address new problems or concerns.
- Each version is given a distinguishing version number. If the Library specifies a version number of this License which applies to it and "any later version", you have the option of following the terms and conditions either of that version or of any later version published by the Free Software Foundation. If the Library does not specify a license version number, you may choose any version ever published by the Free Software Foundation.
14. If you wish to incorporate parts of the Library into other free programs whose distribution conditions are incompatible with these, write to the author to ask for permission. For software which is copyrighted by the Free Software Foundation, write to the Free Software Foundation; we sometimes make exceptions for this. Our decision will be guided by the two goals of preserving the free status of all derivatives of our free software and of promoting the sharing and reuse of software generally.

#### NO WARRANTY

15. BECAUSE THE LIBRARY IS LICENSED FREE OF CHARGE, THERE IS NO WARRANTY FOR THE LIBRARY, TO THE EXTENT PERMITTED BY APPLICABLE LAW. EXCEPT WHEN OTHERWISE STATED IN WRITING THE COPYRIGHT HOLDERS AND/OR OTHER PARTIES PROVIDE THE LIBRARY "AS IS" WITHOUT WARRANTY OF ANY KIND, EITHER EXPRESSED OR IMPLIED, INCLUDING, BUT NOT LIMITED TO, THE IMPLIED WARRANTIES OF MERCHANTABILITY AND FITNESS FOR A PARTICULAR PURPOSE. THE ENTIRE RISK AS TO THE QUALITY AND PERFORMANCE OF THE LIBRARY IS WITH YOU. SHOULD THE LIBRARY PROVE DEFECTIVE, YOU ASSUME THE COST OF ALL NECESSARY SERVICING, REPAIR OR CORRECTION.

16. IN NO EVENT UNLESS REQUIRED BY APPLICABLE LAW OR AGREED TO IN WRITING WILL ANY COPYRIGHT HOLDER, OR ANY OTHER PARTY WHO MAY MODIFY AND/OR REDISTRIBUTE THE LIBRARY AS PERMITTED ABOVE, BE LIABLE TO YOU FOR DAMAGES, INCLUDING ANY GENERAL, SPECIAL, INCIDENTAL OR CONSEQUENTIAL DAMAGES ARISING OUT OF THE USE OR INABILITY TO USE THE LIBRARY (INCLUDING BUT NOT LIMITED TO LOSS OF DATA OR DATA BEING RENDERED INACCURATE OR LOSSES SUSTAINED BY YOU OR THIRD PARTIES OR A FAILURE OF THE LIBRARY TO OPERATE WITH ANY OTHER SOFTWARE), EVEN IF SUCH HOLDER OR OTHER PARTY HAS BEEN ADVISED OF THE POSSIBILITY OF SUCH DAMAGES.

#### END OF TERMS AND CONDITIONS

##### How to Apply These Terms to Your New Libraries

If you develop a new library, and you want it to be of the greatest possible use to the public, we recommend making it free software that everyone can redistribute and change. You can do so by permitting redistribution under these terms (or, alternatively, under the terms of the ordinary General Public License).

To apply these terms, attach the following notices to the library. It is safest to attach them to the start of each source file to most effectively convey the exclusion of warranty; and each file should have at least the "copyright" line and a pointer to where the full notice is found.

```
<one line to give the library's name and a brief idea of what it does.> Copyright (C)
<year> <name of author>
```

This library is free software; you can redistribute it and/or modify it under the terms of the GNU Lesser General Public License as published by the Free Software Foundation; either version 2 of the License, or (at your option) any later version.

This library is distributed in the hope that it will be useful, but WITHOUT ANY WARRANTY; without even the implied warranty of MERCHANTABILITY or FITNESS FOR A PARTICULAR PURPOSE. See the GNU Lesser General Public License for more details.

You should have received a copy of the GNU Lesser General Public License along with this library; if not, write to the Free Software Foundation, Inc., 59 Temple Place, Suite 330, Boston, MA 02111-1307 USA

Also add information on how to contact you by electronic and paper mail.

You should also get your employer (if you work as a programmer) or your school, if any, to sign a "copyright disclaimer" for the library, if necessary. Here is a sample; alter the names:

```
Yoyodyne, Inc., hereby disclaims all copyright interest in the library 'Frob' (a
library for tweaking knobs) written by James Random Hacker.
```

```
<signature of Ty Coon>, 1 April 1990 Ty Coon, President of Vice
```

That's all there is to it!

#### ■ About Fusion

DirectFB Fusion kernel module: introduction and API

by Niels Røest

Copyright (C) 2009 Niels Røest

This documentation is free software; you can redistribute it and/or modify it under the terms of the GNU General Public License as published by the Free Software Foundation; either version 2 of the License, or (at your option) any later version.

This program is distributed in the hope that it will be useful, but WITHOUT ANY WARRANTY; without even the implied warranty of MERCHANTABILITY or FITNESS FOR A PARTICULAR PURPOSE. See the GNU General Public License for more details.

You should have received a copy of the GNU General Public License along with this program; if not, write to the Free Software Foundation, Inc., 59 Temple Place, Suite 330, Boston, MA 02111-1307 USA  
For more details see the file COPYING in the source distribution of Linux.

#### ■ About openssl

Copyright (C) 1998-2008 The OpenSSL Project. All rights reserved.

Redistribution and use in source and binary forms, with or without modification, are permitted provided that the following conditions are met:

1. Redistributions of source code must retain the above copyright notice, this list of conditions and the following disclaimer.
2. Redistributions in binary form must reproduce the above copyright notice, this list of conditions and the following disclaimer in the documentation and/or other materials provided with the distribution.
3. All advertising materials mentioning features or use of this software must display the following acknowledgment:  
"This product includes software developed by the OpenSSL Project for use in the OpenSSL Toolkit. (<http://www.openssl.org/>)"
4. The names "OpenSSL Toolkit" and "OpenSSL Project" must not be used to endorse or promote products derived from this software without prior written permission. For written permission, please contact [openssl-core@openssl.org](mailto:openssl-core@openssl.org).
5. Products derived from this software may not be called "OpenSSL" nor may "OpenSSL" appear in their names without prior written permission of the OpenSSL Project.
6. Redistributions of any form whatsoever must retain the following acknowledgment:  
"This product includes software developed by the OpenSSL Project for use in the OpenSSL Toolkit (<http://www.openssl.org/>)"

THIS SOFTWARE IS PROVIDED BY THE OpenSSL PROJECT "AS IS" AND ANY EXPRESSED OR IMPLIED WARRANTIES, INCLUDING, BUT NOT LIMITED TO, THE IMPLIED WARRANTIES OF MERCHANTABILITY AND FITNESS FOR A PARTICULAR PURPOSE ARE DISCLAIMED. IN NO EVENT SHALL THE OpenSSL PROJECT OR ITS CONTRIBUTORS BE LIABLE FOR ANY DIRECT, INDIRECT, INCIDENTAL, SPECIAL, EXEMPLARY, OR CONSEQUENTIAL DAMAGES (INCLUDING, BUT NOT LIMITED TO, PROCUREMENT OF SUBSTITUTE GOODS OR SERVICES; LOSS OF USE, DATA, OR PROFITS; OR BUSINESS INTERRUPTION) HOWEVER CAUSED AND ON ANY THEORY OF LIABILITY, WHETHER IN CONTRACT, STRICT LIABILITY, OR TORT (INCLUDING NEGLIGENCE OR OTHERWISE) ARISING IN ANY WAY OUT OF THE USE OF THIS SOFTWARE, EVEN IF ADVISED OF THE POSSIBILITY OF SUCH DAMAGE.

This product includes cryptographic software written by Eric Young (eay@cryptsoft.com). This product includes software written by Tim Hudson (tjh@cryptsoft.com).

#### Original SSLeay License

Copyright (C) 1995-1998 Eric Young (eay@cryptsoft.com) All rights reserved. This package is an SSL implementation written by Eric Young (eay@cryptsoft.com). The implementation was written so as to conform with Netscapes SSL. This library is free for commercial and non-commercial use as long as the following conditions are adhered to. The following conditions apply to all code found in this distribution, be it the RC4, RSA, lhash, DES, etc., code; not just the SSL code. The SSL documentation included with this distribution is covered by the same copyright terms except that the holder is Tim Hudson (tjh@cryptsoft.com). Copyright remains Eric Young's, and as such any Copyright notices in the code are not to be removed. If this package is used in a product, Eric Young should be given attribution as the author of the parts of the library used. This can be in the form of a textual message at program startup or in documentation (online or textual) provided with the package.

Redistribution and use in source and binary forms, with or without modification, are permitted provided that the following conditions are met:

1. Redistributions of source code must retain the copyright notice, this list of conditions and the following disclaimer.
2. Redistributions in binary form must reproduce the above copyright notice, this list of conditions and the following disclaimer in the documentation and/or other materials provided with the distribution.
3. All advertising materials mentioning features or use of this software must display the following acknowledgment:  
"This product includes cryptographic software written by Eric Young (eay@cryptsoft.com)" The word 'cryptographic' can be left out if the routines from the library being used are not cryptographic related :-).
4. If you include any Windows specific code (or a derivative thereof) from the apps directory (application code) you must include an acknowledgement:  
"This product includes software written by Tim Hudson (tjh@cryptsoft.com)"

THIS SOFTWARE IS PROVIDED BY ERIC YOUNG "AS IS" AND ANY EXPRESS OR IMPLIED WARRANTIES, INCLUDING, BUT NOT LIMITED TO, THE IMPLIED WARRANTIES OF MERCHANTABILITY AND FITNESS FOR A PARTICULAR PURPOSE ARE DISCLAIMED. IN NO EVENT SHALL THE AUTHOR OR CONTRIBUTORS BE LIABLE FOR ANY DIRECT, INDIRECT, INCIDENTAL, SPECIAL, EXEMPLARY, OR CONSEQUENTIAL DAMAGES (INCLUDING, BUT NOT LIMITED TO, PROCUREMENT OF SUBSTITUTE GOODS OR SERVICES; LOSS OF USE, DATA, OR PROFITS; OR BUSINESS INTERRUPTION) HOWEVER CAUSED AND ON ANY THEORY OF LIABILITY, WHETHER IN CONTRACT, STRICT LIABILITY, OR TORT (INCLUDING NEGLIGENCE OR OTHERWISE) ARISING IN ANY WAY OUT OF THE USE OF THIS SOFTWARE, EVEN IF ADVISED OF THE POSSIBILITY OF SUCH DAMAGE.

The licence and distribution terms for any publically available version or derivative of this code cannot be changed. i.e. this code cannot simply be copied and put under another distribution licence [including the GNU Public Licence.]

## ■ About zlib

Copyright notice:

(C) 1995-2004 Jean-loup Gailly and Mark Adler

This software is provided 'as-is', without any express or implied warranty. In no event will the authors be held liable for any damages arising from the use of this software. Permission is granted to anyone to use this software for any purpose, including commercial applications, and to alter it and redistribute it freely, subject to the following restrictions:

1. The origin of this software must not be misrepresented; you must not claim that you wrote the original software. If you use this software in a product, an acknowledgment in the product documentation would be appreciated but is not required.
2. Altered source versions must be plainly marked as such, and must not be misrepresented as being the original software.
3. This notice may not be removed or altered from any source distribution.

Jean-loup Gailly Mark Adler

jloup@gzip.org madler@alumni.caltech.edu

If you use the zlib library in a product, we would appreciate \*not\* receiving lengthy legal documents to sign. The sources are provided for free but without warranty of any kind. The library has been entirely written by Jean-loup Gailly and Mark Adler; it does not include third-party code.

If you redistribute modified sources, we would appreciate that you include in the file ChangeLog history information documenting your changes. Please read the FAQ for more information on the distribution of modified source versions.

## ■ About FreeType

The FreeType Project LICENSE

2006-Jan-27

Copyright 1996-2002, 2006 by  
David Turner, Robert Wilhelm, and Werner Lemberg

### Introduction

The FreeType Project is distributed in several archive packages; some of them may contain, in addition to the FreeType font engine, various tools and contributions which rely on, or relate to, the FreeType Project.

This license applies to all files found in such packages, and which do not fall under their own explicit license. The license affects thus the FreeType font engine, the test programs, documentation and makefiles, at the very least.

This license was inspired by the BSD, Artistic, and IJG (Independent JPEG Group) licenses, which all encourage inclusion and use of free software in commercial and freeware products alike. As a consequence, its main points are that:

- o We don't promise that this software works. However, we will be interested in any kind of bug reports. ('as is' distribution)
- o You can use this software for whatever you want, in parts or full form, without having to pay us. ('royalty-free' usage)
- o You may not pretend that you wrote this software. If you use it, or only parts of it, in a program, you must acknowledge somewhere in your documentation that you have used the FreeType code. ('credits')

We specifically permit and encourage the inclusion of this software, with or without modifications, in commercial products. We disclaim all warranties covering The FreeType Project and assume no liability related to The FreeType Project. Finally, many people asked us for a preferred form for a credit/disclaimer to use in compliance with this license. We thus encourage you to use the following text:

Portions of this software are copyright (C) <year> The FreeType Project (www.freetype.org). All rights reserved.

Please replace <year> with the value from the FreeType version you actually use.

### Legal Terms

#### 0. Definitions

Throughout this license, the terms 'package', 'FreeType Project', and 'FreeType archive' refer to the set of files originally distributed by the authors (David Turner, Robert Wilhelm, and Werner Lemberg) as the 'FreeType Project', be they named as alpha, beta or final release.

'You' refers to the licensee, or person using the project, where 'using' is a generic term including compiling the project's source code as well as linking it to form a 'program' or 'executable'. This program is referred to as 'a program using the FreeType engine'. This license applies to all files distributed in the original FreeType Project, including all source code, binaries and documentation, unless otherwise stated in the file in its original, unmodified form as distributed in the original archive. If you are unsure whether or not a particular file is covered by this license, you must contact us to verify this.

The FreeType Project is copyright (C) 1996-2000 by David Turner, Robert Wilhelm, and Werner Lemberg. All rights reserved except as specified below.

#### 1. No Warranty

THE FREETYPE PROJECT IS PROVIDED 'AS IS' WITHOUT WARRANTY OF ANY KIND, EITHER EXPRESS OR IMPLIED, INCLUDING, BUT NOT LIMITED TO, WARRANTIES OF MERCHANTABILITY AND FITNESS FOR A PARTICULAR PURPOSE. IN NO EVENT WILL ANY OF THE AUTHORS OR COPYRIGHT HOLDERS BE LIABLE FOR ANY DAMAGES CAUSED BY THE USE OR THE INABILITY TO USE, OF THE FREETYPE PROJECT.

#### 2. Redistribution

This license grants a worldwide, royalty-free, perpetual and irrevocable right and license to use, execute, perform, compile, display, copy, create derivative works of, distribute and sublicense the FreeType Project (in both source and object code forms) and derivative works thereof for any purpose; and to authorize others to exercise some or all of the rights granted herein, subject to the following conditions:

- o Redistribution of source code must retain this license file ('FTL.TXT') unaltered; any additions, deletions or changes to the original files must be clearly indicated in accompanying documentation. The copyright notices of the unaltered, original files must be preserved in all copies of source files.
- o Redistribution in binary form must provide a disclaimer that states that the software is based in part of the work of the FreeType Team, in the distribution documentation. We also encourage you to put an URL to the FreeType web page in your documentation, though this isn't mandatory.

These conditions apply to any software derived from or based on the FreeType Project, not just the unmodified files. If you use our work, you must acknowledge us. However, no fee need be paid to us.

#### 3. Advertising

Neither the FreeType authors and contributors nor you shall use the name of the other for commercial, advertising, or promotional purposes without specific prior written permission.

We suggest, but do not require, that you use one or more of the following phrases to refer to this software in your documentation or advertising materials: 'FreeType Project', 'FreeType Engine', 'FreeType library', or 'FreeType Distribution'.

As you have not signed this license, you are not required to accept it. However, as the FreeType Project is copyrighted material, only this license, or another one contracted with the authors, grants you the right to use, distribute, and modify it. Therefore, by using, distributing, or modifying the FreeType Project, you indicate that you understand and accept all the terms of this license.

#### 4. Contacts

There are two mailing lists related to FreeType:

o freetype@nongnu.org

Discusses general use and applications of FreeType, as well as future and wanted additions to the library and distribution. If you are looking for support, start in this list if you haven't found anything to help you in the documentation.

o freetype-devel@nongnu.org

Discusses bugs, as well as engine internals, design issues, specific licenses, porting, etc. Our home page can be found at <http://www.freetype.org>

## ■ About Expat

Copyright (C) 1998, 1999, 2000 Thai Open Source Software Center Ltd  
and Clark Cooper

Copyright (C) 2001, 2002, 2003, 2004, 2005, 2006 Expat maintainers.

Permission is hereby granted, free of charge, to any person obtaining a copy of this software and associated documentation files (the "Software"), to deal in the Software without restriction, including without limitation the rights to use, copy, modify, merge, publish, distribute, sublicense, and/or sell copies of the Software, and to permit persons to whom the Software is furnished to do so, subject to the following conditions:  
The above copyright notice and this permission notice shall be included in all copies or substantial portions of the Software.

THE SOFTWARE IS PROVIDED "AS IS", WITHOUT WARRANTY OF ANY KIND, EXPRESS OR IMPLIED, INCLUDING BUT NOT LIMITED TO THE WARRANTIES OF MERCHANTABILITY, FITNESS FOR A PARTICULAR PURPOSE AND NONINFRINGEMENT. IN NO EVENT SHALL THE AUTHORS OR COPYRIGHT HOLDERS BE LIABLE FOR ANY CLAIM, DAMAGES OR OTHER LIABILITY, WHETHER IN AN ACTION OF CONTRACT, TORT OR OTHERWISE, ARISING FROM, OUT OF OR IN CONNECTION WITH THE SOFTWARE OR THE USE OR OTHER DEALINGS IN THE SOFTWARE.

## ■ About cURL, libcurl

COPYRIGHT AND PERMISSION NOTICE

Copyright (C) 1996 - 2009, Daniel Stenberg, <daniel@haxx.se>.  
All rights reserved.

Permission to use, copy, modify, and distribute this software for any purpose with or without fee is hereby granted, provided that the above copyright notice and this permission notice appear in all copies.

THE SOFTWARE IS PROVIDED "AS IS", WITHOUT WARRANTY OF ANY KIND, EXPRESS OR IMPLIED, INCLUDING BUT NOT LIMITED TO THE WARRANTIES OF MERCHANTABILITY, FITNESS FOR A PARTICULAR PURPOSE AND NONINFRINGEMENT OF THIRD PARTY RIGHTS. IN NO EVENT SHALL THE AUTHORS OR COPYRIGHT HOLDERS BE LIABLE FOR ANY CLAIM, DAMAGES OR OTHER LIABILITY, WHETHER IN AN ACTION OF CONTRACT, TORT OR OTHERWISE, ARISING FROM, OUT OF OR IN CONNECTION WITH THE SOFTWARE OR THE USE OR OTHER DEALINGS IN THE SOFTWARE.

Except as contained in this notice, the name of a copyright holder shall not be used in advertising or otherwise to promote the sale, use or other dealings in this Software without prior written authorization of the copyright holder.

## ■ About Independent JPEG Group's software, libjpeg

In plain English:

1. We don't promise that this software works. (But if you find any bugs, please let us know!)

2. You can use this software for whatever you want. You don't have to pay us.

3. You may not pretend that you wrote this software. If you use it in a program, you must acknowledge somewhere in your documentation that you've used the IJG code.

In legalese:

The authors make NO WARRANTY or representation, either express or implied, with respect to this software, its quality, accuracy, merchantability, or fitness for a particular purpose. This software is provided "AS IS", and you, its user, assume the entire risk as to its quality and accuracy.

This software is copyright (C) 1991-2009, Thomas G. Lane, Guido Vollbeding.

All Rights Reserved except as specified below.

Permission is hereby granted to use, copy, modify, and distribute this software (or portions thereof) for any purpose, without fee, subject to these conditions:

(1) If any part of the source code for this software is distributed, then this README file must be included, with this copyright and no-warranty notice unaltered; and any additions, deletions, or changes to the original files must be clearly indicated in accompanying documentation.

(2) If only executable code is distributed, then the accompanying documentation must state that "this software is based in part on the work of the Independent JPEG Group".

(3) Permission for use of this software is granted only if the user accepts full responsibility for any undesirable consequences; the authors accept NO LIABILITY for damages of any kind.

These conditions apply to any software derived from or based on the IJG code, not just to the unmodified library. If you use our work, you ought to acknowledge us.

Permission is NOT granted for the use of any IJG author's name or company name in advertising or publicity relating to this software or products derived from it. This software may be referred to only as "the Independent JPEG Group's software".

We specifically permit and encourage the use of this software as the basis of commercial products, provided that all warranty or liability claims are assumed by the product vendor.

ansi2knr.c is included in this distribution by permission of L. Peter Deutsch, sole proprietor of its copyright holder, Aladdin Enterprises of Menlo Park, CA. ansi2knr.c is NOT covered by the above copyright and conditions, but instead by the usual distribution terms of the Free Software Foundation; principally, that you must include source code if you redistribute it. (See the file ansi2knr.c for full details.) However, since ansi2knr.c is not needed as part of any program generated from the IJG code, this does not limit you more than the foregoing paragraphs do.

The Unix configuration script "configure" was produced with GNU Autoconf. It is copyright by the Free Software Foundation but is freely distributable. The same holds for its supporting scripts (config.guess, config.sub, ltmain.sh). Another support script, install-sh, is copyright by X Consortium but is also freely distributable.

The IJG distribution formerly included code to read and write GIF files. To avoid entanglement with the Unisys LZW patent, GIF reading support has been removed altogether, and the GIF writer has been simplified to produce "uncompressed GIFs". This technique does not use the LZW algorithm; the resulting GIF files are larger than usual, but are readable by all standard GIF decoders.

We are required to state that

"The Graphics Interchange Format(c) is the Copyright property of

CompuServe Incorporated. GIF(sm) is a Service Mark property of

CompuServe Incorporated."

## ■ About International Components for Unicode

ICU License - ICU 1.8.1 and later

COPYRIGHT AND PERMISSION NOTICE

Copyright (C) 1995-2003 International Business Machines Corporation and others  
All rights reserved.

Permission is hereby granted, free of charge, to any person obtaining a copy of this software and associated documentation files (the "Software"), to deal in the Software without restriction, including without limitation the rights to use, copy, modify, merge, publish, distribute, and/or sell copies of the Software, and to permit persons to whom the Software is furnished to do so, provided that the above copyright notice(s) and this permission notice appear in all copies of the Software and that both the above copyright notice(s) and this permission notice appear in supporting documentation.

THE SOFTWARE IS PROVIDED "AS IS", WITHOUT WARRANTY OF ANY KIND, EXPRESS OR IMPLIED, INCLUDING BUT NOT LIMITED TO THE WARRANTIES OF MERCHANTABILITY, FITNESS FOR A PARTICULAR PURPOSE AND NONINFRINGEMENT OF THIRD PARTY RIGHTS. IN NO EVENT SHALL THE COPYRIGHT HOLDER OR HOLDERS INCLUDED IN THIS NOTICE BE LIABLE FOR ANY CLAIM, OR ANY SPECIAL INDIRECT OR CONSEQUENTIAL DAMAGES, OR ANY DAMAGES WHATSOEVER RESULTING FROM LOSS OF USE, DATA OR PROFITS, WHETHER IN AN ACTION OF CONTRACT, NEGLIGENCE OR OTHER TORTIOUS ACTION, ARISING OUT OF OR IN CONNECTION WITH THE USE OR PERFORMANCE OF THIS SOFTWARE.

Except as contained in this notice, the name of a copyright holder shall not be used in advertising or otherwise to promote the sale, use or other dealings in this Software without prior written authorization of the copyright holder.

All trademarks and registered trademarks mentioned herein are the property of their respective owners.

## ■ About libpng

This copy of the libpng notices is provided for your convenience. In case of any discrepancy between this copy and the notices in the file png.h that is included in the libpng distribution, the latter shall prevail.

COPYRIGHT NOTICE, DISCLAIMER, and LICENSE:

If you modify libpng you may insert additional notices immediately following this sentence. This code is released under the libpng license.

libpng versions 1.2.6, August 15, 2004, through 1.2.47, February 18, 2012, are Copyright (C) 2004, 2006-2009 Glenn Randers-Pehrson, and are distributed according to the same disclaimer and license as libpng-1.2.5 with the following individual added to the list of Contributing Authors

Cosmin Truta

libpng versions 1.0.7, July 1, 2000, through 1.2.5 - October 3, 2002, are Copyright (C) 2000-2002 Glenn Randers-Pehrson, and are distributed according to the same disclaimer and license as libpng-1.0.6 with the following individuals added to the list of Contributing Authors

Simon-Pierre Cadieux

Eric S. Raymond

Gilles Vollant

and with the following additions to the disclaimer:

There is no warranty against interference with your enjoyment of the library or against infringement. There is no warranty that our efforts or the library will fulfill any of your particular purposes or needs. This library is provided with all faults, and the entire risk of satisfactory quality, performance, accuracy, and effort is with the user.

libpng versions 0.97, January 1998, through 1.0.6, March 20, 2000, are Copyright (C) 1998, 1999 Glenn Randers-Pehrson, and are distributed according to the same disclaimer and license as libpng-0.96, with the following individuals added to the list of Contributing Authors:

Tom Lane

Glenn Randers-Pehrson

Willem van Schaik

libpng versions 0.89, June 1996, through 0.96, May 1997, are Copyright (C) 1996, 1997 Andreas Dilger Distributed according to the same disclaimer and license as libpng-0.88, with the following individuals added to the list of Contributing Authors:

John Bowler

Kevin Bracey

Sam Bushell

Magnus Holmgren

Greg Roelofs

Tom Tanner

libpng versions 0.5, May 1995, through 0.88, January 1996, are Copyright (C) 1995, 1996 Guy Eric Schalnat, Group 42, Inc. For the purposes of this copyright and license, "Contributing Authors" is defined as the following set of individuals:

Andreas Dilger

Dave Martindale

Guy Eric Schalnat

Paul Schmidt

Tim Wegner

The PNG Reference Library is supplied "AS IS". The Contributing Authors and Group 42, Inc. disclaim all warranties, expressed or implied, including, without limitation, the warranties of merchantability and of fitness for any purpose. The Contributing Authors and Group 42, Inc. assume no liability for direct, indirect, incidental, special, exemplary, or consequential damages, which may result from the use of the PNG Reference Library, even if advised of the possibility of such damage. Permission is hereby granted to use, copy, modify, and distribute this source code, or portions hereof, for any purpose, without fee, subject to the following restrictions:

1. The origin of this source code must not be misrepresented.
2. Altered versions must be plainly marked as such and must not be misrepresented as being the original source.
3. This Copyright notice may not be removed or altered from any source or altered source distribution.

The Contributing Authors and Group 42, Inc. specifically permit, without fee, and encourage the use of this source code as a component to supporting the PNG file format in commercial products. If you use this source code in a product, acknowledgment is not required but would be appreciated.

A "png\_get\_copyright" function is available, for convenient use in "about" boxes and the like:

```
printf("%s",png_get_copyright(NULL));
```

Also, the PNG logo (in PNG format, of course) is supplied in the files "pngbar.png" and "pngbar.jpg (88x31)" and "pngnow.png" (98x31).

Libpng is OSI Certified Open Source Software. OSI Certified Open Source is a certification mark of the Open Source Initiative.

Glenn Randers-Pehrson

glennrp at users.sourceforge.net

February 18, 2012

## ■ About gSOAP

gSOAP Public License

Version 1.3b

The gSOAP public license is derived from the Mozilla Public License (MPL1.1). The sections that were deleted

from the original MPL1.1 text are 1.0.1, 2.1.(c),(d), 2.2.(c),(d), 8.2.(b), 10, and 11.

Section 3.8 was added. The

modified sections are 2.1.(b), 2.2.(b), 3.2 (simplified), 3.5 (deleted the last sentence), and 3.6 (simplified).

This license applies to the gSOAP software package, with the exception of the wsdl2h source code located in

gsoap/wsdl, all code generated by wsdl2h, the UDDI source code gsoap/uddi2, and the Web server sample

source code samples/webserver. To use all of the software commercially, a commercial license has to be obtained

from [www.genivia.com](http://www.genivia.com).

### 1 DEFINITIONS.

#### 1.0.1.

1.1. "Contributor" means each entity that creates or contributes to the creation of Modifications.

1.2. "Contributor Version" means the combination of the Original Code, prior Modifications used by a Contributor, and the Modifications made by that particular Contributor.

1.3. "Covered Code" means the Original Code, or Modifications or the combination of the Original Code, and Modifications, in each case including portions thereof.

1.4. "Electronic Distribution Mechanism" means a mechanism generally accepted in the software development community for the electronic transfer of data.

1.5. "Executable" means Covered Code in any form other than Source Code.

1.6. "Initial Developer" means the individual or entity identified as the Initial Developer in the Source Code notice required by Exhibit A.

1.7. "Larger Work" means a work which combines Covered Code or portions thereof with code not governed by the terms of this License.

1.8. "License" means this document.

1.8.1. "Licensable" means having the right to grant, to the maximum extent possible, whether at the time of the initial grant or subsequently acquired, any and all of the rights conveyed herein.

1.9. "Modifications" means any addition to or deletion from the substance or structure of either the Original Code or any previous Modifications. When Covered Code is released as a series of files, a Modification is: A.

Any addition to or deletion from the contents of a file containing Original Code or previous Modifications. B.

Any new file that contains any part of the Original Code, or previous Modifications.

1.10. "Original Code" means Source Code of computer software code which is described in the Source Code notice required by Exhibit A as Original Code, and which, at the time of its release under this License is not already Covered Code governed by this License.

1.10.1. "Patent Claims" means any patent claim(s), now owned or hereafter acquired, including without limitation, method, process, and apparatus claims, in any patent Licensable by grantor.

<http://www.cs.fsu.edu/~engelen/license.html>

1.11. "Source Code" means the preferred form of the Covered Code for making modifications to it, including all modules it contains, plus any associated interface definition files, scripts used to control compilation and installation of an Executable, or source code differential comparisons against either the Original Code or another well known, available Covered Code of the Contributor's choice. The Source Code can be in a compressed or archival form, provided the appropriate decompression or de-archiving software is widely available for no charge.

1.12. "You" (or "Your") means an individual or a legal entity exercising rights under, and complying with all of the terms of, this License or a future version of this License issued under Section 6.1. For legal entities, "You" includes any entity which controls, is controlled by, or is under common control with You. For purposes of this definition, "control" means (a) the power, direct or indirect, to cause the direction or management of such entity, whether by contract or otherwise, or (b) ownership of more than fifty percent (50%) of the outstanding shares or beneficial ownership of such entity.

### 2 SOURCE CODE LICENSE.

2.1. The Initial Developer Grant. The Initial Developer hereby grants You a worldwide, royalty-free, non-exclusive license, subject to third party intellectual property claims:

(a) under intellectual property rights (other than patent or trademark) Licensable by Initial Developer to use, reproduce, modify, display, perform, sublicense and distribute the Original Code (or portions thereof) with or without Modifications, and/or as part of a Larger Work; and

(b) under patents now or hereafter owned or controlled by Initial Developer, to make, have made, use and sell ("offer to sell and import") the Original Code, Modifications, or portions thereof, but solely to the extent that any such patent is reasonably necessary to enable You to utilize, alone or in combination with other software, the Original Code, Modifications, or any combination or portions thereof.

(c)

(d)

#### 2.2. Contributor Grant.

Subject to third party intellectual property claims, each Contributor hereby grants You a world-wide, royalty-free, non-exclusive license

(a)

under intellectual property rights (other than patent or trademark) Licensable by Contributor, to use, reproduce, modify, display, perform, sublicense and distribute the Modifications created by such Contributor (or portions thereof) either on an unmodified basis, with other Modifications, as Covered Code and/or as part of a Larger Work; and

(b)

under patents now or hereafter owned or controlled by Contributor, to make, have made, use and sell ("offer to sell and import") the Contributor Version (or portions thereof), but solely to the extent that any such patent is reasonably necessary to enable You to utilize, alone or in combination with other software, the Contributor Version (or portions thereof).

(c)

(d)

### 3 DISTRIBUTION OBLIGATIONS.

#### 3.1. Application of License.

The Modifications which You create or to which You contribute are governed by the terms of this License, including without limitation Section 2.2. The Source Code version of Covered Code may be distributed only under the terms of this License or a future version of this License released under Section 6.1, and You must include a copy of this License with every copy of the Source Code You distribute. You may not offer or impose any terms on any Source Code version that alters or restricts the applicable version of this License or the recipients' rights hereunder. However, You may include an additional document offering the additional rights described in Section 3.5.

#### 3.2. Availability of Source Code.

Any Modification created by You will be provided to the Initial Developer in Source Code form and are subject to the terms of the License.

#### 3.3. Description of Modifications.

You must cause all Covered Code to which You contribute to contain a file documenting the changes You made to create that Covered Code and the date of any change. You must include a prominent statement that the Modification is derived, directly or indirectly, from Original Code provided by the Initial Developer and including the name of the Initial Developer in (a) the Source Code, and (b) in any notice in an Executable version or related documentation in which You describe the origin or ownership of the Covered Code.

#### 3.4. Intellectual Property Matters.

##### (a) Third Party Claims.

If Contributor has knowledge that a license under a third party's intellectual property rights is required to exercise the rights granted by such Contributor under Sections 2.1 or 2.2, Contributor must include a text file with the Source Code distribution titled "LEGAL" which describes the claim and the party making the claim in sufficient detail that a recipient will know whom to contact. If Contributor obtains such knowledge after the Modification is made available as described in Section 3.2, Contributor shall promptly modify the LEGAL file in all copies Contributor makes available thereafter and shall take other steps (such as notifying appropriate mailing lists or newsgroups) reasonably calculated to inform those who received the Covered Code that new knowledge has been obtained.

##### (b) Contributor APIs.

If Contributor's Modifications include an application programming interface and Contributor has knowledge of patent licenses which are reasonably necessary to implement that API, Contributor must also include this information in the LEGAL file.

##### (c) Representations.

Contributor represents that, except as disclosed pursuant to Section 3.4(a) above, Contributor believes that Contributor's Modifications are Contributor's original creation(s) and/or Contributor has sufficient rights to grant the rights conveyed by this License.

#### 3.5. Required Notices.

You must duplicate the notice in Exhibit A in each file of the Source Code. If it is not possible to put such notice in a particular Source Code file due to its structure, then You must include such notice in a location (such as a relevant directory) where a user would be likely to look for such a notice. If You created one or more Modification(s) You may add your name as a Contributor to the notice described in Exhibit A. You must also duplicate this License in any documentation for the Source Code where You describe recipients' rights or ownership rights relating to Covered Code. You may choose to offer, and to charge a fee for, warranty, support, indemnity or liability obligations to one or more recipients of Covered Code. However, You may do so only on Your own behalf, and not on behalf of the Initial Developer or any Contributor.

#### 3.6. Distribution of Executable Versions.

You may distribute Covered Code in Executable form only if the requirements of Section 3.1-3.5 have been met for that Covered Code. You may distribute the Executable version of Covered Code or ownership rights under a license of Your choice, which may contain terms different from this License, provided that You are in compliance with the terms of this License and that the license for the Executable version does not attempt to limit or alter the recipient's rights in the Source Code version from the rights set forth in this License. If You distribute the Executable version under a different license You must make it absolutely clear that any terms which differ from this License are offered by You alone, not by the Initial Developer or any Contributor. If You distribute executable versions containing Covered Code as part of a product, you must reproduce the notice in Exhibit B in the documentation and/or other materials provided with the product.

#### 3.7. Larger Works.

You may create a Larger Work by combining Covered Code with other code not governed by the terms of this License and distribute the Larger Work as a single product. In such a case, You must make sure the requirements of this License are fulfilled for the Covered Code.

#### 3.8. Restrictions.

You may not remove any product identification, copyright, proprietary notices or labels from gSOAP.

#### 4. INABILITY TO COMPLY DUE TO STATUTE OR REGULATION.

If it is impossible for You to comply with any of the terms of this License with respect to some or all of the Covered Code due to statute, judicial order, or regulation then You must: (a) comply with the terms of this License to the maximum extent possible; and (b) describe the limitations and the code they affect. Such description must be included in the LEGAL file described in Section 3.4 and must be included with all distributions of the Source Code. Except to the extent prohibited by statute or regulation, such description must be sufficiently detailed for a recipient of ordinary skill to be able to understand it.

#### 5. APPLICATION OF THIS LICENSE.

This License applies to code to which the Initial Developer has attached the notice in Exhibit A and to related Covered Code.

#### 6. VERSIONS OF THE LICENSE.

##### 6.1. New Versions.

Grantor may publish revised and/or new versions of the License from time to time.

Each version will be given a distinguishing version number.

##### 6.2. Effect of New Versions.

Once Covered Code has been published under a particular version of the License, You may always continue to use it under the terms of that version. You may also choose to use such Covered Code under the terms of any subsequent version of the License.

##### 6.3. Derivative Works.

If You create or use a modified version of this License (which you may only do in order to apply it to code which is not already Covered Code governed by this License), You must (a) rename Your license so that the phrase "gSOAP" or any confusingly similar phrase do not appear in your license (except to note that your license differs from this License) and (b) otherwise make it clear that Your version of the license contains terms which differ from the gSOAP Public License. (Filling in the name of the Initial Developer, Original Code or Contributor in the notice described in Exhibit A shall not of themselves be deemed to be modifications of this License.)

#### 7. DISCLAIMER OF WARRANTY.

COVERED CODE IS PROVIDED UNDER THIS LICENSE ON AN "AS IS" BASIS, WITHOUT WARRANTY OF ANY KIND, WHETHER EXPRESS, IMPLIED OR STATUTORY, INCLUDING, WITHOUT LIMITATION, THE IMPLIED WARRANTIES OF MERCHANTABILITY, OF FITNESS FOR A PARTICULAR PURPOSE, NON-INFRINGEMENT OF THIRD PARTY INTELLECTUAL PROPERTY RIGHTS, AND ANY WARRANTY THAT MAY ARISE BY REASON OF TRADE USAGE, CUSTOM, OR COURSE OF DEALING. WITHOUT LIMITING THE FOREGOING, YOU ACKNOWLEDGE THAT THE SOFTWARE IS PROVIDED "AS IS" AND THAT THE AUTHORS DO NOT WARRANT THE SOFTWARE WILL RUN UNINTERRUPTED OR ERROR FREE. LIMITED LIABILITY THE ENTIRE RISK AS TO RESULTS AND PERFORMANCE OF THE SOFTWARE IS ASSUMED BY YOU. UNDER NO CIRCUMSTANCES WILL THE AUTHORS BE LIABLE FOR ANY SPECIAL, INDIRECT, INCIDENTAL, EXEMPLARY OR CONSEQUENTIAL DAMAGES OF ANY KIND OR NATURE WHATSOEVER, WHETHER BASED ON CONTRACT, WARRANTY, TORT (INCLUDING NEGLIGENCE), STRICT LIABILITY OR OTHERWISE, ARISING OUT OF OR IN ANY WAY RELATED TO THE SOFTWARE, EVEN IF THE AUTHORS HAVE BEEN ADVISED ON THE POSSIBILITY OF SUCH DAMAGE OR IF SUCH DAMAGE COULD HAVE BEEN REASONABLY FORESEEN, AND NOTWITHSTANDING ANY FAILURE OF ESSENTIAL PURPOSE OF ANY EXCLUSIVE REMEDY PROVIDED. SUCH LIMITATION ON DAMAGES INCLUDES, BUT IS NOT LIMITED TO, DAMAGES FOR LOSS OF GOODWILL, LOST PROFITS, LOSS OF DATA OR SOFTWARE, WORK STOPPAGE, COMPUTER FAILURE OR MALFUNCTION OR IMPAIRMENT OF OTHER GOODS. IN NO EVENT WILL THE AUTHORS BE LIABLE FOR THE COSTS OF PROCUREMENT OF SUBSTITUTE SOFTWARE OR SERVICES. YOU

ACKNOWLEDGE THAT THIS SOFTWARE IS NOT DESIGNED FOR USE IN ON-LINE EQUIPMENT IN HAZARDOUS ENVIRONMENTS SUCH AS OPERATION OF NUCLEAR FACILITIES, AIRCRAFT NAVIGATION OR CONTROL, OR LIFE-CRITICAL APPLICATIONS. THE AUTHORS EXPRESSLY DISCLAIM ANY LIABILITY RESULTING FROM USE OF THE SOFTWARE IN ANY SUCH ON-LINE EQUIPMENT IN HAZARDOUS ENVIRONMENTS AND ACCEPTS NO LIABILITY IN RESPECT OF ANY ACTIONS OR CLAIMS BASED ON THE USE OF THE SOFTWARE IN ANY SUCH ON-LINE EQUIPMENT IN HAZARDOUS ENVIRONMENTS BY YOU. FOR PURPOSES OF THIS PARAGRAPH, THE TERM "LIFE-CRITICAL APPLICATION" MEANS AN APPLICATION IN WHICH THE FUNCTIONING OR MALFUNCTIONING OF THE SOFTWARE MAY RESULT DIRECTLY OR INDIRECTLY IN PHYSICAL INJURY OR LOSS OF HUMAN LIFE. THIS DISCLAIMER OF WARRANTY CONSTITUTES AN ESSENTIAL PART OF THIS LICENSE. NO USE OF ANY COVERED CODE IS AUTHORIZED HEREUNDER EXCEPT UNDER THIS DISCLAIMER.

#### 8. TERMINATION.

##### 8.1.

This License and the rights granted hereunder will terminate automatically if You fail to comply with terms herein and fail to cure such breach within 30 days of becoming aware of the breach. All sublicenses to the Covered Code which are properly granted shall survive any termination of this License. Provisions which, by their nature, must remain in effect beyond the termination of this License shall survive.

##### 8.2.

##### 8.3.

If You assert a patent infringement claim against Participant alleging that such Participant's Contributor Version directly or indirectly infringes any patent where such claim is resolved (such as by license or settlement) prior to the initiation of patent infringement litigation, then the reasonable value of the licenses granted by such Participant under Sections 2.1 or 2.2 shall be taken into account in determining the amount or value of any payment or license.

##### 8.4.

In the event of termination under Sections 8.1 or 8.2 above, all end user license agreements (excluding distributors and resellers) which have been validly granted by You or any distributor hereunder prior to termination shall survive termination.

#### 9. LIMITATION OF LIABILITY.

UNDER NO CIRCUMSTANCES AND UNDER NO LEGAL THEORY, WHETHER TORT (INCLUDING NEGLIGENCE), CONTRACT, OR OTHERWISE, SHALL YOU, THE INITIAL DEVELOPER, ANY OTHER CONTRIBUTOR, OR ANY DISTRIBUTOR OF COVERED CODE, OR ANY SUPPLIER OF ANY OF SUCH PARTIES, BE LIABLE TO ANY PERSON FOR ANY INDIRECT, SPECIAL, INCIDENTAL, OR CONSEQUENTIAL DAMAGES OF ANY CHARACTER INCLUDING, WITHOUT LIMITATION, DAMAGES FOR LOSS OF GOODWILL, WORK STOPPAGE, COMPUTER FAILURE OR MALFUNCTION, OR ANY AND ALL OTHER COMMERCIAL DAMAGES OR LOSSES, EVEN IF SUCH PARTY SHALL HAVE BEEN INFORMED OF THE POSSIBILITY OF SUCH DAMAGES. THIS LIMITATION OF LIABILITY SHALL NOT APPLY TO LIABILITY FOR DEATH OR PERSONAL INJURY RESULTING FROM SUCH PARTY'S NEGLIGENCE TO THE EXTENT APPLICABLE LAW PROHIBITS SUCH LIMITATION. SOME JURISDICTIONS DO NOT ALLOW THE EXCLUSION OR LIMITATION OF INCIDENTAL OR CONSEQUENTIAL DAMAGES. SO THIS EXCLUSION AND LIMITATION MAY NOT APPLY TO YOU.

#### 10. U.S. GOVERNMENT END USERS.

#### 11. MISCELLANEOUS.

#### 12. RESPONSIBILITY FOR CLAIMS.

As between Initial Developer and the Contributors, each party is responsible for claims and damages arising, directly or indirectly, out of its utilization of rights under this License and You agree to work with Initial Developer and Contributors to distribute such responsibility on an equitable basis. Nothing herein is intended or shall be deemed to constitute any admission of liability.

#### EXHIBIT A.

"The contents of this file are subject to the gSOAP Public License Version 1.3 (the "License"); you may not use this file except in compliance with the License. You may obtain a copy of the License at <http://www.cs.fsu.edu/~engelen/soaplicense.html>

Software distributed under the License is distributed on an "AS IS" basis, WITHOUT WARRANTY OF ANY KIND, either express or implied. See the License for the specific language governing rights and limitations under the License.

The Original Code of the gSOAP Software is: stdsoap.h, stdsoap2.h, stdsoap.c, stdsoap2.c, stdsoap.cpp, stdsoap2.epp, soapcpp2.h, soapcpp2.c, soapcpp2\_lex.l, soapcpp2\_yacc.y, error2.h, error2.c, symbol2.c, init2.c, soapdoc2.html, and soapdoc2.pdf, httpget.h, httpget.c, stl.h, stldeque.h, stllist.h, stlvector.h, stlset.h.

The Initial Developer of the Original Code is Robert A. van Engelen. Portions created by Robert A. van Engelen are

Copyright (C) 2001-2004 Robert A. van Engelen, Genivia inc. All Rights Reserved. Contributor(s):

"\_\_\_\_\_".

[Note: The text of this Exhibit A may differ slightly from the text of the notices in the Source Code files of the Original code. You should use the text of this Exhibit A rather than the text found in the Original Code Source Code for Your Modifications.]

#### EXHIBIT B.

"Part of the software embedded in this product is gSOAP software.

Portions created by gSOAP are Copyright (C) 2001-2009 Robert A. van Engelen, Genivia inc. All Rights Reserved. THE SOFTWARE IN THIS PRODUCT WAS IN PART PROVIDED BY GENIVIA INC AND ANY EXPRESS OR IMPLIED WARRANTIES, INCLUDING, BUT NOT LIMITED TO, THE IMPLIED WARRANTIES OF MERCHANTABILITY AND FITNESS FOR A PARTICULAR PURPOSE ARE DISCLAIMED. IN NO EVENT SHALL THE AUTHOR BE LIABLE FOR ANY DIRECT, INDIRECT, INCIDENTAL, SPECIAL, EXEMPLARY, OR CONSEQUENTIAL DAMAGES (INCLUDING, BUT NOT LIMITED TO, PROCUREMENT OF SUBSTITUTE GOODS OR SERVICES; LOSS OF USE, DATA, OR PROFITS; OR BUSINESS INTERRUPTION) HOWEVER CAUSED AND ON ANY THEORY OF LIABILITY, WHETHER IN CONTRACT, STRICT LIABILITY, OR TORT (INCLUDING NEGLIGENCE OR OTHERWISE) ARISING IN ANY WAY OUT OF THE USE OF THIS SOFTWARE, EVEN IF ADVISED OF THE POSSIBILITY OF SUCH DAMAGE."

## ■ About gcc libgcc, gcc libstdc++

### GNU GENERAL PUBLIC LICENSE

Version 3, 29 June 2007

Copyright (C) 2007 Free Software Foundation, Inc. <<http://fsf.org/>>

Everyone is permitted to copy and distribute verbatim copies of this license document, but changing it is not allowed.

#### Preamble

The GNU General Public License is a free, copyleft license for software and other kinds of works.

The licenses for most software and other practical works are designed to take away your freedom to share and change the works. By contrast, the GNU General Public License is intended to guarantee your freedom to share and change all versions of a program—to make sure it remains free software for all its users. We, the Free Software Foundation, use the GNU General Public License for most of our software; it applies also to any other work released this way by its authors. You can apply it to your programs, too.

When we speak of free software, we are referring to freedom, not price. Our General Public Licenses are designed to make sure that you have the freedom to distribute copies of free software (and charge for them if you wish), that you receive source code or can get it if you want it, that you can change the software or use pieces of it in new free programs, and that you know you can do these things.

To protect your rights, we need to prevent others from denying you these rights or asking you to surrender the rights. Therefore, you have certain responsibilities if you distribute copies of the software, or if you modify it: responsibilities to respect the freedom of others.

For example, if you distribute copies of such a program, whether gratis or for a fee, you must pass on to the recipients the same freedoms that you received. You must make sure that they, too, receive or can get the source code. And you must show them these terms so they know their rights.

Developers that use the GNU GPL protect your rights with two steps:

(1) assert copyright on the software, and (2) offer you this License giving you legal permission to copy, distribute and/or modify it.

For the developers' and authors' protection, the GPL clearly explains that there is no warranty for this free software. For both users' and authors' sake, the GPL requires that modified versions be marked as changed, so that their problems will not be attributed erroneously to authors of previous versions.

Some devices are designed to deny users access to install or run modified versions of the software inside them, although the manufacturer can do so. This is fundamentally incompatible with the aim of protecting users' freedom to change the software. The systematic pattern of such abuse occurs in the area of products for individuals to use, which is precisely where it is most unacceptable. Therefore, we have designed this version of the GPL to prohibit the practice for those products. If such problems arise substantially in other domains, we stand ready to extend this provision to those domains in future versions of the GPL, as needed to protect the freedom of users.

Finally, every program is threatened constantly by software patents. States should not allow patents to restrict development and use of software on general-purpose computers, but in those that do, we wish to avoid the special danger that patents applied to a free program could make it effectively proprietary. To prevent this, the GPL assures that patents cannot be used to render the program non-free.

The precise terms and conditions for copying, distribution and modification follow.

### TERMS AND CONDITIONS

#### 0. Definitions.

"This License" refers to version 3 of the GNU General Public License.

"Copyright" also means copyright-like laws that apply to other kinds of works, such as semiconductor masks.

"The Program" refers to any copyrightable work licensed under this License. Each licensee is addressed as "you". "Licensees" and "recipients" may be individuals or organizations.

To "modify" a work means to copy from or adapt all or part of the work in a fashion requiring copyright permission, other than the making of an exact copy. The resulting work is called a "modified version" of the earlier work or a work "based on" the earlier work.

A "covered work" means either the unmodified Program or a work based on the Program.

To "propagate" a work means to do anything with it that, without permission, would make you directly or secondarily liable for infringement under applicable copyright law, except executing it on a computer or modifying a private copy. Propagation includes copying, distribution (with or without modification), making available to the public, and in some countries other activities as well.

To "convey" a work means any kind of propagation that enables other parties to make or receive copies. Mere interaction with a user through a computer network, with no transfer of a copy, is not conveying.

An interactive user interface displays "Appropriate Legal Notices" to the extent that it includes a convenient and prominently visible feature that (1) displays an appropriate copyright notice, and (2) tells the user that there is no warranty for the work (except to the extent that warranties are provided), that licensees may convey the work under this License, and how to view a copy of this License. If the interface presents a list of user commands or options, such as a menu, a prominent item in the list meets this criterion.

#### 1. Source Code.

The "source code" for a work means the preferred form of the work for making modifications to it. "Object code" means any non-source form of a work.

A "Standard Interface" means an interface that either is an official standard defined by a recognized standards body, or, in the case of interfaces specified for a particular programming language, one that is widely used among developers working in that language.

The "System Libraries" of an executable work include anything, other than the work as a whole, that (a) is included in the normal form of packaging a Major Component, but which is not part of that Major Component, and (b) serves only to enable use of the work with that Major Component, or to implement a Standard Interface for which an implementation is available to the public in source code form. A "Major Component", in this context, means a major essential component (kernel, window system, and so on) of the specific operating system (if any) on which the executable work runs, or a compiler used to produce the work, or an object code interpreter used to run it.

The "Corresponding Source" for a work in object code form means all the source code needed to generate, install, and (for an executable work) run the object code and to modify the work, including scripts to control those activities. However, it does not include the work's System Libraries, or general-purpose tools or generally available free programs which are used unmodified in performing those activities but which are not part of the work. For example, Corresponding Source includes interface definition files associated with source files for the work, and the source code for shared libraries and dynamically linked subprograms that the work is specifically designed to require, such as by intimate data communication or control flow between those subprograms and other parts of the work.

The Corresponding Source need not include anything that users can regenerate automatically from other parts of the Corresponding Source.

The Corresponding Source for a work in source code form is that same work.

#### 2. Basic Permissions.

All rights granted under this License are granted for the term of copyright on the Program, and are irrevocable provided the stated conditions are met. This License explicitly affirms your unlimited permission to run the unmodified Program. The output from running a covered work is covered by this License only if the output, given its content, constitutes a covered work. This License acknowledges your rights of fair use or other equivalent, as provided by copyright law.

You may make, run and propagate covered works that you do not convey, without conditions so long as your license otherwise remains in force. You may convey covered works to others for the sole purpose of having them make modifications exclusively for you, or provide you with facilities for running those works, provided that you comply with the terms of this License in conveying all material for which you do not control copyright. Those thus making or running the covered works for you must do so exclusively on your behalf, under your direction and control, on terms that prohibit them from making any copies of your copyrighted material outside their relationship with you.

Conveying under any other circumstances is permitted solely under the conditions stated below. Sublicensing is not allowed; section 10 makes it unnecessary.

#### 3. Protecting Users' Legal Rights From Anti-Circumvention Law.

No covered work shall be deemed part of an effective technological measure under any applicable law fulfilling obligations under article 11 of the WIPO copyright treaty adopted on 20 December 1996, or similar laws prohibiting or restricting circumvention of such measures.

When you convey a covered work, you waive any legal power to forbid circumvention of technological measures to the extent such circumvention is effected by exercising rights under this License with respect to the covered work, and you disclaim any intention to limit operation or modification of the work as a means of enforcing, against the work's users, your or third parties' legal rights to forbid circumvention of technological measures.

#### 4. Conveying Verbatim Copies.



You may convey verbatim copies of the Program's source code as you receive it, in any medium, provided that you conspicuously and appropriately publish on each copy an appropriate copyright notice; keep intact all notices stating that this License and any non-permissive terms added in accord with section 7 apply to the code; keep intact all notices of the absence of any warranty; and give all recipients a copy of this License along with the Program.

You may charge any price or no price for each copy that you convey, and you may offer support or warranty protection for a fee.

#### 5. Conveying Modified Source Versions.

You may convey a work based on the Program, or the modifications to produce it from the Program, in the form of source code under the terms of section 4, provided that you also meet all of these conditions:

a) The work must carry prominent notices stating that you modified it, and giving a relevant date.

b) The work must carry prominent notices stating that it is released under this License and any conditions added under section

#### 7. This requirement modifies the requirement in section 4 to "keep intact all notices".

c) You must license the entire work, as a whole, under this License to anyone who comes into possession of a copy. This License will therefore apply, along with any applicable section 7 additional terms, to the whole of the work, and all its parts, regardless of how they are packaged. This License gives no permission to license the work in any other way, but it does not invalidate such permission if you have separately received it.

d) If the work has interactive user interfaces, each must display Appropriate Legal Notices; however, if the Program has interactive interfaces that do not display Appropriate Legal Notices, your work need not make them do so.

A compilation of a covered work with other separate and independent works, which are not by their nature extensions of the covered work, and which are not combined with it such as to form a larger program, in or on a volume of a storage or distribution medium, is called an "aggregate" if the compilation and its resulting copyright are not used to limit the access or legal rights of the compilation's users beyond what the individual works permit. Inclusion of a covered work in an aggregate does not cause this License to apply to the other parts of the aggregate.

#### 6. Conveying Non-Source Forms.

You may convey a covered work in object code form under the terms of sections 4 and 5, provided that you also convey the machine-readable Corresponding Source under the terms of this License, in one of these ways:

a) Convey the object code in, or embodied in, a physical product (including a physical distribution medium), accompanied by the Corresponding Source fixed on a durable physical medium customarily used for software interchange.

b) Convey the object code in, or embodied in, a physical product (including a physical distribution medium), accompanied by a written offer, valid for at least three years and valid for as long as you offer spare parts or customer support for that product model, to give anyone who possesses the object code either (1) a copy of the Corresponding Source for all the software in the product that is covered by this License, on a durable physical medium customarily used for software interchange, for a price no more than your reasonable cost of physically performing this conveying of source, or (2) access to copy the Corresponding Source from a network server at no charge.

c) Convey individual copies of the object code with a copy of the written offer to provide the Corresponding Source. This alternative is allowed only occasionally and noncommercially, and only if you received the object code with such an offer, in accord with subsection 6b.

d) Convey the object code by offering access from a designated place (gratis or for a charge), and offer equivalent access to the Corresponding Source in the same way through the same place at no further charge. You need not require recipients to copy the Corresponding Source along with the object code. If the place to copy the object code is a network server, the Corresponding Source may be on a different server (operated by you or a third party) that supports equivalent copying facilities, provided you maintain clear directions next to the object code saying where to find the Corresponding Source. Regardless of what server hosts the Corresponding Source, you remain obligated to ensure that it is available for as long as needed to satisfy these requirements.

e) Convey the object code using peer-to-peer transmission, provided you inform other peers where the object code and Corresponding Source of the work are being offered to the general public at no charge under subsection 6d.

A separable portion of the object code, whose source code is excluded from the Corresponding Source as a System Library, need not be included in conveying the object code work.

A "User Product" is either (1) a "consumer product", which means any tangible personal property which is normally used for personal, family, or household purposes, or (2) anything designed or sold for incorporation into a dwelling. In determining whether a product is a consumer product, doubtful cases shall be resolved in favor of coverage. For a particular product received by a particular user, "normally used" refers to a typical or common use of that class of product, regardless of the status of the particular user or of the way in which the particular user actually uses, or expects or is expected to use, the product. A product is a consumer product regardless of whether the product has substantial commercial, industrial or non-consumer uses, unless such uses represent the only significant mode of use of the product.

"Installation Information" for a User Product means any methods, procedures, authorization keys, or other information required to install and execute modified versions of a covered work in that User Product from a modified version of its Corresponding Source. The information must suffice to ensure that the continued functioning of the modified object code is in no case prevented or interfered with solely because modification has been made.

If you convey an object code work under this section in, or with, or specifically for use in, a User Product, and the conveying occurs as part of a transaction in which the right of possession and use of the User Product is transferred to the recipient in perpetuity or for a fixed term (regardless of how the transaction is characterized), the Corresponding Source conveyed under this section must be accompanied by the Installation Information. But this requirement does not apply if neither you nor any third party retains the ability to install modified object code on the User Product (for example, the work has been installed in ROM).

The requirement to provide Installation Information does not include a requirement to continue to provide support service, warranty, or updates for a work that has been modified or installed by the recipient, or for the User Product in which it has been modified or installed. Access to a network may be denied when the modification itself materially and adversely affects the operation of the network or violates the rules and protocols for communication across the network.

Corresponding Source conveyed, and Installation Information provided, in accord with this section must be in a format that is publicly documented (and with an implementation available to the public in source code form), and must require no special password or key for unpacking, reading or copying.

#### 7. Additional Terms.

"Additional permissions" are terms that supplement the terms of this License by making exceptions from one or more of its conditions. Additional permissions that are applicable to the entire Program shall be treated as though they were included in this License, to the extent that they are valid under applicable law. If additional permissions apply only to part of the Program, that part may be used separately under those permissions, but the entire Program remains governed by this License without regard to the additional permissions.

When you convey a copy of a covered work, you may at your option remove any additional permissions from that copy, or from any part of it. (Additional permissions may be written to require their own removal in certain cases when you modify the work.) You may place additional permissions on material, added by you to a covered work, for which you have or can give appropriate copyright permission.

Notwithstanding any other provision of this License, for material you add to a covered work, you may (if authorized by the copyright holders of that material) supplement the terms of this License with terms:

a) Disclaiming warranty or limiting liability differently from the terms of sections 15 and 16 of this License; or

b) Requiring preservation of specified reasonable legal notices or author attributions in that material or in the Appropriate Legal Notices displayed by works containing it; or

c) Prohibiting misrepresentation of the origin of that material, or requiring that modified versions of such material be marked in reasonable ways as different from the original version; or

d) Limiting the use for publicity purposes of names of licensors or authors of the material; or

e) Declining to grant rights under trademark law for use of some trade names, trademarks, or service marks; or

f) Requiring indemnification of licensors and authors of that material by anyone who conveys the material (or modified versions of it) with contractual assumptions of liability to the recipient, for any liability that these contractual assumptions directly impose on those licensors and authors.

All other non-permissive additional terms are considered "further restrictions" within the meaning of section 10. If the Program as you received it, or any part of it, contains a notice stating that it is governed by this License along with a term that is a further restriction, you may remove that term. If a license document contains a further restriction but permits relicensing or conveying under this License, you may add to a covered work material governed by the terms of that license document, provided that the further restriction does not survive such relicensing or conveying.

If you add terms to a covered work in accord with this section, you must place, in the relevant source files, a statement of the additional terms that apply to those files, or a notice indicating where to find the applicable terms.

Additional terms, permissive or non-permissive, may be stated in the form of a separately written license, or stated as exceptions; the above requirements apply either way.

#### 8. Termination.

You may not propagate or modify a covered work except as expressly provided under this License. Any attempt otherwise to propagate or modify it is void, and will automatically terminate your rights under this License (including any patent licenses granted under the third paragraph of section 11).

However, if you cease all violation of this License, then your license from a particular copyright holder is reinstated (a) provisionally, unless and until the copyright holder explicitly and finally terminates your license, and (b) permanently, if the copyright holder fails to notify you of the violation by some reasonable means prior to 60 days after the cessation.

Moreover, your license from a particular copyright holder is reinstated permanently if the copyright holder notifies you of the violation by some reasonable means, this is the first time you have received notice of violation of this License (for any work) from that copyright holder, and you cure the violation prior to 30 days after your receipt of the notice.

Termination of your rights under this section does not terminate the licenses of parties who have received copies or rights from you under this License. If your rights have been terminated and not permanently reinstated, you do not qualify to receive new licenses for the same material under section 10.

#### 9. Acceptance Not Required for Having Copies.

You are not required to accept this License in order to receive or run a copy of the Program. Ancillary propagation of a covered work occurring solely as a consequence of using peer-to-peer transmission to receive a copy likewise does not require acceptance. However, nothing other than this License grants you permission to propagate or modify any covered work. These actions infringe copyright if you do not accept this License. Therefore, by modifying or propagating a covered work, you indicate your acceptance of this License to do so.

#### 10. Automatic Licensing of Downstream Recipients.

Each time you convey a covered work, the recipient automatically receives a license from the original licensors, to run, modify and propagate that work, subject to this License. You are not responsible for enforcing compliance by third parties with this License.

An "entity transaction" is a transaction transferring control of an organization, or substantially all assets of one, or subdividing an organization, or merging organizations. If propagation of a covered work results from an entity transaction, each party to that transaction who receives a copy of the work also receives whatever licenses to the work the party's predecessor in interest had or could give under the previous paragraph, plus a right to possession of the Corresponding Source of the work from the predecessor in interest, if the predecessor has it or can get it with reasonable efforts.

You may not impose any further restrictions on the exercise of the rights granted or affirmed under this License. For example, you may not impose a license fee, royalty, or other charge for exercise of rights granted under this License, and you may not initiate litigation (including a cross-claim or counterclaim in a lawsuit) alleging that any patent claim is infringed by making, using, selling, offering for sale, or importing the Program or any portion of it.

#### 11. Patents.

A "contributor" is a copyright holder who authorizes use under this License of the Program or a work on which the Program is based. The work thus licensed is called the contributor's "contributor version".

A contributor's "essential patent claims" are all patent claims owned or controlled by the contributor, whether already acquired or hereafter acquired, that would be infringed by some manner, permitted by this License, of making, using, or selling its contributor version, but do not include claims that would be infringed only as a consequence of further modification of the contributor version. For purposes of this definition, "control" includes the right to grant patent sublicenses in a manner consistent with the requirements of this License.

Each contributor grants you a non-exclusive, worldwide, royalty-free patent license under the contributor's essential patent claims, to make, use, sell, offer for sale, import and otherwise run, modify and propagate the contents of its contributor version.

In the following three paragraphs, a "patent license" is any express agreement or commitment, however denominated, not to enforce a patent (such as an express permission to practice a patent or covenant not to sue for patent infringement). To "grant" such a patent license to a party means to make such an agreement or commitment not to enforce a patent against the party.

If you convey a covered work, knowingly relying on a patent license, and the Corresponding Source of the work is not available for anyone to copy, free of charge and under the terms of this License, through a publicly available network server or other readily accessible means, then you must either (1) cause the Corresponding Source to be so available, or (2) arrange to deprive yourself of the benefit of the patent license for this particular work, or (3) arrange, in a manner consistent with the requirements of this License, to extend the patent license to downstream recipients. "Knowingly relying" means you have actual knowledge that, but for the patent license, your conveying the covered work in a country, or your recipient's use of the covered work in a country, would infringe one or more identifiable patents in that country that you have reason to believe are valid.

If, pursuant to or in connection with a single transaction or arrangement, you convey, or propagate by procuring conveyance of, a covered work, and grant a patent license to some of the parties receiving the covered work authorizing them to use, propagate, modify or convey a specific copy of the covered work, then the patent license you grant is automatically extended to all recipients of the covered work and works based on it.

A patent license is "discriminatory" if it does not include within the scope of its coverage, prohibits the exercise of, or is conditioned on the non-exercise of one or more of the rights that are specifically granted under this License. You may not convey a covered work if you are a party to an arrangement with a third party that is in the business of distributing software, under which you make payment to the third party based on the extent of your activity of conveying the work, and under which the third party grants, to any of the parties who would receive the covered work from you, a discriminatory patent license (a) in connection with copies of the covered work conveyed by you (or copies made from those copies), or (b) primarily for and in connection with specific products or compilations that contain the covered work, unless you entered into that arrangement, or that patent license was granted, prior to 28 March 2007.

Nothing in this License shall be construed as excluding or limiting any implied license or other defenses to infringement that may otherwise be available to you under applicable patent law.

#### 12. No Surrender of Others' Freedom.

If conditions are imposed on you (whether by court order, agreement or otherwise) that contradict the conditions of this License, they do not excuse you from the conditions of this License. If you cannot convey a covered work so as to satisfy simultaneously your obligations under this License and any other pertinent obligations, then as a consequence you may not convey it at all. For example, if you agree to terms that obligate you to collect a royalty for further conveying from those to whom you convey the Program, the only way you could satisfy both those terms and this License would be to refrain entirely from conveying the Program.

#### 13. Use with the GNU Affero General Public License.

Notwithstanding any other provision of this License, you have permission to link or combine any covered work with a work licensed under version 3 of the GNU Affero General Public License into a single combined work, and to convey the resulting work. The terms of this License will continue to apply to the part which is the covered work, but the special requirements of the GNU Affero General Public License, section 13, concerning interaction through a network will apply to the combination as such.

#### 14. Revised Versions of this License.

The Free Software Foundation may publish revised and/or new versions of the GNU General Public License from time to time. Such new versions will be similar in spirit to the present version, but may differ in detail to address new problems or concerns.

Each version is given a distinguishing version number. If the Program specifies that a certain numbered version of the GNU General Public License "or any later version" applies to it, you have the option of following the terms and conditions either of that numbered version or of any later version published by the Free Software Foundation. If the Program does not specify a version number of the GNU General Public License, you may choose any version ever published by the Free Software Foundation.

If the Program specifies that a proxy can decide which future versions of the GNU General Public License can be used, that proxy's public statement of acceptance of a version permanently authorizes you to choose that version for the Program.

Later license versions may give you additional or different permissions. However, no additional obligations are imposed on any author or copyright holder as a result of your choosing to follow a later version.

#### 15. Disclaimer of Warranty.

THERE IS NO WARRANTY FOR THE PROGRAM, TO THE EXTENT PERMITTED BY APPLICABLE LAW. EXCEPT WHEN OTHERWISE STATED IN WRITING THE COPYRIGHT HOLDERS AND/OR OTHER PARTIES PROVIDE THE PROGRAM "AS IS" WITHOUT WARRANTY OF ANY KIND, EITHER EXPRESSED OR IMPLIED, INCLUDING, BUT NOT LIMITED TO, THE IMPLIED WARRANTIES OF MERCHANTABILITY AND FITNESS FOR A PARTICULAR PURPOSE. THE ENTIRE RISK AS TO THE QUALITY AND PERFORMANCE OF THE PROGRAM IS WITH YOU. SHOULD THE PROGRAM PROVE DEFECTIVE, YOU ASSUME THE COST OF ALL NECESSARY SERVICING, REPAIR OR CORRECTION.

#### 16. Limitation of Liability.

IN NO EVENT UNLESS REQUIRED BY APPLICABLE LAW OR AGREED TO IN WRITING WILL ANY COPYRIGHT HOLDER, OR ANY OTHER PARTY WHO MODIFIES AND/OR CONVEYS THE PROGRAM AS PERMITTED ABOVE, BE LIABLE TO YOU FOR DAMAGES, INCLUDING ANY GENERAL, SPECIAL, INCIDENTAL OR CONSEQUENTIAL DAMAGES ARISING OUT OF THE USE OR INABILITY TO USE THE PROGRAM (INCLUDING BUT NOT LIMITED TO LOSS OF DATA OR DATA BEING RENDERED INACCURATE OR LOSSES SUSTAINED BY YOU OR THIRD PARTIES OR A FAILURE OF THE PROGRAM TO OPERATE WITH ANY OTHER PROGRAMS), EVEN IF SUCH HOLDER OR OTHER PARTY HAS BEEN ADVISED OF THE POSSIBILITY OF SUCH DAMAGES.

#### 17. Interpretation of Sections 15 and 16.

If the disclaimer of warranty and limitation of liability provided above cannot be given local legal effect according to their terms, reviewing courts shall apply local law that most closely approximates an absolute waiver of all civil liability in connection with the Program, unless a warranty or assumption of liability accompanies a copy of the Program in return for a fee.

### END OF TERMS AND CONDITIONS

#### How to Apply These Terms to Your New Programs

If you develop a new program, and you want it to be of the greatest possible use to the public, the best way to achieve this is to make it free software which everyone can redistribute and change under these terms.

To do so, attach the following notices to the program. It is safest to attach them to the start of each source file to most effectively state the exclusion of warranty; and each file should have at least the "copyright" line and a pointer to where the full notice is found.

```
<one line to give the program's name and a brief idea of what it does.>
Copyright (C) <year> <name of author>
```

This program is free software; you can redistribute it and/or modify it under the terms of the GNU General Public License as published by the Free Software Foundation, either version 3 of the License, or (at your option) any later version.

This program is distributed in the hope that it will be useful, but WITHOUT ANY WARRANTY; without even the implied warranty of MERCHANTABILITY or FITNESS FOR A PARTICULAR PURPOSE. See the GNU General Public License for more details.

You should have received a copy of the GNU General Public License along with this program. If not, see <<http://www.gnu.org/licenses/>>.

Also add information on how to contact you by electronic and paper mail.

If the program does terminal interaction, make it output a short notice like this when it starts in an interactive mode:

```
<program> Copyright (C) <year> <name of author>
This program comes with ABSOLUTELY NO WARRANTY; for details type `show
w`.
This is free software, and you are welcome to redistribute it under certain conditions;
type `show c` for details.
```

The hypothetical commands `show w` and `show c` should show the appropriate parts of the General Public License. Of course, your program's commands might be different; for a GUI interface, you would use an "about box".

You should also get your employer (if you work as a programmer) or school, if any, to sign a "copyright disclaimer" for the program, if necessary. For more information on this, and how to apply and follow the GNU GPL, see <<http://www.gnu.org/licenses/>>.

The GNU General Public License does not permit incorporating your program into proprietary programs. If your program is a subroutine library, you may consider it more useful to permit linking proprietary applications with the library. If this is what you want to do, use the GNU Lesser General Public License instead of this License. But first, please read <<http://www.gnu.org/philosophy/why-not-lgpl.html>>.

### GCC RUNTIME LIBRARY EXCEPTION

Version 3.1, 31 March 2009  
Copyright © 2009 Free Software Foundation, Inc. <<http://fsf.org/>>

Everyone is permitted to copy and distribute verbatim copies of this license document, but changing it is not allowed.

This GCC Runtime Library Exception ("Exception") is an additional permission under section 7 of the GNU General Public License, version 3 ("GPLv3"). It applies to a given file (the "Runtime Library") that bears a notice placed by the copyright holder of the file stating that the file is governed by GPLv3 along with this Exception.

When you use GCC to compile a program, GCC may combine portions of certain GCC header files and runtime libraries with the compiled program. The purpose of this Exception is to allow compilation of non-GPL (including proprietary) programs to use, in this way, the header files and runtime libraries covered by this Exception.

### 0. Definitions.

A file is an "Independent Module" if it either requires the Runtime Library for execution after a Compilation Process, or makes use of an interface provided by the Runtime Library, but is not otherwise based on the Runtime Library.

"GCC" means a version of the GNU Compiler Collection, with or without modifications, governed by version 3 (or a specified later version) of the GNU General Public License (GPL) with the option of using any subsequent versions published by the FSF.

"GPL-compatible Software" is software whose conditions of propagation, modification and use would permit combination with GCC in accord with the license of GCC.

"Target Code" refers to output from any compiler for a real or virtual target processor architecture, in executable form or suitable for input to an assembler, loader, linker and/or execution phase. Notwithstanding that, Target Code does not include data in any format that is used as a compiler intermediate representation, or used for producing a compiler intermediate representation.

The "Compilation Process" transforms code entirely represented in non-intermediate languages designed for human-written code, and/or in Java Virtual Machine byte code, into Target Code. Thus, for example, use of source code generators and preprocessors need not be considered part of the Compilation Process, since the Compilation Process can be understood as starting with the output of the generators or preprocessors.

A Compilation Process is "Eligible" if it is done using GCC, alone or with other GPL-compatible software, or if it is done without using any work based on GCC. For example, using non-GPL-compatible Software to optimize any GCC intermediate representations would not qualify as an Eligible Compilation Process.

#### 1. Grant of Additional Permission.

You have permission to propagate a work of Target Code formed by combining the Runtime Library with Independent Modules, even if such propagation would otherwise violate the terms of GPLv3, provided that all Target Code was generated by Eligible Compilation Processes. You may then convey such a combination under terms of your choice, consistent with the licensing of the Independent Modules.

#### 2. No Weakening of GCC Copyleft.

The availability of this Exception does not imply any general presumption that third-party software is unaffected by the copyleft requirements of the license of GCC.

### ■ About c-ares

Copyright 1998 by the Massachusetts Institute of Technology.

Permission to use, copy, modify, and distribute this software and its documentation for any purpose and without fee is hereby granted, provided that the above copyright notice appear in all copies and that both that copyright notice and this permission notice appear in supporting documentation, and that the name of M.I.T. not be used in advertising or publicity pertaining to distribution of the software without specific, written prior permission. M.I.T. makes no representations about the suitability of this software for any purpose. It is provided "as is" without express or implied warranty.

### ■ About WPA Supplicant

WPA Supplicant

Copyright (c) 2003-2012, Jouni Malinen <[jam@w1.fi](mailto:jam@w1.fi)> and contributors  
All Rights Reserved.

This program is licensed under the BSD license (the one with advertisement clause removed).

If you are submitting changes to the project, please see CONTRIBUTIONS file for more instructions.

License

This software may be distributed, used, and modified under the terms of BSD license:

Redistribution and use in source and binary forms, with or without modification, are permitted provided that the following conditions are met:

1. Redistributions of source code must retain the above copyright notice, this list of conditions and the following disclaimer.
2. Redistributions in binary form must reproduce the above copyright notice, this list of conditions and the following disclaimer in the documentation and/or other materials provided with the distribution.
3. Neither the name(s) of the above-listed copyright holder(s) nor the names of its contributors may be used to endorse or promote products derived from this software without specific prior written permission.

THIS SOFTWARE IS PROVIDED BY THE COPYRIGHT HOLDERS AND CONTRIBUTORS "AS IS" AND ANY EXPRESS OR IMPLIED WARRANTIES, INCLUDING, BUT NOT LIMITED TO, THE IMPLIED WARRANTIES OF MERCHANTABILITY AND FITNESS FOR A PARTICULAR PURPOSE ARE DISCLAIMED. IN NO EVENT SHALL THE COPYRIGHT OWNER OR CONTRIBUTORS BE LIABLE FOR ANY DIRECT, INDIRECT, INCIDENTAL, SPECIAL, EXEMPLARY, OR CONSEQUENTIAL DAMAGES (INCLUDING, BUT NOT LIMITED TO, PROCUREMENT OF SUBSTITUTE GOODS OR SERVICES; LOSS OF USE, DATA, OR PROFITS; OR BUSINESS INTERRUPTION) HOWEVER CAUSED AND ON ANY THEORY OF LIABILITY, WHETHER IN CONTRACT, STRICT LIABILITY, OR TORT (INCLUDING NEGLIGENCE OR OTHERWISE) ARISING IN ANY WAY OUT OF THE USE OF THIS SOFTWARE, EVEN IF ADVISED OF THE POSSIBILITY OF SUCH DAMAGE.

## ■ About libxml2

Except where otherwise noted in the source code (e.g. the files hash.c, list.c and the trio files, which are covered by a similar licence but with different Copyright notices) all the files are:

Copyright (C) 1998-2003 Daniel Veillard. All Rights Reserved.

Permission is hereby granted, free of charge, to any person obtaining a copy of this software and associated documentation files (the "Software"), to deal in the Software without restriction, including without limitation the rights to use, copy, modify, merge, publish, distribute, sublicense, and/or sell copies of the Software, and to permit persons to whom the Software is furnished to do so, subject to the following conditions:

The above copyright notice and this permission notice shall be included in all copies or substantial portions of the Software.

THE SOFTWARE IS PROVIDED "AS IS", WITHOUT WARRANTY OF ANY KIND, EXPRESS OR IMPLIED, INCLUDING BUT NOT LIMITED TO THE WARRANTIES OF MERCHANTABILITY, FITNESS FOR A PARTICULAR PURPOSE AND NONINFRINGEMENT. IN NO EVENT SHALL THE DANIEL VEILLARD BE LIABLE FOR ANY CLAIM, DAMAGES OR OTHER LIABILITY, WHETHER IN AN ACTION OF CONTRACT, TORT OR OTHERWISE, ARISING FROM, OUT OF OR IN CONNECTION WITH THE SOFTWARE OR THE USE OR OTHER DEALINGS IN THE SOFTWARE.

Except as contained in this notice, the name of Daniel Veillard shall not be used in advertising or otherwise to promote the sale, use or other dealings in this Software without prior written authorization from him.

## ■ About fonts

Fonts are (c) Bitstream (see below). DejaVu changes are in public domain. Glyphs imported from Arev fonts are (c) Tavmjong Bah (see below)

Bitstream Vera Fonts Copyright

Copyright (c) 2003 by Bitstream, Inc. All Rights Reserved. Bitstream Vera is a trademark of Bitstream, Inc.

Permission is hereby granted, free of charge, to any person obtaining a copy of the fonts accompanying this license ("Fonts") and associated documentation files (the "Font Software"), to reproduce and distribute the Font Software, including without limitation the rights to use, copy, merge, publish, distribute, and/or sell copies of the Font Software, and to permit persons to whom the Font Software is furnished to do so, subject to the following conditions:

The above copyright and trademark notices and this permission notice shall be included in all copies of one or more of the Font Software typefaces.

The Font Software may be modified, altered, or added to, and in particular the designs of glyphs or characters in the Fonts may be modified and additional glyphs or characters may be added to the Fonts, only if the fonts are renamed to names not containing either the words "Bitstream" or the word "Vera".

This License becomes null and void to the extent applicable to Fonts or Font Software that has been modified and is distributed under the "Bitstream Vera" names.

The Font Software may be sold as part of a larger software package but no copy of one or more of the Font Software typefaces may be sold by itself.

THE FONT SOFTWARE IS PROVIDED "AS IS", WITHOUT WARRANTY OF ANY KIND, EXPRESS OR IMPLIED, INCLUDING BUT NOT LIMITED TO ANY WARRANTIES OF MERCHANTABILITY, FITNESS FOR A PARTICULAR PURPOSE AND NONINFRINGEMENT OF COPYRIGHT, PATENT, TRADEMARK, OR OTHER RIGHT. IN NO EVENT SHALL BITSTREAM OR THE GNOME FOUNDATION BE LIABLE FOR ANY CLAIM, DAMAGES OR OTHER LIABILITY, INCLUDING ANY GENERAL, SPECIAL, INDIRECT, INCIDENTAL, OR CONSEQUENTIAL DAMAGES, WHETHER IN AN ACTION OF CONTRACT, TORT OR OTHERWISE, ARISING FROM, OUT OF THE USE OR INABILITY TO USE THE FONT SOFTWARE OR FROM OTHER DEALINGS IN THE FONT SOFTWARE.

Except as contained in this notice, the names of Gnome, the Gnome Foundation, and Bitstream Inc., shall not be used in advertising or otherwise to promote the sale, use or other dealings in this Font Software without prior written authorization from the Gnome Foundation or Bitstream Inc., respectively. For further information, contact: fonts at gnome dot org.

Arev Fonts Copyright

Copyright (c) 2006 by Tavmjong Bah. All Rights Reserved.

Permission is hereby granted, free of charge, to any person obtaining a copy of the fonts accompanying this license ("Fonts") and associated documentation files (the "Font Software"), to reproduce and distribute the modifications to the Bitstream Vera Font Software, including without limitation the rights to use, copy, merge, publish, distribute, and/or sell copies of the Font Software, and to permit persons to whom the Font Software is furnished to do so, subject to the following conditions:

The above copyright and trademark notices and this permission notice shall be included in all copies of one or more of the Font Software typefaces.

The Font Software may be modified, altered, or added to, and in particular the designs of glyphs or characters in the Fonts may be modified and additional glyphs or characters may be added to the Fonts, only if the fonts are renamed to names not containing either the words "Tavmjong Bah" or the word "Arev".

This License becomes null and void to the extent applicable to Fonts or Font Software that has been modified and is distributed under the "Tavmjong Bah Arev" names.

The Font Software may be sold as part of a larger software package but no copy of one or more of the Font Software typefaces may be sold by itself.

THE FONT SOFTWARE IS PROVIDED "AS IS", WITHOUT WARRANTY OF ANY KIND, EXPRESS OR IMPLIED, INCLUDING BUT NOT LIMITED TO ANY WARRANTIES OF MERCHANTABILITY, FITNESS FOR A PARTICULAR PURPOSE AND NONINFRINGEMENT OF COPYRIGHT, PATENT, TRADEMARK, OR OTHER RIGHT. IN NO EVENT SHALL TAVMJONG BAH BE LIABLE FOR ANY CLAIM, DAMAGES OR OTHER LIABILITY, INCLUDING ANY GENERAL, SPECIAL, INDIRECT, INCIDENTAL, OR CONSEQUENTIAL DAMAGES, WHETHER IN AN ACTION OF CONTRACT, TORT OR OTHERWISE, ARISING FROM, OUT OF THE USE OR INABILITY TO USE THE FONT SOFTWARE OR FROM OTHER DEALINGS IN THE FONT SOFTWARE.

Except as contained in this notice, the name of Tavmjong Bah shall not be used in advertising or otherwise to promote the sale, use or other dealings in this Font Software without prior written authorization from Tavmjong Bah. For further information, contact: tavmjong @ free. fr.

## Information for Users on Collection and Disposal of Old Equipment and Used Batteries



These symbols on the products, packaging, and/or accompanying documents mean that used electrical and electronic products and batteries should not be mixed with general household waste. For proper treatment, recovery and recycling of old products and used batteries, please take them to applicable collection points, in accordance with your national legislation and the Directives 2002/96/EC and 2006/66/EC.



By disposing of these products and batteries correctly, you will help to save valuable resources and prevent any potential negative effects on human health and the environment which could otherwise arise from inappropriate waste handling.



For more information about collection and recycling of old products and batteries, please contact your local municipality, your waste disposal service or the point of sale where you purchased the items.

### [Information on Disposal in other Countries outside the European Union]

These symbols are only valid in the European Union. If you wish to discard these items, please contact your local authorities or dealer and ask for the correct method of disposal.



### Note for the battery symbol (bottom two symbol examples):

This symbol might be used in combination with a chemical symbol. In this case it complies with the requirement set by the Directive for the chemical involved.

**Pb**

## Information concernant la Collecte et le Traitement des piles usagées et des déchets d'équipements électriques et électroniques



Les symboles sur les produits, l'emballage et/ou les documents joints signifient que les produits électriques ou électroniques usagés ainsi que les piles ne doivent pas être mélangés avec les déchets domestiques habituels.

Pour un traitement, une récupération et un recyclage appropriés des déchets d'équipements électriques et électroniques et des piles usagées, veuillez les déposer aux points de collecte prévus à cet effet, conformément à la réglementation nationale et aux Directives 2002/96/EC et 2006/66/EC.



En vous débarrassant correctement des déchets d'équipements électriques et électroniques et des piles usagées, vous contribuerez à la sauvegarde de précieuses ressources et à la prévention de potentiels effets négatifs sur la santé humaine qui pourraient advenir lors d'un traitement inapproprié des déchets.



Pour plus d'informations à propos de la collecte et du recyclage des déchets d'équipements électriques et électroniques et des piles usagées, veuillez contacter votre municipalité, votre service de traitement des déchets ou le point de vente où vous avez acheté les produits.

### [Information sur le traitement dans d'autres pays en dehors de l'Union Européenne]

Ces symboles sont seulement valables dans l'Union Européenne. Si vous souhaitez vous débarrasser de déchets d'équipements électriques et électroniques ou de piles usagées, veuillez contacter les autorités locales ou votre fournisseur et demander la méthode de traitement appropriée.



**Pb**

### Note pour le symbole "pile" (deux exemples de symbole ci-dessous):

Ce symbole peut être utilisé en combinaison avec un symbole chimique. Dans ce cas il respecte les exigences établies par la Directive pour le produit chimique en question.

## Verbraucherinformation zur Sammlung und Entsorgung alter Elektrogeräte und benutzter Batterien

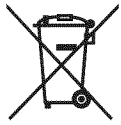

Befinden sich diese Symbole auf den Produkten, der Verpackung und/oder beiliegenden Unterlagen, so sollten benutzte elektrische Geräte und Batterien nicht mit dem normalen Haushaltsabfall entsorgt werden. In Übereinstimmung mit Ihren nationalen Bestimmungen und den Richtlinien 2002/96/EC und 2006/66/EC, bringen Sie alte Geräte und benutzte Batterien bitte zur fachgerechten Entsorgung, Wiederaufbereitung und Wiederverwendung zu den entsprechenden Sammelstellen.



Durch die fachgerechte Entsorgung der Elektrogeräte und Batterien helfen Sie, wertvolle Ressourcen zu schützen und verhindern mögliche negative Auswirkungen auf die menschliche Gesundheit und die Umwelt, die andernfalls durch unsachgerechte Müllentsorgung auftreten könnten.



Für weitere Informationen zum Sammeln und Wiederaufbereiten alter Elektrogeräte und Batterien, kontaktieren Sie bitte Ihre örtliche Stadt- oder Gemeindeverwaltung, Ihren Abfallentsorgungsdienst oder die Verkaufsstelle der Artikel.



### [Entsorgungsinformation für Länder außerhalb der Europäischen Union]

Diese Symbole gelten nur innerhalb der Europäischen Union. Wenn Sie solche Artikel ausrangieren möchten, kontaktieren Sie bitte Ihre örtlichen Behörden oder Ihren Händler und fragen Sie nach der sachgerechten Entsorgungsmethode.

**Pb**

### Anmerkung zum Batteriesymbol (untere zwei Symbolbeispiele):

Dieses Symbol kann auch in Kombination mit einem chemischen Symbol verwendet werden. In diesem Fall entspricht dies den Anforderungen der Richtlinie zur Verwendung chemischer Stoffe.

## Användarinformation, betröffande insamling och dumpning av gammal utrustning och använda batterier



De symboler, som finns på produkterna, emballaget och/eller bifogade dokument talar om att de använda elektriska och elektroniska produkterna, samt batterierna, inte ska blandas med allmänt hushållsavfall. För rätt handhavande, återställande och återvinning av gamla produkter och gamla batterier, vänligen medtag dessa till lämpliga samlingsplatser, i enlighet med din nationella lagstiftning och direktiven 2002/96/EC samt 2006/66/EC.



Genom att slänga dessa produkter och batterier på rätt sätt, kommer du att hjälpa till att rädda värdefulla resurser och förhindra möjliga negativa effekter på mänsklig hälsa och miljö, vilka i annat fall skulle kunna uppstå, p.g.a. felaktig sophantering.



För mer information om insamling och återvinning av gamla produkter och batterier, vänligen kontakta din lokala kommun, ditt sophanteringsföretag eller inköpsstället för dina varor.

### [Information om sophantering i andra länder utanför EU]

Dessa symboler gäller endast inom EU. Om du vill slänga dessa föremål, vänligen kontakta dina lokala myndigheter eller försäljare och fråga efter det korrekta sättet att slänga dem.



### Kommentar ang. batterisymbolen (de två nedersta symbolexemplen):

Denna symbol kan komma att användas i kombination med en kemisk symbol. I detta fall överensstämmer den med de krav, som har ställts genom direktiven för den aktuella kemikalien.

**Pb**

## Informazioni per gli utenti sulla raccolta e lo smaltimento di vecchia attrezzatura e batterie usate



Questi simboli sui prodotti, sull'imballaggio, e/o sui documenti che li accompagnano significano che i prodotti e le batterie elettriche e elettroniche non dovrebbero essere mischiati con i rifiuti domestici generici.

Per il trattamento, recupero e riciclaggio appropriati di vecchi prodotti e batterie usate, li porti, prego, ai punti di raccolta appropriati, in accordo con la Sua legislazione nazionale e le direttive 2002/96/CE e 2006/66/CE.



Smaltendo correttamente questi prodotti e batterie, Lei aiuterà a salvare risorse preziose e a prevenire alcuni potenziali effetti negativi sulla salute umana e l'ambiente, che altrimenti potrebbero sorgere dal trattamento improprio dei rifiuti.

Per ulteriori informazioni sulla raccolta e il riciclaggio di vecchi prodotti e batterie, prego contatti la Sua amministrazione comunale locale, il Suo servizio di smaltimento dei rifiuti o il punto vendita dove Lei ha acquistato gli articoli.



### [Informazioni sullo smaltimento negli altri Paesi al di fuori dell'Unione europea]

Questi simboli sono validi solamente nell'Unione europea. Se Lei desidera disfarsi di questi articoli, prego contatti le Sue autorità locali o il rivenditore e richieda la corretta modalità di smaltimento.

### Noti per il simbolo della batteria (sul fondo due esempi di simbolo):

È probabile che questo simbolo sia usato in combinazione con un simbolo chimico. In questo caso è conforme al requisito stabilito dalla direttiva per gli elementi chimici contenuti.

Pb

## Información para Usuarios sobre Recolección y Disposición de Equipamiento Viejo y Baterías usadas



Estos símbolos en los productos, embalaje, y/o documentación que se acompañe significan que los productos electrónicos y eléctricos usados y las baterías usadas no deben ser mezclados con desechos hogareños corrientes.

Para el tratamiento, recuperación y reciclado apropiado de los productos viejos y las baterías usadas, por favor llévelos a puntos de recolección aplicables, de acuerdo a su legislación nacional y las directivas 2002/96/EC y 2006/66/EC.



Al disponer de estos productos y baterías correctamente, ayudará a ahorrar recursos valiosos y a prevenir cualquier potencial efecto negativo sobre la salud humana y el medio ambiente, el cual podría surgir de un inapropiado manejo de los desechos.

Para mayor información sobre recolección y reciclado de productos viejos y baterías, por favor contacte a su municipio local, su servicio de gestión de residuos o el punto de venta en el cual usted adquirió los artículos.

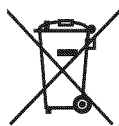

### [Información sobre la Disposición en otros países fuera de la Unión Europea]

Estos símbolos sólo son válidos en la Unión Europea. Si desea deshacerse de estos artículos, por favor contacte a sus autoridades locales y pregunte por el método correcto de disposición.

### Nota sobre el símbolo de la batería (ejemplos de dos símbolos de la parte inferior)

Este símbolo podría ser utilizado en combinación con un símbolo químico. En este caso el mismo obedece a un requerimiento dispuesto por la Directiva para el elemento químico involucrado.

Pb

## Informatie voor gebruikers van inzameling en verwijdering van oude apparaten en gebruikte batterijen



Deze tekens op de producten, verpakkingen en/of bijgaande documenten betekent dat gebruikte elektrische en elektronische producten en batterijen niet mogen worden gemengd met algemeen huishoudelijk afval. Breng alstublieft voor de juiste behandeling, herwinning en hergebruik van oude producten en gebruikte batterijen deze naar daarvoor bestemde verzamelpunten, in overeenstemming met uw nationale wetgeving en de instructies 2002/96/EC en 2006/66/EC.



Door deze producten en batterijen juist te rangschikken, helpt u het redden van waardevolle rijkdommen en voorkomt u mogelijke negatieve effecten op de menselijke gezondheid en de omgeving, welke zich zou kunnen voordoen door onpaste afvalverwerking.



Voor meer informatie over het inzamelen en hergebruik van oude producten en batterijen kunt u contact opnemen met uw plaatselijke gemeente, uw afvalverwerkingsbedrijf of het verkooppunt waar u de artikelen heeft gekocht.



### [Informatie over verwijdering in ander landen buiten de Europese Unie]

Deze symbolen zijn alleen geldig in de Europese Unie. Mocht u artikelen weg willen gooien, neem dan alstublieft contact op met uw plaatselijke overheidsinstantie of dealer en vraag naar de juiste manier van verwijderen.

**Pb**

### Opmerking bij het batterij teken (onderkant twee tekens voorbeelden):

Dit teken wordt mogelijk gebruikt in combinatie met een chemisch teken. In dat geval voldoet het aan de eis en de richtlijn, welke is opgesteld voor het betreffende chemisch product.



<b>Important Notice: Guarantee Information for customers in EEA* and Switzerland</b> For detailed guarantee information about this Yamaha product, and Pan-EEA* and Switzerland warranty service, please either visit the website address below (Printable file is available at our website) or contact the Yamaha representative office for your country. * EEA: European Economic Area	<b>English</b>
<b>Remarque importante: informations de garantie pour les clients de l'EEE et la Suisse</b> Pour des informations plus détaillées sur la garantie de ce produit Yamaha et sur le service de garantie applicable dans l'ensemble de l'EEE ainsi qu'en Suisse, consultez notre site Web à l'adresse ci-dessous (le fichier imprimable est disponible sur notre site Web) ou contactez directement Yamaha dans votre pays de résidence. * EEE : Espace Economique Européen	<b>Français</b>
<b>Wichtiger Hinweis: Garantie-Information für Kunden in der EWR* und der Schweiz</b> Für nähere Garantie-Information über dieses Produkt von Yamaha, sowie über den Pan-EWR*- und Schweizer Garantieservice, besuchen Sie bitte entweder die folgend angegebene Internetadresse (eine druckfähige Version befindet sich auch auf unserer Webseite), oder wenden Sie sich an den für Ihr Land zuständigen Yamaha-Vertrieb. *EWR: Europäischer Wirtschaftsraum	<b>Deutsch</b>
<b>Viktigt: Garantiinformation för kunder i EES-området* och Schweiz</b> För detaljerad information om denna Yamahaprodukt samt garantiservice i hela EES-området* och Schweiz kan du antingen besöka nedanstående webbadress (en utskriftsvänlig fil finns på webbplatsen) eller kontakta Yamahas officiella representant i ditt land. * EES: Europeiska Ekonomiska Samarbetsområdet	<b>Svenska</b>
<b>Avviso importante: informazioni sulla garanzia per i clienti residenti nell'EEA* e in Svizzera</b> Per informazioni dettagliate sulla garanzia relativa a questo prodotto Yamaha e l'assistenza in garanzia nei paesi EEA* e in Svizzera, potete consultare il sito Web all'indirizzo riportato di seguito (è disponibile il file in formato stampabile) oppure contattare l'ufficio di rappresentanza locale della Yamaha. * EEA: Area Economica Europea	<b>Italiano</b>
<b>Aviso importante: información sobre la garantía para los clientes del EEE* y Suiza</b> Para una información detallada sobre este producto Yamaha y sobre el soporte de garantía en la zona EEE* y Suiza, visite la dirección web que se incluye más abajo (la versión del archivo para imprimir esta disponible en nuestro sitio web) o póngase en contacto con el representante de Yamaha en su país. * EEE: Espacio Económico Europeo	<b>Español</b>
<b>Belangrijke mededeling: Garantie-informatie voor klanten in de EER* en Zwitserland</b> Voor gedetailleerde garantie-informatie over dit Yamaha-product en de garantieservice in heel de EER* en Zwitserland, gaat u naar de onderstaande website (u vindt een afdrukbaar bestand op onze website) of neemt u contact op met de vertegenwoordiging van Yamaha in uw land. * EER: Europese Economische Ruimte	<b>Nederlands</b>

**<http://europe.yamaha.com/warranty/>**



BONUS VIEW™



x.v.Color