

# FRIGIDAIRE

# Use & Care

Product Record and Registration . . . . .	2	Care and Cleaning . . . . .	17
Important Safety Instructions . . . . .	3	Before You Call . . . . .	20
Before Setting Oven Controls . . . . .	7	Warranty . . . . .	23
Oven Controls . . . . .	8		

## PRODUCT RECORD AND REGISTRATION

Need Help? .....	2
Product Registration .....	2
<b>Product Record and Registration</b> .....	<b>2</b>
<b>Important Safety Instructions</b> .....	<b>3</b>
<b>Before Setting Oven Controls</b> .....	<b>7</b>
<b>Oven Controls</b> .....	<b>8</b>
<b>Care and Cleaning</b> .....	<b>17</b>
<b>Before You Call</b> .....	<b>20</b>
<b>Warranty</b> .....	<b>23</b>

### Thank you for choosing Frigidaire.

**Important:** This Use and Care Guide is part of our commitment to customer satisfaction and product quality throughout the service life of your new appliance. We view your purchase as the beginning of a relationship. To ensure our ability to continue serving you, please use this page to record important product information.

### Need Help?

Visit the Frigidaire web site at [www.frigidaire.com](http://www.frigidaire.com)

Before you call for service, there are a few things you can do to help us serve you better.

### Read this Use & Care Manual

This manual contains instructions to help you use and maintain your range properly.

### If You Received a Damaged Range...

Immediately contact the dealer (or builder) that sold you the range.

### Save Time and Money

Check the section title "Before You Call". This section helps step you through some common problems that might occur.

If you do need service, help is only a phone call away. Call Frigidaire Customer Services at **1-800-944-9044**.

### Product Registration

Registering your product with Frigidaire enhances our ability to serve you. Register online at [www.frigidaire.com](http://www.frigidaire.com) or by dropping your Product Registration Card in the mail.

### Record model & serial numbers here

#### Purchase Date

#### Frigidaire model number

#### Frigidaire serial number

#### Serial Plate Location

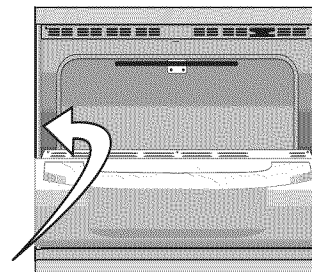

### Questions?

For toll-free telephone support in the U.S. and Canada call **1-800-944-9044**

For online support and Internet production information visit <http://www.frigidaire.com>.

# IMPORTANT SAFETY INSTRUCTIONS

## CAUTIONS AND WARNINGS

Read all instructions before using this appliance.

This manual contains important safety symbols and instructions. Please pay attention to these symbols and follow all instructions given.

Do not attempt to install or operate your appliance until you have read the safety precautions in this manual. Safety items throughout this manual are labeled with a WARNING or CAUTION statement based on the risk type.

## DEFINITIONS

 This is the safety alert symbol. It is used to alert you to potential personal injury hazards. Obey all safety messages that follow this symbol to avoid possible injury or death.

### WARNING

Indicates a potentially hazardous situation which, if not avoided, may result in death or serious injury.

### CAUTION

Indicates a potentially hazardous situation which, if not avoided, may result in minor or moderate injury.

### IMPORTANT

Indicates installation, operation, maintenance, or valuable information that is not hazard related.

### NOTE

Indicates a short, informal reference—something written down to assist the memory or for future reference.

## WARNING

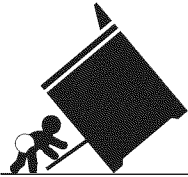

### Tip Over Hazard

- A child or adult can tip the oven and be killed.
- Install the anti-tip device to oven and/or structure per installation instructions.
- Ensure the anti-tip device is re-engaged when the oven is moved.
- Do not operate the oven without the anti-tip device in place and engaged.
- Failure to follow these instructions can result in death or serious burns to children and adults.

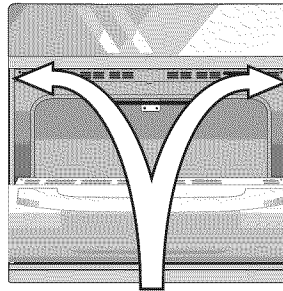

Anti-tip mounting holes

Refer to the installation instructions supplied with your appliance for proper installation.

Check for proper installation with a visual check that the anti-tip screws are present. Test the installation with light downward pressure on the open oven door. The oven should not tip forward.

## WARNING

**Storage In or On Appliance**—Flammable materials should not be stored in an oven, in the storage drawer, warmer drawer, or lower oven. This includes paper, plastic, and cloth items, such as cookbooks, plastic ware, and towels, as well as flammable liquids. Do not store explosives, such as aerosol cans, on or near the wall oven.

## IMPORTANT SAFETY INSTRUCTIONS

### WARNING

- Do Not Leave Children Alone - Children should not be left alone or unattended in the area where appliance is in use. They should never be allowed to sit or stand on any part of the appliance, including the storage drawer, lower broiler drawer, warmer drawer, or lower double oven.
- Stepping, leaning, or sitting on the door or drawers of a oven can result in serious injuries and also cause damage to the appliance. Do not allow children to climb or play around the oven. The weights of a child on an open over door may cause the oven to tip, resulting in serious burns or other injury.
- Never cover any slots, holes, or passages in the oven bottom or cover an entire oven rack with materials, such as aluminum foil. Aluminum foil linings may trap heat, causing a fire hazard.
- Do not touch heating elements or interior surfaces of oven. Heating elements may be hot even though they are dark in color. Interior surfaces of ovens become hot enough to cause burns. During and after use, do not touch, or let clothing or other flammable materials contact heating elements or interior surfaces of oven until they have sufficient time to cool. Other surfaces of the appliance may become hot enough cause burns such as the oven door, windows, and the oven vent.

### IMPORTANT

Important Safety Notice - The California Safe Drinking Water and Toxic Enforcement Act requires the governor of California to publish a list of substances known to cause cancer, birth defects, or other reproductive harms, and requires businesses to warn customers of potential exposures to such substances.

### CAUTION

- When heating fat or grease, watch it closely. Grease may catch fire if it becomes too hot.
- Do not use water or flour on grease fires. Cover the fire with a pan lid, use baking soda, or use a dry chemical or foam type extinguisher.
- Use dry potholders. Moist or damp potholders on hot surfaces may result in burns from steam. Do not let potholders touch hot cooking areas. Do not use towels or other bulky cloths.
- Wear proper apparel. Loose fitting or hanging garments should never be worn while using the appliance.
- Do not heat unopened food containers. Build-up of pressure may cause container to burst and result in injury.

### GROUNDING INSTRUCTIONS

Do not use an adapter plug or an extension cord, or remove grounding prong from the power cord. Failure to follow this warning may cause serious injury, fire, or death.

**For personal safety, this appliance must be properly grounded.**

**For models factory-equipped with a power cord:**

For maximum safety, the power cord must be plugged into an electrical outlet that is the correct voltage, is correctly polarized, and properly grounded in accordance with local codes.

**For ovens to be wired into a junction box:**

It is the personal responsibility of the consumer to have the appropriate outlet with the correct, properly grounded wall receptacle (junction box) installed by a qualified electrician. Follow carefully the installation instructions packaged with this appliance for complete installation and grounding instructions.

## IMPORTANT SAFETY INSTRUCTIONS

### IMPORTANT INSTRUCTIONS FOR USING OVEN

- Never use your appliance for warming or heating the room.
- Use care when opening oven door, lower oven door, or warmer drawer (some models). Stand to the side of the oven when opening the door of a hot oven. Let hot air or steam escape before you remove or replace food in the oven.
- Keep oven vent ducts clear. Touching surfaces in this area when the oven is on may cause severe burns. Do not place plastic or heat-sensitive items on or near the oven vent. These items can melt or ignite.
- Always handle oven racks when the oven is cool. Place oven racks in desired positions while the oven is cool. If a rack must be moved while the oven is hot, use extreme caution. Use potholders and grasp the rack with both hands to reposition. Do not let potholders contact the hot heating elements in the oven. Remove all bakeware and utensils before moving the rack.
- Do not use a broiler pan without its insert. Broiler pans and inserts allow dripping fat to drain away from the high heat of the broiler. Do not cover the broiler insert with aluminum foil; exposed fat and grease could ignite.
- Do not use aluminum foil or other protective liners to line the oven bottom. Only use aluminum foil as recommended in this manual. Improper installation of these liners may result in risk of electric shock or fire.
- Do not cook food on the oven bottom. Always cook in proper bakeware and always use the oven racks

### → IMPORTANT

Read and follow all important instructions and precautions for unpacking, installing, and servicing your appliance.

Remove all tape and packaging before using the oven. Destroy the carton and plastic bags after unpacking the oven. Never allow children to play with packaging material.

### → IMPORTANT

**Proper Installation**—Be sure your appliance is properly installed and grounded by a qualified technician in accordance with the National Electrical Code ANSI/NFPA No. 70 latest edition and local electrical code requirements. In Canada, install in accordance with CSA Standard C22.1, Canadian Electrical code, Part 1, and local electrical code requirements. Install only per installation instructions provided in the literature package for this oven.

**User Servicing**—Do not repair or replace any part of the appliance unless specifically recommended in the manuals. All other servicing should be done only by a qualified technician. This reduces the risk of personal injury and damage to the oven.

Ask your dealer to recommend a qualified technician and an authorized repair service. Know how to disconnect the power to the oven at the circuit breaker or fuse box in case of an emergency.

Never modify or alter the construction of an oven by removing the leveling legs, panels, wire covers, anti-tip brackets/screws, or any other part of the oven.

Remove the oven door from any unused oven if it is to be stored or discarded.

Do not attempt to operate the oven during a power failure. If the power fails, always turn off the oven. If the oven is not turned off and the power resumes, the oven will begin to operate again. Once the power resumes, reset the clock and oven function.

Cold temperatures can damage the electronic control. When using this appliance for the first time, or when the appliance has not been used for an extended period of time, be sure the appliance has been in temperatures above 32°F (0°C) for at least 3 hours before turning on the power to the appliance.

Be sure to have an appropriate foam-type fire extinguisher available, visible, and easily accessible located near the appliance.

## IMPORTANT SAFETY INSTRUCTIONS

### IMPORTANT INSTRUCTIONS FOR CLEANING YOUR OVEN

#### CAUTION

Before manually cleaning any part of the oven, be sure all controls are turned off and the oven is cool. Cleaning a hot oven can cause burns.

- Clean the oven regularly to keep all parts free of grease that could catch fire. Do not allow grease to accumulate.
- Always follow the manufacturer's recommended directions for use of kitchen cleaners and aerosols. Be aware that excess residue from cleaners and aerosols may ignite causing damage and injury.
- Clean ventilating hoods frequently. Grease should not be allowed to accumulate on the hood or filter. Follow the manufacturer's instructions for cleaning hoods.

#### WARNING

Avoid fire hazard or electrical shock. Do not use an adapter plug or an extension cord, or remove grounding prong from the power cord. Failure to follow this warning may cause serious injury, fire, or death.

See the installation instructions packaged with this appliance for complete installation and grounding instructions.

### SELF CLEANING OVENS

- Use the self clean cycle to clean only the parts listed in this manual. Before using self clean, remove the broiler pan, any food, utensils, and bakeware from the oven. Remove oven racks unless otherwise instructed.
- Do not use oven cleaners. No commercial oven cleaner, oven liner, or protective coating of any kind should be used in or around any part of the oven.
- Do not clean the oven door gasket. The door gasket is essential for a good seal. Do not rub, damage, or move the gasket.
- Some birds are extremely sensitive to the fumes given off during the self clean cycle of any oven. Move birds to another well-ventilated room.

## BEFORE SETTING OVEN CONTROLS

### Oven vent location

The oven vent is located under the control panel. When the oven is on, warm air passes through this vent. This venting is necessary for proper air circulation in the oven and good baking results. Steam or moisture may appear near the oven vent, this is normal. Do not block oven vent.

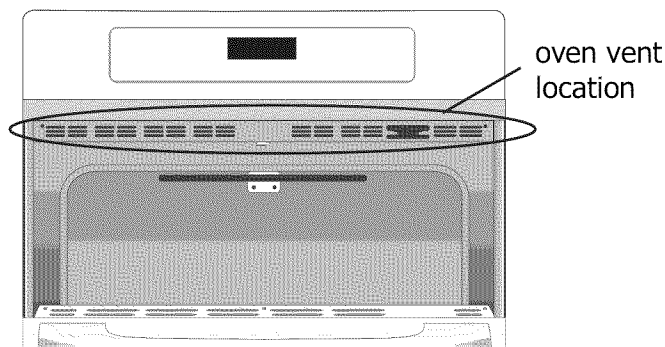

**Figure 1: Do not block oven vent location**

### CAUTION

Always use pot holders or oven mitts when using the oven. When cooking, the oven interior and exterior, as well as the oven racks, will become very hot which can cause burns.

### WARNING

Protective Liners — Do not use aluminum foil to line the oven bottom. Only use aluminum foil as recommended in this manual. Improper installation of these liners may result in risk of electric shock or fire.

### Removing, replacing, and arranging flat or offset oven racks

To arrange - Always arrange the oven racks when the oven is cool (prior to operating the oven).

To remove - Pull the oven rack straight forward until it reaches the stop position. Lift up front of oven rack slightly and slide out.

To replace - Place the oven rack on the rack guides on both sides of oven walls. Tilt the front of oven rack upward slightly and slide the oven rack back into place. Be sure oven racks are level before using.

### Type of oven racks

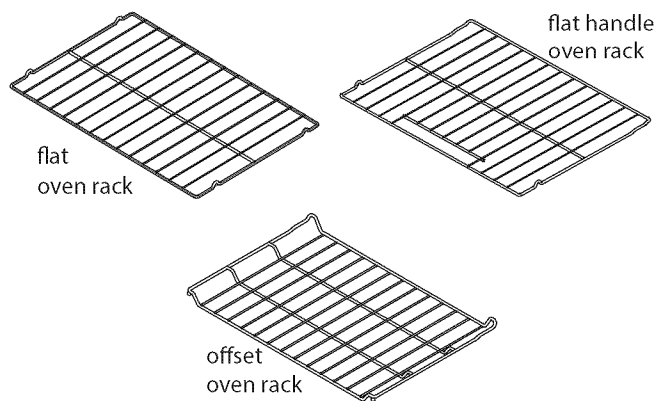

**Figure 2: Oven rack types**

### Oven Rack Descriptions

- Flat oven racks (or the flat handle oven rack) may be used for most cooking needs and may be placed in most oven rack positions.
- The offset oven rack (some models) provides additional stepdown positions from the standard flat rack design. The offset design positions the base of the rack about half of a rack position lower than the flat rack and may be used in most oven rack positions.

### Air circulation in the oven

For best air circulation when baking, allow a space of 2 inches (5 cm) around the bakeware for proper air circulation. Be sure pans and bakeware do not touch each other, the oven door, sides, or back of the oven cavity.

Hot air must be able to circulate around bakeware for heat to reach the food evenly.

# OVEN CONTROLS

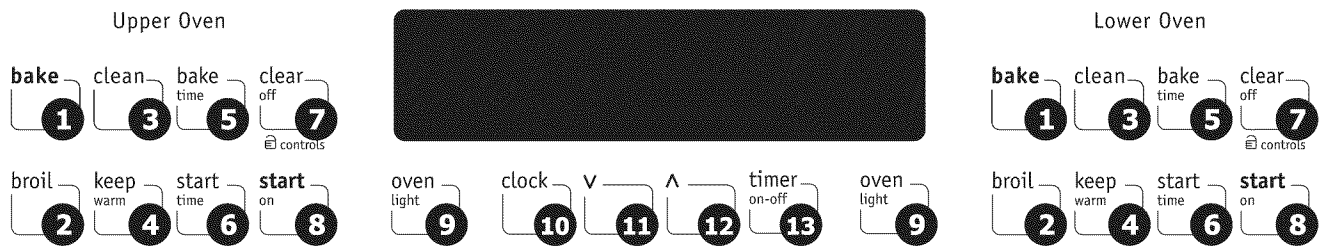

Take time to become familiar with the various features and functions of your oven model. Detailed instructions on using each oven feature and function of the controls can be found in this section of the owner's manual.

1. **Bake** — Use to set normal baking mode temperature.
2. **Broil** — Use to set the variable broil function.
3. **Clean** — Use to select the self clean cycle.
4. **Keep Warm** — Use to set the Keep Warm feature.
5. **Bake Time** — Use to enter length of baking time.
6. **Start Time** — Use to set a start time for baking. Can be used with Bake Time to program a delayed bake.
7. **Clear Off** — Use to clear any function previously entered except time of day and minute timer. Press clear off to cancel cooking.
8. **Start on** — Use to start all oven functions.
9. **Oven light** — Use to turn interior oven light on and off.
10. **Clock** — Use to set time of day.
11. **Down arrow** — Use together with function keys to select oven temperature, time of day, and minute timer.
12. **Up arrow** — Use together with function keys to select oven temperature, time of day, and minute timer.
13. **Timer On-Off** — Use to set or cancel the minute timer. The minute timer does not start or stop any cooking function.

## NOTE

All instructions in this manual are given for the UPPER oven. If LOWER oven is used the indicator lights will appear in the right portion of the display. Be careful to select the proper oven of choice when cooking.

## Setting the Clock

The Clock key is used to set the clock. The clock may be set for 12 or 24 hour time of day operation. The clock has been preset at the factory for the 12 hour operation. When the wall oven is first plugged in, or when the power supply to the appliance has been interrupted, the timer in the display will flash. Some models will also display **PF** (power failure).

When **PF** appears in the display or when 12:00 is flashing, press clear off.

### To set the clock:

1. **Press clock.** **CLO** and the current time of day will appear in the display.
2. **Press up or down arrow** to set the correct time of day. **Press start.** The new time of day will appear in the display.

## Changing Between 12 or 24 Hour Time of Day Display

1. **Press and hold clock** for 6 seconds. **CLO** and the current time of day will appear in the display. A beep will sound and 12h or 24h will appear in the display.
2. **Press up or down arrow** to switch between the 12 and 24 hour time of day display. The display will show either **12h** or **24h**.
3. **Press start or wait 5 seconds** to accept the change. Press clear off to reject the change.
4. Reset the correct time as described in **To set the Clock** above. Please note that if the 24 hour time of day mode was chosen, the clock will now display time from 0:00 through 23:59 hours.



## Setting Silent Control Operation

The start time key controls the Silent Control Operation feature. This feature allows the oven control to be operated without sounds or beeps if necessary. The control can be programmed for silent operation and later returned to operating with all the normal tones.

**To change control from normal sound operation to silent control operation:**

### NOTE

If **SP** appears, the control will operate with normal audible tones. If **--** appears, the control is in the silent operation mode.

1. Press and hold start time for 6 seconds. A beep will sound, **--** will appear, **UPPER** and **DELAY** will flash in the display. After 6 seconds, a beep will sound and **SP** will appear in the display.
2. Press up or down arrow to switch between normal sound operation and silent operation mode.
3. Press start or wait 5 seconds for the controls to accept the change. Press clear off to reject the change.

## Setting Continuous Bake or 12 Hour Energy Saving

The timer on/off and clean keys control the Continuous Bake or 12 Hour Energy Saving Features. The oven control has a factory preset built-in 12 Hour Energy Saving feature that will shut off the oven if the oven control is left on for more than 11 hours and 59 minutes. The oven can be programmed to override this feature for Continuous Baking.

**To set the control for Continuous Bake or 12 Hour Energy Saving Features:**

1. Press and hold timer **on/off** for 6 seconds. After 6 seconds **12h** or **--h** will appear in the display and the control will beep once.
2. Press **up or down arrow** to switch between the 12 Hour Energy Saving and continuous bake features.
3. Press **start or wait 5 seconds** to accept the change (display will return to time of day). Press **clear off** to reject the change.

### NOTE

**12h** indicates the control is set for 12 Hour Energy Saving. **--h** indicates the control set for Continuous Bake.

## Setting Minute Timer

The **timer on-off** key controls the minute timer and serves as an extra timer in the kitchen that will beep when the set time has run out. It does not start or stop cooking. The minute timer can be used during any of the other oven control functions.

**To set the Minute Timer** (example for 5 minutes)

1. Press **timer on-off**. **--** will appear and **TIMER** will flash in the display.
2. Press the number keys to set the desired time in the display. Press **start**. The time will begin to count down and **TIMER** will stay in the display.

**Note:** If **start** is not pressed the timer will return to the time of day after 25 seconds.

When the time expires, **End** and **TIMER** will show in the display. The clock will sound with 3 beeps every 30 seconds until **timer on-off** is pressed.

To cancel the Minute Timer before the set time expires, Press **timer on-off**.

### NOTE

If **F** appears, the display is set to show temperatures in Fahrenheit. If **C** appears, the display is set to show temperatures in Celsius.

## Setting Temperature Display in Fahrenheit or Celsius

The **broil** key control the Fahrenheit or Celsius temperature display modes. The oven has been preset at the factory to display in Fahrenheit.

**To change display from Fahrenheit to Celsius or Celsius to Fahrenheit:**

1. To tell if the display is set for Fahrenheit or Celsius press **broil** and hold it for 6 seconds; **550°** will appear and **broil** will flash in the display and a beep will sound. If **F** appears, the display is set to show temperatures in Fahrenheit. If **C** appears, the display is set to show temperatures in Celsius.
2. Press **up or down arrow** to switch between Fahrenheit or Celsius display modes. The display will show either **F** or **C**.
3. Press **start or wait 5 seconds** to accept the change or press **off** to reject the change.

## OVEN CONTROLS

### Setting the Oven Lockout feature

The **clear off** key controls the Oven Lockout feature. The Oven Lockout feature automatically locks the oven doors and prevents the oven from being turned on. It does not disable the clock, timer or the interior oven lights. The ovens can be locked individually.

#### To activate the oven lockout feature:

1. Press and hold **clear off** for 3 seconds.
2. After 3 seconds a beep will sound, **DOOR, LOCKED** will flash and **Loc, UPPER** and  will appear in the display. Once the oven door is locked the **DOOR** and **LOCKED** indicator will stop flashing and remain in the display.

#### To reactivate normal oven operation:

1. Press and hold **clear off** for 3 seconds. A beep will sound. **UPPER, LOC** and  will disappear from the display. **DOOR** and **LOCKED** will flash in the display until the oven door has completely unlocked.
2. The wall oven is again fully operational.

### Adjusting the Oven Temperature

The temperature in the oven has been preset at the factory. When first using the oven, be sure to follow recipe times and temperatures. If you think the oven is too hot or too cool, the temperature in the oven can be adjusted. Before adjusting, test a recipe by using a temperature setting that is higher or lower than the recommended temperature. The baking results should help you to decide how much of an adjustment is needed.

#### To adjust the oven temperature:

1. **Press and hold bake for 6 seconds.** The preset adjustment number will appear and **UPPER** will flash in the display.
2. To increase the temperature use the **up arrow** to enter the desired change. The temperature may be increased as much as 35°F (19°C). To decrease the temperature use the **down arrow** to enter the desired change. The temperature may be decreased as much as 35°F (19°C).
3. Press start or wait 5 seconds to accept the temperature change and the display will return to the time of day. Press **clear off** to reject the change if necessary.

**Note:** The temperature adjustments made with this feature will not change the self clean or broil temperatures. Each oven may be adjusted individually.

### Setting Bake

#### Baking Tips:

- Preheat your oven before using bake mode.
- Use only one rack and center the pans as much as possible on rack position 2 or 3. If using two racks, place the oven racks in positions 2 and 4.
- Allow 2" to 4" (5.1 cm to 10.2 cm) around the pans for proper air circulation. Be sure the pans do not touch each other, the door, sides or back of the oven cavity. (Figure 3)

The bake key controls normal baking. the oven can be programmed to bake at any temperature from 170°F to 550°F (77°C to 288°C).

#### To set the Bake Temperature:

1. Arrange interior oven racks.
2. Press bake, - - - will appear, **UPPER** and **BAKE** will flash in the display.
3. Press up or down arrow to set desired temperature. When desired temperature appears, **UPPER** and **BAKE** continue flashing in the display.
4. Press start or wait 5 seconds. **UPPER** and **BAKE** stop flashing and the oven icon will appear in the display. A beep will sound once the oven temperature reaches the desired baking temperature.

Pressing clear off will cancel the Bake feature at any time.

#### To change the Bake Temperature

1. After the oven has already been set to bake and the oven temperature needs to be changed, press bake **UPPER** and **BAKE** will start flashing in the display.
2. Press up or down arrow to increase or decrease the set temperature.
3. Press start. **UPPER** and **BAKE** will stop flashing and remain in the display. A beep will sound once the oven temperature reaches the set baking temperature.

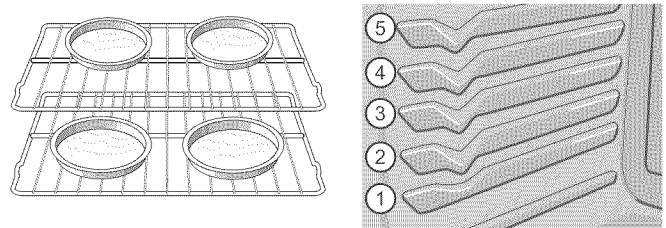

**Figure 3: Pan spacing and rack positions**

## Setting the Timed Bake Feature

The bake and bake time keys control the Timed Bake feature. The automatic timer of the Timed Bake feature will turn the oven off after cooking for the desired amount of time you selected.

### CAUTION

Foods that can easily spoil such as milk, eggs, fish, meat or poultry, should be chilled in the refrigerator first. Even when chilled, they should not stand in the oven for more than 1 hour before cooking begins, and should be removed promptly when cooking is completed. Eating spoiled food can result in sickness from food poisoning.

### To program the oven to begin baking and shut off automatically (Timed Bake):

1. Be sure that the clock is set for the correct time of day.
2. Arrange interior oven rack(s) and place the food in the oven.
3. Press **bake**. **UPPER, BAKE** will flash and - - - will appear in the display.
4. Press **up** or **down arrow** to set the temperature. **UPPER, BAKE** will continue to flash and desired temperature will appear in the display.
5. Press **start** or wait 5 seconds. **UPPER** and **BAKE** stop flashing and remain in the display.
6. Press **bake time**. **UPPER** and **TIMED** start flashing and -- -- will appear in the display.
7. Press the **up** or **down arrow** until the desired baking time appears in the display.
8. Press **start** or wait 5 seconds. The display returns to the time of day.
9. Press **clear off** when baking has finished or at any time to cancel the Timed Bake feature

## Setting Delayed Time Bake

The bake, bake time and start time keys control the Delayed Time Bake feature. The automatic timer will turn the oven on and off at the time you select in advance. To set any delayed bake to start more than 12 hours in advance you must set the clock in 24 hr mode.

### To program the oven for a delayed start time and to shut off automatically (Delayed Start Bake)

1. Be sure that the clock is set with the correct time of day, arrange interior oven rack(s) and place the food in the oven.
2. Press **bake**. **UPPER, BAKE** will flash and - - - will appear in the display.
3. Press **up** or **down arrow** until the desired temperature appears. **UPPER, BAKE** will continue to flash and the desired temperature will appear in the display.
4. Press **start** or wait 5 seconds. **UPPER** and **BAKE** will stop flashing and remain in the display.
5. Press **bake time**. **UPPER** and **TIMED** will start flashing and -- -- will appear in the display.
6. Press the **up** or **down arrow** until the desired baking time appears in the display.
7. Press **start**.
8. Press **start time**. **UPPER, DELAY** start flashing and -- - will appear in the display.
9. Press the **up** or **down arrow** until the desired start time appears in the display.
10. Press **start**. When the start time is reached, the oven icon will appear in the display and the oven will start to bake.
11. Press **clear off** when baking has completed or at any time to cancel.

### When the set bake time runs out:

1. **End** will appear in the display and the oven will shut off automatically.
2. The control will beep 3 times. The control will continue to beep 3 times every 30 seconds until **clear off** is pressed.

# OVEN CONTROLS

## Setting Broil

This mode is best for meats, fish and poultry up to 1" thick. Broiling is a method of cooking tender cuts of meat by direct heat under the broil element of the oven.

### **WARNING**

Should an oven fire occur, leave the oven door closed and turn off the oven. If the fire continues, throw baking soda on the fire or use a fire extinguisher. Do not put water or flour on the fire. Flour may be explosive and water can cause a grease fire to spread and cause personal injury.

The **broil** key controls the broil feature. The oven can be programmed to broil at any temperature from 400°F to 550°F with a default temperature of 550°F.

### To set a Broil:

1. Place the broiler pan insert on the broiler pan. Then place the food on the broiler pan insert. Do not use the broiler pan without the insert. Do not cover the broiler insert with foil. The exposed grease could ignite.
2. Preheat for 2 minutes before broiling.
3. Arrange the interior oven rack and place the broiler pan on the rack. Be sure to center the broiler pan directly under the broiler element.
4. Press **broil**. --- will appear and **UPPER** and **BROIL** will appear in the display
5. Press **up or down arrow** until the desired broiling temperature appears in the display. Press **start**. Broil on

one side until food is browned; turn and cook on the second side. Season and serve.

6. To stop broiling press **clear off**.

The optional broil pan and broil pan insert used together allow dripping grease to drain and be kept away from the high heat of the oven broiler. Available at [frigidaire.com](http://frigidaire.com).

For Broiling recommendations see Table 1

### Broiling Tips:

- For optimum browning, preheat the broil element for 2 minutes.
- Always use a broiler pan and its cover when broiling. (Figure 4).
- Always pull the rack out to the stop position before turning or removing food.
- Do not use the broil pan without an insert. Do not cover the broil pan insert with foil. The exposed grease could catch fire.

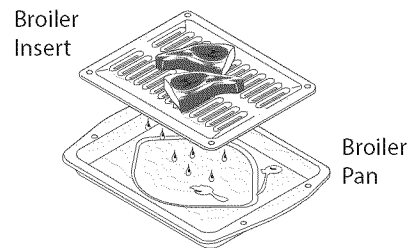

Figure 4: Broil accessories

Table 1: Recommended broil settings

Food item	Rack Position	Temperature	Cook time		Doneness
			1st side	2nd side	
Steak 1" thick	3rd or 4th	550°F	6:00	4:00	Rare
	3rd or 4th	550°F	7:00	5:00	Medium
Pork Chops 3/4 "thick	3rd or 4th	550°F	8:00	6:00	Well
Chicken - Bone In	3rd	450°F	20:00	10:00	Well
Chicken Boneless	3rd or 4th	450°F	8:00	6:00	Well
Fish	3rd	500°F	13:00	-	Well
Shrimp	3rd	550°F	5:00	-	Well
Hamburger 1" thick	3rd or 4th	550°F	9:00	7:00	Medium
	3rd or 4th	550°F	10:00	8:00	Well

## Setting the Keep Warm Feature

The keep warm key turns on the Keep Warm feature and will maintain an oven temperature of 170°F (77°C). The Keep Warm feature will keep oven baked foods warm for serving up to 3 hours after cooking has finished. After 3 hours Keep Warm will shut the oven off. Keep Warm may be used without any other cooking operations or can be used after cooking has finished using Bake.

Keep Warm may be used with a timed bake if you wish to have Keep Warm turn on automatically when cooking has finished. The timed bake feature requires you to set the amount of cooking time. With this information the control can calculate the time when cooking will end and can then start Keep Warm automatically.

### To set keep warm

1. Arrange interior oven racks and place food in oven.
2. Press **keep warm--UPPER, WARM** will flash and - - - will appear in the display.
3. Press **start. UPPER and WARM** will stop flashing, **Hld** and the oven icon will appear in the display.
4. To turn keep warm off at any time press **clear off**.

### NOTE

If no key is touched within 25 seconds the request to turn on the Keep Warm will be cleared.

### To set keep warm to turn on automatically after cooking:

1. Arrange interior oven racks and place food in oven.
2. Set the oven for timed bake or delayed time bake.
3. Press start. **UPPER** and **WARM** will stop flashing and remain in the display.
4. When the timed bake has finished, keep warm will automatically turn on. The desired temperature, **BAKE** and **Timed** will disappear. **Hld** will appear in the display. **UPPER** and the oven icon will remain visible.

The keep warm will turn on when the baking finishes and will remain active for three hours unless cancelled sooner.

Press **clear off** at any time to stop Keep Warm or any cooking function.

## Adjusting The Oven Temperature

The temperature in the oven is pre-set at the factory. When first using the oven, be sure to follow recipe times and temperatures. If you think the oven is cooking too hot or too cool for the temperature you select, you can adjust the actual oven temperature to be more or less than what is displayed. Before adjusting, test a recipe by using a temperature setting higher or lower than the recommended temperature. The baking results should help you to decide how much of an adjustment is needed.

### To adjust the oven temperature higher:

1. Press **bake for 6 seconds. UPO 0** will appear in the display.
2. To increase the temperature use the **number keys** to enter the desired change (Example 30°F) **3 0**. The temperature may be increased as much as 35°F (19°C).
3. Press **start** to accept the temperature change and the display will return to the time of day. Press **off** to reject the change if necessary.

### To adjust the oven temperature lower:

1. Press **bake for 6 seconds. UPO 0** will appear in the display.
2. To decrease the temperature use the number keys to enter the desired change (**Example -30°F**) **3 0** and then press **self clean**. The temperature may be decreased as much as 35°F (19°C).
3. Press **start** to accept the temperature change and the display will return to the time of day.
4. Press **clear off** to reject the change if necessary.

### NOTE

The oven temperature adjustments made with this feature will not change the self clean cycle temperature or the broil temperature.

The oven temperature adjustments are permanent and will stay forever in the unit memory unless you manually change it again. Even a power outage will not reset these changes. Follow the same procedure again if you wish to change it to a different setting.

## OVEN CONTROLS

### Setting Sabbath Feature (for use on the Jewish Sabbath and Holidays)



The **bake time** and **start time** keys are used to set the Sabbath feature. The Sabbath feature may only be used with **BAKE**. The oven temperature may be set higher or lower after setting the Sabbath feature (the oven temperature adjustment feature should be used only during Jewish Holidays), however the display will not visibly show or provide any audible tones indicating whether the change occurred correctly. Once the oven is properly set using Bake with the Sabbath feature active, the oven will remain continuously ON until cancelled. This will override the factory preset 12-Hour Energy Saving feature.

If the oven light will be needed during the Sabbath, press **oven light** before activating the Sabbath feature. Once the oven light is turned on and the Sabbath feature is active, the oven light will remain on until the Sabbath feature is turned off. If the oven light needs to be off, be sure to turn the oven light off before activating the Sabbath feature.

#### → IMPORTANT

It is not advised to attempt to activate any other program feature other than **BAKE** while the Sabbath feature is active. **ONLY** the following keys will function after setting the Sabbath feature; **UP** or **DOWN** arrow, **bake**, **start** and **clear off** keys. All other keys will not function once the Sabbath feature is properly activated.

To Program the oven to begin baking Immediately and activate the Sabbath feature

1. Be sure that the clock is set with the correct time of day.
2. Place the food in the oven.
3. Press **bake**. --- will appear, **UPPER** and **Bake** will flash in the display.
4. Press the **up or down arrow** until the desired temperature appears. **UPPER** and **BAKE** will flash in the display.
5. **Press start or wait 5 seconds**. **UPPER** and **BAKE** stop flashing and the icon will appear in the display.

6. If you desire to set the oven control for a Timed Bake or Delayed Start Bake do so at this time. If not, skip this step and continue to step 7. Refer to the Timed Bake (complete steps 6-8) / Delayed Start Bake (complete steps 6-11) section for complete instructions. Remember the oven will shut down after using Timed Bake or Delay Start Bake and therefore may only be used once during the Sabbath/Jewish Holidays. The maximum Delayed Start Bake time is 11 hours & 59 minutes.
7. The oven will turn ON and begin heating.
8. Press and hold both **bake time and start time** for at least 3 seconds. **SAb** will appear in the display. Once **SAb** appears in the display the oven control will no longer beep when a key is pressed or display any further changes. The oven is properly set for the Sabbath feature.
9. The oven may be turned off at any time by first pressing **clear off** (this will turn the oven off only). To turn off the Sabbath feature press and hold both **bake time** and **start time** for at least 3 seconds. This also turns off the oven. **SAb** will disappear from the display.

#### ↳ NOTE

You may change the oven temperature once baking has started by pressing **bake**, the up or down arrow for the temperature you want and then pressing **start** twice (for Jewish Holidays only). Remember that the oven control will no longer beep when a key is pressed or display any further changes once the oven is set for the Sabbath feature.

Should you experience a power failure or interruption, the oven will shut off. When power is returned the oven will not turn back on automatically. The oven will remember that it is set for the Sabbath and the food may be safely removed from the oven while still in the Sabbath feature, however the oven cannot be turned back on until after the Sabbath. After the Sabbath observance turn OFF the Sabbath feature. Press and hold both the **bake time and start time** for at least 3 seconds. **SAb** will disappear from the display and the oven may be used with all normal functions. For further assistance, guidelines for proper usage, and a complete list of models with the Sabbath feature, please visit the web at [star-k.org](http://star-k.org).

## Self Cleaning Operation

A self cleaning oven cleans with high temperatures (well above normal cooking temperatures) which eliminate soils completely or reduces them to a fine powdered ash you can wipe away with a damp cloth.

### What to expect during cleaning

While the oven is in operation sounds of metal expansion and contraction are normal. Odor is also normal as the food soil is being removed. Smoke may appear through the oven vent. If heavy spills are not wiped up before cleaning, they may flame and cause more smoke and odor than usual. This is normal and safe and should not cause alarm. If available, use an exhaust fan during the self cleaning cycle.

### CAUTION

- When opening the oven after self clean cycle stand to side to allow heat to escape and avoid possible burns.
- In self clean the outside of the range can be very hot. Do not leave small children unattended near the oven.
- Some birds are extremely sensitive to fumes given off by the self clean cycle. Move birds to a well ventilated room.
- Do not line the oven walls, racks, bottom or any part of the range with aluminum foil. This ruins heat distribution, produces poor baking results, and causes permanent damage to the oven interior.
- Do not force the oven door open. This can damage the automatic door locking system. Wait until the self clean cycle is finished and the door fully unlocks.

### IMPORTANT

- Do not use oven cleaners or oven protective coatings in or around any part of the oven interior.
- Do not clean the oven door gasket. The woven material of the oven door gasket is essential for a good seal. Be careful not to rub, damage or remove the gasket. Do not use any cleaning materials on the oven door gasket. Doing so could cause damage.
- Completely remove all oven racks and any accessories including the broiler pan and insert and any aluminum foil. These items cannot withstand high cleaning temperatures and will melt. If the oven racks are not removed, they will lose their special coating properties and will no longer slide in and out of the oven cavity effortlessly.
- Remove any excessive spills in the oven cavity before starting the self cleaning cycle. To clean, use hot, soapy water and a cloth. Large spills can cause heavy smoke or fire when subjected to high temperatures.
- Do not allow food spills with a high sugar or acid content (such as milk, tomatoes, or pie filling) to remain on the surface as they may leave a dull spot even after cleaning.
- Clean any soil from the oven frame, the door liner outside the oven door gasket and the small area at the front center of the oven bottom. These areas heat sufficiently to burn soil on. Clean with soap and water. (fFigure 5)

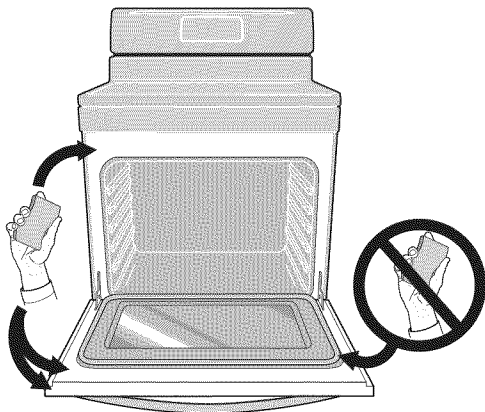

Figure 5: Areas to hand clean and areas to avoid

## OVEN CONTROLS

### Setting Self Clean Cycle Duration

The clean key controls the self cleaning feature. If you are planning to use the oven directly after a self clean cycle remember to allow time for the oven to cool down and the oven door to unlock. This normally takes about one hour. A 3 hour self clean cycle will actually take about 4 hours to complete.

#### To set the controls for a 3 hour Self Cleaning cycle to start immediately and shut off automatically

1. Be sure that the clock is set with the correct time of day and the oven door is closed.
2. Press **clean**. **3:00**, **CLn** will appear, **UPPER** and **CLEAN** will flash in the display. The control will automatically clean for a 3 hour period.
3. Press **start**. **DOOR** and **LOCKED** will flash; **UPPER** and **CLn** will appear in the display and the clock will return to the time of day.
4. As soon as the control is set, the motor driven oven door lock will begin to close automatically. Once the door has been locked the **UPPER**, **DOOR** and **LOCKED** indicator light will stop flashing and remain on. Also, the oven icon will appear in the display. Allow about 15 seconds for the oven door lock to close.
5. Press **start time**. **UPPER** and **DELAY** will start flashing and **- - - -** will appear in the display.

**Note: If the optional delay self clean is desired, finish steps 6-8.**

1. Press the **up or down arrow** until the desired start time appears in the display.
2. Press **start or wait 5 seconds**. The display will return to the time of day.
3. The control will start the self cleaning at the set start time, for the period of time previously selected.

#### When the Self Clean Cycle is Completed

1. Three long beeps will be heard and **CLn** will disappear from the display. **UPPER**, **DOOR** and **LOCKED** will remain in the display until the door is unlocked. Some models will display **Hot**. The cooling fan will continue to run until the oven has cooled down.
2. Once the oven has cooled down for 1 hour, and **UPPER**, **DOOR** and **LOCKED** are no longer displayed, the oven door can then be opened.

### Stopping or interrupting a Self Clean Cycle

**If it becomes necessary to stop or interrupt a self cleaning cycle due to excessive smoke or fire in the oven:**

Press **clear off**.

Once the oven has cooled down for approximately 1 hour and **UPPER**, **DOOR** and **LOCKED** are no longer displayed, the oven door can then be opened.

#### Important Notes when using the self clean feature:

- A self clean cycle cannot be started if the Oven Lockout feature is active.
- When self clean cycle is active on one oven, the other one cannot be used or set for a self clean cycle or any cooking cycle.
- If your clock is set for normal 12 hour display mode the delay self clean can never be set to start more than 12 hours in advance. To set for a delayed self cleaning cycle 12-24 hours in advance see instructions to set control for the 24 hour time of day display mode.



## Cleaning Various Parts of Your Wall Oven

Before cleaning any part of the oven, be sure all controls are turned off and the oven is cool. Remove spills and any heavy soiling as soon as possible. Regular cleaning will reduce the difficulty of major cleaning later.

Surface Type	Recommendation
Aluminum and Vinyl	Use hot, soapy water and a cloth. Dry with a clean cloth.
Painted and plastic control knobs Painted body parts Painted decorative trims	<p>Using a soft cloth and clean with mild dish detergent and water or a 50/50 solution of vinegar and water. Follow by rinsing the area with clean water; dry and polish with a soft cloth. Glass cleaners may be used if sprayed on a soft cloth first. Do not spray liquids directly on the oven control and display area.</p> <p>Do not use large amounts of water on the control panel - excess water on the control area may cause damage to the appliance.</p> <p>Do not use other liquid cleaners, abrasive cleaners, scouring pads, or paper towels - they will damage the finish. To remove control knobs, turn to the OFF position; grasp firmly and pull straight off the shaft. To replace knobs after cleaning, line up the flat sides of both the knob and the shaft; then push the knob into place.</p>
Stainless Steel	<p>Your oven finish may be made with stainless steel (some models). Clean the stainless with warm soapy water using a clean sponge or cloth. Rinse with clean water and dry with a soft clean cloth.</p> <p>Do not use any store bought cleaners like stainless steel cleaners or any other types of cleaners containing any abrasive, chlorides, chlorine or ammonia. It is recommended to use mild dish soap and water or a 50/50 solution of water and vinegar.</p>
Porcelain enamel broiler pan and insert (available by mail order) Door liner and body parts	Gentle scouring with a soapy scouring pad will remove most spots. Rinse with a 1:1 solution of clear water and ammonia. If necessary, cover difficult spots with an ammonia-soaked paper towel for 30 to 40 minutes. Rinse with clean water and a damp cloth, and then scrub with a soap-filled scouring pad. Rinse and wipe dry with a clean cloth. Remove all cleaners or the porcelain may become damaged during future heating.
Oven racks	Oven racks must be removed from oven cavity. Clean by using a mild, abrasive cleaner following manufacturer's instructions. Rinse with clean water and dry.
Oven door	<p>Use soap and water to thoroughly clean the top, sides, and front of the oven door. Rinse well. You may use a glass cleaner on the outside glass of the door.</p> <p>Do not immerse the door in water. Do not spray or allow water or the glass cleaner to enter the door vents. Do not use oven cleaners, cleaning powders, or any harsh abrasive cleaning materials on the outside of the oven door.</p> <p>Do not clean the oven door gasket. On self clean models, the oven door gasket is made of a woven material which is essential for a good seal. Care should be taken not to rub, damage, or remove this gasket.</p>

## CARE AND CLEANING

### Removing and Replacing the Oven Door

#### **CAUTION**

The door is heavy. For safe, temporary storage, lay the door flat with the inside of the door facing down.

#### To remove oven door:

1. Open oven door completely, horizontal with floor (See Figure 6).
2. Pull the door hinge locks on both left and right door hinges down from the oven frame completely towards the oven door (See Figure 7). A tool such as a small flat-blade screwdriver may be required.
3. Firmly grasp both sides of oven door along the door sides. Do not use the oven door handle (See Figure 8).
4. Close the door to approximately 10 degrees from the door frame. (See Figure 8).
5. Lift the oven door hinge arms over the roller pins located on each side of the oven frame (See Figure 8).

#### To replace oven door:

1. Firmly grasp both sides of oven door along the door sides. Do not use the oven door handle (See Figure 8).
2. Holding the oven door at the same angle as the removal position, seat the hook of the hinge arm over the roller pins located on each side of the oven door frame (See Figure 8 and Figure 9). The hook of the hinge arms must be fully seated onto the roller pins.
3. Fully open the oven door, horizontal with floor See Figure 6).
4. Push the door hinge locks up towards and into the oven frame on both left and right oven door hinges to the locked position (See Figure 7).
5. Close the oven door.

#### **IMPORTANT**

Most oven doors contain glass that can break. Do not close the oven door until all the oven racks are fully in place. Do not hit the glass with pots, pans, or any other object. Scratching, hitting, jarring, or stressing the glass may weaken its structure causing an increased risk of breakage at a later time.

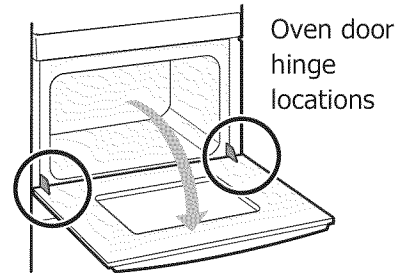

Figure 6: Door hinge location

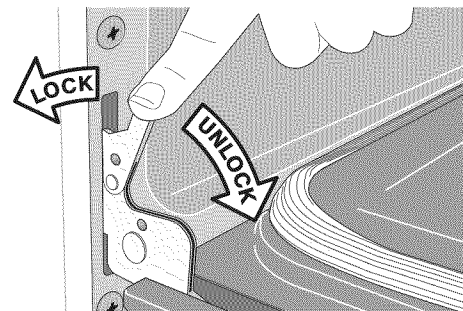

Figure 7: Door hinge locks

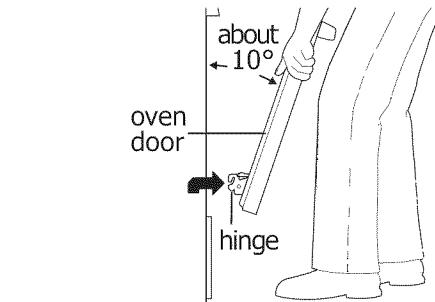

Figure 8: Holding door for removal

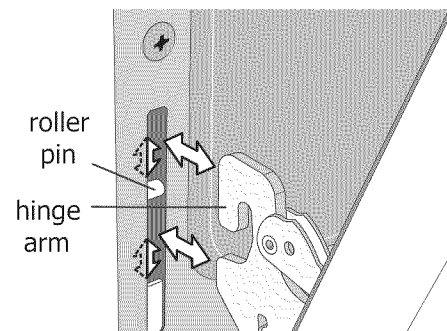

Figure 9: Replacement and location of hinge arm and roller pin

### Replacing the oven light

#### **⚠ CAUTION**

Be sure the oven is unplugged and all parts are cool before replacing oven light. If the oven is hard wired into a junction box, make sure the breaker that powers the oven is turned off.

The interior oven lights are located at the rear of the oven cavity and are covered with a glass shield. The glass shield must be in place whenever the oven is in use (See Figure 10).

#### **Replacing the oven interior light bulb:**

1. Turn electrical power off at the main source.
2. Remove interior oven light shield by turning a quarter turn.
3. Replace bulb with a new T-4 type Halogen 25 watt appliance bulb.

#### **📌 NOTE**

Do not allow your fingers to touch the new bulb when replacing. This will shorten the life of the bulb. Use a paper towel or cotton glove while handling the new bulb when installing.

4. Replace glass oven light shield.
5. Turn power back on again at the main source.
6. Be sure to reset the time of day on the clock.

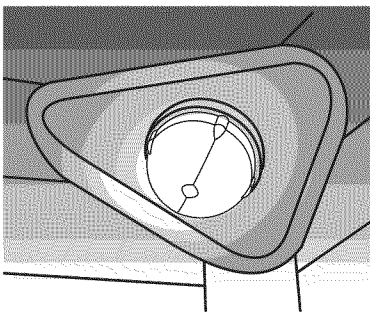

**Figure 10: Wall oven Halogen light**



# BEFORE YOU CALL

## Solutions to Common Baking Problems

For best cooking results, heat the oven before baking cookies, breads, cakes, pies or pastries, etc. There is no need to preheat the oven for roasting meat or baking casseroles.

The cooking times and temperatures needed to bake a product may vary slightly from your previously owned appliance.

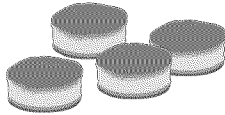
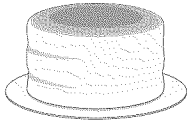
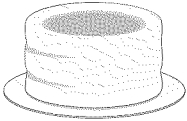
### Baking Problems and Solutions Chart

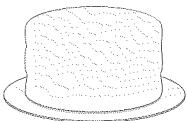
Baking Problems	Causes	Corrections
<b>Cookies and biscuits burn on the bottom.</b> 	<ul style="list-style-type: none"> <li>• Cookies and biscuits put into oven before the preheating time is completed.</li> <li>• Oven rack is overcrowded.</li> <li>• Dark pans absorb heat too fast.</li> </ul>	<ul style="list-style-type: none"> <li>• Allow oven to preheat to desired temperature before placing food in oven.</li> <li>• Choose pan sizes that will permit 2" to 4" of air space (5.1 cm or 10.2 cm) on all sides when placed in the oven.</li> <li>• Use a medium weight baking sheet.</li> </ul>
<b>Cakes too dark on top or bottom.</b> 	<ul style="list-style-type: none"> <li>• Cakes put in oven before preheating time is completed.</li> <li>• Rack position too high or too low.</li> <li>• Oven too hot.</li> </ul>	<ul style="list-style-type: none"> <li>• Allow oven to preheat to the selected temperature before placing food in the oven.</li> <li>• Use proper rack position for baking needs.</li> <li>• Set oven temperature 25°F/12°C lower than recommended.</li> </ul>
<b>Cakes not done in center.</b> 	<ul style="list-style-type: none"> <li>• Oven too hot.</li> <li>• Incorrect pan size.</li> <li>• Pan not centered in oven.</li> </ul>	<ul style="list-style-type: none"> <li>• Set oven temperature 25°F/12°C lower than recommended.</li> <li>• Use pan size suggested in recipe.</li> <li>• Use proper rack position and place pan to allow for 5.1 cm to 10.2 cm (2" to 4") of space on all sides of pan.</li> </ul>
<b>Cakes not level.</b> 	<ul style="list-style-type: none"> <li>• Range not level.</li> <li>• Pan too close to oven wall or rack overcrowded.</li> <li>• Pan warped.</li> </ul>	<ul style="list-style-type: none"> <li>• Place a marked glass measuring cup filled with water on the center of the oven rack. If the water level is uneven, refer to the installation instructions for leveling the range.</li> <li>• Be sure to allow 5.1 cm to 10.2 cm (2" to 4") of clearance on all sides of each pan in the oven.</li> <li>• Do not use pans that are dented or warped.</li> </ul>
<b>Foods not done when cooking time is over.</b> 	<ul style="list-style-type: none"> <li>• Oven too cool.</li> <li>• Oven overcrowded.</li> <li>• Oven door opened too frequently.</li> </ul>	<ul style="list-style-type: none"> <li>• Set oven temperature 25°F/12°C higher than suggested and bake for the recommended time.</li> <li>• Be sure to remove all pans from the oven except the ones to be used for baking.</li> <li>• Open oven door only after shortest recommended baking time.</li> </ul>

## Solutions to Common Problems

Before you call for service, review the following list. It may save you time and expense. Possible solutions are provided with the problem listed:

Problem	Solution
Poor baking results	Many factors effect baking results. Use proper oven rack position. Center food in the oven and space pans to allow air to circulate. Preheat oven to the set temperature before placing food in the oven. Try adjusting the recipe's recommended temperature or baking time. See "Adjusting oven temperatures" on page 23 if you feel the oven is too hot or cold.
Appliance is not level	Be sure floor is level, strong and stable enough to adequately support range. If floor is sagging or sloping, contact a carpenter to correct the situation.  Poor installation. Place oven rack in center of oven and place a level on the oven rack. Adjust leveling legs at base of appliance until the rack is level.  Kitchen cabinet alignment may make range appear not level. Be sure cabinets are square and have sufficient room for appliance clearance.
Cannot move appliance easily. Appliance must be accessible for service.	Cabinets not square or are built in too tight to allow clearance for appliance. Contact builder or installer to make appliance accessible.  Carpet interferes with appliance. Provide sufficient space so appliance can be lifted over carpet.
Entire appliance does not work.	For models with a power cord, make sure power cord is plugged properly into outlet. If electricity to home is working, check fuse box or breaker. Call your local electric company for service outage information.  Service wiring is not complete. Call 1-800-4-MY-HOME® for assistance.
Oven portion does not operate.	The time of day is not set. The oven clock must first be set in order to operate the oven. See "Setting the Clock" on <sup>a</sup>  Be sure oven controls are set properly. See "Oven Control Functions" on page 14 and review instructions for the desired cooking function in this manual or see "Entire appliance does not operate" in this checklist.
Oven light does not work.	Be sure the oven light is secure in the socket. See "Replacing the oven light" on page 19
Cooking zones do not glow when heating.	Induction cooking zones will not glow when in use. Induction cooking uses electromagnetic energy to induce heat directly to the cookware.
Flames inside oven or smoking from oven vent.	Excessive spills in oven. Grease or food spilled onto oven bottom or oven cavity. Wipe up excessive spills before starting oven. If flames or excessive smoke are present when using Broil, see "Setting Broil" page 12.
Self Clean does not work.	Oven control not set properly. Review instructions in Self Clean section.
Oven racks discolored or do not slide easily.	Oven racks left in oven cavity during Self Clean. Always remove oven racks from oven cavity before starting a self-clean cycle. Clean by using a mild abrasive cleaner following manufacturer's instructions. Rinse with clean water, dry, and replace in oven.

## BEFORE YOU CALL

Oven smokes excessively when broiling.	<p>Incorrect setting. Follow broiling instructions in Setting Oven Controls section.</p> <p>Meat too close to the broil element. Reposition broil rack to provide proper clearance between the meat and broil element. Remove excess fat from meat. Cut remaining fatty edges to prevent curling, but do not cut into lean.</p> <p>Grease build up on oven surfaces. Regular cleaning is necessary when broiling frequently. Grease or food splatters will cause excessive smoking.</p>
Oven control panel beeps and displays any F or E code error.	<p>Oven control has detected a fault or error condition. Press Clear off key to clear the error code. Try Bake or Broil function. If the F or E code error repeats, turn OFF power to appliance, wait 5 minutes and then repower appliance. Set clock with correct time of day. Try Bake or Broil function again. If fault recurs, press Clear off to clear and call 1-800-4-MY-HOME® for assistance.</p>
Soil not completely removed after Self Clean.	<p>Self Clean was interrupted. Review instructions in Self Clean section.</p> <p>Excessive spills on oven bottom. Clean before starting Self Clean.</p> <p>Failure to clean soil from the oven frame, the door liner outside the oven door gasket and the small area at the front center of the oven bottom. These areas are not in the self-cleaning area, but get hot enough to burn on residue. Clean these areas before starting the self-cleaning cycle. Burned-on residue can be cleaned with a stiff nylon brush and water or a nylon scrubber. Be careful not to damage the oven gasket.</p>
Convection fan does not rotate.	<p>Oven door is open. Convection fan will turn off if oven door is opened when Convection is active. Close oven door.</p>
Oven racks discolored or do not slide easily.	<p>Oven racks left in oven cavity during Self Clean. Always remove oven racks from oven cavity before starting a self-clean cycle. Clean by using a mild abrasive cleaner following manufacturer's instructions. Rinse with clean water, dry, and replace in oven.</p>
Self Clean does not work.	<p>Oven control not set properly. Review instructions in Self Clean section.</p>

a.

Your appliance is covered by a one year limited warranty. For one year from your original date of purchase, Electrolux will pay all costs for repairing or replacing any parts of this appliance that prove to be defective in materials or workmanship when such appliance is installed, used and maintained in accordance with the provided instructions.

#### Exclusions

This warranty does not cover the following:

1. Products with original serial numbers that have been removed, altered or cannot be readily determined.
2. Product that has been transferred from its original owner to another party or removed outside the USA or Canada.
3. Rust on the interior or exterior of the unit.
4. Products purchased "as-is" are not covered by this warranty.
5. Food loss due to any refrigerator or freezer failures.
6. Products used in a commercial setting.
7. Service calls which do not involve malfunction or defects in materials or workmanship, or for appliances not in ordinary household use or used other than in accordance with the provided instructions.
8. Service calls to correct the installation of your appliance or to instruct you how to use your appliance.
9. Expenses for making the appliance accessible for servicing, such as removal of trim, cupboards, shelves, etc., which are not a part of the appliance when it is shipped from the factory.
10. Service calls to repair or replace appliance light bulbs, air filters, water filters, other consumables, or knobs, handles, or other cosmetic parts.
11. Surcharges including, but not limited to, any after hour, weekend, or holiday service calls, tolls, ferry trip charges, or mileage expense for service calls to remote areas, including the state of Alaska.
12. Damages to the finish of appliance or home incurred during installation, including but not limited to floors, cabinets, walls, etc.
13. Damages caused by: services performed by unauthorized service companies; use of parts other than genuine Electrolux parts or parts obtained from persons other than authorized service companies; or external causes such as abuse, misuse, inadequate power supply, accidents, fires, or acts of God.

#### DISCLAIMER OF IMPLIED WARRANTIES; LIMITATION OF REMEDIES

CUSTOMER'S SOLE AND EXCLUSIVE REMEDY UNDER THIS LIMITED WARRANTY SHALL BE PRODUCT REPAIR OR REPLACEMENT AS PROVIDED HEREIN. CLAIMS BASED ON IMPLIED WARRANTIES, INCLUDING WARRANTIES OF MERCHANTABILITY OR FITNESS FOR A PARTICULAR PURPOSE, ARE LIMITED TO ONE YEAR OR THE SHORTEST PERIOD ALLOWED BY LAW, BUT NOT LESS THAN ONE YEAR. ELECTROLUX SHALL NOT BE LIABLE FOR CONSEQUENTIAL OR INCIDENTAL DAMAGES SUCH AS PROPERTY DAMAGE AND INCIDENTAL EXPENSES RESULTING FROM ANY BREACH OF THIS WRITTEN LIMITED WARRANTY OR ANY IMPLIED WARRANTY. SOME STATES AND PROVINCES DO NOT ALLOW THE EXCLUSION OR LIMITATION OF INCIDENTAL OR CONSEQUENTIAL DAMAGES, OR LIMITATIONS ON THE DURATION OF IMPLIED WARRANTIES, SO THESE LIMITATIONS OR EXCLUSIONS MAY NOT APPLY TO YOU. THIS WRITTEN WARRANTY GIVES YOU SPECIFIC LEGAL RIGHTS. YOU MAY ALSO HAVE OTHER RIGHTS THAT VARY FROM STATE TO STATE.

#### If You Need Service

Keep your receipt, delivery slip, or some other appropriate payment record to establish the warranty period should service be required. If service is performed, it is in your best interest to obtain and keep all receipts. Service under this warranty must be obtained by contacting Electrolux at the addresses or phone numbers below.

This warranty only applies in the USA and Canada. In the USA, your appliance is warranted by Electrolux Major Appliances North America, a division of Electrolux Home Products, Inc. In Canada, your appliance is warranted by Electrolux Canada Corp. Electrolux authorizes no person to change or add to any obligations under this warranty. Obligations for service and parts under this warranty must be performed by Electrolux or an authorized service company. Product features or specifications as described or illustrated are subject to change without notice.

USA  
1.800.944.9044  
Electrolux Home Products, Inc.  
10200 David Taylor Drive  
Charlotte, NC 28262



Canada  
1.800.265.8352  
Electrolux Canada Corp.  
5855 Terry Fox Way  
Mississauga, Ontario, Canada  
L5V 3E4