

en-us Use and care manual

Dryer
WTB86200UC

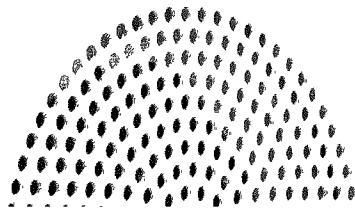
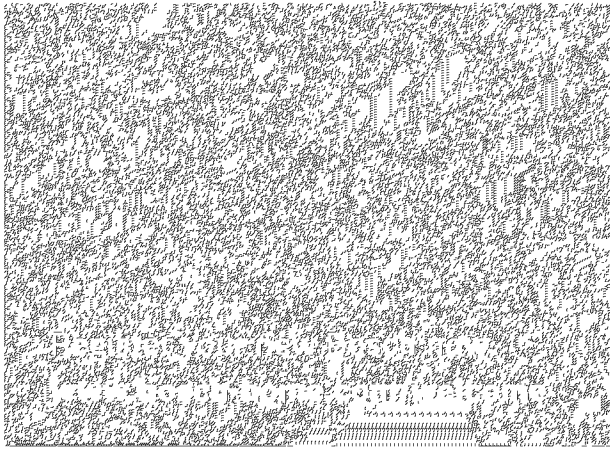
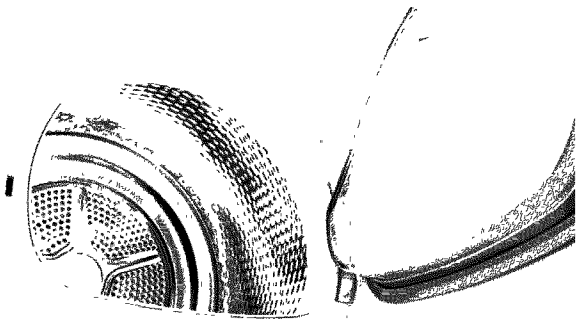

Welcome to Your New Dryer!

Congratulations on your selection of a new Bosch dryer for your laundry needs. We are confident you will enjoy the superior performance and reliability.

Please do not hesitate to contact our Customer Service department if you have any questions or comments with your new dryer.

Thank you for choosing Bosch.

Visit our web site at www.bosch-home.com for more information and to view a selection of our products.

Table of contents

Important information	4	Loading the laundry	23
Purchase information	4	Starting the program	23
Customer service	4	Indicator of program sequence	24
Your dryer is intended for	5	Childproof lock	24
Importance and meaning of symbols	5	Selecting a different program	24
IMPORTANT SAFETY INSTRUCTIONS	6	Cancel program	24
Introduction to your new dryer	7	Program end	24
Standard features and helpful information	7	Removing laundry/switching the appliance off	24
Special features	7	Signal	24
Environmentally friendly use of your dryer	7	Cleaning and care	25
Dimensions and clearances required	8	Cleaning the housing and control panel	25
Installation for best performance	8	Cleaning the lint filter	25
Appliance dimensions	8	Cleaning the heat exchanger	26
Length of power cord and drain hose	8	Cleaning the moisture sensors	27
Minimum clearances	8	Cleaning the lint filter area	27
Installation Instructions	10	Maintenance of drain hose	27
Introduction	10	Troubleshooting	28
Before installing the dryer	10	Introduction	28
Waste disposal	10	Troubleshooting	28
Parts provided with your dryer	11	STATEMENT OF LIMITED PRODUCT WARRANTY ...	30
Accessories for your appliance	11	Bosch Clothes Dryer	30
Installation - step by step	11		
Electrical Connections	13		
Leveling the dryer	14		
Check heating system	15		
Preparing to transport the dryer - step by step	15		
Getting to know your appliance	16		
Control panel	16		
Display area	17		
Laundry	17		
Preparing the laundry	17		
Sorting the laundry	17		
Drying tips	17		
Program selection table	18		
Program settings	19		
Time Dry	19		
Dry Level	19		
Finished in	19		
Additional options	19		
Low Heat	19		
Wrinkle Block	19		
Operating Instructions	20		
Your new dryer	20		
Before using the dryer for the first time	21		
Temporary disconnection of the dryer	21		
Using the program selector to choose a drying cycle	21		
Program selection	22		
Selecting program settings and additional options	22		

Additional information on products, accessories, replacement parts and services can be found at www.bosch-home.com and in the online shop www.bosch-eshop.com

Questions?
1-800-944-2904
www.bosch-home.com
1901 Main Street, Suite 600
Irvine, CA 92614
We look forward to hearing from you!

Important information

Purchase information

Please take a moment to record the following basic information about the purchase of your new Bosch dryer. This information will be helpful in the event you need to contact Customer Service or would like to order accessories or replacement parts for your dryer.

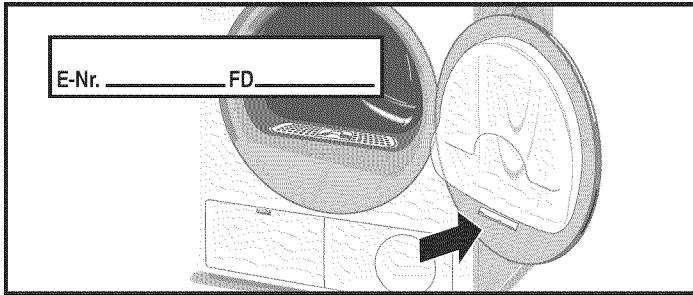

The **E-Nr.** (model number) and the **FD** (serial) number are found on the rating plate label.

The model number includes the slash and a two digit number (eg: "/01"). Please be sure to include the final 2 digit number when filling in your model number. This helps make sure any parts you may need are correctly matched to your specific machine.

Date of Purchase: ___/___/___

Where Purchased: _____

E-Nr. : _____/___ (ex: WTB86202UC/01)

FD : _____-_____ (ex: FD 9304|90007, provides production date)

Customer service

Your dryer does not require any special care other than the maintenance and care mentioned in this manual. If you have a problem with your dryer, please consult → *Troubleshooting; Page 28.*

This may save you money. If a technician comes out to advise you of information that is in the Troubleshooting table you may be charged, even if your dryer is still under warranty.

If service becomes necessary, contact your dealer or installer or an authorized service center. Do not attempt to repair the appliance yourself. Any work performed by unauthorized personnel may void the warranty.

If you are having a problem with your dryer and are not pleased with the service you have received, please follow these steps:

1. Contact your installer or the Authorized Service Contractor in your area and explain to them why you are not satisfied. This will usually correct the problem.
2. If after working with your installer or service technician the problem still has not been resolved to your satisfaction, please let us know either by writing to us at:

BSH Home Appliances
1901 Main Street, Suite 600
Irvine, CA 92614

or calling us at:
1-800-944-2904

When writing or calling please have the following information available:

- E-Nr. (model number, example: WTB86202UC/01)
- FD (serial number, example: 9304|90007)
- Date of Original Purchase (receipt required)
- Date Problem Occurred
- Explanation of Problem

If writing, please also include a daytime telephone number and a copy of the sales invoice.

When calling Customer Service, please be ready to provide the model number **E-Nr.** and **FD** number. This information will help provide the best support for your dryer.

Additional information is available at our website:
www.bosch-home.com

Your dryer is intended for

- Only for household use and in a non-commercial environment.
- Household use only for drying washable textiles.
- The dryer can be operated by people with reduced physical, sensory or mental capabilities, and by people with little experience or knowledge if they **are supervised** or **were trained** by a responsible person.
- Children may not do any laundry without supervision.
- Keep pets away from the dryer.
- Recommended operating conditions:
Ambient temperature: 41-95°F / 5-35°C
Relative humidity: under 95%
- Installation by qualified installers.
- Installation in accordance with all regulatory requirements; if in doubt have the appliance installed by a specialist familiar with these requirements.

Read the use and set-up instructions and all other information included with the dryer and act accordingly.

Keep documents for future use.

Importance and meaning of symbols

Important safety information is contained in this manual and on the warning labels located on your dryer.

Standard symbols and headings are used to identify areas where you should take precautions to avoid injury or damage. Please take a moment to become familiar with each of these symbols and what they mean before proceeding.

▲ WARNING

WARNING

This indicates that death or serious injuries may occur as a result of non-observance of this warning.

▲ CAUTION

CAUTION

This indicates that minor or moderate injuries may occur as a result of non-observance of this warning.

NOTICE: This indicates that damage to the appliance or property may occur as a result of non-observance of this warning.

Tip: This symbol is used to draw the user's attention to important matters.

IMPORTANT SAFETY INSTRUCTIONS

READ AND SAVE THESE INSTRUCTIONS

WARNING

When properly cared for, your new appliance has been designed to be safe and reliable. Read all instructions carefully before use. These precautions will reduce the risk of burns, electric shock, fire, and injury to persons. When using laundry appliances, basic safety precautions must be followed, including those in the following pages.

Examine the appliance after unpacking it. In the event of transport damage, do not plug it in.

WARNING

TO REDUCE THE RISK OF FIRE, ELECTRIC SHOCK, SERIOUS INJURY OR DEATH WHEN USING YOUR DRYER, FOLLOW BASIC PRECAUTIONS INCLUDING THE FOLLOWING

- Bosch dryers are provided with an Operating, Care and Installation Instruction manual. Read and understand all instructions before using the dryer.
 - Do not dry articles that have been previously cleaned, washed, soaked, or spotted with gasoline, dry cleaning solvents, other flammable or explosive substances as they give off vapors that could ignite or explode.
 - Before the appliance is removed from service or discarded, remove the door to prevent children from playing or hiding inside. Also remove the power cord/plug.
 - Do not allow anyone to climb, lean or hang on any part of the dryer including any protruding components such as the appliance door or a pullout shelf.
 - Do not reach into the appliance if the drum is rotating.
 - Do not tamper with the controls.
 - Do not repair or replace any part of the appliance or attempt any service unless specifically recommended in the user manual or in published user repair instructions that you understand and have the skills to carry out.
 - Do not use fabric softeners or products to eliminate static unless recommended by the fabric manufacturer.
 - Always unplug the dryer from the power supply before attempting any service. Disconnect the power cord by grasping the plug, not the cord.
 - To reduce the risk of fire, clothes, cleaning rags, mop heads and the like which have traces of any flammable substance, such as vegetable oil, cooking oil, petroleum based oils or distillates, waxes, fats, etc., must not be placed in the dryer. These items may contain some flammable substance(s) even after washing, which may smoke or catch fire by itself.
 - Do not place items exposed to cooking oils in your dryer. Items contaminated with cooking oils may contribute to a chemical reaction that could cause a load to catch fire.
 - Do not use heat to dry articles containing foam rubber (may be labeled latex foam) or similarly textured rubber-like materials. Foam rubber materials can ignite by spontaneous combustion.
 - Keep flammable materials and vapors, such as gasoline, away from the dryer.
 - Clean lint filter before or after each load.
 - The interior of the machine should be cleaned periodically by qualified service personnel.
 - Do not install or store the dryer where it will be exposed to the weather. Hoses and internal parts may be damaged if exposed to freezing temperatures.
 - Do not use the dryer if it has a worn power cord or loose plug.
 - The dryer must only be used for its intended purpose.
 - Always follow the fabric care instructions recommended by the clothing manufacturer.
 - Do not operate the dryer if parts are missing or broken.
 - Do not sit on top of the dryer.
 - To reduce the risk of fire or electrical shock, DO NOT use an extension cord or an adapter to connect the dryer to the electrical power supply.
 - Use the integrated socket only for listed appliances.
 - Always check pockets and remove any objects. Cigarette lighters are particularly hazardous.
 - Do not operate the dryer if any guards and/or panels have been removed.
 - Do not bypass any safety devices.
 - Do not operate this dryer until you are sure that:
 - The dryer, all services (water, power, drain etc.) has been installed according to the Installation Instructions.
 - All installation and grounding are in compliance with all local regulations and/or other applicable regulations and requirements.
 - Failure to install, maintain and/or operate the dryer according to the manufacturer's instructions may result in injury and/or damage.
 - To avoid floor damage and mold growth, do not let spills or splashout cause standing water around or under the appliance.
 - See the installation instructions in this manual for grounding requirements.
→ *Electrical Connections; Page 13*
 - The IMPORTANT SAFEGUARDS and WARNINGS presented in this manual do not cover all possible conditions that may occur. Common sense, caution and care must be exercised when installing, maintaining or operating the dryer.
 - Always contact your dealer, distributor, service agent or the manufacturer about any problems or conditions that you do not understand.
 - Follow the Safety Information in the INSTALLATION INSTRUCTIONS and the OPERATING INSTRUCTIONS.
-

⚠ **IMPORTANT SAFETY INSTRUCTIONS**

READ AND SAVE THESE INSTRUCTIONS

WARNING

WARNINGS FOR CHILDREN

- Do not allow children to play on or in the appliance. Close supervision of children is necessary when the appliance is used near children.
- Make sure to utilize all child lock/safety features of your appliance, and be sure to turn the appliance **Off** when not in use.
- Appliances are not intended for use by children, however when children become old enough to operate the appliance, it is the responsibility of the parents or legal guardians to ensure they are instructed in safe practices by qualified persons.

- Keep all laundry aids (including detergents, bleach, fabric softener, etc.) out of the reach of children.
-

WARNING

STATE OF CALIFORNIA PROPOSITION 65 WARNINGS

This product contains chemicals known to the State of California to cause cancer, birth defects or other reproductive harm.

SAVE THESE INSTRUCTIONS!

Keep These Instructions for Future Reference.

In case of change of ownership, manual should be conveyed with the dryer.

Introduction to your new dryer

⚠ **WARNING**

RISK OF FIRE, ELECTRIC SHOCK OR INJURY

To reduce the risk of fire, electric shock or injury to persons, read the IMPORTANT SAFETY INSTRUCTIONS of this manual before installing or operating this appliance.

→ *IMPORTANT SAFETY INSTRUCTIONS; Page 6*

About this manual

These operating and installation instructions apply to more than one model of dryer. Illustrations used may show details that differ from your particular model.

Read your user manual. It contains valuable information about safety, installation and operation of your new appliance.

This can save your time, make it easier to correctly install and use your dryer, and improve your overall satisfaction with your new appliance.

Standard features and helpful information

Thank you for choosing Bosch for your laundry appliance needs.

Please read and follow the use and care, important safety instructions and troubleshooting information contained in this manual. Please retain this manual for future reference.

This dryer complies with UL 2158 A Electric Clothes Dryers.

Standard features

- Sensor controlled auto cycles.
- 15.4 lb (7 kg) large drum capacity (for regular cotton loads).
- Large door opening, 180° opening angle.

Quality tested

Each dryer which leaves our factory has undergone a thorough performance test and is in full working condition.

Web Site

Visit our web site at www.bosch-home.com for more information and to view a selection of our products.

Special features

- A distinctive feature of your dryer is low energy consumption.
- An easy operation philosophy, a variety of customized drying programs and solid touch and feel make this appliance a user-friendly assistant in your household.
- Load adjust matches power consumption to each cycle according to the amount of laundry sensed in the drum and the type of fabric.
The load adjust function runs automatically to keep energy consumption as low as possible.

Environmentally friendly use of your dryer

Your new Bosch dryer is designed to use energy in a highly efficient way to help reduce operating costs, conserve resources and protect the environment.

To save energy, money and time, Bosch recommends the following:

- **Drain the laundry thoroughly!**
Before drying, spin the laundry thoroughly in the washing machine. Use the highest possible spin speed for the type of laundry! Higher spin speeds reduce the drying time and the energy consumption.

- **Use optimum load!**
Utilize the maximum amount of laundry for the appropriate cycle. However, do not exceed loads.
- **Clean filter!**
Clean the lint filter before or after each drying process.
→ *Cleaning the lint filter; Page 25*

- **Air inlet on the dryer!**
Do not cover or allow any articles/items to restrict the air inlet on the front of the dryer.
- **Energy-saving mode!**
The display panel lighting goes out after a few minutes and **Start**/Pause flashes. To activate the display, press any button.
Energy-saving mode is not activated if a program is running.

Dimensions and clearances required

Installation for best performance

▲ CAUTION

DO NOT INSTALL THE DRYER:

- outdoors,
- in an environment with dripping water,
- near flammable materials,
- in rooms which are at risk of frost,
- in rooms which may contain gas or other fuels,
- on carpets.

The dryer should be installed in an open area with no restrictions to ambient air for the best drying results. Space allowances to fully open the door should also be considered.

Do not operate the dryer at temperatures above 95 °F (35 °C) or below 41 °F (5 °C). Low temperatures affect the drying process and may prolong the drying times.

The installation surface (floor) must be level and structurally sound. Using the bubble level and the height-adjustable feet installed on the appliance, level the appliance side to side and front to back.

Appliance dimensions

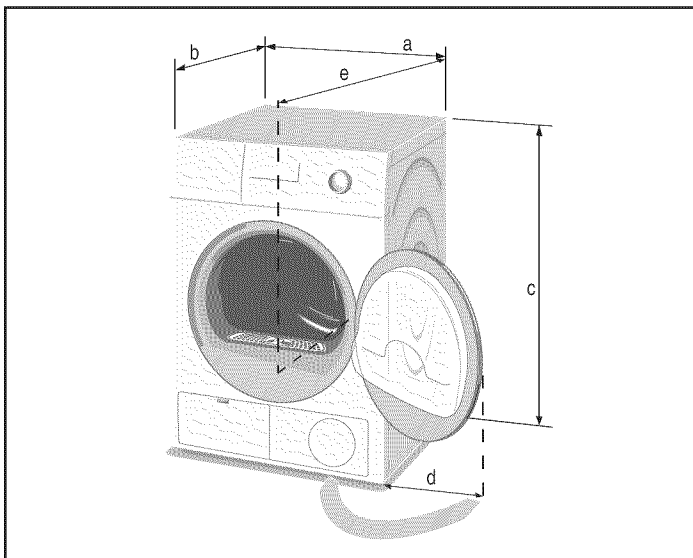

Label	Dimension	U.S. Inches	Metric cm
a	Width	23.6	60
b	Depth (to front of door)	25	63.5
c	Height (minimum)	33.2	84.3
	Height (maximum)	34	86.4
d	Side clearance (door open 180°)	16	40.6
e	Depth (door open 90°)	42.9	109

Length of power cord and drain hose

	To Left*		To Right*	
	U.S. Inches	Metric cm	U.S. Inches	Metric cm
Power Cord	42	106.7	60	152.4
Drain Hose	76	193	55	139.7

* Facing the front of the dryer

Minimum clearances

Closet: Stacked

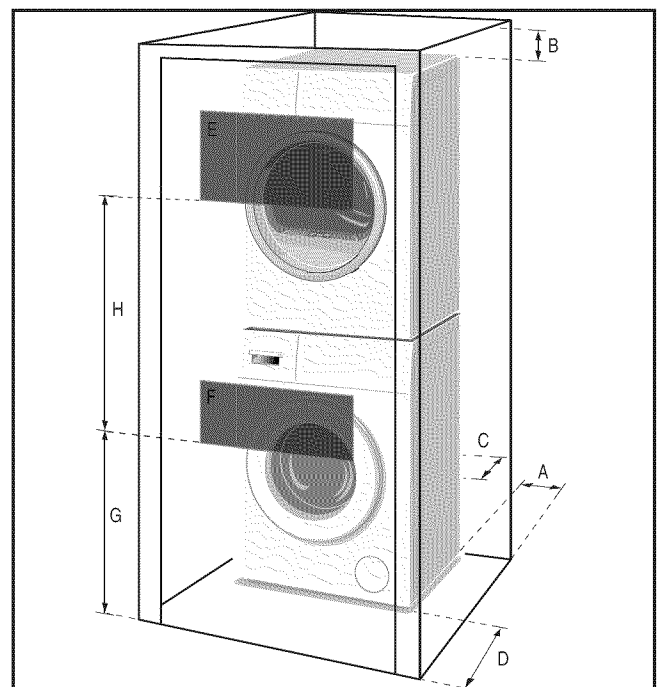

Closet: Stand alone (shown) or Side by Side

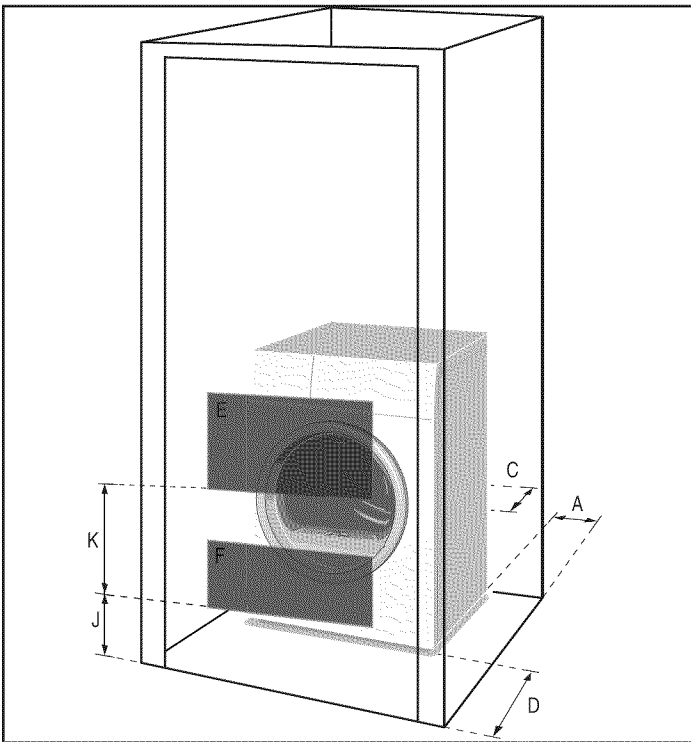

Label	Dimension	U.S. Inches	Metric cm
A	Both Sides	0.6	1.5
B	Top	6.3	16
C	Rear	2.5	6.2
D	Front	2.4	6
E & F are minimum area size!			
E	Top Vent	63 sq.	404 sq.
F	Bottom Vent	63 sq.	404 sq.
Vent spacing is actual (not minimum dimensions)			
G		37	94
H		26	66
J		3	7.6
K		29	73.6

Under counter (Preferred)

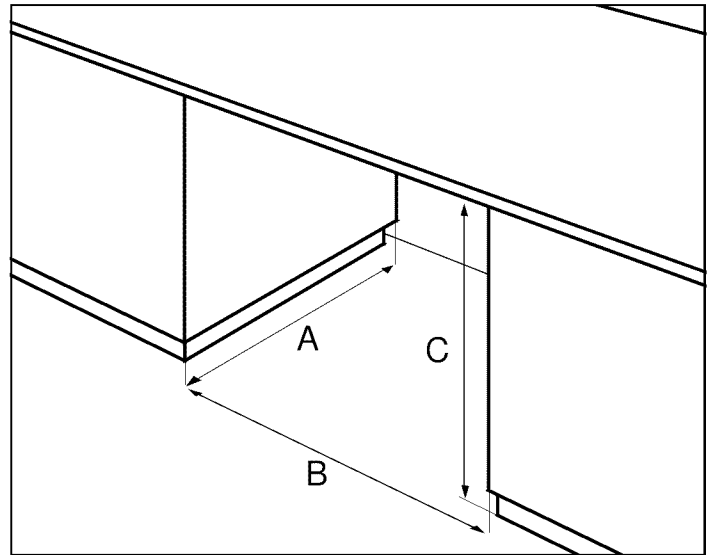

Front of the appliance fully open.
No doors or coverings.

Minimum opening dimensions

A	23.8 in.	60.5 cm
B	23.8 in.	60.5 cm
C	33.5 in.	85 cm

Under counter (Less Desirable)

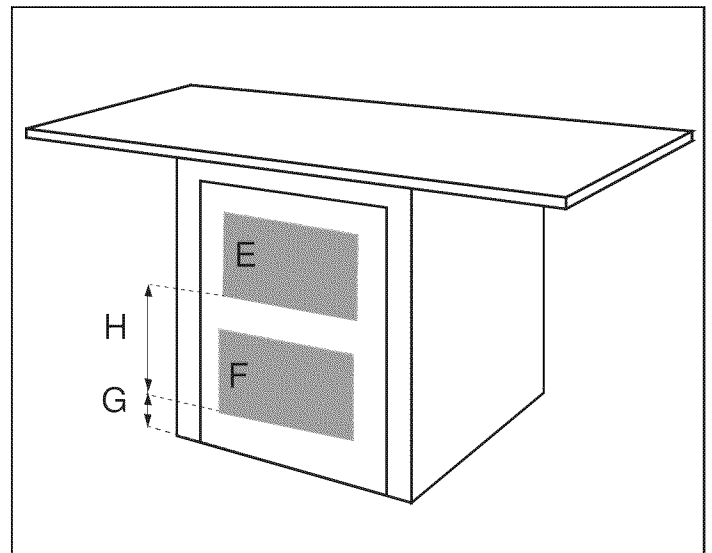

If front of the appliance is covered ventilation openings must be installed.

E & F are minimum area sizes

E	63 sq.in.	404 sq. cm
F	63 sq.in.	404 sq. cm

G & H

actual spacing dimensions for min. open area sizes

G	3 in.	7.6 cm
H	14 in.	35.6 cm

Installation Instructions

SAVE THESE INSTRUCTIONS

Introduction

Read these installation instructions completely and carefully before starting to install your new dryer. The information contained can save you time and effort and will help to ensure optimum performance of your new dryer. Be sure to observe all warnings and cautions.

WARNING

▲ WARNING

RISK OF FIRE, ELECTRIC SHOCK OR INJURY TO PERSONS

- To reduce the risk of fire, electric shock or injury to persons, read the Important Safety Instructions at the beginning of this manual before installing or operating this appliance.
- Clothes dryer installation must be performed by a qualified installer, according to these instructions and according to all local codes. In addition to the installation and safety information in this manual, the local water and electrical power suppliers (services) may have special requirements.

▲ CAUTION

- Dryer is heavy. Do not lift it by yourself, use additional help and care when lifting and positioning.
- If in doubt, have the appliance installed and connected by an authorized technician.
- Take care to not damage the appliance. Do not hold on to protruding parts (e.g. door) when lifting.
- Do not install the appliance outdoors or in an area exposed to freezing conditions.
- If freezing conditions exist where appliance is located all drain water must be removed from hoses, sumps, pumps, etc.

These installation instructions are intended for use by qualified installers. In addition to these instructions, the installation must comply with:

- for the United States - National Electrical Code, ANSI/NFPA70 - and latest editions of the State and Municipal and/or local regulations.
- for Canada - Canadian Electrical Code C22.1 - and the latest editions of the Provincial, Municipal and/or local regulations.

Before installing the dryer

Unpacking the appliance

▲ CAUTION

Remove the appliance packaging carefully to prevent damage to the surfaces.

After removing the packaging, immediately remove any objects from the drum.

Check the dryer for transportation damage. Do not connect a dryer which is visibly damaged. If in doubt, contact your dealer.

Waste disposal

Disposal of Packaging Materials

After unpacking your new appliance dispose of the protective packaging materials in an environmentally friendly way. Ask your dealer or inquire with your local authority regarding currently acceptable means of disposal.

▲ WARNING

WARNINGS FOR CHILDREN

Do not let children play with packaging and associated parts to avoid risk of choking or suffocation.

Disposal of Your Old Appliance

Your old appliance can be recycled if it is no longer to be used. Prior to disposing of your old appliance observe the following precautions to reduce safety risks.

▲ WARNING

TO AVOID RISK OF INJURY OR DEATH, DO THE FOLLOWING

- after unplugging the old appliance, remove the electric power cord and dispose of properly.
 - remove the door or permanently disable the door lock to prevent children from being locked inside.
-

Parts provided with your dryer

Back side of the dryer

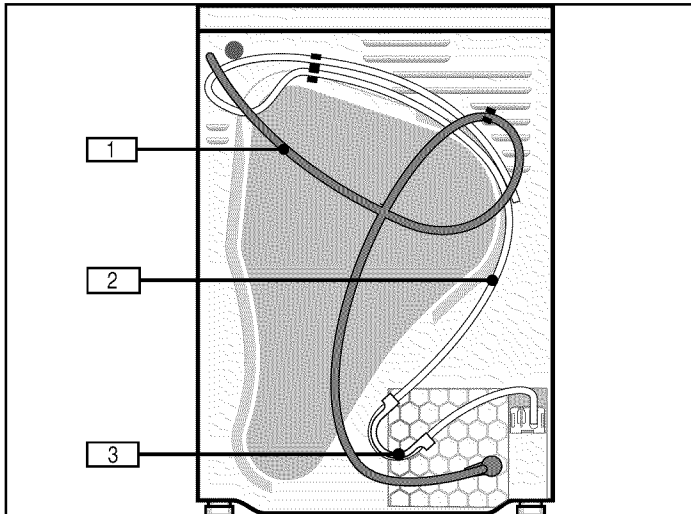

- 1 power cord with plug
- 2 drain hose connected to the dryer
- 3 elbow to form the hose to fit the drain

Dryer drum contents

A literature pack and drain hose pack are shipped in the dryer drum. Be sure to remove these items before using the dryer.

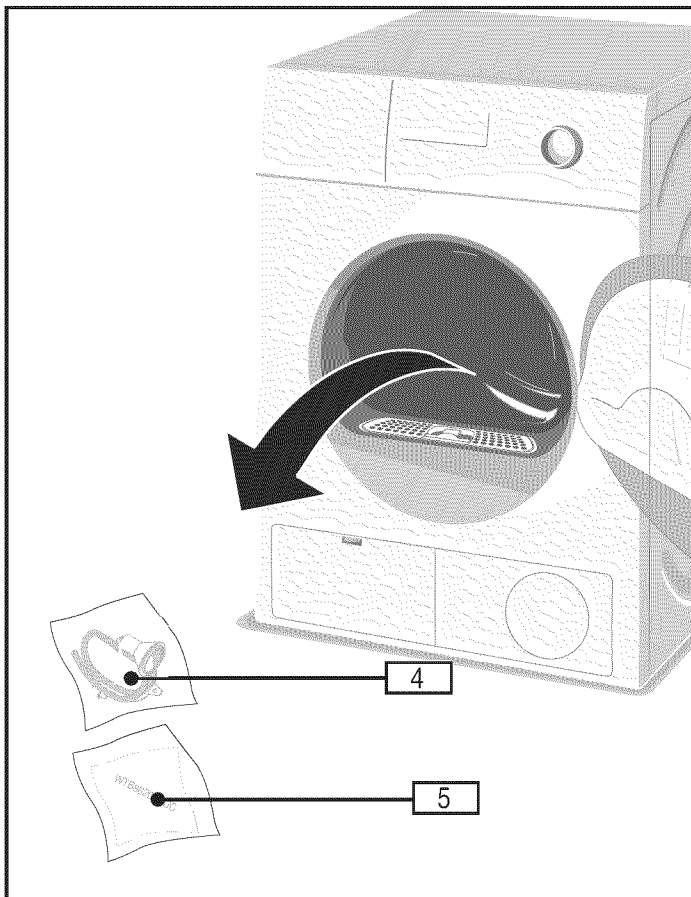

- 4 drain hose pack contents:
 - (2) plastic ties for securing drain hose
 - plastic connector
 - summary of drain hose installation instructions
- 5 literature pack contents:
 - User manual
 - Warranty

NOTICE: If any parts are missing please notify your dealer immediately.

Accessories for your appliance

Pedestal

The dryer can be mounted on a special pedestal for easier loading and unloading.

Pedestal item number: **WMZ 20500**

Stacking kits

The dryer can be stacked on a Bosch washer of the same dimensions to save space.

Stacking kits without a shelf: **WTZ20410**

Stacking kits with a shelf: **WTZ11400**

Accessories can be purchased from customer service or your local dealer.

→ *Customer service; Page 4*

Installation - step by step

1. Unpack the dryer.
2. Remove all objects from the dryer drum.
3. Check the dryer for visible damage.
4. Position the dryer near the installation location.
5. Disconnect the power cord and drain hose from their clips on the back of the dryer.

⚠ CAUTION

Do not disconnect the drain hose from the sump/pump connection at the bottom of the dryer.

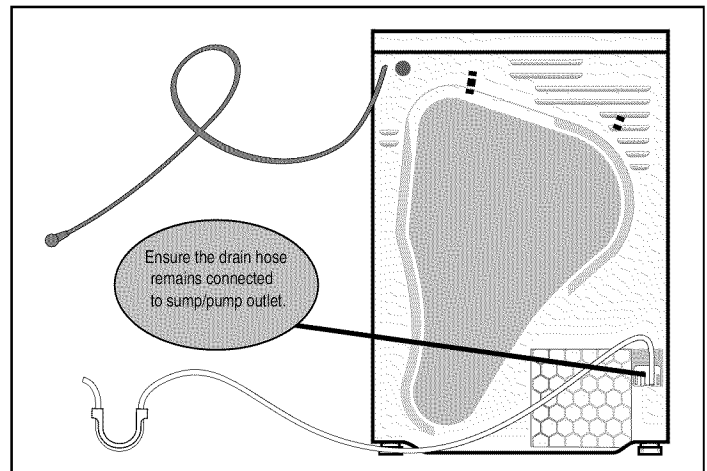

NOTICE: Do not reuse an old or different drain hose. Only use the drain hose included with the dryer.

- Connect the outlet end of the drain hose to a standpipe or other drain inlet. Examples are shown below.

CAUTION

APPLIANCE DAMAGE COULD OCCUR IF DRAIN WATER FLOWS BACK INTO THE APPLIANCE

In all drain conditions, scenarios, or connections you must ensure:

- The drain water from the hose is free flowing and not obstructed allowing adequate water flow.
- Drain opening is not sealed in any way and ventilated enough not to cause a back siphon.
- The end of the drain hose does not protrude into the pumped out or standing water.
- Be sure to follow all local codes and regulations in draining the condensate water to a suitable drain.

Examples of connections:

- Plumbing box or Standpipe connection:
For most plumbing box installations (with adjacent washer) the plastic elbow supplied with the dryer will not be used and must be removed from the dryer drain hose.
- Fasten the dryer drain hose to the washer drain/elbow as shown in picture "A". Secure with plastic ties supplied.

CAUTION

Do not over tighten plastic ties pinching or causing a restriction in the drain hose.

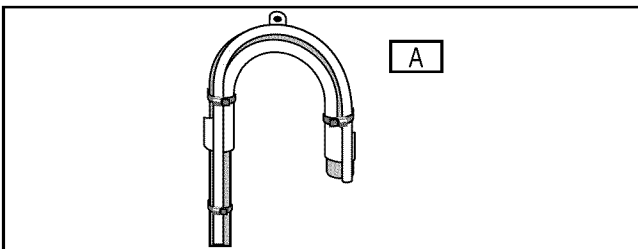

- Place drain hose assembly into standpipe as shown in picture "B".

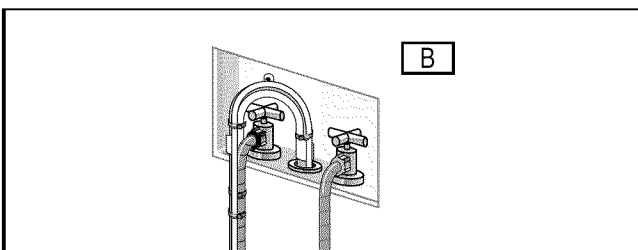

- Sink/Basin or Floor drain:
If using the elbow supplied on the hose re-position elbow closer to the drain end of hose and fasten with the plastic ties as shown in picture "C".

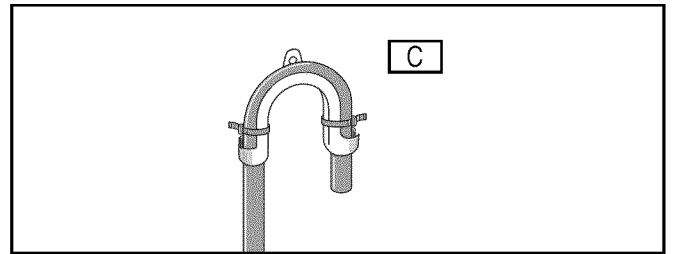

Secure hose and/or elbow as shown below. Basin "D" or floor "E".

NOTICE: Examples shown are for reference only. Not all fittings, connectors, nuts, brackets, ties, etc. are supplied to accommodate every application.

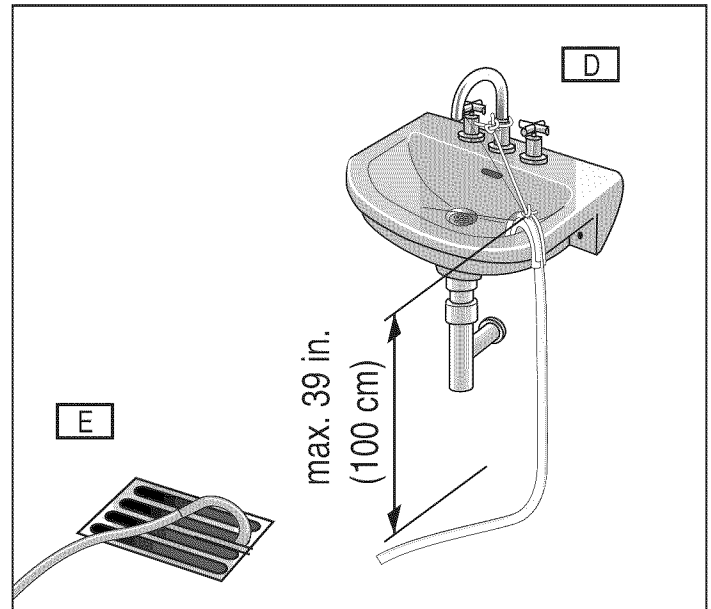

Maximum height of drain is 39 in. (100 cm).

- Sink Drain Pipe:
Attach and secure drain hose as shown below in picture "F".
Use a standard hose clamp available from your local hardware store.

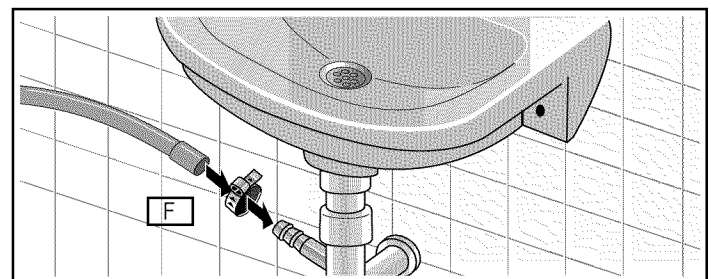

NOTICES

- Examples shown are for reference only. Not all fittings, connectors, nuts, brackets, ties, etc. are supplied to accommodate every application.
- Ensure there are no kinks or crimps along the entire length of hose.

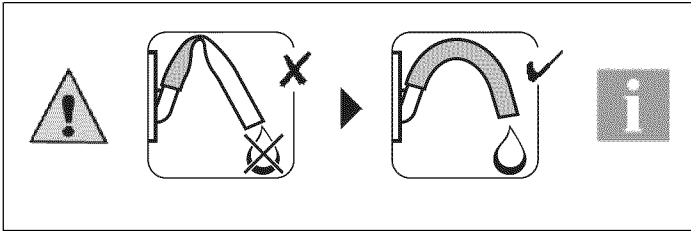

- If installed in an upper floor of a multi-story building, the dryer should be installed on a drained floor to prevent water damage to lower floors in the event of a leak.

Electrical Connections

Power Cord

The attached power cord is a standard 4-wire dryer cord and is UL approved and listed in the USA and Canada. It meets the following requirements:

- 208-240 volt rated (minimum);
- 30 amps;
- Type SRDT or DRT (UL 2158A).

NOTICE: If your specific installation requires a 3-wire power cord follow the installation instructions for such in the next section of this manual.

ALL ELECTRICAL CONNECTIONS AND CIRCUITS

▲ WARNING

ELECTRIC SHOCK

- Do not pull on the power cord to unplug the dryer.
- Protect the power cord from physical damage such as being twisted, kinked, pinched, or walked on for example.
- DO NOT use an extension cord or an adapter to connect the dryer to the power supply.
- Make sure:
 - The power cord fits into the outlet/receptacle.
 - The home's internal power supply circuit wire size is sufficient and electrically grounded.
- The outlet/receptacle used to power the dryer must be connected to an individual 30 amps Branch Circuit.
- Do not cut, remove or bypass the grounding prong on the power cord end.
- Do not modify the plug provided. If the plug will not fit into the outlet/receptacle have it inspected by a qualified electrician.
- The power cord must only be replaced by a qualified technician or licensed electrician to help avoid a fire/electric shock hazard.

Replacement power cords are available through our Customer Service department.

- Use only a UL listed 30 amps power cord.
- Do not reuse old power cord.
- Do not make a sharp bend or crimp wiring or conductors at connections.
- Use only a 4-wire/conductor power cord when the appliance is installed in a mobile home, recreational vehicle, in a new branch-circuit installations or where the local codes do not permit grounding through the neutral.

▲ WARNING

ELECTRIC SHOCK

To reduce the risk of electrical shock:

- Only pull out the main cable by the plug and never by the cable, as this could damage it.
- Never touch or hold the main plug with wet hands.
- Never unplug the main plug during operation.

▲ WARNING

ELECTRIC SHOCK

Improper connection of the ground may result in electric shock. Have the appliance checked by a qualified technician or licensed electrician if you are in doubt as to whether the dryer has been properly grounded.

Grounding Instructions

This appliance must be electrically grounded. In the event of malfunction or breakdown, grounding will reduce the risk of electric shock by providing a path of least resistance for electric current.

This appliance is equipped with a cord that has an equipment grounding conductor and a grounding plug.

The plug must be plugged into an appropriate outlet that is properly installed and grounded in accordance with all local codes and ordinances.

If a ground fault circuit breaker is used, ensure it has this symbol: .

This symbol guarantees compliance with all current regulations.

SAVE THESE INSTRUCTIONS!

Connecting a 3-wire power supply cord

The power cord must meet the following requirements:

- 208-240 volt rated (minimum);
- 30 amps;
- Type SRDT or DRT (UL 2158A).

1. Unplug the current power cord being used from the outlet/receptacle.
2. To disconnect and/or reconnect a new power cord you must remove the top cover of the appliance as shown below.
 - A. Remove the two T20 torx head screws.
 - B. Push the top cover toward the rear of the appliance and lift up.

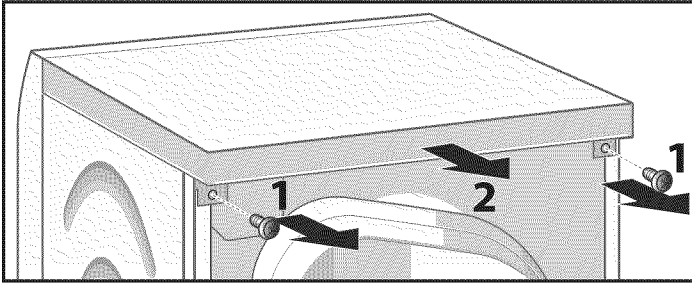

3. Open the connection box toward the rear of the appliance by removing the T20 torx head screw fastening the cover.

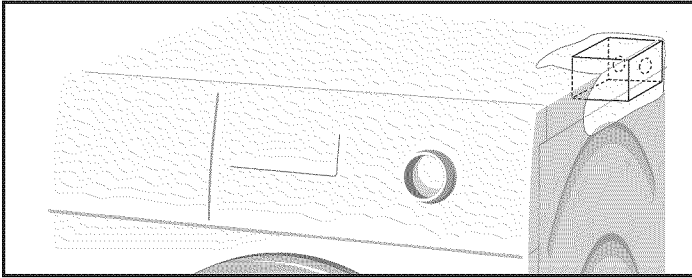

4. Remove the 4-wire power cord (as supplied):
 - A. Remove the 3 Philips screws (2 labeled **L** and one labeled **N**).
 - B. Remove the green grounding screw **PE** (T20 torx).

NOTICE: Be careful not to drop the screws into the dryer.

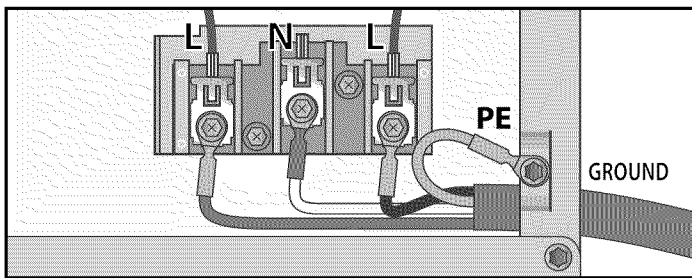

5. Loosen the strain relief clamp screw (Philips head) on rear of the connection box.
6. Pull the old power cord out of the connection box.
7. Install the new power cord back through the strain relief clamp.

NOTICE: Ensure the strain relief clamp has not been moved and its clamping screw(s) are outside the rear of the connection box.
8. Ensure the terminal ends are long enough and are formed (bent) so that no part of them (wires or

terminal ends) come in contact with connection box enclosure.

NOTICE: Use only open-end spade lugs.

9. Ensure the terminal ends are long enough and are formed (bent) so they will align with the terminal block fastening locations (screw holes).
10. Reinstall the 2 terminal block screws (Philips head) at locations **L** as shown below.
11. If the ground wire shown below from **N** to **PE** is not part of the 3-wire cord assembly you have it must be obtained/purchased separately and **it must be installed**.
12. Install the last terminal block screw (Philips) and 1 grounding screw (T20 torx) at locations **N** and **PE**.

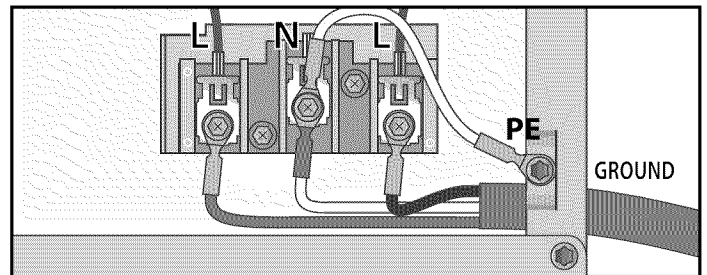

13. Tighten the strain relief screw ensuring the power cord cannot be pulled out of the connection box but not so tight as cut the power cord insulation.
14. Reinstall the connection box cover making sure all wires are routed so they do not touch any part of the enclosure and are secure.
15. Reinstall the appliance top cover as previously described in "2" point above.

Integrated electrical receptacle

This appliance is equipped with a 208/240V 15A receptacle for use ONLY with Bosch washer listed below.

▲ CAUTION

Do not use this receptacle to power any other device.

If any other electrical device is plugged into this receptacle Bosch will assume no liability.

▲ CAUTION

Use integrated electrical receptacle only for these Bosch washer listed:

WAP24200UC, WAP24201UC, WAP24202UC,
WAS24460UC, WAS20160UC, WAE20060UC.

Leveling the dryer

Importance of leveling the dryer

It is important that your dryer is level and that all four dryer feet press with equal pressure against the floor. This will help assure the quietest, most vibration-free use of your dryer.

To adjust the dryer feet:

1. Install the dryer on a level and solid surface, preferably in a corner of a room.
2. If the floor is uneven (or not level) adjust the dryer feet as required to level the dryer. Do not place anything under the dryer feet to help level the dryer.
3. Extend the dryer feet no more than is necessary. The more the feet are extended, the more vibration the dryer will experience. Start with the dryer feet turned all the way in and adjust each foot as necessary.
4. Use a bubble level to check the top of the dryer to make sure it is level side to side and front to rear.
5. Press down on each corner of the dryer top to make sure the dryer does not "wobble". There should be no "give" or movement. All four dryer feet should press equally against the floor. This is just as important as the dryer being level to prevent vibration.

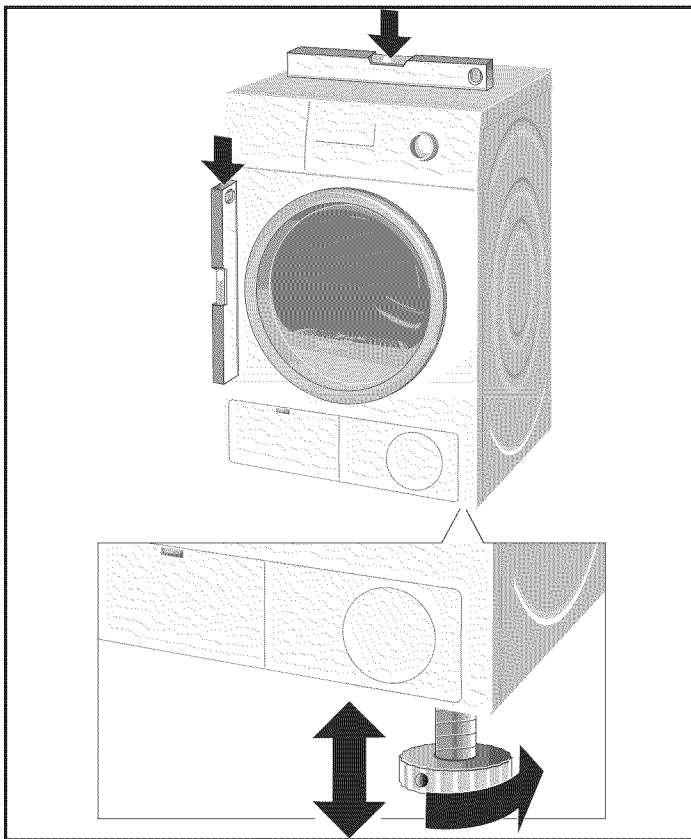

Check heating system

1. Check that the drum is empty.
2. Close the dryer door.
3. Switch the dryer to **Extra Dry** and then press the **Start/Pause** button.
4. After 3-5 minutes press the **Start/Pause** button and open the door.
 - If the interior of the dryer feels warm, the dryer has been connected properly. Switch the dryer to **Off**.
 - If the dryer does not work, switch the dryer to **Off**. Look in the Troubleshooting section of this user manual and find the fault.

Preparing to transport the dryer - step by step

1. Rotate the program selector to **Off**.
2. Pull out power supply plug.
3. Place any accessories in the drum.
4. Close the door and secure with adhesive tape.
5. Screw the height-adjustable feet of the dryer into the housing to prevent them from being damaged during transportation.

Getting to know your appliance

Control panel

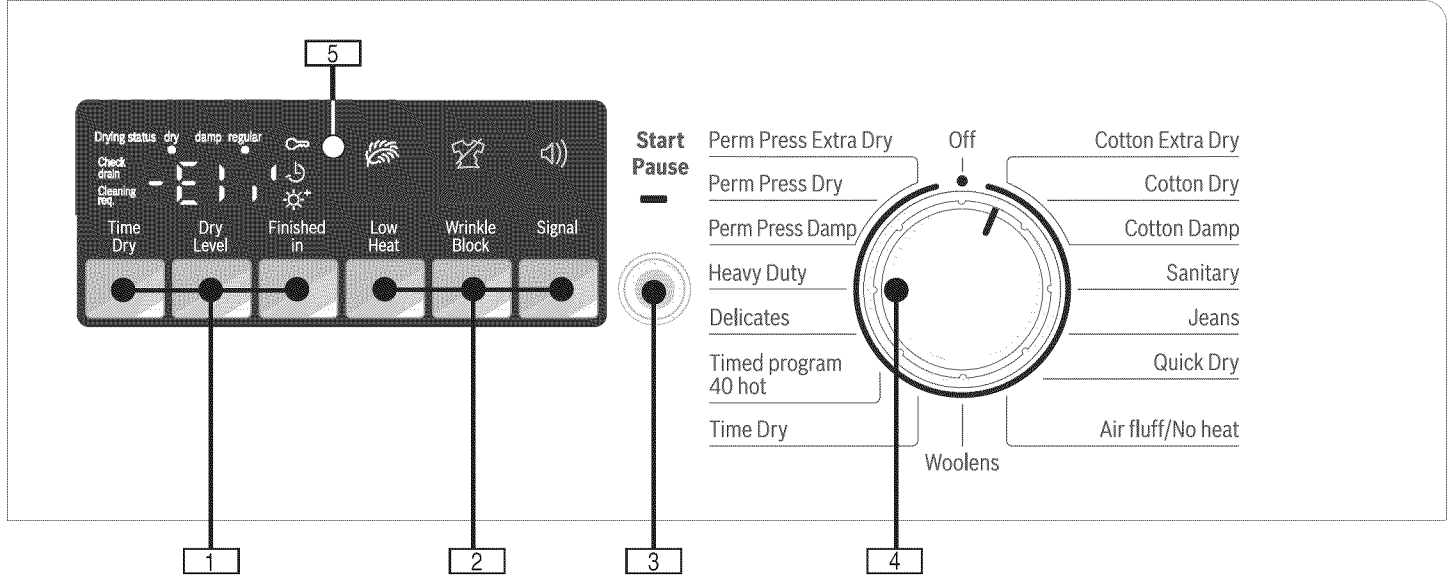

1 Time Dry, Dry Level, Finished in

Changing the program settings.
Indicator lamp lights up if the setting is active.

2 Low Heat, Wrinkle Block, Signal

Additional option settings.
Indicator lamp lights up if the setting is active.

3 Start/Pause

- starts or pauses the selected cycle;
- indicator lamp on (steady) - cycle running, can be paused;
- indicator lamp blinking - settings can be changed; cycle can be started; door is closed; childproof lock is active; cycle is in Pause mode.

4 Program Selector

Selecting a program and switching on/off;
turns in both directions.

5 Display area for settings and information.

- Do not dry woolens in the dryer. They may, however, be refreshed by using the **Woolens** program.
- Starched laundry is not always suitable for dryer. Starch leaves behind a coating that reduces the drying effect.
- When washing laundry that is to be tumble-dried afterwards, use the correct amount of fabric softener as specified in the manufacturer's instructions.
- For pre-dried, multi-layered fabrics or small, individual items of laundry, use the **Time** program. → *Program selection table; Page 18*
Also suitable for subsequent drying.

Program selection table

Programs	max. load up to:	Type of laundry (For laundry which is:)
Standard programs		
Cotton Damp	full load	T-shirts, sports shirts, dresses, trousers, overalls, underwear bed linen and table linen, towels, T-shirts, sports shirts, overalls bed linen and table linen, towels (to be ironed)
Cotton Dry	full load	bed linen, underwear, cotton socks (not to be ironed)
Cotton Extra Dry	full load	terry bathrobes and terry bed linen (particularly thick or multi-ply)
Perm Press Damp	1/2 load	trousers, dresses, skirts, shirts, blouses, leggings, sports clothing with synthetic-rich fibers, lingerie (not to be or only lightly ironed)
Perm Press Dry	1/2 load	shirts, blouses, sports clothing (not to be ironed)
Perm Press Extra Dry	1/2 load	bed linen and table linen, track suits, anoraks, blankets (not to be ironed, thick or multi-ply)
Quick Dry	1/4 load	laundry made of synthetic fibres, cotton or blended fabrics (for example) that needs to be dried quickly the values may differ from the those specified depending on the type of fabric, mixture of laundry to be dried, residual moisture in the fabric and loading capacity
Woolens	1/3 load	woollen fabrics suitable for washers fabrics become fluffier but not dry remove fabrics once the program has ended and allow to dry
Delicates	1/4 load	lingerie made of synthetic fibres, cotton or blended fabric
Air fluff/No heat	1/3 load	all type of fabrics for freshing up or airing of items of laundry that have been worn for a short period of time
Timed program 40 hot	1/3 load	pre-dried, multi-layered, sensitive fabrics made of acrylic fibres or separate small items of laundry also for subsequent drying
Time Dry	1/3 load	pre-dried, multi-layered, sensitive fabrics made of acrylic fibres or separate small items of laundry also for subsequent drying
Special programs		
Sanitary	1/2 load	cotton fabrics for drying in higher temperatures to keep them more hygienic
Jeans	1/2 load	fabrics made from jeans/denim
Heavy Duty	full load	terry towels, kitchen towels, hand towels, bed linen, underwear, cotton socks

Tip: For best results it is recommended to load the drum depending on the fabric type:

- full load: Cottons and Linens
- 1/2 load: Permanent Press, Synthetic Blends and poly Knits
- 1/3 load: Wool, Mixed

- 1/4 load: Delicates, Silk

Program settings

At the factory initial settings are pre-set for all cycles. You can change some program settings as follows.

Time Dry

Available only for Time programs,
→ *Program selection table; Page 18*
can be selected from minimum 20 minutes to maximum 3 hours, in 10-minute steps.

Dry Level

The dryness levels (e.g. Cotton Dry) can be increased in 3 levels. The laundry is made drier.
Default setting = 0.
Selectable values: 0, 1, 2, 3.

After setting the **Dry Level** for a program, it is also retained for other programs, until it is changed again.

Finished in

Before the program start, the program end (Finished in time) can be pre-selected in one-hour steps up to a maximum of 24 h (h=hour).
Press the **Finished in** button until the desired setting is displayed.

NOTICE: The cycle duration is included in the set Finished in time.

After the start, the pre-selected drying time, e.g. **8 h** is displayed and counted down until the drying cycle begins. Then the cycle duration, e.g. **2:30** (hours:minutes) is displayed.

Additional options

Low Heat

Reduced temperature for delicate fabrics, e.g. polyacrylic, polyamide or elastane, with longer drying time.

Observe the care information or symbols on the textiles tickets.

Wrinkle Block

To prevent the laundry from creasing, the dryer drum rotates at specific intervals following the drying program. Standard setting for this function is 1 hour.

If the **Wrinkle Block** button is pressed, this function is extended to 2 hours.

The laundry remains loose and fluffy until it is removed. The laundry should be removed at the latest after this time has elapsed.

Operating Instructions

▲ WARNING

RISK OF FIRE, ELECTRIC SHOCK, OR INJURY
To reduce the risk of fire, electric shock, or injury to persons, read the Important Safety Instructions and Operating Instructions before operating this appliance.

Your new dryer

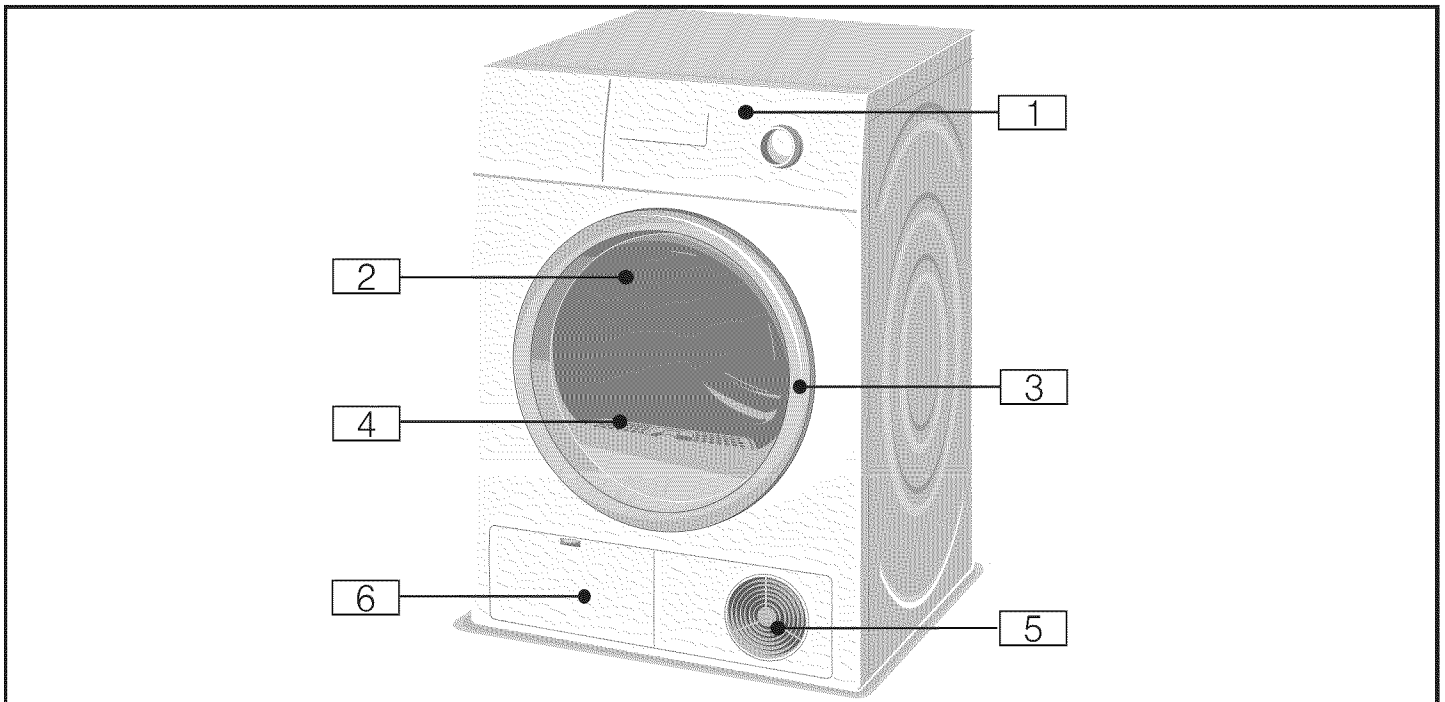

1 Control panel, display area, program selector

2 Drum with interior light (depending on model)

The light up after the door is opened and after the program starts, and switches off automatically.

3 Open the door

Close the door

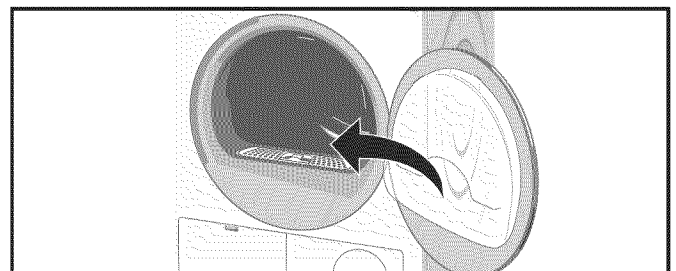
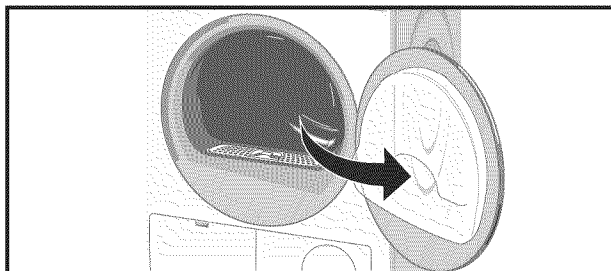

4 Lint filter

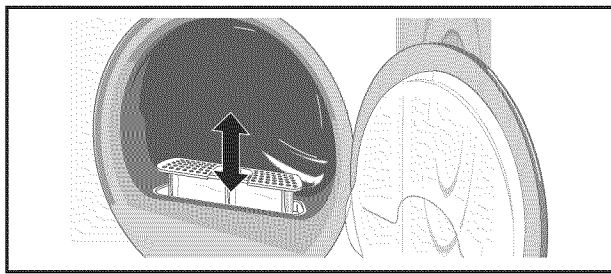

5 Air inlet

6 Open the maintenance flap

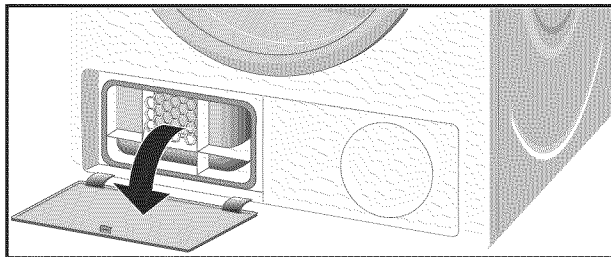

Heat exchanger

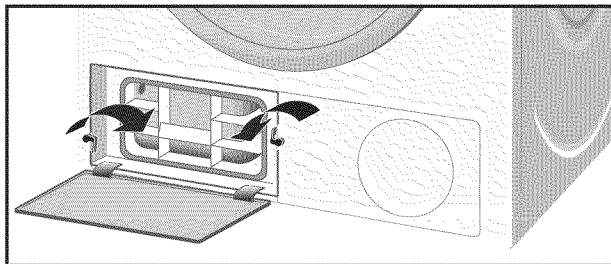

Close the maintenance flap

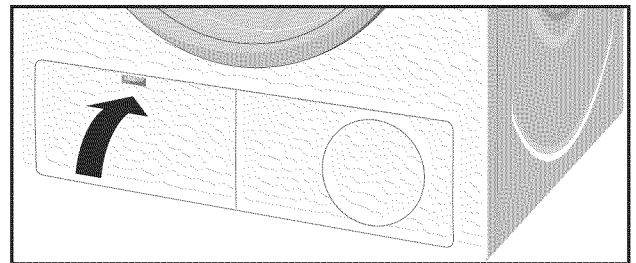

▲ WARNING

BEFORE INSTALLING OR USING YOUR DRYER
Read and follow all installation and operating instructions.

Check the machine. Never start a damaged machine!
Contact your customer service!
→ *Customer service; Page 4*

Check to be sure your household electrical system voltage and the voltage specifications on the dryer rating plate correspond.

Check to be sure the dryer drain hose is installed properly.

Turning the dryer on and off

The rotating Program Selector turns the dryer on as drying cycle is selected and off when the selector is later turned to the vertical **Off** position.

Before using the dryer for the first time

1. Read these operating instructions carefully.
2. Check that the supply voltage corresponds with the voltage specifications on the rating plate on the dryer, see top rear side of the dryer and/or rating plate label inside of the dryer door.
3. Remove all objects from the drum.

4. Check the dryer for visible damage. If damage found contact your dealer.
5. Wipe the inside of the drum with a damp cloth.
6. Check heating system.
→ *Check heating system; Page 15*
7. If the dryer does not work, switch the dryer to **Off**. Look in the Troubleshooting section of the operating instructions and find the fault.
→ *Troubleshooting; Page 28*

Temporary disconnection of the dryer

Operate your dryer only when you are at home. If you intend going on vacation or are not using your dryer for an extended period of time, you should:

1. Turn off the circuit breaker.
2. Pull out the power supply plug if possible.
3. Clean the lint filter.

Using the program selector to choose a drying cycle

NOTICE: If you have activated the childproof lock, you must deactivate it before you can set a program.

Use the program selector to select the desired drying cycle. Turns in both directions.
The machine is switched on.

In the display area, the cycle duration for the selected program appears.

Program selection

For optimum drying results your dryer offers several program groups and additional options. Select the required drying program from the program table according to the examples. → *Program selection table; Page 18*

Automatic programs

There are automatic programs for different types of textiles (regular/cotton, permanent press).

The program sequence of automatic programs is controlled by sensors. The duration of the program depends on the measured degree of moisture in the laundry and on the selected degree of dryness (e.g. Cotton Dry or Cotton Extra Dry).

- Regular/Cotton

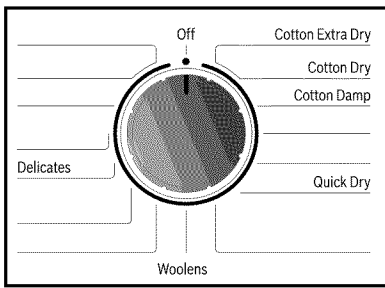

- Permanent Press

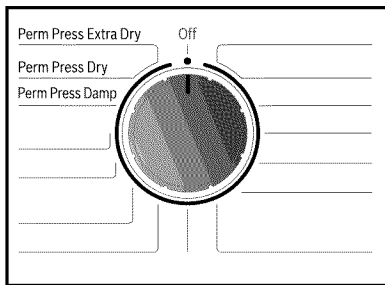

Special programs

The programs Sanitary, Jeans, Active Wear, AntiShrink, Super Quick 15 min, Towels, Mixed and Heavy Duty (depending on model) are made for special application cases. Details. → *Program selection table; Page 18*

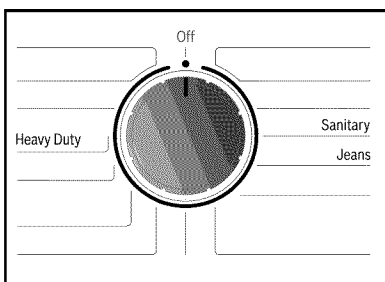

Time programs

Time programs run at specific temperatures. Suitable for pre-dried, multi-ply, delicate textiles or individual small items. Also for subsequent drying. → *Program settings; Page 19*

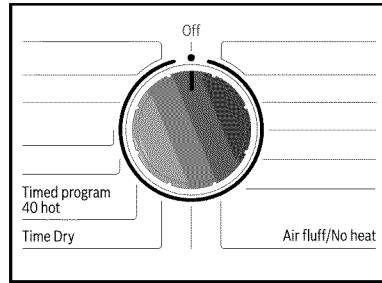

Selecting program settings and additional options

By selecting program settings and additional options, you can adjust the drying process still better to suit the items you are drying. The settings can be selected and deselected depending on the cycle progress.

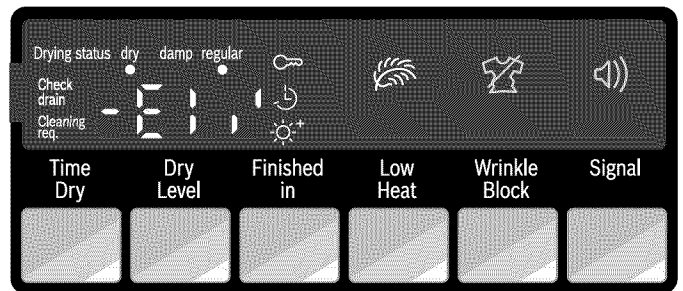

The indicator lamps of the buttons light up if the setting is active.

For **Time Dry**, **Finished in**, **Low Heat**, **Wrinkle Block** and **Signal** the settings are not retained after the appliance is switched off.

→ *Program settings; Page 19*

→ *Additional options; Page 19*

For **Dry Level** the setting is retained after the appliance is switched off.

→ *Dry Level; Page 19*

Loading the laundry

▲ WARNING

RISK OF EXPLOSION

Do not dry the laundry that has ever been in contact with solvents, oil, wax, grease or paint (e.g. hair styling products, nail varnish remover, stain remover, cleaning solvent, etc.).

1. Check lint filter.

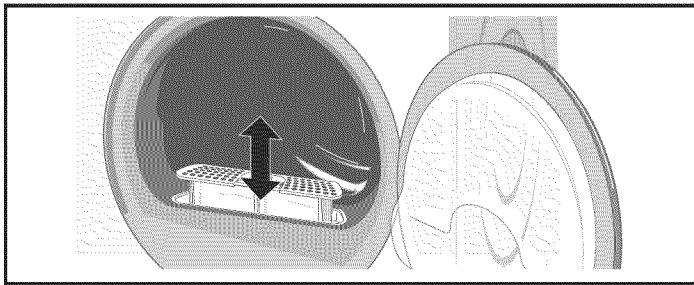

The filter should be cleaned after or before every drying process. Cleaning the filter reduces the drying time and saves energy.

→ *Cleaning the lint filter; Page 25*

2. Load the laundry into the drum and close the door.

Tip: If the door has not been closed properly, the dryer will not start.

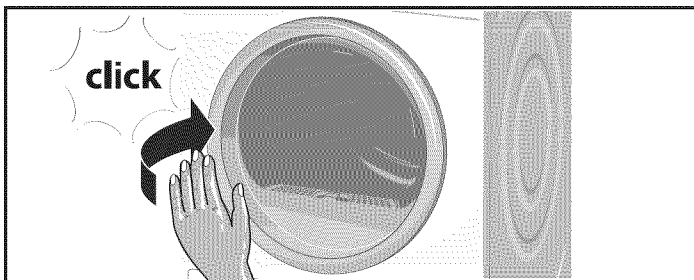

Tips

After loading, close the door carefully so as not to trap any items between the door and the rubber seal. The door should close until a click is heard.

Foreign objects left in the drum may damage laundry. Before inserting any laundry, check to make sure no foreign objects are in the drum.

Recommended Load Size

Recommended maximum load size can be found in the program selection table in this manual.

→ *Program selection table; Page 18*

Load the laundry

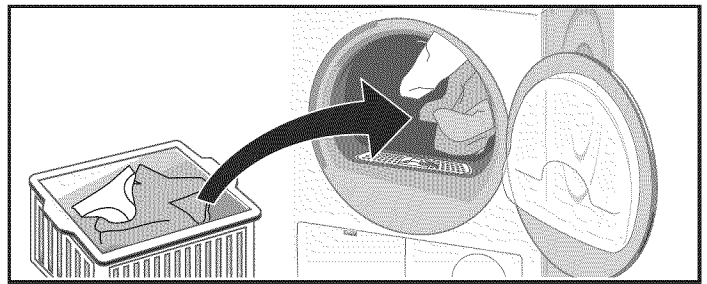

Place laundry in the empty drum. Put each piece of laundry into machine separately.

For best results the laundry to be dried must be sorted according to type of laundry and desired degree of drying.

→ *Program selection table; Page 18*

→ *Sorting the laundry; Page 17*

→ *Dry Level; Page 19*

Starting the program

1. Rotate program selector to the desired program. Select the program which corresponds to the laundry in the dryer from Program selection table.
→ *Program selection table; Page 18*

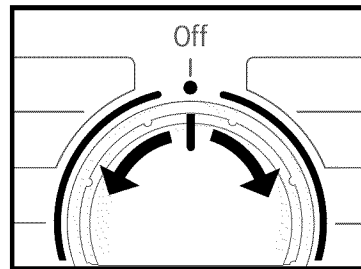

The **Start/Pause** indicator light starts flashing.

2. Press the **Start/Pause** button. Indicator lamp lights up and the cycle starts.

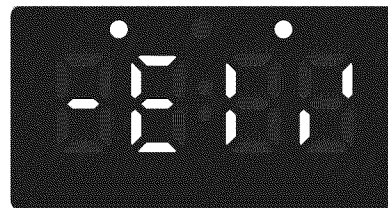

During the cycle, the display area indicates the estimated remaining time and, after starting the drying cycle, the cycle duration and the symbols for the cycle progress are flashing.

→ *Display area; Page 17*

NOTICES

- If you want to protect the cycle against inadvertent adjustment, select the **Childproof lock**.
→ *Childproof lock; Page 24*
- If **Cleaning req.** indicator lights up, clean the lint filter and/or heat exchanger.
→ *Cleaning the lint filter; Page 25*
→ *Cleaning the heat exchanger; Page 26*

- If **Check drain** indicator lights up, check the drain hose and its connection.
→ *Maintenance of drain hose; Page 27*
3. If required, select **Low Heat** by pressing the button.
→ *Additional options; Page 19*
 4. If required, select **Wrinkle Block** by pressing the button.
→ *Additional options; Page 19*

Tip: The estimated remaining time will be updated.

Indicator of program sequence

The dryer uses an electronic control system. A moisture sensor continuously checks the moisture in the laundry. Drying ends automatically as soon as the selected degree of dryness has been reached.

The drum continues to rotate at specific intervals for one hour to prevent creasing.

The current state of the process and level reached during the program sequence is indicated by indicator lights (dry, damp, regular).

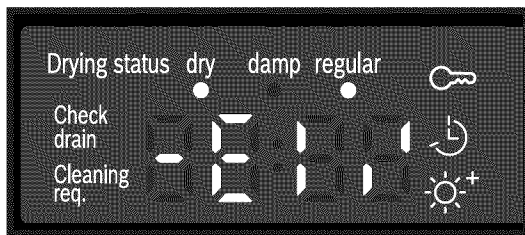

Childproof lock

You can secure the dryer against inadvertent changing of the set functions. To do this, activate the childproof lock after cycle start.

To **Activate/Deactivate**, press Start/Pause for approx. 5 seconds. In the display field, you will see the  symbol light indicating the childproof lock is active.

NOTICE: The childproof lock will remain activated until the next cycle start even after switching the machine off. You must deactivate the childproof lock before the next cycle and, if necessary, activate it again after starting the cycle.

Signal

For switching the buzzer on and off press the **Signal** button.

The Buzzer indicates program end if it is activated. Other alarms are not influenced by this option.

Selecting a different program

If you have inadvertently started the wrong program, you can change this as follows:

1. Press Start/**Pause**.
2. Select another program.
3. Press **Start/Pause**. The new drying cycle starts from the beginning.

Cancel program

If required, you can cancel the selected program:

1. Press Start/**Pause**.
2. Rotate the program selector to **Off**.

Program end

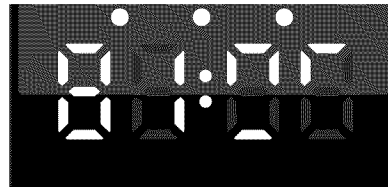

End appears in the display area, the Start/Pause button indicator lamp is off and the **regular** indicator lights up. After the program end, rotate the program selector to **Off**.

Removing laundry/switching the appliance off

1. Open the door and remove the laundry.
2. Turn the program selector to the **Off** position. Appliance is switched off and dryer light goes out.
3. Clean lint filter.
→ *Cleaning the lint filter; Page 25*
4. Close the door.

Tip: If at the end of the drying cycle the display does not light, the energy-saving mode is active. To see display, e.g. press any button.

→ *Environmentally friendly use of your dryer; Page 7*

Cleaning and care

⚠ WARNING

RISK OF EXPLOSION

Never use solvents or highly flammable liquids for cleaning.

⚠ CAUTION

Incorrect cleaning may damage the dryer.
Do not spray with a water jet.
Do not use scouring agents or all-purpose cleaners.
Do not use steam cleaners.

Cleaning the housing and control panel

Wipe the housing and fascia with a soft cloth and soapy water only.

Wipe the drum, door seal and inside of the door with a damp cloth only.

NOTICE: Do not clean with a water jet.

Remove detergent and cleaning agent residue immediately.

During drying, water may occasionally accumulate between the window and the seal. This does not affect the proper operation of your dryer.

Cleaning the lint filter

A dirty filter extends the drying time and increases energy consumption.

The filter should be cleaned before or after each drying process.

If the **Cleaning req.** indicator lights up during a drying program, clean the filter immediately.

Tip: The program interrupts automatically.

To clean the lint filter:

1. Switch off the dryer. Rotate the program selector to **Off**.

⚠ CAUTION

The inside of the door heats up during the drying process. The drum, the door and the laundry may be hot.

2. Open the door.

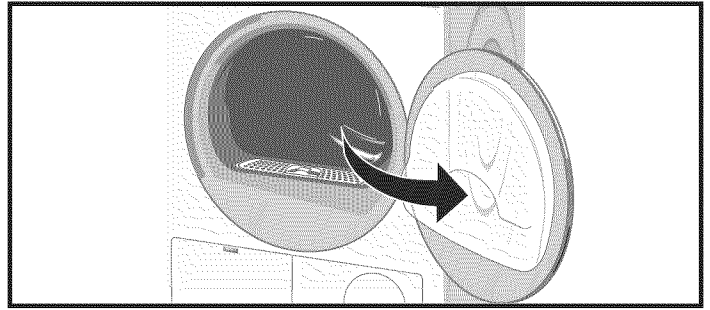

3. Pull out filter.

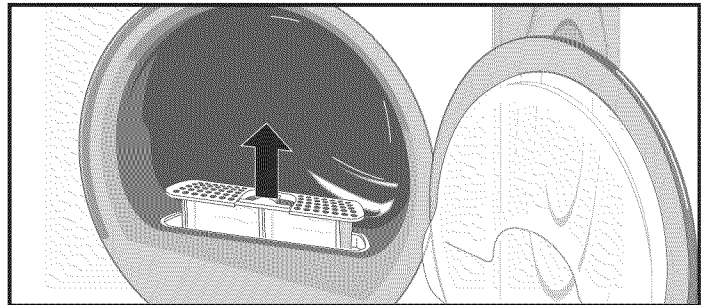

4. Open the filter.

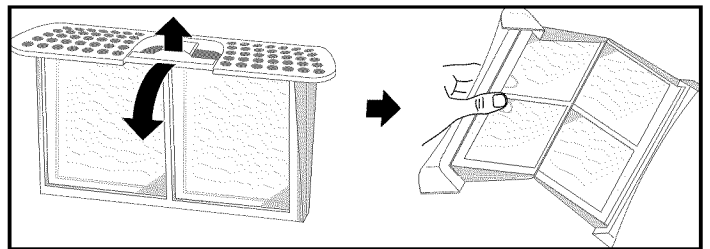

5. Remove fluff (run hand over filter).

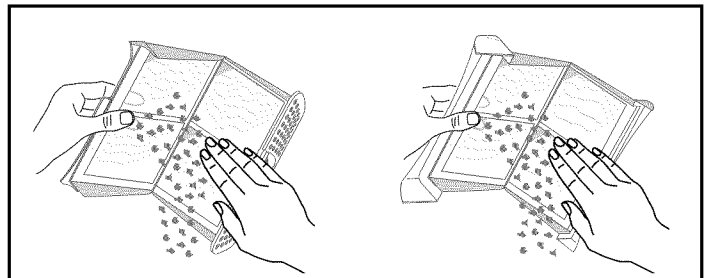

6. Close the filter and re-insert it.

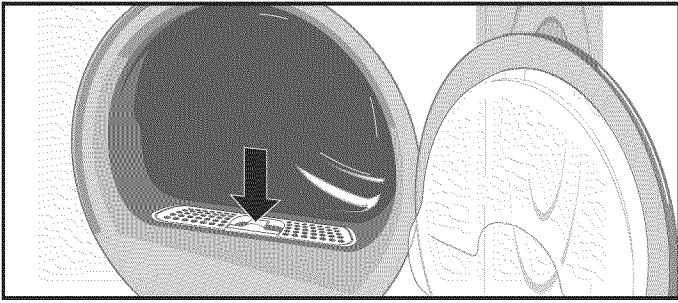

7. Close the door.

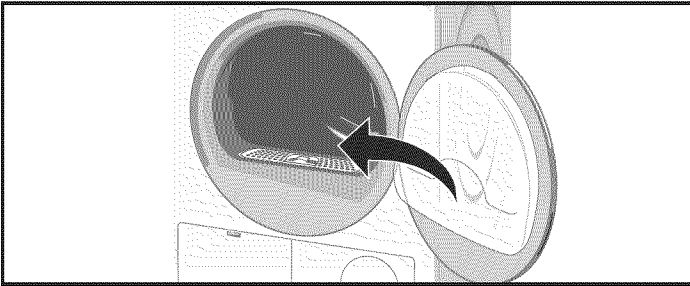

NOTICE: The filter should be rinsed once a year under warm running water.

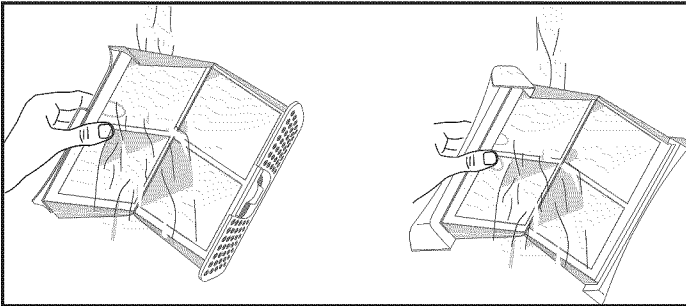

The filter must be dried thoroughly before being replaced.

Cleaning the heat exchanger

The heat exchanger requires periodic cleaning (recommended once per month under normal drying conditions). The frequency of cleaning depends on the amount and type loads being dried.

To clean the heat exchanger:

1. If the dryer is hot, run on **Air fluff/No heat** program to allow the dryer to cool down.
2. Residual water may escape, place an absorbent cloth under the maintenance flap.

3. Unlock the maintenance flap and open it completely.

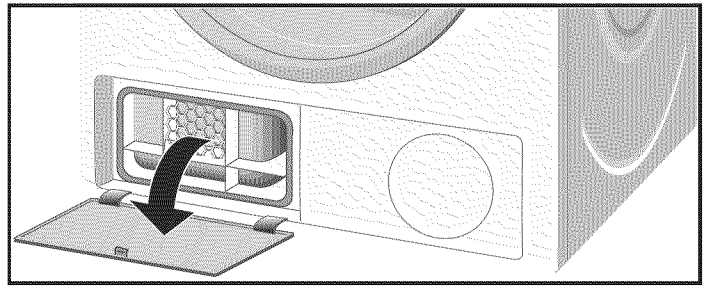

4. Turn both locking levers towards each other.

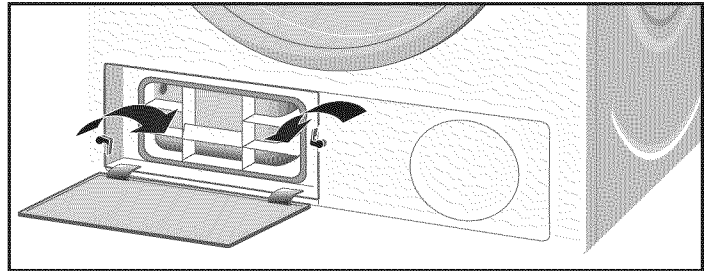

5. Pull out the heat exchanger cap.

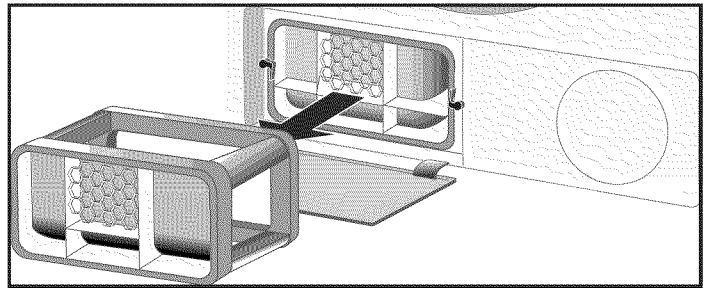

6. Remove the heat exchanger.

NOTICE: Do not damage the heat exchanger! Clean with warm water only. Do not use hard/sharp-edged objects!

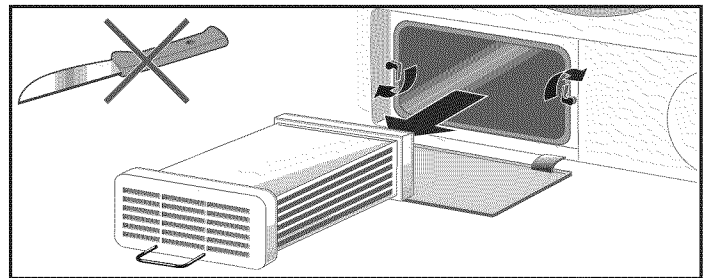

7. Rinse the heat exchanger and the cap on all sides with a jet of water to completely remove all of the fluff.

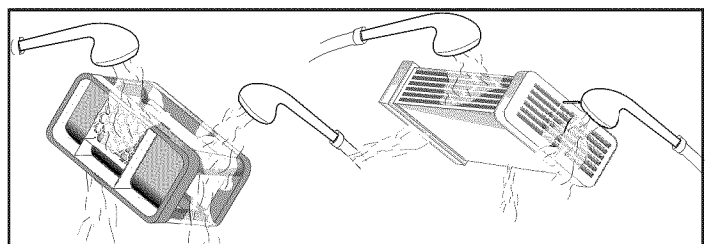

8. Remove any fluff from the seals on the dryer and heat exchanger.
9. Allow the cap and the heat exchanger to dry fully.
10. First insert the heat exchanger, then the cap.
11. Turn back both locking levers.

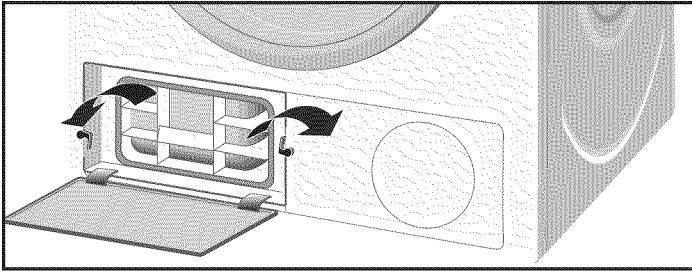

12. Close the maintenance flap until it locks into position.

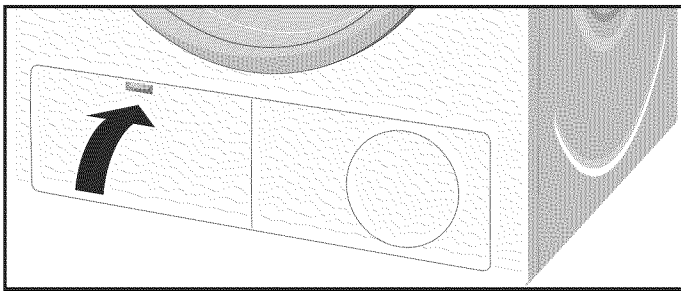

13. Look in the Troubleshooting table also to reset the maintenance indication.
→ *Troubleshooting; Page 28*

Cleaning the moisture sensors

Occasionally the moisture sensors have to be cleaned because a fine layer of transparent buildup is deposited on the sensors.

To clean the moisture sensors:

1. Open the door.

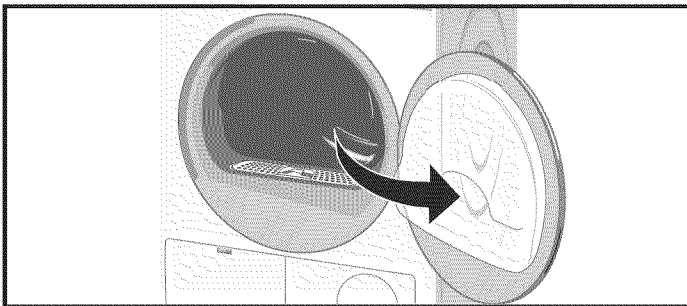

2. The deposit on the sensors can easily be removed by wiping the sensors (the two bars next to the lint filter) with a cloth and a little white vinegar.

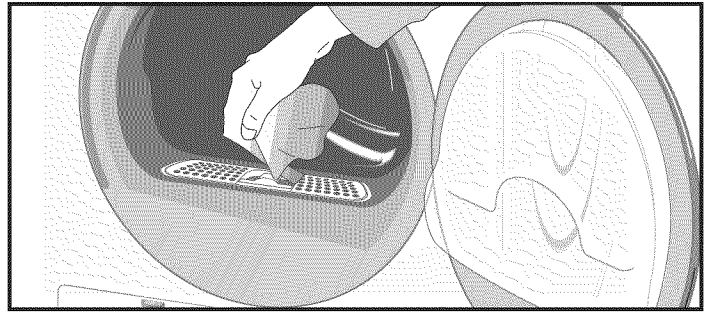

NOTICE: Use white vinegar only!
Clean the moisture sensors once a month.

Cleaning the lint filter area

Over time, fluff from the drying process collects in the lint filter area.

This fluff can be easily removed using your vacuum cleaner, at least once a month.

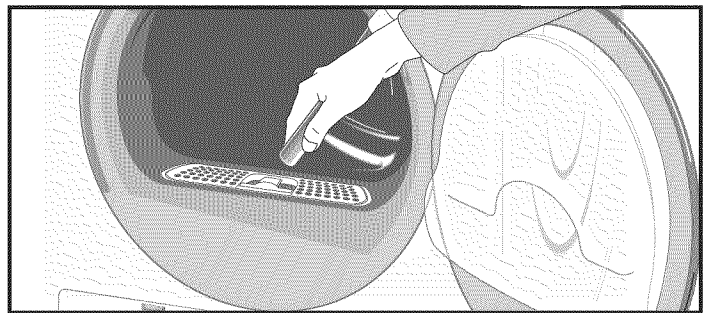

Maintenance of drain hose

If **Check drain** indicator lights up, check the drain hose, it may be kinked or bent, and/or the drain hose connection conditions.

NOTICE: If **Check drain** indicator still lights up after the maintenance, you should contact customer service or your local dealer.

Troubleshooting

Introduction

NOTICE: Before doing maintenance work or trying to rectify a problem by yourself, rotate the program selector to **Off**.

The program will not continue running when the power supply has been restored. Desired program must be selected again and start button pressed.

▲ WARNING

RISK OF INJURY TO SKIN
The door, the drum and the laundry may be hot.

▲ WARNING

RISK OF ELECTRIC SHOCK! EXPLOSION HAZARD
Repairs or replacement of parts should be carried out by authorized technicians only.

Determining the Problem

Problem	Possible cause(s)	Solution(s)
Dryer does not start. Start/Pause indicator light does not illuminate.	Main plug not inserted at all or not inserted correctly.	Insert main plug correctly.
	A fuse of power supply is tripped.	Replace/switch on fuse.
	Start/Pause button not pressed.	Press Start/Pause button.
	Door not closed properly.	Check if laundry is caught in the door, address the issue. Close the door until a click is heard.
	Ambient temperature below 41°F/ 5°C.	Increase room temperature. → <i>Your dryer is intended for; Page 5</i>
	Program not selected.	Rotate the program selector to desired program. → <i>Program selection table; Page 18</i>
The display panel lighting and indicator lights go out, Start/Pause indicator light flashes.	Energy-saving mode is activated.	Press any button to activate the lighting. → <i>Environmentally friendly use of your dryer; Page 7</i>
The display panel switches off.	Sleep mode after setting the Finished in option is activated.	Press any button to activate the lighting.
The Cleaning req. indicator light up.	Lint filter dirty.	Clean lint filter. → <i>Cleaning the lint filter; Page 25</i> Press the Start/Pause button to reset the displayed indication and then press Start/Pause button again to reset the appliance if necessary.
	Heat exchanger dirty.	Clean heat exchanger. → <i>Cleaning the heat exchanger; Page 26</i> Press the Start/Pause button to reset the displayed indication and then press Start/Pause button again to reset the appliance if necessary.

Before calling the customer service, check whether you can rectify the fault yourself by means of the following table.

If a fault cannot be rectified or a repair is required:

1. Set program selector to the **Off**.
2. Pull the mains plug out of the socket.
3. Call customer service.
→ *Customer service; Page 4*

Troubleshooting

If you encounter a problem, it often will merely be something minor. Before you call customer service, consider the suggestions and instructions below:

NOTICE: The troubleshooting items listed below can help you resolve minor issues with your dryer quickly and without the necessity of waiting for a service call.

Service calls for issues that could have been solved by using this table may not be covered under the warranty. Please rule out any of these issues before calling customer service.

Problem	Possible cause(s)	Solution(s)
The Check drain indicator light up. Water has not drained completely.	Drain hose is blocked.	Check drain hose. → <i>Maintenance of drain hose; Page 27</i> Check drain hose connection conditions.
	Drain hose is leaking: is not screwed on the tight at both ends, or rubber not placed in hose.	Check the drain hose, be sure that it is on the dryer securely with the clamp in place; may need to replace the drain hose if leaking continues.
Water is leaking out.	Dryer is not leveled.	Level the dryer. → <i>Leveling the dryer; Page 14</i>
	The heat exchanger seal is dirty.	Clean the heat exchanger seal. → <i>Cleaning the heat exchanger; Page 26</i>
Program terminates shortly after starting.	Ambient temperature greater than 41°F/5°C.	Ventilate the room.
	Laundry is not loaded.	Load the laundry. → <i>Loading the laundry; Page 23</i>
	Load too small for selected program.	Use time program. → <i>Program selection table; Page 18</i>
	Loaded laundry dry.	Check the loaded laundry. If it is dry, open the door, remove laundry and turn program selector to Off .
The door opens by itself.	The door not closed properly.	Close the door until a click is heard.
Creasing.	Laundry load exceeded. Unsuitable program selected.	Do not exceed the maximum load for selected program. Remove items of laundry immediately after the end of the program, hang them up and pull into shape. Turn program selector to Off . → <i>Program selection table; Page 18</i>
Drying result is not satisfactory (laundry feels too damp).	Warm laundry may feel damper than it really is.	Remove items of laundry immediately after the end of the program and turn the program selector to Off .
	The selected program does not suit the load.	Use another drying program or, in addition, select the time program. → <i>Program selection table; Page 18</i>
	Dryness level is not adjusted.	Use Dry Level to adjust the dryness level. → <i>Dry Level; Page 19</i>
	Fine layer of limescale on the humidity sensors.	Clean the moisture sensors. → <i>Cleaning the moisture sensors; Page 27</i>
	Program termination e.g. main power supply failure, door open or maximum drying time reached.	See the problem(s) mentioned in this table.
	Laundry is too wet.	Spin laundry at higher speed in the washing machine, before drying. Switch off the dryer and switch on again.
Drying time too long.	Lint filter is dirty.	Clean lint filter. → <i>Cleaning the lint filter; Page 25</i>
	Insufficient supply of air.	Ensure that air can circulate.
	Air inlet possibly blocked.	Do not obstruct the air inlet on the front of the dryer.
	Ambient temperature higher than 95°F/35°C.	Ventilate the room.
Program does not start Finished in (remaining) time is displayed.	Program ending time has been selected and activated.	Drying cycle will begin at proper time to complete at the selected Finished in time.
Program does not start -  symbol light up.	Childproof lock is activated.	Deactivate Childproof lock. → <i>Childproof lock; Page 24</i>

Problem	Possible cause(s)	Solution(s)
One or more indicator lights are flashing.	Lint filter or/and heat exchanger is dirty.	Clean lint filter or/and heat exchanger (see solution of the problem(s) in this table above).
	Installation conditions are not fine.	Check the installation conditions. → <i>Electrical Connections; Page 13</i>
	Fault in program sequence or malfunction.	Switch off the dryer, allow it to cool down, switch back on and restart the program.
Power failure.		Remove laundry from the dryer immediately and spread out. This allows the heat to dissipate. Be careful as the door, the drum and the laundry may be hot.

STATEMENT OF LIMITED PRODUCT WARRANTY

Bosch Clothes Dryer

What this Warranty Covers & Who it Applies to:

The limited warranty provided by BSH Home Appliances Corporation (Bosch) in this Statement of Limited Product Warranty applies only to the Bosch Clothes Dryer ("Product") sold to you, the first using purchaser, but strictly conditioned on the Product having been purchased: (1) for your normal, household (non-commercial) use, and has in fact at all times only been used for normal household purposes (any commercial use or setting of the Product automatically voids the warranty); (2) new at retail (not a display, "as is", or previously returned model) purchased directly by the end-user consumer, and not for resale, or commercial use; and (3) within the United States or Canada, and has at all times remained within the country of original purchase. The warranties stated herein apply only to the first purchaser of the Product and are not transferable. Bosch reserves the right to request proof of purchase at the time any warranty claim is submitted to confirm that the Product falls within the scope of this limited product warranty. The warranty is automatically void if the Product was a display model, sold "as is", tampered with, a damaged or "scratch and dent" model, or a previously returned model, a free give-away, charitable donation or contest prize.

Limitation for Third Party Accessories:

Third party accessories, other than those shipped with your Bosch appliance, and any consequential damages resulting there from, are not covered by this warranty. This limitation expressly includes the implied warranties of merchantability and fitness for a particular purpose, which are also expressly excluded with respect to third party accessories, other than those shipped with your Bosch appliance. Use of third party accessories, other than those shipped with your Bosch appliance, does not void this warranty on any other part, and all other provisions of this warranty remain in effect.

Please make sure to return your registration card; while not necessary to effectuate warranty coverage, it is the best way for Bosch to notify you in the unlikely event of a safety notice or product recall.

How Long the Warranty Lasts:

Bosch warrants that the Product is free from defects in materials and workmanship for a period of three hundred sixty-five days (365) days from the date of purchase. The foregoing timeline begins to run upon the date of purchase, and shall not be stalled, tolled, extended, or suspended, for any reason whatsoever.

Repair/Replace as Your Exclusive Remedy:

During this warranty period, Bosch or one of its authorized service providers will repair your Product without charge to you (subject to certain limitations stated herein) if your Product proves to have been manufactured with a defect in materials or workmanship. If reasonable attempts to repair the Product have been made without success, then Bosch will replace your Product (upgraded models may be available to you, in Bosch's sole discretion, for an additional charge). All removed parts and components shall become the property of Bosch at its sole option. All replaced and/or repaired parts shall assume the identity of the original part for purposes of this warranty and this warranty shall not be extended with respect to such parts. Bosch's sole liability and responsibility hereunder is to repair manufacturer-defective Product only, using a Bosch-authorized service provider during normal business hours. For safety and property damage concerns, Bosch highly recommends that you do not attempt to repair the Product yourself, or use an un-authorized servicer; Bosch will have no responsibility or liability for repairs or work performed by a non-authorized servicer. If you choose to have someone other than an authorized service provider work on your Product, THIS WARRANTY WILL AUTOMATICALLY BECOME NULL AND VOID. Authorized service providers are those persons or companies that have been specially trained on Bosch products, and who possess, in Bosch's opinion, a superior reputation for customer service and technical ability (note that they are independent entities and are not agents, partners, affiliates or representatives of Bosch). Notwithstanding the foregoing, Bosch will not incur any liability, or have responsibility, for the Product if it is located in a remote area (more than 100 miles from an authorized service provider) or is reasonably inaccessible, hazardous, threatening, or treacherous locale, surroundings, or environment; in any such event, if you request, Bosch would still pay for labor and parts and ship the parts to

the nearest authorized service provider, but you would still be fully liable and responsible for any travel time or other special charges by the service company, assuming they agree to make the service call.

Extended Limited Warranty:

LENGTH OF EXTENDED LIMITED WARRANTY

2 year Limited Warranty from date of Purchase.

SCOPE OF EXTENDED LIMITED WARRANTY

Bosch will repair or replace, free of charge, any printed circuit boards, drive motor or component part of the drive motor that proves defective under conditions of normal home use during the first two years from the date of purchase, labor charges excluded.

Out of Warranty Product:

Bosch is under no obligation, at law or otherwise, to provide you with any concessions, including repairs, pro-rates, or Product replacement, once this warranty has expired.

Warranty Exclusions:

The warranty coverage described herein excludes all defects or damage that are not the direct fault of Bosch, including without limitation, one or more of the following: (1) use of the Product in anything other than its normal customary and intended manner (including without limitation, any form of commercial use, use or storage of an indoor product outdoors, use of the Product in conjunction with air or water-going vessels); (2) any party's willful misconduct, negligence, misuse, abuse, accidents, neglect, improper operation, failure to maintain, improper or negligent installation, tampering, failure to follow operating instructions, mishandling, unauthorized service (including self-performed "fixing" or exploration of the appliance's internal workings); (3) adjustment, alteration or modification of any kind; (4) a failure to comply with any applicable state, local, city, or county electrical, plumbing and/or building codes, regulations, or laws, including failure to install the product in strict conformity with local fire and building codes and regulations; (5) ordinary wear and tear, spills of food, liquid, grease accumulations, or other substances that accumulate on, in, or around the Product; and (6) any external, elemental and/or environmental forces and factors, including without limitation, rain, wind, sand, floods, fires, mud slides, freezing temperatures, excessive moisture or extended exposure to humidity, lightning, power surges, structural failures surrounding the appliance, and acts of God. In no event shall Bosch have any liability or responsibility whatsoever for damage to surrounding property, including cabinetry, floors, ceilings, and other structures or objects around the Product. Also excluded from this warranty are scratches, nicks, minor dents, and cosmetic damages on external surfaces and exposed parts; Products on which the serial numbers have been altered, defaced, or removed; service visits to teach you how to use the Product, or visits where there is nothing wrong with the Product; correction of installation problems (you are solely responsible for any structure and setting for the Product, including all electrical, plumbing or other connecting facilities, for proper foundation/flooring, and

for any alterations including without limitation cabinetry, walls, floors, shelving, etc.); and resetting of breakers or fuses. TO THE EXTENT ALLOWED BY LAW, THIS WARRANTY SETS OUT YOUR EXCLUSIVE REMEDIES WITH RESPECT TO PRODUCT, WHETHER THE CLAIM ARISES IN CONTRACT OR TORT (INCLUDING STRICT LIABILITY, OR NEGLIGENCE) OR OTHERWISE. THIS WARRANTY IS IN LIEU OF ALL OTHER WARRANTIES, WHETHER EXPRESS OR IMPLIED. ANY WARRANTY IMPLIED BY LAW, WHETHER FOR MERCHANTABILITY OR FITNESS FOR A PARTICULAR PURPOSE, OR OTHERWISE, SHALL BE EFFECTIVE ONLY FOR THE PERIOD THAT THIS EXPRESS LIMITED WARRANTY IS EFFECTIVE. IN NO EVENT WILL THE MANUFACTURER BE LIABLE FOR CONSEQUENTIAL, SPECIAL, INCIDENTAL, INDIRECT, "BUSINESS LOSS", AND/OR PUNITIVE DAMAGES, LOSSES, OR EXPENSES, INCLUDING WITHOUT LIMITATION TIME AWAY FROM WORK, HOTELS AND/OR RESTAURANT MEALS, REMODELLING EXPENSES IN EXCESS OF DIRECT DAMAGES WHICH ARE DEFINITELY CAUSED EXCLUSIVELY BY Bosch, OR OTHERWISE. SOME STATES DO NOT ALLOW THE EXCLUSION OR LIMITATION OF INCIDENTAL OR CONSEQUENTIAL DAMAGES, AND SOME STATES DO NOT ALLOW LIMITATIONS ON HOW LONG IMPLIED WARRANTY LASTS, SO THE ABOVE LIMITATIONS MAY NOT APPLY TO YOU. THIS WARRANTY GIVES YOU SPECIFIC LEGAL RIGHTS, AND YOU MAY ALSO HAVE OTHER RIGHTS, WHICH VARY FROM STATE TO STATE. No attempt to alter, modify or amend this warranty shall be effective unless authorized in writing by an officer of BSH.

How to Obtain Warranty Service:

To obtain warranty service for your Product, you should contact the nearest Bosch authorized service center.

BSH Home Appliances Corporation - 1901 Main Street, Irvine, CA 92614 / 800-944-2904



9000866559
9308



BOSCH

1901 Main Street, Suite 600 • Irvine, CA 92614 • 1-800-944-2904
www.bosch-home.com • © 2012 BSH Home Appliances