

Use & Care

TABLE OF CONTENTS

Product Record and Registration	2	Setting Oven Controls	12
Important Safety Instructions	3	Care and Cleaning	20
Surface Controls	8	Before You Call	25
Before Setting Oven Controls	11	Warranty	29

PRODUCT RECORD AND REGISTRATION

Need Help?	2
Product Registration	2
Product Record and Registration	2
Important Safety Instructions	3
Surface Controls	8
Before Setting Oven Controls	11
Setting Oven Controls	12
Care and Cleaning	20
Before You Call	25
Warranty	29

Need Help?

Visit the Frigidaire web site at www.frigidaire.com

Before you call for service, there are a few things you can do to help us serve you better.

Read this Use & Care Manual

This manual contains instructions to help you use and maintain your range properly.

If You Received a Damaged Range...

Immediately contact the dealer (or builder) that sold you the range.

Save Time and Money

Check the Before You Call chapter. This section helps step you through some common problems that might occur.

If you do need service, help is only a phone call away. Call Frigidaire Customer Services at **1-800-944-9044**.

Product Registration

Registering your product with Frigidaire enhances our ability to serve you. You can register online at <http://www.frigidaire.com> or by dropping your Product Registration Card in the mail.

Record model and serial numbers here

Purchase Date: _____

Frigidaire model number: _____

Frigidaire serial number: _____

Serial Plate Location

Questions?

For toll-free telephone support in the U.S. call **1-800-944-9044**

For online support and Internet product information, visit <http://www.frigidaire.com>.

Thank you for choosing Frigidaire.

This Use and Care Guide is part of our commitment to customer satisfaction and product quality throughout the service life of your new appliance. We view your purchase as the beginning of a relationship. To ensure our ability to continue serving you, please use this page to record important product information.

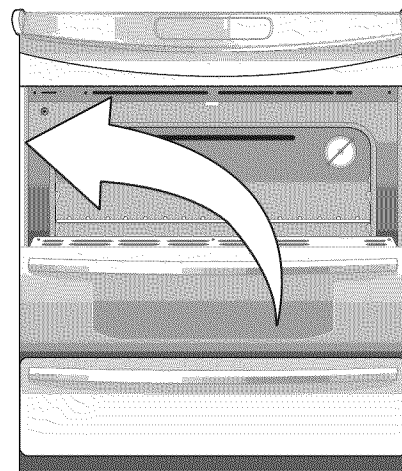

IMPORTANT SAFETY INSTRUCTIONS

CAUTIONS AND WARNINGS

Read all instructions before using this appliance.

This manual contains important safety symbols and instructions. Please pay attention to these symbols and follow all instructions given.

Do not attempt to install or operate your appliance until you have read the safety precautions in this manual. Safety items throughout this manual are labeled with a WARNING or CAUTION statement based on the risk type.

DEFINITIONS

 This is the safety alert symbol. It is used to alert you to potential personal injury hazards. Obey all safety messages that follow this symbol to avoid possible injury or death.

WARNING

Indicates a potentially hazardous situation which, if not avoided, may result in death or serious injury.

CAUTION

Indicates a potentially hazardous situation which, if not avoided, may result in minor or moderate injury.

IMPORTANT

Indicates installation, operation, maintenance, or valuable information that is not hazard related.

NOTE

Indicates a short, informal reference—something written down to assist the memory or for future reference.

NOTE

Save these instructions for future use.

WARNING

Storage In or On Appliance—Flammable materials should not be stored in an oven, near surface burners, or in the warmer drawer (if equipped). This includes paper, plastic, and cloth items, such as cookbooks, plastic ware, and towels, as well as flammable liquids. Do not store explosives, such as aerosol cans, on or near the range.

WARNING

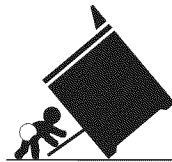

Tip Over Hazard

- A child or adult can tip the range and be killed.
- Verify the bracket is engaged with countertop or that the anti-tip device has been

installed to the walls of the cabinet, the wall, or the floor as per the installation instructions.

- Ensure the anti-tip device is re-engaged with the countertop, the walls of the cabinet, the wall, or the floor as per the installation instructions when the range is moved.
- Do not operate the range without the anti-tip device in place and engaged.
- Failure to follow these instructions can result in death or serious burns to children and adults.



To check if the anti-tip bracket is installed properly, use both arms and grasp the rear edge of range back. Carefully attempt to tilt range forward. When properly installed, the range should not tilt forward.

Refer to the anti-tip bracket installation instructions supplied with your range for proper installation.

IMPORTANT SAFETY INSTRUCTIONS

WARNING

- Do Not Leave Children Alone - Children should not be left alone or unattended in the area where appliance is in use. They should never be allowed to sit or stand on any part of the appliance, including the storage drawer, lower broiler drawer, warmer drawer, or lower double oven.
- Stepping, leaning, or sitting on the door or drawers of this appliance can result in serious injuries and also cause damage to the appliance. Do not allow children to climb or play around the appliance. The weights of a child on an open over door may cause the appliance to tip, resulting in serious burns or other injury. An open drawer when hot may cause burns.
- Never cover any slots, holes, or passages in the oven bottom or cover an entire oven rack with materials, such as aluminum foil. Aluminum foil linings may trap heat, causing a fire hazard.

IMPORTANT

Important Safety Notice - The California Safe Drinking Water and Toxic Enforcement Act requires the governor of California to publish a list of substances known to cause cancer, birth defects, or other reproductive harms, and requires businesses to warn customers of potential exposures to such substances.

Cold temperatures can damage the electronic control. When using this appliance for the first time, or when the appliance has not been used for an extended period of time, be sure the appliance has been in temperatures above 32°F (0°C) for at least 3 hours before turning on the power to the appliance.

Do not attempt to operate the appliance during a power failure. If the power fails, always turn off the unit. If the unit is not turned off and the power resumes, the appliance will not operate and an error message will be displayed. Once the power resumes, reset the clock and the oven function.

CAUTION

- When heating fat or grease, watch it closely. Grease may catch fire if it becomes too hot.
- Do not use water or flour on grease fires. Smother fire or flame or use dry chemical or foam-type extinguisher. Cover the fire with a pan lid or use baking soda.
- Use dry potholders. Moist or damp potholders on hot surfaces may result in burns from steam. Do not let potholders touch hot cooking areas. Do not use towels or other bulky cloths.
- Do Not Heat Unopened Food Containers - Build-up of pressure may cause container to burst and result in injury.
- Wear Proper Apparel - Loose-fitting or hanging garments should never be worn while using the appliance. Do not let clothing or other flammable materials contact hot surfaces.
- Do not touch surface heating units or surface cooking elements, areas near these units or elements, interior surface of the oven, or the warmer drawer (if equipped). Surface heating areas and oven heating elements may be hot even though they appear cool. Areas near surface cooking units may become hot enough to cause burns. During and after use, do not touch, or let clothing or other flammable materials touch these areas until they are cool. These areas may include the cooktop, surfaces facing the cooktop, oven vent areas, oven door, and oven window.
- Do not store items of interest to children in the cabinets above a range. Children climbing on the range to reach items could be seriously injured.

WARNING

Do not use oven or warmer drawer (if equipped) for storage. Never use your appliance as a space heater to heat or warm the room.

IMPORTANT SAFETY INSTRUCTIONS

IMPORTANT

Read and follow the below instructions and precautions for unpacking, installing, and servicing your appliance:

- Remove all tape and packaging before using the appliance. Destroy the carton and plastic bags after unpacking the appliance. Never allow children to play with packaging material. Do not remove the wiring label and other literature attached to the range. Do not remove model/serial number plate.
- Proper Installation—Be sure your appliance is properly installed and grounded by a qualified technician in accordance with the National Electrical Code ANSI/NFPA No. 70 latest edition and local electrical code requirements. In Canada, install in accordance with CSA Standard C22.1, Canadian Electrical code, Part 1-latest edition, and local electrical code requirements. Install only per installation instructions provided in the literature package for this range.
- User Servicing—Do not repair or replace any part of the appliance unless specifically recommended in the manuals. All other servicing should be done only by a qualified technician. This reduces the risk of personal injury and damage to the oven.
- Ask your dealer to recommend a qualified technician and an authorized repair service. Know how to disconnect the power to the appliance at the circuit breaker or fuse box in case of an emergency.
- Never modify or alter the construction of an oven by removing the leveling legs, panels, wire covers, anti-tip brackets/screws, or any other part of the oven.
- Remove the oven door from any unused oven if it is to be stored or discarded.
- Be sure to have an appropriate foam-type fire extinguisher available, visible, and easily accessible located near the appliance.

IMPORTANT INSTRUCTIONS FOR USING YOUR COOKTOP

- Know which knob or key controls each surface heating area. Place cookware with food on the cooking area before turning it on. Turn the cooking area off before removing the cookware.
- Use proper pan size. This appliance is equipped with one or more surface units of different sizes. Select cookware with flat bottoms that match the surface unit heating element. The use of undersized cookware may expose a portion of the heating element to direct contact and may result in the ignition of clothing or other items. Using the proper cookware on the cooking zone will improve efficiency.
- To reduce the risk of burns, ignition of flammable materials, and spills due to unintentional contact with the utensil, the utensil handles should be turned inward and not extend over other cooking areas.
- Never leave surface elements unattended. Boil-overs may cause smoking and greasy spills may ignite. A pan that has boiled dry could be damaged and may damage the cooktop.
- Improper cookware may break due to sudden changes in temperature. Check the cookware manufacturer's recommendations for cooktop use.
- When you are flaming foods under a ventilating hood, turn on the fan.
- Glazed Cooking Utensils—Only certain types of glass, glass/ceramic, ceramic, earthenware, or other glazed utensils are suitable for cooktop service without breaking due to the sudden change in temperature. Check the manufacturer's recommendations for cooktop use.
- Do Not Use Decorative Surface Burner Covers. If an element is accidentally turned on, the decorative cover will become hot and possibly melt. Burns will occur if the hot covers are touched. Damage may also be done to the cooktop.
- Do not use Searing grill on the cooktop. The Searing grill is not designed for use on the cooktop. Doing so may result in a fire.

IMPORTANT SAFETY INSTRUCTIONS

IMPORTANT NOTICES ON COOKTOPS WITH COIL ELEMENTS

CAUTION

Do not use aluminum foil to line surface unit drip bowls or reflector pans. Only use aluminum foil as recommended in this manual. Improper installation of these liners may result in risk of electric shock or fire.

- Do not immerse or soak removable surface heating elements. Surface heating elements should never be immersed in water. Heating elements clean themselves during normal operation.
- Make sure drip pans or drip bowls are in place. Absence of these pans or bowls during cooking may subject wiring or components underneath to damage.

IMPORTANT INSTRUCTIONS FOR USING YOUR OVEN

- Use care when opening oven door, lower oven door, or warmer drawer (some models). Stand to the side of the appliance when opening the door of a hot range. Let hot air or steam escape before you remove or replace food in the oven.
- Keep oven vent ducts unobstructed. Touching surfaces in this area when the oven is on may cause severe burns. Do not place plastic or heat-sensitive items on or near the oven vent. These items can melt or ignite.
- Placement of Oven Racks - Always place oven racks in desired location while oven is cool. If rack must be moved while oven is hot, do not let potholder contact hot heating element in oven. Use potholders and grasp the rack with both hands to reposition. Do not let potholders contact the hot heating elements in the oven. Remove all cookware and utensils before moving the rack.
- Do not use a broiler pan without its insert. Broiler pans and inserts allow dripping fat to drain away from the high heat of the broiler. Do not cover the broiler insert with aluminum foil; exposed fat and grease could ignite.

- Protective Liners—Do not use aluminum foil to line oven bottom or any other part of the appliance. Only use aluminum as recommended for baking if used as a cover placed on the food. Any other use of protective liners or aluminum foil may result in a risk of electric shock or fire or a short circuit.
- Do not cook food on the oven bottom. Always cook in proper cookware and always use the oven racks.

IMPORTANT INSTRUCTIONS FOR CLEANING YOUR OVEN

CAUTION

Before manually cleaning any part of the appliance, be sure all controls are turned off and the range is cool. Cleaning a hot oven can cause burns.

- Clean the range regularly to keep all parts free of grease that could catch fire. Pay particular attention to the area around each surface element. Do not allow grease to accumulate. Greasy deposits in the fan could catch fire. Follow the manufacturer's instructions for cleaning hoods.
- Always follow the manufacturer's recommended directions for use of kitchen cleaners and aerosols. Be aware that excess residue from cleaners and aerosols may ignite causing damage and injury.
- Clean ventilating hoods frequently. Grease should not be allowed to accumulate on the hood or filter. Follow the manufacturer's instructions for cleaning hoods.
- Do not touch a hot oven light bulb with a damp cloth. Doing so could cause the bulb to break. Disconnect the appliance or shut off the power to the appliance before removing and replacing the bulb.

IMPORTANT SAFETY INSTRUCTIONS

SELF-CLEANING OVENS

- Clean only the parts listed in this manual. Before using self-clean, remove the broiler pan, any food, utensils, and cookware from the oven.
- Do not use oven cleaners. No commercial oven cleaner or oven liner protective coating of any kind should be used in or around any part of the appliance.
- Do not clean the oven door gasket. The door gasket is essential for a good seal. Care should be taken not to rub, damage, or move the gasket.
- Some birds are extremely sensitive to the fumes given off during the self-clean cycle of any oven. Move birds to another well-ventilated room.
- Remove oven racks. Oven racks color will change if left in the oven during a self-cleaning cycle.

GROUNDING INSTRUCTIONS

WARNING

Do not use an adapter plug or an extension cord, or remove grounding prong from the power cord. Failure to follow this warning may cause serious injury, fire, or death.

For personal safety, this appliance must be properly grounded.

For models factory-equipped with a power cord:

For maximum safety, the power cord must be plugged into an electrical outlet that is the correct voltage, is correctly polar-ized, and is properly grounded in accordance with local codes.

For ovens to be wired into a junction box:

It is the personal responsibility of the consumer to have the appropriate outlet with the correct, properly grounded wall receptacle installed by a qualified electrician. See the installation instructions packaged with this appliance for complete installation and grounding instructions.

WARNING

Avoid fire hazard or electrical shock. Do not use an adapter plug or an extension cord, or remove grounding prong from the power cord. Failure to follow this warning may cause serious injury, fire, or death.

See the installation instructions packaged with this appliance for complete installation and grounding instructions.

SURFACE CONTROLS

Using Proper Cookware

The size and type of cookware used will influence the setting needed for best cooking results. Be sure to follow the recommendations for using proper cookware as illustrated in Figure 1 and Figure 2.

Cookware should have flat bottoms that make good contact with the entire surface heating element. Check for flatness by rotating a ruler across the bottom of the cookware (See Figure 1).

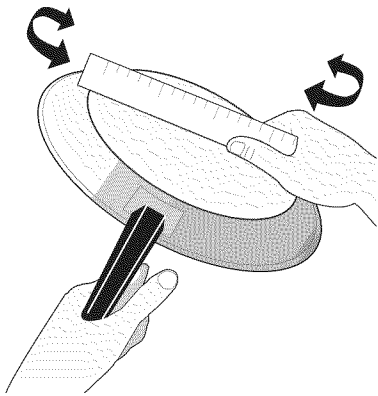

Figure 1: Check for level-bottomed cookware

Cookware Material Types

The cookware material determines how evenly and quickly heat is transferred from the surface element to the pan bottom. The most popular materials available are:

Aluminum - Excellent heat conductor. Some types of food will cause it to darken (Anodized aluminum cookware resists staining and pitting).

Copper - Excellent heat conductor but discolors easily (See Aluminum).

Stainless - Slow heat conductor with uneven cooking results. Is durable, easy to clean and resists staining.

Cast Iron - A slow heat conductor however will retain heat very well. Cooks evenly once cooking temperature is reached.

Porcelain-enamel on metal - Heating characteristics will vary depending on base material.

Glass - Slow heat conductor.

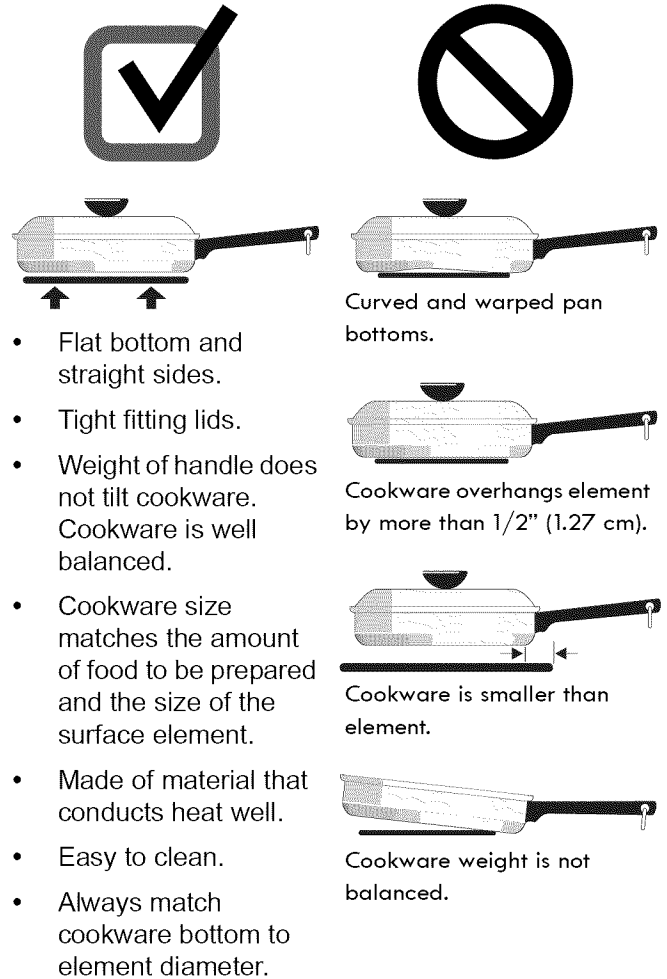

Figure 2: Troubleshooting guide

SURFACE CONTROLS

Home Canning

Be sure to read and observe all the following points when home canning with your appliance:

- Use only quality flat bottom canners when home canning. Use a straight-edge to check canner bottom.
- Use only a completely flat bottom canner with no ridges that radiate from the bottom center when home canning. Heat is spread more evenly when the bottom surface is flat.
- Make sure the diameter of the canner does not exceed 1 inch beyond the surface element markings or burner. It is recommended to use smaller diameter canners on electric coil and ceramic glass cooktops and to center canners on the burner grates.
- Start with hot tap water to bring water to boil more quickly.
- Use the highest heat setting when first bringing the water to a boil. Once boiling is achieved, reduce heat to lowest possible setting to maintain that boil.
- Check with the USDA (United States Department of Agriculture) Web site and be sure to read all the information they have available as well as follow their recommendations for home canning procedures.
- Use tested recipes and follow instructions carefully. Check with your local Cooperative Agricultural Extension Service or a manufacturer of glass jars for the latest canning information.
- It is best to can small amounts and light loads.
- Do not leave water bath or pressure canners on high heat for an extended amount of time.
- Alternate surface units between each batch to allow the units and surrounding surfaces to cool down. Try to avoid canning on the same burner unit all day.

CAUTION

Canning can generate large amounts of steam. Use extreme caution to prevent burns. Always raise the lid to vent steam away from you.

Safe canning requires that harmful micro-organisms are destroyed and the jars are sealed completely. When canning in a water bath canner, a gentle but steady boil must be maintained continuously for the required time.

Element on indicator lights

Your range is equipped with one or more element on indicator lights located on the control panel just above the surface control knobs (See Figure 3). The element on indicator light will glow when a surface element is turned on. A quick glance at this indicator light after cooking is an easy check to be sure all surface controls are turned off.

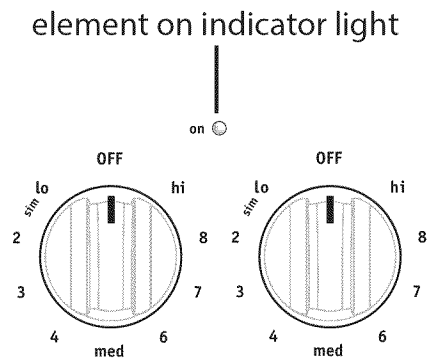

Figure 3: Indicator light location

IMPORTANT

Never place or straddle a cooking utensil over two different surface cooking elements at the same time unless the utensil is designed for that purpose. This can cause uneven heating results. This can also cause the ceramic cooktop to fracture (for ceramic cooktop models only).

SURFACE CONTROLS

Operating Surface Elements

To operate surface elements:

CAUTION

Surface elements may appear to have cooled after they have been turned off. The element surface may still be hot and burns may occur if the element or the area surrounding the element is touched before it has cooled sufficiently.

Do not place flammable items such as plastic salt and pepper shakers, spoon holders or plastic wrappings on top of the range when it is in use. These items could melt or ignite. Potholders, towels or wooden spoons could catch fire if placed too close to the surface elements.

Protective liners—Do not use aluminum foil to line surface drip bowls, or reflector pans. Improper installation of these liners may result in risk of electric shock, or fire. Only use aluminum foil as recommended in this manual.

1. Place correctly sized cooking utensil on surface element.
2. Push in and turn the surface control knob in either direction to the desired setting. Start most surface cooking on a higher setting and then turn to a lower setting to finish. The surface control knobs do not have to be set exactly on a particular spot. Use the graphics provided as a guide and adjust the control knob as needed (See Figure 4). Each surface element provides a constant amount of heat at each setting. For more information, see the suggested surface element settings in Table 1.
3. When cooking is complete, turn the surface element OFF before removing the cookware.

IMPORTANT

Do not allow aluminum foil, or any material that can melt to make contact with the surface element.

NOTE

The size and type of utensil used, and the amount and type of food being cooked will influence the surface setting needed for best cooking results.

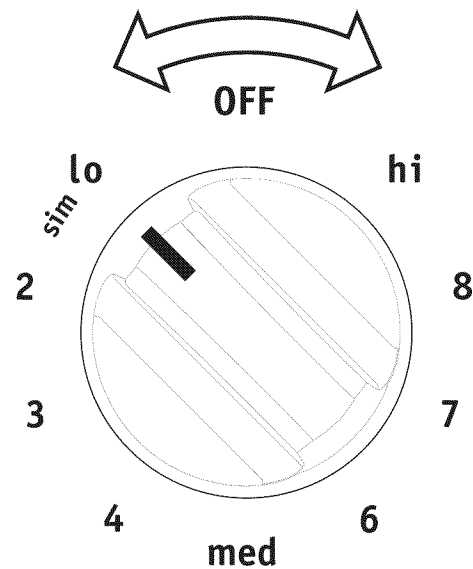

Figure 4: Control knob operation

Table 1: Suggested surface element settings^a

Settings	Types of Cooking
High (HI - 9)	Start most foods, bring water to a boil, pan broiling
Medium high (7 - 8)	Continue a rapid boil, fry, deep fat fry
Medium (5 - 6)	Maintain a slow boil, thicken sauces and gravies or steam vegetables
Medium Low (2 - 4)	Keep foods cooking, poach, stew
Low (LO - 1)	Keep warm, melt, simmer

^aThe suggested settings are based when cooking with medium-weight aluminum pans with lids. Settings may vary when using other types of pans.

BEFORE SETTING OVEN CONTROLS

Oven vent location

The oven vent is located through the upper front trim and visible when the oven door is open. When the oven is on, warm air passes through this vent. This venting is necessary for proper air circulation in the oven and good baking results. Do not block oven vent. Doing so may cause cooking failures, fires, or damage to the range. Steam or moisture may appear near the oven vent. This is normal.

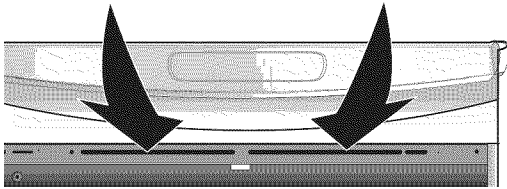

Figure 5: Do not block oven vent location

Removing, replacing, and arranging flat or offset oven racks

CAUTION

Always use pot holders or oven mitts when using the oven. When cooking, the oven interior and exterior, oven racks and cooktop will become very hot which can cause burns.

WARNING

Protective Liners — Do not use aluminum foil to line the oven bottom. Only use aluminum foil as recommended in this manual. Improper installation of these liners may result in risk of electric shock or fire.

To Arrange - Always arrange the oven racks when the oven is cool (prior to operating the oven).

To Remove - Pull the oven rack straight forward until it reaches the stop position. Lift up front of oven rack slightly and slide out.

To Replace - Place the oven rack on the rack guides on both sides of oven walls. Tilt the front of oven rack upward slightly and slide the oven rack back into place. Be sure oven racks are level before using.

Type of oven racks

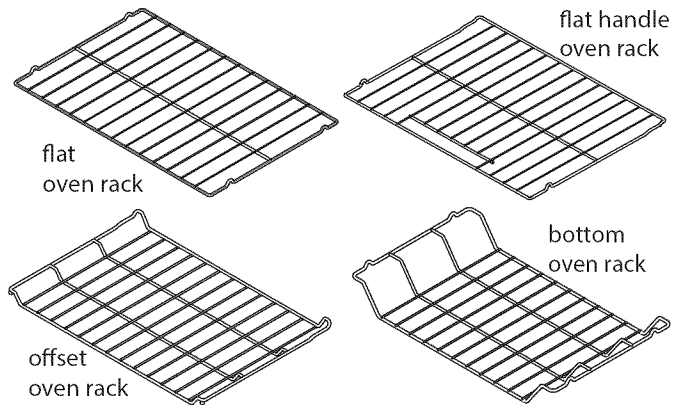

Figure 6: Oven rack types

Oven Rack Descriptions

- Flat oven racks (or the flat handle oven rack) may be used for most cooking needs and may be placed in most oven rack positions.
- The offset oven rack (some models) provides additional stepdown positions from the standard flat rack design. The offset design positions the base of the rack about 1/2 of a rack position lower than the flat rack and may be used in most oven rack positions.
- To maximize oven cooking space, place the bottom oven rack (some models) in the lowest rack position for baking or roasting large cuts of meat.

Air circulation in the oven

For best air circulation when baking, allow a space of 2-4 inches (5-10 cm) around the cookware for proper air circulation. Be sure pans and cookware do not touch each other, the oven door, sides, or back of the oven cavity.

Hot air must be able to circulate around cookware for even heat to reach the food.

IMPORTANT

Remove all oven racks and accessories before starting a self-clean cycle. If the oven racks are left in the oven during the self-clean cycle, they will lose their special coating properties, may turn blue, and no longer slide in and out of the oven cavity easily. If your model came with porcelain-enameled racks, those may be left in the oven during the self-clean cycle.

SETTING OVEN CONTROLS

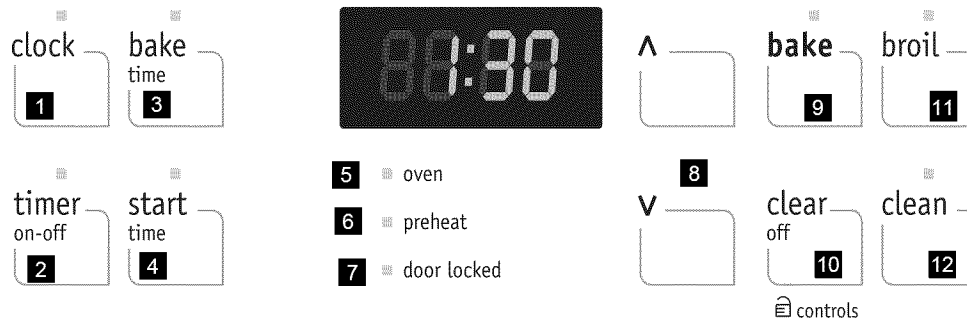

Oven Control Features

To get the best use of your oven, take some time to become familiar with the various features and functions of your oven model. Detailed instructions on using each oven feature and function of the controls can be found in this section of the owner's manual.



- 1. Clock** - Use to set the time of day.
- 2. Timer on-off** - Use to set or cancel the minute timer. The minute timer does not start or stop any cooking function. Timer on-off is used to set the continuous bake function.
- 3. Bake time** - Enters the length of baking time desired.
- 4. Start time** - Use to set the desired start time for baking and self-clean. May be used with bake time to program a delayed timed bake.
- 5. Oven light** - The oven light will glow each time the oven turns on to maintain the set oven temperature.
- 6. Preheat light** - The preheat light will glow when the oven is first set to operate or if the desired temperature is reset higher than the actual oven temperature.
- 7. Door locked** - The door locked light will flash when the oven door locks and unlocks, when the oven door lockout is active, or when the self-clean cycle feature is active.
- 8. Up and Down arrows** - Use with the feature or function keys to set oven temperature, bake time, start time, clean time (when programming an automatic start time), and setting or adjusting the clock and minute timer.
- 9. Bake** - Use to select bake feature.
- 10. Clear-off** - Use to clear any feature previously entered except the time of day and minute timer. Press clear off to stop cooking. Also use clear off to activate oven lockout feature.
- 11. Broil** - Use to set Broil feature.

- 12. Clean** - Use to set self-clean cycle.

Setting the Clock

When the appliance is first plugged in or when the power supply to the appliance has been interrupted, the display will flash **12:00**. It is recommended to always set the clock for the correct time of day before using the appliance.

To set the clock:

- Press **clock** once (do not hold clock key down).
- Within 5 seconds, press and hold  or  until the correct time of day appears in the display.





NOTE

The clock cannot be changed when the oven is set for cooking or self-clean is active.

Temperature display (Fahrenheit/Celsius)

The electronic oven control is set to operate in Fahrenheit (°F) at the factory. The oven may be programmed for any temperature from 170°F to 550°F (77°C to 288°C).

To change the temperature to Celsius (°C) or from °C to °F:

- Press **broil**.  appears in the display.
- Press and hold  until **HI** appears in the display.
- Press and hold **broil** until **°F** or **°C** appears in the display.
- Press  or  to change °F to °C or °C to °F. To accept the change, wait 6 seconds.

SETTING OVEN CONTROLS

Table 2: Minimum and maximum control settings^a

Feature	Mode	Minimum Temp. /Time	Maximum Temp. /Time
Preheat		170°F (77°C)	550°F (288°C)
Bake		170°F (77°C)	550°F (288°C)
Broil		400°F (205°C)	550°F (288°C)
Timer	12 Hr. Mode 24 Hr. Mode	0:01 Min. 0:01 Min	11:59 Hr./Min. 11:59 Hr./Min.
Clock Time	12 Hr. Mode 24 Hr. Mode	1:00 Hr./Min. 0:00 Min	12:59 Hr./Min. 23:59 Hr./Min.
Delay Start	12 Hr. Mode 24 Hr. Mode	1:00 Hr./Min. 0:00 Min	12:59 Hr./Min. 23:59 Hr./Min
Bake Time	12 Hr. Mode 24 Hr. Mode	0:01 Min 0:01 Min	5:59 Hr./Min. 5:59 Hr./Min.
Self Clean Time		2 hours	4 hours

a. The features listed show the minimum and maximum time or temperature settings allowable.

Changing between continuous bake setting or 12-hour energy saving feature

The oven control has a built-in 12-hour energy saving feature that will shut off the oven if the oven is left on for more than 12 hours. The oven control can be programmed to override this feature for continuous baking.

To change the continuous bake setting:

1. Press and hold **timer on-off** for 6 seconds until a tone sounds. **— — hr** will appear in the display for continuous cooking. The current time of day will return to the display.
2. To cancel the continuous bake setting, press **timer on-off** and hold for 6 seconds until a tone sounds. **12 hr** will appear in display indicating that the control has returned to the 12-hour energy saving feature.

Setting a silent control panel

When selecting a function, an audible tone is heard each time a key is pressed. If desired, the control can be programmed for silent operation. To set the controls for silent operation, press and hold **start time** for 6 seconds. The control will beep once, then release the key. To return to non-silent operation, press and hold **start time** again for 6 seconds until the control beeps once.

NOTE

Do not use oven thermometers such as those found in grocery stores to check the temperature settings inside your oven. These oven thermometers may vary as much as 20 to 40 degrees from actual temperatures.

IMPORTANT

Changing to continuous bake or 12 hour mode does not change how the cooktop controls operate.

SETTING OVEN CONTROLS

Setting oven lockout

The control can be programmed to lock the oven door and lockout the oven control keypad.



To set the oven lockout feature:

1. Press **clear off** and hold for 3 seconds. **Loc** will appear in display, the **door locked** indicator light will flash, and the motor driven door lock will begin to close. Allow about 15 seconds for the oven door to lock. Once the oven door is locked, the current time of day will appear in the display.
2. To cancel the Oven Lockout feature, press **clear off** and hold for 3 seconds. The control will unlock the oven door and resume normal operation.

NOTE

If any control key is pressed with the oven lockout feature active, **Loc** will appear in the display until the control key is released. But it does not disable the clock, kitchen timer, or the interior oven lights.

Setting the minute timer

1. Press **timer on-off**.
2. Press  to increase time in one-minute increments. Press and hold  to increase time in 10-minute increments. The timer can be set for any amount of time from 1 minute to 11 hours and 59 minutes.

NOTE

If  is pressed first, the timer will advance to 11 hours and 59 minutes.

3. When the set time ends, the timer will beep three times and will continue to beep three times every minute until **timer on-off** is pressed.



NOTE

The indicator light located above the timer on-off key will glow while the minute timer is active.

NOTE

The minute timer will not start or stop the cooking process. The minute timer can be used alone or while using any of the other oven features. If another feature is active when the minute timer is active, the minute timer will show in the display. To view information about other active features, press the key for that feature.

To change the timer while it is in use:

While the timer is active and shows in the display, press and hold  or  to increase or decrease the time remaining.

To cancel the minute timer before the set time has run out:

- Press **timer on-off** once.

Operating the Oven Light

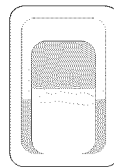

Figure 7: Oven light switch



The interior oven light will automatically turn on when the oven door is opened. Press the oven light switch located on the control panel to turn the interior oven light on and off whenever the oven door is closed. To change the interior oven light, see "Replacing the oven light" on page 24.

SETTING OVEN CONTROLS



Setting Bake

The oven can be programmed to bake at any temperature from 170°F to 550°F (77°C to 288°C). The factory preset automatic bake temperature is 350°F (177°C).

To set bake:

1. Press **bake**. — — — appears in the display.
2. Within 5 seconds, press  or . The display will show **350°F (177°C)**. The temperature can then be adjusted in 5°F (1°C) increments.
3. When a key is released, the oven will begin heating to the selected temperature. When the oven reaches the set temperature, the preheat indicator light will turn off and the control will beep three times.
4. To cancel the baking function, press **clear off**.

To change oven temperature after bake has started:

1. Press **bake**.
2. Press  or  to increase or decrease to a new temperature. The oven indicator light on the electronic display will turn on and off when using the bake feature and during preheat. This is normal and indicates that the oven is cycling to maintain the selected baking temperature. To cancel baking press **clear off**.

Baking Tips

For best bake results:

- Fully preheat the oven before baking items like cookies, cakes, biscuits, and breads.
- When using any single rack, position the rack so that the food is in the center of the oven.
- For best results when baking cakes using two oven racks, place racks in positions 2 and 4 (See Figure 8).
- When baking using two oven racks, position cookware as shown in Figure 9. Allow at least 2 inches (5 cm) of space between cookware for proper air circulation.
- Dark or dull bakeware absorbs more heat than shiny bakeware. It may be necessary to reduce oven temperature and cook time to prevent overbrowning of some foods. Dark bakeware is recommended for pies. Shiny bakeware is recommended for cakes, cookies, and muffins.
- For batter and dough-based baked goods such as cakes, pastries, and breads, use the convection function for best results.

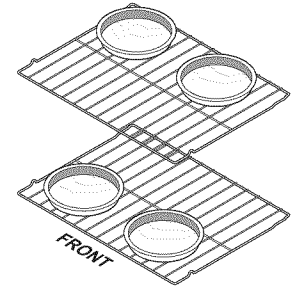
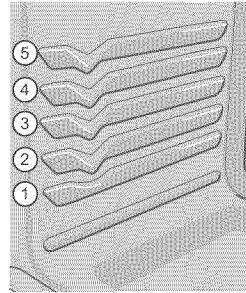

Figure 8: Rack positions Figure 9: Pan spacing





Setting bake time

The **bake time** key sets the amount of time needed for baking. The oven will turn on immediately and stop automatically after the set bake time ends.

To program the oven to begin baking immediately and to shut off automatically (timed bake):

CAUTION

Food Poisoning Hazard. Do not let food sit for more than one hour before or after cooking. Doing so can result in food poisoning or sickness. Foods that can easily spoil such as milk, eggs, fish, meat, or poultry should be chilled in the refrigerator first. Even when chilled, they should not stand in the oven for more than 1 hour before cooking begins and should be removed promptly when finished cooking.

1. Be sure the clock is set to the correct time of day.
2. Place the food in the oven.
3. Press **bake**. — — — ° appears in the display.
4. Within 5 seconds, press  or . The display will show **350°F (177°C)**. The temperature can then be adjusted in 5°F (1°C) increments,
5. Press **bake time.0:00** will appear in the display.
6. Press  or  until the desired baking time appears in the display.
7. The oven will turn on and begin heating.

When the set bake time runs out:

1. **End** will appear in the display, and the oven will shut off automatically.
2. The control will beep three times every 60 seconds as a reminder until **clear off** is pressed.

SETTING OVEN CONTROLS

NOTE

- Bake time will not operate when using the broil feature.
- Once the controls are set, the oven will come on and begin heating to the selected baking temperature. The oven temperature (or time of day) will show in the display.







Setting start time

Use the **start time** key to delay the starting time (delayed timed bake). The oven will turn on at a later time and stop automatically after the set bake time ends.

To program oven for a delayed start time and to shut-off automatically:

CAUTION

Food Poisoning Hazard. Do not let food sit for more than one hour before or after cooking. Doing so can result in food poisoning or sickness. Foods that can easily spoil such as milk, eggs, fish, meat, or poultry should be chilled in the refrigerator first. Even when chilled, they should not stand in the oven for more than 1 hour before cooking begins and should be removed promptly when finished cooking.

1. Be sure that the clock displays the correct time of day.
2. Place food in the oven.
3. Press **bake**. **---**° appears in the display. Within 5 seconds, press  or . The display will show **350°F (177°C)**. The temperature can then be adjusted in 5°F (1°C) increments.
4. Press **bake time**. **0:00** will appear in the display.
5. Press  or  until desired baking time appears.
6. Press **start time**. The time of day will appear in the display.
7. Press  or  until the desired start time appears in the display.
8. Once the controls are set, the control calculates the time when baking will stop. The oven will turn on at the delayed start time and begin heating.

To change the oven temperature (or bake time) after baking has started:

1. Press the function you want to change.
2. Press  or  to adjust the setting.



NOTE

During a delayed timed bake, the preheat indicator light will not function until the set time to start cooking is reached.

Adjusting the oven temperature

Your appliance has been factory calibrated and tested to ensure an accurate baking temperature. For the first few uses, follow your recipe times and temperature recommendations carefully. If you think the oven is cooking too hot or too cool for your recipe times, you can adjust the control so the oven cooks hotter or cooler than the temperature displayed.

To adjust oven temperature:

1. Press **bake**.
2. Set the temperature to 550°F (288°C) by pressing and holding .
3. Within 3 seconds, press and hold **bake** until numeric digit(s) appear. Release **bake** key. The display now indicates the amount of degrees offset between the original factory temperature setting and the current temperature setting. If the oven control has the original factory calibration, the display will read **00**.
4. The temperature can now be adjusted up or down 35°F (19°C), in 5°F increments. Press and hold  to adjust the temperature higher until the desired amount of offset appears in the display. When lowering the oven temperature using , a minus sign (-) will appear before the number to indicate that the oven will be cooler by the displayed amount of degrees.
5. When you have made the desired adjustment, press **clear off** to go back to the time of day display.

NOTE



- Oven temperature adjustments made will not affect the broil or self-cleaning feature temperatures.
- If the display is set for Celsius, adjustments made will be in 1°C increments each press of arrow keys.

SETTING OVEN CONTROLS

Setting broil

Use the broil feature to cook meats that require direct exposure to radiant heat for optimum browning results. When broiling, always remember to arrange the oven racks while oven is still cool. Position the rack as suggested in Table 3.

To set broil

1. Arrange the oven rack while oven is still cool.
2. Press **broil**. — — will appear in display.
3. Press  for **HI** broil or  for **LO** broil. Most foods may be broiled at the HI broil setting. Select the LO broil setting to avoid excess browning or drying of foods that should be cooked to the well-done stage.
4. For optimum results, preheat broil for 2-to-5 minutes before adding food.
5. Place the insert on the broil pan (if equipped), then place the food on the broil pan insert (if using a broiler pan and insert).
6. Place the broiler pan and insert on the oven rack.
7. Broil on one side until food is browned. Turn and broil food on 2nd side.

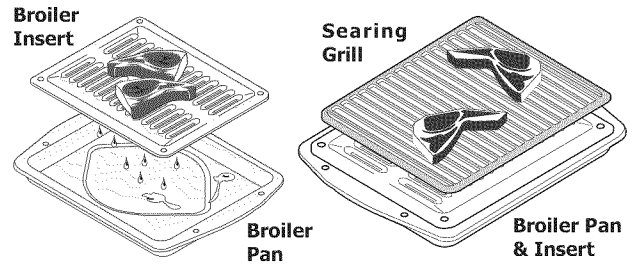

Figure 10: Broil accessories

WARNING

Should an oven fire occur, close the oven door and turn the oven off. If the fire continues, use a fire extinguisher. Do not put water or flour on the fire. Flour may be explosive.

The broiler pan and the insert (some models) allow grease to drain and be kept away from the high heat of the broiler. Do not use the pan without the insert. Do not cover the insert with aluminum foil; the exposed grease could ignite. To ensure proper results when broiling, use only Electrolux Home Products, Inc. approved broil pan and insert.

NOTE

Always pull the oven rack out to the stop position before turning or removing food.

NOTE

To purchase a broiling pan and insert, visit frigidaire.com

8. When broiling is finished press **clear off**.

Table 3: Broil recommendations

Food item	Rack Position	Temperature	Cook time in minutes		Doneness
			1st side	2nd side	
Steak 1" thick	3rd or 4th	550°F	6:00	4:00	Rare
	3rd or 4th	550°F	7:00	5:00	Medium
Pork Chops 3/4 "thick	3rd or 4th	550°F	8:00	6:00	Well
Chicken - Bone In	3rd	450°F	20:00	10:00	Well
Chicken Boneless	3rd or 4th	450°F	8:00	6:00	Well
Fish	3rd	500°F	13:00	--	Well
Shrimp	3rd	550°F	5:00	--	Well
Hamburger 1" thick	3rd or 4th	550°F	9:00	7:00	Medium

SETTING OVEN CONTROLS

Self-Cleaning

A self-cleaning oven cleans itself with temperatures well above normal cooking temperatures which eliminate soils completely or reduces them to a fine powdered ash you can wipe away with a damp cloth.

While the oven is in operation, the oven heats to temperature much higher than those used in normal cooking. Sounds of metal expansion and contraction are normal. Odor is also normal because the food soil is being removed. Smoke may appear through the oven vent.

→ IMPORTANT

Adhere to the following self-clean precautions:

- Do not use oven cleaners or oven protective coatings in or around any part of the oven interior.
- Do not clean the oven door gasket (Figure 11). The woven material of the oven door gasket is essential for a good seal. Care should be taken not to rub, damage, or remove the gasket.
- Do not use any cleaning materials on the oven door gasket. Doing so could cause damage.
- Remove the broiler pan and insert, all utensils, and any aluminum foil. These items cannot withstand high cleaning temperatures and will melt.
- Completely remove all oven racks and any accessories. If the oven racks are not removed, they will lose their special coating properties and no longer slide in and out of the oven cavity easily.
- Remove any excessive spills. Any spills on the oven bottom should be wiped-up and removed before starting the self-cleaning cycle. To clean, use hot, soapy water and a cloth. Large spills can cause heavy smoke or fire when subjected to high temperatures.
- Do not allow food spills with a high sugar or acid content (such as milk, tomatoes, sauerkraut, fruit juices, or pie filling) to remain on the surface as they may leave a dull spot even after cleaning.
- Clean any soil from the oven frame, the door liner outside the oven door gasket, and the small area at the front center of the oven bottom. These areas heat sufficiently to burn soil on. Clean with soap and water. These areas are shown in white (Figure 11).

⚠ CAUTION

During the self-cleaning cycle, the outside of the range can become very hot to the touch. Do not leave small children unattended near the appliance.

The health of some birds is extremely sensitive to the fumes given off during the self-cleaning cycle of any range. Move birds to another well-ventilated room.

Do not force the oven door open. This can damage the automatic door locking system. Use caution when opening the door after the self-cleaning cycle is complete. The oven may still be very hot.

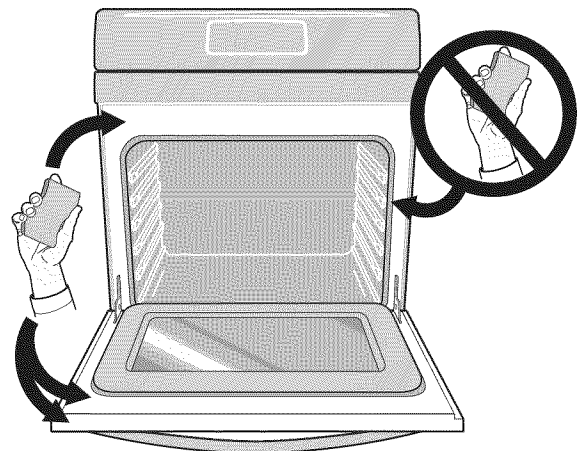

Figure 11: Clean around the oven door gasket

⚠ CAUTION

To avoid possible burns, use care when opening the oven door after the self-cleaning cycle. Stand to the side of the oven when opening the door to allow hot air or steam to escape.

Do not line the oven walls, racks, bottom, or any other part of the range with aluminum foil. Doing so will destroy heat distribution, produce poor baking results, and cause permanent damage to the oven interior (aluminum foil will melt to the interior surface of the oven).





SETTING OVEN CONTROLS

To set a self-clean cycle or a delayed start self-clean cycle:

1. Be sure the clock displays the correct time of day.

IMPORTANT

To start a self-clean cycle immediately without a delay, skip Step 2 and Step 3 in the instructions provided below.

2. Press **start time**. The **:** in the time of day will flash.
3. Press and hold  to scroll to the time to start the delayed self-clean cycle. Release the key when the desired time is displayed.
4. Press **clean**. **---** appears in the display.
5. Press  until **3:00** appears in the display for a 3 hour self-clean process, or push  until **2:00** appears in the display for a 2 hour self-clean process.
(Some models) For a 4 hour self-clean time, press  until (4:00 appears in display).
6. As soon as the controls are set, the motor driven lock will begin to close automatically and the **door locked** indicator light will flash. Do not open the oven door while the light is flashing (allow about 15 seconds for the oven door to lock).
7. **CLn** will appear in the display during the self-clean cycle, and the **door locked** light will glow until the self cleaning cycle is complete or cancelled and the oven temperature has cooled.

When the self-clean cycle has completed:

1. The time of day will appear in the display window, and the **Clean** key and **door locked** light will continue to glow.
2. Once the oven has cooled down for about 1 hour and the **door locked** light has gone out, the oven door may be opened.

To stop or interrupt a self-clean cycle (once it has been activated):

1. Press **clear off**.
2. Once the oven has cooled down for about 1 hour and the **door locked** light has turned off, the oven door can be opened.
3. Restart the self-clean cycle once all conditions have been corrected.

NOTE

Whenever the self-clean feature is active, you may check the amount of time remaining in the self-clean cycle by pressing the **clean** key. Remember the range door cannot be opened until the range has cooled sufficiently. You will need to add about 1 hour to the time displayed before you can use the range for cooking.

When the oven is cool, wipe away any residue or powdered ash with a damp cloth or paper towel.

CARE AND CLEANING

Cleaning Various Parts of Your Wall Oven

Before cleaning any part of the oven, be sure all controls are turned off and the oven is cool. Remove spills and any heavy soiling as soon as possible. Regular cleaning will reduce the number of major cleaning later.

Surface Type	Recommendation
Aluminum and Vinyl	Use hot, soapy water and a cloth. Dry with a clean cloth.
Painted and plastic control knobs Painted body parts Painted decorative trims	Use a soft cloth and clean with mild dish detergent and water or a 50/50 solution of vinegar and water. Follow by rinsing the area with clean water; dry and polish with a soft cloth. Glass cleaners may be used if sprayed on a soft cloth first. Do not spray liquids directly on the oven control and display area. Do not use large amounts of water on the control panel - excess water on the control area may cause damage to the appliance. Do not use other liquid cleaners, abrasive cleaners, scouring pads, or paper towels - they will damage the finish. To remove control knobs, turn to the OFF position; grasp firmly and pull straight off the shaft. To replace knobs after cleaning, line up the flat sides of both the knob and the shaft; then push the knob into place.
Stainless Steel	Your oven finish may be made with stainless steel (some models). Clean the stainless with warm soapy water using a clean sponge or cloth. Rinse with clean water and dry with a soft clean cloth. Do not use any store bought cleaners like stainless steel cleaners or any other types of cleaners containing any abrasive, chlorides, chlorine or ammonia. It is recommended to use mild dish soap and water or a 50/50 solution of water and vinegar. Do not use harsh scrubbing cleaners. Only use kitchen cleaners that are especially made for cleaning stainless steel. Always be sure to rinse the cleaners from the surface as bluish stains may occur during heating that cannot be removed.
Porcelain enamel broiler pan and insert (available by mail order) Door liner and body parts	Gentle scouring with a soapy scouring pad will remove most spots. Rinse with a 1:1 solution of clear water and ammonia. If necessary, cover difficult spots with an ammonia-soaked paper towel for 30 to 40 minutes. Rinse with clean water and a damp cloth, and then scrub with a soap-filled scouring pad. Rinse and wipe dry with a clean cloth. Remove all cleaners or the porcelain may become damaged during future heating.
Oven racks	Oven racks must be removed from oven cavity. Clean by using a mild, abrasive cleaner following manufacturer's instructions. Rinse with clean water and dry. After cleaning the racks, rub the sides of the racks with wax paper or a cloth containing a small amount of baby oil or salad oil (this will make the racks glide easier into the rack positions).
Oven door	Use soap and water to thoroughly clean the top, sides, and front of the oven door. Rinse well. You may use a glass cleaner on the outside glass of the door. Do not immerse the door in water. Do not spray or allow water or the glass cleaner to enter the door vents. Do not use oven cleaners, cleaning powders, or any harsh abrasive cleaning materials on the outside of the oven door. Do not clean the oven door gasket. On self-clean models, the oven door gasket is made of a woven material which is essential for a good seal. Care should be taken not to rub, damage, or remove this gasket.

CARE AND CLEANING

Coil Elements Cooktop Cleaning and Maintenance

! WARNING

Never leave covers on the coil elements. They could be permanently damaged if turned on by accident.

Prior to cleaning the coil elements make sure they are cold and that control knobs are set at OFF. Never immerse the coil elements in water.

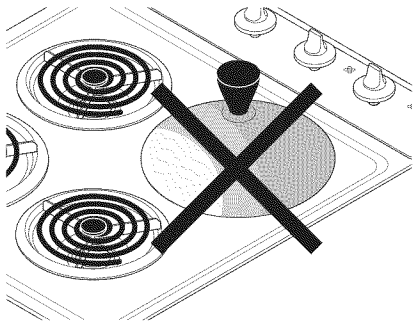

Figure 12: Covers left on elements may damage coil.

To Remove and Replace Surface Elements and Drip Bowls (some models)

! CAUTION

Before cleaning the cooktop, be sure the controls are turned to **OFF** and the cooktop is cool.

! CAUTION

Be careful not to bend terminal ends when replacing elements after cleaning.

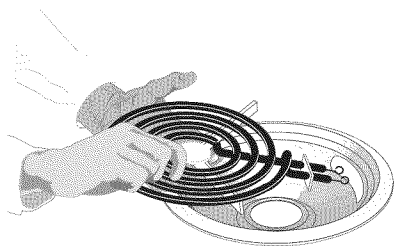

Figure 13: Terminal ends should never be bent.

To Remove

1. Lift up edge of surface element across from terminal end just enough to clear the edge of the drip bowl.
2. Gently slide the surface element out of the terminal plug.
3. Lift the drip bowl up and out.

To Replace

1. Line up the opening of the drip bowl with the terminal plug.
2. Hold the surface element as level as possible and slide the terminal end through the opening and into the terminal plug.
3. Be sure the surface element is level to reduce the hazard of pans sliding off the element.

To Raise the Top for Cleaning

! CAUTION

When lowering the lift-up cooktop, grasp the sides with fingertips only. Be careful not to pinch fingers. Do not drop or bend the cooktop when raising or lowering. This could damage the surface.

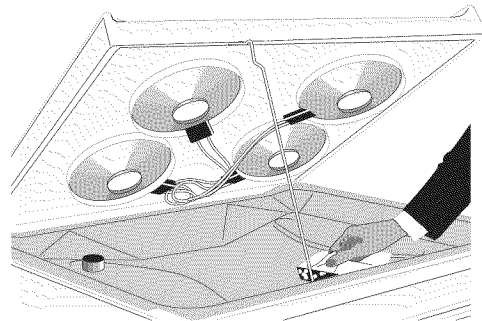

Figure 14: Rod swings up to support for cleaning

1. Grasp the sides and lift from the front. Some models may have a lift-up rod to support the top in its raised position. Lift the top only high enough to allow the support rod to fit into place, then gently lower the cooktop onto the raised rod.
2. Clean underneath using a clean cloth and hot, soapy water.
3. Gently lower the cooktop into the frame. If your model has a support rod, lower the support rod, then gently lower the cooktop into the frame.

CARE AND CLEANING

Porcelain enamel cooktop cleaning instructions (some models)

WARNING

Do not use a cooktop cleaner on a hot cooktop. The fumes can be hazardous to your health, and can chemically damage the cooking surface.

CAUTION

Before cleaning the surface cooktop, be sure the controls are turned to OFF and the cooktop is cool. Do not use commercial oven cleaners on the exterior surfaces including cooktop and door frame.

Correct and consistent cleaning is essential to maintaining your porcelain enamel cooktop. If food spills and grease spatters are not removed, they may burn onto the surface of the cooktop and cause permanent discoloration.

Daily cleaning for normal soil:

1. Allow cooktop surface to cool.
2. Wipe off spills and spatters using a clean paper towel or a clean cloth with warm, soapy water.
3. If needed, use a soapy steel wool pad or other mild household cleaners.
4. Be sure to rinse off the cleaners or the porcelain may become damaged during future heating.

Daily cleaning for heavy, burned-on soil:

1. Allow cooktop surface to cool.
2. Use a soap filled scouring pad with warm water or cover heavily soiled spots with a solution of clear water and ammonia. Scour gently. Rinse and wipe dry with a clean cloth.
3. If any soil remains, apply a few drops of a recommended cooktop cleaning cream on the spots and rub gently using a clean damp cloth or scouring pad. Buff with a dry cloth until all soil and cream are removed. Frequent cleaning with the cooktop cleaning cream leaves a protective coating which helps in preventing scratches and abrasions.

Daily cleaning for sugary spill overs:

Sugary spills can chemically damage your cooktop surface. Therefore, you must begin cleaning the spills while the cooktop is still hot. Use caution when following the steps below.

1. Turn off all surface units and remove all pans immediately.
2. Wearing an oven mitt, wipe up carefully or move hot spills away from the element area with a clean damp cloth.
3. Allow the cooktop to cool. Follow the instructions above for heavy, burned-on soil.

NOTE

Cooktop cleaning / polishing cream can be purchased through authorized service centers or major department stores.

Removing and Replacing the Oven Door

⚠ CAUTION

The door is heavy. For safe, temporary storage, lay the door flat with the inside of the door facing down.

To remove oven door:

1. Open oven door completely, horizontal with floor (See Figure 15).
2. Pull the door hinge locks on both left and right door hinges down from the oven frame completely towards the oven door (See Figure 16). A tool such as a small flat-blade screwdriver may be required.
3. Firmly grasp both sides of oven door along the door sides. Do not use the oven door handle (See Figure 17).
4. Close the door to approximately 10 degrees from the door frame (See Figure 17).
5. Lift the oven door hinge arms over the roller pins located on each side of the oven frame (See Figure 17).

To replace oven door:

1. Firmly grasp both sides of oven door along the door sides. Do not use the oven door handle (See Figure 17).
2. Holding the oven door at the same angle as the removal position, seat the hook of the hinge arm over the roller pins located on each side of the oven door frame (See Figure 17 and Figure 18). The hook of the hinge arms must be fully seated onto the roller pins.
3. Fully open the oven door, horizontal with floor (See Figure 15).
4. Push the door hinge locks up towards and into the oven frame on both left and right oven door hinges to the locked position (See Figure 16).
5. Close the oven door.

➔ IMPORTANT

Special door care instructions - Most oven doors contain glass that can break. Do not close the oven door until all the oven racks are fully in place. Do not hit the glass with pots, pans, or any other object. Scratching, hitting, jarring, or stressing the glass may weaken its structure causing an increased risk of breakage at a later time.

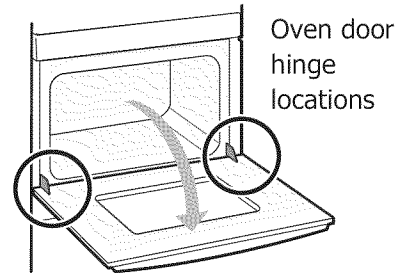

Figure 15: Door hinge location

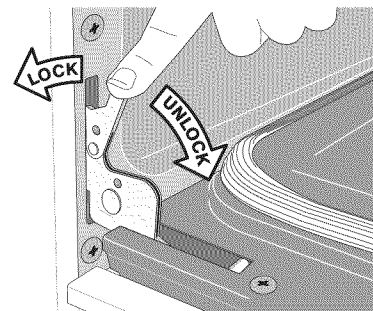

Figure 16: Door hinge locks

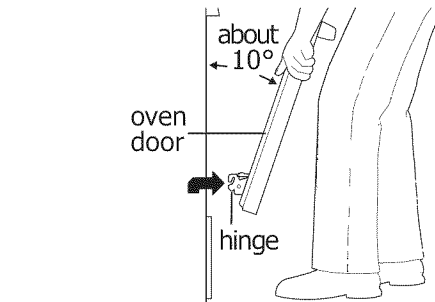

Figure 17: Holding door for removal

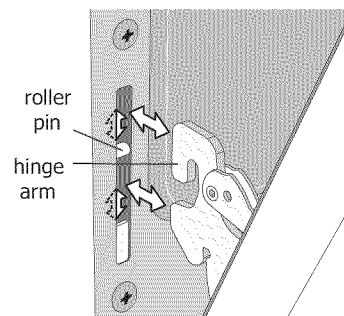

Figure 18: Replacement and location of hinge arm and roller pin

CARE AND CLEANING

Replacing the oven light

CAUTION

Be sure the oven is unplugged and all parts are cool before replacing oven light.

The interior oven lights are located at the rear of the oven cavity and are covered with a glass shield. The glass shield must be in place whenever the oven is in use (See Figure 19).

Replacing the oven interior light bulb:

1. Turn electrical power off at the main source or unplug the appliance.
2. Remove interior oven light shield by turning a quarter turn.
3. Replace bulb with a new T-4 type Halogen 25 watt appliance bulb.

NOTE

Do not allow your fingers to touch the new bulb when replacing. This will shorten the life of the bulb. Use a paper towel or cotton glove while handling the new bulb when installing.

4. Replace glass oven light shield.
5. Turn power back on again at the main source (or plug the appliance back in).
6. Be sure to reset the time of day on the clock.

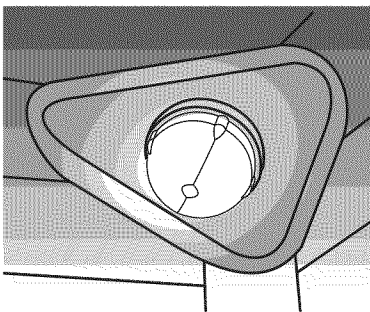

Figure 19: Wall oven Halogen light

To remove and replace storage drawer (some models)

Use the storage drawer for storing cooking utensils. The drawer can be removed to facilitate cleaning under the range. Use care when handling the drawer.

To remove the drawer:

1. Pull empty drawer out to the roller guide stop.
2. Tilt the drawer up and pull it out over the rollers.

To replace the drawer:

1. Insert the rear end of the drawer into the opening.
2. Fit the drawer end rollers onto the guide rails.
3. Push the drawer in until it stops, then lift to allow the rollers to clear the roller guide stop, and push in.

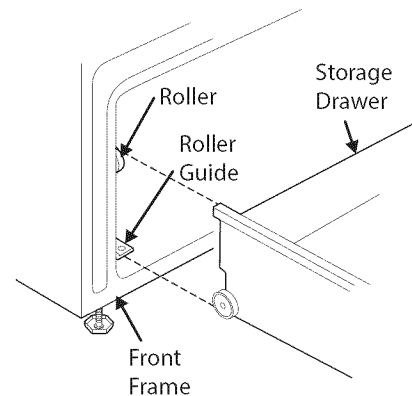
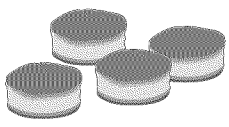
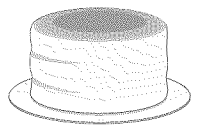
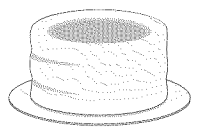
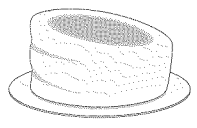
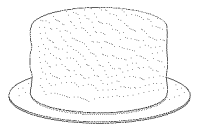

Figure 20: Storage drawer removal and replacement

Oven Baking

For best cooking results, heat the oven before baking cookies, breads, cakes, pies, or pastries. There is no need to preheat the oven for roasting meat or baking casseroles. The cooking times and temperatures needed to bake a product may vary slightly from your previously owned appliance.

Baking Problems and Solutions

Baking Problems	Causes	Corrections
<p>Cookies and biscuits burn on the bottom.</p> 	<ul style="list-style-type: none"> • Cookies and biscuits put into oven before the preheating time is completed. • Oven rack is overcrowded. • Dark pans absorb heat too fast. 	<ul style="list-style-type: none"> • Allow oven to preheat to desired temperature before placing food in oven. • Choose pan sizes that will permit 2" to 4" of air space (5.1 cm to 10.2 cm) on all sides when placed in the oven. • Use a medium weight baking sheet.
<p>Cakes too dark on top or bottom</p> 	<ul style="list-style-type: none"> • Cakes put in oven before preheating time is completed. • Rack position too high or too low. • Oven too hot. 	<ul style="list-style-type: none"> • Allow oven to preheat to the selected temperature before placing food in the oven. • Use proper rack position for baking needs. • Set oven temperature 25°F (12°C) lower than recommended.
<p>Cakes not done in center</p> 	<ul style="list-style-type: none"> • Oven too hot. • Incorrect pan size. • Pan not centered in oven. 	<ul style="list-style-type: none"> • Set oven temperature 25°F (12°C) lower than recommended. • Use pan size suggested in recipe. • Use proper rack position and place pan so there is 5.1 cm to 10.2 cm (2" to 4") of space on all sides of pan.
<p>Cakes not level.</p> 	<ul style="list-style-type: none"> • Oven not level. • Pan too close to oven wall or rack overcrowded. • Pan warped. 	<ul style="list-style-type: none"> • Place a marked glass measuring cup filled with water on the center of the oven rack. If the water level is uneven, refer to the installation instructions for leveling the oven. • Be sure to allow 5.1 cm to 10.2 cm (2" to 4") of clearance on all sides of each pan in the oven. • Do not use pans that are dented or warped.
<p>Foods not done when cooking time is over.</p> 	<ul style="list-style-type: none"> • Oven too cool. • Oven overcrowded. • Oven door opened too frequently. 	<ul style="list-style-type: none"> • Set oven temperature 25°F (12°C) higher than suggested and bake for the recommended time. • Be sure to remove all pans from the oven except the ones to be used for baking. • Open oven door only after shortest recommended baking time.

BEFORE YOU CALL

Solutions to Common Problems

Before you call for service, review the following list. It may save you time and expense. Possible solutions are provided with the problem listed:

Problem	Solution
Poor baking results	<ul style="list-style-type: none">• Many factors affect baking results. Use proper oven rack position. Center food in the oven and space pans to allow air to circulate. Preheat oven to the set temperature before placing food in the oven. Try adjusting the recipe's recommended temperature or baking time. See "Adjusting the oven temperature" on page 16 if you feel the oven is too hot or cold.• If your oven is cooking poorly or Self Clean is performing badly, perform the following check. Press Broil, press the Up button, and HI should be on the display. Place your hand near the handle on the oven door. Between the door and the control panel, you should feel a rush of air on your hand. If so, your unit is functioning properly and you have had a power failure in your home. If no air stream is present, call a service technician to replace your cooling fan.
Appliance is not level	<ul style="list-style-type: none">• Be sure floor is level, strong and stable enough to adequately support range. If floor is sagging or sloping, contact a carpenter to correct the situation.• Poor installation. Place oven rack in center of oven and place a level on the oven rack. Adjust leveling legs at base of appliance until the rack is level.• Kitchen cabinet alignment may make range appear not level. Be sure cabinets are square and have sufficient room for appliance clearance.
Cannot move appliance easily. Appliance must be accessible for service.	<ul style="list-style-type: none">• Cabinets not square or are built in too tight to allow clearance for appliance. Contact builder or installer to make appliance accessible.• Carpet interferes with appliance. Provide sufficient space so appliance can be lifted over carpet.
Entire appliance does not work.	<ul style="list-style-type: none">• For models with a power cord, make sure power cord is plugged properly into outlet. If electricity to home is working, check fuse box or breaker. Call your local electric company for service outage information.• Service wiring is not complete. Call 1-800-4-MY-HOME® for assistance (See back cover).
Oven portion of appliance does not operate.	<ul style="list-style-type: none">• The time of day is not set. The oven clock must first be set in order to operate the oven. See "Setting the Clock" on page 12. Be sure oven controls are set properly. See "Oven Control Features" on page 12 and review instructions for the desired cooking function in this manual or see <i>Entire appliance does not operate</i> in this checklist.
Surface element is too hot or not hot enough	<ul style="list-style-type: none">• Incorrect surface control setting. Adjust power level setting.
Surface element does not heat or does not heat evenly.	<ul style="list-style-type: none">• Be sure the correct surface control is turned ON for the element.

BEFORE YOU CALL

- Oven light does not work. • Be sure the oven light is secure in the socket. See “Replacing the oven light” on page 24.
- Flames inside oven or smoking from oven vent. • Excessive spillovers in oven. This is normal, especially for pie spillovers or large amounts of grease on the oven bottom. Wipe up excessive spillovers before starting the self-clean cycle. If flames or excessive smoke are present, stop the self-clean cycle, close the oven door, and turn the oven off. If the fire continues, use a fire extinguisher. Do not put water or flour on the fire. Flour may be explosive.
- Self Clean does not work. • Oven control not set properly. Review instructions in Self Clean section.
- Oven racks discolored or do not slide easily. • Oven racks left in oven cavity during Self Clean. Always remove oven racks from oven cavity before starting a self-clean cycle. Clean by using a mild abrasive cleaner following manufacturer's instructions. Rinse with clean water, dry, and replace in oven.
- Oven smokes excessively when broiling. • Incorrect setting. Follow “Setting broil” instructions on page 17.
• Meat too close to the broil element. Reposition broil rack to provide proper clearance between the meat and broil element. Remove excess fat from meat. Cut remaining fatty edges to prevent curling, but do not cut into lean.
• Grease build up on oven surfaces. Regular cleaning is necessary when broiling frequently. Grease or food splatters will cause excessive smoking.
- Oven control panel beeps and displays any F or E code error. • Oven control has detected a fault or error condition. Press STOP key to clear the error code. Try Bake or Broil function. If the F or E code error repeats, turn OFF power to appliance, wait 5 minutes and then repower appliance. Set clock with correct time of day. Try Bake or Broil function again. If fault recurs, press STOP to clear and call 1-800-4-MY-HOME® for assistance (See back cover).
- Soil not completely removed after Self Clean. • Self Clean was interrupted. Review instructions in Self Clean section. Excessive spills on oven bottom. Clean before starting Self Clean. Failure to clean soil from the oven frame, the door liner outside the oven door gasket and the small area at the front center of the oven bottom. These areas are not in the self-cleaning area, but get hot enough to burn on residue. Clean these areas before starting the self-cleaning cycle. Burned-on residue can be cleaned with a stiff nylon brush and water or a nylon scrubber. Be careful not to damage the oven gasket.
• If your oven is cooking poorly or Self Clean is performing badly, perform the following check. Press **Broil**, press the **Up** button, and **HI** should be on the display. Place your hand near the handle on the oven door. Between the door and the control panel, you should feel a rush of air on your hand. If so, your unit is functioning properly and you have had a power failure in your home. If no air stream is present, call a service technician to replace your cooling fan.
- Scratches or abrasions on cooktop surface. • Coarse particles such as salt or hardened soils between cooktop and utensils can cause scratches. Be sure cooktop surface and bottoms of utensils are clean before using. Small scratches do not affect cooking performance and will become less visible with time. Cleaning materials not recommended for ceramic-glass cooktop have been used. Use only non-abrasive cooktop cleaners. Buff with a non-abrasive cloth or sponge. For more information on your cooktop, see “Coil Elements Cooktop Cleaning and Maintenance” on page 21. Cookware with rough bottom was used. Use smooth, flat-bottomed cookware.
- Metal marks on cooktop. • Sliding or scraping of metal utensils on cooktop surface. Do not slide metal utensils on cooktop surface. Use a ceramic-glass cooktop cleaning cream to remove the marks. “Porcelain enamel cooktop cleaning instructions (some models)” on page 22.

BEFORE YOU CALL

- **Brown streaks or specks on cooktop surface** • Food that boils over can cook onto surface. Use razor blade scraper to remove soil. For more information, see “Coil Elements Cooktop Cleaning and Maintenance” on page 21.
- **Areas of discoloration with metallic sheen on cooktop surface.** • Mineral deposits from water and food. Use non-abrasive ceramic cleaner. Buff with a non-abrasive cloth or sponge.
- **Drip bowls are pitting or rusting.** • Foods with acids, such as tomatoes, if allowed to stand in/on bowls will cause corrosion. Remove and wash drip bowls as soon as possible after spillover. Houses along sea coast are exposed to salt air. Protect bowls as much as possible from direct exposure to salt air.
- **Drip bowls turning color or distorted out of shape.** • Bottom surface of cookware extends beyond surface elements and touches cooktop surface. This can cause high enough temperatures to discolor the drip bowls. Do not use cookware of this type. Pan sizes should be matched to the size of the element.

Your appliance is covered by a one year limited warranty. For one year from your original date of purchase, Electrolux will pay all costs for repairing or replacing any parts of this appliance that prove to be defective in materials or workmanship when such appliance is installed, used and maintained in accordance with the provided instructions.

- Exclusions This warranty does not cover the following:
1. Products with original serial numbers that have been removed, altered or cannot be readily determined.
 2. Product that has been transferred from its original owner to another party or removed outside the USA or Canada.
 3. Rust on the interior or exterior of the unit.
 4. Products purchased "as-is" are not covered by this warranty.
 5. Food loss due to any refrigerator or freezer failures.
 6. Products used in a commercial setting.
 7. Service calls which do not involve malfunction or defects in materials or workmanship, or for appliances not in ordinary household use or used other than in accordance with the provided instructions.
 8. Service calls to correct the installation of your appliance or to instruct you how to use your appliance.
 9. Expenses for making the appliance accessible for servicing, such as removal of trim, cupboards, shelves, etc., which are not a part of the appliance when it is shipped from the factory.
 10. Service calls to repair or replace appliance light bulbs, air filters, water filters, other consumables, or knobs, handles, or other cosmetic parts.
 11. Surcharges including, but not limited to, any after hour, weekend, or holiday service calls, tolls, ferry trip charges, or mileage expense for service calls to remote areas, including the state of Alaska.
 12. Damages to the finish of appliance or home incurred during installation, including but not limited to floors, cabinets, walls, etc.
 13. Damages caused by: services performed by unauthorized service companies; use of parts other than genuine Electrolux parts or parts obtained from persons other than authorized service companies; or external causes such as abuse, misuse, inadequate power supply, accidents, fires, or acts of God.

DISCLAIMER OF IMPLIED WARRANTIES; LIMITATION OF REMEDIES

CUSTOMER'S SOLE AND EXCLUSIVE REMEDY UNDER THIS LIMITED WARRANTY SHALL BE PRODUCT REPAIR OR REPLACEMENT AS PROVIDED HEREIN. CLAIMS BASED ON IMPLIED WARRANTIES, INCLUDING WARRANTIES OF MERCHANTABILITY OR FITNESS FOR A PARTICULAR PURPOSE, ARE LIMITED TO ONE YEAR OR THE SHORTEST PERIOD ALLOWED BY LAW, BUT NOT LESS THAN ONE YEAR. ELECTROLUX SHALL NOT BE LIABLE FOR CONSEQUENTIAL OR INCIDENTAL DAMAGES SUCH AS PROPERTY DAMAGE AND INCIDENTAL EXPENSES RESULTING FROM ANY BREACH OF THIS WRITTEN LIMITED WARRANTY OR ANY IMPLIED WARRANTY. SOME STATES AND PROVINCES DO NOT ALLOW THE EXCLUSION OR LIMITATION OF INCIDENTAL OR CONSEQUENTIAL DAMAGES, OR LIMITATIONS ON THE DURATION OF IMPLIED WARRANTIES, SO THESE LIMITATIONS OR EXCLUSIONS MAY NOT APPLY TO YOU. THIS WRITTEN WARRANTY GIVES YOU SPECIFIC LEGAL RIGHTS. YOU MAY ALSO HAVE OTHER RIGHTS THAT VARY FROM STATE TO STATE.

- If You Need Service Keep your receipt, delivery slip, or some other appropriate payment record to establish the warranty period should service be required. If service is performed, it is in your best interest to obtain and keep all receipts. Service under this warranty must be obtained by contacting Electrolux at the addresses or phone numbers below.

This warranty only applies in the USA and Canada. In the USA, your appliance is warranted by Electrolux Major Appliances North America, a division of Electrolux Home Products, Inc. In Canada, your appliance is warranted by Electrolux Canada Corp. Electrolux authorizes no person to change or add to any obligations under this warranty. Obligations for service and parts under this warranty must be performed by Electrolux or an authorized service company. Product features or specifications as described or illustrated are subject to change without notice.

USA
1.800.944.9044
Electrolux Home Products, Inc.
10200 David Taylor Drive
Charlotte, NC 28262



Canada
1.800.265.8352
Electrolux Canada Corp.
5855 Terry Fox Way
Mississauga, Ontario, Canada
L5V 3E4